

Aluminium Skirting 2079

NEW !

Our aluminum skirting systems can all be combined with a 15 mm x 10 mm low location lighting system (LLL).

- The aluminum skirting 2079 is 70 mm high.
- If a LLL system is not required an aluminum cover is clipped to provide a concealed fixing. For LLL purpose, end plugs and corner pieces enable the passage of electric wires.
- All aluminum skirting systems are delivered pre-drilled (\varnothing 5 mm), with a foam gasket stuck on the profile in order to compensate the unevenness of the panel surface.
- The gasket J14 protects the wall from all kind of attacks (water, dust, impacts). Especially recommended on smooth floors.
- Our aluminum skirting systems are high resistant to scratches and shocks.

Skirting 2079
satin bronze

Cover 2110
satin bronze

Angle 2090R
satin bronze

LLL

not supplied

Ref	Description	Standard Finishes	Weight
SKIRTING			
2079	Skirting delivered in lengths of 5 meters (anodized or veneered) or 3 meters (coated)	SA-BA-C-OF	0.560 kg/m
2110	Cover delivered in lengths of 5 meters (anodized or veneered) or 3 meters (coated)	SA-BA-C-OF	0.080 kg/m
J14	Rubber gasket delivered in rolls of 50 meters	Black	0,065 kg/m
ANGLE PARTS			
2090-A	90° angle	SA-BA-C	0,050 kg
2090-R	90° angle with radius R = 10, 20 or 50 mm (specify radius)	SA-BA-C	0.080 kg
2090-U	Specific angle (angle to be specified)	SA-BA-C	0.020 kg
END PARTS			
2090-EG	Left end part	SA-BA-C	0.045 kg
2090-ED	Right end part	SA-BA-C	0.045 kg



SKIRTING

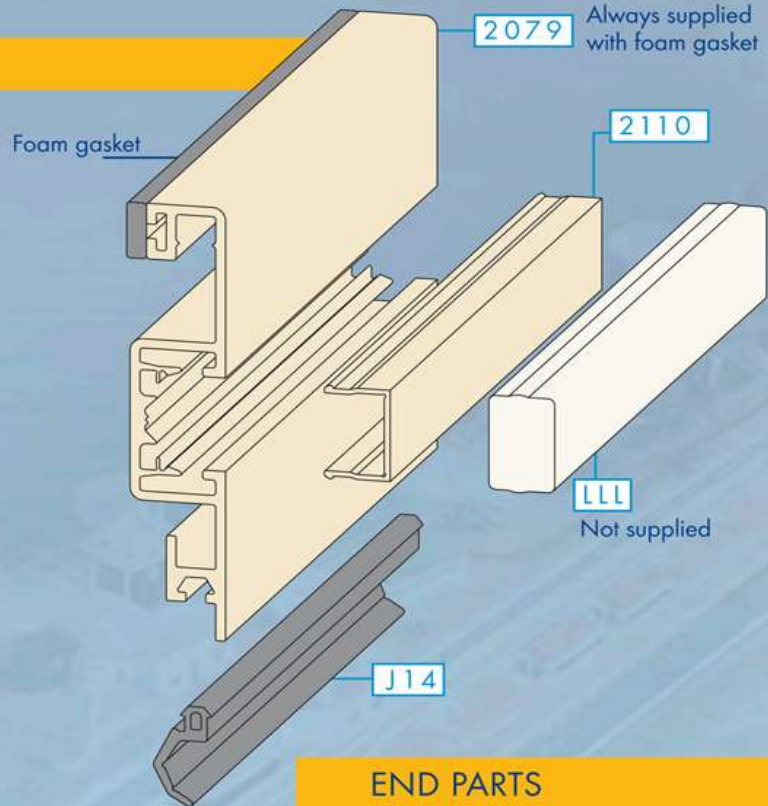
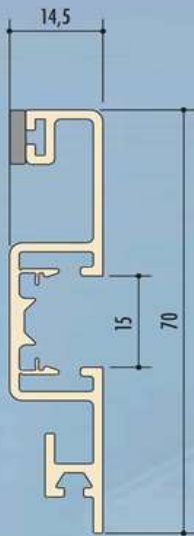

END PARTS



2090E right
satin bronze

2090-EG
left



2090-ED
right



ANGLE PARTS

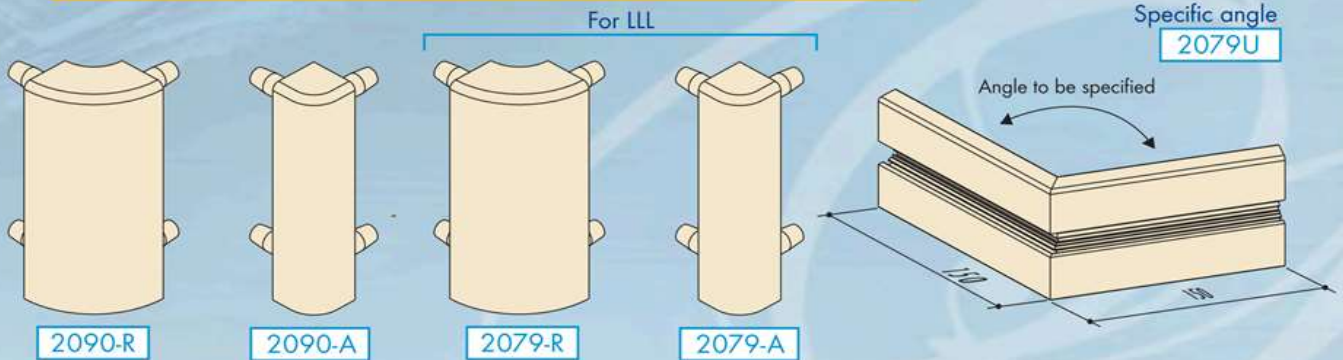

Aluminium Skirting 2109

- The aluminum skirting 2109 is 100 mm high
- If a LLL system is not required, an aluminum cover is clipped to provide a concealed fixing. For LLL purpose, end plugs and corner pieces enable the passage of electric wires.
- All aluminum skirting systems are delivered pre-drilled (\varnothing 5 mm), possibly counter sunk for LLL purpose and with a foam gasket stuck on the profile in order to compensate the irregularity of the panel surface.
- The gasket J14 protects the wall from all kind of attacks (water, dust, impacts). Particularly recommended on smooth floors.
- Our aluminum skirting systems are high resistant to scratches and shocks.

Cover 2110
satin bronze

Skirting 2109
satin bronze

Angle 2109R
satin bronze

LLL

not supplied

Ref	Description	Standard Finishes	Weight
SKIRTING			
2109	Skirting delivered in lengths of 5 meters	SA-BA-C-OF	0.685 kg/m
2110	Cover delivered in lengths of 5 meters	SA-BA-C-OF	0.080 kg/m
J14	Rubber gasket delivered in rolls of 50 meters	Grey	0.080 kg/m
1130	Skirting delivered in lengths of 5 meters	SA-BA-C-OF	0.325 kg/m
5015	Cover delivered in lengths of 5 meters	SA-BA-C-OF	0.470 kg/m
ANGLE PARTS			
2107-A	90° angle	SA-BA-C	0.060 kg
2107-R	90° angle with radius R = 10, 20 or 50 mm (specify radius)	SA-BA-C	0.480 kg
2109-A	90° angle with overlapping for LLL	SA-BA-C	0.125 kg
2109-R	90° angle with overlapping for LLL with radius R = 10, 20 or 50 mm (specify radius)	SA-BA-C	0.505 kg
2109-U	Specific angle (angle to be specified)	SA-BA-C	0.210 kg
END PARTS			
2107-ED	Right end part	SA-BA-C	0.505 kg
2107-EG	Left end part	SA-BA-C	0.055 kg
2109-ED	Right end part with overlapping	SA-BA-C	0.080 kg
2109-EG	Left end part with overlapping	SA-BA-C	0.080 kg

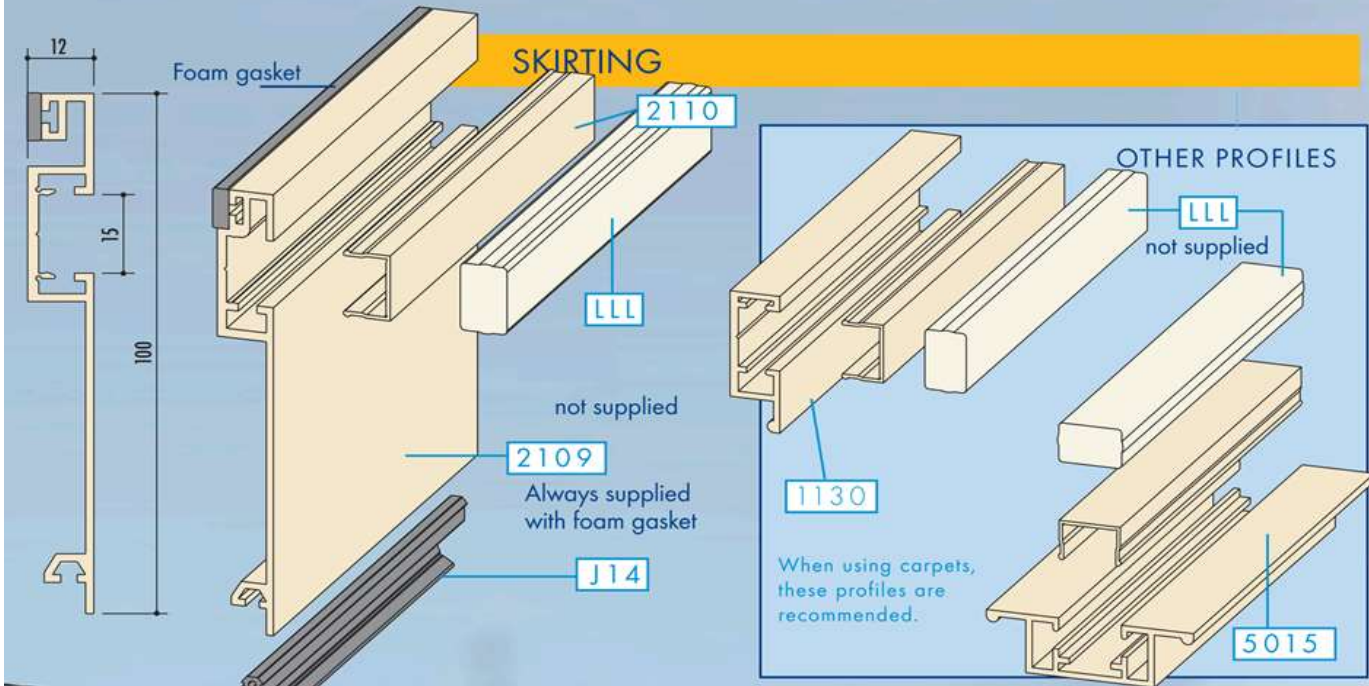

END PARTS

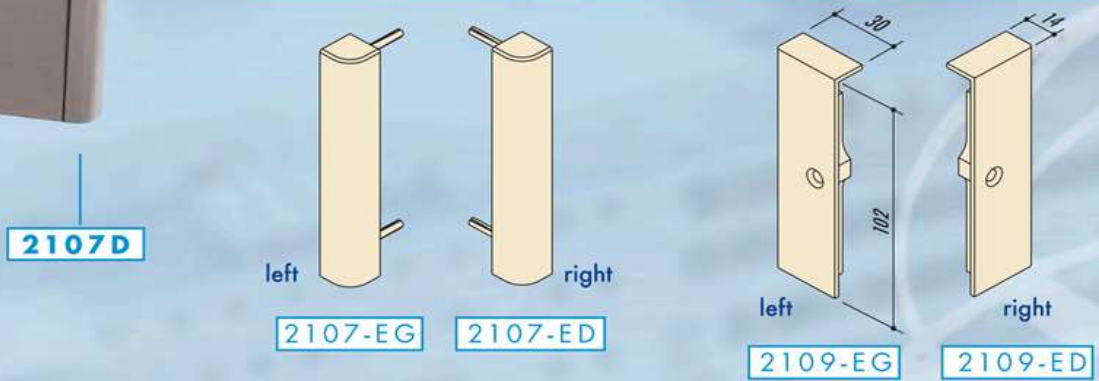

ANGLE PARTS

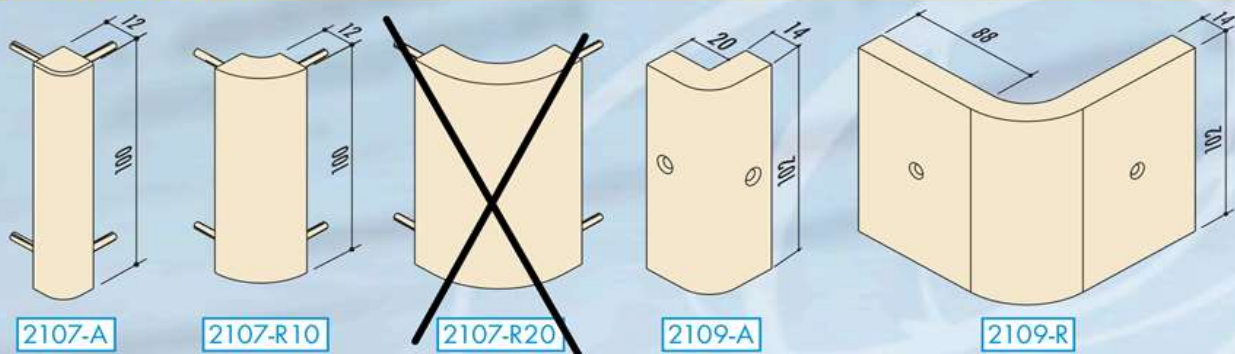

Carpet Skirting

- The use of carpet skirting 1112 makes easier the laying of the carpet.
- It prevents the carpet from fraying.
- Carpet skirting 1112 ensures a long life to your carpet.
- The concealed fixing gives a perfect finish to the floor.
- Thanks to complementary accessories, our carpet skirting 1112 is well adapted to many configurations (walls, steps,...).
- All the pieces are delivered drilled \varnothing 3.5 mm.

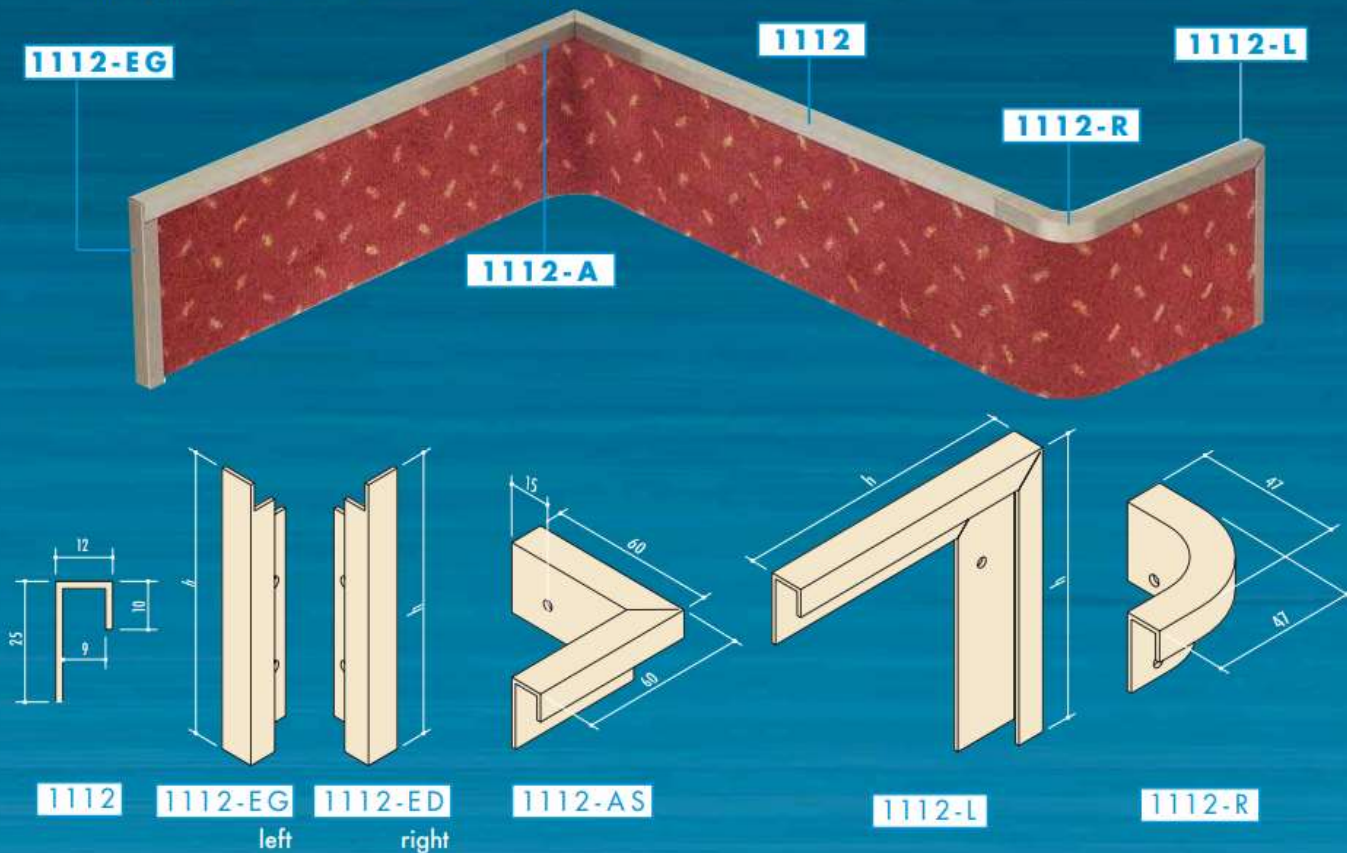

	Ref	Description	Standard Finishes	Weight
SKIRTING				
	1112	Skirting delivered in lengths of 5 meters (anodized) or 3 meters (coated)	SA-BA-C	0.180 kg/m
ANGLE PARTS				
	1112-AS	90° external angle	SA-BA-C	0,020 kg
	1112-AR	90° external angle	SA-BA-C	0.020 kg
	1112-R	90° angle with radius R = 10, 20 or 50 mm (specify radius)	SA-BA-C	0.020 kg
	1112-U	Angle to specific angle (specify angle)	SA-BA-C	0.030 kg
END PARTS				
	1112-EG	Left end part (h standard = 100 mm.)	SA-BA-C	0.015 kg
	1112-ED	Right end part (h standard = 100 mm.)	SA-BA-C	0.015 kg
	1112-L	L end plug (h standard = 100 mm.)	SA-BA-C	0.030 kg

Stepnosing Profiles

Step nosing systems in aluminum are adapted to applications inside or outside either in private or public areas. They ensure at the same time a high level protection of the step edge and an excellent protection against injuries by slipping on board.

- The step nosing systems are concealed fixing thanks to non-sliding rubber strips.
- The rubber strips can be either clipped or sticked.
- Profiles can be delivered pre-drilled and/or countersunk upon request
- Finish : satin anodized

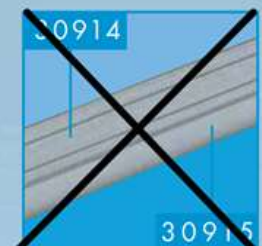
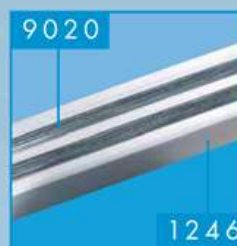
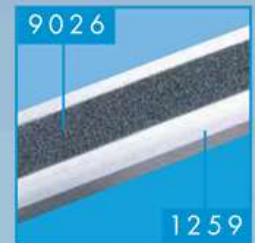
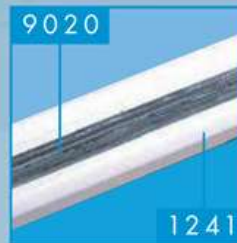
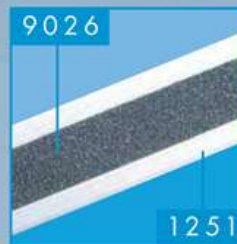

LLL compatible



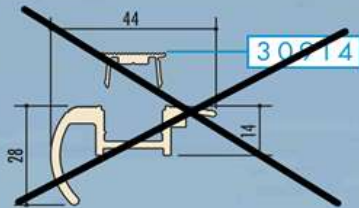

30914

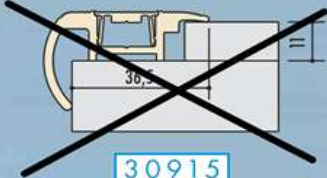

30915

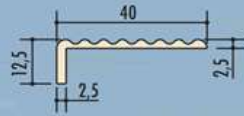

1244



1251

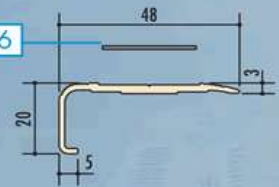

1259

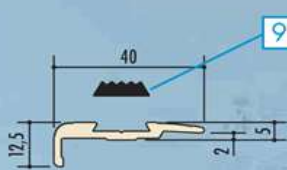

1241

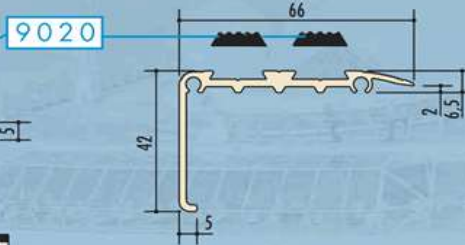
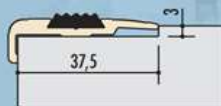

1246

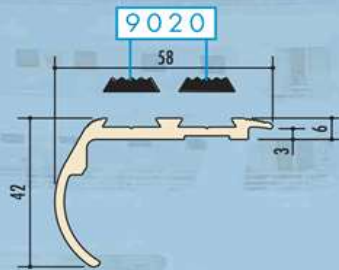

1242

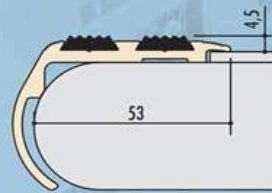

Ref	Description	LLL compatible	Standard Length	Standard Finishes	Weight
1244	Step nosing profile	no	2 or 4 meters	SA	0.280 kg/m
1241	Step nosing profile	no	2 or 4 meters	SA	0.350 kg/m
1246	Step nosing profile	no	2 or 4 meters	SA	0.740 kg/m
1242	Step nosing profile	no	2 or 4 meters	SA	0.840 kg/m
1259	Step nosing profile	no	2 or 4 meters	SA	0.340 kg/m
30915	Step nosing profile	yes	2 or 4 meters	SA	0.610 kg/m
30914	Cover profile	-	2 or 4 meters	SA	0.125 kg/m
1251	Step nosing profile	no	2 or 4 meters	SA	0.260 kg/m
9020	Black non-sliding rubber strip (to be inserted)	-	10 or 25 meters	Black	0.620 kg/roll (10 m)
9021	Grey non-sliding rubber strip (to be inserted)	-	40 meters	Light grey	2.421 kg/roll
9026	Non-sliding strip (adhesive)	-	18 meters	Black	0.420 kg/roll

Corner Protection

Corner protections are particularly designed to protect wall corner angles against frictions or impacts in risky areas.

- 2 models are available, made of either extruded aluminum (ref. 534) or PVC (ref. 534PR).
- The PVC model 534 PR is flexible and fits whatever the wall angle is. It is fire-resistant class M1.
- Regarding the fixing :
 - The aluminum corner protection 534 can be fixed either by screws or by adhesive strip.
 - The PVC corner protection 534 PR is fixed thanks to adhesive strip.
 - The double side adhesive strip ref 43142 is delivered separately in rolls of 50 meters.

All corner protections are compatible with RIVALU aluminum skirting systems.

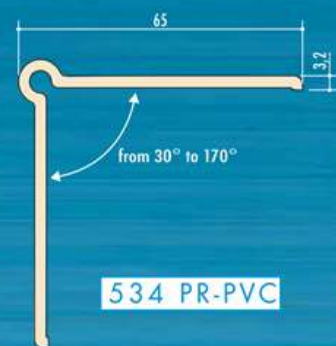
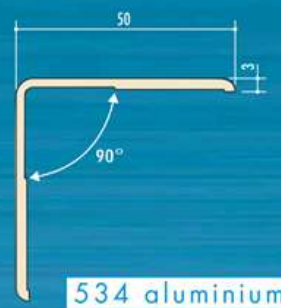
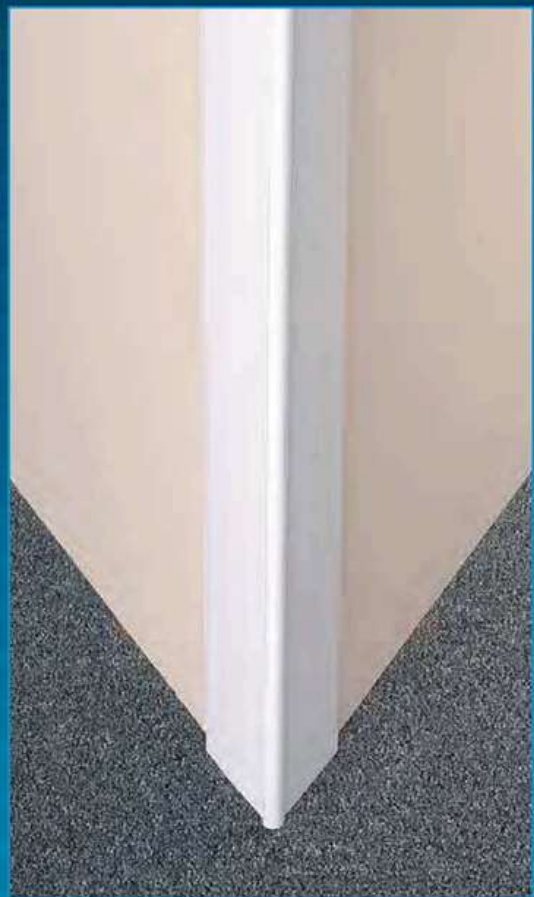

Ref	Description	Fire resistant	Standard Length	Standard Finishes	Weight
534	Aluminium protection	yes	2 or 4 meters	SA-BA-C	0.595 kg
534 PR1	PVC protection	yes	1.20 meters	White or light grey	0.640 kg
534 PR2	PVC protection	yes	2.40 meters	White or light grey	1.280 kg
43142	Special double side strip	-	50 meters	-	-



Bed-ladder

Our bed-ladder is made of aluminum and especially designed to combine lightness and high resistance. Non-skid steps are made of extruded aluminum tubular section, hooks and shoes are made of plastic composite material.

- The bed-ladders can be stored either at wall or laid on the bed.
- Quality tests have been carried out into our laboratories according to European Norm EN 131.2 § 4.
- How to order :
Please indicate total height "H" and distance floor/first step "T1".



High Resistance Hook



Anti-slide Shoe

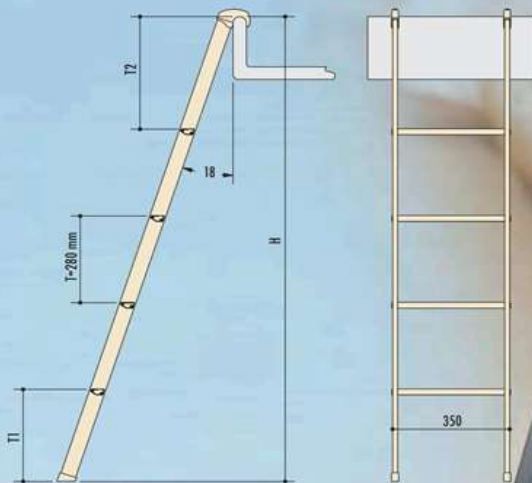
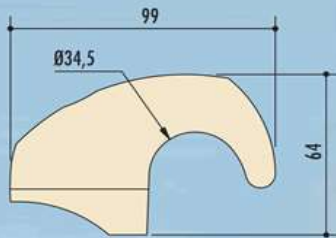

Finishes

ANODIZED FINISHES

SATIN



SILVER - S1



CHAMPAGNE - S2

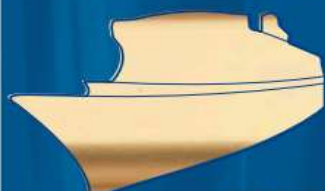

GOLD - S3



HONEY BRONZE - S5



MID BRONZE - S6



DARK BRONZE - S7

BRIGHT



SILVER - B1



CHAMPAGNE - B2

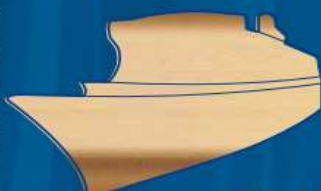

GOLD - B3



HONEY BRONZE - B5



MID BRONZE - B6



DARK BRONZE - B7

WOOD FINISHES

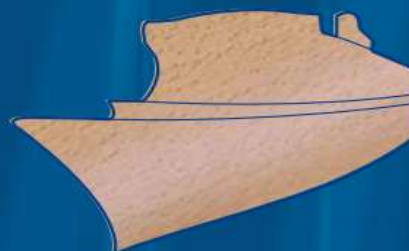

We propose 3 kinds of wood finishes :
- genuine wood veneered
- pvc veneered imitation wood
- coated imitation wood
For other finishes, contact us.

POLYESTER COATED COLOUR

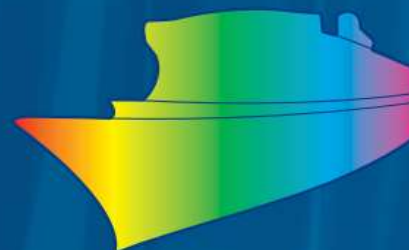

We propose all the range of RAL and NCS colours.
All profiles are coated in accordance with QUALICOAT process.

QUALICOAT