

# Digest 178



[www.schneider-electric.us/digestplus](http://www.schneider-electric.us/digestplus)

Life Is On

**Schneider**  
Electric

# INNOVATION

## Powering the digital economy

EcoStruxure is Schneider Electric's IoT-enabled, plug-and-play, open, interoperable architecture and platform, in Homes, Buildings, Data Centers, Infrastructure and Industries.

EcoStruxure delivers Innovation at Every Level from Connected Products to Edge Control, and Apps, Analytics and Services, on 6 domains of expertise – Power, IT, Building, Machine, Plant and Grid – delivering enhanced value around safety, reliability, operational efficiency, sustainability, and connectivity to our customers..

#WhatsYourBoldIdea

[schneider-electric.us/ecostruxure](https://schneider-electric.us/ecostruxure)

Life Is On

Schneider  
Electric

## How to Use Digest 178

Welcome to the Schneider Electric Digest! Over a thousand pages of technical product information to help you specify and select Schneider Electric products.

A key element of the Digest 178 is its color-coded Table of Contents, shown at the right, and matching product section tabs throughout the Digest. This colorful approach aids navigation and helps you quickly find the major product categories.

A detailed Table of Contents is provided at the beginning of each product section and two indexes are available in the back of the book: an alphabetical listing and an alphanumeric listing. To ensure you have the latest pricing information, list prices are now available online only. This meets our customer and market driven demand to merge technical information with functionality.

Finally, the Supplemental and Obsolescence Digest 178 contains additional product information for our international product offer, our legacy products in the obsolescence process, and more.

## DigestPLUS

DigestPLUS provides one location to access the most current Digest updates available in HTML5 and PDF formats, plus many links to additional technical product information to assist with specifying and selecting Schneider Electric products. DigestPLUS is a simple portal into all things Digest related.

[www.schneider-electric.us/digestplus](http://www.schneider-electric.us/digestplus)

## Field Services for Every Step of the Lifecycle

From planning and inception to modernization and end-of-life, Schneider Electric helps you ensure optimal technical and business performance. Our services engineers combine decades of manufacturer-level experience with the latest technology to bring innovation to every level of our offer, and every step of your project.

With our IoT-enabled EcoStruxure™ Power solutions, we can help proactively empower facilities with system-health analyses and maintenance service recommendations to optimize performance and help deliver more reliable and efficient power.

[www.schneider-electric.us/services](http://www.schneider-electric.us/services)

## Customer Care Center

### Have questions or need support?

mySchneider App Download the mySchneider app to find pricing, order status, FAQ's and Chat on the go. It's your one stop mobile shop.

[www.schneider-electric.us/en/work/support/myschneider-app](http://www.schneider-electric.us/en/work/support/myschneider-app)



### For Distributors

Distributors Login to mySE and access all the Schneider Electric Support Tools for the fastest answers. Need more tailored support? Click CHAT under the support tab and an agent will quickly deliver the answer you need.

[www.myseus.schneider-electric.com/mySchneider](http://www.myseus.schneider-electric.com/mySchneider)

## Helpful Tools and Calculators

Visit our Support Center to view all of our Free Digital Tools and Calculators Schneider Electric is continuously creating and improving our portfolio of free digital calculators and tools designed around the many needs of our customers to help increase efficiency in everything you do. Our tools offer 24/7 access to information to grow your business, are easy to use - on your desktop or mobile device.

Get access to tools such as:

- CAD Drawings
- Distributor Locator
- Partner Portal
- Cross Reference
- FAQs
- ...and much more!

We also offer product selector tools that are designed to assist you through the product selection process with the click of a button.

[www.schneider-electric.us/en/work/support/](http://www.schneider-electric.us/en/work/support/)

**LayoutFAST:** a Revit MEP Plugin that's going to help you select, configure and insert the most updated Schneider Electric product models from the cloud into your design without leaving your Revit project.

[www.schneider-electric.us/en/partners/resources/layoutfast/](http://www.schneider-electric.us/en/partners/resources/layoutfast/)

## Table of Contents Product Section Listing

1	Load Centers
2	Metering Equipment
3	Safety Switches
4	Power Monitoring and Control
5	Protection, Control, and Energy Automation
6	Surge Protective Devices
7	Miniature and Molded Case Circuit Breakers
8	Operator Mechanisms and Disconnect Switches
9	Panelboards
10	Power Solutions: Integrated
11	Switchboards and Switchgear
12	Busway
13	Wire Management
14	Transformers
15	Medical Products
16	NEMA Contactors and Starters
17	Motor Control Centers
18	IEC Contactors and Starters
19	Push Buttons and Operator Interface
20	Electronic Sensors and Machine Cabling
21	Limit Switches
22	Pressure, Vacuum, and Float Switches
23	Relays and Timers
24	Terminal Blocks
25	Machine Safeguarding Products
26	AC Drives and Soft Starts
27	Automation Products
28	Universal Enclosures
29	EcoStruxure™
	Alphabetical Listing Alpha-Numeric Listing

**Section 1 Load Centers**

QO™ Plug-On Neutral Load Centers with Qwik-Grip ..... 1-11  
 Homeline™ Plug-On Neutral Load Centers with Qwik-Grip..... 1-23  
 QO™ and Homeline™ Plug-on Neutral SPD ..... 1-27  
 Wiser Energy™ Smart Home ..... 1-41

**Section 4 Power Monitoring and Control**

ION9000 Power and Energy Meters ..... 4-7  
 PowerLogic™ EM4900 Series Multi-Circuit Meters ..... 4-25

**Section 5 Protection, Control, and Energy Automation**

ECOFIT™ 50/51 Protection Relays ..... 5-4  
 Sepam™ Protection Relays ..... 5-5  
 MiCOM Protection Relays ..... 5-16  
 SAGE RTUs ..... 5-27  
 Easergy™ T300 Remote Terminal Unit (RTU) ..... 5-32

**Section 6 Surge Protective Devices (SPDs)**

Surgelogic Type XDSE Surge Protective Devices ..... 6-8

**Section 7 Miniature and Molded Case Circuit Breakers**

Masterpact MTZ Circuit Breakers..... 7-64  
 Micrologic X Control Units for Masterpact MTZ..... 7-65  
 Masterpact MTZ Accessories ..... 7-67

**Section 8 Operating Mechanisms and Disconnect Switches**

TeSys VLS Disconnect Switches..... 8-9

**Section 9 Panelboards**

Fingersafe IP2X Barriers for NQ Panelboards ..... 9-23  
 Separated Distribution and Split Bus NF and NQ..... 9-35

**Section 10 Power Solutions Integrated Equipment**

Energy Control Center..... 10-4

**Section 12 Busway**

H-, J-, and L-Frame Plug-In Units with Electronic Trip and Communication ..... 12-15

**Section 16 NEMA and Definite Purpose Contactors & Starters**

TeSys N Non-Reversing Contactors..... 16-14  
 TeSys N Reversing Contactors..... 16-15  
 TeSys N Non-Reversing Starters..... 16-16  
 TeSys N Reversing Starters ..... 16-17  
 TeSys T Motor Management System ..... 16-103  
 TeSys T Controller and Accessories ..... 16-104–16-108  
 Adapted Bimetallic Overload Relay Mounting Bracket Adapter (NEMA Sizes 00–1)..... 16-109

**Section 21 Limit Switches**

XCKS Standard Range ..... 21-19–21-21  
 XCKW Wireless and Batteryless Limit Switches ..... 21-23

**Section 22 Pressure, Vacuum, and Float Switches**

XMEP Pressure Transmitters for Mobile Equipment ..... 22-8

**Section 23 Relays and Timers**

729 Ice Cube Relays ..... 23-14  
 781R Plug-in Relays ..... 23-16  
 782 Power Series—DPDT 15 A Relays ..... 23-19  
 783 Series—3PDT 15 A Relays ..... 23-21  
 784 Series—4PDT 15 A Relays ..... 23-22  
 750R Series Universal Relays ..... 23-24  
 788R Series Universal Relays ..... 23-27  
 199 Power Relays ..... 23-48  
 725 Power Relays ..... 23-51  
 389F Power Relays ..... 23-53  
 300 Power Relays ..... 23-56  
 92 Power Relays ..... 23-58  
 861H Solid-State Relays..... 23-68  
 6000 Solid-State Relays ..... 23-79  
 SSRDIN Solid-State Relays..... 23-81  
 861 Solid-State Relays ..... 23-83  
 70S2 Solid-State Relays..... 23-85  
 820 Series Time Delay and Sensor Relays ..... 23-104  
 TDR782 Series Time Delay and Sensor Relays..... 23-105  
 TDRPRO Series Time Delay and Sensor Relays ..... 23-107

**Section 25 Machine Safety Products**

XUSL Light Curtains ..... 25-5  
 XCSR Contactless RFID Safety Sensors ..... 25-7  
 XY2 Cable Pull Switches ..... 25-8

**Section 26 AC Drives and Soft Starters**

Altivar™ 320 Machine ..... 26-15  
 Altivar™ 340 Machine ..... 26-17  
 Altivar™ Process 630/650 ..... 26-24  
 Altivar™ Process 930/950 ..... 26-25

**Section 27 Automation Products**

Lexium™ ILx Series Combination Stepper Motors ..... 27-20  
 Lexium 28 Series ..... 27-20  
 Lexium 32 Series ..... 27-20  
 Lexium 32i Series Integrated Servo ..... 27-21  
 PacDrive 3 ..... 27-21

**Section 29 EcoStruxure™**

EcoStruxure™: IoT-enabled Architecture and Platform ..... 29-2

# Section 1

## Load Centers



QO™ Miniature Circuit Breakers



QO™ Load Centers



Homeline™ Miniature Circuit Breakers



Homeline™ Load Centers



CSEDs

Surge Protective Devices (SPD)

Enclosed Devices

Wisier Energy™ Smart Home

Servicepak™ Power Outlet Panels

<b>EZ Selector - Selection Assistance</b>	<b>1-2</b>
<b>QO™ Miniature Circuit Breakers</b>	<b>1-3</b>
<b>QO™ Load Centers</b>	<b>1-9</b>
<b>Homeline™ Miniature Circuit Breakers</b>	<b>1-19</b>
<b>Homeline™ Load Centers</b>	<b>1-22</b>
<b>QO/Homeline Load Center Value Packs and Accessories</b>	<b>1-26</b>
<b>QO/Homeline Load Center Dimensions</b>	<b>1-32</b>
<b>Combination Service Entrance Devices</b>	<b>1-35</b>
<b>Solar Ready PoN CSEDs</b>	<b>1-43</b>
<b>Wisier Energy™ and Wiring Devices</b>	<b>1-46</b>
<b>Enclosed Devices</b>	<b>1-47</b>
<b>Servicepak™ Power Outlet Panels</b>	<b>1-50</b>



QO Load Center

## QO™ and Homeline™ Load Center EZ Selector - Selection Assistance

### EZ Selector

#### Steps to select a load center.

- Select product type:
  - Homeline™ 1 inch format (HOM)
  - QO™ 3/4 inch format with plug-on neutral (QO) (P)
  - QO™ 3/4 inch format (QO)
- Select enclosure type: indoor or outdoor (RB = rainproof)
- Select single phase (1) or three phase (3)
- Select type of main:
  - Main circuit Breaker (M)
  - Main lugs (L)
  - Generator panel (GP)
- Select main ampacity rating
- Select pole spaces and max. number of 1-pole, single-phase circuits
- Select cover style:
  - Surface (box mounted on surface)
  - Surface (box mounted on surface, hinged cover included)
  - Flush (box recessed, cover is flush to wall)
- Value pack (VP)
- Select ground bar option:
  - Ground bar factory installed (T)
  - Ground bar included, field installation (G)
- Select special application:
  - Riser panel with gutter
  - Mfg housing, single phase 3-wire, convertible mains
  - Manufactured housing, single phase, 3-wire
  - Manufactured housing, single phase, 2-wire

#### QO™ and Homeline™ Load Centers — Catalog Number Construction

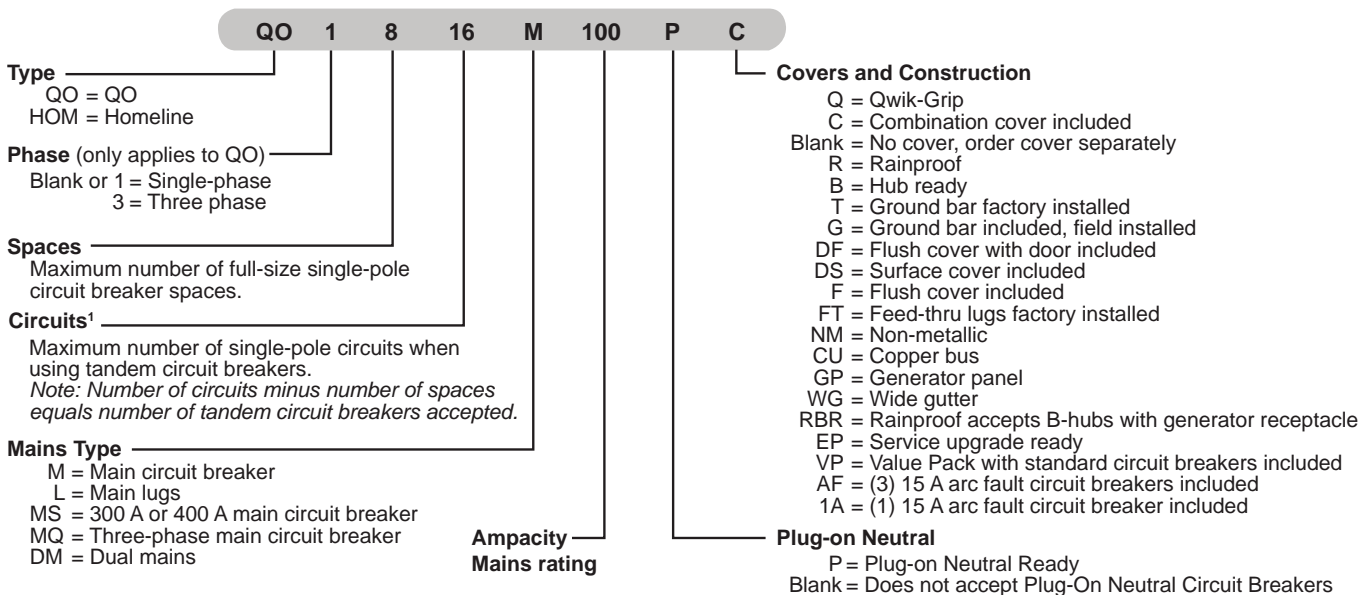

#### Additional Information

- See **Circuits** [1].
- Search "Load Centers" from our technical FAQs page: [www.schneider-electric.us/en/faqs/home/](http://www.schneider-electric.us/en/faqs/home/)
- Refer to catalog [1100CT0501](#).

[1] QO Plug-on neutral load center catalog numbers indicate the number of spaces only. The tables in this document containing QO plug-on neutral load centers list the maximum number of single-pole circuits when using tandem breakers.

**QO Standard Plug-On Circuit Breakers**

Square D brand QO miniature circuit breakers are plug-on products for use in QO load centers, NQOD and NQ panelboards, NQOD and NQ OEM interiors or Speed-D™ switchboard distribution panels. Bolt-on QOB circuit breakers are for use in NQOD and NQ panelboards or interiors. [1]

The Square D exclusive Qwik-Open™ mechanism, with a trip reaction within 1/60th of a second, is standard on all 1P 15 and 20 A QO circuit breakers.

**Table 1.1: Standard QO Plug-On Circuit Breakers**

Amperes Rating [2]	1P—120/240 Vac	2P—120/240 Vac Common Trip	2P—240 Vac [3] Common Trip	3P—240 Vac Common Trip
<b>10 k AIR</b>				
10 A	QO110	QO210	—	QO310
15 A	QO115 [4] [5]	QO215 [4]	QO215H	QO315 [4]
20 A	QO120 [4] [5]	QO220 [4]	QO220H	QO320 [4]
25 A	QO125 [4]	QO225 [4]	QO225H OBS	QO325 [4]
30 A	QO130 [4]	QO230 [4]	QO230H	QO330 [4]
35 A	QO135 [4]	QO235 [4]	—	QO335 [4]
40 A	QO140 [4]	QO240 [4]	QO240H	QO340 [4]
45 A	QO145 OBS	QO245 [4]	—	QO345 [4]
50 A	QO150 [4]	QO250 [4]	QO250H OBS	QO350 [4]
60 A	QO160 [4]	QO260 [4]	QO260H OBS	QO360 [4]
70 A	QO170 [4]	QO270 [4]	QO270H OBS	QO370 [4]
80 A	—	QO280 [4]	QO280H OBS	QO380 [4]
90 A	—	QO290 [4]	QO290H OBS	QO390 [4]
100 A	—	QO2100 [4]	QO2100H	QO3100 [4]
110 A	—	QO2110 [4]	—	—
125 A	—	QO2125 [4]	—	—
150 A	—	QO2150 [4] [6] [7]	—	—
175 A	—	QO2175 [4] [6] [7]	—	—
200 A	—	QO2200 [4] [6] [7]	—	—
Molded Case Switch 60 A max.—240 Vac	—	—	QO200	QO300 OBS
Molded Case Switch 100 A max.—240 Vac	—	—	QO2000 OBS	QO3000 OBS
<b>22 k AIR [4]</b>				
15 A	QO115VH [5]	QO215VH [8]	—	QO315VH [8]
20 A	QO120VH [5]	QO220VH [8]	—	QO320VH [8]
25 A	QO125VH OBS	QO225VH [8]	—	QO325VH [8]
30 A	QO130VH	QO230VH [8]	—	QO330VH [8]
40 A	QO140VH	QO240VH [8]	—	QO340VH [8]
50 A	QO150VH	QO250VH [8]	—	QO350VH [8]
60 A	QO160VH	QO260VH [8]	—	QO360VH [8]
70 A	QO170VH	QO270VH [8]	—	QO370VH [8]
80 A	—	QO280VH [8]	—	QO380VH [8]
90 A	—	QO290VH [8]	—	QO390VH [8]
100 A	—	QO2100VH [8] [9]	—	QO3100VH [8]
110 A	—	QO2110VH [8] [9]	—	—
125 A	—	QO2125VH [8] [9]	—	—
150 A	—	QO2150VH [6] [8] [7]	—	—
175 A	—	QO2175VH OBS	—	—
200 A	—	QO2200VH [6] [8] [7]	—	—
<b>42 k AIR [4]</b>				
40 A	—	QOH240 OBS	—	—
45 A	—	QOH245 OBS	—	—
50 A	—	QOH250 OBS	—	—
60 A	—	QOH260 [10]	—	—
70 A	—	QOH270	—	—
80 A	—	QOH280	—	—
90 A	—	QOH290	—	—
100 A	—	QOH2100	—	—
110 A	—	QOH2110 [10]	—	—
125 A	—	QOH2125	—	—
<b>65 k AIR [4]</b>				
15 A	QH115 OBS	QH215 OBS	—	QH315 OBS
20 A	QH120 [5]	QH220	—	QH320 OBS
25 A	QH125 OBS	QH225 OBS	—	QH325 [10]
30 A	QH130 OBS	QH230	—	QH330 OBS

OBS This product is obsolete.

Refer to [page](#) for Interrupting Ratings, Accessories, and Dimensions.



QO 1P  
1 Space Required



QO 2P  
2 Spaces Required



QO 3P  
3 Spaces Required



QO2200 2P 200 A  
4 Spaces Required

[1] See Digest Section 1 for load centers, and Section 9 for panelboards and interiors.

[2] 10–30 A circuit breakers are suitable for use with 60°C or 75°C conductors. 35–125 A circuit breakers are suitable for use with 75°C conductors.

[3] UL Listed 5 k AIR on corner grounded Delta systems.

[4] UL Listed as HACR type for use with air conditioning, heating and refrigeration equipment having motor group combinations and marked for use with HACR type circuit breakers.

[5] UL Listed as SWD (switching duty) rated. Suitable for switching 120 Vac fluorescent lighting loads.

[6] Requires four spaces (1 AWG–300 kcmil Al/Cu.) Suitable for switching 120 Vac fluorescent lighting loads.

[7] Not suitable for use in 3Ø panels. Use only in 1Ø panel rated 150 A or greater.

[8] UL Listed for use ahead of QO, QO-GFI, QO-EPD, QOT, QO-AFI, and QO-PL 10 k AIR circuit breakers to permit their application at 22 kA fault level.

[9] 100 A maximum branch mounted opposite.

[10] Order only. Contact your local Field Office.

### QO/QOB Ring Terminal

Table 1.2: QO/QOB Ring Terminal—Factory-Installed Only

Ampere Rating	Poles	Suffix
10–30 A	1, 2, 3	5237
35–60 A	1, 2	5238
35–50 A	3	
70–110 A	2	
60–100 A	3	5273

### Wire Sizes for QO/QOB Circuit Breakers

Table 1.3: Wire Sizes for QO/QOB Circuit Breakers

Circuit Breaker Type	Ampere Rating [11]	Wire Size (AWG/kcmil)
QO 1P	10–30 A	14–8 Al/Cu
	10–30 A	(2) 14–10 Cu
	35–70 A	8–2 Al/Cu
QO 2P	10–30 A	14–8 Al/Cu
	10–30 A	(2) 14–10 Cu
	35–70 A	8–2 Al/Cu
	80–125 A	4–2/0 Al/Cu
	150–200 A	4–300 Al/Cu
QO 3P	10–30 A	14–8 Al/Cu, (2) 14–10 Cu
	35–70 A	8–2 Al/Cu
	80–125 A	4–2/0 Al/Cu
QOB-VH	110–150 A	4–300 Al/Cu
QOT	15–20 A	12–8 Al 14–8 Cu
QO-AFI, QO-GFI or QO-EPD	15–30 A	12–8 Al 14–8 Cu
	40, 50, 60 A	12–4 Al 14–6 Cu
QO-PL	10–60 A	12–2 Al 14–2 Cu

### QOT and QO Tandem Circuit Breakers

QOT tandem circuit breakers have a mounting cam as shown. Installation into a QO load center can only be made in those positions having a mounting pan rail slot. Meets Paragraph 408.54 of the NEC®. UL Listed as Class CTL.



QOT 1P Tandem  
1 Space Required

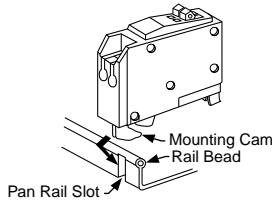

Table 1.4: QOT Tandem Circuit Breakers (CTL)—Not Compatible with Plug-on Neutral Systems

Ampere Rating [11]	Cat. No. [12]
<b>1P—120/240 Vac</b>	
15 A and 15 A	QOT1515
15 A and 20 A	QOT1520
20 A and 20 A	QOT2020
<b>2P—120/240 Vac Common Trip</b>	

Order two QOT1515 or QOT2020 circuit breakers and handle tie QOTHT for common switching of center two poles.

Table 1.5: QO Tandem Circuit Breakers (non-CTL)—Compatible with Plug-on Neutral Systems

Ampere Rating [11]	Cat. No. [12]
<b>1P—120/240 Vac—1 Space Required</b>	
15 A and 15 A	QO1515
15 A and 20 A	QO1520
20 A and 20 A	QO2020
20 A and 30 A	QO2030
30 A and 20 A	QO3020
<b>Two 1P Individual Trip—120/240 Vac—2 Spaces Required</b>	
15 A and 15 A	Order two QO1515 or QO2020 circuit breakers and handle tie QOTHT
15 A and 20 A	
20 A and 20 A	—
20 A and 30 A	QO20303020 [13]
30 A and 20 A	—

[11] 10–30 A circuit breakers are suitable for use with 60°C or 75°C conductors. 35–125 A circuit breakers are suitable for use with 75°C conductors.

[12] UL Listed as HACR type for use with air conditioning, heating and refrigeration equipment having motor group combinations and marked for use with HACR type circuit breakers.

[13] Includes two circuit breakers (one QO2030 and one QO3020) and handle tie QOTHT.





1P QO-GFI



2P QO-GFI

**QO Ground-Fault Circuit Breakers (GFI)**

Qwik-Gard™ circuit breakers provide overload and short circuit protection, combined with Class A ground fault protection. Class A denotes a ground fault circuit interrupter that will trip when a fault current to ground is 6 mA or more, for people protection. Do not connect to more than 250 feet of load conductor for the total one-way run to prevent nuisance tripping.

**Table 1.6: QO-GFI Circuit Breakers**

Circuit Breaker Type	Ampere Rating [14]	Qwik-Gard Circuit Breakers With Ground Fault Circuit Interrupter			
		1P 120 Vac		2P Common Trip 120/240 Vac	3P Common Trip 208Y/120 Vac
		10 k AIR 1 Space Required	22 k AIR 1 Space Required	10 k AIR 2 Spaces Required	10 k AIR 3 Spaces Required
Ground-Fault Circuit Interrupter (Pigtail Neutral)	15	QO115GFI	QO115VHGFI	QO215GFI	QO315GFI
	20	QO120GFI	QO120VHGFI	QO220GFI	QO320GFI
	25	—	—	QO225GFI	—
	30	QO130GFI	QO130VHGFI OBS	QO230GFI	QO330GFI
	35	—	—	QO235GFI	—
	40	—	—	QO240GFI	QO340GFI
	45	—	—	QO245GFI	—
	50	—	—	QO250GFI	QO350GFI
Plug-On Neutral Ground-Fault Circuit Interrupter	15	QO115PGFI [16]	—	—	—
	20	QO120PGFI [16]	—	—	—

OBS This product is obsolete.

**QO Arc-Fault Circuit Breaker (QO-CAFI)**

QO arc-fault circuit breakers provide protection for Series and Parallel Type Arcing as required by the NEC and local code adoption, and comply with UL 1699.

**Table 1.7: QO-CAFI Circuit Breakers**

Circuit Breaker Type [17]	Ampere Rating	One-Pole 120 Vac		Two-Pole 120/240 Vac	
		10 k AIR 1 Space Required	22 k AIR 1 Space Required	10 k AIR 2 Space Required	22 k AIR 2 Space Required
Combination Arc-fault Interrupter (Pigtail Neutral)	15	QO115CAFI	QO115VHCAFI	QO215CAFI [18]	QO215VHCAFI OBS
	20	QO120CAFI	QO120VHCAFI	QO220CAFI [18]	QO220VHCAFI OBS
Plug-On Neutral Combination Arc-fault Interrupter	15	QO115PAF	QO115VHPAF	—	—
	20	QO120PAF	QO120VHPAF	—	—

OBS This product is obsolete.



1P QO-CAFI Plug-On Neutral



1P QO-CAFI Pigtail

**QO Dual Function Circuit Breaker**

QO Combination Arc Fault and Ground Fault Circuit Interrupters (Dual Function) provide overload and short circuit protection, plus arc fault and ground fault protection in accordance with the NEC, UL 1699 and UL943.

**Table 1.8: QO-DF Circuit Breakers**

Circuit Breaker Type [17]	Ampere Rating	1P 120 Vac 10 k AIR 1 Space Required	1P 120 Vac 22 k AIR 1 Space Required
Combination Arc-fault and Ground Fault Circuit Interrupter (Pigtail Neutral)	15	QO115DF	QO115VHDF OBS
	20	QO120DF	QO120VHDF
Plug-On Neutral Combination Arc-fault and Ground Fault Circuit Interrupter	15	QO115PAFGF	QO115VHPAFGF
	20	QO120PAFGF	QO120VHPAFGF

OBS This product is obsolete.



1P QO-DF Plug-on Neutral



1P QO-DF Pigtail

[14] 10–30 A circuit breakers are suitable for use with 60°C or 75°C conductors. 35–60 A circuit breakers are suitable for use with 75°C conductors.

[15] Suitable only for feeding 240 Vac and 208 Vac two-wire loads. Does not contain load neutral connection.

[16] New Plug-On Neutral

[17] UL Listed as HACR type for use with air conditioning, heating and refrigeration equipment having motor group combinations and marked for use with HACR type circuit breakers.

[18] For 120/240 V only, not for 208Y/120 V.



QO 1P  
With Shunt Trip

### QO-EPD/EPE Circuit Breakers

QO-EPD/EPE circuit breakers provide overload and short circuit protection combined with Class B ground fault protection. They are designed to provide ground fault protection of equipment at a 30 mA level (EPD) or 100 mA level (EPE). They are not designed to protect people from electrical shock.

Table 1.9: QO-EPD Circuit Breakers

Ampere Rating [19]	1P 120 Vac 10 k AIR 1 Space Required	2P Common Trip 120/240 Vac 10 k AIR 2 Spaces Required	3P Common Trip 240 Vac 10 k AIR 3 Spaces Required	
15	QO115EPD	QO215EPD	QO315EPD <sup>OBS</sup>	QO315EPE [20]
20	QO120EPD	QO220EPD	QO320EPD [20]	QO320EPE [20]
25	QO125EPD <sup>OBS</sup>	QO225EPD	—	—
30	QO130EPD	QO230EPD	QO330EPD [20]	QO330EPE [20]
40	—	QO240EPD	QO340EPD [20]	QO340EPE [20]
50	—	QO250EPD	QO350EPD [20]	QO350EPE [20]
60	—	QO260EPD [21]	—	—

<sup>OBS</sup> This product is obsolete.

### QO Switch Neutral Common Trip Circuit Breakers (QO-SWN)

Switch Neutral Common Trip 2008 NEC® 514.11



Two-wire  
QO-SWN



Three-wire  
QO-SWN

Table 1.10: QO-SWN Circuit Breakers

Ampere Rating [22]	2 Wire 120 Vac 10 k AIR 2 Spaces Required	3 Wire 120/240 Vac 10 k AIR 3 Spaces Required
10	QO210SWN <sup>OBS</sup>	QO310SWN
15	QO215SWN	QO315SWN <sup>OBS</sup>
20	QO220SWN	QO320SWN
25	QO225SWN <sup>OBS</sup>	QO325SWN
30	QO230SWN <sup>OBS</sup>	QO330SWN <sup>OBS</sup>
40	QO240SWN <sup>OBS</sup>	QO340SWN <sup>OBS</sup>
50	QO250SWN <sup>OBS</sup>	QO350SWN <sup>OBS</sup>

<sup>OBS</sup> This product is obsolete.

### QO High Intensity Discharge Circuit Breakers (QO-HID)

HID circuit breakers are for use on circuits feeding fluorescent and high intensity discharge (HID) lighting systems such as mercury vapor, metal halide, or high pressure sodium. These circuit breakers are physically interchangeable with QO circuit breakers.

Table 1.11: QO-HID Circuit Breakers

Ampere Rating [22]	1P 120/240 Vac 10 k AIR 1 Space Required	2P Common Trip 120/240 Vac 10 k AIR 2 Spaces Required	3P Common Trip 240 Vac 10 k AIR 3 Spaces Required
15	QO115HID <sup>OBS</sup>	QO215HID <sup>OBS</sup>	QO315HID <sup>OBS</sup>
20	—	QO220HID	QO320HID
25	QO125HID <sup>OBS</sup>	QO225HID <sup>OBS</sup>	QO325HID <sup>OBS</sup>
30	QO130HID <sup>OBS</sup>	QO230HID <sup>OBS</sup>	QO330HID <sup>OBS</sup>
40	QO140HID <sup>OBS</sup>	QO240HID <sup>OBS</sup>	—
50	QO150HID <sup>OBS</sup>	QO250HID <sup>OBS</sup>	—

<sup>OBS</sup> This product is obsolete.

### QO Key Operated Circuit Breakers (QO-K)

Key operated QO circuit breakers are available in single-pole construction and can be mounted in any single-pole space which will accept a standard QO circuit breaker. These circuit breakers can be turned ON or OFF or to RESET with a special key (catalog number QOK10) included with the circuit breaker. These circuit breakers are UL Listed and available as shown in the table.



QO-K Key Operated

Table 1.12: QO-K Circuit Breakers

120 Vac—10 k AIR (1 Space Required)			
Ampere Rating [22]	Cat. No.	Ampere Rating [22]	Cat. No.
10	QO110K <sup>OBS</sup>	25	QO125K
15	QO115K <sup>OBS</sup>	30	QO130K <sup>OBS</sup>
20	QO120K <sup>OBS</sup>	—	—

<sup>OBS</sup> This product is obsolete.

[19] 10–30 A circuit breakers are suitable for use with 60°C or 75°C conductors. 35–60 A circuit breakers are suitable for use with 75°C conductors.

[20] See note in Instruction Bulletin when using in an enclosure with a QO403 or QON prefix.

[21] Suitable only for feeding 240 Vac and 208 Vac two-wire loads. Does not contain load neutral connection.

[22] 10–30 A circuit breakers are suitable for use with 60°C or 75°C conductors. 35–60 A circuit breakers are suitable for use with 75°C conductors.

### QO High Magnetic Trip Circuit Breakers (QO-HM)

High magnetic trip circuit breakers are recommended for applications where high initial inrush may occur and for individual dimmer applications.

**Table 1.13: QO-HM Circuit Breakers**

120 Vac—10 k AIR	
Ampere Rating [23]	1P
15 A	QO115HM [24] [25]
20 A	QO120HM [24] [25]

### Non-Automatic (Standard) Miniature Switches

Miniature non-automatic switches have the same physical packaging as miniature circuit breakers, but open only when the handle is switched to the OFF position.

Non-automatic switches provide no overcurrent protection or short circuit protection. They must not be used on systems that have an available fault current greater than the values listed in the table. Non-automatic switches are UL Listed per UL 1087 and are CSA certified.

**Table 1.14: QO Non-Automatic Miniature Switches, 240 Vac 10 kA**

Ampere Rating	2P	3P
60	QO200	QO300
100	QO2000 <sup>OBS</sup>	QO3000

<sup>OBS</sup> This product is obsolete.

[23] 10–30 A circuit breakers are suitable for use with 60°C or 75°C conductors. 35–60 A circuit breakers are suitable for use with 75°C conductors.

[24] UL Listed as HACR type for use with air conditioning, heating and refrigeration equipment having motor group combinations and marked for use with HACR type circuit breakers.

[25] UL Listed as SWD (switching duty) rated. Suitable for switching 120 Vac fluorescent lighting loads.

Accessories for QO/QOB Circuit Breakers

Table 1.15: Accessories for use with QO and QOB Miniature Circuit Breakers

Description		Cat. No.	Schedule
<b>Handle Attachments</b>			
Handle Tie	Converts any two adjacent 120/240 Vac 1P QO circuit breakers to independent trip 2P Converts any two adjacent 120/240 Vac 1P side-by-side QOT circuit breakers to independent trip 2P	QO1HT QOTHT QO3HT	DE2E DE2E
Handle Clamp	Clamp for holding QO 1P handle in ON or OFF position Clamp for holding QO or Q1 either 1P, 2P or 3P circuit breaker handles in ON or OFF position	QO1LO HLO1	DE2E DE2E
Handle Padlock Attachment for Padlocking in ON or OFF position	For padlocking 1P QO circuit breaker in ON or OFF position Loose attachment	QOHPL QO1PA	DE2E DE2E
	Fixed attachment	QOTHPA <sup>obs</sup>	DE2E
	For padlocking 1P side-by-side QOT circuit breaker in ON or OFF position	QOTHPA <sup>obs</sup>	DE2E
	For padlocking 2P QO-GFI circuit breakers in either ON or OFF position, fixed attachment.	GFI2PA	DE2A
Handle Padlock Attachment for Padlocking in OFF position	For 2P and 3P QO and Q1 standard circuit breakers which require padlocking in either ON or OFF position. Loose attachment	QO1HPL QO1PL	DE2E DE2E
	Fixed attachment	QO1PAF	DE2E
	For padlocking 1P QO circuit breaker in OFF position only, fixed attachment.	QO1PAF	DE2E
	For padlocking 2P and 3P QO circuit breakers in OFF position only, fixed attachment.	QO2PAF	DE2E
Mechanical Interlock Attachment for Padlocking in OFF position	For padlocking 1P QO-GFI, QO-CAFI, QO-DF and QO-EPD circuit breakers in OFF position only, fixed attachment.	QOGFI1PAF	DE2E
	For padlocking 2P QO-GFI, QO-CAFI and QO-EPD circuit breakers in OFF position only, fixed attachment.	QOGFI2PAF	DE2E
	For padlocking 1P QO-GFI, QO-CAFI and QO-EPD circuit breakers in OFF position only, fixed attachment.	QOGFI2PAF	DE2E
Ring Terminal	Ring terminals are available as a factory-installed option.	See Section 7	DE2A
Sub-feed Lugs	60 A 2P plug-on – 2 spaces required (6–2 Al/Cu) 125 A 2P plug-on – 2 spaces required (12–2/0 Al/Cu) 225 A 2P plug-on – 4 spaces required (4–300 Al/Cu) 125 A 3P plug-on – 3 spaces required (12–2/0 Al/Cu)	QO60SL <sup>obs</sup> QO2125SL QO2225SL [26] QO3125SL	DE2A DE2A DE2A DE3
Mechanical Interlock Attachment	For interlocking the handles of two 2P or one 2P and one 1P QO and Q1 circuit breakers mounted side-by-side so that only one circuit breaker can be ON at a time (Not QOU)	QO2DTI	DE2E
With Retaining Kit	QO2DTI mechanical interlock attachment with retaining kits for securing two adjacent back-fed circuit breakers in dual power supply applications. Can be used with (2) 2Ps or (1) 2P and (1) 1P QO circuit breakers in QO816L100 load centers.	QO2DTIM	DE2E

<sup>obs</sup> This product is obsolete.



QO1PA



QO1PL



QO1HT



HLO1



QO1PAF



QO2DTI



QO1HPL



QOTHPA



QO1LO



QOHPL



QO2PAF



QOGFI2PAF

[26] Not suitable for use in 3Ø panels. Use only in 1Ø panel rated 150 A or greater.

**Factory-Installed Accessories for QO and QOB Miniature Circuit Breakers**

Factory-installed electrical accessories take up an additional pole space on QO, QO-GFI, QO-EPD, QO-SWN and QOU circuit breakers. All AC electrical accessories shown below are rated for 50/60 Hz. Accessories are not available for QOB-VH (2P 150 A and 3P 110–150 A) circuit breakers or QO, QOU molded case switches. QO circuit breakers will accept only one accessory per circuit breaker. Undervoltage trip is not available on miniature circuit breakers. Factory-installed accessories are not available for QO-AFI or QO-CAFI Arc Fault Circuit Breakers, QO-CAFI, QO-DF, or QO-PDF circuit breakers, or on QO2150, QO2175, or QO2200 circuit breakers.

**Table 1.16: Factory-Installed Accessories for QO/QOB Circuit Breakers**

Accessory	Description	Rated Voltage	Coil Burden	Cat. No. Suffix	Accessory	Description	Contact Comb.	Max. Voltage	Max.	Cat. No. Suffix
Shunt Trip	Trips the circuit breaker from a remote location by means of a trip coil energized from a separate circuit. A 120 Vac shunt trip will operate at 55% or more of rated voltage. All other shunt trips will operate at 75% or more of rated voltage. <b>Application</b> <ul style="list-style-type: none"> <li>For use with momentary or maintained push button.</li> <li>Not available on QO-GFI, QO-EPD, QO-AFI, QO-CAFI, QO-DF, or QO-PDF.</li> <li>Shunt trip terminals accept (2) 0.14–0.12 AWG Cu.</li> </ul>	12 Vac/Vdc 24 Vac/Vdc	60 VA 168 VA	-1042	Auxiliary Switches	Monitors circuit breaker contact status and provides a remote signal indicating the circuit breaker contacts are OPEN or CLOSED. <b>Application</b> <ul style="list-style-type: none"> <li>Auxiliary switch terminals accept (2) 14–12 AWG Cu leads.</li> <li>Leads (EH): Yellow for "A", Blue for "B", Striped common 18 AWG Cu.</li> </ul>	1A 1B	120 Vac 120 Vac	5 A 5 A	-1200 -1201
		120 Vac 208 Vac 240 Vac	72 VA 228 VA 288 VA	-1021	Alarm Switches	Used with control circuits and is actuated only when the circuit breaker has tripped. Standard construction includes a normally-open contact. <b>Application</b> <ul style="list-style-type: none"> <li>Leads: Alarm switch terminals accept (2) 14–12 AWG Cu leads.</li> </ul>	1A	120 Vac	5 A	-2100

**Plug-on Neutral Load Center Main Lugs, Convertible Mains (1Ø3W—120/240 Vac Indoor—UL Listed)**

QO Plug-on Neutral Load Centers and CAFI Breakers are engineered for a quick Plug-on Neutral connection on every unit.

**Table 1.17: Convertible Main Lugs Plug-on Neutral Load Center (Compatible with QO Plug-on Circuit Breaker and QO Plug-on Neutral Circuit Breakers)**

	Mains Rating	Spaces	Max. Single Pole Circuits [1]	Max. Tandem Circuit Breakers	Load Center Box and Interior	Load Center Covers		AI	CU	Equipment Ground Bar Kit (Factory-Included)	Box No. [2]	
						Flush/Surface	Mono-Flat					
INDOOR	<b>Convertible Mains—Factory-installed Main Circuit Breaker, 65 kA Short Circuit Current Rating—Copper Bus</b>											
	<b>QOM1 Main Frame Size—Convertible to Main Circuit Breaker</b>											
	125 A	12	24	12	12	QO112L125PG	QOC16UF[3] QOC16US	—	6–2/0		PKGTALP1	6
		16	24	8	8	QO116L125PG	QOC24UF[3] QOC24US	—	6–2/0		PKGTALP1	7
		20	24	4	4	QO120L125PG	QOC20U100F[3] QOC20U100S	—	6–2/0		PKGTALP1	6
		24	34	10	10	QO124L125PG	QOC24UF[3] QOC24US	—	6–2/0		PK15GTAL	7
		30	34	4	4	QO130L125PG	QOC30U125C	—	6–2/0		PK23GTAL	9
	32	38	6	6	QO132L125PG	QOC32UF[3]	—	6–2/0		PKGTALP1	8	
	<b>Convertible Mains—Factory-installed Main Circuit Breaker, 65 kA Short Circuit Current Rating—Copper Bus</b>											
	<b>QOM2 Main Frame Size—Convertible to Main Circuit Breaker</b>											
	200 A	12	24	12	12	QO112L200PG	QOC30UF[3] QOC30US	QOCMF30UCW [3]	4–300	4–250	PKGTALP1	9
		24	36	12	12	QO124L200PG	QOC30UF[3] QOC30US	QOCMF30UCW [3]	4–300	4–250	PKGTALP1	9
		30	40	10	10	QO130L200PG	QOC30UF[3] QOC30US	QOCMF30UCW [3]	4–250		PK23GTAL	9
		40	60	20	20	QO140L200PG	QOC40UF[3] QOC40US	—	4–300	4–250	PKGTALP2	10
	225 A	42	52	10	10	QO142L225PG	QOC42UF[3] QOC42US	QOCMF42UCW [3]	4–300		PK23GTAL	11
		54	64	10	10	QO154L225PG	QOC54UF[3]	QOCMF54UCW [3]	4–300		PK23GTAL	11

Above listings through 200 A mains rating meet Federal Specification W-P-115c as Type 1, Class 2.

[1] Maximum single pole branch circuits utilizing QO and/or QOT circuit breakers.  
 [2] See page 1-32  
 [3] Available in gray and white. For white equivalencies, add the "W" suffix to the reference, or see page 1-28.

Field-Installed Main Circuit Breaker Kits, 1Ø

Table 1.18: QOM1 Frame Size—Use with Convertible Main Load Centers Only



QOM1 Frame Size  
50–125 Amperes

Main Circuit Breaker Rating [4]	Convertible Load Center Mains Rating	22 k AIR [5]		Lug Wire Size [6] AWG/kcmil
		Main Circuit Breaker		
50 A	100–125	QOM50VH		12–2/0 Al or Cu
60 A	100–125	QOM60VH		
70 A	100–125	QOM70VH		
80 A	100–125	QOM80VH		
90 A	100–125	QOM90VH		
100 A	100–125	QOM100VH		
110 A	125	QOM110VH		
125 A	125	QOM125VH		



QOM2 Frame Size  
100–225 Amperes

Table 1.19: QOM2 Frame Size—Use with Convertible Main Load Centers Only

Main Circuit Breaker Rating [4]	Convertible Load Center Mains Rating	22 k AIR [5]		Lug Wire Size [6] AWG/kcmil
		Main Circuit Breaker [7]		
100 A	150–225	QOM2100VH		4–300 Al or Cu
125 A	150–225	QOM2125VH		
150 A	150–225	QOM2150VH		
175 A	200–225	QOM2175VH		
200 A	200–225	QOM2200VH		
225 A	225	QOM2225VH		

Plug-on Neutral Load Center Main Breaker, Convertible Mains (1Ø3W—120/240 Vac Indoor—UL Listed)

QO Plug-on Neutral Load Centers and CAFI Breakers are engineered for a quick Plug-on Neutral connection on every unit.

Table 1.20: Convertible Main Breaker Plug-on Neutral Load Centers (Compatible with QO Plug-on Circuit Breakers and QO Plug-on Neutral Circuit Breakers)

Mains Rating	Spaces	Max. 1P Circuits	Max. Tandem Breakers	Load Center Box and Interior	Load Center Covers		Al	Cu	Equipment Ground Bar Kit (Order Separately)	Box No. [8]	
					Flush/Surface	Mono-Flat					
Convertible Mains — Factory-Installed Main Lugs — 22 kA Short Circuit Current Rating Convertible to Main Lugs (see below) or Lower Amperage Main Circuit Breaker (see QO Standard Plug-On Circuit Breakers, page 1-3) [5], QOM1 Main Circuit Breaker Frame Size—Copper Bus											
100 A	12	24	12	QO112M100P	QOC12UF QOC12US	—	6-2/0	6-1	PK9GTA	5	
	16	24	8	QO116M100P	QOC20U100F[9] QOC200U100S	—	6-2/0	6-1	PK9GTA	6	
	20	24	4	QO120M100P	QOC20U100F[9] QOC200U100S	—	6-2/0	6-1	PK9GTA	6	
	24	34	10	QO124M100P	QOC24UF[9] QOC24US	—	6-2/0		PK15GTA	7	
	32	38	6	QO132M100P	QOC32UF[9]	—	6-2/0		PK15GTA	8	
125 A	24	34	10	QO124M125P	QOC24UF[9] QOC24US	—	6-2/0		PK15GTA	7	
	32	38	6	QO132M125P	QOC32UF[9]	—	6-2/0		PK15GTA	8	
Convertible Mains — Factory-Installed Main Lugs — 22 kA Short Circuit Current Rating Convertible to Main Lugs (see below) or Lower Amperage Main Circuit Breaker (see QO Standard Plug-On Circuit Breakers, page 1-3) [5], QOM2 Main Circuit Breaker Frame Size—Copper Bus											
150 A	20	30	10	QO120M150P	QOC30UF[9] QOC30US	QOCMF30UCW[9]	4-250		PK15GTA	9	
	24	36	12	QO124M150P	QOC30UF[9] QOC30US	QOCMF30UCW[9]	4-250		PK15GTA	9	
	30	40	10	QO130M150P	QOC30UF[9] QOC30US	QOCMF30UCW[9]	4-250		PK15GTA	9	
	32	40	10	QO132M150P	QOC40UF[9] QOC40US	—	4-300	4-250	PK15GTA	10	
200 A	20	30	10	QO120M200P	QOC30UF[9] QOC30US	QOCMF30UCW[9]	4-300	4-250	PK15GTA	9	
	24	36	12	QO124M200P	QOC30UF[9] QOC30US	QOCMF30UCW[9]	4-300	4-250	PK15GTA	9	
	30	40	10	QO130M200P	QOC30UF[9] QOC30US	QOCMF30UCW[9]	4-250		PK15GTA	9	
	40	60	20	QO140M200P	QOC40UF[9] QOC40US	—	4-300	4-250	PK23GTA	10	
	42	52	10	QO142M200P	QOC42UF[9] QOC42US	QOCMF42UCW[9]	4-300		PK18GTA	11	
225 A	54	72	18	QO154M200P	QOC54UF[9]	QOCMF54UCW[9]	4-300		PK23GTA	12	
	60	72	12	QO160M200PC [10]	—	—	4-300		PK27GTA	24	
	40	60	20	QO140M225P	QOC42UF[9] QOC42US	QOCMF42UCW[9]	4-300		PK23GTA	11	
	42	52	10	QO142M225P	QOC42UF[9] QOC42US	QOCMF42UCW[9]	4-300		PK18GTA	11	

Above listings through 200 A mains rating meet Federal Specification W-P-115c as Type 1, Class 2.

[4] Do not exceed the load center mains rating.  
 [5] 22 k AIR main circuit breaker UL Listed for use ahead of QO, QOT and QO-PL 10 k AIR branch circuit breakers to permit their application on systems with up to 22 kA available fault current.  
 [6] Wire range listed for QOM circuit breaker kits is the wire range of that circuit breaker. To find out maximum wire size permitted in a particular load center per UL, see Main Wire Size in that load center table.  
 [7] Add suffix 1021 for 120, 208 or 240 Vac shunt trip.  
 [8] See Indoor Knockout Information and Enclosure Dimensions, page 1-32.  
 [9] Available in gray and white. For white equivalencies, add the "W" suffix to the reference, or see page 1-28.  
 [10] For Certification to IEC 60439-1 contact the local Square D sales office; otherwise panels are NOT CE marked. (For use on 415Y/240 Vac 3-phase 4-wire, 3,000 Short Circuit Current Rating when QOXD...branch circuit breakers are used and 10,000 Short Circuit Current Rating when QO...VS branch circuit breakers are used).

**Field-Installed Main Lugs Kits, 1Ø**

**Table 1.21: 1Ø Field-Installed Main Lug Kits—Use with Convertible Main Load Centers Only**



QOL125

QOL225

Main Lugs Rating [11]	Use on Convertible Load Center with Mains Rating	Cat. No.	Lug Wire Size [12] AWG/kcmil Al or Cu
125 A	100–125 A	QOL125 [13]	6–2/0
125 A	100–125 A	QOL125VD [13]	6–4/0
225 A	150–225 A	QOL225 [13]	6–300

**QO™ Plug-On Neutral Load Centers with Qwik-Grip™ (1Ø3W—120/240 Vac Indoor—UL Listed)**

The Square D QO plug-on neutral load centers with Qwik-Grip simplify rough-in by eliminating the need to remove knockouts, install wire connectors, and blindly pull wire into the load center. A quick bend of the wire using the wire bend guide on the Qwik-Grip insert and the wire slides into the slot. Once inserted, the Qwik-Grip shield snaps on to keep the wire behind the router for a secure, code-compliant installation.



QO Plug-on Neutral Load Center with Qwik-Grip™

**Table 1.22: Plug-on Neutral Load Centers with Qwik-Grip (Compatible with QO Plug-on Circuit Breakers and QO Plug-on Neutral Circuit Breakers)**

	Mains Rating	Spaces	Max. Single Pole Circuits	Max. Tandem Circuit Breakers	Load Center Box and Interior	Indoor Cover with Door (Order Separately)		Main Wire Size AWG/kcmil		Equipment Ground Bar Kit	Box No.	
						Flush/Surface	Mono-Flat	Al	Cu			
ROUNDER	Convertible Mains—Factory-Installed Main Lugs, 65 kA Short Circuit Current Rating—Copper Bus, QOM1 Main Frame Size, Convertible to Main Circuit Breaker											
	125 A	24	34	10	QO124L125PQG	QOC24UF [14] QOC24US	—	6–2/0		PK15GTAL Included	7Q	
		30	34	4	QO130L125PQG	QOC30U125C	—			PK23GTAL Included	9Q	
	Convertible Mains—Factory—Installed Main Lugs, 65 kA Short Circuit Current Rating—Copper Bus, QOM2 Main Frame Size, Convertible to Main Circuit Breaker											
	200 A	30	40	10	QO130L200PQG	QOC30UF [14] QOC30US	QOCMF30UCW [14]	6–300		PK23GTAL Included	9Q	
		225 A	42	52	10	QO142L225PQG	QOC42UF [14] QOC42US			QOCMF42UCW [14]	PK23GTAL	9Q
			54	72	18	QO154L225PQG	QOC54UF [14]	QOCMF54UCW [14]	6–300	PK23GTAL Included	12Q	
	Convertible Mains—Factory-Installed Main Circuit Breaker, 22 kA Short Circuit Current Rating—Copper Bus, QOM2 Main Frame Size, Convertible to Main Lugs or Main Circuit Breaker											
	200 A	30	40	10	QO130M200PQ	QOC30UF [14] QOC30US	QOCMF30UCW [14]	4–250		PK23GTA (Order separately)	11Q	
		42	52	10	QO142M200PQ	QOC42UF [14] QOC42US	QOCMF42UCW [14]			PK23GTA (Order separately)	11Q	
		54	72	18	QO154M200PQ	QOC54UF [14]	QOCMF54UCW [14]			PK23GTA (Order separately)	12Q	

[11] Do not exceed the load center mains rating.

[12] Wire range listed for QOL lug kits is the wire range of that lug. To find out maximum wire size permitted in a particular load center per UL, see Main Wire Size in that load center table.

[13] If main circuit breaker knockout has been removed from the load center's trim, order appropriate filler plate from Table 1.51, page 1-24

[14] Available in gray and white. For white equivalencies, add the "W" suffix to the reference, or see page 1-28.

**QO Load Centers with Included Cover  
(1Ø3W—120/240 Vac Indoor—UL Listed)**

**Table 1.23: Load Centers with Included Cover (Compatible with QO Plug-on Circuit Breakers and QO Plug-on Neutral Circuit Breakers)**

Mains Rating	Short Circuit Current Rating	Spaces	Max. 1P Circuits [15]	Max. Tandem Circuit Breakers	Load Center [16] Box, Interior, and Cover	Al	Cu	Equipment Ground Bar Kit	Box No. [17]
125 A	65 kA	12	24	12	QO112L125PGC	6-2/0		PKGTALP1 Included	1
	65 kA	20	24	4	QO120L125PGC	6-2/0		PKGTALP1 Included	1
	65 kA	24	34	10	QO124L125PGC	6-2/0		PK15GTA, LK100AN Included	2
Convertible Mains—Factory-Installed Main Lugs [18]—QOM2 Main Frame Size—Convertible to Main Circuit Breaker (See page 1-3)—Copper Bus									
200 A	65 kA	30	40	10	QO130L200PGC	4-250		PK23GTA, LK100AN Included	9
225 A	65 kA	42	52	10	QO142L225PGC	4-300		PK23GTA, LK100AN Included	11
	65 kA	54	72	18	QO154L225PGC	4-300		PK23GTA, LK100AN Included	12
Convertible Mains—Factory-Installed Main Circuit Breaker—QOM1 Main Frame Size—Convertible to Main Lugs (See page 1-24 or Lower Amperage Main Circuit Breaker (See page 1-3)—Copper Bus [8]/[19]									
100 A	22 kA	12	24	12	QO112M100PC	6-2/0	6-1	PK9GTA	5
	22 kA	16	24	8	QO116M100PC	6-2/0	6-1	PK9GTA	6
	22 kA	20	24	4	QO120M100PC	6-2/0	6-1	PK9GTA	6
	22 kA	24	34	10	QO124M100PC	4-300		PK15GTA	7
Convertible Mains—Factory-Installed Main Circuit Breaker—QOM2 Main Frame Size—Convertible to Main Lugs (See page 1-24 or Lower Amperage Main Circuit Breaker (See page 1-3)—Copper Bus [8]/[19]									
150 A	22 kA	30	40	10	QO130M150PC	4-250		PK15GTA	9
	22 kA	42	52	10	QO142M150PC	4-300		PK18GTA	11
200 A	22 kA	30	40	10	QO130M200PC	4-250		PK15GTA	9
	22 kA	40	60	20	QO140M200PC	4-300	4-250	PK23GTA	10
	22 kA	42	52	10	QO142M200PC	4-300		PK18GTA	11
	22 kA	54	72	18	QO154M200PC	4-300		PK23GTA	12

**Plug-on Neutral Load Center Main Lugs, Convertible Mains  
(1Ø3W—120/240 Vac Rainproof—UL Listed)**

QO Plug-on Neutral Load Centers and CAFI Breakers are engineered for a quick Plug-on Neutral connection on every unit.

**Table 1.24: Convertible Main Lugs Plug-on Neutral Load Center (Compatible with QO Plug-on Circuit Breakers and QO Plug-on Neutral Circuit Breakers)**

Mains Rating	Spaces	Max. Single Pole Circuits [15]	Max. Tandem Circuit Breakers	Load Center Box and Interior	Al	Cu	Equipment Ground Bar Kit (Factory Included)	Box No. [20]
Convertible Mains — Factory-Installed Main Lugs — 65 kA Short Circuit Current Rating [21][18][22] QOM1 Main Circuit Breaker Frame Size, Convertible to Main Circuit Breaker — Equipment Ground Bar Included								
125 A	12	24	12	QO112L125PGRB	6-2/0		PKGTALP1	3R
	16	24	8	QO116L125PGRB	6-2/0		PKGTALP1	4R
	24	34	10	QO124L125PGRB	6-2/0		PK15GTA	4R
Convertible Mains — Factory-Installed Main Lugs — 65 kA Short Circuit Current Rating [21][18][22] QOM2 Main Circuit Breaker Frame Size, Convertible to Main Circuit Breaker — Equipment Ground Bar Included								
200 A	12	24	12	QO112L200PGRB	4-300	4-250	PKGTALP1	5R
	30	40	10	QO130L200PGRB	4-250		PK23GTAL	6R
	40	60	20	QO140L200PGRB	4-300	4-250	PKGTALP2	7R
225 A	42	52	10	QO142L225PGRB	4-300		PK23GTA, LK100AN	8R

Above listings through 200 A mains rating meet Federal Specification W-P-115C as Type 1, Class 2.

[15] Maximum single pole branch circuits utilizing QO and/or QOT circuit breakers.

[16] Order F for flush device or S for surface device.

[17] See page 1-32

[18] UL Listed 5000 A short circuit current rating for corner grounded Delta systems. Use QO-H circuit breakers only.

[19] [9]22 k AIR main circuit breaker UL Listed for use ahead of QO, QOT and QO-PL 10 k AIR branch circuit breakers to permit their application on systems with up to 22 kA available fault current.

[20] See Table 1.76 Enclosure Dimensions, page 1-34 or Indoor Enclosure Dimensions and Knockout Information, page 1-32

[21] UL short circuit current rating depends on lowest interrupting rating of circuit breaker installed.

[22] Side hinge door device; allow 1-1/4 in. on left side for door to open.



**Plug-on Neutral Load Center Main Breaker, Convertible Mains (1Ø3W—120/240 Vac Rainproof—UL Listed)**

QO Plug-on Neutral Load Centers and CAFI circuit breakers are engineered for a quick Plug-on Neutral connection on every unit.

**Table 1.25: Convertible Main Breaker Plug-on Neutral Load Center (Compatible with QO Plug-on Circuit Breakers and QO Plug-on Neutral Circuit Breakers)**

	Mains Rating	Spaces	Max. Single Pole Circuits [23]	Max. Tandem Circuit Breakers	Load Center Box and Interior	Al	Cu	Equipment Ground Bar Kit (Order Separately)	Box No. [24]	
RAI N P R O O F	Convertible Mains — Factory-Installed Main Breaker — 22 kA Short Circuit Current Rating Convertible to Main Lugs (see below) or Lower Amperage Main Circuit Breaker (See page 1-3)[25] QOM1 Main Circuit Breaker Frame Size—Copper Bus									
	100 A	12	24	12		QO112M100PRB	6-2/0		PK9GTA	3R
		16	24	8		QO116M100PRB	6-2/0		PK9GTA	4R
		20	24	4		QO120M100PRB	6-2/0		PK9GTA	4R
		24	34	10		QO124M100PRB	6-2/0		PK15GTA	4R
	125 A	24	34	10		QO124M125PRB	6-2/0		PK15GTA	4R
	Convertible Mains — Factory-Installed Main Breaker — 22 kA Short Circuit Current Rating Convertible to Main Lugs (see below) or Lower Amperage Main Circuit Breaker (See page 1-3) [25] QOM2 Main Circuit Breaker Frame Size—Copper Bus									
	150 A	20	30	10		QO120M150PRB	4-300	4-250	PK15GTA	5R
		30	40	10		QO130M150PRB	4-250		PK15GTA	6R
	200 A	20	30	10		QO120M200PRB	4-300	4-250	PK15GTA	5R
		30	40	10		QO130M200PRB	4-250		PK15GTA	6R
		40	60	20		QO140M200PRB	4-300	4-250	PK23GTA	7R
		42	52	10		QO142M200PRB	4-300		PK18GTA	8R
	225 A	42	52	10		QO142M225PRB	4-300		PK18GTA	8R

Above listings through 200 A mains rating meet Federal Specification W-P-115C as Type 1, Class 2.

[23] Maximum single pole branch circuits utilizing QO and/or QOT circuit breakers.

[24] See Table 1.76 Enclosure Dimensions, page 1-34 or Indoor Enclosure Dimensions and Knockout Information, page 1-32

[25] 22 k AIR main circuit breaker UL Listed for use ahead of QO, QOT, QO-GFI, QO-AFI, QO-EPD and QOPL 10 k AIR branch circuit breakers to permit their application on systems up to 22 kA

Backup Power Solutions  
(1Ø3W—120/240 Vac Backup Power—UL Listed)

Table 1.26: Backup Power Solutions

	Mains Rating (A)	Spaces	Max. Single Pole Circuits [26]	Max. Tandem Circuit Breakers	Load Center Box, Interior and Cover	Equipment Grounding Bar Kit (Order Separately)	Main Wire Size AWG/kcmil		Box No. [27]
							Al	Cu	
INDOOR	Generator Panels—Manual Transfer for Sub-Feed Applications NEMA 1 (Indoor)								
	Factory-Installed Main Circuit Breakers with Mechanical Interlock—10 kA Short Circuit Current Rating								
	30	4	8	4	QO48M30DSGP	PK7GTA	14–8	14–8	4
	60	4	8	4	QO48M60DSGP		8–2	8–2	4
	Split Bus Plug-on Neutral Load Centers—Manual Transfer for use with Temporary Backup Power Source Applications NEMA 1 (Indoor)								
200	48	48	0	QO122X26M200PC	PK23GTA	4–250	4–250	12	
	36	69	34	HOM1427X2242M200PC	PK27GTA	4–250	4–250	12	
RAINFROOF	Generator Panels—Manual Transfer with Generator Power Inlet Plug for Sub-Feed Applications NEMA 3R (Outdoor)								
	Factory-Installed Main Circuit Breakers with Mechanical Interlock—10 kA Short Circuit Current Rating								
	100	4	8	4	QO1DM10020TRBR	Factory-Installed	—	8–2	17R
		4	8	4	QO1DM10030TRBR		—		17R
		4	8	4	QO1DM10050TRBR		—		17R
Split Bus Plug-on Neutral Load Centers—Manual Transfer for use with Temporary Backup Power Source Applications NEMA 1 (Indoor)									
200	48	48	0	QO122X26M200PC	PK23GTA	—	4–250	12	

Table 1.27: Manual Power Transfer Accessories

	Description	Cat. No.	Schedule
Manual Transfer Equipment Kit	For interlocking the handles of two 2P or one 2P and one 1P QO and Q1 circuit breakers mounted side-by-side so that only one circuit breaker can be "ON" at a time.	QO2DTI	DE2E
	QO2DTI mechanical interlock attachment with retaining kits for securing two adjacent back-fed circuit breakers in dual power supply applications. Can be used with (2) 2P or (1) 2P and (1) 1P QO circuit breakers in QO816L100 load centers.	QO2DTIM	DE2E
	Secures two 2P circuit breakers to right side of interior when used as back-fed mains, a QO2DTI Kit included for back-up power supply applications. For 1Ø 100–125 ampere convertible main load centers. Series S01 and S02.	PK4DTIM4LA	DE3A
	Secures two 2P circuit breakers to right side of interior when used as back-fed mains, a QO2DTI Kit included for back-up power supply applications. For 1Ø 150–225 ampere convertible main load centers. Series S01 and S02.	PK4DTIM4HA	DE3A
	Secures two 2P circuit breakers to left side of interior when used as back-fed mains, a QO2DTI Kit included for back-up power supply applications. For 1Ø 100–125 ampere convertible main load centers. Series S01 and S02.	PK4DTIM4LAL	DE3A
Generator Circuit Breaker Interlock Kit	For use on "G" and "S" Series NEMA 1 and "G", "S1" and "S2" Series NEMA 3R load centers. Interlocks a QOM1 2P main circuit breaker of a load center (100–125 A) with a QO 2P (15–125 A) branch circuit breaker. Includes a retaining kit.	QOCRBGK1C	DE3A
	For use on "G" and "S" Series NEMA 1 and "G" and "S1" Series NEMA 3R load centers. Interlocks a QOM2 2P main circuit breaker of a load center (150–225 A) with a QO 2P (15–125 A) branch circuit breaker. Includes a retaining kit.	QOCGK2C	DE3A
	For use on "S2" Series NEMA 3R load centers. Interlocks a QOM2 2P main circuit breaker of a load center (150–225 A) with a QO 2P (15–125 A) branch circuit breaker. Includes a retaining kit.	QORBKGK2C	DE3A

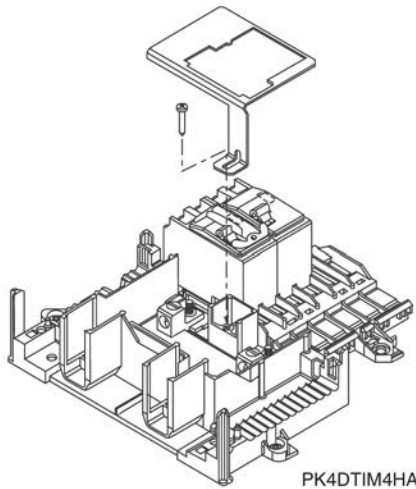

QOCGK2C

[26] Maximum single pole branch circuits utilizing QO and/or QOT circuit breakers.

[27] See page 1-32 or page 1-34

**QO Standard Load Center Main Lugs and Main Breaker, Fixed Mains (1Ø3W—120/240 Vac Special Applications—UL Listed)**

**Table 1.28: Low Amperage Fixed Main Lugs Indoor Load Centers (Accepts Only QO Plug-on Circuit Breakers - Not compatible with QO Plug-on Neutral Circuit Breakers)**

	Mains Rating	Spaces	Max. 1P Circuits [28]	Max. Tandem Circuit Breakers	Load Center Box and Interior	Indoor Cover with Door (Order Separately)		Main Wire Size AWG/kcmil		Equipment Ground Bar Kit (Order Separately)	Box No. [29]	
						Flush	Surface	Al	Cu			
INDOOR	Fixed Mains—Factory-Installed Main Lugs—10 kA Short Circuit Current Rating [30]											
	30 A	2	2	0	QO2L30S [31] [32]	Cover Included—Without Door		12–10	14–10	PK3GTA1	1	
	70 A	2	4	2	QO24L70F / S [33] [34]	Cover Included—Without Door		12–3	14–4	PK4GTA	2	
	100 A	6	12	6	QO612L100F / S [33] [35]	Cover Included—Without Door		8–1		PK7GTA	4	
		6	12	6	QO612L100DF / S [33] [35]	Cover Included—With Door				PK7GTA	4	
		8	16	8	QO816L100F / S [33] [35]	Cover Included—Without Door				PK7GTA	4	
		8	16	8	QO816L100DF / S [33] [35]	Cover Included—With Door				PK7GTA	4	
		6	12	6	QO612L100DFCU / SCU [33] [35] [36]	Cover Included—With Door				PK7GTA	4	
		8	16	8	QO816L100DFCU / SCU [33] [35] [36]	Cover Included—With Door				PK7GTA	4	
	125 A	4	8	4	QO148L125GF / S [33] [37]	Cover Included—Without Door		12–2/0	14–2/0	PK7GTA [38]	21	

**Table 1.29: Low Amperage Fixed Mains Indoor Load Centers with Factory Installed Ground Bar (Accepts Only QO Plug-On Circuit Breakers - Not compatible with QO Plug-on Neutral Circuit Breakers)**

	Mains Rating	Short Circuit Current Rating	Spaces	Max. 1P Circuits [28]	Max. Tandem Circuit Breakers	Load Center [33] Box, Interior, and Cover	Equipment Ground Bar Kit (Order Separately)	Main Wire Size AWG/kcmil		Box No. [39]	
								Al	Cu		
INDOOR	Manufactured Housing: 1Ø2W 120 Vac—Main Lugs Only—CSA Certified										
	30 A [40]	10 kA	2	2	0	QO2L30TTS [41]	Factory-installed	12–10	14–10	1	
	50 A	10 kA	2	4	2	QO24L50TTS [42]		—	14–6	2	
	1Ø2W 120 Vac—Main Circuit Breaker—CSA Certified										
	30 A	10 kA	3	5	2	QO35FM30TTF / S	Factory-installed	[43]		3	
	1Ø3W 120/240 Vac—Main Lugs Only—CSA Certified										
	70 A	10 kA	2	4	2	QO24L70TS [42]	Factory Installed	12–3	14–4	2	
	100 A	10 kA	6	12	6	QO612L100TF OBS		4–1		4	
			6	12	6	QO612L100DTF / S [44]				4	
			8	16	8	QO816L100TF / S [44]				4	
8			16	8	QO816L100DTF / S [44]	4					

OBS This product is obsolete.

**Table 1.30: High Amperage Fixed Main Breaker and Main Lugs Indoor Load Centers (Accepts Only QO Plug-On Circuit Breakers - Not compatible with QO Plug-on Neutral Circuit Breakers)**

	Mains Rating	Spaces	Max. 1P Circuits [28]	Max. Tandem Circuit Breakers	Load Center Box and Interior	Indoor Cover with Door (Order Separately)		Main Wire Size AWG/kcmil		Equipment Ground Bar Kit (Order Separately)	Box No. [29]	
						Flush	Surface	Al	Cu			
INDOOR	300 A	42	42	0	QONQ42MS300 (Int) [45]	NC62NQVF	NC62NQVS	(1) 4–500		PK27GTA [46] or PK15GTA6	16	
					MH62 (Box) [47]			or (2) 4–3/0				
	400 A	42	42	0	QONQ42MS400 (Int) [45]	NC62NQVF	NC62NQVS	(1) 4–500		16		
					MH62 (Box) [47]			or (2) 4–3/0				
	Fixed Mains—Factory-Installed Main Lugs—65 kA Short Circuit Current Rating [30] [48]											
	400 A	30	30	0	QONQ30LS400 (Int) [45]	NC50NQVF	NC50NQVS	(1) 1/0–750		PK27GTA [46] or PK15GTA6	15	
MH50 (box) [47]					or (2) 1/0–300							
400 A	42	42	0	QONQ42LS400 (Int) [45]	NC50NQVF	NC50NQVS	(1) 1/0–750		15			
				MH50 (box) [47]			or (2) 1/0–300					

Above listings through 200 A mains rating meet Federal Specification W-P-115C as Type 1, Class 2.

- [28] Maximum single pole branch circuits utilizing QO and/or QOT circuit breakers.
- [29] See page 1-32
- [30] UL short circuit current rating depends on lowest interrupting rating of circuit breaker installed.
- [31] Will not accept QO-EPD or Qwik-Gard™ QO-GFI or QO-AFI circuit breakers.
- [32] Mains rated 25 A when Al wire is used.
- [33] Order F for flush device or S for surface device.
- [34] Use 10 AWG maximum size wire for GFI and AFI circuit breakers.
- [35] 70 A Max. branch circuit breaker and 100 A max. back fed main circuit breaker.
- [36] CU indicates copper bus.
- [37] Copper bus.
- [38] Factory-included.
- [39] See Table 1.74 Knockout Information, page 1-32
- [40] Mains rating 25 A when Al wire is used.
- [41] Will not accept Qwik-Gard™ QO-GFI or QO-AFI circuit breaker.
- [42] Use 10 AWG maximum size wire for GFI and AFI circuit breakers.
- [43] Main circuit breaker is a field-installed standard QO single pole circuit breaker. Order separately from page 1-2, page 1-3.
- [44] 70 A max. branch circuit breaker and 70 A max. back fed main circuit breaker.
- [45] Interior only, order box separately.
- [46] PK27GTA includes a 6–2/0 AWG Al/Cu lug.
- [47] PE1A Discount Schedule.
- [48] UL Listed 5000 A short circuit current rating for corner grounded Delta systems. Use QO-H circuit breakers only.

**QO Standard Load Center Main Lugs, Fixed Mains  
(1Ø3W—120/240 Vac Rainproof—UL Listed)**

**Table 1.31: Fixed Main Lugs Rainproof Load Centers (Accepts Only QO Plug-on Circuit Breakers - Not compatible with QO Plug-on Neutral Circuit Breakers)**

	Mains Rating	Spaces	Max. Single Pole Circuits [49]	Max. Tandem Circuit Breakers	Load Center Box and Interior	Main Wire Size AWG/kcmil		Equipment Ground Bar Kit (Order Separately)	Box No. [50]
						Al	Cu		
RA I N P R O O F	<b>Non-Metallic Enclosure</b> Fixed Mains—Factory-installed Main Lugs—10 kA Short Circuit Current Rating								
	60 A	2	4	2	QO24L60NRNM	14-4	14-4	Factory-installed	1NM
	<b>Metallic Enclosure</b> Fixed Mains—Factory-installed Main Lugs—10 kA Short Circuit Current Rating								
	40 A	2	2	0	QO2L40RB [51]	12-6	14-6	PK3GTA1	1R
	70 A	2	4	2	QO24L70RB [51]	12-3	14-4	PK4GTA	1R
	100 A	6	12	6	QO612L100RB[52]	8-1		PK7GTA	2R
		6	12	6	QO612L100TRB[52]			Factory-installed	2R
		8	16	8	QO816L100RB [52]			PK7GTA	2R
		6	12	6	QO612L100RBCU[52] [53]			PK7GTA	2R
		8	16	8	QO816L100RBCU[52] [53]			PK7GTA	2R
		125 A	4	8	4			QO148L125GRB [53]	12-2/0

**Standard Load Center Main Breaker, Convertible Mains  
(1Ø3W—120/240 Vac Rainproof—UL Listed)**

**Table 1.32: Convertible Main Breaker Load Centers (Accepts Only QO Plug-on Circuit Breakers - Not compatible with QO Plug-on Neutral Circuit Breakers)**

	Mains Rating	Spaces	Max. Single Pole Circuits [49]	Max. Tandem Circuit Breakers	Load Center Box and Interior	Al	Cu	Equipment Ground Bar Kit (Order Separately)	Box No. [50]
RA I N P R O O F	125 A	6	12	6	QO1612M125FTRB [56]	4-2/0		PK12GTA	3R
	150 A	8	16	8	QO1816M150FTRB [56]	4-250		PK15GTAL	4R
	200 A	8	16	8	QO1816M200FTRB [56]	4-250		PK15GTAL	4R

Above listings through 200 A mains rating meet Federal Specification W-P-115C as Type 1, Class 2.

[49] Maximum single pole branch circuits utilizing QO and/or QOT circuit breakers.

[50] See page 1-34 or Indoor Enclosure Dimensions and Knockout Information, page 1-32

[51] Use 10 AWG maximum size wire for GFI and AFI circuit breakers.

[52] 70 A Max. branch circuit breaker and 70 A max. back fed main circuit breaker.

[53] Copper bus.

[54] Side hinge door device; allow 1-1/4 in. on left side for door to open.

[55] 22 k AIR main circuit breaker UL Listed for use ahead of QO, QOT, QO-GFI, QO-AFI, QO-EPD and QOPL 10 k AIR branch circuit breakers to permit their application on systems up to 22 kA

[56] QO1612M125FTRB provided with QOM1 frame main circuit breaker. QO1816M150FTRB and QO1816M200FTRB provided with QOM2 frame main circuit breaker.

QO Riser Panels  
(1Ø3W—120/240 Vac Special Applications—UL Listed)

Table 1.33: Riser Panels for Offset Interior for Wide Gutter—30 A Maximum Branch Circuit Breaker on Left Side of Interior [57], [58]  
(Compatible with QO Plug-on Circuit Breakers and QO Plug-on Neutral Circuit Breakers)

	Mains Rating	Spaces	Max. Single Pole Circuits [59]	Max. Tandem Circuit Breakers	Load Center Box and Interior	Load Center Cover		Equipment Ground Bar Kit (Order Separately)	Main Wire Size AWG/kcmil		Box No. [60]	
						Flush	Mono-Flat		Al	Cu		
I N D O R	Convertible Mains—Factory-Installed Main Lugs, 65 kA Short Circuit Current Rating Convertible to QOM1 22 kA Short Circuit Current Rating Main Circuit Breaker (See page ) when used with QOC cover below—Copper Bus											
	125 A	12	24	12	QO112L125PWW	QOC20UFWG [61]	NQC20FWGW [61]	PK15GTA	6-2/0		14	
		20	24	4	QO120L125PWW	QOC20UFWG [61]	NQC20FWGW [61]	PK15GTA			14	
	Convertible Mains—Factory—Installed Main Lugs, 65 kA Short Circuit Current Rating Convertible to QOM2 22 kA Short Circuit Current Rating Main Circuit Breaker (See page ) when used with QOC cover below—Copper Bus											
	200 A	30	40	10	QO130L200PWW	QOC30UFWG [61]	NQC30FWGW [61]	PK23GTA	4-250		23	
Convertible Mains—Factory-Installed Main Circuit Breaker, 22 kA Short Circuit Current Rating Convertible to Main Lugs (See page ) or Lower Amperage QOM2 Main Circuit Breaker (See page ) when used with QOC cover below—Copper Bus												
200 A	24	36	12	QO124M200PWW125 [62]	QOC30UFWG [61]	NQC30FWGW [61]	PK23GTA	4-250		23		

Above listings through 200 A mains rating meet Federal Specification W-P-115c as Type 1, Class 2.

Panelboard-style Covers for Riser Panels

Mono-Flat™ Front available for riser panels as an alternative to standard load center cover listed above. Provides a low-profile, aesthetically pleasing solution for high-traffic areas in upscale multi-family applications. Deadfront included. Lock kit not provided. Cover NQC30FWG CANNOT be used when panel has been converted to a main circuit breaker panel. [63]

Mains Rating of Load Center	Cat. No.
125 A	NQC20FWG
200 A	NQC30FWG

Table 1.34: Auxiliary Gutter

Cat. No.	Cover	Conduit Riser Size	Width	Height	Depth
UL Listed for use with standard 1Ø and 3Ø load centers for riser applications [64]. For auxiliary gutter-load center compatibility, see catalog number 1100CT0501					
SDAG26	Flush	1-3/4, 2, 2-1/2 or [65] 3	13.50	26.12	3.75

Table 1.35: Tap Kits for Use with Auxiliary Gutter

Cat. No.	Use with Auxiliary Gutter Cat. No.	Riser Wire		Tap Off Wire	
		Lug Type	Al/Cu Wire Size	Lug Type	Al/Cu Wire Size
SDGT30020	SDAG26	Mechanical (Included)	(2) 6 AWG—300 kcmil	Mechanical (Included)	(1) 6—2/0 AWG
SDGT300300	SDAG26	Mechanical (Included)	(2) 6 AWG—300 kcmil	Mechanical (Included)	(1) 6 AWG—300 kcmil
SDGT300C10C	SDAG26	Anderson VCEL030516H1 (Not included)	(2) 4 AWG—300 kcmil	Anderson VCEL02114S1 (Not Included)	(1) 8—1/0 AWG
SDGT300C300C	SDAG26	Anderson VCEL030516H1 (Not included)	(2) 4 AWG—300 kcmil	Anderson VCEL030516H1 (Not included)	(1) 4 AWG—300 kcmil
QOGL20 Grounding Terminals	SDAG26	Mechanical (Included)	(2) 6—2/0 AWG	—	—

[57] UL short circuit current rating depends on lowest interrupting rating of circuit breaker installed.  
 [58] UL Listed 5000 A short circuit current rating for corner grounded Delta systems. Use QO-H circuit breakers only.  
 [59] Maximum single pole branch circuits utilizing QO and/or QOT circuit breakers.  
 [60] See page 1-32  
 [61] Available in gray and white. For white equivalencies, add the "W" suffix to the reference, or see page 1-28.  
 [62] Comes with 125 A main circuit breaker factory installed.  
 [63] Order catalog number PK4FL for field-installed lock kit.  
 [64] One tap kit required for each riser wire.  
 [65] When used with B300 bolt-on hubs.

**QO Standard Load Center Main Lugs and Main Breaker  
(3Ø4W—208Y/120 Vac, 3Ø4W—240/120 Vac Delta  
and 3Ø3W—240 Vac Delta—Indoor and Rainproof—UL Listed)**

**Table 1.36: Main Lugs and Main Breaker Load Centers (Accepts Only QO Plug-on Circuit Breakers - Not compatible with QO Plug-on Neutral Circuit Breakers)**

	Mains Rating	Max. Number of 1P QO circuit breakers	Load Center Box and Interior	Indoor Cover with Door (Order Separately)		Main Wire Size AWG/kcmil		Equipment Ground Bar Kit (Order Separately)	Box No. [66]
			Cat. No.	Flush	Surface	Al	Cu		
INDOOR	<b>Fixed Mains—Factory-installed Main Lugs—Copper Bus—65 kA Short Circuit Current Rating [67]</b>								
	60 A	3	QO403L60NF/S	Cover Included With Load Center (No Door)		—	10–6	PK4GTA	13
	125 A	12	QO312L125G [68]	QOC16UF	QOC16US	6–2/0	6–2/0	Factory-incl. [69]	6
		20	QO320L125G [68]	QOC24UF	QOC24US			Factory-incl. [69]	7
		24	QO324L125G [68]	QOC24UF	QOC24US			Factory-incl. [69]	7
	200 A	18	QO318L200G [68]	QOC30UF	QOC30US	6–250	6–250	Factory-incl. [70]	9
		30	QO330L200G [68]	QOC30UF	QOC30US			Factory-incl. [70]	9
	225 A	42	QO342L225G [68]	QOC42UF	QOC42US	6–300	6–300	Factory-incl. [70]	11
	<b>Convertible Mains—Factory-installed QDL Main Circuit Breaker—Copper Bus—25 kA Short Circuit Current Rating [71]</b>								
	100 A	27	QO327M100 [72]	QOC30UF	QOC30US	4–2/0	4–2/0	PK15GTA	9
	125 A	30	QO330MQ125 [73] [68]	QOC342MQF	QOC342MQS	4–300	4–300	PK18GTA	12
		30	QO330MQ150 [73] [68]	QOC342MQF	QOC342MQS			PK18GTA	12
	150 A	42	QO342MQ150 [73] [68]	QOC342MQF	QOC342MQS	4–300	4–300	PK23GTA	12
		30	QO330MQ200 [73] [68]	QOC342MQF	QOC342MQS			PK18GTA	12
	200 A	42	QO342MQ200 [73] [68]	QOC342MQF	QOC342MQS	4–300	4–300	PK23GTA	12
		42	QO342MQ225 [73] [68]	QOC342MQF	QOC342MQS			PK23GTA	12
RAINPROOF	<b>Fixed Mains—Factory-installed Main Lugs—Copper Bus—65 kA Short Circuit Current Rating [67] [74]</b>								
	60 A	3	QO403L60NRB	Cover Included		—	10–6	PK4GTA	10R
	125 A	12	QO312L125GRB			Factory Incl. [69]	3R		
		20	QO320L125GRB			Factory Incl. [69]	4R		
	200 A	18	QO318L200GRB			Factory Incl. [70]	6R		
		30	QO330L200GRB			Factory Incl. [70]	6R		
	225 A	42	QO342L225GRB	Factory Incl. [70]	8R				
	<b>Convertible Mains—Factory-installed QDL Main Circuit Breaker—Copper Bus—25 kA Short Circuit Current Rating [71] [74]</b>								
	100 A	27	QO327M100RB [72]	Cover Included		4–2/0	4–2/0	PK15GTA	6R
	125 A	30	QO330MQ125RB [73]			4–300	4–300	PK18GTA	14R
	150 A	30	QO330MQ150RB [73]			4–300	4–300	PK18GTA	14R
	200 A	30	QO330MQ200RB [73]			4–300	4–300	PK18GTA	14R
		42	QO342MQ200RB [73]			4–300	4–300	PK23GTA	14R
	225 A	42	QO342MQ225RB [73]			4–300	4–300	PK23GTA	14R

Above listings through 200 A mains rating meet Federal Specification W-P-115C as Type 1, Class 2.

**Table 1.37: 3Ø, Main Circuit Breakers**

Amperage	25 k AIR	65 k AIR	100 k AIR [75]
<b>Field-installed alternate main circuit breakers for QO 3Ø main circuit breaker load centers rated 70–225 A. Do not exceed the load center main rating.</b>			
70 A	QDL32070	QGL32070	QJL32070
80 A	QDL32080	QGL32080	QJL32080
90 A	QDL32090	QGL32090	QJL32090
100 A	QDL32100	QGL32100	QJL32100
110 A	QDL32110	QGL32110	QJL32110
125 A	QDL32125	QGL32125	QJL32125
150 A	QDL32150	QGL32150	QJL32150
175 A	QDL32175	QGL32175	QJL32175
200 A	QDL32200	QGL32200	QJL32200
225 A	QDL32225	QGL32225	QJL32225

**Table 1.38: 3Ø, Main Lugs Kits**

Main Lugs Amperage Rating	Cat. No.	Lug Wire Size AWG/kcmil
<b>Field-installed main lugs for convertible 3Ø main circuit breaker load centers</b>		
125 A	QOL3125	6–2/0 Cu/Al
225 A	QOL3225	6–300 Cu/Al



QO330MQ200



QO312L125G

[66] See page 1-32

[67] UL short circuit current rating depends on lowest interrupting rating of circuit breaker installed.

[68] For Certification to IEC 60439-1 contact the local Square D sales office; otherwise panels are NOT CE marked. (For use on 415Y/240 Vac 3-phase 4-wire, 3,000 Short Circuit Current Rating when QOXD...branch circuit breakers are used and 10,000 Short Circuit Current Rating when QO...VS branch circuit breakers are used).

[69] PK15GTA.

[70] PK23GTA and LK100AN.

[71] 25 kA short circuit current rating SCCR maximum with Square D Type QDL main circuit breaker, or 22 kA SCCR maximum with back-fed Type QO-VH main circuit breaker, feeding QO 10 k AIR branch circuit breakers.

[72] Includes factory-installed back fed QO3100VH main circuit breaker.

[73] 65 kA Short Circuit Current Rating maximum with field-installed Square D type QGL 65 k AIR minimum main circuit breaker feeding QO and Q1 10 k AIR minimum branch circuit breakers.

[74] Side hinge door device allow 1-1/4 in. on left side for door to open.

[75] When these 3P circuit breakers are used as the main circuit breaker of a 3Ø load center, the maximum AIR rating is 65 kA at 240 Vac and 100 kA at 208 Vac.

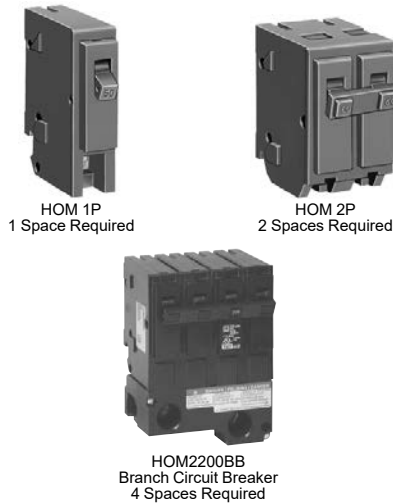

**Homeline Standard Plug-On Circuit Breakers**

The Square D Homeline circuit breakers are in a 1 in. wide format for 1-pole circuit breakers. They are designed to plug into Homeline load centers.

**Table 1.39: Standard HOM Plug-on Circuit Breakers**

Ampere Rating	AIR	1P—120 Vac, 1 Space Required	2P—120/240 Vac Common Trip 2 Spaces Required.
15 A	10 kA	HOM115 [1][2]	HOM215 [2]
20 A	10 kA	HOM120 [1][2]	HOM220 [2]
25 A	10 kA	HOM125 [2]	HOM225 [2]
30 A	10 kA	HOM130 [2]	HOM230 [2]
35 A	10 kA	—	HOM235 [2]
40 A	10 kA	HOM140 [2]	HOM240 [2]
45 A	10 kA	—	HOM245 [2]
50 A	10 kA	HOM150 [2]	HOM250 [2]
60 A	10 kA	—	HOM260 [2]
70 A	10 kA	—	HOM270 [2]
80 A	10 kA	—	HOM280 [2]
90 A	10 kA	—	HOM290 [2]
100 A	10 kA	—	HOM2100 [2]
110 A	10 kA	—	HOM2110 [2]
125 A	10 kA	—	HOM2125 [2]
150 A	10 kA	—	HOM2150BB [2][3]
175 A	10 kA	—	HOM2175BB [2][3]
200 A	10 kA	—	HOM2200BB [2][3]

**Homeline High Magnetic Circuit Breakers (HOM-HM)**

High magnetic trip circuit breakers are recommended for applications where high initial inrush current may occur.

**Table 1.40: HOM-HM Circuit Breakers**

Amperes	1P—120/240 Vac	2Ps
15 A	HOM115HM OBS	—
20 A	HOM120HM [2]	—

OBS This product is obsolete.

**Homeline Ground-Fault Circuit Breaker (HOM-GFI)**

HOM-GFI circuit breakers provide overload and short circuit protection, combined with Class A ground fault protection. Class A denotes a ground fault circuit interrupter that will trip when a fault current to ground is 6 milliamperes or more.

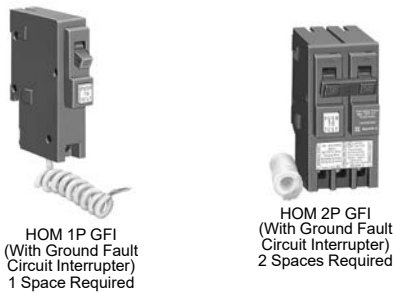

**Table 1.41: HOM-GFI Circuit Breakers**

Circuit Breaker Type	Ampere Rating	AIR	1P—120 Vac 1 Space Required	2P—120/240 Vac Common Trip 2 Spaces Required
Ground-Fault Circuit Interrupter (Pigtail Neutral)	15 A	10 kA	HOM115GFI	HOM215GFI
	20 A	10 kA	HOM120GFI	HOM220GFI
	25 A	10 kA	—	HOM225GFI
	30 A	10 kA	—	HOM230GFI
	35 A	10 kA	—	HOM235GFI
	40 A	10 kA	—	HOM240GFI
	45 A	10 kA	—	HOM245GFI
Plug-On Neutral Ground- Fault Circuit Interrupter	15 A	10 kA	HOM115PGFI[4]	—
	20 A	10 kA	HOM120PGFI[4]	—

**Homeline Combination Arc Fault Circuit Interrupters (HOM-CAFI)**

Homeline Combination Arc Fault Circuit Interrupters—Provide overload and short circuit protection, plus arc fault protection in accordance with the NEC and UL 1699.



**Table 1.42: HOM-CAFI Circuit Breakers**

Circuit Breaker Type	Ampere Rating	Poles 120 Vac	Cat. No.
<b>One-Pole</b>			
Combination Arc-Fault Circuit Interrupter with Pigtail Neutral	15 A	1	HOM115CAFI [2]
	20 A	1	HOM120CAFI [2]
Plug-On Neutral Combination Arc-Fault Interrupter	15 A	1	HOM115PCAFI [2]
	20 A	1	HOM120PCAFI [2]
<b>Two-Pole</b>			
Combination Arc-Fault Circuit Interrupter with Pigtail Neutral	15 A	2	HOM215CAFI [2] [5]
	20 A	2	HOM220CAFI [2] [5]

[1] UL Listed as SWD (switching duty) rated. Suitable for switching 120 Vac fluorescent lighting loads.

[2] UL Listed as HACR type for use with air conditioning, heating and refrigeration equipment having motor group combinations and marked for use with HACR type circuit breakers.

[3] Requires four spaces (1 AWG–300 kcmil Al/Cu). Use only in 1Ø panel rated 150 A or greater.

[4] New Plug-on Neutral

[5] For 120/240 V only, not for 208Y/120 V.



HOM 1P DF  
Plug-on Neutral



HOM 1P DF  
Pigtail

### Homeline Dual Function Circuit Breaker (HOM-DF)

Homeline Combination Arc Fault and Ground Fault Circuit Interrupters (Dual Function)—Provide overload and short circuit protection, plus arc fault and ground fault protection in a single device in accordance with the NEC, UL1699 and UL943.

Table 1.43: HOM-DF Circuit Breakers

Circuit Breaker Type	Ampere Rating	Poles 120 Vac	Cat. No.
Combination Arc-Fault and Ground Fault Circuit Interrupter with Pigtail Neutral	15 A	1	HOM115DF [6]
	20 A	1	HOM120DF [6]
Plug-On Neutral Combination Arc-Fault and Ground Fault Circuit Interrupter	15 A	1	HOM115PDF [6]
	20 A	1	HOM120PDF [6]

### Homeline Equipment Protection Device (HOM-EPD)

Homeline Equipment Protection Device—Circuit Breakers with 30 mA Equipment Ground Fault Protection (UL Listed).

Table 1.44: HOM-EPD Circuit Breakers

Amperes	1P—120 Vac	2P—120/240 Vac Common Trip
15 A	HOM115EPD	HOM215EPD <sup>OBS</sup>
20 A	HOM120EPD	HOM220EPD
25 A	—	HOM225EPD
30 A	—	HOM230EPD
40 A	—	HOM240EPD
50 A	—	HOM250EPD

<sup>OBS</sup> This product is obsolete.

### Homeline Tandem and Quad Tandem Circuit Breakers (HOMT)

Table 1.45: HOMT Tandem Circuit Breakers

Ampere Rating [7]	AIR	1P Tandem—120/240 Vac (One Space Required)
15 and 15 A	10 kA	HOMT1515 [6]
15 and 20 A	10 kA	HOMT1520 [6]
20 and 20 A	10 kA	HOMT2020 [6]
30 and 15 A	10 kA	HOMT3015 [6]
30 and 20 A	10 kA	HOMT3020 [6]

Table 1.46: HOMT Quad Tandem 1P Circuit Breakers

Ampere Rating [7]		AIR	2P Tandem—120/240 Vac (Two Spaces Required)
1P	2P		
(2) 15 A	15 A	10 kA	HOMT1515215
(2) 15 A	20 A	10 kA	HOMT1515220
(2) 15 A	25 A	10 kA	HOMT1515225 <sup>OBS</sup>
(2) 15 A	30 A	10 kA	HOMT1515230
(2) 15 A	40 A	10 kA	HOMT1515240
(2) 15 A	50 A	10 kA	HOMT1515250
(2) 20 A	20 A	10 kA	HOMT2020220
(2) 20 A	25 A	10 kA	HOMT2020225
(2) 20 A	30 A	10 kA	HOMT2020230
(2) 20 A	40 A	10 kA	HOMT2020240
(2) 20 A	50 A	10 kA	HOMT2020250

<sup>OBS</sup> This product is obsolete.

**NOTE:** Typical catalog no. (e.g. HOMT 1515230) represents two 1P, outer poles (two 15 A 1P CBs) and one 2P inner circuit breaker with common trip (one 30 A 2P CB).

Table 1.47: HOMT Quad Tandem 2P Circuit Breakers

Ampere Rating [7]		AIR	(2) 2P Tandem—120/240 Vac (Two Spaces Required)
2P	2P		
15 A	15 A	10 kA	HOMT215215
15 A	20 A	10 kA	HOMT215220
15 A	25 A	10 kA	HOMT215225
15 A	30 A	10 kA	HOMT215230
15 A	40 A	10 kA	HOMT215240
15 A	50 A	10 kA	HOMT215250
20 A	20 A	10 kA	HOMT220220
20 A	25 A	10 kA	HOMT220225
20 A	30 A	10 kA	HOMT220230
20 A	40 A	10 kA	HOMT220240
20 A	50 A	10 kA	HOMT220250
25 A	25 A	10 kA	HOMT225225
25 A	30 A	10 kA	HOMT225230
25 A	40 A	10 kA	HOMT225240
25 A	50 A	10 kA	HOMT225250
30 A	30 A	10 kA	HOMT230230
30 A	40 A	10 kA	HOMT230240
30 A	50 A	10 kA	HOMT230250

**NOTE:** Typical catalog no. (i.e. HOMT215230) represents two 2P; outer poles (one 15 A 2P with common trip) and inner poles (one 30 A 2P with common trip).



HOMT Quad  
Circuit Breaker  
2 Spaces Required

[6] UL Listed as HACR type for use with air conditioning, heating and refrigeration equipment having motor group combinations and marked for use with HACR type circuit breakers.  
 [7] 15–20 A tandem or quad tandem circuit breakers are suitable for use with 60°C or 75°C conductors. 25–50 A tandem or quad tandem circuit breakers are suitable for use with 75°C conductors only.



**Homeline Circuit Breaker Wire Sizes**

**Table 1.48: Wire Sizes for Homeline Circuit Breakers**

Breaker Type	Ampere Rating	Wire Size (AWG/kcmil) [8]	
		Aluminum	Copper
HOM 1P	15–30 A	14–8 AWG	14–8 AWG or (2) 14–10 AWG
	40–50 A	8–2 AWG	8–2 AWG
HOM 2P	15–30 A	14–8 AWG	14–8 AWG or (2) 14–10 AWG
	35–70 A	8–2 AWG	8–2 AWG
	80–125 A	4–2/0 AWG	4–2/0 AWG
	150–200 A	4 AWG–300 kcmil	4 AWG–300 kcmil
HOMT and Quad	15–30 A	14–8 AWG	14–8 AWG
Quad Only	40–50 A	6–12 AWG	6–14 AWG
HOM-GFI - 1P	15–20 A	14–10 AWG	14–10 AWG
HOM-GFI - 2P	15–50 A	12–4 AWG	14–6 AWG

**Accessories for Homeline Circuit Breakers**

**Table 1.49: Accessories for Use with Homeline Circuit Breakers**

Description	Cat. No.	
<b>Handle Attachments</b>		
Handle Tie: Converts any two adjacent 120/240 Vac single HOM circuit breakers to independent trip 2P	HOM1HT	
Handle Tie: Converts any two adjacent 120/240 Vac 1P side-by-side HOMT circuit breakers to independent trip 2P	HOMTHT	
Handle Clamp: Clamp for holding HOM 1P handle in the ON or OFF position	QO1LO	
Handle Blocking Device: Attaches to standard HOM 2P circuit breakers for holding the handle in the OFF position	HOM2HBD	
Handle Padlock Attachment: For padlocking 1P Standard HOM breakers in the ON or OFF position	HOM1PA	
Handle Padlock Attachment: For padlocking 2P Standard HOM circuit breakers in ON or OFF position	15–70 A	HOM2PALA
	80–125 A	HOM2PAHA
	150–200 A	HOM2PAVHA
Handle Padlock Attachment: For padlocking 1P CAFI, DF, GFI, and EPD HOM breakers in ON or OFF position	HOMELEC1PA	
Handle Padlock Attachment: For padlocking 2P CAFI, GFI, and EPD HOM breakers in ON or OFF position	HOMELEC2PALA	
Handle Padlock Attachment: For padlocking center poles of Homeline Quad breakers in the OFF position	HOMQPA	
Handle Padlock Attachment: For padlocking main circuit breakers in convertible load center in OFF position	50–125 A	QOM1PA [9]
	100–225 A	QOM2PA [9]
<b>Sub-Feed Lugs</b>		
125 A 2P plug-on—2 spaces required	HOML2125	
225 A 2P plug-on—4 spaces required	HOML2225 [10]	

[8] 15–30 A circuit breakers are suitable for use with 60°C or 75°C conductors. 40–125 A circuit breakers are suitable for use with 75°C conductors.

[9] 50–125 A QOM1 frame size; 100–225 A QOM2 frame size.

[10] Requires four spaces (1 AWG–300 kcmil Al/Cu). Use only in 1Ø panel rated 150 A or greater.

**HOM Standard Load Center Main Lugs, Fixed Mains  
(1Ø3W—120/240 Vac Indoor—UL Listed)**

**Table 1.50: Fixed Main Lugs Load Centers (Accepts Only HOM Plug-on Circuit Breakers - Not compatible with HOM Plug-on Neutral Circuit Breakers)**

	Mains Rating	Spaces	Max. Single Pole Circuits [1]	Max. Tandem Circuit Breakers	Load Center Box, Interior and Cover [2]	Main Wire Size AWG/kcmil		Equipment Ground Bar Kit (Order Separately)	Box No. [3]	
						Al	Cu			
INDOOR	<b>Main Lugs—10 kA Short Circuit Current Rating Order HOM Circuit Breakers (See page 1-19) Factory-installed Fixed Main Lugs</b>									
	70 A	2	4	2	HOM24L70F/S [4] [5]	12-3	14-4	PK3GTA1	2	
	100 A	6	12	6	HOM612L100F/S [4] [6]	8-1		PK7GTA	4	
	125 A	4	8	4	HOM48L125GC	12-2/0	14-2/0	PK7GTA Included	21	

**HOM Plug-on Neutral Load Center Main Lugs, Convertible Mains  
(1Ø3W—120/240 Vac Indoor—UL Listed)**

**Table 1.51: Convertible Main Lugs Plug-on Neutral Load Centers (Compatible with HOM Plug-on Circuit Breakers and HOM Plug-on Neutral Circuit Breakers)**

	Mains Rating	Spaces	Max. Single Pole Circuits [1]	Max. Tandem Circuit Breakers	Load Center Box, Interior and Cover [2]	Main Wire Size AWG/kcmil		Equipment Ground Bar Kit (Order Separately)	Box No. [3]	
						Al	Cu			
INDOOR	<b>Convertible Mains—Factory-installed Main Lugs</b>									
	<b>QOM1 Main Frame Size—Convertible to Main Circuit Breaker (See page 1-25)</b>									
	125 A	8	16	8	HOM816L125PC	6-2/0	6-1	PK9GTA	6	
		12	24	12	HOM1224L125PC		6-1	PK15GTA	6	
		16	32	16	HOM1632L125PC		6-1/0	PK15GTA	8	
		20	40	20	HOM2040L125PC		6-1/0	PK18GTA	8	
		30	60	30	HOM3060L125PC		6-2/0	PK23GTA	10	
	<b>Convertible Mains—Factory-installed Main Lugs</b>									
	<b>QOM2 Main Frame Size—Convertible to Main Circuit Breaker (See page 1-25)</b>									
	225 A	30	60	30	HOM3060L225PC	4-300	4-250	PK23GTA	10	
		40	80	40	HOM4080L225PC			PK27GTA	12	
		42	84	42	HOM4284L225PC			PK27GTA	12	
		60	120	60	HOM60120L225PC			PK27GTA	25	
		<b>Convertible Mains—Factory-installed Main Lugs—Ground Bar Included</b>								
	<b>QOM1 Main Frame Size—Convertible to Main Circuit Breaker (See page 1-25)</b>									
125 A	8	16	8	HOM816L125PGC	6-2/0	6-1	PKG TALP1 Included	6		
	12	24	12	HOM1224L125PGC		6-1	PKG TALP1 Included	6		
	20	40	20	HOM2040L125PGC		6-1/0	PKG TALP1 Included	8		
	24	48	24	HOM2448L125PGC		6-1/0	PKG TALP2 Included	8		
<b>Convertible Mains—Factory-installed Main Lugs—Ground Bar Included</b>										
<b>QOM2 Main Frame Size—Convertible to Main Circuit Breaker (See page 1-25)</b>										
225 A	30	60	30	HOM3060L225PGC	4-300	4-250	PKG TALP2 Included	10		
	16	32	16	HOM1632L225PGC			PKG TALP1 Included	9		
	20	40	20	HOM2040L225PGC			PKG TALP1 Included	9		
	40	80	40	HOM4080L225PGC			PKG TALP3 Included	12		
	42	84	42	HOM4284L225PGC			PKG TALP3 Included	12		

Above listings through 200 A mains rating meet Federal Specification W-P-115c as Type 1, Class 2.

**Field-Installed Main Circuit Breaker Kits, 1Ø**

**Table 1.52: QOM1 Frame Size—Use with Convertible Main Load Centers Only**



QOM1 Frame Size  
50-125 Amperes

Main Circuit Breaker Rating [7]	Convertible Load Center Mains Rating	22 k AIR [8]		Lug Wire Size [9] AWG/kcmil
		Main Circuit Breaker		
50 A	100-125	QOM50VH		12-2/0 Al or Cu
60 A	100-125	QOM60VH		
70 A	100-125	QOM70VH		
80 A	100-125	QOM80VH		
90 A	100-125	QOM90VH		
100 A	100-125	QOM100VH		
110 A	125	QOM110VH		
125 A	125	QOM125VH		

[1] Maximum single pole branch circuits utilizing HOM and/or HOMT circuit breakers.

[2] C at end of catalog number indicates combination flush/surface cover included with device.

[3] See page 1-32

[4] F/S at end of catalog number indicates to order F for flush device or S for surface device. The cover does not have a door.

[5] HOM-GFI and HOM-AFI branch circuit breakers are limited to number 10 maximum wire.

[6] 70 A maximum branch circuit breaker, 100 A maximum back feed main circuit breaker.

[7] Do not exceed the load center mains rating.

[8] 22 k AIR main circuit breaker UL Listed for use ahead of QO, QOT and QO-PL 10 k AIR branch circuit breakers to permit their application on systems with up to 22 kA available fault current.

[9] Wire range listed for QOM circuit breaker kits is the wire range of that circuit breaker. To find out maximum wire size permitted in a particular load center per UL, see Main Wire Size in that load center table.



QOM2 Frame Size  
100–225 Amperes

**Table 1.53: QOM2 Frame Size—Use with Convertible Main Load Centers Only**

Main Circuit Breaker Rating [10]	Convertible Load Center Mains Rating	22 k AIR [11]	Lug Wire Size [12] AWG/kcmil
		Main Circuit Breaker [13]	
100 A	150–225	QOM2100VH	4–300 Al or Cu
125 A	150–225	QOM2125VH	
150 A	150–225	QOM2150VH	
175 A	200–225	QOM2175VH	
200 A	200–225	QOM2200VH	
225 A	225	QOM2225VH	

**HOM Plug-on Neutral Load Center Main Breaker, Convertible Mains (1Ø3W—120/240 Vac Indoor—UL Listed)**

**Table 1.54: Convertible Main Breaker Plug-on Neutral Load Centers (Compatible with HOM Plug-on Circuit Breakers and HOM Plug-on Neutral Circuit Breakers)**

	Mains Rating	Spaces	Max. Single Pole Circuits [14]	Max. Tandem Circuit Breakers	Load Center Box, Interior and Cover [15]	Main Wire Size AWG/kcmil		Equipment Ground Bar Kit (Order Separately)	Box No. [16]	
						Al	Cu			
INDOOR	<b>Main Circuit Breaker—22 kA Short Circuit Current Rating</b>									
	<b>Convertible Mains—Factory-installed Main Circuit Breaker</b>									
	<b>QOM1 Main Frame Size—Convertible to Main Lugs or Lower Amperage Main Circuit Breaker (See page 1-25)</b>									
	100 A	8	16	8	HOM816M100PC	6–1		PK9GTA	5	
		12	24	12	HOM1224M100PC	6–2/0		PK15GTA	6	
		20	40	20	HOM2040M100PC	6–1		PK18GTA	7	
		24	48	24	HOM2448M100PC	6–2/0		PK23GTA	8	
		30	60	30	HOM3060M100PC	6–2/0		PK23GTA	10	
	125 A	24	48	24	HOM2448M125PC	6–2/0	6–1/0	PK23GTA	8	
		30	60	30	HOM3060M125PC			PK23GTA	10	
		<b>Convertible Mains—Factory-installed Main Circuit Breaker</b>								
	<b>QOM2 Main Frame Size—Convertible to Main Lugs or Lower Amperage Main Circuit Breaker (See page 1-25)</b>									
	150 A	30	60	30	HOM3060M150PC	4–250		PK23GTA	10	
		20	40	20	HOM2040M200PC			PK18GTA	9	
		30	60	30	HOM3060M200PC			PK23GTA	10	
		40	80	40	HOM4080M200PC			PK27GTA	12	
		42	84	42	HOM4284M200PC			PK27GTA	12	
	200 A	60	120	60	HOM60120M200PC	4–250		PK27GTA	25	
		42	84	42	HOM4284M225PC			PK27GTA	12	
	225 A	42	84	42	HOM4284M225PC	4–300	4–250	PK27GTA	12	
<b>Split Bus Plug-on Neutral Load Center—Manual Transfer for use with Temporary Backup Power Source Applications NEMA 1 (indoor)</b>										
200 A	36	72	36	HOM1428X2244M200PC	4–250		PK27GTA	12		

Above listings through 200 A mains rating meet Federal Specification W-P-115c as Type 1, Class 2.

[10] Do not exceed the load center mains rating.  
 [11] 22 k AIR main circuit breaker UL Listed for use ahead of QO, QOT and QO-PL 10 k AIR branch circuit breakers to permit their application on systems with up to 22 kA available fault current.  
 [12] Wire range listed for QOM circuit breaker kits is the wire range of that circuit breaker. To find out maximum wire size permitted in a particular load center per UL, see Main Wire Size in that load center table.  
 [13] Add suffix 1021 for 120, 208 or 240 Vac shunt trip.  
 [14] Maximum single pole branch circuits utilizing HOM and/or HOMT circuit breakers.  
 [15] C at end of catalog number indicates combination flush/surface cover included with device.  
 [16] See page 1-32

1Ø, Field-Installed Mains Kits

Table 1.55: 1Ø Field Installed Main Lug Kits – Use with Convertible Main Load Centers Only



Field-Installed Main Type	Frame Size	Main [17] Ampere Rating	Use on Convertible Load Center with Mains Rating	Cat. No.	Lug Wire Size [18] AWG/kcmil
Main Lugs [19]	—	125 A	100–125 A	QOL125	6–2/0 Al or Cu
		125 A	100–125 A	QOL125VD	6–4/0 Al or Cu
		225 A	150–225 A	QOL225	6–300 Al or Cu
Main Circuit Breaker [20]	QOM1	50 A	100–125 A	QOM50VH	12–2/0 Al or Cu
		60 A	100–125 A	QOM60VH	
		70 A	100–125 A	QOM70VH	
		80 A	100–125 A	QOM80VH	
		90 A	100–125 A	QOM90VH	
		100 A	100–125 A	QOM100VH	
		110 A	125 A	QOM110VH	
	QOM2 [21]	125 A	125 A	QOM125VH	4–300 Al or Cu
		100 A	150–225 A	QOM2100VH	
		125 A	150–225 A	QOM2125VH	
		150 A	150–225 A	QOM2150VH	
		175 A	200–225 A	QOM2175VH	
		200 A	200–225 A	QOM2200VH	
		225 A	225 A	QOM2225VH	

HOM Plug-on Neutral Load Centers with Qwik-Grip (1Ø3W—120/240 Vac Indoor—UL Listed)

The Square D Homeline plug-on neutral load centers with Qwik-Grip simplify rough-in by eliminating the need to remove knockouts, install wire connectors, and blindly pull wire into the load center. A quick bend of the wire using the wire bend guide on the Qwik-Grip insert and the wire slides into the slot. Once inserted, the Qwik-Grip shield snaps on to keep the wire behind the router for a secure, code-compliant installation.



HOM Plug-on Neutral Load Center with Qwik-Grip

Table 1.56: Plug-on Neutral Load Centers with Qwik-Grip (Compatible with HOM Plug-on Circuit Breakers and HOM Plug-on Neutral Circuit Breakers)

Main Ratings	Spaces	Max. 1P Circuits	Max. Tandem Circuit Breakers	Load Center Box, Interior and Cover	Main Wire Size AWG/kcmil		Equipment Ground Bar Kit	Box No.
					Al	Cu		
125 A	24	48	24	HOM2448L125PQGC	6–2/0	6–1/0	PKGTALP2 Included	8Q
	30	60	30	HOM3060L125PQGC	6–2/0	6–2/0	PKGTALP2 Included	10Q
Convertible Mains—Factory-Installed Main Lugs, 10 kA Short Circuit Current Rating—QOM2 Main Frame Size, Convertible to Main Circuit Breaker								
225 A	30	60	30	HOM3060L225PQGC	4–250		PKGTALP2 Included	10Q
	40	80	40	HOM4080L225PQGC	4–250		PKGTALP3 Included	12Q
	42	84	42	HOM4284L225PQGC	4–250		PKGTALP3 Included	12Q
Convertible Mains—Factory-Installed Main Circuit Breaker, 22 kA Short Circuit Current Rating—QOM2 Main Circuit Breaker Frame Size, Convertible to Main Lugs or Main Circuit Breaker								
200 A	30	60	30	HOM3060M200PQC	4–250		PK23GTA (Order separately)	10Q
	40	80	40	HOM4080M200PQC	4–250		PK27GTA (Order separately)	12Q
	42	84	42	HOM4284M200PQC	4–250		PK27GTA (Order separately)	12Q

Homeline Service Upgrade Load Centers (1Ø3W—120/240 Vac Special Applications—UL Listed)

Table 1.57: Service Upgrade Load Centers with Removable End Walls (Compatible with HOM Plug-on Circuit Breakers and HOM Plug-on Neutral Circuit Breakers)

	Mains Rating	Spaces	Max. 1P Circuits [22]	Max. Tandem Circuit Breakers	Load Center Box and Interior	Extra Long Cover with Door (Order Separately)		Main Wire Size AWG / Kcmil		Equipment Ground Bar Kit (Order Separately)	Box No. [23]
						Flush	Surface	Al	Cu		
Convertible Mains—Factory-Installed Main Circuit Breaker—22KA QOM2 Main Frame Size—Convertible to Main Lugs or Lower Amperage Main Circuit Breaker (See page 1-19)—Copper Bus [24]											
INDOOR	200 A	30	60	30	HOM3060M200PCEP [25]	HOMC30UFL	—	4-250	Al	PK23GTA	10

[17] Do not exceed the load center mains rating.

[18] Wire range listed for main device kits is the wire range of that device. To find out maximum wire size permitted in a particular load center per UL, see tables in page 1-9 and page 1-26 under Main Wire Size.

[19] If main circuit breaker knockout has been removed from the load center's trim, order appropriate filler plate from page 1-27.

[20] 22 k AIR main circuit breaker UL Listed for use ahead of HOM and HOMET 10 k AIR branch circuit breakers to permit their application on systems with up to 22 kA available fault current.

[21] Add suffix 1021 for 120, 208, 240 Vac shunt trip.

[22] Maximum single pole branch circuits utilizing QO and/or QOT circuit breakers.

[23] See page 1-32

[24] 22 k AIR main circuit breaker UL Listed for use ahead of QO, QOT and QO-PL 10 k AIR branch circuit breakers to permit their application on systems with up to 22 kA available fault current.

[25] Ships with standard length cover.

**HOM Standard Load Center Main Lugs, Fixed Mains (1Ø3W—120/240 Vac Rainproof—UL Listed)**

**Table 1.58: Fixed Main Lugs Load Centers (Accepts Only HOM Plug-on Circuit Breakers - Not compatible with HOM Plug-on Neutral Circuit Breakers)**

	Mains Rating	Spaces	Max. Single Pole Circuits [26]	Max. Tandem Circuit Breakers	Load Center Box, Interior and Cover	Main Wire Size AWG/kcmil		Equipment Ground Bar Kit (Order Separately)	Box No. [27]	
					Cat. No. (DE3C)	Al	Cu	Cat. No. (DE3A)		
RA I N P R O O F	<b>Main Lugs—10 kA Short Circuit Current Rating</b> Factory-installed Fixed Main Lugs, 10 kA Short Circuit Current Rating									
	70 A	2	4	2	HOM24L70RB [28]	12–3	14–4	PK4GTA	1R	
	100 A	6	12	6	HOM612L100RB [29]	8–1		PK7GTA	2R	
	125 A	4	8	4	HOM48L125GRB	12–2/0	14–2/0	PK7GTA Included	15R	

Above listings through 200 A mains rating meet Federal Specification W-P-115c as Type 1, Class 2.

**HOM Plug-on Neutral Load Center Main Lugs, Convertible Mains (1Ø3W—120/240 Vac Rainproof—UL Listed)**

**Table 1.59: Convertible Main Lugs Plug-on Neutral Load Centers (Compatible with HOM Plug-on Circuit Breakers and HOM Plug-on Neutral Circuit Breakers)**

	Mains Rating	Spaces	Max. Single Pole Circuits [26]	Max. Tandem Circuit Breakers	Load Center Box, Interior and Cover	Main Wire Size AWG/kcmil		Equipment Ground Bar Kit (Order Separately)	Box No. [27]	
					Cat. No. (DE3C)	Al	Cu	Cat. No. (DE3A)		
RA I N P R O O F	<b>Convertible Mains with Factory-installed Main Lugs [30], QOM1 Main Frame Size—Convertible to Main Circuit Breaker (See Below)</b>									
	125 A	8	16	8	HOM816L125PRB	6–2/0	6–1	PK9GTA	3R	
		12	24	12	HOM1224L125PRB			PK15GTA	3R	
		20	40	20	HOM2040L125PRB			PK18GTA	4R	
		24	48	24	HOM2448L125PRB			PK23GTA	6R	
	<b>Convertible Mains with Factory-installed Main Lugs [30], QOM2 Main Frame Size—Convertible to Main Circuit Breaker (See Below)</b>									
	225 A	12	12	0	HOM12L225PRB	4–300	4–250	PK9GTA	5R	
		16	32	16	HOM1632L225PRB			PK15GTA	6R	
		20	40	20	HOM2040L225PRB			PK18GTA	6R	
		30	60	30	HOM3060L225PRB			PK23GTA	7R	
		40	80	40	HOM4080L225PRB			PK27GTA	14R	
		42	84	42	HOM4284L225PRB			PK27GTA	14R	

Above listings through 200 A mains rating meet Federal Specification W-P-115c as Type 1, Class 2.

**HOM Plug-on Neutral Load Center Main Breaker, Convertible Mains (1Ø3W—120/240 Vac Rainproof—UL Listed)**

**Table 1.60: Convertible Main Breaker Plug-on Neutral Load Centers (Compatible with HOM Plug-on Circuit Breakers and HOM Plug-on Neutral Circuit Breakers)**

	Mains Rating	Spaces	Max. Single Pole Circuits [26]	Max. Tandem Circuit Breakers	Load Center Box, Interior and Cover	Main Wire Size AWG/kcmil		Equipment Ground Bar Kit (Order Separately)	Box No. [27]	
					Cat. No. (DE3C)	Al	Cu	Cat. No. (DE3A)		
RA I N P R O O F	<b>Main Circuit Breaker—22 kA Short Circuit Current Rating</b> Convertible Mains with Factory-Installed Main Circuit Breaker, QOM1 Main Frame Size—Convertible to Main Lugs or Lower Amperage Main Circuit Breaker (See Below) [31]									
	100 A	8	16	8	HOM816M100PRB	6–2/0	6–1	PK9GTA	3R	
		12	24	12	HOM1224M100PRB			PK15GTA	3R	
		20	40	20	HOM2040M100PRB			PK18GTA	4R	
	125 A	8	16	8	HOM816M125PRB	6–2/0	6–1	PK9GTA	3R	
		24	48	24	HOM2448M125PRB			PK23GTA	6R	
	<b>Convertible Mains with Factory-installed Main Circuit Breaker, QOM2 Main Frame Size—Convertible to Main Lugs or Lower Amperage Main Circuit Breaker (See Below)</b>									
	200 A	150 A	30	60	30	HOM3060M150PRB	4–250		PK23GTA	7R
		200 A	12	12	0	HOM12M200PRB	4–250		PK9GTA	5R
			20	40	20	HOM2040M200PRB			PK18GTA	6R
			30	60	30	HOM3060M200PRB			PK23GTA	7R
			40	80	40	HOM4080M200PRB			PK27GTA	14R
	<b>Convertible Mains with Factory-installed Main Circuit Breaker with Feed-thru Lugs, QOM2 Main Frame Size—Convertible to Main Lugs or Lower Amperage Main Circuit Breaker (See Below) [30]</b>									
	150 A	8	16	8	HOM816M150PFTRB	4–250		PK15GTA	6R	
200 A	8	16	8	HOM816M200PFTRB	4–250		PK15GTA	6R		

Above listings through 200 A mains rating meet Federal Specification W-P-115c as Type 1, Class 2.

[26] Maximum single pole branch circuits utilizing HOM and/or HOMT circuit breakers.

[27] See page 1-34

[28] HOM-GFI and HOM-AFI branch circuit breakers are limited to number 10 maximum wire.

[29] 70 A maximum branch circuit breaker, 100 A maximum back feed main circuit breaker.

[30] Side hinge door device allow 1-1/4 in. on left side for door to open.

[31] 22 k AIR main circuit breaker UL Listed for use ahead of HOM and HOMT 10 k AIR branch circuit breakers to permit their application on systems with up to 22 kA available fault current.

Plug-on Neutral Indoor Load Center Value Packs

Table 1.61: Plug-on Neutral Indoor Load Center Value Packs (Compatible with Plug-on and Plug-on Neutral Circuit Breakers)

	Mains Rating	Spaces	Max. 1P Circuits [1]	Max. Tandem Circuit Breakers	Load Center Box, Interior, Cover and Branch Circuit Breakers		Equipment Ground Bar Kit (Order Separately)	Main Wire Size [AWG/kcmil] Al/Cu		Box No. [2]
					Cat. No.	Included Load Center/Circuit Breakers		Cat. No.		
INDOOR	QO (Accepts Only QO Plug-On Circuit Breakers) QO—Copper Bus; Convertible Mains—Factory-Installed Main Circuit Breaker, 22 kA Short Circuit Current Rating Convertible appropriate to Main Lugs (See page 1-11) or QOM Main Circuit Breaker (See page 1-22)									
	125 A	24	34	10	QO124L125PGCVP	(1) QO124L125PGC, (3) QO120, (2) QO230	PK15GTA Included	6-2/0		7
	225 A	42	52	10	QO142L225PGCVP OBS	(1) QO142L225PGC, (3) QO120, (2) QO230	PK23GTA Included	4-300		11
	Convertible Mains—Factory-Installed Main Circuit Breaker, 22 kA Short Circuit Current Rating Convertible appropriate to Main Lugs or Main Circuit Breaker (See page 1-25)									
	100 A	24	34	10	QO124M100PCVP	(1) QO124M100PC, (3) QO120, (2) QO230	PK15GTA	6-2/0		7
		32	38	6	QO132M100PCVP	(1) QO132M100PC, (3) QO120, (2) QO230	PK18GTA	6-2/0		8
	200 A	42	52	10	QO142M200PCVP	(1) QO142M200PC, (3) QO120, (2) QO230	PK23GTA	4-300		11
		42	52	10	QO142M200PCAFVP	(1) QO142M200PC, (3) QO120, (2) QO230, (3) QO115PCAFI	PK23GTA			11
	HomeLine (Accepts Only HOM Plug-On Circuit Breakers); Convertible Mains—Factory-Installed Main Lugs, 10 kA Short Circuit Current Rating Convertible to appropriate QOM 22 kA Short Circuit Current Rating Main Circuit Breaker (See page 1-25)									
	125 A	12	24	12	HOM1224L125PGCVP	(1) HOM1224L125PGC, (2) HOM120	PKGTALP1 Included	6-2/0	6-1	6
	225 A	30	60	30	HOM3060L225PGCVP	(1) HOM3060L225PGC, (3) HOM120, (2) HOM230	PKGTALP2 Included	4-300	4-250	10
	Convertible Mains—Factory-Installed Main Circuit Breaker, 22 kA Short Circuit Current Rating Convertible appropriate to Main Lugs or Main Circuit Breaker (See page 1-25)									
	100 A	20	40	20	HOM2040M100PCVP	(1) HOM2040M100PC, (2) HOM120, (1) HOM230	PK18GTA	6-1	6-3	7
		20	40	20	HOM2040M100PC1AVP	(1) HOM2040M100PC, (2) HOM120, (1) HOM230, (1) HOM115PCAFI	PK18GTA	6-1	6-3	7
	150 A	24	48	24	HOM2448M100PCVP	(1) HOM2448M100PC, (3) HOM120, (2) HOM230	PK23GTA	6-2/0	6-1/0	8
		30	30	30	HOM3060M150PCVP	(1) HOM3060M150PC, (3) HOM120, (2) HOM230	PK23GTA	4-250		10
	200 A	20	40	20	HOM2040M200PCVP	(1) HOM2040M200PC, (3) HOM120, (2) HOM230	PK18GTA	4-250		9
		30	60	30	HOM3060M200PCVP	(1) HOM3060M200PC, (3) HOM120, (2) HOM230	PK23GTA			10
		30	60	30	HOM3060M200PC1AVP	(1) HOM3060M200PC, (3) HOM120, (2) HOM230, (1) HOM115PCAFI	PK23GTA			10
		30	60	30	HOM3060M200PCAFVP	(1) HOM3060M200PC, (3) HOM120, (2) HOM230, (3) HOM115PCAFI	PK23GTA			10
40		80	40	HOM4080M200PCVP	(1) HOM4080M200PC, (3) HOM120, (2) HOM230	PK27GTA			12	
40		80	40	HOM4080M200PC1AVP	(1) HOM4080M200PC, (3) HOM120, (2) HOM230, (1) HOM115PCAFI	PK27GTA			12	
	40	80	40	HOM4080M200PCAFVP	(1) HOM4080M200PC, (3) HOM120, (2) HOM230, (3) HOM115PCAFI	PK27GTA		12		

OBS This product is obsolete.

Table 1.62: Plug-on Neutral with Qwik-Grip Indoor Load Center Value Packs (Compatible with Plug-on and Plug-on Neutral Breakers)

	Main Ratings	Spaces	Max. 1P Circuits	Max. Tandem Circuit Breakers	Load Center Box, Interior, Cover and Branch Circuit Breakers		Equipment Ground Bar Kit (Order Separately)	Main Wire Size [AWG/kcmil] Al/Cu		Box No. [3]
					Cat. No.	Included Load Center/Circuit Breakers		Cat. No.		
INDOOR	QO Convertible Mains—Factory-Installed Main Lugs, up to 65 kA Short Circuit Current Rating—Copper Bus, QOM1 Main Frame Size, Convertible to Main Circuit Breaker									
	125 A	24	34	10	QO124L125PQGCVP	(1) QO124L125PQGC, (3) QO120, (2) QO230 and (1) PKQGA Qwik-Grip assembly kit	PK15GTAL Included	6-2/0		7Q
	QO Convertible Mains—Factory-Installed Main Circuit Breaker, 22 kA Short Circuit Current Rating—Copper Bus, QOM2 Main Frame Size, Convertible to Main Lugs or Main Circuit Breaker									
	200 A	42	52	10	QO142M200PQCV	(1) QO142M200PQC, (3) QO120, (2) QO230 and (1) PKQGA Qwik-Grip assembly kit	PK23GTA (Order separately)	4-250		11Q
	HomeLine Convertible Mains—Factory-Installed Main Circuit Breaker, 22kA Short Circuit Current Rating—Copper Bus, QOM1 Main Frame Size, Convertible to Main Lugs or Main Circuit Breaker									
	100 A	20	40	20	HOM2040M100PQCV	(1) HOM2040M100PQC, (2) HOM120, (1) HOM230 and (1) PKQGA Qwik-Grip assembly kit	PK18GTA (Order separately)	6-2/0	6-1	7Q
200 A	30	60	30	HOM3060M200PQCV	(1) HOM3060M200PQC, (3) HOM120, (2) HOM230 and (1) PKQGA Qwik-Grip assembly kit	PK23GTA (Order separately)	4-250		10Q	
	40	80	40	HOM4080M200PQCV	(1) HOM4080M200PQC, (2) HOM120, (1) HOM230 and (1) PKQGA Qwik-Grip assembly kit	PK27GTA (Order separately)	4-250		12Q	

Table 1.63: Plug-on Neutral Rainproof Load Center Value Packs (Compatible with Plug-on and Plug-on Neutral Circuit Breakers)

	Main Ratings	Spaces	Max. 1P Circuits	Max. Tandem Circuit Breakers	Load Center Box, Interior, Cover and Branch Circuit Breakers		Equipment Ground Bar Kit (Order Separately)	Main Wire Size [AWG/kcmil] Al/Cu		Box No. [3]
					Cat. No.	Included Load Center/Circuit Breakers		Cat. No.		
RAINPROOF	HomeLine (Accepts Only HOM Plug-On Circuit Breakers) Convertible Mains—Factory-Installed Main Circuit Breaker, 22 kA Short Circuit Current Rating Convertible to Main Lugs or Lower Amperage QOM2 Main Circuit Breaker (See page 1-25)									
	125 A	12	24	12	HOM1224M125PRBVP	(1) HOM1224M125PRB, (3) HOM120, (2) HOM230	PK23GTA	6-2/0	6-1	3R
	200 A	30	60	30	HOM3060M200PRBVP	(1) HOM3060M200PRB, (3) HOM120, (2) HOM230	PK23GTA	4-250		7R

[1] Maximum single pole branch circuits utilizing QO and/or QOT circuit breakers.

[2] See page 1-32 or page 1-34

[3] See page 1-32

**Table 1.64: Plug-on Neutral Load Center Surge Packs (Compatible with Plug-On and Plug-On Neutral Circuit Breakers)**

	Mains Rating	Max. 1P Circuits	Max. Tandem Circuit Breakers	Load Center Box, Interior, Cover and Branch Circuit Breakers		Equipment Ground Bars	Main Wire Size AWG/kcmil		Box No.
				Catalog Number	Included Load Center / Circuit Breakers / SPD	Catalog Number	Al	Cu	
Indoor	225	60	30	HOM3060L225PGCSVP2	(1) HOM3060L225PGC, (1) HOM230, (2) HOM120, (1) Plug-on Neutral HOM250PSPD, Cover & Ground Bar	PK9GTA, PK18GTAL (included)	4-300	4-250	10
Rainproof	200	16	8	HOM816M200PFTRBSP2	(1) HOM816M200PFTRB & (1) Plug-on Neutral HOM250PSPD	PK15GTA (order separately)	4-250		6R

**QO Load Center Accessories**

**Table 1.65: QO Load Center Accessories**

	Description	Cat. No.	Schedule
Circuit Identification Stickers	Circuit identification stickers for use on cover directory labels to identify branch circuits	PSDS	DE5
Cover Sealing Strap	Provides means of sealing trim mounting screws on QO load center covers	QO1SE	DE3A
Door Lock Kits	Use with QO612L100DF/S, QO612L100DFCU/SCU, QO612L100DTF/S, QO816L100DF/S, QO816L100DFCU/SCU, QO816L100DTF/S, QO48M30DSGP, or QO48M60DSGP	PK8FL [4]	DE3A
	Use with convertible mains, 1Ø and 3Ø 100–225 A, and fixed mains, 3Ø 125–225 A indoor load centers	PK6FL	DE3A
	Use with 300 and 400 ampere indoor load centers	PK4FL	PE1A
Filler Plates	Fills opening in covers if twistout is removed in error	QOFP	DE3A
	Fills main circuit breaker opening in convertible load center covers 100–125 A	QOM1FP	DE3A
	Fills main circuit breaker opening in convertible load center covers 150–225 A	QOM2FP	DE3A
	Fills main circuit breaker opening in 3Ø load center covers (S01 and S02 Series)	KFP	DE3A
	Fills main circuit breaker opening in "Q" style 3Ø load center covers (S03 Series)	Q2FP	DE3A
Ground Bar Kits	Ground Bar Assembly—3 connectors	PK3GTA1	DE3A
	Ground Bar Assembly—4 connectors	PK4GTA	DE3A
	Ground Bar Assembly—7 connectors	PK7GTA	DE3A
	Ground Bar Assembly—9 connectors	PK9GTA	DE3A
	Ground Bar Assembly—12 connectors	PK12GTA	DE3A
	Ground Bar Assembly—15 connectors	PK15GTA	DE3A
	Ground Bar Assembly—18 connectors	PK18GTA	DE3A
	Ground Bar Assembly—23 connectors	PK23GTA	DE3A
	Ground Bar Assembly—27 connectors	PK27GTA	DE3A
	Ground Bar Assembly—21 connectors. Use in high amperage load centers.	PK15GTA6	DE3A
	Standard PK15GTA with a 1–4/0 Al/Cu Lug	PK15GTAL	DE3A
	Standard PK18GTA with a 1–4/0 Al/Cu Lug	PK18GTAL	DE3A
	Standard PK23GTA with a 1–4/0 Al/Cu Lug	PK23GTAL	DE3A
	Ground Bar Pack—PK9GTA, PK9GTA, & LK100AN	PKGTALP1	DE3A
	Ground Bar Pack—PK9GTA, PK18GTA, & LK100AN	PKGTALP2	DE3A
Ground Bar Pack—PK15GTA, PK18GTA, & LK100AN	PKGTALP3	DE3A	
Insulator Kit for PK7GTA through PK27GTA		PKGTAB	DE3A
		QOM1PA	DE2E
Handle Padlock Attachments	For padlocking main circuit breakers in convertible load centers OFF	50A–125A	QOM2PA
	For padlocking main circuit breakers in convertible load centers OFF	100A–225A	QOM2PA
Neutral Bonding Screw	For use on all Homeline and QO 125A convertible main load centers	4028344850K	DE5
	For use on QO 150A–225A convertible main load centers	4028345850K	DE5
Neutral / Ground Lugs	Field-installed for 12–2 Al or 14–4 Cu AWG wire	LK70AN	DE3A
	Field-installed for 6–2/0 Al/Cu AWG wire	LK100AN	DE3A
	Field-installed for 14–2/0 Al/Cu AWG wire	LK125AN	DE3A
	Field-installed for 2–3/0 Al/Cu AWG wire	LK150AN	DE3A
	Field-installed for 4 AWG to 300 kcmil Al/Cu wire. Use in Series S, 150–225A QO load center or S03 and below, 150–225A HOM load center	LK225AN LK225ANHOM	DE3A
Replacement Cover Directory Label	1 through 42 numbered universal replacement directory label for load center covers	LSDL	DE5
Retaining Kit for Breakers Used as Back-fed Mains	Secures circuit breaker to interior when used as a back-fed main. For QO612L100F/S, RB, QO612L100DF/S, RB, QO816L100F/S, RB, QO816L100DF/S and QO148L125GF/S, GRB load centers	PK2MB	DE3A
	Secures 3P circuit breaker without accessories to left side of interior when used as a back-fed main. For 3Ø load centers	PK3MB	DE3A
	Secures circuit breaker to interior when used as a back-fed main for 2P QO 150–200 A circuit breakers	PK5RK 06S	DE3A
	Secures ONE circuit breaker with or without electrical accessories to right side of interior when used as a back-fed main for 1Ø 100–125 ampere convertible main load centers. Series S01 and S02	PK4MB2LA	DE3A
	Secures ONE circuit breaker with or without electrical accessories to right side of interior when used as a back-fed main for 1Ø 150–225 ampere convertible main load centers. Series S01 and S02	PK4MB2HA	DE3A
Service Entrance Barriers	QO / Homeline 1Ø 100–125 A QOM1 convertible main load centers	PKSB1LA	DE3A
	QO / Homeline 1Ø 150–225 A QOM2 convertible main load centers	PKSB1HA	DE3A
	QO 3Ø convertible main load centers	PKSB3	DE3A
	QO 1Ø back-fed main breaker applications	PKSB1QOBF	DE3A
	QO 3Ø back-fed main breaker applications	PKSB3BF	DE3A
<b>QO Load Center Manual Power Transfer Accessories</b>			
Generator Circuit Breaker Interlock Kit	For use on "G" and "S" Series NEMA 1 and "G", "S1" and "S2" Series NEMA 3R load centers. Interlocks a QOM1 2P main circuit breaker of a load center (100–125 A) with a QO 2P (15–125 A) branch circuit breaker. Includes a retaining kit.	QOCRBGK1C	DE3A
	For use on "G" and "S" Series NEMA 1 and "G" and "S1" Series NEMA 3R load centers. Interlocks a QOM2 2P main circuit breaker of a load center (150–225 A) with a QO 2P (15–125 A) branch circuit breaker. Includes a retaining kit.	QOCGK2C	DE3A
	For use on "S2" Series NEMA 3R load centers. Interlocks a QOM2 2P main circuit breaker of a load center (150–225 A) with a QO 2P (15–125 A) branch circuit breaker. Includes a retaining kit.	QORBGK2C	DE3A

[4] QO403L60NF/S does not have provisions for a field-installed lock.

Table 1.65 QO Load Center Accessories (cont'd.)

	Description	Cat. No.	Schedule
Manual Transfer Equipment Kit	For interlocking the handles of two 2P or one 2P and one 1P QO and Q1 circuit breakers mounted side-by-side so that only one circuit breaker can be "ON" at a time.	QO2DTI	DE2E
	QO2DTI mechanical interlock attachment with retaining kits for securing two adjacent back-fed circuit breakers in dual power supply applications. Can be used with (2) 2P or (1) 2P and (1) 1P QO circuit breakers in QO816L100 load centers.	QO2DTIM	DE2E
	Secures two 2P circuit breakers to right side of interior when used as back-fed mains, a QO2DTI Kit included for back-up power supply applications. For 1Ø 100–125 ampere convertible main load centers. Series S01 and S02.	PK4DTIM4LA	DE3A
	Secures two 2P circuit breakers to right side of interior when used as back-fed mains, a QO2DTI Kit included for back-up power supply applications. For 1Ø 150–225 ampere convertible main load centers. Series S01 and S02.	PK4DTIM4HA	DE3A
	Secures two 2P circuit breakers to left side of interior when used as back-fed mains, a QO2DTI Kit included for back-up power supply applications. For 1Ø 100–125 ampere convertible main load centers. Series S01 and S02.	PK4DTIM4LAL	DE3A

ØBS This product is obsolete.

Table 1.66: QO Load Center Accessories



Table 1.67: QO Load Center Covers

Mains Rating	Spaces	QO Standard Covers			QO Mono-Flat Covers	
		Flush	Surface	Flush	Gray Covers	White Covers
		Gray Covers		White Covers	Gray Covers	White Covers
<b>QO 1 Phase Load Center Covers — Convertible Mains</b>						
100A	12	QOC12UF	QOC12US	—	—	—
	16	QOC20U100F	QOC20U100S	—	—	—
	20	QOC20U100F	QOC20U100S	—	—	—
	24	QOC24UF	QOC24US	QOC24UFW	—	—
125A	32	QOC32UF	—	QOC32UFW	—	—
	12	QOC16UF	QOC16US	QOC16UFW	—	—
	16	QOC24UF	QOC24US	QOC24UFW	—	—
	20	QOC20U100F	QOC20U100S	—	—	—
	24	QOC24UF	QOC24US	QOC24UFW	—	—
	30	QOC30U125C	—	—	—	—
150A	32	QOC32UF	—	QOC32UFW	—	—
	20	QOC30UF	QOC30US	QOC30UFW	QOCMF30UC	QOCMF30UCW
	24	QOC30UF	QOC30US	QOC30UFW	QOCMF30UC	QOCMF30UCW
	30	QOC30UF	QOC30US	QOC30UFW	QOCMF30UC	QOCMF30UCW
200A	32	QOC40UF	QOC40US	QOC40UFW	—	—
	12	QOC30UF	QOC30US	QOC30UFW	QOCMF30UC	QOCMF30UCW
	20	QOC30UF	QOC30US	QOC30UFW	QOCMF30UC	QOCMF30UCW
	24	QOC30UF	QOC30US	QOC30UFW	QOCMF30UC	QOCMF30UCW
	30	QOC30UF	QOC30US	QOC30UFW	QOCMF30UC	QOCMF30UCW
	40	QOC40UF	QOC40US	QOC40UFW	—	—
225A	42	QOC42UF	QOC42US	QOC42UFW	QOCMF42UC	QOCMF42UCW
	54	QOC54UF	—	QOC54UFW	QOCMF54UC	QOCMF54UCW
	60	—	—	—	QOCMF60UC	QOCMF60UCW
	40	QOC42UF	QOC42US	QOC42UFW	QOCMF42UC	QOCMF42UCW
<b>QO Rise Panel (Wide Gutter) Covers</b>						
125A	12	QOC20UFWG	—	QOC20UFWGW	NQC20FWG	NQC20FWGW
	20	QOC20UFWG	—	QOC20UFWGW	NQC20FWG	NQC20FWGW
200A	24	QOC30UFWG	—	QOC30UFWGW	NQC30FWG	NQC30FWGW
	30	QOC30UFWG	—	QOC30UFWGW	NQC30FWG	NQC30FWGW
<b>QO 3-Phase Load Center Covers — Fixed Mains</b>						
125A	12	QOC16UF	QOC16US	QOC16UFW	—	—
	20	QOC24UF	QOC24US	QOC24UFW	—	—
	24	QOC24UF	QOC24US	QOC24UFW	—	—
200A	18	QOC30UF	QOC30US	QOC30UFW	—	—
	30	QOC30UF	QOC30US	QOC30UFW	—	—
225A	42	QOC42UF	QOC42US	QOC42UFW	—	—
<b>QO 3-Phase Load Center Covers — Convertible Mains</b>						
100A	27	QOC30UF	QOC30US	QOC30UFW	—	—
125A	30	QOC342MQF	QOC342MQS	—	—	—
	30	QOC342MQF	QOC342MQS	—	—	—
150A	42	QOC342MQF	QOC342MQS	—	—	—



**Table 1.67 QO Load Center Covers (cont'd.)**

Mains Rating	Spaces	QO Standard Covers			QO Mono-Flat Covers	
		Flush	Surface	Flush	Gray Covers	White Covers
		Gray Covers		White Covers		
200A	30	QOC342MQF	QOC342MQS	—	—	—
	42	QOC342MQF	QOC342MQS	—	—	—
225A	42	QOC342MQF	QOC342MQS	—	—	—

**Table 1.68: QO Load Center Covers**



QOCMF42UCW



QOC40UFW



QOC20UFWG

**Homeline Load Center Accessories**

**Table 1.69: Homeline Load Center Accessories**

	Description	Cat. No.	Schedule	
Circuit Identification Stickers	Circuit identification stickers for use on cover directory labels to identify branch circuits	PSDS	DE5	
Door Lock Kit	Use with convertible indoor load center covers (Series S-1)	PK6FL	DE3A	
Filler Plates	Fills opening in covers if twistout is removed in error	HOMFP	DE3C	
	Fills main circuit breaker opening in convertible load centers	100–125 A	QOM1FP	DE3A
		150–225 A	QOM2FP	DE3A
Generator Circuit Breaker Interlock Kit	For use on "S" Series NEMA 1 and NEMA 3R load centers. Interlocks a QOM1 2P main circuit breaker of a load center (100–125 A) with a Homeline 2P (15–125 A) branch circuit breaker	HOMCRBGK1C	DE3D	
	For use on "S" Series NEMA 1 and "S1" Series NEMA 3R load centers. Interlocks a QOM2 2P main circuit breaker of a load center (150–225 A) with a Homeline 2P (15–125 A) branch circuit breaker	HOMCGK2C	DE3D	
	For use on "S2" and "S3" Series NEMA 3R QOM2 load centers. Interlocks a QOM2 2P main circuit breaker of a load center (150–225 A) with a Homeline 2P (15–125 A) branch circuit breaker	HOMRBGK2C	DE3D	
Ground Bar Kits	Ground Bar Assembly - 3 connectors	PK3GTA1	DE3A	
	Ground Bar Assembly - 4 connectors	PK4GTA1	DE3A	
	Ground Bar Assembly - 7 connectors	PK7GTA1	DE3A	
	Ground Bar Assembly - 9 connectors	PK9GTA1 <sup>obs</sup>	DE3A	
	Ground Bar Assembly - 15 connectors	PK15GTA1	DE3A	
	Ground Bar Assembly - 19 connectors	PK18GTA1	DE3A	
	Ground Bar Assembly - 23 connectors	PK23GTA1	DE3A	
	Ground Bar Assembly - 27 connectors	PK27GTA1	DE3A	
	Standard PK15GTA with a 1–4/0 Al/Cu Lug	PK15GTA	DE3A	
	Standard PK18GTA with a 1–4/0 Al/Cu Lug	PK18GTAL	DE3A	
	Ground Bar Pack - PK9GTA, PK9GTA & Lug	PKGTALP1	DE3A	
	Ground Bar Pack - PK9GTA, PK18GTA & Lug	PKGTALP2	DE3A	
	Ground Bar Pack - PK15GTA, PK18GTA & Lug	PKGTALP3	DE3A	
	Insulator Kit for PK7GTA through PK27GTA	PKGTAB	DE3A	
Handle Padlock Attachment	For padlocking main circuit breakers in convertible load center, "OFF"	50–125 A	QOM1PA	DE2E
		100–225 A	QOM2PA	DE2E
Neutral Bonding Screw	For use on all Homeline and QO 125A convertible main load centers	4028344850K	DE5	
	For use on QO 150A-225A convertible main load centers	4028345850K	DE5	
Neutral / Ground Lugs	Field-installed for 14–2 AWG Al or 14–4 AWG Cu wire	LK70AN	DE3B	
	Field-installed for 6–2/0 AWG Al/Cu wire	LK100AN	DE3B	
	Field-installed for 14–2/0 AWG Al/Cu wire	LK125AN	DE3B	
	Field-installed for 4 AWG to 300 kcmil Al/Cu wire. Use in Series S, 150-225A QO load center or S03 and below, 150-225A HOM load center	LK225AN	DE3A	
	Field-installed for 4 AWG–300 kcmil Al/Cu wire. Use in Series S04, 150–225 A HOM load center	LK225ANHOM	DE3A	
Replacement Cover Directory Label	1 through 42 numbered universal replacement directory label for load center covers	LSDL	DE5	
Retaining Kit for Breakers Used as Back-fed Mains	Secures circuit breaker to interior when used as a back-fed main. For HOM612L100F/S, RB and HOM48L125GC, GRB load centers	HOM1RK	DE3C	
	Secures ONE circuit breaker right side of interior when used as a back-fed main For 100–125 A convertible main load centers, Series S01 and S02	HOM4RK2LA	DE3C	
	Secures ONE circuit breaker right side of interior when used as a back-fed main For 150–225 A convertible main load centers, Series S01 and S02	HOM4RK2HA <sup>obs</sup>	DE3C	
	Secures circuit breaker to interior when used as a back-fed main For 2P 150–200 A circuit breakers	HOM5RK	DE3C	
Service Entrance Barriers	QO / Homeline 1Ø 100–125 A QOM1 convertible main load centers	PKSB1LA	DE3A	
	QO / Homeline 1Ø 150–225 A QOM2 convertible main load centers	PKSB1HA	DE3A	
	Homeline back-fed main breaker applications	PKSB1HOMBF	DE3A	

<sup>obs</sup> This product is obsolete.

Table 1.70: Homeline Load Center Replacement Covers

Mains Rating	Spacers	Homeline Standard Covers		Homeline Mono Flat Covers
		Combination	Combination	Gray
		Gray	White	Gray
100A	8	HOMC8UC	—	—
	12	HOMC12UC	HOMC12UCW	—
	24	HOMC24UC	HOMC24UCW	—
125A	8	HOMC12UC	HOMC12UCW	—
	16	HOMC24UC	HOMC24UCW	—
	20	HOMC24UC	HOMC24UCW	—
	24	HOMC24UC	HOMC24UCW	—
150A	16	HOMC20UC	HOMC20UCW	—
	20	HOMC20UC	HOMC20UCW	—
	30	HOMC30UC	HOMC30UCW	—
200A	12	HOMC20UC	HOMC20UCW	—
	16	HOMC20UC	HOMC20UCW	—
	20	HOMC20UC	HOMC20UCW	—
	30	HOMC30UC [5]	HOMC30UCW	—
	40	HOMC42UC	—	—
	42	HOMC42UC	—	—
	60	HOMC60UC	—	HOMCMF60UC
225A	16	HOMC20UC	HOMC20UCW	—
	20	HOMC20UC	HOMC20UCW	—
	30	HOMC30UC	HOMC30UCW	—
	40	HOMC42UC	—	—
	42	HOMC42UC	—	—
	60	HOMC60UC	—	HOMCMF60UC

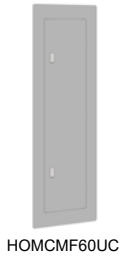

QO and Homeline Qwik-Grip Load Center Accessories

Table 1.71: Qwik-Grip Load Center Accessories

Description		Cat. No.	Schedule
Qwik-Grip replacement shield	(1) Qwik-Grip shield	PKQGS	DE3A
Qwik-Grip fillers	(4) Qwik-Grip fillers	PKQGFP	DE3A
Qwik-Grip replacement insert	(1) Qwik-Grip insert	PKQGI	DE3A
Qwik-Grip assembly kit	(4) Qwik-Grip shields, (4) Qwik-Grip fillers	PKQGA	DE3A

[5] Extra long version available HOMC30UFL

**Surge Protective Devices (SPD)**

**Table 1.72: Load Center and CSED Surge Protection Devices**

Description	Cat. No.	Description	Surge Current per Phase	Schedule
Surge Protective Devices	<a href="#">QO2175SB</a>	QO Surgebreaker	22.5 kA	DE1B
	<a href="#">HOM2175SB</a>	HOM Surgebreaker	22.5 kA	DE1B
	<a href="#">HEPD25</a>	1Ø3W—120/240 V Compact SPD	25 kA	DE1B
	<a href="#">SDSA2040</a>	3Ø4W—208Y/120 V Compact SPD	40 kA	DE1B
	<a href="#">SDSA2040D</a>	3Ø3W—240 V Compact SPD	40 kA	DE1B
	<a href="#">QO250PSPD</a>	QO Plug-on Neutral SPD	50 kA	DE1B
	<a href="#">HOM250PSPD</a>	HOM Plug-on Neutral SPD	50 kA	DE1B
	<a href="#">HEPD50</a>	SurgeArrest Whole Home Electronic Protection	50 kA	DE1B
	<a href="#">HEPD80</a>	SurgeArrest Whole Home Electronic Protection	80 kA	DE1B
	<a href="#">SDSB80111</a>	Surgebreaker Plus (all-in-one protection for appliances, ethernet, and telephone)	80 kA	DE1B
Surge Protective Device Mounting Kits	<a href="#">HEPD25MKF</a>	HEPD25 Flush Mount Kit	—	DE1B
	<a href="#">HEPD58MKF</a>	HEPD50 and HEPD80 Flush Mount Kit	—	DE1B



HEPD25



HEPD50



HEPD80



QO250PSPD



HOM250PSPD



QO2175SB



HOM2175SB

Indoor Enclosure Dimensions and Knockout Information

Table 1.73: Enclosure Dimensions

Box No.	Dimensions					
	W		H		D	
	in.	mm	in.	mm	in.	mm
1	3.81	97	6.72	171	3.00	76
2	4.81	122	9.30	236	3.19	81
3	4.81	122	9.30	236	3.19	81
4	8.88	226	12.57	319	3.80	97
5	14.25	362	14.92	379	3.75	95
6	14.25	362	17.92	455	3.75	95
7	14.25	362	20.92	531	3.75	95
8	14.25	362	26.04	661	3.75	95
9	14.25	362	29.86	758	3.75	95
10	14.25	362	33.78	858	3.75	95
11	14.25	362	37.98	965	3.75	95
12	14.25	362	39.37	1000	3.75	95

Table 1.74: Knockout Information

Symbol	Knockouts								
	A	B	C	D	E	F	G	H	I
Conduit Size	1/2	3/4	1	1-1/4	1-1/2	2	2-1/2	3	3-1/2

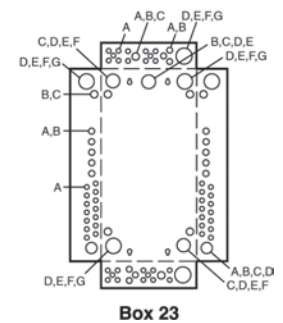
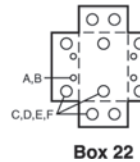
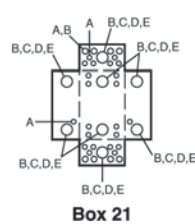
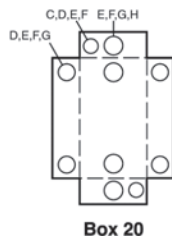
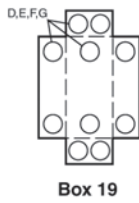
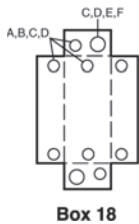
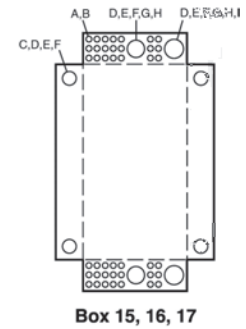
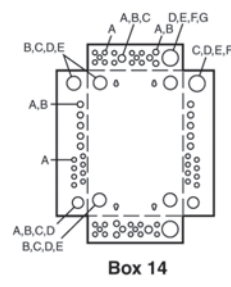
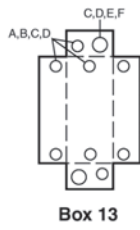
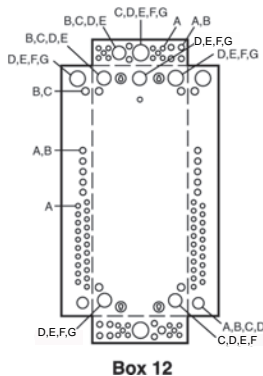
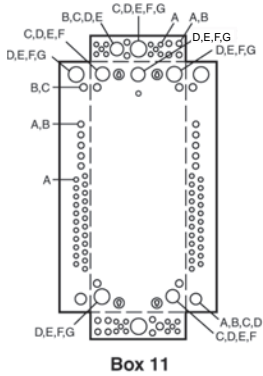
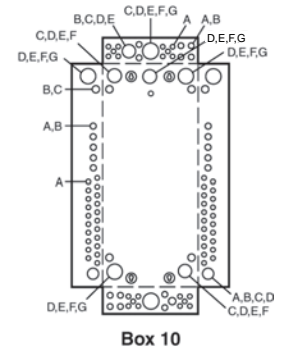
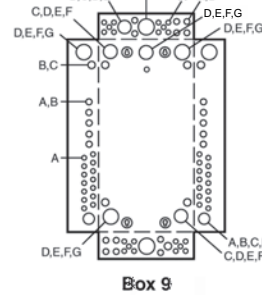
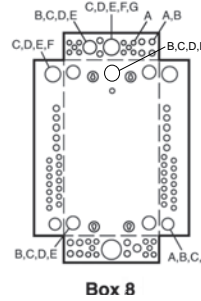
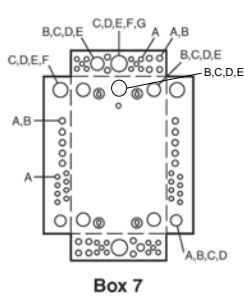
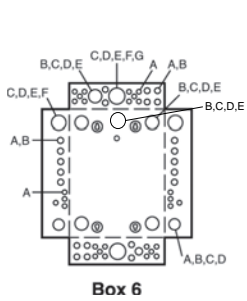
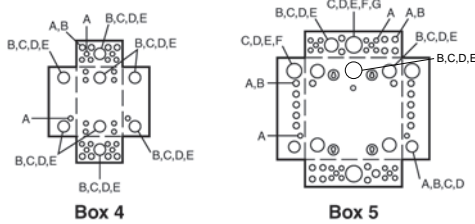
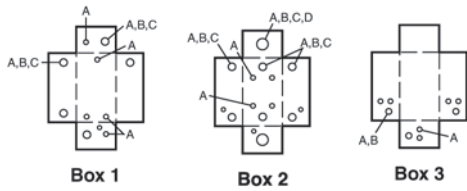

**Table 1.75: Indoor Knockout Information and Enclosure Dimensions for Qwik Grip Loadcenters**

Box No.	Dimensions					
	W		H		D	
	in.	mm	in.	mm	in.	mm
7Q	14.25	362	20.92	531	3.75	95
8Q	14.25	362	26.04	661	3.75	95
9Q	14.25	362	29.86	758	3.75	95
10Q	14.25	362	33.78	858	3.75	95
11Q	14.25	362	37.98	965	3.75	95
12Q	14.25	362	39.37	1000	3.75	95

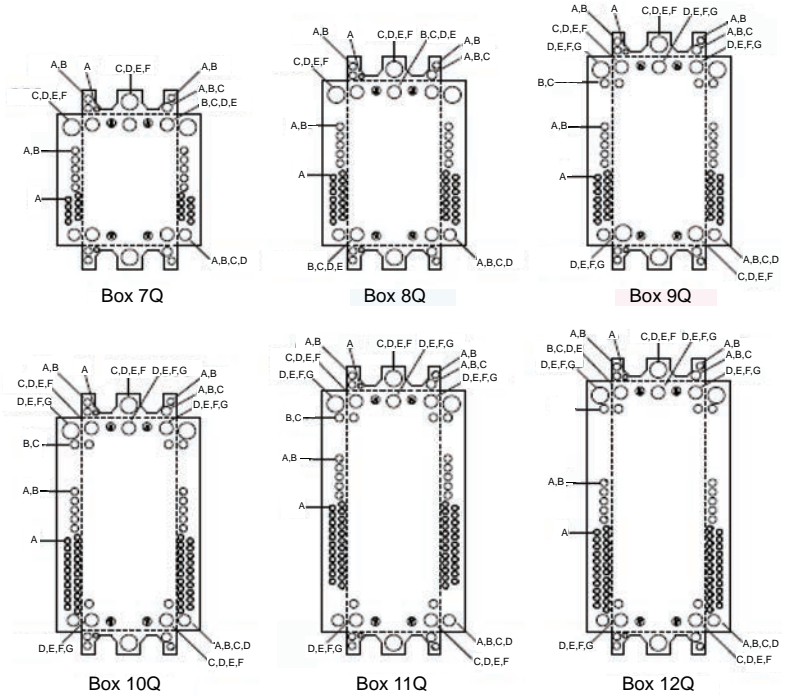

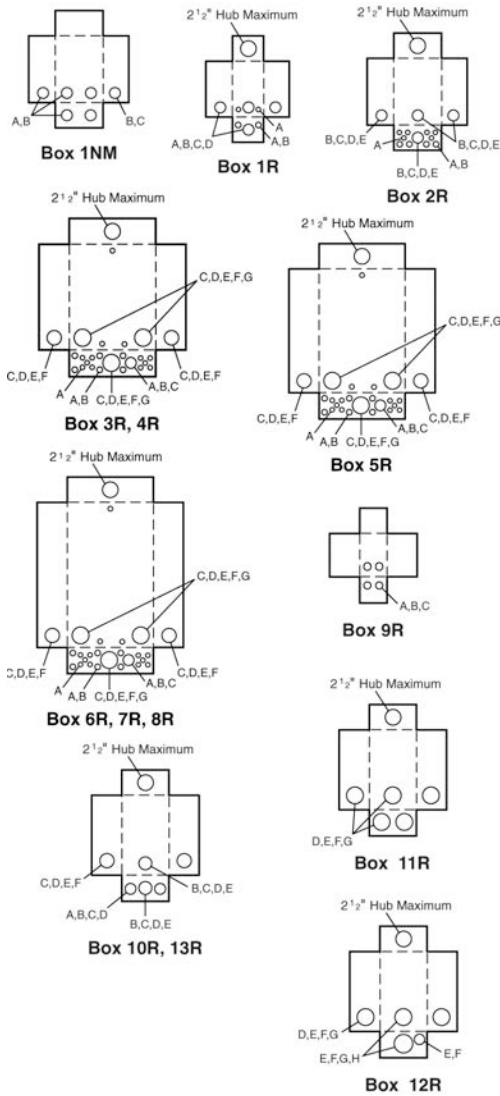

Enclosure Dimensions and Knockout Information

Table 1.76: Enclosure Dimensions

Box No.	Dimensions					
	W		H		D	
	in.	mm	in.	mm	in.	mm
1NM	6.52	166	8.79	223	3.90	99
1R [1]	4.88	124	9.38	238	4.00	102
2R	8.88	226	12.65	321	4.27	108
3R	14.75	375	18.92	481	4.52	115
4R	14.75	375	22.06	560	4.52	115
5R	14.75	375	26.04	661	4.52	115
6R	14.75	375	29.86	758	4.52	115
7R	14.75	375	33.78	858	4.52	115
8R	14.75	375	37.98	965	4.52	115
9R	4.56	116	6.50	165	3.88	99
10R	6.92	176	13.18	335	4.12	105
11R	7.56	192	23.24	590	4.75	121
12R	9.62	244	26.24	666	5.50	140
13R	6.92	176	16.18	411	4.12	105
14R	14.75	375	39.37	1000	4.52	115
15R	8.88	226	14.80	376	4.27	108
16R	8.55	217	24.75	629	4.16	106
17R	8.88	226	12.65	321	4.27	108

Table 1.77: Knockout Information

Symbol	Knockouts							
	A	B	C	D	E	F	G	H
Conduit Size	1/2 in.	3/4 in.	1 in.	1-1/4 in.	1-1/2 in.	2 in.	2-1/2 in.	3 in.

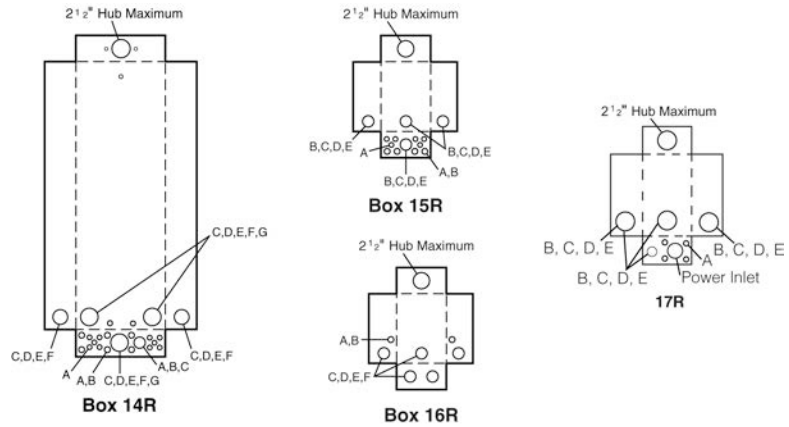

Bolt-On Hubs

Square D equipment with "R" or "RB" suffix, designated NEMA 3R rainproof construction, utilizes bolt-on hubs listed below. "RB" devices will accept 3/4 in. through 2-1/2 in. bolt-on hubs without the use of reducers. Off-center conduit thread openings and elongated mounting holes provide quick and easy adjustment to eliminate costly conduit offsets and bends. Catalog suffix "R" devices require 3 in. through 4 in. field cut opening. Hubs are suitable for use with conduit having ANSI standard taper pipe thread.



Table 1.78: Bolt-On Hubs UL Listed for Rainproof Devices

Conduit Size	3/4 in.	1 in.	1-1/4 in.	1-1/2 in.	2 in.	2-1/2 in.
Hub Cat. No.	B075	B100	B125	B150	B200	B250

NOTE: Closing cap (Cat. No. BCAP) is provided factory-installed on each device having "RB" suffix.

Table 1.79: Bolt-On Hubs UL Listed for Mounting in Field-Cut Opening

Conduit Size	3 in.	4 in.
Hub Cat. No.	B300	B400
	Designed for mounting in field cut opening. Includes gasket and four mounting bolts and nuts.	

[1] HOME250SPA and QO260NATR top endwall has no hub opening.

**Catalog Number Logic for CSED**

**Table 1.80: Catalog Numbers for Combination Service Entrance Devices**

Number Segment	Character	Description	R	Q	C	8	16	D	200	C	H	X	S
Socket Type	Q	QO Ringless											
	R	HOM Ringless											
	C	QO Ring type											
	S	HOM Ring type											
Service Disconnect Install	Blank	Field Installed											
	Q	Factory Installed											
Service Feed	Blank	Combination overhead/underground											
	C	Combination overhead/underground											
	O	Overhead only											
	U	Underground only											
	RA	"A" Hub provision in top endwall											
Spaces (Service Discounts or Branches)	#	Maximum # of 1-pole circuits											
	#	Maximum # of 1-pole spaces											
Interior	D	Dual main service disconnects (feed-thru lugs on meter mains only)											
	F	Single main service disconnect with feed-thru lugs											
	L	Main lug interior (service disconnects field installed)											
	M	Single main service disconnect											
Amperage Rating	100	100 A											
	125	125 A											
	150	150 A											
	200	200 A											
	225	225 A											
	400	400 A											
Enclosure Mounting Style	C	Surface mount or convertible to semi-flush (use appropriate flange kit)											
	F	Semi-flush mount only											
	R	Reverse mount only											
	S	Surface mount only											
	PF	Home PoN semi-flush mount device											
	PS	Home PoN surface mount device											
Meter Socket Bypass Type	H	Horn by-pass											
	K	K-4 bolt-on, no by-pass											
	L	Class 320 with lever by-pass											
	N	Class 320, No by-pass											
	B	Class 320 with test block by-pass											
	Blank	No by-pass											
	X	2 piece lever by-pass cover											
Application	S	Solar ready											
	FMG	Florida Meter Group											
	MEG	Meter Equipment Group											

This table is for interpreting existing part number only. All possible combinations are not available.

**Table 1.81: Catalog Numbers Square D™ Energy Center**

Number Segment	Character	Description	QO	W	C	60	M	200	P	F	Y
Architecture platform	QO	QO architecture platform									
Wiser Energy	W	Wiser Energy									
Socket Type	C	QO Ringless									
Spaces	#	Number of Spaces									
Interior	M	Single main service disconnect									
Amperage Rating	200	200 A									
Plug-on-neutral	P	Plug-on-neutral ready									
Enclosure mounting style	F	Semi-flush mount only									
		Meter Socket Bypass Type									
Application	Y	Universal — compatible with any solar inverter									

Rainproof Meter Mains

Table 1.82: Rainproof Meter Mains

Ampere Rating	Bypass Type	Service (Type of Feed)		Short Circuit Current Rating	Cat. No.	Service Disconnect(s)			Load Center and Branch Circuit Breakers (Order separately [1])				Hub Type (Order separately [2])	Line Side Main Lugs AWG/kcmil (Al/Cu)	Service Ground Lug AWG/kcmil (Al/Cu)	Weight Each (Lbs) and Pallet Qty.	
		UL	UL and EUSERC			2P Circuits (Max.)	Type (Order separately [3])	Ampere Rating Max.	Max. Quantity		Ampere Rating Max.						
									Circuits	Tandems							
<b>Ring Type, QO™</b>																	
<b>Surface Mount Only</b>																	
125 A	None	OH/UG	—	10 kA	C125RB	1	QOM1-VH	125 A	—	—	—	—	B	4-1/0	8-1/0	15, 54	
		OH/UG	—	22 kA	CM200S	1	QOM2-VH	200 A	—	—	—	—	A	4-250	(2)8-2/0	26, 24	
200 A	None	OH/UG	—	22 kA	C2M200S	1	QOM2-VH	200 A	—	—	—	—	A	4-250	(2)8-2/0	27, 20	
		OH/UG	—	10 kA	C4L200S	2	QO	100 A	—	—	—	—	A	4-250	(2)8-2/0	27, 28	
<b>Ring Type, Homeline™</b>																	
<b>Surface Mount Only</b>																	
125 A	None	OH/UG	OH/UG	10 kA	SC8L125S	4	HOM	125 A	—	—	—	—	A	6-2/0	6-2/0	31, 24	
200 A	None	OH/UG	OH/UG	10 kA	SC12L200S	6	HOM	200 A [4]	—	—	—	—	A-L	4-250	8-2/0	40, 10	
<b>Semiflush Mount only</b>																	
125 A	None	OH/UG	OH/UG	10 kA	SC8L125F	4	HOM	110 A	—	—	—	—	A or B300	6-2/0	6-2/0	37, 20	
200 A	None	OH [5]/UG	OH [5]/UG	10 kA	SC12L200F	6	HOM	200 A [6]	—	—	—	—	A-L	4-250	8-2/0	47, 10	
<b>Surface Mount—Supplied with Feed-Thru Lugs and provisions for Branch Circuit Breakers</b>																	
150 A	None	OH/UG	—	10 kA	SC816D150C [7] [8]	1	HOM2150 [9]	150 A	8	16	8	100 A [10]	A or A-L	6-300	8-1/0	48, 18	
			UG		SU816D150C [7] [8]	1	HOM	50 A									
200 A	None	UG	—	10 kA	SC816D200C [7] [8]	1	HOM2200 [9]	200 A	8	16	8	100 A [10]	A or A-L	6-300	8-1/0	48, 18	
			UG		SU816D200C obs	1	HOM	50 A									
<b>Ringless, QO™</b>																	
<b>Surface Mount Only</b>																	
200 A	None	OH/UG	—	22 kA	RC200S [11]	1	QOM2-VH	200 A	—	—	—	—	A	6-350	(2)8-2/0	26, 24	
	Lever			10 kA	RCM200SL [11] [12]	1	QOM2-VH	200 A						A	6-350	8-1/0	60 / 14
	None			22 kA	RC2M200S [11]	1	QOM2-VH	200 A						A	6-350	(2)8-2/0	27, 20
	Horn			22 kA	RC2M200SH [11]	1	QO-VH	50 A						A	6-350	(2)8-2/0	27, 20
	Lever			10 kA	RC2M200SL [11] [12]	1	QOM2-VH	200 A						A	6-350	8-1/0	60 / 14
	None			22 kA	QC12L200S [11] [12]	6	QO-VH	200 A						A	6-350	8-2/0	43, 21
	None			22 kA	QC12L200C [11]	6	QO-VH	200 A [6]						A	6-350	12-2/0	40, 21
	None			22 kA	QC12L200C [11]	6	QO-VH	200 A [6]						A	6-350	12-2/0	40, 21
<b>Surface Mount Only, Supplied with Feed-Thru Lugs and provisions for Branch Circuit Breakers</b>																	
100 A	Horn	OH/UG	—	22 kA	QC816F100CH [7] [11] [12]	1	QOM2100VH [9]	100 A	8	16	8	100	A	6-350	12-2/0	40, 21	
125 A	None	OH/UG	—	22 kA	QC816F125S obs	1	QOM2125VH [9]	125 A	8	16	8	100	A	6-350	8-2/0	43, 21	
	None	OH/UG	—	22 kA	QC816F125C [7] [11]	1	QOM2125VH [9]	125 A	8	16	8	100	A	6-350	12-2/0	40, 21	
150 A	None	OH/UG	—	22 kA	QC816F150S [7] [11] [12]	1	QOM2150VH [9]	150 A	8	16	8	150 A [13]	A	6-350	8-2/0	43, 21	
	None	OH/UG	—	22 kA	QC816F150C [7] [11]	1	QOM2150VH [9]	150 A	8	16	8	150 A [13]	A	6-350	12-2/0	40, 21	
	Lever	OH/UG	—	22 kA	QC816F150SL [7] [11] [12]	1	QOM2150VH [9]	200 A	8	16	8	150 A	A	6-350	8-2/0	74 / 12	
200 A	None	OH/UG	—	22 kA	QC816F200S [7] [11] [12]	1	QOM2200VH [9]	200 A	8	16	8	200 A [6]	A	6-350	8-2/0	43, 21	
	Horn	OH/UG	—	22 kA	QC816F200SH [7] [11] [12]	1	QOM2200VH [9]	200 A	8	16	8	200 A [6]	A	6-350			
	Horn	OH/UG	—	22 kA	QC816F200CH [7] [11]	1	QOM2200VH [9]	200 A	8	16	8	200 A [6]	A	6-350	12-2/0	40, 21	
	Lever	OH/UG	—	22 kA	QC816F200SL [7] [11] [12]	1	QOM2200VH [9]	200 A	8	16	8	200 A	A	6-350	8-2/0	74 / 12	
<b>Ringless, Homeline™</b>																	
<b>Surface Mount Only</b>																	
125 A	None	OH/UG	—	10 kA	RC8L125S [14]	4	HOM	125 A [15]	—	—	—	—	A	6-2/0	6-2/0	27, 32	
200 A	None	OH/UG	—	10 kA	RC12L200S obs	6	HOM	200 A [6]	—	—	—	—	A	6-350	8-2/0	43, 21	

[1] To order branch circuit breakers, see QO Plug-On Circuit Breakers, page 1-3  
 [2] To order hubs, see Accessories and Hubs for CSEDs, page 1-45  
 [3] To order service disconnects, see Circuit Breakers for CSEDs, page 1-44 except as noted)  
 [4] Use only 15-110 A and 150-200 A breakers.  
 [5] Suitable for OH service with addition of tunnel kit (SCTK20). Order separately.  
 [6] Use only 15-100 A and 150-200 A circuit breakers.  
 [7] Supplied with load side feed-thru lugs, for 4 AWG-250 kcmil (Al/Cu) conductors.  
 [8] Convertible to semiflush with SC200F flange kit (order separately).  
 [9] Service disconnect supplied factory-installed.  
 [10] A 100 A circuit breaker can be installed in bottom position only, all other positions are limited to 70 A max.  
 [11] Device supplied with barrel lock provisions factory-installed.  
 [12] 5th jaw factory-installed.  
 [13] Use only 15-100 A and 150 A circuit breakers.  
 [14] Knockout provided in cover for use with barrel lock kit SCBRLOCK (see Accessories).  
 [15] 125 A Homeline™ 2P circuit breaker can be installed in top position only. All other positions are limited to 100 A max.



**Table 1.82 Rainproof Meter Mains (cont'd.)**

Ampere Rating	Bypass Type	Service (Type of Feed)		Short Circuit Current Rating	Cat. No.	Service Disconnect(s)			Load Center and Branch Circuit Breakers (Order separately [16])				Hub Type (Order separately [17])	Line Side Main Lugs AWG/kcmil (Al/Cu)	Service Ground Lug AWG/kcmil (Al/Cu)	Weight Each (Lbs) and Pallet Qty.	
		UL	UL and EU-SERC			2P Circuits (Max.)	Type (Order separately [18])	Ampere Rating Max.	Max. Quantity		Ampere Rating Max.						
									Spaces	Circuits		Tandems					
200 A	None	OH/UG	—	22 kA	RC12L200C [19]	6	HOM	200 A [20]	—	—	—	—	A	6-350	12-2/0	40, 21	
<b>Surface Mount Only, Supplied with Feed-Thru Lugs and provisions for Branch Circuit Breakers</b>																	
100 A	Horn	OH/UG	—	22 kA	RC816F100SH [21] [19] [22]	1	QOM2100VH [23]	100 A	8	16	8	100 A	A	6-350	8-2/0	43, 21	
100 A	Horn	OH/UG	—	22 kA	RC816F125SH OBS RC816F100CH [21] [19] [22]	1	QOM2100VH [23]	100 A	8	16	8	100 A			12-2/0	40, 21	
125 A	Horn	OH/UG	—	22 kA	RC816F125SH OBS	1	QOM2125VH [23]	125 A	8	16	8	100 A			8-2/0	43, 21	
125 A	Horn	OH/UG	—	22 kA	RC816F125CH [21] [19]	1	QOM2125VH [23]	125 A	8	16	8	100 A			12-2/0	40, 21	
150 A	None	OH/UG	—	22 kA	RC816F150S [21] [19]	1	QOM2150VH [23]	150 A	8	16	8	150 A [24]			8-2/0	43, 21	
	None	OH/UG	—	22 kA	RC816F150C [21] [19]	1	QOM2150VH [23]	150 A	8	16	8	150 A [24]			12-2/0	40, 21	
	Horn	OH/UG	—	22 kA	RC816F150SH [21] [19] [22]	1	QOM2150VH [23]	150 A	8	16	8	150 A [24]			8-2/0	43, 21	
	Horn	OH/UG	—	22 kA	RC816F150CH [21] [19] [22]	1	QOM2150VH [23]	150 A	8	16	8	150 A [24]			12-2/0	40, 21	
	Lever	OH/UG	—	22 kA	RC816F150SL [19] [22] [25]	1	QOM2150VH [23]	200 A	8	16	8	150 A			8-2/0	72 / 12	
200 A	None	OH/UG	—	22 kA	RC816F200S [21] [19] [22]	1	QOM2200VH [23]	200 A	8	16	8	200 A [20]			8-2/0	43, 21	
	None	OH/UG	—	22 kA	RC816F200C [21] [19]	1	QOM2200VH [23]	200 A	8	16	8	200 A [20]			12-2/0	40, 21	
	Horn	OH/UG	—	22 kA	RC816F200SH OBS	1	QOM2200VH [23]	200 A	8	16	8	200 A [20]			8-2/0	43, 21	
	Horn	OH/UG	—	22 kA	RC816F200CH [21] [19] [22]	1	QOM2200VH [23]	200 A	8	16	8	200 A [20]			12-2/0	40, 21	
	Lever	OH/UG	—	22 kA	RC816F200SL [21] [19] [22] [25]	1	QOM2200VH [23]	200 A	8	16	8	200 A			8-2/0	72 / 12	
200 A	Horn	OH/UG	—	10 kA	RC816D200CH [26] [21] [22] [27]	1	HOM2200 [23]	200 A	8	16	8	100 A [28]			6-300	6-1/0	48, 18
								50 A									

OBS This product is obsolete.

[16] To order branch circuit breakers, see *QO Plug-On Circuit Breakers*, page 1-3  
 [17] To order hubs, see *Accessories and Hubs for CSEDs*, page 1-45  
 [18] To order service disconnects, see *Circuit Breakers for CSEDs*, page 1-44 except as noted)  
 [19] Device supplied with barrel lock provisions factory-installed.  
 [20] Use only 15-100 A and 150-200 A circuit breakers.  
 [21] Supplied with load side feed-thru lugs, for 4 AWG-250 kcmil (Al/Cu) conductors.  
 [22] 5th jaw factory-installed.  
 [23] Service disconnect supplied factory-installed.  
 [24] Use only 15-100 A and 150 A circuit breakers.  
 [25] Suitable for load wires to exit top endwall with addition of Tunnel Kit OHBL, see *Table 1.89 Accessories*, page 1-45, check with local utility for approval.  
 [26] Convertible to semiflush with SC200F flange kit (order separately).  
 [27] Knockout provided in cover for use with barrel lock kit SCBRLLLOCK (see Accessories).  
 [28] A 100 A circuit breaker can be installed in bottom position only, all other positions are limited to 70 A max.

Meter Mains and All-In-Ones (100 to 225 A Maximum)

- Ring or ringless type meter socket designs available
- UL Listed, suitable only for use as service equipment
- Meets EUSERC standards
- Service disconnect(s) are supplied factory-installed, except where noted
- Semiflush-reverse design available, supplied with load center (indoor access)
- Supplied with 100% branch neutrals, all unused terminals may be used for equipment grounding wires.
- Meets Federal Specification W-P-115c as Type 1, Class 2

Table 1.83: All-In-One Combination Service Entrance Devices

Ampere Rating	Bypass Type	Service (Type of Feed) UL and EUSERC	Short Circuit Current Rating	Cat. No. (DE3A)	Service Disconnect(s)			Load Center and Branch Circuit Breakers (Order separately [29])				Hub Type [30] (Order separately)	Line Side Main Lugs AWG/kcmil (Al/Cu)	Service Ground Lug AWG/kcmil (Al/Cu)	Weight Each (Lbs) and Pallet Qty.			
					2P Circuits (Max.)	Type (Factory Installed)	Ampere Rating Max.	Max. Quantity	1P		Ampere Rating Max.							
									Circuits	Tan-dems								
<b>Ring Type, Homeline™</b>																		
<b>Surface Mount Only</b>																		
100 A	None	OH/UG	10 kA	SC1624M100S	1	HOM2100	100 A	16	24	8	100 A	A	6-2/0	6-2/0	32, 24			
125 A	None	OH/UG	10 kA	SC1624M125S	1	HOM2125	125 A	16	24	8	125 A [31]	A	6-2/0	6-2/0	32, 24			
200 A	None	OH/UG	10 kA	SC2040M200C [32]	1	HOM2200	200 A	20	40	20	100 A	A or A-L	6-300	8-1/0	47, 18			
200 A	None	UG	10 kA	SU2040M200C OBS	1	HOM2200	200 A	20	40	20	100 A	A or A-L	6-300	8-1/0	47, 18			
<b>Semiflush Mount Only</b>																		
100 A	None	OH/UG	10 kA	SC1624M100F	1	HOM2100	100 A	16	24	8	100 A	A or B30-0	6-2/0	6-2/0	44, 20			
125 A	None	OH/UG	10 kA	SC1624M125F	1	HOM2125	125 A	16	24	8	110 A	A or B30-0	6-2/0	6-2/0	44, 20			
<b>Surface Mount Only</b>																		
100 A	None	OH[33]	10 kA	SO1020M100S	1	HOM2100	100 A	10	20	10	80 A	A	6-1	8-4	20, 42			
200 A	None	OH[33]	22 kA	SO2040M200S	1	QOM2200VH	200 A	20	40	20	200 A	A	6-350	8-2/0	43, 21			
<b>REVERSE All-In-One—Semiflush Mount with Service Disconnect (outdoor access) and Load Center (indoor access)</b>																		
200 A	None	UG	10 kA	SU3040M200R OBS	1	QOM2200VH	200 A	30	40	10	200 A [34]	A or B30-0	6-300	12-1/0	60, 15			
225 A	None	UG	10 kA	SU3040M225R OBS	1	QOM2225VH	225 A											
<b>Ringless, Homeline</b>																		
<b>Surface Mount Only</b>																		
100 A	None	OH/UG	10 kA	RC1624M100S	1	HOM2100	100 A	16	24	8	100 A	A	6-2/0	6-2/0	32, 24			
125 A		OH/UG [33]		RC1624M125S OBS	1	HOM2125	125 A				125 A [31]							
125 A	Horn	OH/UG[33]	22 kA	RC2040M125CH [35]/[36]	1	QOM2125VH	125 A	20	40	20	125 A	A	6-300	8-1/0	40, 21			
150 A		OH/UG[33]		RC2040M150SH [35]	1	QOM2150VH	150 A				150 A				43, 21			
	150 A	Horn	OH/UG[33]	22 kA	RC2040M150CH [35]/[36]	1	QOM2150VH	150 A	20	40	20	150 A	A	6-300	8-2/0	40, 21		
OH/UG[33]			RC3040M150SL [37]		1	QOM2150VH [31]	200 A	30				40				10	150 A	76 / 12
200 A	None	OH/UG[33]	22 kA	RC2040M200S [35]	1	QOM2200VH	200 A	20	40	20	200 A	A	6-300	8-2/0	43, 21			
		OH/UG[33]		RC2040M200C [35]	1	QOM2200VH	200 A				20				40	20	200 A	40, 21
		OH/UG[33]		RC2040M200SH OBS	1	QOM2200VH	200 A				20				40	20	200 A	43, 21
		OH/UG[33]		RC2040M200CH [35]	1	QOM2200VH	200 A				20				40	20	200 A	40, 21
		OH/UG[33]		RC3040M200SL [37]	1	QOM2200VH [31]	200 A				30				40	10	200 A	76 / 12
		OH/UG[33]		RC2040M200CGP	1	QOM2200VH	200 A				20				40	20	200 A	48 / 21
<b>Ringless, QO</b>																		
<b>Surface Mount Only</b>																		
150 A	Horn	OH/UG[33]	22 kA	QC2442M150SH OBS	1	QOM2150VH	150 A	24	42	18	150 A	A	6-350	8-2/0	43, 21			
200 A		None		OH/UG[33]	QC2442M200S OBS	1	QOM2200VH				200 A				24	42	18	200 A
	200 A	None	OH/UG[33]	22 kA	QC2442M200C [35]	1	QOM2200VH	200 A	24	42	18	200 A	A	6-350	8-2/0	40, 21		
OH/UG[33]			QC2442M200SH [35]		1	QOM2200VH	200 A	24				42				18	200 A	43, 21
200 A	None	OH/UG[33]	22 kA	QC2442M200CH [35]/[36]	1	QOM2200VH	200 A	24	42	18	200 A	A	6-350	8-2/0	40, 21			
		OH/UG[33]		QC3040M200S	1	QOM2200VH	200 A				30				40	10	200 A	40, 21
200 A	Horn	OH/UG[33]	22 kA	QC3040M200SH	1	QOM2200VH	200 A	30	40	10	200 A	A	6-350	8-2/0	40, 21			

OBS This product is obsolete.

[29] To order branch circuit breakers, see QO Plug-On Circuit Breakers, page 1-3  
 [30] To order hubs, see Accessories and Hubs for CSEDs, page 1-45  
 [31] 125 A Homeline™ 2P circuit breaker can be installed in top position only. All other positions are limited to 100 A max.  
 [32] Convertible to semiflush with SC200F flange kit (order separately).  
 [33] Device does not meet EUSERC Specifications.  
 [34] Use only 15-110 A and 150-200 A circuit breakers.  
 [35] Device supplied with barrel lock provisions factory-installed.  
 [36] 5th jaw factory-installed.  
 [37] Suitable for load wires to exit top endwall with addition of Tunnel Kit OHBL, (see Table 1.89 Accessories, page 1-45, check with local utility for approval.

**Energy Center**

Ampere Rating	Bypass Type	Service (Type of Feed)		Short Circuit Current Rating	Cat. No.	Service Disconnect(s)			Load Center and Branch Circuit Breakers (Order separately [38])				Hub Type (Order separately [39])	Line Side Main Lugs AWG/ kcmil (Al/ Cu)	Service Ground Lug AWG/ kcmil (Al/Cu)	Weight Each (Lbs) and Pallet Qty.
		UL	UL and EU-SERC			2P Circuits (Max.)	Type (Order separately [40])	Ampere Rating (Max.)	Max. Quantity			Ampere Rating Max.				
									Spaces	Circuits	Tandems					
<b>Square D™ Energy Center</b>																
<b>Semi-flush Mount Only</b>																
200 A		UG		22 kA	QOWC60M200PFY		QOM2[41]	200 A	60 [4-2]	61	10	200 A	A30-0L	6—250	14—2/0	116,2

LOAD CENTERS  
1

[38] To order branch circuit breakers, see [QO Plug-On Circuit Breakers](#), page 1-3  
 [39] To order hubs, see [Accessories and Hubs for CSEDs](#), page 1-45  
 [40] To order service disconnects, see [Circuit Breakers for CSEDs](#), page 1-44 except as noted)  
 [41] One service disconnect with 2 — 110 A sub-main feeds.  
 [42] Nine spaces are used for factory-installed components, leaving 51 available spaces for branch circuits.

Meter Mains and All-in-Ones (300–400 A Devices)

Meter Mains and All-in-Ones

- Ring or ringless type meter socket designs available
- UL Listed, suitable **only** for use as service equipment
- Meets EUSERC standards where indicated.

- Service disconnects are supplied factory-installed, except where noted
- Supplied with 100% branch neutrals; all unused terminals may be used for equipment grounding wires
- Meets Federal Specification W-P-115c as Type 1, Class 2

**Meter Mains:** Meets Federal Specification W-P-115c as Type 1, Class 2, UL Listed, suitable only for use as service equipment, 120/240 Vac, 1Ø3W, NEMA 3R Enclosure

Table 1.84: Meter Mains

Ampere Rating	Bypass Type	Service (Type of Feed)		Short Circuit Current Rating	Cat. No.	Service Disconnect(s) [43]			Load Center and Branch Circuit Breakers (Order separately [44])				Line Side Main Lugs AWG/ kcmil (Al/Cu)	Service Ground Lug AWG/ kcmil (Al/Cu)	Weight Each (Lbs) and Pallet Qty.	
		UL	UL and EUSERC			2P Circuits (Max.)	Type (Order separately [46])	Ampere Rating (Max.)	Max. Quantity			Hub Type (Order separately [45])				
									Spaces	Circuits	Tandems					
<b>Ring Type, QO</b>																
<b>Surface and Semiflush Mount [43]</b>																
400 A	None	UG	UG	25 kA	CU12L400CN [47]	1	QDL22200 [48]	200 A	—	—	—	—	A-L	(2) Studs	4–250	98, 4
400 A	Class 320 Manual Bypass	UG	—	25 kA	CU12L400CB [47] [49]	1	QDL22200 [48]	200 A	—	—	—	—	A-L	(2) Studs	4–250	98, 4
					CU12L400FB OBS	1	QDL, QGL, QJL [50]	200 A	—	—	—	—				
400 A	Class 320 Manual Bypass	UG	—	25 kA	CU816D400CN [47] [53]	1	QDL22200 [48]	200 A	8	16	8	200 A	A-L	(2) Studs	4–250	98, 4
					CU816D400CB [47] [52] [49]		QDL, QGL, QJL [50]									
400 A	Class 320 Manual Bypass	UG	—	65 kA [43]	CUM400CB [47] [49]	1	LJL36400U31X [48]	400 A	—	2 [54]	—	200 A	A-L	(2) Studs	4–250	115, 4
<b>Ringless Type, QO</b>																
400 A	Class 320 Lever	UG	—	25 kA	QU12L400SL [55] [49]	1	QDL22200 [48]	200 A	—	—	—	—	A-L	(2) Studs	4–250	98, 4
400 A	Class 320 Lever	UG	—	25 kA	QU12L400SL [55] [49]	1	QDL, QGL, QJL [50]	200 A	—	—	—	—				
						4	QO, QO-VH or QOH [51]	125 A [52]	—	—	—	—				
<b>Surface Mount Only, Supplied with Feed-Thru Lugs and Provisions for Branch Circuit Breakers</b>																
400 A	[56]	UG	—	25 kA	QU816D400SL [52] [55] [49]	1	QDL22200 [48]	200 A	8	16	8	200 A	A-L	(2) Studs	4–250	98, 4
<b>Surface and Semiflush Mount [43]</b>																
400 A	Class 320 Lever	UG	—	25 kA	QU12L400CL [55] [57] [49]	1	QDL22200 [48]	200 A	—	—	—	—	A-L	(2) Studs	4–250	98, 4
						1	QDL, QGL, QJL [50]	200 A	—	—	—	—				
400 A	Class 320 Lever	UG	—	25 kA	QU816D400CL [55] [52] [57] [49]	1	QDL22200 [48]	200 A	8	16	8	200 A	A-L	(2) Studs	4–250	98, 4
					QU816D400FL OBS	1	QDL, QGL, QJL [50]	—	—	—	—					
400 A	Class 320 Lever	UG	—	65 kA [43]	QUM400CL [55] [49]	1	LJL36400U31X [48]	400 A	—	2 [54]	—	200 A	A-L	(2) Studs	4–250	120, 4
400 A	K-4 Bolt-On	UG	—	65kA [43]	QUM400CK OBS	1	LJL36400U31X [48]	400 A	—	2 [54]	—	200 A	A-L	(2) Studs	4–250	123, 4

OBS This product is obsolete.

[43] UL short circuit current rating is equal to the lowest interrupting rating of any circuit breaker installed.  
 [44] To order branch circuit breakers, see QO Plug-On Circuit Breakers, page 1-3  
 [45] To order hubs, see Accessories and Hubs for CSEDs, page 1-45  
 [46] To order service disconnects, see Circuit Breakers for CSEDs, page 1-44 except as noted)  
 [47] For use only on 120/240 Vac 1Ø3W system (4-jaw meter socket).  
 [48] Service disconnect supplied factory-installed.  
 [49] Device configuration is not included in EUSERC standards. Consult applicable utility for acceptance.  
 [50] Additional service disconnect for field-installation: order prefix QBL at 10 kA, QDL at 25 kA, QGL at 65 kA, or QJL at 100 kA. Order separately. For complete circuit breaker catalog number, see Digest Section 7.  
 [51] Order two pole circuit breakers for field installation: order catalog designation QO for 10 kA, QO-VH for 22 kA or QOH for 42 kA short circuit current rating. See Table 1.1 Plug-On Circuit Breakers, page 1-3 or Table 1.88 Circuit Breakers for use with Meter Mains and All-In-One Devices, page 1-44.  
 [52] QO panel is rated 200 A maximum.  
 [53] Supplied with load side feed-thru lugs for 6 AWG–250 kcmil (Al/Cu) conductors.  
 [54] Option for field installation of two Q-frame, 200 A max. 2-pole branch circuit breakers used as mains for two downstream load centers. Purchase installation kit BMK2Q400 and two Q-frame circuit breakers separately. Order QBL prefix at 10 kA, QDL prefix at 25 kA, or QGL prefix at 65 kA.  
 [55] Fifth jaw factory-installed.  
 [56] Device with suffix L has Class 320 lever bypass and device with suffix K has a K-4 bolt-on, no bypass.  
 [57] Knockout provided in cover for use with barrel lock kit SCBRLOCK (see Table 1.89 Accessories, page 1-45).

**Table 1.85: All-in-One Combination Service Entrance Devices**

Surface and Semiflush Mount <sup>[58]</sup>																
Ring Type, Homeline																
300 A	Class 320 Manual	UG	—	25 kA	SU3040D300CB <sup>[59]</sup> / <sub>[60]</sub> <sup>[61]</sup>	1	QDL22200 <sup>[62]</sup> QDL, QGL, QJL <sup>[63]</sup>	200 A 100 A	30	40	10	200 A	A–L	(2) Studs	4–250	100, 4
					SU3040D300FB <sup>[59]</sup> / <sub>[60]</sub> <sup>[61]</sup>											
400 A	None	UG	UG	25 kA	SU3040D400CN <sup>[59]</sup> <sup>[60]</sup>	1	QDL22200 <sup>[62]</sup> QDL, QGL, QJL <sup>[63]</sup>	200 A 200 A	30	40	10	200 A	A–L	(2) Studs	4–250	100, 4
					SU3040D400FN <sup>[59]</sup> / <sub>[60]</sub> <sup>[61]</sup>											
400 A	Class 320 Manual	UG	—	25 kA	SU3040D400CB <sup>[59]</sup> / <sub>[60]</sub> <sup>[61]</sup>	1	QDL22200 <sup>[62]</sup>	200 A	30	40	10	200 A	A–L	(2) Studs	4–250	100, 4
					SU3040D400FB <sup>[59]</sup> / <sub>[60]</sub> <sup>[61]</sup>											
Ringless, Homeline																
400 A	Class 320 Lever	UG	—	25 kA	RU3040D400CL <sup>[60]</sup> / <sub>[64]</sub> <sup>[61]</sup>	1	QDL22200 <sup>[62]</sup>	200 A	30	40	10	200 A	A–L	(2) Studs	4–250	100, 4
					RU3040D400FL <sup>[60]</sup> / <sub>[64]</sub> <sup>[61]</sup>											
400 A	K-4 Bolt-on	UG	—	25 kA	RU3040D400CK <sup>[60]</sup> <sup>[61]</sup>	1	QDL22200 <sup>[62]</sup> QDL, QGL, QJL <sup>[63]</sup>	200 A 200 A	30	40	10	200 A	A–L	(2) Studs	4–250	100, 4
					RU3040D400FK <sup>obs</sup>											

<sup>obs</sup> This product is obsolete.

<sup>[58]</sup> UL short circuit current rating is equal to the lowest interrupting rating of any circuit breaker installed.

<sup>[59]</sup> For use only on 120/240 Vac 1Ø3W system (4-jaw meter socket).

<sup>[60]</sup> Knockout provided in cover for use with barrel lock kit SCBRLLOCK (see Accessories).

<sup>[61]</sup> Device configuration is not included in EUSERC standards. Consult applicable utility for acceptance.

<sup>[62]</sup> Service disconnect supplied factory-installed.

<sup>[63]</sup> Additional service disconnect for field-installation: order prefix QBL at 10 kA, QDL at 25 kA, QGL at 65 kA, or QJL at 100 kA. Order separately. For complete circuit breaker catalog number, see Digest Section 7.

<sup>[64]</sup> 5th jaw factory-installed.

Dimensions for CSEDs

Table 1.86: Knockouts

Symbol	A	B	C	D	E	F	G	H	I	J
Conduit Size (in.)	1/2	3/4	1	1-1/4	1-1/2	2	2-1/2	3	3-1/2	4

- ▲ Drip hood supplied factory-installed and is required for surface mount installation. For semi-flush installation, remove drip hood and install flange kit SC200F (order separately).
- Unit supplied with blank top endwall (factory-installed) for surface mount installation. For semi-flush installation, install flange kit FK400 (order separately). Kit includes replacement top endwall (with knockouts) and flanges.
- ◆ Unit supplied with semi-flush top endwall factory installed and semi-flush flanges factory included.

LOAD CENTERS

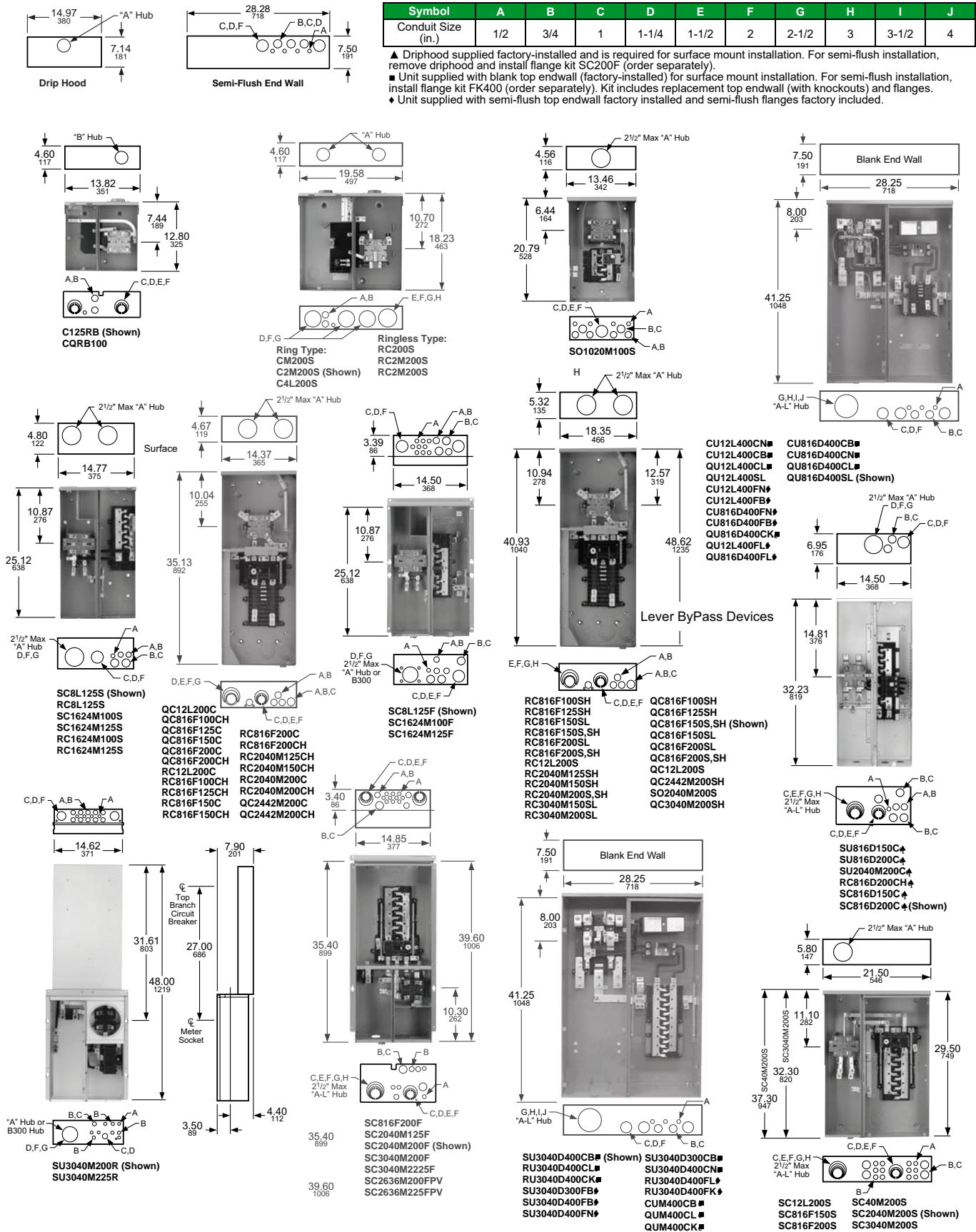

**Solar Ready PoN CSEDs**

- Ring or ringless type meter socket designs available
- UL Listed, suitable only for use as service equipment
- Service disconnect(s) are supplied factory-installed, except where noted
- Interiors accept plug-on neutral and pigtail style branch circuit breakers
- Supplied with a fully distributed neutral bar, all unused terminals may be used for equipment grounding wires
- Meets Federal Specification W-P-115c as Type 1, Class 2
- Solar ready kits for line side tap available, see accessories table
- All devices have a 3" KO in the bottom endwall
- Provisions for field installed CTs on All devices

Amperage Rating	Bus Bar Ampere Rating	Bypass type	Service (Type of Feed)	Short Circuit Current Rating	Cat. No.	Service Disconnect(s)						Load Center and Branch Circuit Breakers (Order separately pages....)				Hub Type	Line Side Main Lugs	Service Ground Lug
						2P Circuits	Type (Factory installed except where noted)	Spaces	Circuits	Tandems	Ampere Rating Max.	Spaces	Circuits	Tandems	Ampere Rating Max.			
<b>Ring Type, QO</b>																		
Surface Mount Only																		
100 A	225 A	None	UG	22 kA	CU816F100PS <sup>[1][2]</sup>	1	QOM2100VH	8	16	8	70 A	A-L	4-250	14-2/0 CU 12-2/0 AL				
200 A		None	UG	22 kA	CU48F200PS <sup>[1][2]</sup>	1	QOM2200VH	4	8	4	110 A							
200 A		None	UG	22 kA	CU816F200PS <sup>[1][2]</sup>	1	QOM2200VH	8	16	8	110 A							
<b>Ring Type, Homeline</b>																		
Surface Mount Only																		
100 A	225 A	None	UG	22 kA	SU816F100PS <sup>[1][2]</sup>	1	QOM2100VH	8	16	8	70 A	A-L	4-250	14-2/0 CU 12-2/0 AL				
200 A		None	UG	22 kA	SU48F200PS <sup>[1][2]</sup>	1	QOM2200VH	4	8	4	110 A							
200 A		None	UG	22 kA	SU816F200PS <sup>[1][2]</sup>	1	QOM2200VH	8	16	8	110 A							
150 A		None	OH/UG	22 kA	SC816F150PS <sup>[1][2]</sup>	1	QOM2150VH	8	16	8	150 A			8-2/0				
200 A		None	OH/UG	22 kA	SC816F200PS <sup>[1][2]</sup>	1	QOM2200VH	8	16	8	200 A							
200 A		None	OH/UG	22 kA	SC2040M200PS <sup>[2]</sup>	1	QOM2200VH	20	40	20	200 A							
200 A		None	OH/UG	22 kA	SC3042M200PS <sup>[2]</sup>	1	QOM2200VH	30	42	12	200 A							
200 A		None	OH/UG	22 kA	SC42M200PS <sup>[2]</sup>	1	QOM2200VH	42	42	0	200 A							
200 A		None	OH/UG	22 kA	SC816F200PF <sup>[1][2]</sup>	1	QOM2200VH	8	16	8	200 A							
<b>Semiflush Mount Only</b>																		
200 A	225 A	None	OH <sup>[3]</sup> /UG	22 kA	SC2040M125PF <sup>[2]</sup>	1	QOM2125VH	20	40	20	110 A	A-L	4-250	8-2/0				
200 A		None	OH <sup>[3]</sup> /UG	22 kA	SC2040M200PF <sup>[2]</sup>	1	QOM2200VH	20	40	20	200 A							
200 A		None	OH <sup>[4]</sup> /UG	22 kA	SC3042M200PF <sup>[2]</sup>	1	QOM2200VH	30	42	12	200 A							
225 A		None	OH <sup>[4]</sup> /UG	22 kA	SC3042M225PF <sup>[2]</sup>	1	QOM2225VH	30	42	12	200 A							
<b>Ringless, QO</b>																		
Surface Mount Only																		
100 A	225 A	None	UG	22 kA	QU48F100PS <sup>[1]</sup>	1	QOM2100VH	4	8	4	70 A	A-L	4-250	14-2/0 CU 12-2/0 AL				
100 A		Lever	UG	22 kA	QU48F100PSL <sup>[1]</sup>	1	QOM2100VH	4	8	4	70 A							
125 A		None	UG	22 kA	QU48F125PS <sup>[1]</sup>	1	QOM2125VH	4	8	4	70 A							
150 A		None	UG	22 kA	QU48F150PS <sup>[1]</sup>	1	QOM2150VH	4	8	4	110 A							
200 A		None	UG	22 kA	QU48F200PS <sup>[1]</sup>	1	QOM2200VH	4	8	4	110 A							
150 A		None	UG	22 kA	QU816F150PS <sup>[1]</sup>	1	QOM2150VH	8	16	8	110 A							
200 A		None	UG	22 kA	QU816F200PS <sup>[1]</sup>	1	QOM2200VH	8	16	8	110 A							
200 A		Lever	UG	22 kA	QU816F200PSL <sup>[1]</sup>	1	QOM2200VH	8	16	8	110 A							
200 A		None	UG	22 kA	QU816M200PS	1	QOM2200VH	8	16	8	110 A							
<b>Ringless, Homeline</b>																		
Surface Mount Only																		
100 A	225 A	None	UG	22 kA	RU48F100PS <sup>[1]</sup>	1	QOM2100VH	4	8	4	70 A	A-L	4-250	14-2/0 CU 12-2/0 AL				
100 A		Lever	UG	22 kA	RU48F100PSL <sup>[1]</sup>	1	QOM2100VH	4	8	4	70 A							
125 A		None	UG	22 kA	RU48F125PS <sup>[1]</sup>	1	QOM2125VH	4	8	4	70 A							
150 A		None	UG	22 kA	RU48F150PS <sup>[1]</sup>	1	QOM2150VH	4	8	4	110 A							
200 A		None	UG	22 kA	RU48F200PS <sup>[1]</sup>	1	QOM2200VH	4	8	4	110 A							
150 A		None	UG	22 kA	RU816F150PS <sup>[1]</sup>	1	QOM2150VH	8	16	8	110 A							
200 A		None	UG	22 kA	RU816F200PS <sup>[1]</sup>	1	QOM2200VH	8	16	8	110 A							
200 A		Horn	UG	22 kA	RU816F200PSH <sup>[1]</sup>	1	QOM2200VH	8	16	8	110 A							
200 A		Lever	UG	22 kA	RU816F200PSL <sup>[1]</sup>	1	QOM2200VH	8	16	8	110 A							
200 A		None	UG	22 kA	RU816M200PS	1	QOM2200VH	8	16	8	110 A							

**Table 1.87: Knockouts**

Symbol	A	B	C	D	E	F	G	H	I	J
Conduit Size (in.)	1/2	3/4	1	1-1/4	1-1/2	2	2-1/2	3	3-1/2	4

[1] Supplied with load side feed-thru lugs, for 4AWG-250 kcmil Al/Cu conductors.  
 [2] Meets EUSERC requirements.  
 [3] Suitable for OH service with addition of tunnel kit (SCTKP20). Check with local utility for approval and order separately.  
 [4] Suitable for OH service with addition of tunnel kit (SCTKP30). Check with local utility for approval and order separately.

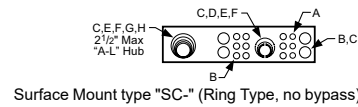
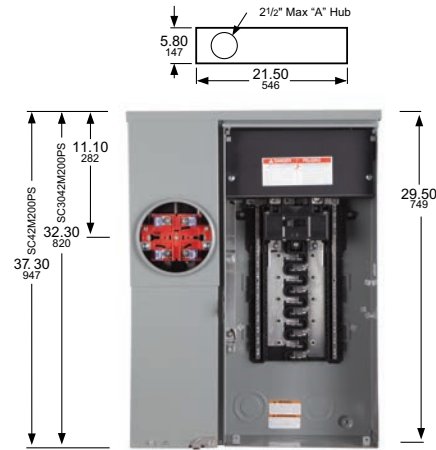
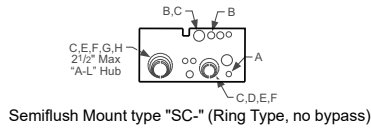
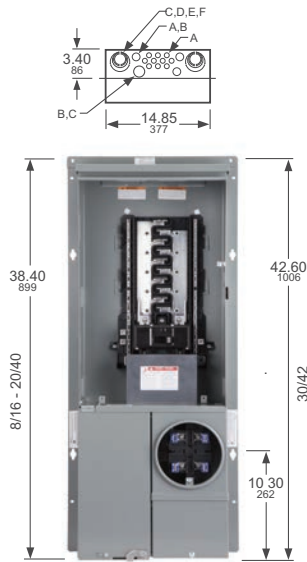

NOTE: See each catalog number's associated technical drawing online for additional dimensions and enclosure details.

Circuit Breakers for CSEDs

Table 1.88: Circuit Breakers for use with Meter Mains and All-In-One Devices

Ampere Rating [5]	Type: HOM, 1P	Type: HOM, 2P	Type: QO, 1P	Type: QO, 2P	Type: QO-VH, 1P	Type: QO-VH, 2P
	Cat. No. (DE3D)	Cat. No. (DE3D)	Cat. No. (DE2A)	Cat. No. (DE2A)	Cat. No. (DE2A)	Cat. No. (DE2A)
10	—	—	QO110	—	—	—
15	HOM115	—	QO115	—	QO115VH	—
20	HOM120	—	QO120	—	QO120VH	—
25	HOM125	—	QO125	—	QO125VH OBS	—
30	HOM130	HOM230	QO130	QO230	QO130VH	QO230VH
35	—	HOM235	QO135	QO235	—	—
40	HOM140	HOM240	QO140	QO240	—	QO240VH
45	—	HOM245	QO145 OBS	QO245	—	—
50	HOM150	HOM250	QO150	QO250	—	QO250VH
60	—	HOM260	QO160	QO260	—	QO260VH
70	—	HOM270	QO170	QO270	—	QO270VH
80	—	HOM280	—	QO280	—	QO280VH
90	—	HOM290	—	QO290	—	QO290VH
100	—	HOM2100	—	QO2100	—	QO2100VH
110	—	HOM2110	—	QO2110	—	QO2110VH
125	—	HOM2125	—	QO2125	—	QO2125VH
150	—	HOM2150BB	—	QO2150	—	QO2150VH
175	—	HOM2175BB	—	QO2175	—	QO2175VH OBS
200	—	HOM2200BB	—	QO2200	—	QO2200VH

OBS This product is obsolete.

Ampere Rating [5]	Type: QOM1-VH, 2P	Type: QOM2-VH, 2P	Type: QDL, 2P [6]
	Cat. No. (DE3D)	Cat. No. (DE3D)	Cat. No. (DE2A)
50	QOM50VH [7]	—	—
60	QOM60VH	—	—
70	QOM70VH	—	QDL22070
80	QOM80VH	—	QDL22080
90	QOM90VH	—	QDL22090
100	QOM100VH	QOM2100VH	QDL22100
110	QOM110VH	—	QDL22110
125	QOM125VH	QOM2125VH	QDL22125
150	—	QOM2150VH	QDL22150
175	—	QOM2175VH	QDL22175
200	—	QOM2200VH	QDL22200
225	—	QOM2225VH	—

[5] Do not exceed mains rating of device

[6] For additional interrupting rating circuit breakers, order circuit breaker prefix QBL at 10 kA, QGL at 65 kA or QJL at 100 kA.

[7] Reference National Electrical Code Article 230-79.



**Accessories and Hubs for CSEDs**

**Table 1.89: Accessories**

Description	Cat. No.
Generator Kit: Interlocks main service disconnect and generator circuit breaker (order separately). For : Homeline™ CSED Devices RC816F-, RC2040M-, SO2040M- containing suffix -C or -CH QO CSED Devices QC816F-, QC2442M- containing suffix -C or -CH	RCGK2 QCGK3
Backfed inverter circuit breaker retaining kit for SC2636M225FPV	PK2SCPV <sup>Obs</sup>
<b>Fifth Jaw Kit for:</b> Meter Main Types: C, RC, SC, QC All-In-One Types: SC, SU (100–225 A), QC, RC, SO	5J
Bypass (Horn Type) for Ringless Type Meter Mains and All-In-Ones (100–200 A) (except for RC8L125S, RC1624M100S and RC1624M125S—use RCHB).	MMHB
Lexan Meter Socket Cover Plate for: Ring and Ringless Type Meter Mains Ring and Ringless Type All-In-Ones	29007
Meter Socket Sealing Rings for Ring Type Meter Mains and All-In-Ones: Snap Type Aluminum (Std.) Screw Type Aluminum Snap Type Stainless Steel	2920910001 29008W ARP00026
Anti-Inversion Kit . For use ONLY on 400 A Meter Mains and All-In-Ones with lever bypass.	MMLRK
Trim Kit for 2 in. X 6 in. stud wall, used with Reverse All-In-Ones, SU3040M200R, and SU3040M225R	SU2X6TRIM
Barrel Lock Kit (Barrel Lock not included), supplied with bracket and mounting screw, refer to listings for where used.	SCBRLLOCK
<b>Semiflush Flange Kit for:</b> Meter Mains: SC816D150/200C and RC816D200CH All-In-Ones: SC2040M200C	SC200F
Semiflush Flange Kit for ring- and ringless-type Meter Mains and All-In-Ones (400 A Only)	FK400
Lug Kit includes (4) lugs, for use with 2 AWG–600 kcmil Al/Cu conductors. Lugs are for standard 2-Hole mounting. Meter Main and All-In-One units supplied with (2) studs per phase and neutral will accept one lug per phase and neutral. Not for use on 400 A devices with "K" suffix.	C MELK4
Branch Circuit Breaker Field Installation Kit for two Q-Frame Circuit Breakers (QBL, QDL, or QGL, order separately). For CUM400CB, QUM400CL or QUM400CK - includes (2) mounting pans, (4) wires.	BMK2Q400
Overhead Feed Trough for 400 A ring- and ringless-type Meter Mains and All-In-Ones.	O CK400
Touch-Up Paint (ASA49 Gray)	PK49SP
Ground Bar Kit, Meter Mains and All-In-Ones QC, RC, and SC (100–225 A)	PK15GTA
<b>Filler Plate for:</b> Meter Main Types: QC, CU All-In-One Types: QC	QOFP
<b>Filler Plate for:</b> Meter Main Types: RC, SC All-In-One Types: SC, RC, SU	HOMFP
<b>Neutral Lug (6-2/0 AWG) for:</b> Meter Main Types: RC, SC, QC All-In-One Types: SC, SU, QC, RC	LK100AN
Overhead Barrier Tunnel Kit for Ringless & Horn Bypass in RC/QC Devices	OHBS <sup>Obs</sup>
Overhead Barrier Tunnel Kit for Lever Bypass RC/QC Devices	OHBL
Solar Ready Kit for Type SC Semiflush Mounted Solar Ready Devices (includes lugs and replacement UL67 barrier)	SR69064AF
Solar Ready Kit for Type SC Surface Mounted Solar Ready Devices (includes lugs and replacement UL67 barrier)	SR69064AS
Energy Center Manual Transfer Kit	QO2DTEC
Energy Center Hold-Down Bracket Kit	QOCRBGK2EC
Solar Ready Kit for UG 200 A Max Meter Mains	SRKUGMM
Generator Kit for RU- SU- 200 A Max Meter Mains	RUSUGK
Generator Kit for QU- CU- 200 A Max Meter Mains	QUCUGK

<sup>Obs</sup> This product is obsolete.

**Table 1.90: Hubs and Closing Plates**

Hub Series	Conduit Size (Inches)	Cat. No.	Disc. Sch.
Closing Plate for "A" Hub opening			
A	1.00	ACP	DE4
	1.25	A100	DE4
	1.50	A125	DE4
	2.00	A150	DE4
	2.50	A200	DE4
Adapter plate to allow use of "A" Hubs on "A-L" size hub openings			
Closing Plate for "A-L" Hub opening			
A-L	2.00	ACPL	DE4
	2.50	A200L [8]	DE4
	3.00	A250L	DE4
	3.50	A300L	DE4
	4.00	A350L	DE4
Closing Plate for "B" Hub opening			
B	0.75	BCAP	DE1A
	1.00	B075	DE1A
	1.25	B100	DE1A
	1.50	B125	DE1A
	2.00	B150	DE1A
	2.50	B200	DE1A
B300	3.00	B250	DE1A
		B300	DE1A

[8] Supplied with AAP adapter plate and "A" hub.

*New!*

**Wiser Energy™ Home Power Monitor**

Wiser Energy from Square D is an integral part of any smart home. With Wiser Energy, you can give your home a voice. It helps you keep tabs on your home by notifying you when devices are on or off in the home, and monitors home energy usage in real time, for a safer and more efficient home.



- Keep tabs on your home activity from anywhere
- Save money on your electric bill with live energy tracking
- Get notified with instant alerts of appliances left on or off
- Take control of your energy through smart device integration

More information can be found at: [Wiser Energy](https://www.se.com/us/en/home/offers/connected-home/wiser-energy/)

<https://www.se.com/us/en/home/offers/connected-home/wiser-energy/>

**Table 1.91: Wiser Energy**

Description	Contents	CT Rating	Catalog Number
Wiser Energy monitoring system intended for installation in new or existing 120 V split-phase residential panels; cETLus listed			
Wiser Energy Standard Disaggregation Monitoring	Monitoring hub, Main CTs	200 A	WISEREM
Wiser Energy Solar Disaggregation Monitoring	Monitoring hub, Main CTs, Solar CTs	200 A	WISEREMPV
Wiser Energy Solar add-on CT Kit	Solar CTs (hub purchased separately)	200 A	WISERCTPV
Wiser Energy CT extension cable - 4 ft.	Solar CTs (hub purchased separately)	N/A	WISEREMCTEXT4
Wiser Energy CT extension cable - 12 ft.			WISEREMCTEXT12
Wiser Energy CT extension cable - 25 ft.			WISEREMCTEXT25
Wiser Energy CT extension cable - 40 ft.			WISEREMCTEXT40

*New!*

**Dimmers, Switches, and Outlets**

Square D™ wiring devices continue to raise the bar on aesthetics, ease of installation, and connectivity.



**Square D X Series Wiring Devices**

The X Series connected products include wall switches and dimmers, socket outlets (receptacles), occupancy and humidity sensors, and media and network devices.

View the X Series products at <https://www.se.com/us/en/product-range/26420638>.

**Square D XD Series Cover Plates**

XD Series consists of a premium range of screwless wall cover plates and frames that mount easily on X Series switches and receptacles.

View the XD Series products at <https://www.se.com/us/en/product-range/38326871>.



**Service Entrance Devices**

**Table 1.92: Residential Enclosed Circuit Breakers with PowerPacT Q Frame MCBs**



Enclosure	Mains Rating	Short Circuit Rating	Commercial Reference	Included in Package
Rainproof NEMA 3R	150 A	25 kA	Q2150MRBE	Factory Installed: (1) QDL22150, (1) service entrance barrier, (1) emergency disconnect label & (1) service disconnect label
Rainproof NEMA 3R	200 A	25 kA	Q2200MRBE	Factory Installed: (1) QDL22200, (1) service entrance barrier, (1) emergency disconnect label & (1) service disconnect label
Rainproof NEMA 3R	70-200 A	10-100 kA	Q2200RBE [1]	Factory Installed: (1) emergency disconnect label & (1) service disconnect label Factory Included: (1) service entrance barrier[2]

**Table 1.93: Replacement Kit for Residential Enclosed Circuit Breakers with PowerPacT Q Frame**

Mains Rating	Short Circuit Rating	Commercial Reference	Included in Package
70 -200 A	10-100 kA	PKSB1Q2	(1) Service entrance barrier & (1) emergency disconnect label.[3]

**Table 1.94: PowerPacT Q-Frame Molded Case Circuit Breakers for Residential Enclosed Circuit Breakers**



Service	Type 3R — Rainproof Circuit Breaker not included	Ampere rating	Short Circuit Rating			
			10 k AIR	25 k AIR	65 k AIR	100 k AIR
2P 240 Vac Maximum	Q2200RBE	70 A	QBL22070	QDL22070	QGL22070	QJL22070
		80 A	QBL22080	QDL22080	QGL22080	QJL22080
		90 A	QBL22090	QDL22090	QGL22090	QJL22090
		100 A	QBL22100	QDL22100	QGL22100	QJL22100
		110 A	QBL22110	QDL22110	QGL22110	QJL22110
		125 A	QBL22125	QDL22125	QGL22125	QJL22125
		150 A	QBL22150	QDL22150	QGL22150	QJL22150
		175 A	QBL22175	QDL22175	QGL22175	QJL22175
		200 A	QBL22200	QDL22200	QGL22200	QJL22200

[1] Suitable ONLY for breakers from 70A-200A. Not compatible with 225A breakers.  
 [2] Suitable only for 2P Q Frame MCBs only.  
 [3] Suitable ONLY for breakers from 70A-200A. Not compatible with 225A breakers



QO200TRNM



QO3100BNF  
With Cover Removed

**1Ø3W—120/240 Vac—240 Vac—UL Listed**

**Table 1.95: Enclosed Molded Case Switch, Switch Included, Does NOT provide overcurrent protection**

Service	Ampere Rating	General Purpose	Rainproof	Box No. [4]
240 Vac	60 A[5] [6]	QO260NATS	QO200TR	2, 9R[7]
			QO200TRNM	1NM
			QO260NATR	1R
120/240 Vac	100 A[8]	QO2000NS	QO2000NRB	13, 10R

**Table 1.96: Enclosed GFCI Circuit Breakers, GFCI Circuit Breaker Included—10 kA Short Circuit Current Rating**

Service	Ampere Rating	Type 3R—Rainproof Circuit Breaker Included	Circuit Breaker Only	Box No. [4]
120/240 Vac	50 A	QOE250GF1NM	QO250GFI	1NM (Non-metallic) 1R (Metallic)
		HOME250SPA	HOM250GFI	
		QOE260GF1NM	QO260GFI3W	
	60 A			

**Table 1.97: 2-Pole Circuit Breaker Enclosures—22 kA Short Circuit Current Rating**

Service [9]	Ampere Rating	General Purpose [10]	Rainproof	Box No. [4]
120/240 Vac	100 A 125 A	QO2100BNF/S QO2125BNF/S	QO2100BNRB QO2125BNRB	13, 10R 18, 13R
240 Vac	100 A	QO3100BNF/S	QO3100BNRB	13, 10R
60A Max. Circuit Breaker Enclosures—10 kA Short Circuit Current Rating Circuit breaker not included. Order separately from <b>QO Plug-On Circuit Breakers</b> , page 1-3. Will not accept QO-GFI circuit breaker nor QO circuit breakers with factory-installed accessories.				
240 Vac	60 A[5]	—	QO2TR	9R[7]

**Table 1.98: Q Frame Enclosures and Q Frame Circuit Breakers**

Service	Enclosure Only [11]			Circuit Breaker (Order Separately)				
	Type 1—General Purpose [10]	Type 3R—Rainproof	Box No. [4]	Ampere Rating	10 k AIR	25 k AIR	65 k AIR	100 k AIR
<p>2P 240 Vac Maximum</p>	Q22200NS [12] or Q23225NF/S	Q22200NRB [12] or Q23225NRB	19, 11R 20, 12R	70 A	QBL22070	QDL22070	QGL22070	QJL22070
				80 A	QBL22080	QDL22080	QGL22080	QJL22080
				90 A	QBL22090	QDL22090	QGL22090	QJL22090
				100 A	QBL22100	QDL22100	QGL22100	QJL22100
				110 A	QBL22110	QDL22110	QGL22110	QJL22110
				125 A	QBL22125	QDL22125	QGL22125	QJL22125
				150 A	QBL22150	QDL22150	QGL22150	QJL22150
				175 A	QBL22175	QDL22175	QGL22175	QJL22175
				200 A	QBL22200	QDL22200	QGL22200	QJL22200
				225 A	QBL22225	QDL22225	QGL22225	QJL22225
				<p>3P 240 Vac</p>	Q23225NF/S	Q23225NRB	20, 12R	70 A
80 A	QBL32080	QDL32080	QGL32080					QJL32080 [13]
90 A	QBL32090	QDL32090	QGL32090					QJL32090 [13]
100 A	QBL32100	QDL32100	QGL32100					QJL32100 [13]
110 A	QBL32110	QDL32110	QGL32110					QJL32110 [13]
125 A	QBL32125	QDL32125	QGL32125					QJL32125 [13]
150 A	QBL32150	QDL32150	QGL32150					QJL32150 [13]
175 A	QBL32175	QDL32175	QGL32175					QJL32175 [13]
200 A	QBL32200	QDL32200	QGL32200					QJL32200 [13]
225 A	QBL32225	QDL32225	QGL32225					QJL32225 [13]

[4] See Table 1.74 Knockout Information, page 1-32

[5] Not suitable for service equipment.

[6] Maximum 10 hp 240 Vac.

[7] Top endwall has no hub opening.

[8] Maximum 20 hp 240 Vac.

[9] Not for use with one pole QO circuit breakers. Circuit breakers not included. Order QO type circuit breakers separately from pages 1-2 and 1-3. Accepts QO circuit breakers with factory-installed accessories. Order equipment ground bar PKOGTA2, if required.

[10] Order F for flush, S for surface.

[11] Factory-installed groundable neutral assembly includes (2) ground lugs and (2) neutral lugs. Equipment ground kit PKOGTA2 also included.

[12] Accepts 200 A max. 2P Q Frame circuit breakers.

[13] Equipment ground bar kit PKOGTA2 factory-included.

**Table 1.99: QOM2 Enclosures and QOM2 Circuit Breakers**

Service	Enclosure Only [14]			QOM2 Circuit Breaker (Order Separately) [15]	
	Type 1 General Purpose [16]	Type 3R Rainproof	Box No. [17]	Ampere Rating	22 k AIR
	Cat. No.	Cat. No.			Cat. No. [18]
 <p>2P 240 Vac Maximum</p>	QOM22225NF/S	QOM22225NRB	22, 16R	100 A	QOM2100VH
				125 A	QOM2125VH
				150 A	QOM2150VH
				175 A	QOM2175VH
				200 A	QOM2200VH
				225 A	QOM2225VH



QOM22225NS  
With Cover Removed



Q22200NS  
With Cover Removed



Q23225NF

(Order Q-Frame circuit breaker separately)

[14] Equipment ground bar kit PKOGTA2 factory-included.

[15] Add suffix 1021 for 120, 208 or 240 Vac shunt trip.

[16] Order F for flush, S for surface.

[17] See Table 1.74 Knockout Information, page 1-32

[18] DE3A Discount Schedule.

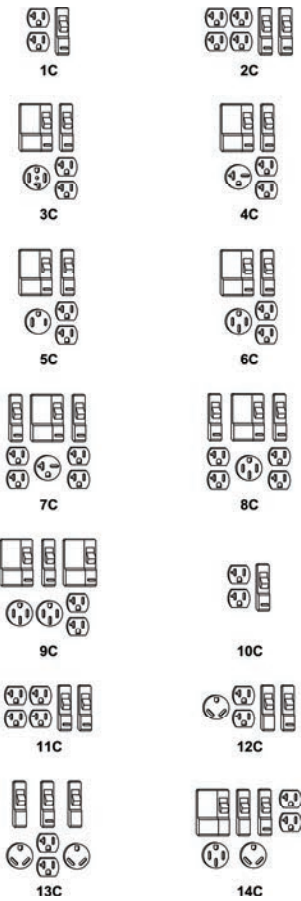

**Power Outlet Panels for Construction Sites**

- Provide temporary power at construction sites.
- Each receptacle protected by QO-GFI circuit breaker in compliance with NEC® requirements.
- Each enclosure is rainproof.
- 10 kA short circuit current rating.
- UL Listed as suitable for use as temporary site service equipment.
- Provided with neutral bonding provisions.
- Boxes have provisions for type “B” hubs to be field-installed.

**Table 1.100: Construction Site Panels**

Power Outlet Configuration	Service [1]	Mains Ampere Rating	Circuit Breaker (Included)	Receptacles (Included)						Cat. No. [2]	Main Wire Size AWG [3]	
				A	C	D	E	F	Cu		Al	
1C	1Ø2W	40 A	(1) QO120GFI	1					PAK10C1 OBS	14-6	12-6	
2C	1Ø2W	40 A	(2) QO120GFI	2					PAK11C [4]	14-6	12-6	
3C	1Ø3W	70 A	(1) QO120GFI (1) QO230GFI	1			1		PAK31CGFI	8-1	8-1	
4C	1Ø3W	70 A	(1) QO120GFI (1) QO220GFI	1		1			PAK36C1GFI	8-1	8-1	
5C	1Ø3W	70 A	(1) QO120GFI (1) QO250GFI	1			1		PAK51CGFI	8-1	8-1	
6C	1Ø3W	70 A	(1) QO120GFI (1) QO250GFI	1	1				PAK55CGFI	8-1	8-1	
7C	1Ø3W	70 A	(2) QO120GFI (1) QO220GFI	2		1			PAK72CGFI	8-1	8-1	
8C	1Ø3W	70 A	(2) QO120GFI (1) QO250GFI	2	1				PAK76CGFI	8-1	8-1	
9C	1Ø3W	100 A	(1) QO120GFI (2) QO250GFI	1	2				PAK1004CGFI	14-1	12-1	

OBS This product is obsolete.

**Power Outlet Panels for Recreational Vehicle Parks**

- Provide electrical power to individual recreational vehicle park sites.
- Each receptacle protected by appropriate GFI or Standard QO™ circuit breaker.
- All receptacles and circuit breakers included.
- 10 kA short circuit current rating.
- UL Listed.
- All enclosures are rainproof.
- No neutral bonding provisions.
- Loop-feed provisions.

**Table 1.101: Recreational Vehicle Park Panels**

Power Outlet Configuration	Service [1]	Mains Ampere Rating	Circuit Breaker (Included)	Receptacles (Included) [5]			Cat. No.	Main Wire Size AWG/kcmil [6]	
				A	B	C		Phase and Neutral	Al
<b>Underground or Overhead Loop-Feed Terminals—Non-Pedestal [2] [7]</b>									
11C	1Ø2W	40 A	(2) QO120GFI	2			PAK11CTG	14-6	12-6
12C	1Ø2W	50 A	(1) QO120GFI (1) QO130	1	1		PAK41CTGFI		12-1
			(2) QO130	1	1		PAK41CTG		
14C	1Ø3W	100 A	(1) QO120GFI (1) QO250 (1) QO130	1	1	1	PAK75CTGFI (Not Loop Feed)	14-1	12-1
			(1) QO250 (2) QO130	1	1	1	PAK75CTG (Not Loop Feed)		
<b>Pedestal Mounted—Underground Loop-Feed Terminals [8]</b>									
11C	1Ø2W	40 A	(2) QO120GFI	2			PAK11PG	(2) 6-250	

A		20 A 125 V 2W and Grd. NEMA 5-20R
B		30 A 125 V 2W and Grd ANSI 73.13
C		50 A 125/250 V 3W and Grd. NEMA 14-50R
D		20 A 250 V 2W and Grd. NEMA 6-20R
E		30 A 125/250 V 3W and Grd. NEMA 14-30R
F		50 A 250 V 2W and Grd. NEMA 6-50R

All non-pedestal devices have provisions to field-install a Type “B” hub on the bottom endwall for bottom feed from a conduit riser. Order Type “B” bolt-on hub (B250 Max.) and two mounting screws (Cat. No. 8002505501) and two hex nuts (Cat. No. 2340102000).

[1] (1Ø2W 120 Vac) (1Ø3W 120/240 Vac)

[2] Devices have a bolt-on factory-installed closing cap. Order type “B” bolt-on hub separately from page 1-18.

[3] Equipment ground terminal suitable for (2) 14 or 12 AWG Cu or (2) 12 or 10 AWG Al.

[4] Receptacles in this device are in bottom endwall and are accessible with outer door padlocked. “Order Only” from Lexington—Minimum order quantity is 50 devices.

[5] 20 A receptacles protected by 20 A GFI circuit breaker.

[6] Two wires each per phase, neutral, and equipment ground—for loop feed (except PAK75CTG).

[7] Equipment ground terminal suitable for (2) 14-12 AWG Cu or (2) 12-10 Al.

[8] Equipment ground terminals suitable for (2) 10-2/0 AWG Cu or (2) 6-2/0 AWG Al.

**Table 1.101 Recreational Vehicle Park Panels (cont'd.)**

Power Outlet Configuration	Service [9]	Mains Am-pere Rating	Circuit Breaker (Included)	Receptacles (Included) [10]			Cat. No.	Main Wire Size AWG/kcmil [11]	
				A	B	C		Phase and Neutral	
								Cu	Al
12C	1Ø2W	50 A	(1) QO120GFI (1) QO130	1	1		PAK41PGFI		
			(2) QO130	1	1		PAK41PG		
13C	1Ø2W	75 A	(1) QO120GFI (2) QO130	1	2		PAK61PGFI		
			(3) QO130	1	2		PAK61PG OBS		
			(1) QO120GFI (1) QO250 (1) QO130	1	1	1	PAK75PG FI		
14C	1Ø3W	100 A	(1) QO250 (2) QO130	1	1	1	PAK75PG		

OBS This product is obsolete.

[9] (1Ø2W 120 Vac) (1Ø3W 120/240 Vac)

[10] 20 A receptacles protected by 20 A GFI circuit breaker.

[11] Two wires each per phase, neutral, and equipment ground—for loop feed (except PAK75CTG).

# Section 2

## Metering Equipment



Individual Meter Socket



MP Meter-Pak Metering Equipment



EZ Meter-Pak Metering Equipment

<b>Meter Sockets</b>	<b>2-2</b>
Ring and Ringless Type Individual Meter Sockets	2-2
Horizontal Ganged, Test Block Bypass Sockets and Accessories	2-3
Dimensions	2-4
<b>MP Meter-Pak™ Meter Centers</b>	<b>2-5</b>
Ring and Ringless Devices	2-5
Ring and Ringless Type Devices	2-5
Tenant Circuit Breakers	2-7
Accessories for MP Meter-Pak Meter Centers	2-7
Dimensions and Knockouts for MP Meter-Pak Meter Centers	2-8
<b>EZ Meter-Pak™ Meter Centers</b>	<b>2-9</b>
Indoor/Rainproof EZM General Information	2-9
Selection Information	2-11
1 Phase Main Devices	2-12
1 Phase Branch Devices	2-14
3 Phase Main Devices	2-15
3 Phase Branch Devices	2-17
3 Phase Main Devices (Busway Side Tap)	2-19
3 Phase Main Devices (Busway Center Tap)	2-20
Tenant Circuit Breakers and EZM Accessories	2-21
Dimensions	2-22
<b>Enclosures</b>	<b>2-24</b>
Enclosed Switches, Dimensions, and Accessories	2-24
Key Interlock Systems—Factory Installed Only	2-25



**Individual Meter Sockets**

This metering is generally utility specific. Always check with local utility company before installing. Contact your nearest Field Sales Office for additional catalog numbers, if required by utility.

- Available single or three phase, 600 Vac max., with and without horn or lever bypass, overhead and underground service feed.
- 10 kA short circuit current rating (or higher with utility approval).
- UL Listed, NEMA 3R enclosure.
- Units supplied with bonded neutral.
- Units supplied with hub opening in top endwall require the use of a bolt-on hub, or closing plate.
- Units supplied with solid top are for underground feed only.
- For accessories, refer to [page 2-3](#).

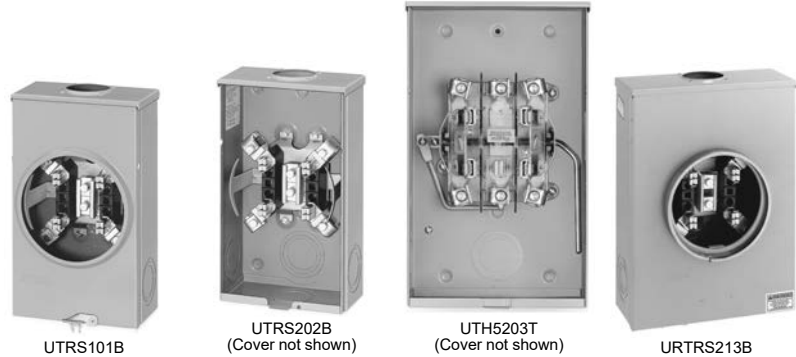

2 METERING EQUIPMENT

**Table 2.1: Individual Meter Sockets**

Ampere Rating [1]	Jaw Qty.	Service Type	Cat. No. [2]	Lug Wire Range (Al/Cu)			Enclosure Information			Box No. [3]
				Line, Load, and Neutral (AWG/kcmil)	Wire Binding	Gnd. (AWG)	Material	Top Endwall Conf.		
Ringless Type, 1Ø3W 600 Vac Max., Without Bypass or Jaw Release										
125	4	UG	UTZRS101A [5]	8-2/0	1/2 in. Hex	14-2	Steel	Solid Top [5]	—	1R
125	4	OH	UTRS101B	8-2/0	Slotted	14-2	Steel	Series A	ACP	1R
125	4	OH	UATRS101B	8-2/0	Slotted	14-2	Aluminum	Series A	ACPA	1R
125	4	OH	URS101BCPL	8-2/0	Slotted	14-2	Steel	Series A	ACP	1R
125	5	OH/UG	1003880A [6]	8-2/0	Slotted	14-2	Steel	Series A	ACP	1R
200	4	OH	UTRS202B	8-250	1/2 in. Hex	14-2	Steel	Series A	ACP	3R
200	4	OH	UATRS202B	8-250	1/2 in. Hex	14-2	Aluminum	Series A	ACPA	3R
200	4	UG	UTRS213A [5]	1/0-350	1/2 in. Hex	14-2	Steel	Solid Top [5]	—	5R
200	4	OH/UG	UTRS213B [6]	1/0-350	1/2 in. Hex	14-2	Steel	Series A	ACP	5R
200	4	OH/UG	UATRS213B [6]	1/0-350	1/2 in. Hex	14-2	Aluminum	Series A	ACPA	5R
200	4	OH/UG	U92197CCCPL [7]	1/0-350	1/2 in. Hex	14-2	Steel	(2) Series A	(2) ACP [7]	7R
Ringless Type, 1Ø3W 600 Vac Max., With Horn Bypass, Without Jaw Release										
125	4	OH/UG	UHTRS101B	8-2/0	Slotted	14-2	Steel	Series A	ACP	1R
125	5	OH	UGHTRS101L [8]	8-2/0	Slotted	14-2	Steel	A125 [8]	—	1R
125	4	OH	URS101BDQ [9]	8-2/0	1/2 in. Hex	None	Steel	Series A	ACP	1R
125	5	OH/UG	UGHTRS111C [10]	8-2/0	Slotted	14-2	Steel	Series A	ACP [10]	4R
200	4	OH/UG	UBHMRS212B [6]	8-250	1/2 in. Hex	None	Steel	Series A	ACP	4R
200	4	OH	UHTRS202B	8-250	1/2 in. Hex	14-2	Steel	Series A	ACP	3R
200	4	OH/UG	UHTRS212B [6]	8-250	1/2 in. Hex	14-2	Steel	Series A	ACP	4R
200	4	OH/UG	UHTRS213B [6]	1/0-350	1/2 in. Hex	14-2	Steel	Series A	ACP	5R
200	4	UG	UHTRS223A [5]	1/0-350	1/2 in. Hex	14-2	Steel	Solid Top [5]	—	2R
200	4	UG	URS212ADQ [9]	8-250	1/2 in. Hex	None	Steel	Solid Top [5]	—	4R
Ringless Type, 1Ø3W 600 Vac Max., With Lever Bypass and Jaw Release										
200	4	OH	UTH4203T	6-350	1/2 in. Hex	14-2	Steel	Series A-L	ACPL	8R
200	4	OH/UG	UTH4213T [6]	6-350	1/2 in. Hex	14-2	Steel	Series A-L	ACPL	9R
200	5	OH	UTH5203T	6-350	1/2 in. Hex	14-2	Steel	Series A-L	ACPL	8R
200	5	OH/UG	UTH5213T [6]	6-350	1/2 in. Hex	14-2	Steel	Series A-L	ACPL	9R
320	4	OH/UG	UTH4330T [11]	Studs Only	3/8 in. dia. studs	14-1/0	Steel	Series A-L	ACPL	11R
Ringless Type, 3Ø4W 600 Vac Max., With Lever Bypass and Jaw Release										
200	7	OH/UG	UTH7213T [6]	6-350	1/2 in. Hex	14-2	Steel	Series A-L	ACPL	9R
320	7	OH	UTH7300T [11]	Studs Only	3/8 in. dia. studs	14-1/0	Steel	Series A-L	ACPL	10R
Ringless Type, 3Ø4W 600 Vac Max., Bolt-On Socket Without Bypass										
400	7	OH/UG	UK7T [11]	Studs Only	1/2 in.-20 dia. studs	1/2 in.-20 dia. studs	Steel	Series A-L	ACPL	12R
400	7	OH/UG	UAK7T [11]	Studs Only	1/2 in.-20 dia. studs	1/2 in.-20 dia. studs	Aluminum	Series A-L	ACPLA	12R
Ring Type, 1Ø3W 600 Vac Max., Without Bypass or Jaw Release										
125	4	OH/UG	URTRS101B [6]	8-2/0	Slotted	14-2	Steel	Series A	ACP	1R
200	4	OH/UG	URTRS213B [6]	1/0-350	1/2 in. Hex	14-2	Steel	Series A	ACP	5R

[1] Rating is continuous.  
 [2] Device requires approval from the serving utility, consult your nearest Schneider Electric sales office.  
 [3] For box dimensions, see [page 2-4](#)  
 [4] Order appropriate bolt-on hub or closing plate separately and install on TOP endwall.  
 [5] Device supplied with solid top endwall (without hub opening).  
 [6] When unit is installed for underground feed, the appropriate closing plate must be ordered separately and installed over hub opening in TOP endwall of device.  
 [7] Device supplied with two closing plates ACP mounted in TOP endwall.  
 [8] Device supplied with 1-1/4 in. bolt-on hub (Cat. No. A125) mounted on TOP endwall.  
 [9] Contains "Duquesne Light Co." approved label.  
 [10] Device supplied with closing plate ACP mounted on TOP endwall.  
 [11] Order lugs separately, see [page 2-3](#)



UT2R1121B

**Horizontal Ganged Meter Sockets**

- 1Ø, 600 Vac max., main lugs only, 2 through 6 meter positions, with and without horn or lever bypass, end or center feed, overhead and underground service feeds.
- 10 kA short circuit current rating (or higher with utility approval).
- UL Listed, NEMA 3R enclosure.
- Supplied with ground lugs.
- Supplied with hub opening in top endwall, requires the use of a bolt-on hub, or closing plate.

**This metering is generally utility specific. Always check with local utility company before installing. Contact your nearest Field Sales Office for additional catalog numbers, if required by utility.**

**Table 2.2: Ringless Type, 1Ø3W, 600 Vac Max., Without Bypass or Jaw Release**

Branch Ratings				Mains Rating (A)	Cat. No.	Main Lugs Phase and Neutral Al/Cu (AWG/kcmil)	Branch Lugs Phase and Neutral Al/Cu (AWG)	Top Endwall [12]		Box No. [13]
Amperes [14]	No. of Positions	Socket Jaw Qty. [15]	Service Type					Hub Type (Order Separately)	Closing Plate (Order Separately)	
100 A	2	4	OH/UG	200	UT2R1121B	6-250	8-2/0	Series A	ACP	13R
	3			205	UT3R1121B	6-250				13R1
	4			205	UT4R1131B	6-350				14R
	5			250	UT5R1131B	6-350				15R
	6			300	UT6R1131B	6-350				16R
	2			205	UT2R2122B	6-250				17R
200 A	4	4	OH/UG	360	UT4R2352T	1/0-500	8-250	Series A	ACP	18R
	5			500	UT5R2392TU	1/0-500 or (2)1/0-350		Series A-L	ACPL	19R
						1/0-500 or (2)1/0-350		Series A-L	ACPL	20R
	6			620	UT6R2392TU	1/0-500 or (2)1/0-350		Series A-L	ACPL	20R

METERING EQUIPMENT 2

**Meter Mains with Test Block Bypass**

**Table 2.3: Ring Type, 1Ø3W and 3Ø4W, Meter Main with Test Block Bypass (Meets EUSERC Requirements)**



EMT3225CB

EMT1225CB Without Covers

System (Incoming and Service (Outgoing))	Meter Socket Type	Ampere Rating (Max.)	Short Circuit Current Rating	Cat. No. [13][16]	Main Circuit Breaker Type (Order Separately) [17]
120/240 Vac 1Ø3W	5-Jaw	225 A	100 kA max.	EMT1225CB	2P Type QB, QD, QG, QJ (QO, QO-VH, QOH) [18]
208Y/120 Vac 3Ø4W [19] or 240/120 Vac 3Ø4W Delta	7-Jaw	225 A	65 kA max.	EMT3225CB	3P Type QB, QD, QG or QJ

**Table 2.4: EMT Terminal Wire Size [20]**

Line Phase Lug	Line Neutral Lug	Service Ground Lug	Equipment Ground Lug	Load Neutral Lug
6 AWG-300 kcmil Al/Cu	6 AWG-350 kcmil Al/Cu	4 AWG-300 kcmil Al/Cu	6 AWG-300 kcmil Al/Cu	4 AWG-300 kcmil Al/Cu

**Table 2.5: Adapter Plate, Lug Kits, and Sealing Rings**

Accessory	Description	Cat. No.
Adapter Plate	To allow the use of a Series A Hub on a device that is setup for a series A-L Hub.	AAP
Lug Kits	For use on meter sockets supplied with Line, Load, and Neutral Studs only. Be sure to order enough lugs for each device (a typical 1Ø device requires 6 lugs).	
	Includes one, two-barrel lug (6-250 kcmil)	ARP00118
	Includes one, single barrel lug (4-600 kcmil)	ARP00129
Sealing Ring	Includes three, two-barrel lugs (6-350 kcmil)	ARP00427
	Snap-on Aluminum (Standard)	2920910001
	Snap-on Stainless Steel (Non-standard)	ARP00026
	Screw Type Aluminum (Non-standard)	29008W

**Meter Socket Accessories**

**Table 2.6: Fifth-Jaw Kit, Closing Plates, and Hubs**

Accessory	Description	Cat. No.		
Fifth-Jaw Kit	Converts a 4-jaw meter socket to a 5-jaw meter socket. For use on meter sockets supplied without lever bypass or jaw release only.	A5J		
	For Series A (steel)	ACP		
Closing Plates (to seal hub openings)	For Series A (aluminum)	ACPA		
	For Series A-L (steel)	ACPL		
	For Series A-L (aluminum)	ACPLA		
Hubs (listed by conduit size)	Series A	1.00 inch	A100	
		1.25 inch	A125	
		1.50 inch	A150	
		2.00 inch	A200	
		2.50 inch	A250	
		2.00 inch	A200L	
	Series A-L	2.50 inch	A250L	
		3.00 inch	A300L	
		3.50 inch	A350L	
		4.00 inch	A400L	
		Series B	3.00 inch	B300

[12] For hubs and closing plates, see page 2-3.

[13] For box dimensions, see page 2-4

[14] Rating is continuous.

[15] Fifth jaw kit available to convert 4-jaw socket to a 5-jaw socket. See page 2-3.

[16] Supplied with bondable neutral, suitable for use as service equipment, suitable for overhead or underground service. UL Listed E6294.

[17] See page 2-21 to select main circuit breaker.

[18] Requires use of an EZM12SQOA adapter (order separately), when using QO (40 A-125 A, 2-pole) 10 kA max. SCCR, QO-VH (40 A-60 A, 2-pole) 22 kA max. SCCR, or QOH (40 A-60 A, 2-pole) 42 kA max. SCCR.

[19] 100 kA max.

[20] Refer to circuit breaker listings for usable load lug wire sizes.

**Table 2.7: Enclosure Dimensions**

Dimensions (Inches)				
Box No.	H	W	D	Hub Opening (Max. Conduit Size) [21]
1R	10.88	8.00	3.50	Series A
2R	13.00	13.00	4.94	Solid Top
3R	14.00	8.00	4.38	Series A
4R	14.00	11.00	4.38	Series A
5R	15.00	11.00	4.38	Series A
6R	15.50	8.00	4.36	Series A
7R	17.13	13.00	4.94	(2) Series A
8R	19.00	10.50	4.94	Series A-L
9R	19.00	13.00	4.94	Series A-L
10R	34.50	15.00	5.68	Series A-L
11R	36.62	15.00	5.68	Series A-L
12R	43.00	20.25	6.00	Series A-L
13R	14.12	24.31	4.50	Series A
13R1	14.12	32.50	4.50	Series A
14R	14.12	40.62	4.50	Series A
15R	14.12	48.75	4.50	Series A
16R	14.12	57.00	4.50	Series A
17R	14.12	24.31	5.38	Series A
18R	14.12	40.62	5.38	Series A-L
19R	14.12	54.75	5.38	(2) Series A-L
20R	14.12	63.00	5.38	(2) Series A-L

**Table 2.8: Knockout Information**

Knockouts						
Symbol	S	A	B	C	D	
Conduit Size (in.)	5/16 [22]	1/2	3/4	1	1-1/4	
Symbol	E	F	G	H	I	J
Conduit Size (in.)	1-1/2	2	2-1/2	3	3-1/2	4

**Dimensions and Knockouts for Meter Sockets**

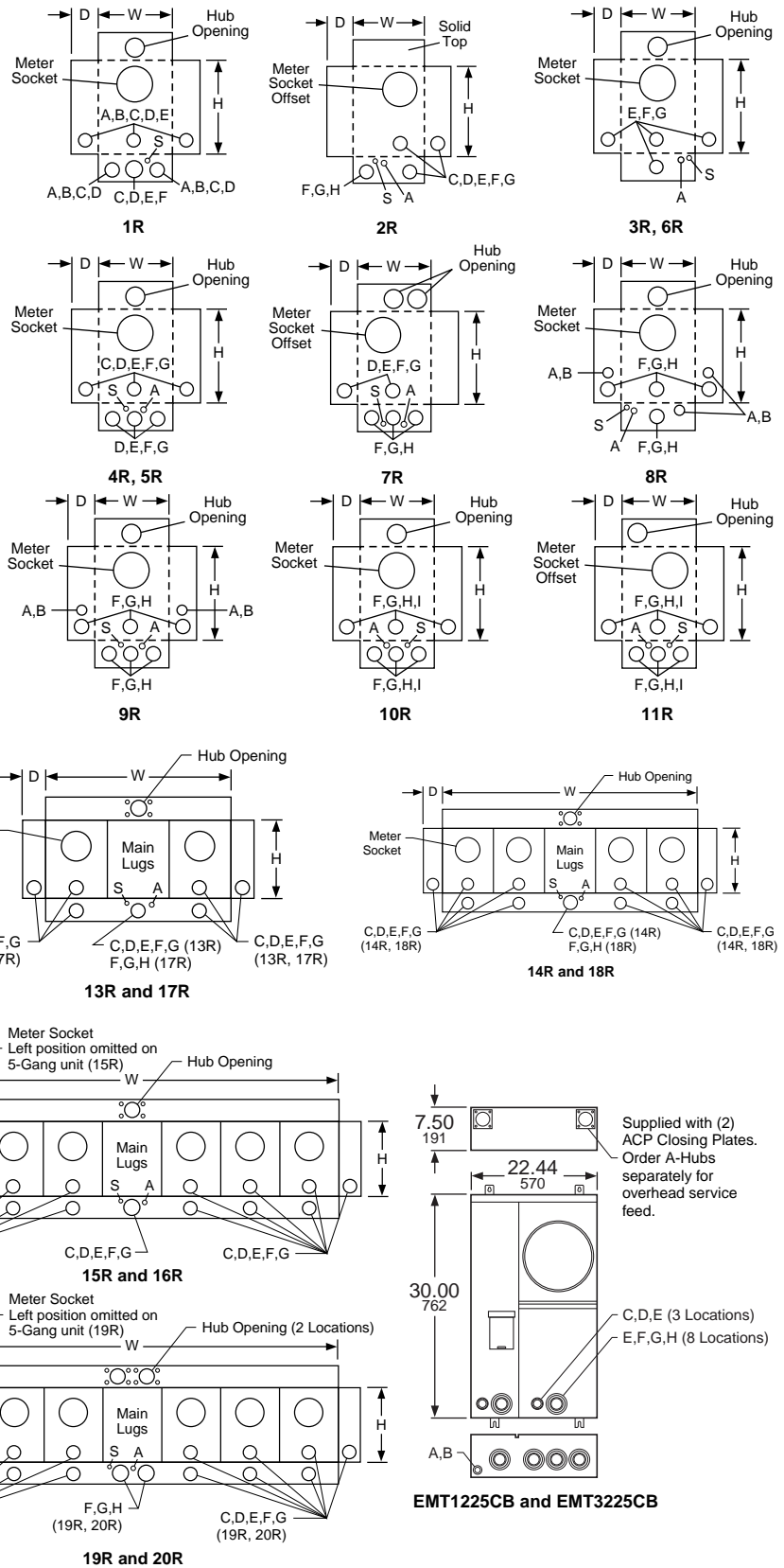

[21] Refer to page 2-3 for closing plates and hubs.  
[22] Knockout for grounding conductor.



MP44125

**Ring and Ringless Type Devices**

- Consult local utility for approval before installation.
- 120/240 Vac 1Ø3W.
- Main lugs only—two to six meter sockets.
- Enclosures are indoor/rainproof NEMA 3R construction.
- Suitable only for use as service equipment.
- Swingable mounting feet supplied at bottom of device.
- Factory-installed mechanical lugs, alternate lugs and NEMA/EUSERC lug landing kits available.
- Surface mount, convertible to semi-flush with field installed flange kit.
- Ring type devices supplied with 4-jaw meter sockets (5th jaw kits available, order separately).
- Ringless type devices supplied with 5-jaw meter sockets, available with and without horn or lever bypass.
- Provisions for mounting 2-pole circuit breaker for each meter socket position (order circuit breakers separately).
- Mounting channel supplied, except for box 1R (125 A, 2-position).
- Combination overhead/underground feed.

**Table 2.9: MP Catalog Number Description**

Number Segment	Character	Description	MP	H	4	4	125
Device Name	MP	Meter-Pak Meter Center					
	Blank	Ring Type					
Socket/Bypass Type	R	Ringless Type with 5th Jaw					
	H	Ringless with Horn Bypass and 5th Jaw					
	L	Ringless with Lever Bypass, Jaw Release and 5th Jaw					
Bus Ampacity	2	200 A					
	3	300 A					
	4	400 A					
	5	500 A					
	6	600 A					
	8	800 A					
Number of Meter Sockets	2	2-Positions MP, MPH, MPL, and MPR					
	3	3-Positions MP, MPH, MPL, and MPR					
	4	4-Positions MP, MPH, MPL, and MPR					
	5	5-Positions MP, MPH and MPR					
Max. Tenant Circuit Breaker Amperage	125	125 A					
	200	200 A					
	225	225 A					

**Table 2.10: Ring Type MP Meter-Pak Metering Equipment with 125 A (42 kA Maximum SCCR) or 200 A (22 kA Maximum SCCR) Meter Socket Positions**

Amperes per Pos.	No. of Positions	Factory-Installed Main Lugs Ampacity (alternate lugs [1])	Main Bus Ampacity (A)	Cat. No.	Line Lug Wire Size Al/Cu AWG/kcmil	Circuit Breaker Type (2P)	Hub Prov. [2]	Semi-Flush Flange Kit	Wt Lbs	Box No.
125	2	200	200	MP22125 [3]	(1) 4-250	QO, QO-VH, QOH	A/B300	MPSF12	46	1R
	3	300	300	MP33125 [4]	(1) 1/0-600 or (2) 1/0-250		A-L	MPSF14	95	2R
	4	400	400	MP44125 [4]	(1) 1/0-600 or (2) 1/0-250		A-L	MPSF14	97	2R
	5	400 Al 500 Cu	500	MP55125 [4]	(1) 1/0-600 or (2) 1/0-250		(4) A-L	MPSF16	130	3R
	6	400 Al 500 Cu	600	MP66125 [4]	(1) 1/0-600 or (2) 1/0-250		(4) A-L	MPSF16	132	3R
200	2	400	400	MP42200 [4]	(1) 1/0-600 or (2) 1/0-250	QOM2-MM, QOM2-MVH	(4) A-L	MPSF23	99	4R
	3	400	400	MP43200 [4]	(1) 1/0-600 or (2) 1/0-250			MPSF23	99	4R
	4	400	600	MP64200 [4]	(1) 1/0-600 or (2) 1/0-250			MPSF24	135	5R
	5	600 Al, 750 Cu	800	MP85200 [4]	(2) 3/0-500			MPSF26	173	6R
	6	600 Al, 750 Cu	800	MP86200 [4]	(2) 3/0-500			MPSF26	173	6R

**Table 2.11: Ringless Type MP Meter-Pak Metering Equipment with 125 A (42 kA Maximum SCCR) or 200 A Type MPR, MPH (22 kA Maximum SCCR) or 225 A Type MPL (100 kA Maximum SCCR) Meter Socket Positions**

Amperes Per Pos.	No. of Pos.	Factory-Installed Main Lugs Ampacity (alternate lugs [1])	Main Bus Ampacity	No. Bypass Cat. No.	Horn Bypass Cat. No.	Lever Bypass Cat. No.	Line Lug Wire Size Al/Cu AWG/kcmil	Circuit Breaker Type (2P) [5]	Hub Prov. [2]	Semi-Flush Flange Kit	Wt Lbs	Box No.
125	2	200	200	MPR22125	MPH22125	—	(1) 4-250	QO, QO-VH, QOH	A/B300	MPSF12	46	1R
	3	300	300	MPR33125	MPH33125	—	(1) 1/0-600 or (2) 1/0-250		A-L	MPSF14	95	2R
	4	400	400	MPR44125	MPH44125	—	(1) 1/0-600 or (2) 1/0-250			MPSF14	97	2R
	5	400 Al 500 Cu	500	MPR55125	MPH55125	—	(1) 1/0-600 or (2) 1/0-250		(2) A-L	MPSF16	130	3R
	6	400 Al 500 Cu	600	MPR66125	MPH66125	—	(1) 1/0-600 or (2) 1/0-250			MPSF16	132	3R
200	2	400	400	MPR42200	MPH42200	—	(1) 1/0-600 or (2) 1/0-250	QOM2-MM, QOM2-MVH	(2) A-L	MPSF23	99	4R
	3	400	400	MPR43200	MPH43200					MPSF23	99	4R
	4	400	600	MPR64200	MPH64200					MPSF24	135	5R
225	2	350	350	—	—	MPL32225	(1) 1/0-600 or (2) 1/0-250	QBP-TM, QDP-TM, QGP-TM or QJ-TM QO [6], QO-VH [6] or QOH [6]	(2) A-L	N/A	105	7R
	3	400	500	—	—	MPL53225				N/A	147	8R
	4	400	600	—	—	MPL64225				N/A	200	9R
200	5	600 Al, 750 Cu	800	MPR85200	MPH85200	—	(2) 3/0-500	QOM2-MM, QOM2-MVH	(2) A-L	MPSF26	173	6R
	6	600 Al, 750 Cu	800	MPR86200	MPH86200	—	(2) 3/0-500			MPSF26	173	6R

**NOTE:** UL Listed short circuit current rating depends on lowest interrupting rating of circuit breaker installed.

[1] See page 2-7 for alternate lugs.  
 [2] For A and A-L Hubs see page 2-3, for B Hubs see Digest Section 3.  
 [3] Meets EUSERC standards.  
 [4] Meets EUSERC standards with addition of lug landing kit, MMSK2.  
 [5] See page 2-7  
 [6] Requires use of EZM125QOA adapter (order separately).

2 METERING EQUIPMENT

**Tenant Circuit Breakers**

UL Listed Short Circuit Current Rating depends on lowest interrupting rating of circuit breaker installed. (Refer to page 2-11 for Square D certified ratings for downstream panelboards and load centers.)

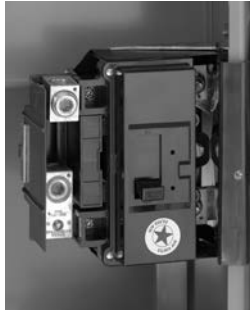

QOM2200MVH



QO2100VH  
2P, Plug-on Type  
Circuit Breaker



QDP22200TM  
2P, Plug-on Type  
Circuit Breaker



MMLK500

**Table 2.12: Tenant Circuit Breakers**

Amperes	10 k AIR 120/240 Vac	22 k AIR 120/240 Vac	42 k AIR 120/240 Vac	100 k AIR 120/240 Vac
<b>For use in 125 A Max. Type MP, MPR and MPH Meter-Pak Metering Equipment</b>				
40	QO240	QO240VH [7]	QOH240	—
50	QO250	QO250VH [7]	QOH250 [7]	—
60	QO260	QO260VH	QOH260 [7]	—
70	QO270	QO270VH	QOH270 [7]	—
80	QO280	QO280VH	QOH280 [7]	—
90	QO290	QO290VH	QOH290	—
100	QO2100	QO2100VH	QOH2100	—
125	QO2125	QO2125VH	QOH2125	—
<b>For use in 200 A Max. Type MP, MPR and MPH Meter-Pak Metering Equipment</b>				
100	QOM2100MM	QOM2100MVH	—	—
125	QOM2125MM	QOM2125MVH	—	—
150	QOM2150MM	QOM2150MVH	—	—
175	QOM2175MM	QOM2175MVH	—	—
200	QOM2200MM	QOM2200MVH	—	—
Amperes	10 k AIR 120/240 Vac	25 k AIR 120/240 Vac	65 k AIR 120/240 Vac	100 k AIR 120/240 Vac
<b>For use in 225 A MPL Lever Bypass Meter-Pak Metering Equipment</b>				
40	QO240 [8]	QO240VH [7] [9] [8]	QOH240 [10] [8]	—
50	QO250 [8]	QO250VH [7] [9] [8]	QOH250 [10] [7] [8]	—
60	QO260 [8]	QO260VH [7] [9] [8]	QOH260 [10] [7] [8]	—
70	QBP22070TM	QDP22070TM	QGP22070TM	QJP22070TM
80	QBP22080TM	QDP22080TM	QGP22080TM	QJP22080TM
90	QBP22090TM	QDP22090TM	QGP22090TM	QJP22090TM
100	QBP22100TM	QDP22100TM	QGP22100TM	QJP22100TM
110	QBP22110TM	QDP22110TM	QGP22110TM	QJP22110TM
125	QBP22125TM	QDP22125TM	QGP22125TM	QJP22125TM
150	QBP22150TM	QDP22150TM	QGP22150TM	QJP22150TM
175	QBP22175TM	QDP22175TM	QGP22175TM	QJP22175TM
200	QBP22200TM	QDP22200TM	QGP22200TM	QJP22200TM
225	QBP22225TM	QDP22225TM	QGP22225TM	QJP22225TM

**Accessories for MP Meter-Pak Meter Centers**

**Table 2.13: Accessories**

Accessory	Description	Cat. No.
Fifth Jaw Kit	Fifth Jaw Kit	5J
Horn Bypass Kit	For MPR and MPH only	MMHB
QO Adapter	For Bolt-on Q2M tenant circuit breakers (40–125 A, 2P)	EZM125QOA
Slider Type Manual Circuit Closing:	125 A Ring Style 2 Position Top Meter (Only) 125 and 200 A Ring Style	MM125MB [11] MM200MB [11]
Sealing Rings:	Snap-on Aluminum Screw Type Aluminum Snap-on Type Stainless Steel	2920910001 29008W ARP00026
Meter Cover-Lexan™	Meter Cover-Lexan™	29007
Optional Lug Kits:	(1) 1/0–600 AWG/kcmil or (2) 1/0–250 AWG/kcmil per phase  (1) 3/0–500 AWG/kcmil per phase (2) 2–600 AWG/kcmil per phase	MMLK250 [12][13]  MMLK500 [13] MMLK600 [13]
Semiflush Kits:	125 A 2 Position 125 A 3–4 Position 125 A 5–6 Position 200 A 2–3 Position 200 A 4 Position 200 A 5–6 Position	MPSF12 MPSF14 MPSF16 MPSF23 MPSF24 MPSF26
NEMA/EUSERC Lug Landing Kit:	For 3 through 6 position 125 A and 200 A devices. Each pad rated 600 A maximum and includes (2) 1/2-13 studs and mounting hardware.	MMSK2 [13]
NEMA Lug Landing Kit:	For use ONLY on MPL43225, MPL53225 and MPL64225 with optional lugs. See wiring diagram of each device for optional lugs.	MMSK4
MP Meter-Pak Wireway: (Wall Mount Pedestal)	125 A 2 Position ONLY 125 A 3–6 Position 200 A 2–6 Position MPL32-225 MPL53-225 MPL64-225	MP43X8PED MP43X11PED MP43X11PED MP35X11PED [14] MP43X11PED MP35X11PED [14]
MP Meter-Pak Wireway Extensions:	Used ONLY with MP43X8PED Used with MP43X11PED and MP35X11PED	MP12X8PEDEXT [14] MP12X11PEDEXT [14]

[7] Order only. Not stocked in PDS. Order Point: Lincoln.

[8] Requires use of EZM125QOA adapter (order separately).

[9] QO-VH tenant circuit breakers are rated 22 kAIR at 120/240 Vac.

[10] QOH tenant circuit breakers are rated 42 k AIR at 120/240 Vac.

[11] The meter center short circuit current rating is 10 kA when manual circuit closing is used. Not rated for continuous duty.

[12] Standard lug for 3 through 6 position 125 A and 2 through 4 position 200 A devices.

[13] Cannot be installed on 2 position 125 A device.

[14] Order only. Not stocked in PDS. Order point: Lexington.

For hubs and closing plates, see page 2-3.

Dimensions and Knockouts for MP Meter-Pak Meter Centers

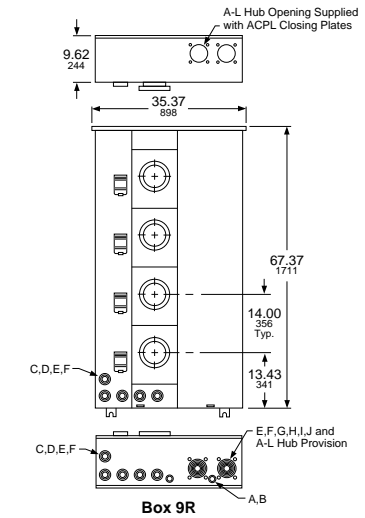
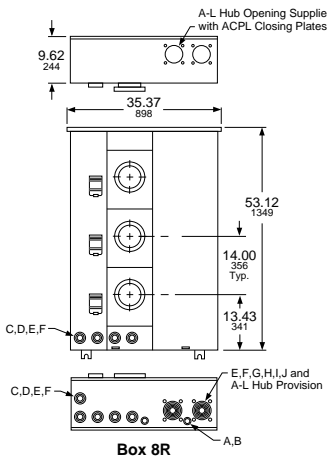
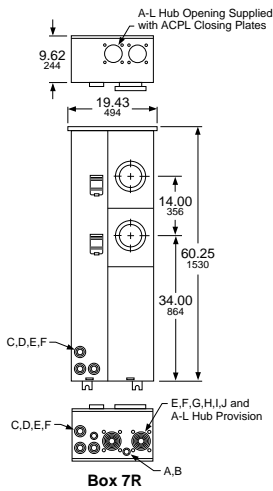
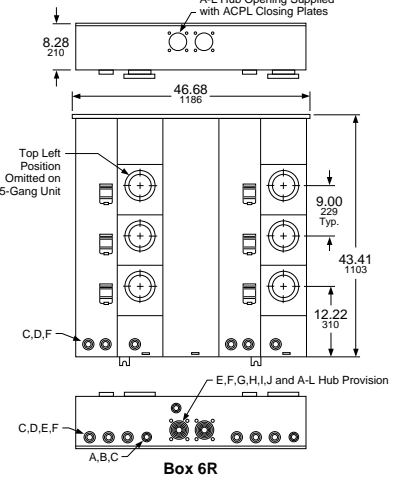
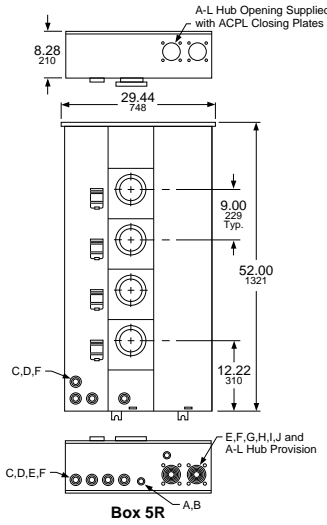
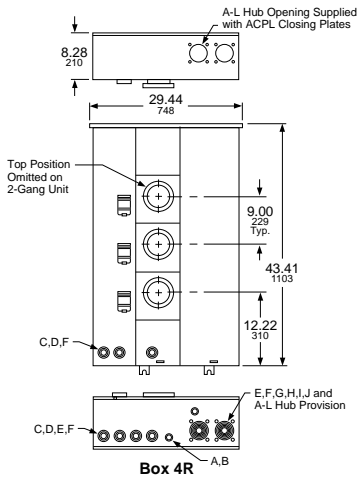
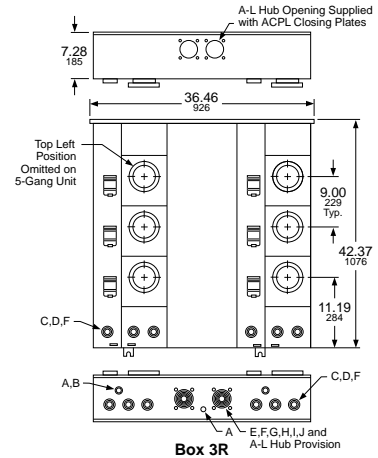
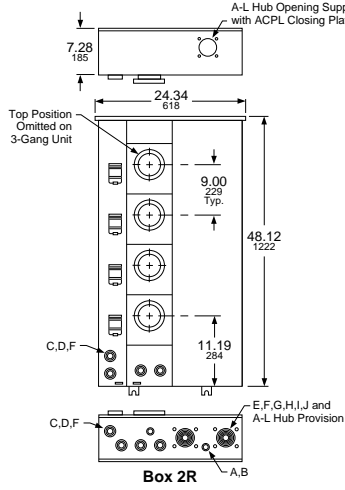
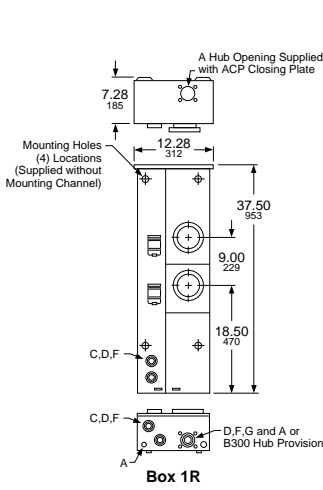

Symbol	Knockouts									
	A	B	C	D	E	F	G	H	I	J
Conduit Size (in.)	1/2	3/4	1	1-1/4	1-1/2	2	2-1/2	3	3-1/2	4

## NEMA 3R Construction

**240 Vac Maximum**, for use on AC systems, suitable for use as Service Equipment.

**Utility Company Requirements Review local utility requirements to ensure that metering equipment meets their standards.**

**EZ Meter-Pak** meter center enclosures meet NEC wire bending requirements, and are designed for wall mounting only (not suitable for floor mounting). All unmetrated conductor compartments may be sealed by the utility company.

**EZ Meter-Pak** meter centers have UL Listed short circuit current ratings up to 100 kA at 240 Vac when properly applied. For three-tier series ratings refer to Data Bulletin 4100DB0301 and Instruction Bulletin 80043-303-22.

**Suitable incoming services for an EZM main device and available outgoing feeder(s) to downstream panelboards from EZM branch section(s)—**

### Incoming Service to Main Device 120/240 Vac, 1Ø3W

Available outgoing feeder(s) to downstream panelboards:

- 120/240 Vac, 1Ø3W (4-jaw ring type meter sockets, two-pole circuit breakers), (5-jaw ringless meter sockets, two-pole circuit breakers).

### Incoming Service to Main Device 240/120 Vac, 3Ø4W Delta

Available outgoing feeder(s) to downstream panelboards:

- 120/240 Vac, 1Ø3W (Fed from transformer's "A-Phase" and "C-Phase" only.) NOTE: Connection to High-Leg "B-Phase" not permitted for this service (4-jaw ring type meter sockets, two-pole circuit breakers) (5-jaw ringless meter sockets, two-pole circuit breakers) Standard 3Ø IN/1Ø OUT branch units **are not suitable for use on this Delta System**. Special branch units are available for this System by adding suffix: "CA" to catalog number (Typical Examples: EZM313125CA, EZM313125XCA, EZM313125CUXCA, EZM314225CA, EZM314225XCA, EZM314225CUXCA, EZM315225CA, EZM314225CUCU, etc.).
- 240/120 Vac, 3Ø4W Delta (7-jaw meter sockets, three-pole circuit breakers).

### Incoming Service to Main Device 208Y/120 Vac, 3Ø4W

Available outgoing feeder(s) to downstream panelboards:

- 120/208 Vac, 1Ø3W (5-jaw meter sockets, two-pole circuit breakers)
- 208Y/120 Vac, 3Ø4W (7-jaw meter sockets, three-pole circuit breakers).

## EZM General Information

### Main Devices

- 400, 600 and 800 A main disconnects may be end-mounted with branch units having 800 A or 1200 A continuous horizontal cross bus.
- 1000 and 1200 A main disconnect or terminal box **must be center mounted** when used with branch devices with main bus rated 800 A continuous.
- 1600 A main disconnect or terminal box **must be center mounted**.
- 2000 A main disconnect **must be center mounted** and requires use of branch units having 1200 A continuous horizontal cross bus.
- 400, 800 and 1200 A Type EZM-TBU terminal boxes supplied with lug landings to meet EUSERC requirements.

**Main Circuit Breaker ratings:** 400, 600, 800, 1000, 1200, 1600 and 2000 A

**Main Fusible Switch ratings:** 400, 600, 800, and 1200 A (1Ø3W only)

**Main Lugs Terminal Box ratings:** 225, 400, 600, 800, 1200, 1600, and 2000 A

### Branch Units

- **125 and 225 A residential branch units** are available in ring type or ringless type construction and are supplied with 800 A continuous aluminum horizontal cross bus as standard (Example: EZM314125). For optional 1200 A continuous copper horizontal cross bus with aluminum vertical connectors, add suffix "X" to catalog number (Example: EZM314125X). For optional 1200 A continuous all-copper bussing, add suffix "CUX" to catalog number (Example: EZM314125CUX). NOTE: 5-gang 225 A EZM, EZMR and EZMH residential branch units are supplied with 1200 A continuous Cross Bus as standard, do not add suffix "X" or "CUX" to these units (Examples: EZMR315225 or EZMR315225CU). Plug-in style residential meter sockets are available as ring type **EZM** without bypass, ringless type **EZMR** without bypass, and ringless type **EZMH** with horn bypass. Tenant circuit breakers must be ordered separately for these branch units. 125 A max. units make use of Type QO, QO-VH or QO-H two-pole tenant circuit breakers (40–125 A). 225 A max. units make use of Type QDP-TM, QBP-TM, QGP-TM and QJP-TM two-pole tenant circuit breakers (70–225 A), and may also make use of two-pole Type QO (40–125 A at 10 kA max.), two-pole Type QO-VH (40–60 A at 100 kA max.), or two-pole Type QO-H (40–60 A at 100 kA max.) tenant circuit breakers.
- **225 A commercial branch units** are available in ring type or ringless type construction and are supplied with 1200 A copper horizontal cross bus with aluminum vertical connectors as standard (Example: EZML314225). For optional 1200 A continuous all-copper bussing, add suffix "CU" to catalog number (Example: EZML314225CU). Plug-in style commercial meter sockets are available as ring type **EZMT** with test block bypass (meets EUSERC requirements), ringless type **EZMR** without bypass, and ringless type **EZML** with lever bypass.

225 A max. units make use of type QDP-TM, QBP-TM, QGP-TM and QJP-TM two-pole or three-pole tenant circuit breakers (70–225 A), and may also make use of two-pole type QO (40–125 A at 10 kA max.), two-pole type QO-VH (40–60 A at 100 kA max.), or two-pole type QO-H (40–60 A at 100 kA max.) tenant circuit breakers.

**Note:** QO, QO-VH and QO-H tenant circuit breakers used in 225 A branch units require the use of adapter **EZM125QOA** (purchased separately).

- **400 A branch units** are available in ringless type construction only, and are supplied with 1200 A continuous all-copper bussing as standard (Example: EZML332400). These branch units are supplied with factory-installed type LJL tenant circuit breakers that have a field adjustable ampere rating trip setting from 125 A min. to 400 A max. A tamper-evident seal kit is available where needed, order seal kit **MICROTUSEAL** (refer to NEC 240-6 [c]). 400 A branch units are available as Type **EZML** with plug-in style lever bypass type meter sockets, or Type **EZMK** with bolt-on style with manual bypass type meter sockets.
- Units having **800 A continuous horizontal cross bus** WILL CONNECT with units having **1200 A continuous horizontal cross bus**.
- **Single phase units** (three bus bars in horizontal cross bus) WILL NOT CONNECT with **three phase units** (four bus bars in horizontal cross bus).

**For Load Center Three-Tiered Series Ratings used downstream from Metering Equipment, refer to Data Bulletins: 4100DB0301 and 2700DB9901.**



EZM Configuration Information

Table 2.14: EZM Mains Devices

Number Segment	Character	Description	EZM	1	1000	CB	U	CU
Device Name	EZM	EZ Meter-Pak Meter Center						
Service Feed	1	1Ph, 3W						
	3	3Ph, 4W						
Mains Rating		225 A						
		400 A						
		600 A						
		800 A						
		1000 A						
		1200 A						
		1600 A						
		2000 A						
Main Type	CB	Main Circuit Breaker						
	FS	Main Fusible Switch						
	TB	Terminal Box						
	GCB	Main Circuit Breaker (65 kAIC)						
	JCB	Main Circuit Breaker (100 kAIC)						
Feed Direction	Blank	Overhead / Underground						
	C	Overhead / Underground						
	B	Underground Only						
	T	Overhead Only						
	U	Underground Only, Meets EUSERC Standards up to 1200 A max.						
Special Construction	E	Underground Only, Meets EUSERC Standards up to 1200 A max.						
	Blank	Aluminum Horizontal Cross Bus Bar up to 1000A max.						
	CU	Copper Horizontal Cross Bus Bar						
	MS	Includes Energy Reduction Maintenance Switch						

This table is for interpreting existing part numbers only. All possible combinations are not available.

Table 2.15: EZM Branch Devices

Number Segment	Character	Description	EZM	R	1	1	3	125	CU
Device Name	EZM	EZ Meter-Pak Meter Center							
Socket/Bypass Type	Blank	Ring Type							
	R	Ringless Type with 5th Jaw							
	H	Ringless with Horn Bypass and 5th Jaw							
	L	Lever Bypass with 5th Jaw, 7th Jaw if Three Phase							
	T	Ring Type Test-Block Bypass EUSERC							
Service Feed	K	K-Base Bolt-On Type							
	1	1Ph, 3W							
Load Feed	3	3Ph, 4W							
	1	1Ph, 3W							
Number of Meter Sockets Available	3	3Ph, 4W							
	1,2,3,4,5 or 6								
Maximum Tenant Circuit Breaker Amperage	125	125 A							
	225	225 A							
	400	400 A							
Special Construction	Blank	Aluminum Horizontal Cross Bus Bar							
	CA	For 240/120 Vac Delta Systems							
	CU	Copper Horizontal Cross Bus Bar							
	D	Removable Drip Hood with Indoor Top Endwall with Knockouts							
	M10	10-Inch Meter Centers							
	X	1200A Copper Horizontal Cross Bus Bar							

2 METERING EQUIPMENT

**Selection Information**

- Review local utility requirements to ensure that metering equipment meets their standards.
- Check local utility to determine available fault current at the meter center.
- Using the SCCR table:
  - Select meter center configuration, main lugs only (Six Disconnect Rule), or remote main, main circuit breaker, or main fusible switch.
  - Read down to select SCCR equal to, or greater than desired rating.
  - Read across to select branch unit tenant circuit breaker type.
  - Continue reading across to select EZM main device type.

**Table 2.16: UL Listed Meter Center Short Circuit Current Ratings (SCCR) [1]**

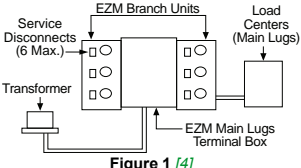
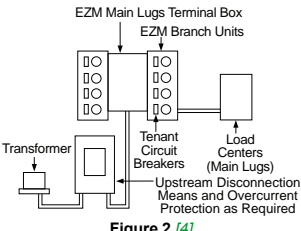
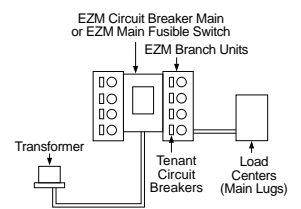
Figures	Short Circuit Current Rating (240 Vac Maximum) [2] [3]	EZM Meter Center Overcurrent Protection Devices		
		EZM Branch Unit Tenant Circuit Breaker Types Available (Branch Unit Amperes max., Tenant Circuit Breaker Amperes Rating Range)	EZM Main Device with Integral Mounted Main, Remote Mounted Main or without an Upstream Mounted Main (Six Disconnect Rule)	
 <p>Figure 1 [4]</p>	<b>EZ Meter-Pak (Six Disconnect Rule Applications)—See Figure 1</b>			
	10 kA	QO (125 A, 2P, 40–125 A) QO (225 A, 2P, 40–125 A) [5] QB (225 A, 2P or 3P, 70–225 A)	400–2000 A Main Lugs Terminal Box (Tenant Circuit Breakers used as Service Disconnects—6 maximum)	
	22 kA	QO-VH (125 A, 2P, 40–125 A) QO-VH (225 A, 2P, 40–60 A) [5]		
	25 kA	QD (225 A, 2P or 3P, 70–225 A)		
	42 kA	QOH (125 A, 2P, 40–125 A) QOH (225 A, 2P, 40–60 A) [5]		
	65 kA	QG (225 A, 2P or 3P, 70–225 A)		
	100 kA	QJ (225 A, 2P or 3P, 70–225 A) [6] LJL (125–400 A, 2P or 3P) [7]		
 <p>Figure 2 [4]</p>	<b>EZ Meter-Pak 225–2000 A Main Lugs Terminal Box Applications Protected by Remote Main—See Figure 2</b>			
	10 kA	QO (125 A, 2P, 40–125 A) QO (225 A, 2P, 40–125 A) [5] QB (225 A, 2P or 3P, 70–225 A) LJL (125–400 A, 2P or 3P) [7]	Must be protected by an upstream disconnecting means rated 10 k AIR minimum	
	22 kA	QO-VH (125 A, 2P, 40–125 A) QO-VH (225 A, 2P, 40–60 A) [5] LJL (125–400 A, 2P or 3P) [7]	Must be protected by an upstream disconnecting means rated 22 k AIR minimum	
	25 kA	QD (225 A, 2P or 3P, 70–225 A) LJL (125–400 A, 2P or 3P) [7]	Must be protected by an upstream disconnecting means rated 25 k AIR minimum	
	42 kA	QOH (125 A, 2P, 40–125 A) QOH (225 A, 2P, 40–60 A) [5] LJL (125–400 A, 2P or 3P) [7] QO-VH (125 A, 2P, 40–125 A) QO-VH (225 A, 2P, 40–60 A) [5] QD (225 A, 2P or 3P, 70–225 A)	Must be protected by an upstream disconnecting means rated 42 k AIR minimum	
	65 kA	QG (225 A, 2P or 3P, 70–225 A) LJL (125–400 A, 2P or 3P) [7] QO-VH (125 A, 2P, 40–125 A) QO-VH (225 A, 2P, 40–60 A) [5] QD (225 A, 2P or 3P, 70–225 A) LJL (125–400 A, 2P or 3P) [7]	Must be protected by an upstream disconnecting means rated 65 k AIR minimum	
	100 kA	QJ (225 A, 2P or 3P, 70–225 A) [6] LJL (125–400 A, 2P or 3P) [7] QO-VH (125 A, 2P, 40–125 A) QO-VH (225 A, 2P, 40–60 A) [5] QD (225 A, 2P only, 70–225 A) LJL (125–400 A, 2P or 3P) [7] QD (225 A, 3P only, 70–225 A) [6]	Must be protected by an upstream disconnecting means rated 100 k AIR minimum	
	<b>EZ Meter-Pak—Main Circuit Breaker Applications—See Figure 3</b>			
	10 kA	QO (125 A, 2P, 40–125 A) QO (225 A, 2P, 40–125 A) [5] QB (225 A, 2P or 3P, 70–225 A)	400–2000 A EZM Main Device with Type LH (400 A max.); MG or MJ (800 A max.); MH (1000 A max.); PG or PJ (1200 A max.); RG or RJ (2000 A max.)	
	65 kA	QO-VH (125 A, 2P, 40–125 A) QO-VH (225 A, 2P, 40–60 A) [5] QD (225 A, 2P or 3P, 70–225 A) LJL (125–400 A, 2P or 3P) [7]		
	 <p>Figure 3 [4]</p>	100 kA	QO-VH (125 A, 2P, 40–125 A) QO-VH (225 A, 2P, 40–60 A) [5] QD (225 A, 2P only, 70–225 A) QD (225 A, 3P only, 70–225 A) [6] LJL (125–400 A, 2P or 3P) [7] QD (225 A, 2P only, 70–225 A) QD (225 A, 3P only, 70–225 A) [6] LJL (125–400 A, 2P or 3P) [7]	1000 A Main Device with catalog number suffix "CBU" supplied with Type MHF circuit breaker.
		800–2000 A EZM Main Device with Type MJ (800 A max.); MHF (1000 A max.); PJ (1200 A max.) or RJ (2000 A max.)		
	<b>EZ Meter-Pak—Main Fusible Switch Applications—See Figure 3</b>			
10 kA	QO (125 A, 2P, 40–125 A) QO (225 A, 2P, 40–125 A) [5] QB (225 A, 2P or 3P, 70–225 A)	400–1200 A EZM Main Device (1Ø or 3Ø) with Class T (300 Vac) fuses installed.		
100 kA	QO-VH (125 A, 2P, 40–125 A) QO-VH (225 A, 2P, 40–60 A) [5] QD (225 A, 2P only, 70–225 A) QD (225 A, 3P only, 70–225 A) [6] LJL (125–400 A, 2P or 3P) [7]	400–1200 A EZM Main Device (1Ø or 3Ø) with Class T (300 Vac) fuses installed.		

[1] Tenant circuit breakers of same frame size having higher AIR values may replace tenant circuit breakers as listed in this table and maintain the series rating.  
 [2] Meter center short circuit current rating is equal to the lowest short circuit current rating given in table for any circuit breaker installed in any meter panelboard in the meter center.  
 [3] Short circuit current rating is measured at the LINE SIDE terminals of the integral mounted or remote mounted main providing overcurrent protection for the EZM metering equipment lineup.  
 [4] For three-tier series ratings refer to Data Bulletin 4100DB0301 and Instruction Bulletin 80043-303-22.  
 [5] Requires use of EZM125QOA adapter (order separately).  
 [6] 3P only tenant circuit breaker(s) are limited to: 100 kA Max. at 208Y/120 Vac or 65 kA Max at 240/120 Vac.  
 [7] Supplied with factory-installed circuit breaker(s), with an adjustable trip range of 125–400 A.

**1Ø 3W 120/240 Vac EZ Meter-Pak Meter Centers—  
1Ø, Indoor/Rainproof, UL Listed**

**1200 A Main CB/Fusible Switch Devices come Standard with 2-STEP Removable Service Entrance Endwalls**

Select EZM meter center short circuit current rating from [Table 2.16 UL Listed Meter Center Short Circuit Current Ratings \(SCCR\)](#), page 2-11. Using this table as a reference, make the following selections:

1. Select EZM 1Ø main device from [Table 2.17](#) or [Table 2.18](#), with an equal or higher short circuit rating than the application.
2. Select EZM 1Ø branch units from [Table 2.20](#) or [Table 2.21](#).
3. Select proper 2P type QO, QO-VH, QOH, QBP-TM, QDP-TM, QGP-TM or QJP-TM branch circuit breakers for use as tenant mains in branch unit from [Table 2.33](#) and [Table 2.34](#).
4. Select accessories as required from [Table 2.35](#).
5. Dimensions; see [page 2-22](#) and [page 2-23](#).

**Select Main Devices—NEMA 3R Construction**

**Table 2.17: 1Ø Main Devices**

Ampere Rating	Service Feed	Horizontal Cross Bus Rating and Bus Bar Material	Cat. No. [8]		Width (in.)	Factory-Installed Line Side Lug (Conductors per Phase and Neutral) Wire Size (AWG/kcmil)
<b>Main Circuit Breaker (1Ø Incoming and 1Ø Outgoing)</b>						
			65 kA	100 kA		
400	OH/UG	400 A, Al	EZM1400CB	—	18.66	(1) 1–600 or (2) 1–250
600	OH/UG	600 A, Al	EZM1600CB	—	18.66	(3) 3/0–500
800	OH/UG	800 A, Al	EZM1800CB	—	18.66	(3) 3/0–500
1000	OH/UG	1200 A, Cu	EZM11000CB	—	18.66	(3) 3/0–500
1200	OH	1200 A, Al	EZM11200GCBT [9]	EZM11200JCBT [9]	23.69	(4) 3/0–500
1200	UG	1200 A, Al	EZM11200GCBU [9] [10]	EZM11200JCBU [9] [10]	23.69	(4) 3/0–500
1600	UG	1200 A, Al/Cu	EZM11600GCBU [9] [11]	EZM11600JCBU [9] [11]	22.48	6 (Order Lugs Separately)
1600	OH/UG	1200 A, Al/Cu	EZM11600GCBC [9] [11]	EZM11600JCBC [9] [11]	30.19	(6) 1/0–750 or (12) 1/0–250
2000	OH/UG	1200 A, Al/Cu	—	EZM12000CB [11]	30.19	(6) 1/0–750 or (12) 1/0–250
2000	UG	1200 A, Al/Cu	—	EZM12000CBU [11]	30.19	6 (Order Lugs Separately)
<b>Main Fusible Switches (1Ø Incoming and 1Ø Outgoing) Requires 300 Vac Class T Fuses (Order Separately)</b>						
400	OH/UG	400 A, Al	—	EZM1400FS	18.66	(1) 1–600 or (2) 1–250
600	OH/UG	600 A, Al	—	EZM1600FS	18.50	(3) 3/0–500
600	UG	600 A, Al	—	EZM1600FSU	20.46	2 (Order Lugs Separately)
800	OH/UG	800 A, Al	—	EZM1800FS	18.50	(3) 3/0–500
800	UG	800 A, Al	—	EZM1800FSU	20.46	2 (Order Lugs Separately)
1200	OH	1200 A, Al	—	EZM11200FST	23.69	(4) 3/0–500
1200	UG	1200 A, Al	—	EZM11200FSB [10]	23.69	(4) 3/0–500
<b>Main Lug Terminal Boxes (1Ø Incoming and 1Ø Outgoing)</b>						
225	OH/UG	800 A, Al	—	EZM1225TB [12]	11.66	(1) 4–300
400	OH/UG	800 A, Al	—	EZM1400TB [13]	17.15	(2) 3/0–500
600	OH/UG	800 A, Al	—	EZM1600TB [13]	17.15	(2) 1/0–750 or (4) 1/0–300
800	OH/UG	800 A, Al	—	EZM1800TB [13]	18.66	(4) 3/0–500
800	OH/UG	800 A, Cu	—	EZM1800TBCU [13] [14]	24.08	(4) 3/0–500
1600	OH/UG	1200 A, Al/Cu	—	EZM11600TB [13] [14]	22.48	(6) 1/0–600 or (12) 1/0–300
2000	OH/UG	1200 A, Cu	—	EZM12000TB [13] [11]	30.19	6 (Order Lugs Separately)
<b>Main Circuit Breaker (1Ø Incoming and 1Ø Outgoing) with Energy Reduction Maintenance (ERMS)</b>						
1200	UG	1200 A, Al	EZM11200GCBUMS	EZM11200JCBUMS	26.39	(4) 3/0–500
1200	OH	1200 A, Cu	EZM11200GCBTMS	EZM11200JCBTMS	23.69	(4) 3/0–500
1600	OH/UG	1200 A, Cu	EZM11600GCBUMS	EZM11600JCBUMS	30.19	(6) 1/0–750 or (12) 1/0–250
1600	UG	1200 A, Al	EZM11600GCBUMS	EZM11600JCBUMS	30.19	6 (Order Lugs Separately)
2000	OH/UG	1200 A, Cu	EZM12000CBMS	—	30.19	(6) 1/0–750 or (12) 1/0–250
2000	UG	1200 A, Al	EZM12000CBUMS	—	30.19	6 (Order Lugs Separately)



EZM11200FST

[8] Does not meet EUSERC requirements.

[9] Ampere rating of the circuit breaker supplied with this device can be changed to a LOWER value in the field by changing the setting on the circuit breaker.

[10] For field installed Lug Landing Kit, order catalog number EZM1200ULL. Order lugs separately.

[11] Supplied with copper horizontal bus bars and aluminum vertical bus bars.

[12] 225 A terminal box supplied with isolated neutral that cannot be bonded NOT suitable for use on the LINE side of service equipment.

[13] Terminal box is suitable for use on LINE or LOAD side of service equipment. Supplied with isolated neutral and provided with neutral bonding kit for use as required. Refer to [page 2-11](#) for appropriate short circuit current ratings.

[14] Feed-thru lug kit available, see [page 2-21](#).

**Table 2.18: 1Ø Main Devices, EUSERC**

Ampere Rating	Service Feed	Horizontal Cross Bus Rating and Bus Bar Material	Cat. No.		Width (in.)	Factory-Installed Lug Landings for use with Crimp-Type Lugs (2-Hole Mounting) Qty. per Phase and Neutral, except non-EUSERC. [15]
<b>Main Circuit Breakers (1Ø Incoming and 1Ø Outgoing)[15]</b>						
			65 kA	100 kA		
400	UG	400 A, Al	EZM1400CBU [16]	—	20.46	1 (Order Lugs Separately)
600	UG	600 A, Al	EZM1600CBU [16]	—	26.19	2 (Order Lugs Separately)
800	UG	800 A, Al	EZM1800CBU [16]	—	26.19	2 (Order Lugs Separately)
1000	UG	1200 A, Cu	EZM11000CBU [17]	—	34.19	2 (Order Lugs Separately)
1200	UG	1200 A, Al	EZM11200GCBE [18]	EZM11200JCBE [18]	32.39	3 (Order Lugs Separately)
<b>Main Fusible Switches (1Ø Incoming and 1Ø Outgoing) [15] Requires 300 Vac Class T Fuses (Order Separately)</b>						
400	UG	400 A, Al	—	EZM1400FSU	20.46	1 (Order Lugs Separately)
600	UG	600 A, Al	—	EZM1600FSE	18.36	2 (Order Lugs Separately)
800	UG	800 A, Al	—	EZM1800FSE	18.36	2 (Order Lugs Separately)
1200	UG	1200 A, Al	—	EZM11200FSE	32.39	3 (Order Lugs Separately)
<b>Main Lug Terminal Boxes (1Ø Incoming and 1Ø Outgoing)</b>						
400	UG	800 A, Al	—	EZM1400TBU [19]	17.16	1 (Order Lugs Separately)
800	UG	800 A, Al	—	EZM1800TBU [19]	25.16	2 (Order Lugs Separately)
1200	UG	1200 A, Al/Cu	—	EZM11200TBU [19]	33.16	3 (Order Lugs Separately)
<b>Main Circuit Breaker (1Ø Incoming and 1Ø Outgoing) with Energy Reduction Maintenance Switch (ERMS)</b>						
1200	UG	1200 A, Al	EZM11200GCBEMS	EZM11200JCBEMS	32.39	3 (Order Lugs Separately)



EZM11200GCBE

METERING EQUIPMENT

2

[15] For mechanical lugs (3/0 AWG–600 kcmil) order kit CMEK4. Kit includes 4 lugs only. Multiple kits may be required, consult factory. For crimp-type lugs refer to Anderson Electrical Connector Products Catalog AEC-40R.

[16] Available by special order with main circuit breaker supplied with other standard ampere ratings, consult local Field Office (allow 6 weeks for delivery).

[17] Supplied with copper horizontal bus bars and aluminum vertical bus bars.

[18] Ampere rating of the circuit breaker supplied with this device can be changed to a LOWER value in the field by changing the setting on the circuit breaker.

[19] Terminal box is suitable for use on LINE or LOAD side of service equipment. Supplied with isolated neutral and provided with neutral bonding kit for use as required. Refer to page 2-11 for appropriate short circuit current ratings.

1 Phase Branch Devices—NEMA 3R Construction

Table 2.19: Branch Units—1Ø Incoming and 1Ø Outgoing

System Type	Number of Meter Sockets	Horizontal Cross Bus Rating and Bus Bar Material	Ring Type 4-Jaw Meter Socket without Bypass [20]		Ringless Type 5-Jaw Meter Socket without Bypass		Ringless Type 5-Jaw Meter Socket with Horn Bypass		Ringless Type 5-Jaw Meter Socket with Lever Bypass	
			Cat. No	Width (in.)	Cat. No	Width (in.)	Cat. No	Width (in.)	Cat. No	Width (in.)
125 A Maximum (Order Type QO, QO-VH or QOH Circuit Breakers Separately) [21][22]										
1Ø3W 120/240 Vac 2P Branch Circuit Breakers	3	800 A Al	EZM113125 [23]	12.25	EZMR113125 [23]	12.25	EZMH113125 [23]	12.25	EZML113125 [23]	15.56
		1200 A Cu	EZM113125CUX		EZMR113125CUX		EZMH113125CUX		EZML113125CUX	
	4	800 A Al	EZM114125 [23]		EZMR114125 [23]		EZMH114125 [23]		EZML114125 [23]	
		1200 A Cu	EZM114125CUX		EZMR114125CUX		EZMH114125CUX		EZML114125CUX	
	5	800 A Al	EZM115125 [23]		EZMR115125 [23]		EZMH115125 [23]		EZML115125 [23]	
		1200 A Cu	EZM115125CUX		EZMR115125CUX		EZMH115125CUX		EZML115125CUX	
6	800 A Al	EZM116125 [23]	EZMR116125 [23]	EZMH116125 [23]	EZML116125 [23]					
1200 A Cu	EZM116125CUX	EZMR116125CUX	EZMH116125CUX	EZML116125CUX						
225 A Maximum Branch Units (Order Type QBP-TM, QDP-TM, QGP-TM or QJP-TM Circuit Breakers Separately) [24]										
1Ø3W 120/240 Vac 2P Branch Circuit Breakers	2	800 A Al	EZM112225 [23]	17.38	EZMR112225 [23]	17.38	EZMH112225 [23]	17.38	—	—
		1200 A Cu	EZM112225CUX		EZMR112225CUX		EZMH112225CUX		—	—
	3	800 A Al	EZM113225 [23]		EZMR113225 [23]		EZMH113225 [23]		—	—
		1200 A Cu	EZM113225CUX		EZMR113225CUX		EZMH113225CUX		—	—
	4	800 A Al	EZM114225 [23]		EZMR114225 [23]		EZMH114225 [23]		—	—
		1200 A Cu	EZM114225CUX		EZMR114225CUX		EZMH114225CUX		—	—
5	1200 A Al/Cu	EZM115225	EZMR115225	EZMH115225	—	—				
1200 A Cu	EZM115225CU	EZMR115225CU	EZMH115225CU	—	—					
6	1200 A Cu	EZM116225	EZMR116225	EZMH116225	—	—				

Table 2.20: Branch Units—225 A Maximum Commercial  
(Order Type QBP-TM, QDP-TM, QGP-TM or QJP-TM Circuit Breakers Separately) [25]

System Type	Number of Meter Sockets	Horizontal Cross Bus Rating and Bus Bar Material	Ringless Type 5-Jaw Meter Socket with Lever Bypass and Jaw Release		Ring Type 5-Jaw Meter Socket with Test Block Bypass. Meets EUSERC Requirements	
			Cat. No.	Width (in.)	Cat. No.	Width (in.)
1Ø3W 120/240 Vac 2P Branch Circuit Breakers	1	1200 A Al/Cu	EZML112225	19.44	EZMT112225 [26]	22.42
		1200 A Cu	EZML112225CU		—	—
		1200 A Al/Cu	EZML112225D [27]		—	—
	2	1200 A Al/Cu	EZML112225	19.44	EZMT112225 [26]	22.42
		1200 A Cu	EZML112225CU		—	—
	3	1200 A Al/Cu	EZML11225D [27]	19.44	EZMT113225 [26][28]	22.42
		1200 A Cu	EZML113225CU		—	—
	4	1200 A Al/Cu	EZML113225	19.44	—	—
		1200 A Al/Cu	EZML113225D [27]		—	—
		1200 A Cu	EZML114225		—	—
	1200 A Al/Cu	EZML114225CU	—	—		
	1200 A Al/Cu	EZML114225D [27]	—	—		

Table 2.21: Branch Units—400 A Maximum Commercial

System Type	Number of Meter Sockets	Main Cross Bus Rating and Bus Bar Material	Ringless Type 5-Jaw Meter Socket with Lever Bypass and Jaw Release. Includes Factory-Installed 400 A Type L.J.L. Circuit Breaker [29] [30]		Ringless Type K Bolt-on 4-Jaw Meter Socket with Manual Bypass. Includes Factory-Installed 400 A Type L.J.L. Circuit Breaker [30]	
			Cat. No.	Width (in.)	Cat. No.	Width (in.)
1Ø3W 120/240 Vac 2P Branch Circuit Breakers	1	1200 A Cu	EZML111400	23.21	EZMK111400	27.56
	2	1200 A Cu	EZML112400	23.21	EZMK112400	27.56

[20] Snap-on aluminum sealing rings supplied as standard.  
 [21] Supplied with removable drip hood and equipped with an indoor top endwall with knockouts provided.  
 [22] Compatible with a branch terminal box accommodating a maximum conductor size of 300 kcmil when voltage drop calculations require sizes over 2/0, see Table 1.35: Accessories, page 2-21.  
 [23] For 1200 A main cross bus add suffix "X" to catalog number (Example: EZM314125X). Allow 6 weeks for delivery.  
 [24] Type QO, QO-VH and QOH branch circuit breakers (40–60 A) may be installed with use of EZM125QOA adapter kits, see page 2-21.  
 [25] 2P Type QO (40–125 A, 10 kA max. meter center SCCR) or QO-VH and QO-H (40–60 A, 100 kA max. meter center SCCR) may be installed using EZM125QOA adapter kit, see page 2-21.  
 [26] Supplied with bondable neutral, suitable for use as service equipment. Use main lugs terminal box type EZM-TBU for Six Disconnect Rule applications to feed this device. Supplied with copper horizontal bus bars and aluminum vertical bus bars.  
 [27] Supplied with removable drip hood and equipped with an indoor top endwall with knockouts provided.  
 [28] Does not meet EUSERC 48 in. minimum / 75 in. maximum meter height requirements for outdoor installations. The bottom meter socket is 37 inches above ground when the device is mounted with the top meter socket at 75 inches above ground. EUSERC indoor requirements are 36 in. minimum / 75 in. maximum.  
 [29] Supplied with Class 320 lever bypass meter socket. Utilizes anti-inversion clip kit MMLRK, if required, refer to page 2-21.  
 [30] L.J.L. circuit breaker has adjustable trip settings from 125-400 A. Use seal kit MICROTUSEAL, if required. L.J.L. circuit breaker terminal lug kit factory-installed and accommodates (2) 2/0-500 kcmil Cu-Al per phase. Alternate lug kit AL400L61K3 for L.J.L. circuit breaker is available, see page 2-21.

**3Ø4W 208Y/120 Vac or 240/120 Vac Delta EZ Meter-Pak™ Meter Centers—3Ø Indoor/Rainproof, UL Listed**

**1200 A Main CB/Fusible Switch Devices come Standard with 2-STEP Removable Service Entrance Endwalls**

Select EZM meter center short circuit current rating from Table 2.16. Using this table as a reference, make the following selections:

1. Select 3Ø EZM main device below with an equal or higher short circuit rating than the application from Table 2.22 and Table 2.23.
2. Select EZM 3Ø branch units from , Table 2.25, and Table 2.26.
3. Select proper 2P type QO, QO-VH, QOH, QBP-TM, QDP-TM, QGP-TM or QJP-TM or 3P QBP-TM, QDP-TM, QGP-TM or QJP-TM branch circuit breakers for use as tenant mains in branch unit; from Table 2.33 and Table 2.34.
4. Select accessories as required, from page 2-21.
5. Dimensions see page 2-22.

**3 Phase Main Devices—NEMA 3R Construction**

**Table 2.22: 3Ø Main Devices**

Ampere Rating	Service Feed	Horizontal Cross Bus Rating and Bus Bar Material	Cat. No. [31]		Width (in.)	Factory-Installed Line Side Lug (Conductors per Phase and Neutral) Wire Size (AWG-kcmil)
<b>Main Circuit Breakers (3Ø Incoming and 3Ø Outgoing)</b>						
<b>65 kA Short Circuit Current Rating (400–1600 A Max.), 100 kA Short Circuit Current Rating (2000 A Max.)</b>						
Short Circuit Rating			65 kA		100 kA	
400	OH/UG	400 A, Al	EZM3400CB	—	18.66	(1) 1–600 or (2) 1–250
600	OH/UG	600 A, Al	EZM3600CB	—	18.66	(3) 3/0–500
800	OH/UG	800 A, Al	EZM3800CB	—	18.66	(3) 3/0–500
1000	OH/UG	1200 A, Al	EZM31000CB	—	18.66	(3) 3/0–500
1200	OH	1200 A, Al	EZM31200GCBT [32]	EZM31200JCBT [32]	23.69	(4) 3/0-500
1200	UG	1200 A, Al	EZM31200GCBU [33] [32]	EZM31200JCBU [33] [32]	23.69	(4) 3/0-500
1600	OH/UG	1200 A, Al/Cu	EZM31600GCBC [32] [34]	EZM31600JCBC [32] [34]	30.19	(6) 1/0–750 or (12) 1/0–250
1600	UG	1200 A, Al/Cu	EZM31600GCBU [32] [34]	EZM31600JCBU [32] [34]	30.19	6 (Order Lugs Separately)
2000	OH/UG	1200 A, Al/Cu	—	EZM32000CB [34]	30.19	(6) 1/0–750 or (12) 1/0–250
2000	UG	1200 A, Al/Cu	—	EZM32000CBU [34]	30.19	6 (Order Lugs Separately)
<b>Main Fusible Switches (3Ø Incoming and 3Ø Outgoing) Requires 300 Vac Class T Fuses (Order Separately)</b>						
400	OH/UG	400 A, Al	—	EZM3400FS	18.66	(1) 1–600 or (2) 1–250
600	OH/UG	600 A, Al	—	EZM3600FS	18.66	(3) 3/0–500
800	OH/UG	800 A, Al	—	EZM3800FS	18.66	(3) 3/0–500
1200	OH	1200 A, Al	—	EZM31200FST	23.69	(4) 3/0–500
1200	UG	1200 A, Al	—	EZM31200FSB [37]	23.69	(4) 3/0-500
<b>Main Lug Terminal Boxes (3Ø Incoming and 3Ø Outgoing)</b>						
225	OH/UG	800 A, Al	—	EZM3225TB [35]	11.66	(1) 4–300
400	OH/UG	800 A, Al	—	EZM3400TB [36]	17.15	(2) 3/0–500
600	OH/UG	800 A, Al	—	EZM3600TB [36]	17.15	(2) 1/0–750 or (4) 1/0–300
800	OH/UG	800 A, Al	—	EZM3800TB [36]	18.66	(4) 3/0–500
800	OH/UG	800 A, Cu	—	EZM3800TBCU [36] [37]	24.08	(4) 3/0–500
1600	OH/UG	1200 A, Al/Cu	—	EZM31600TB [34] [37] [36]	22.48	(6) 1/0-600 or (12) 1/0-300
2000	OH/UG	1200 A, Cu	—	EZM32000TB [36]	30.19	6 (Order Lugs Separately)
<b>Main Circuit Breakers (3Ø Incoming and 3Ø Outgoing) with Energy Reduction Maintenance Switch (ERMS)</b>						
1200	OH	1200 A, Cu	EZM31200GCBTMS	EZM31200JCBTMS	23.69	(4) 3/0–500
1200	UG	1200 A, Cu	EZM31200GCBUMS	EZM31200JCBUMS	23.69	(4) 3/0–500
1600	OH/UG	1200 A, Cu	EZM31600GCBCMS	EZM31600JCBCMS	30.19	(6) 1/0–750 or (12) 1/0–250
1600	UG	1200 A, Cu	EZM31600GCBUMS	EZM31600JCBUMS	30.19	6 (Order Lugs Separately)
2000	OH/UG	1200 A, Cu	EZM32000CBMS	—	30.19	(6) 1/0–750 or (12) 1/0–250
2000	UG	1200 A, Cu	EZM32000CBUMS	—	30.19	6 (Order Lugs Separately)



[31] Does not meet EUSERC requirements.  
 [32] Ampere rating of the circuit breaker supplied with this device can be changed to a LOWER value in the field by changing the setting on the circuit breaker.  
 [33] For field installed Lug Landing Kit order catalog number EZM1200ULL.  
 [34] Supplied with copper horizontal bus bars and aluminum vertical bus bars.  
 [35] 225 A terminal box supplied with isolated neutral that cannot be bonded.  
 [36] Terminal box is suitable for use on LINE or LOAD side of service equipment. Supplied with isolated neutral and provided with neutral bonding kit for use as required. Refer to page 2-11 for appropriate short circuit current ratings.  
 [37] Feed-thru lug kit available, see Table 2.35

Table 2.23: 3Ø Main Devices, EUSERC

	Ampere Rating	Service Feed	Horizontal Cross Bus Rating and Bus Bar Material	Cat. No.		Width (in.)	Factory-Installed Lug Landings For use with Crimp-Type Lugs (2-Hole Mounting) Qty. per Phase and Neutral, except non-EUSERC device. [38]
 <p>EZM31200GCBEMS</p>	<b>Main Circuit Breakers (3Ø Incoming and 3Ø Outgoing)</b>						
	Short Circuit Rating			65 kA	100 kA		
	400	UG	400 A, Al	EZM3400CBU [39]	—	20.46	1 (Order Lugs Separately)
	600	UG	600 A, Al	EZM3600CBU [39]	—	26.19	2 (Order Lugs Separately)
	800	UG	800 A, Al	EZM3800CBU [39]	—	26.19	2 (Order Lugs Separately)
	1000	UG	1200 A, Cu	EZM31000CBU	—	34.19	3 (Order Lugs Separately)
	1200	UG	1200 A, Al	EZM31200GCBE [40]	EZM31200JCBE [40]	32.39	3 (Order Lugs Separately)
	<b>Main Fusible Switches (3Ø Incoming and 3Ø Outgoing) Requires 300 Vac Class T Fuses (Order Separately)</b>						
	400	UG	400 A, Al	—	EZM3400FSU	20.46	1 (Order Lugs Separately)
	600	UG	600 A, Al	—	EZM3600FSU	26.19	2 (Order Lugs Separately)
800	UG	800 A, Al	—	EZM3800FSU	26.19	2 (Order Lugs Separately)	
1200	UG	1200 A, Al	—	EZM31200FSE	32.39	3 (Order Lugs Separately)	
<b>Main Lugs Terminal Boxes (3Ø Incoming and 3Ø Outgoing)</b>							
400	UG	400 A, Al	—	EZM3400TBU [41]	17.16	1 (Order Lugs Separately)	
800	UG	800 A, Al	—	EZM3800TBU [41]	25.16	2 (Order Lugs Separately)	
1200	UG	1200 A, Cu	—	EZM31200TBU [41]	33.16	3 (Order Lugs Separately)	
<b>Main Circuit Breaker (3Ø Incoming and 3Ø Outgoing) with Energy reduction Maintenance Switch (ERMS)</b>							
1200	UG	1200 A, Cu	EZM31200GCBEMS	EZM31200JCBEMS	32.39	3 (Order Lugs Separately)	

2

METERING EQUIPMENT

[38] For mechanical lugs (3/0 AWG–600 kcmil) order kit CMEK4. Kit includes 4 lugs only. Multiple kits may be required, consult factory. For crimp-type lugs refer to Anderson Electrical Connector Products Catalog AEC-40R.

[39] Available by special order with main circuit breaker supplied with other standard ampere ratings, consult your nearest Field Sales Office (allow 6 weeks for delivery).

[40] Ampere rating of the circuit breaker supplied with this device can be changed to a LOWER value in the field by changing the setting on the circuit breaker.



[41] Terminal box is suitable for use on LINE or LOAD side of service equipment. Supplied with isolated neutral and provided with neutral bonding kit for use as required. Refer to page 2-11 for appropriate short circuit current ratings.

**3 Phase Branch Devices—NEMA 3R Construction**

**Table 2.24: Branch Units—3Ø Incoming and 1Ø Outgoing**

System Type	Number of Meter Sockets	Horizontal Cross Bus Rating [42] and Bus Bar Material	Ring Type 5-Jaw Meter Socket without Bypass [43]		Ringless Type 5-Jaw Meter Socket without Bypass		Ringless Type 5-Jaw Meter Socket with Horn Bypass		Ringless Type 5-Jaw Meter Socket with Lever Bypass					
			Cat. No	Width (in.)	Cat. No	Width (in.)	Cat. No	Width (in.)	Cat. No	Width (in.)				
125 A Maximum (Order Type QO, QO-VH or QO-H Circuit Breakers Separately) [44] [45]														
3Ø4W 208Y/120 Vac 5-Jaw-Meter Socket 2P Branch Circuit Breakers	3	800 A Al	EZM313125 [42]	12.25	EZMR313125 [42]	12.25	EZMH313125 [42]	12.25	EZML313125 [42]	15.56				
		800 A Al	EZM313125M10 [46]		—		—		—					
		1200 A Cu	EZM313125CUX		EZMR313125CUX		EZMH313125CUX		EZML313125CUX					
	4	800 A Al	EZM314125 [42]		EZMR314125 [42]		EZMH314125 [42]		EZML314125 [42]					
		800 A Al	EZM314125M10 [46]		—		—		—					
		1200 A Cu	EZM314125CUX		EZMR314125CUX		EZMH314125CUX		EZML314125CUX					
	5	800 A Al	EZM315125 [42]		EZMR315125 [42]		EZMH315125 [42]		EZML315125 [42]					
		800 A Al	EZM315125M10 [46]		—		—		—					
		1200 A Cu	EZM315125CUX		EZMR315125CUX		EZMH315125CUX		EZML315125CUX					
	6	800 A Al	EZM316125 [42]		EZMR316125 [42]		EZMH316125 [42]		EZML316125 [42]					
		800 A Al	EZM316125M10 [46]		—		—		—					
		1200 A Cu	EZM316125CUX		EZMR316125CUX		EZMH316125CUX		EZML316125CUX					
225 A Maximum (Order Type QBP-TM, QDP-TM, QGP-TM or QJP-TM Circuit Breakers Separately) [47]														
3Ø4W 208Y/120 Vac 5-Jaw-Meter Socket 2P Branch Circuit Breakers	2	800 A Al	EZM312225 [42]	17.38	EZMR312225 [42]	17.38	EZMH312225 [42]	17.38	—	—				
		1200 A Cu	EZM312225CUX		EZMR312225CUX		EZMH312225CUX		—					
	3	800 A Al	EZM313225 [42]		EZMR313225 [42]		EZMH313225 [42]		—					
		1200 A Cu	EZM313225CUX		EZMR313225CUX		EZMH313225CUX		—					
	4	800 A Al	EZM314225 [42]		EZMR314225 [42]		EZMH314225 [42]		—					
		1200 A Cu	EZM314225CUX		EZMR314225CUX		EZMH314225CUX		—					
	5	1200 A Al/Cu	EZM315225		EZMR315225		EZMH315225		—					
		1200 A Cu	EZM315225CU		EZMR315225CU		EZMH315225CU		—					
	6	1200 A Al/Cu	EZM316225		EZMR316225		EZMH316225		—					
		1200 A Cu	EZM316225CU		EZMR316225CU		EZMH316225CU		—					
			1200 A Al/Cu		EZM316225CA		EZMR316225CA		EZMH316225CA		—	—	—	—

**Table 2.25: Branch Units—225 A Maximum Commercial**

System Type	Number of Meter Sockets	Horizontal Cross Bus Rating and Bus Bar Material	Ringless Type Meter Socket without Bypass		Ringless Type Meter Socket with Lever Bypass and Jaw Release		Ring Type Meter Socket with Test Block Bypass. Meets EUSERC Requirements			
			Cat. No.	Width (in.)	Cat. No.	Width (in.)	Cat. No.	Width (in.)		
3Ø Incoming and 1Ø Outgoing [48] (Order Type QBP-TM, QDP-TM, QGP-TM or QJP-TM circuit breakers separately) [49]										
 EZM311225	3Ø4W 208Y/120 Vac 5-Jaw Meter Sockets 2P Branch Circuit Breakers	1	1200 A Al/Cu	—	—	—	EZMT311225 [50]	22.42		
			1200 A Al/Cu	—	—	EZML312225	EZMT312225 [50]	22.42		
		2	1200 A Cu	—	—	EZML312225CU	—	—		
			1200 A Al/Cu	—	—	EZML312225D [44]	19.44	—		
		3	1200 A Al/Cu	—	—	EZML313225	19.44	EZMT313225 [50][51]	22.42	
			1200 A Cu	—	—	EZML313225CU	—	—		
	4	1200 A Al/Cu	—	—	EZML314225	19.44	—			
		1200 A Cu	—	—	EZML314225CU	—	—			
				1200 A Al/Cu	—	—	EZML314225D [44]	—		
	3Ø Incoming and 3Ø Outgoing (Order QBP-TM, QDP-TM, QGP-TM or QJP-TM circuit breakers separately, see [49])									
	 EZML313225   EZMT311225 Without Cover	3Ø4W 240/120 Vac Delta or 208Y/120 Vac 7-Jaw Meter Socket 3P Branch Circuit Breakers	1	1200 A Al/Cu	—	—	EZML331225	19.44	EZMT331225 [50]	22.42
				1200 A Cu	—	—	EZML331225CU	—	—	
2			1200 A Al/Cu	EZMR332225	19.44	EZML332225D [44]	19.44	EZMT332225 [50]	22.42	
			1200 A Cu	EZMR332225CU	—	EZML332225	—	—		
3			1200 A Al/Cu	EZMR333225	19.44	EZML33225D [44]	19.44	EZMT333225 [50][51]	22.42	
			1200 A Cu	EZMR333225CU	—	EZML333225	—	—		
4			1200 A Al/Cu	EZMR334225	19.44	EZML333225CU	19.44	—		
			1200 A Cu	EZMR334225CU	—	EZML333225D [44]	—	—		
					1200 A Al/Cu	—	—	EZML334225	19.44	—
					1200 A Cu	—	—	EZML334225CU	—	—
					1200 A Al/Cu	—	—	EZML334225D [44]	19.44	—

[42] For 1200 A main cross bus, add suffix "X" to catalog number. Example: EZMR313125X.. Allow 6 weeks for delivery.  
 [43] Snap-On aluminum sealing rings supplied as standard.  
 [44] Supplied with removable drip hood and equipped with an indoor top endwall with knockouts provided.  
 [45] Compatible with a branch terminal box accommodating a maximum conductor size of 300 kcmil when voltage drop calculations require sizes over 2/0, see Table 1.35: Accessories, page 2-21.  
 [46] Distance between meter sockets as measured from centerline to centerline is 10 inches.  
 [47] 2P Type QO (40–125 A, 10 kA max. meter center SCCR) or QO-VH and QO-H (40–60 A, 100 kA max. meter center SCCR) may be installed using EZM125QOA adapter kit, see page 2-21.  
 [48] For 240/120 Vac Delta Systems add Suffix "CA" to catalog number (Example: EZM314125CA). All meter sockets are phased A and C only. Price remains the same as the base catalog number. Order only branch units, not stocked in PDS (6-week delivery).  
 [49] 2P Type QO (40–125 A, 10 kA max. meter center SCCR) or QO-VH and QO-H (40–60 A, 100 kA max. meter center SCCR) may be installed using EZM125QOA adapter kit, refer to .  
 [50] Supplied with bondable neutral, suitable for use as service equipment. Use main lugs terminal box type EZM-TBU for Six Disconnect Rule applications to feed this device. Supplied with copper horizontal bus bars and aluminum vertical bus bars.  
 [51] Does not meet EUSERC 48 in. minimum / 75 in. maximum meter height requirements for outdoor installations. The bottom meter socket is 37 inches above ground when the device is mounted with the top meter socket at 75 inches above ground. EUSERC indoor requirements are 36 in. minimum / 75 in. maximum.  
 For 400 A maximum Commercial Branch Units, see page 2-18.





EZMK311400

Table 2.26: Branch Units—400 A Maximum Commercial

System Type	Number of Meter Sockets	Horizontal Cross Bus Rating	Ringless Type Meter Socket with Lever Bypass and Jaw Release—Includes Factory-Installed 400 A Type LJL Circuit Breaker. [52], [53]		Ringless Type K Bolt-on Meter Socket with Manual Bypass—Includes Factory-Installed 400 A Type LJL Circuit Breaker. [53]	
			Cat. No.	Width (in.)	Cat. No.	Width (in.)
<b>3Ø Incoming and 1Ø Outgoing [54]</b>						
3Ø4W 208Y/120 Vac 5-Jaw Meter Socket 2P Circuit Breakers	1	1200 A Cu	EZML311400	23.21	EZMK311400	27.56
	2	1200 A Cu	EZML312400	23.21	EZMK312400	27.56
<b>3Ø Incoming and 3Ø Outgoing</b>						
3Ø4W 240/120 Vac Delta or 208Y/120 Vac 7-Jaw Meter Socket 3P Circuit Breakers	1	1200 A Cu	EZML331400	23.21	EZMK331400	27.56
	2	1200 A Cu	EZML332400	23.21	EZMK332400	27.56

**3Ø–1Ø OUT EZM Branch Unit Phase Balancing Flexibility**

The major benefit of factory phase balancing is that most jobs will not require field phase balancing. To see if meter socket phase balancing in the field is required (refer to wiring diagram for complete instructions):

- A. Determine if the load in amperes on each phase of the transformer using handle rating of tenant circuit breakers installed at each number of meter sockets. Use Phase Balancing Chart to determine total number of connections each meter socket makes on each phase of transformer.
- B. If phase balancing is required, determine which meter sockets should be changed to properly phase balance metering equipment lineup.
- C. Once meter socket(s) is selected to be phase balanced, remove individual meter socket cover from each meter socket to be phase balanced. The vertical bus bars running top to bottom in the branch unit behind each meter socket are phased: **AØ, BØ, CØ, left to right.**
- D. By moving only the line side meter socket “Z” shaped connectors per meter socket to be changed, phase balancing can easily be accomplished on-site:

Starting Position	can be changed to	Possible Ending Position (By moving only one “Z” connector)
AØ and BØ	can be changed to	AØ and CØ
AØ and CØ	can be changed to	AØ and BØ or BØ and CØ
BØ and CØ	can be changed to	AØ and CØ

Table 2.27: Example: To change an AØ and CØ meter socket to a BØ and CØ socket

<p style="text-align: center;">A      B      C</p> <p style="text-align: center;">Starting Position Meter Socket Phasing: AØ and CØ</p>	<p style="text-align: center;">Step 2: Loosen hex nut from AØ line side meter socket jaw and slide “Z” connector down to free connector from stud.</p>	<p style="text-align: center;">Step 1: Remove hex nut from AØ line side connection to vertical bus.</p>
<p style="text-align: center;">Step 3: Rotate “Z” connector to right and align with stud on BØ vertical bus.</p>	<p style="text-align: center;">Step 4: Slide “Z” connector up to engage stud on BØ vertical bus. Torque hex nut of meter socket jaw to 75 lb-in (8 N·m).</p>	<p style="text-align: center;">Step 6: Replace hex nut (removed in Step 1) onto stud of BØ vertical bus and torque to 75 lb-in (9 N·m). Phase balancing of meter socket is complete: BØ and CØ.</p>

[52] Supplied with Class 320 lever bypass meter socket. Use anti-inversion clip kit, catalog number MMLRK, if required. See page 2-21.

[53] LJL circuit breaker has adjustable trip settings from 125-400 A. Use seal kit MICROTUSEAL, if required. LJL circuit breaker terminal lug kit factory-installed and accommodates (2) 2/0-500 kcmil Cu-Al per phase. Alternate lug kit AL400L61K3 for LJL circuit breaker is available, see page 2-21.

[54] For 240/120 Vac Delta Systems add Suffix “CA” to catalog number (Example: EZML312400CA). All meter sockets are phased A and C only. Price remains the same as the base catalog number. “Order only” branch units, not stocked in PDS (4–6 week delivery). Order point Lexington.

**EZM Main with Busway Side Tap**

EZ Meter-Pak metering equipment is available for use in high rise applications for connection to 800–5000 A I-Line™ or I-Line II plug-in busway installed as a vertical riser. Three phase only EZM main devices in the form of a main circuit breaker or main fusible switch are available with an integral busway tap extending from the right or left side of the main device and phased to align with the busway for either neutral front or neutral back installations.

**Busway Mains, 3Ø only (Indoor only) ordering instructions:**

- Step 1: Determine height to center line of busway plug-in opening, check local utility requirements for minimum and maximum meter socket heights.
- Step 2: Determine side of EZM main section for busway tap to extend from (busway tap is an integral part of the main and extends to the left or right on the EZM device as viewed from the front).
- Step 3: Check phasing of busway riser to insure that it matches phasing of busway tap on main section (indicated as neutral front or neutral back as viewed from the front).
- Step 4: Select Cat. No. from tables below.
- Step 5: Busway main devices are build to order specials and require 4 to 6 weeks for delivery.

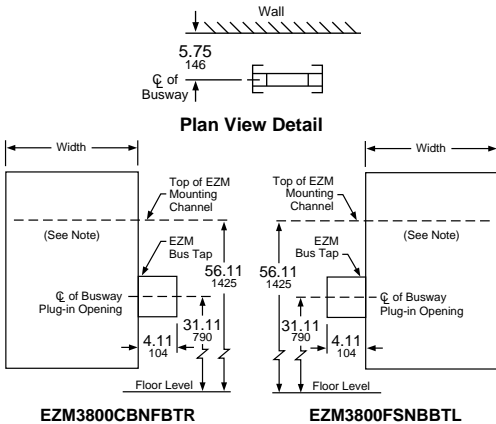

**Table 2.28: EZM Busway Side Tap Mains Devices**

Number Segment	Character	Description	EZM	3	800	CB	NF	BTR
Device Name	EZM	EZ Meter-Pak Meter Center						
Service Feed	3	3Ph, 4W						
Mains Rating		400 A 600 A 800 A 1000 A 1200 A						
Main Type		CB Main Circuit Breaker FS Main Fusible Switch GB Main Circuit Breaker (65 kAIC) JB Main Circuit Breaker (100kAIC)						
Neutral Position		NF Neutral Front NB Neutral Back						
Bus Tap Location		BTL Bus Tap Left BTR Bus Tap Right						

This table is for interpreting existing part numbers only. All possible combinations are not available.

**Table 2.29: 1200 A EZM Mains with Busway Side Tap (Three Phase Only—Note positioning left or right below)**

Ampere Rating	Width (in.)	Horizontal Cross Bus Rating	Busway to LEFT of EZM Metering Equipment Lineup		Busway to RIGHT of EZM Metering Equipment Lineup	
			Neutral Front	Neutral Back	Neutral Front	Neutral Back
<b>Main Circuit Breaker with Busway Tap</b>						
65,000 RMS Symmetrical Amperes Maximum Short Circuit Current Rating						
400	18.66	400 A Al	EZM3400CBNFBTL	EZM3400CBNFBTR	EZM3400CBNFBTR	EZM3400CBNBBTR
600	18.66	600 A Al	EZM3600CBNFBTL	EZM3600CBNFBTR	EZM3600CBNFBTR	EZM3600CBNBBTR
800	18.66	800 A Al	EZM3800CBNFBTL	EZM3800CBNFBTR	EZM3800CBNFBTR	EZM3800CBNBBTR
1000	18.66	1000 A Al	EZM31000CBNFBTL [55]	EZM31000CBNFBTR [55]	EZM31000CBNFBTR [55]	EZM31000CBNBBTR [55]
1200	23.36	1200 A Cu	EZM31200GBNFBTL [55]	EZM31200GBNFBTR [55]	EZM31200GBNFBTR [55]	EZM31200GBNBBTR [55]
100,000 RMS Symmetrical Amperes Maximum Short Circuit Current Rating						
1200	23.36	1200 A Cu	EZM31200JBNFBTL [55]	EZM31200JBNFBTR [55]	EZM31200JBNFBTR [55]	EZM31200JBNBBTR [55]
<b>Main Fusible Switch with Busway Tap Requires Class T (300 Vac) Fuses - Order Separately</b>						
100,000 RMS Symmetrical Amperes Maximum Short Circuit Current Rating						
400	18.66	400 A Al	EZM3400FSNFBTL	EZM3400FSNFBTR	EZM3400FSNFBTR	EZM3400FSNBBTR
600	18.66	600 A Al	EZM3600FSNFBTL	EZM3600FSNFBTR	EZM3600FSNFBTR	EZM3600FSNBBTR
800	18.66	800 A Al	EZM3800FSNFBTL	EZM3800FSNFBTR	EZM3800FSNFBTR	EZM3800FSNBBTR
1200	22.36	1200 A Cu	EZM31200FSNFBTL [55]	EZM31200FSNFBTR [55]	EZM31200FSNFBTR [55]	EZM31200FSNBBTR [55]

**NOTE:** Dimensions shown position the centerline of top meter socket of a 125 A, 5-Gang or 6-Gang branch unit at 72" above floor level. Check with utility to meet local requirements.

**Busway Transition Section**

EZM busway transition section provides no overcurrent protection for the downstream EZM branch units.

Tenant main circuit breakers in these branch units must be selected as "fully rated" equipment. (Examples: QO for 10 kA, QO-VH for 22 kA or QOH for 42 kA.)

**Table 2.30: EZM Busway Transition Sections (3Ø only)**

Ampere Rating	I-Line™ Busway location	Neutral Front	Neutral Back	Width (in.)
1200	RIGHT of EZM Transition Section	EZM3BUSRF	EZM3BUSRB	12.00
1200	LEFT of EZM Transition Section	EZM3BUSLF	EZM3BUSLB	12.00

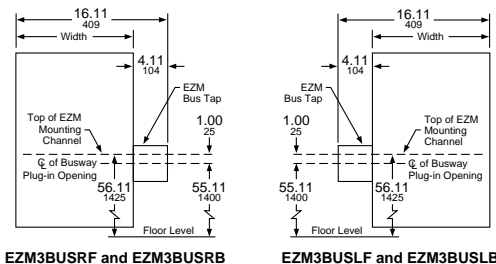

[55] Requires use of branch units supplied with 1200 A horizontal cross bus.



### EZM Main with Center-Mounted Busway Tap

The EZM Main with center-mounted busway tap is a space-saving design for high rise applications that is installed as an integral component of the vertical riser busway and allows standard EZM branches to be mounted from both sides. See online digest updates for availability or contact your local field sales office for additional information

### EZM Busway Center Tap Mains

The EZM Busway Center Tap mains offer provides a convenient space saving method for connecting EZM Branch Meter sections to I-Line II Busway in vertical riser applications. The mains are connected "inline" with the Busway column conserving precious electrical room space.

1. The Part Number Coding Table is to be used for interpreting existing part numbers only. All possible combinations are not available. Please contact product support for additional references needed.
2. Outgoing Feeder Bus Joint-Pak is included with each EZM CTM Section.
3. EZM Horizontal Cross Bus is 1200 A Copper Only
4. Busway Center Tap Mains are fully NEMA 3R Rated.
5. Mains Devices are fully sealable by utility.
6. EZM Branch units are installed using the mounting kit - EZMCTMKIT.
7. Short circuit current rating = 150,000 symmetrical amps.
8. EZM CTM is configured for neutral front only (G-> N-> C-> B->A-> G) as viewed front to rear.
9. Compatible with I-LINE II Busway rated 2000–5000 A.
10. Includes factory installed PowerPact M- and P-frame Circuit Breakers and Switches (Rated 600–1200 A.)
11. Fully compatible with all standard EZ Meter-Pak Branch Devices and Extenders.

Table 2.31: Part Number Coding

Number Segment	Character	Description	EZM	3	1000	JCB	C	20
Device Name	EZM	EZM Busway Center Tap Main						
System Connection (Phase Order: Front to Back)	3	3 Phase (N, C, B, A)						
Maximum Current of Main Service Disconnect	600	600 A						
	800	800 A						
	1000	1000 A						
	1200	1200 A						
Type of Main Service Disconnect (with AIC Rating)	GCB	65 kAIC Circuit Breaker						
	JCB	100 kAIC Circuit Breaker						
	FS	100 kAIC Fused Switch						
Material of I-Line II	C	Copper						
	A	Aluminum						
Amperage of I-Line II	20	2000 A						
	25	2500 A						
	30	3000 A						
	32	3200 A						
	40	4000 A						
	50	5000 A						

This table is for interpreting existing part numbers only. All possible combinations are not available.

Table 2.32: EZM Busway Center Tap Mains

	Main CB Ampere Rating (A)	I-Line II Busway Rating Material	Cat. No.	Height (in.)	Width (in.)	Depth (in.)	MC Height (in.)	
	<b>Main Circuit Breakers (3Ø Incoming and 3Ø Outgoing)</b>							
		SCCR	65 kA	100 kA				
	600	2000A, Al	—	EZM3600JCBA20	43.08	22.70	14.78	56.11
		3000A, Al	—	EZM3600JCBA30	43.08	22.70	14.78	56.11
		4000A, Al	—	EZM3600JCBA40	43.08	27.96	14.78	56.11
		4000A, Al	EZM3600GCBA40	—	43.08	27.96	14.78	56.11
	800	4000A, Cu	EZM3600GCBC40	—	43.08	27.96	14.78	56.11
		2000A, Al	EZM3800GCBA20	—	43.08	22.70	14.78	56.11
		3000A, Al	EZM31200GCBA30	—	43.08	22.70	14.78	56.11
		3000A, Al	EZM3800GCBA30	—	43.08	22.70	14.78	56.11
	1000	3000A, Cu	EZM3800GCBC30	—	43.08	22.70	14.78	56.11
		3000A, Al	—	EZM3800JCBA30	43.08	22.70	14.78	56.11
		4000A, Al	—	EZM3800JCBA40	43.08	27.96	14.78	56.11
		4000A, Al	EZM3800GCBA40	—	43.08	27.96	14.78	56.11
	1200	4000A, Al	EZM31000GCBA40	—	43.08	27.96	14.78	56.11
		4000A, Al	—	EZM31000JCBA40	43.08	27.96	14.78	56.11
		4000A, Cu	—	EZM31000JCBC40	43.08	27.96	14.78	56.11
		2500A, Al	EZM3800GCBA25	—	43.08	22.70	14.78	56.11
	1200	4000A, Al	EZM31200GCBA40	—	43.08	27.96	14.78	56.11
		4000A, Al	—	EZM31200JCBA40	43.08	27.96	14.78	56.11

**Tenant Circuit Breakers and EZM Accessories**

**Table 2.33: 125 A Max. EZM Branch Unit Tenant Circuit Breakers**

	Poles	Ampere Rating	10 k AIR	22 k AIR	42 k AIR	100 k AIR
	2	40	QO240	QO240VH	QOH240	—
		50	QO250	QO250VH	QOH250	—
		60	QO260	QO260VH	QOH260	—
		70	QO270	QO270VH	QOH270	—
		80	QO280	QO280VH	QOH280	—
		90	QO290	QO290VH	QOH290	—
	3	100	QO2100	QO2100VH	QOH2100	—
		110	QO2110	QO2110VH	QOH2110	—
		125	QO2125	QO2125VH	QOH2125	—

**Table 2.34: 225 A Max. EZM Branch Unit Tenant Circuit Breakers**

	Poles	Ampere Rating	10 k AIR	25 k AIR	65 k AIR	100 k AIR
	2	40	QO240 [56]	QO240VH [56] [57]	QOH240 [56] [58]	—
		50	QO250 [56]	QO250VH [56] [57]	QOH250 [56] [58]	—
		60	QO260 [56]	QO260VH [56] [57]	QOH260 [56] [58]	—
		70	QBP22070TM	QDP22070TM	QGP22070TM	QJP22070TM
		80	QBP22080TM	QDP22080TM	QGP22080TM	QJP22080TM
		90	QBP22090TM	QDP22090TM	QGP22090TM	QJP22090TM
		100	QBP22100TM	QDP22100TM	QGP22100TM	QJP22100TM
		110	QBP22110TM	QDP22110TM	QGP22110TM	QJP22110TM
		125	QBP22125TM	QDP22125TM	QGP22125TM	QJP22125TM
		150	QBP22150TM	QDP22150TM	QGP22150TM	QJP22150TM
		175	QBP22175TM	QDP22175TM	QGP22175TM	QJP22175TM
		200	QBP22200TM	QDP22200TM	QGP22200TM	QJP22200TM
	225	QBP22225TM	QDP22225TM	QGP22225TM	QJP22225TM	
	3	70	QBP32070TM	QDP32070TM	QGP32070TM	QJP32070TM [59]
		80	QBP32080TM	QDP32080TM	QGP32080TM	QJP32080TM [59]
		90	QBP32090TM	QDP32090TM	QGP32090TM	QJP32090TM [59]
		100	QBP32100TM	QDP32100TM	QGP32100TM	QJP32100TM [59]
		110	QBP32110TM	QDP32110TM	QGP32110TM	QJP32110TM [59]
		125	QBP32125TM	QDP32125TM	QGP32125TM	QJP32125TM [59]
		150	QBP32150TM	QDP32150TM	QGP32150TM	QJP32150TM [59]
		175	QBP32175TM	QDP32175TM	QGP32175TM	QJP32175TM [59]
		200	QBP32200TM	QDP32200TM	QGP32200TM	QJP32200TM [59]
		225	QBP32225TM	QDP32225TM	QGP32225TM	QJP32225TM [59]

**Table 2.35: Accessories**

Accessory	Description	Cat. No.
1200 A Bus Extension (Indoor/ Outdoor Cu bus)	1Ø3W Bus Extension (6 in. wide) 1Ø3W Bus Extension (12 in. wide) 3Ø4W Bus Extension (6 in. wide) 3Ø4W Bus Extension (12 in. wide)	EZM1EXT6 EZM1EXT EZM3EXT6 EZM3EXT
1200 A Bussed Corner Sections (Indoor Cu bus only)	1Ø3W Inside Corner (14.75 in. wide) 1Ø3W Outside Corner (6.20 in. wide) 3Ø4W Inside Corner (14.75 in. wide) 3Ø4W Outside Corner (6.20 in. wide)	EZM1CORNER EZM1ELBOW EZM3CORNER EZM3ELBOW
1200 A Transition Sections—Old to New (10.7 in. wide Cu bus)	Add right of old style 1Ø EZM lineup Add right of old style 3Ø EZM lineup Add left of old style 1Ø EZM lineup Add left of old style 3Ø EZM lineup	EZM1TRANR EZM3TRANR EZM1TRANL EZM3TRANL
Mounting Channel	72" long	EZM72MC
Secondary Surge Arrester Mounting kit	For use with 1 or 2-SDSA1175 or 1-SDSA3650 (order surge arrester separately)	MMSAMK [60]
Stud Kit for EZM-TB 400–600 A terminal box	Includes (2) 1/2 in.-13 studs per pad and mounting hardware. Four pads per kit.	EZMSK2
Al/Cu Lug Kits (Each kit includes three, 2-barrel lugs.)	(1) 1/0–600 kcmil or (2) 1/0–250 kcmil per lug (2) 3/0–500 kcmil per lug (2) 2–600 kcmil per lug	MMLK250 MMLK500 MMLK600
Feed-Thru for EZM-TB 800 A Terminal Box	(4) 750 kcmil Al/Cu lugs per phase and neutral. Al wire 600 A max. Cu wire 800 A max.	EZM600FTLK3
Feed-Thru for EZM-TB 1600 A Terminal Box	(24) additional lugs, 600 kcmil Al/Cu, (6) per phase and neutral.	EZM1600FTLK3
EZM Mains Right Side Closure Cap	Replacement right side end cap for EZM Cross Bus Opening	EZM5SCAP
EZM Mains Left Side Closure Cap	Replacement left side end cap for EZM Cross Bus Opening	EZM5CAP
Fifth Jaw Kit	1 per kit	5J [61]
Horn Bypass Kit	Use with Type EZMR 1Ø meter socket only	MMHB
Slider Type Manual Circuit Closer	For (1) 125–225 A ring-type socket only—indoor/outdoor	MM200MB [62] [63]
Anti-inversion Clip	Rejects 100 A and 200 A watt-hour meters in Class 320 meter sockets in Type EZML branch units.	MMLRK
QO Adapter for bolt-on Q-frame tenant circuit breakers	For 2P Type QO (40–125 A, 10 kA max. meter center SCCR) or QO-VH and QOH (40–60 A, 100 kA max. meter center SCCR)	EZM125QOA
LJL Circuit Breaker Alternate Lug (DE2)	Kit includes (3) separate lugs for (1) #2 AWG - 500 kcmil Al or (1) #2 AWG - 600 kcmil Cu per lug.	AL400L61K3
LJL Circuit Breaker Seal Kit	Tamper-evident kit to seal LJL trip dial cover, (1) per circuit breaker, if required. Meets NEC 240-6 [c]	MICROTUSEAL
Meter Socket Closing Plates	Lexan Closing Plate—EZM, EZMR, EZMH, EZMT Metal Closing plate—EZMR, EZMH, EZML	29007 RSG4
Sealing Rings	Snap-on (Stainless Steel) Screw-Type (Aluminum) Latch-Type (Aluminum)—standard	ARP00026 29008W 2920910001
Barrel Lock Kit	For use on ringless EZM or MP branch unit covers, includes 6 each of head protectors, lock nuts and sealing caps. (Barrel lock not included)	MMBLC
Tenant Circuit Breaker Filler Plates	125 A Branches—2P Type QO (2 per opening) 225 A Branches—2P and 3P Q-Frame	QOFP

[56] Must use EZM125QOA adapter.

[57] QO-VH tenant circuit breaker is rated 22 k AIR max.

[58] QOH tenant circuit breaker is rated 42 k AIR max.

[59] 3-pole QJP tenant circuit breaker is rated 65 k AIR max. at 240/120 Vac, 3Ø4W High Leg Delta, or 100 k AIR max. at 208Y/120 Vac, 3Ø4W.

[60] Consult your nearest Schneider Electric sales office for details.

[61] All sockets include 5th Jaw factory-installed except EZM11\_\_ devices.

[62] Meter center short circuit current rating is 10,000 RMS symmetrical amperes with manual circuit closers installed (bypass is not designed for use as continuous duty).

[63] For use on ring type meter sockets only.

Table 2.35 Accessories (cont'd.)

Accessory	Description	Cat. No.
Lug Landing Kit	For use with EZM 1200 A Mains suffix -CBU or -FSB. Order lugs separately	EZM1200ULL
Branch Section Mounting Kit for Riser Applications	This kit is needed when installing and connecting meter center branch sections to EZ-Meter Pak busway center tap mains in multi-floor riser applications (1 per branch section)	EZMCTMKIT
Branch Terminal Box	This device accommodates a maximum conductor size of 300 kcmil when voltage drop calculations require sizes over 2/0. The EZM3BTB accommodates oversizing conductors of up to 3 circuits, mounts above or below a 125 A EZM branch, and is rated NEMA 3R when below device, NEMA 1 when above device. The EZM6BTB accommodates oversizing conductors of up to 6 circuits, mounts above a 125 A EZM branch, and is rated NEMA 1.	EZM3BTB EZM6BTB
Load Center Main Lug Kit 125 A	125 A main lug kit for load centers, supporting larger wire sizes 6-4/0.	QOL125VD

Dimensions for EZ Meter-Pak Meter Centers

Table 2.36: Main Device Dimensions and Accessories (in.)

	Cat. No.	Height (H)	Width (W)	Depth (D)	MC Channel (MC)	Cat. No.	Height (H)	Width (W)	Depth (D)	MC Channel (MC)
<p>Main Device</p>	EZM11000CB	53.97	18.66	11.50	34.30	EZM1ELBOW [64] [65] [66]	19.50	14.52	8.01	11.85
	EZM11000CBU	66.27	32.39	13.70	47.28	EZM31000CB	53.97	18.66	11.50	34.30
	EZM11200G/JCBE	46.90	23.69	13.69	13.75	EZM31000CBU	66.27	32.39	13.70	47.28
	EZM11200G/JCBE	66.20	32.39	13.69	50.09	EZM31200G/JCBE	46.90	23.69	13.69	13.75
	EZM11200FST	46.90	23.69	13.69	13.75	EZM31200G/JCBE	66.20	32.39	13.69	50.09
	EZM11200FSE	66.20	32.39	13.69	50.09	EZM31200TBU	44.71	33.16	11.68	31.17
	EZM11200G/JCBU	65.30	23.69	13.69	49.11	EZM31200G/JCBU	65.30	23.69	13.69	49.11
	EZM11200FSB	65.30	23.69	13.69	49.11	EZM31200FSB	65.30	23.69	13.69	49.11
	EZM11200TBU	44.71	33.16	11.68	31.17	EZM31200FST	46.90	23.69	13.69	13.75
	EZM11200GCBUMS	65.30	23.69	13.63	49.12	EZM31200FSE	66.20	32.39	13.69	51.09
EZM11200GCBEMS	66.27	32.39	13.70	50.09	EZM31200GCBUMS	65.30	23.69	13.63	49.12	
EZM11200GCBTMS	46.93	23.69	13.63	13.75	EZM31200GCBEMS	66.27	32.39	13.70	50.09	
EZM11200JCBUMS	65.30	23.69	13.63	49.12	EZM31200GCBTMS	46.93	23.69	13.63	13.75	
EZM11200JCBEMS	66.27	32.39	13.70	50.09	EZM31200JCBUMS	65.30	23.69	13.63	49.12	
EZM11200JCBTMS	46.93	23.69	13.63	13.75	EZM31200JCBEMS	66.27	32.39	13.70	50.09	
EZM11600G/JCBC	68.70	30.19	18.33	38.13	EZM31200JCBTMS	46.93	23.69	13.63	13.75	
EZM11600G/JCJU	68.70	30.19	18.33	49.12	EZM31600G/JCBC	68.70	30.19	18.33	38.13	
EZM11600TB	55.09	22.48	13.00	27.92	EZM31600G/JCJU	68.70	30.19	18.33	49.12	
EZM11600GCBUMS	68.91	30.19	18.31	44.50	EZM31600TB	55.09	22.48	13.00	27.92	
EZM11600GCBUMS	68.91	30.19	18.31	44.50	EZM31600GCBUMS	68.91	30.19	18.31	44.50	
EZM11600GCBUMS	68.91	30.19	18.31	44.50	EZM31600GCBUMS	68.91	30.19	18.31	44.50	
EZM11600GCBUMS	68.91	30.19	18.31	44.50	EZM31600GCBUMS	68.91	30.19	18.31	44.50	
EZM12000CB	68.70	30.19	18.33	44.25	EZM31600GCBUMS	68.91	30.19	18.31	44.50	
EZM12000CBU	68.70	30.19	18.33	44.25	EZM32000CB	68.70	30.19	18.33	44.25	
EZM12000TB	71.09	30.19	21.46	37.62	EZM32000CBU	68.70	30.19	18.33	44.25	
EZM12000CBMS	68.91	30.19	18.31	44.50	EZM32000TB	71.09	30.19	21.46	37.62	
EZM12000CBUMS	68.91	30.19	18.31	44.50	EZM32000CBMS	68.91	30.19	18.31	44.50	
EZM1225TB [66]	21.81	11.66	6.37	13.00	EZM32000CBUMS	68.91	30.19	18.31	44.50	
EZM1400CB	53.97	18.66	11.50	34.30	EZM3225TB [66]	21.81	11.66	6.37	13.00	
EZM1400CBU	69.03	20.46	11.50	49.37	EZM3400CB	53.97	18.66	11.50	34.30	
EZM1400FS	53.97	18.66	11.50	34.30	EZM3400CBU	69.03	20.46	11.50	49.37	
EZM1400FSU	69.03	20.46	11.50	49.37	EZM3400FS	53.97	18.66	11.50	34.30	
EZM1400TB	30.46	17.15	7.09	16.29	EZM3400FSU	69.03	20.46	11.50	49.37	
EZM1400TBU	35.71	17.16	8.00	27.17	EZM3400TB	30.46	17.15	7.09	16.29	
EZM1600CB	53.97	18.66	11.50	34.30	EZM3400TBU	35.71	17.16	8.00	27.17	
EZM1600CBU	69.03	20.46	11.50	49.37	EZM3600CB	53.97	18.66	11.50	34.30	
EZM1600FS	53.97	18.66	11.50	34.30	EZM3600CBU	69.03	20.46	11.50	49.37	
EZM1600FSU	69.03	20.46	11.50	49.37	EZM3600FS	53.97	18.66	11.50	34.30	
EZM1600TB	30.46	17.15	7.09	16.29	EZM3600FSU	69.03	20.46	11.50	49.37	
EZM1800CB	53.97	18.66	11.50	34.30	EZM3600TB	30.46	17.15	7.09	16.29	
EZM1800CBU	69.03	20.46	11.50	49.37	EZM3800CB	53.97	18.66	11.50	34.30	
EZM1800FS	53.97	18.66	11.50	34.30	EZM3800CBU	69.03	20.46	11.50	49.37	
EZM1800FSU	69.03	20.46	11.50	49.37	EZM3800FS	53.97	18.66	11.50	34.30	
EZM1800TB	30.46	17.15	7.09	16.29	EZM3800FSU	69.03	20.46	11.50	49.37	
EZM1800TBU	35.71	17.16	8.00	27.17	EZM3800TB	30.46	17.15	7.09	16.29	
EZM1800TBCU	51.76	22.48	7.09	28.01	EZM3800TBU	35.71	17.16	8.00	27.17	
EZM1800TBCU	39.96	25.16	11.68	31.17	EZM3800TBCU	51.76	22.48	7.09	28.01	
EZM1EXT [66]	19.34	11.66	6.37	11.85	EZM3800TBCU	39.96	25.16	11.68	31.17	
EZM1EXT6 [66]	19.34	6.00	6.37	11.85	EZM3EXT [66]	19.34	11.66	6.37	11.85	
EZM1CORNER [64][66][67]	19.50	14.40	8.02	11.85	EZM3EXT6 [66]	19.34	6.00	6.37	11.85	
EZM3BTB [68]	19.31	12.25	8.43	—	EZM3CORNER [64] [66] [67]	19.50	14.40	8.02	11.85	
EZM6BTB [64]	23.00	12.13	8.00	—						

[64] Indoor only.  
 [65] Each leg of elbow section measures 6.17 in. corner of wall to start of next enclosure.  
 [66] Device supplied without mounting channel, secure to wall by use of swingable mounting feet.  
 [67] Each leg of this corner section measures 14.72 in. from wall to start of next enclosure.  
 [68] Outdoor when mounted below branch device. Indoor only when mounted above branch device.

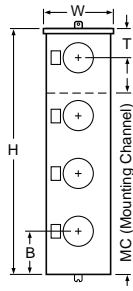

Branch Device

**Table 2.37: Single Phase Branch Device Dimensions (in.)** [69]

Cat. No. [available suffix]	Height (H)	Width (W)	Depth (D)	MC Channel (MC)	Top Meter (T)	Bottom Meter (B)	Cat. No. [available suffix]	Height (H)	Width (W)	Depth (D)	MC Channel (MC)	Top Meter (T)	Bottom Meter (B)
EZM112225 [X, CUX]	43.41	17.38	8.09	32.34	22.18	12.23	EZML112225 [CU]	39.06	19.44	9.44	25.51	11.67	13.39
EZM113125 [X, CUX]	42.37	12.25	7.09	31.30	13.18	11.19	EZML112225D	39.06	19.44	9.44	25.51	11.67	13.39
EZM113225 [X, CUX]	43.41	17.38	8.09	32.34	13.18	12.23	EZML112400	69.61	23.21	9.44	37.81	20.64	21.53
EZM114125 [X, CUX]	48.12	12.25	7.09	31.30	9.93	11.19	EZML113125 [X, CUX]	45.06	15.56	9.48	34.23	12.84	12.22
EZM114225 [X, CUX]	52.00	17.38	8.09	32.34	12.77	12.23	EZML113225 [CU]	53.06	19.44	9.44	39.51	11.67	13.39
EZM115125 [X, CUX]	57.12	12.25	7.09	31.30	9.93	11.19	EZML113225D	53.06	19.44	9.44	39.51	11.67	13.39
EZM115225 [CU]	61.00	17.38	8.09	32.35	12.77	12.23	EZML114125 [X, CUX]	55.06	15.56	9.48	34.29	12.84	12.22
EZM116125 [X, CUX]	66.12	12.25	7.09	40.30	9.93	11.19	EZML114225 [CU]	67.06	19.44	9.44	39.51	11.67	13.39
EZM16225	69.94	17.38	8.09	41.33	12.72	12.22	EZML114225D	67.06	19.44	9.44	39.51	11.67	13.39
EZMH112225 [X, CUX]	43.41	17.38	8.09	32.34	22.18	12.23	EZML115125 [X, CUX]	65.06	15.56	9.48	34.29	12.84	12.22
EZMH113125 [X, CUX]	42.37	12.25	7.09	31.30	13.18	11.19	EZML116125 [X, CUX]	75.06	15.56	9.48	44.29	12.84	12.25
EZMH113225 [X, CUX]	43.41	17.38	8.09	32.34	13.18	12.23	EZMR112225 [X, CUX]	43.41	17.38	8.09	32.34	22.18	12.23
EZMH114125 [X, CUX]	48.12	12.25	7.09	31.30	9.93	11.19	EZMR113125 [X, CUX]	42.37	12.25	7.09	31.30	13.18	11.19
EZMH114225 [X, CUX]	52.00	17.38	8.09	32.34	12.77	12.23	EZMR113225 [X, CUX]	43.41	17.38	8.09	32.34	13.18	12.23
EZMH115125 [X, CUX]	57.12	12.25	7.09	31.30	9.93	11.19	EZMR114125 [X, CUX]	48.12	12.25	7.09	31.30	9.93	11.19
EZMH115225 [CU]	61.00	17.38	8.09	32.35	12.77	12.23	EZMR114225 [X, CUX]	52.00	17.38	8.09	32.34	12.77	12.23
EZMH116125 [X, CUX]	66.12	12.25	7.09	40.30	9.93	11.19	EZMR115125 [X, CUX]	57.12	12.25	7.09	31.30	9.93	11.19
EZMH116225	69.94	17.37	8.09	41.33	12.72	12.22	EZMR115225 [CU]	61.00	17.38	8.09	32.35	12.77	12.23
EZMK111400	45.55	27.56	9.74	37.81	24.51	21.04	EZMR116125 [X, CUX]	66.12	12.25	7.09	40.30	9.93	11.19
EZMK112400	72.99	27.56	9.74	37.81	22.26	21.04	EZMR116225	69.94	17.37	8.09	41.33	12.72	12.22
EZML111225 [CU]	39.06	19.44	9.44	25.51	25.67	13.39	EZMT112225	25.45	22.42	9.38	16.19	4.67	20.45
EZML11225D	39.06	19.44	9.44	25.51	25.67	13.39	EZMT112225	60.56	22.42	9.38	43.63	12.67	28.89
EZML111400	44.55	23.21	9.44	37.81	24.02	21.53	EZMT113225	79.56	22.42	9.38	48.25	12.67	28.89

**Table 2.38: Three Phase Branch Device Dimensions (in.)** [69]

Cat. No. [available suffix]	Height (H)	Width (W)	Depth (D)	MC Channel (MC)	Top Meter (T)	Bottom Meter (B)	Cat. No. [available suffix]	Height (H)	Width (W)	Depth (D)	MC Channel (MC)	Top Meter (T)	Bottom Meter (B)
EZM312225 [X, CUX, CA, XCA, CUXCA]	43.41	17.38	8.09	32.34	22.18	12.23	EZML314125 [X, CUX]	55.06	15.56	9.48	34.29	12.84	12.22
EZM313125 [X, CUX, CA, XCA, CUXCA]	42.37	12.25	7.09	31.30	13.18	11.19	EZML314225 [CU, CA, CUXCA]	67.06	19.44	9.44	39.51	11.67	13.39
EZM313125M10	42.37	12.25	7.09	24.29	10.18	12.19	EZML314225D [CA]	67.06	19.44	9.44	39.51	11.67	13.39
EZM313225 [X, CUX, CA, XCA, CUXCA]	43.41	17.38	8.09	32.34	13.18	12.23	EZML315125 [X, CUX]	65.06	15.56	9.48	34.29	12.84	12.22
EZM314125 [X, CUX, CA, XCA, CUXCA]	48.12	12.25	7.09	31.30	9.93	11.19	EZML316125 [X, CUX]	75.06	15.56	9.48	44.29	12.84	12.25
EZM314125M10	52.12	12.25	7.09	34.29	9.93	12.19	EZML331225 [CU]	39.06	19.44	9.44	25.51	25.67	13.39
EZM314225 [X, CUX, CA, XCA, CUXCA]	52.00	17.38	8.09	32.34	12.77	12.23	EZML331225D	39.06	19.44	9.44	25.51	25.67	13.39
EZM315125 [X, CUX, CA, XCA, CUXCA]	57.12	12.25	7.09	31.30	9.93	11.19	EZML331400	45.55	23.21	9.44	37.81	24.02	21.53
EZM315125M10	62.12	12.25	7.09	34.29	9.93	12.19	EZML332225 [CU]	39.06	19.44	9.44	35.51	11.67	13.39
EZM315225 [CU, CA, CUXCA]	61.00	17.38	8.09	32.35	12.77	12.23	EZML332225D	39.06	19.44	9.44	35.51	11.67	13.39
EZM316125 [X, CUX, CA, XCA, CUXCA]	66.12	12.25	7.09	40.30	9.93	11.19	EZML332400 [CU]	69.61	23.21	9.44	37.82	20.64	21.53
EZM316225 [CU, CA]	69.94	17.37	8.09	41.33	12.72	12.22	EZML333225 [CU]	53.06	19.44	9.44	39.51	11.67	13.39
EZMH312225 [X, CUX, CA, XCA]	43.41	17.38	8.09	32.34	22.18	12.23	EZML333225D	53.06	19.44	9.44	39.51	11.67	13.39
EZMH313125 [X, CUX, CA, XCA]	42.37	12.25	7.09	31.30	13.18	11.19	EZML334225 [CU]	67.06	19.44	9.44	39.51	11.67	13.39
EZMH313225 [X, CUX, CA, XCA]	43.41	17.38	8.09	32.34	13.18	12.23	EZML334225D	67.06	19.44	9.44	39.51	11.67	13.39
EZMH314125 [X, CUX, CA, XCA]	48.12	12.25	7.09	31.30	9.93	11.19	EZMR312225 [X, CUX, CA, XCA]	43.41	17.38	8.09	32.34	22.18	12.23
EZMH314225 [X, CUX, CA, XCA]	52.00	17.38	8.09	32.34	12.77	12.23	EZMR313125 [X, CUX, CA, XCA]	42.37	12.25	8.09	31.30	13.18	11.19
EZMH315125 [X, CUX, CA, XCA]	57.12	12.25	7.09	31.30	9.93	11.19	EZMR313225 [X, CUX, CA, XCA]	43.41	17.38	8.09	32.34	13.18	12.23
EZMH315225 [CU, CA, CUXCA]	61.00	17.38	8.09	32.35	12.77	12.23	EZMR314125 [X, CUX, CA, XCA]	48.12	12.25	7.09	31.30	9.93	11.19
EZMH316125 [X, CUX, CA, XCA]	66.12	12.25	7.09	40.30	9.93	11.19	EZMR314225 [X, CUX, CA, XCA]	52.00	17.38	8.09	32.34	12.77	12.23
EZMH316225 [CU, CA]	69.94	17.37	8.09	41.33	12.72	12.22	EZMR315125 [X, CUX, CA, XCA]	57.12	12.25	7.09	31.30	9.93	11.19
EZMK311400 [CA]	45.55	27.56	9.74	30.60	24.51	21.04	EZMR315225 [CU, CA, CUXCA]	61.00	17.38	8.09	32.35	12.77	12.23
EZMK312400 [CA]	72.99	27.56	9.74	37.81	22.26	21.04	EZMR316125 [X, CUX, CA, XCA]	66.12	12.25	7.09	40.30	9.93	11.19
EZMK331400	45.55	27.56	9.74	30.60	24.51	21.04	EZMR316225 [CU, CA]	69.94	17.37	8.09	41.33	12.72	12.22
EZMK332400	72.99	27.56	9.74	37.81	22.26	21.04	EZMR332225 [CU]	39.06	19.44	9.44	25.51	11.67	13.39
EZML311400 [CA]	45.55	23.21	9.44	37.81	24.02	21.53	EZMR333225 [CU]	53.06	19.44	9.44	39.51	11.67	13.39
EZML312225 [CU, CA, CUXCA]	39.06	19.44	9.44	25.51	25.67	13.39	EZMR334225 [CU]	67.06	19.44	9.44	39.51	11.67	13.39
EZML312225 [CU, CA, CUXCA]	39.06	19.44	9.44	25.51	11.67	13.39	EZMT311225 [CA]	25.45	22.42	9.38	16.19	4.67	20.45
EZML312225D [CA]	39.06	19.44	9.44	25.51	11.67	13.39	EZMT312225 [CA]	60.56	22.42	9.38	43.63	12.67	28.89
EZML312400 [CA]	69.61	23.21	9.44	37.82	20.64	21.53	EZMT313225 [CA]	79.56	22.42	9.38	48.25	12.67	28.89
EZML313125 [X, CUX]	45.06	15.56	9.48	34.23	12.84	12.22	EZMT331225	25.12	22.42	9.38	16.19	4.67	20.45
EZML313225 [CU, CA, CUXCA]	53.06	19.44	9.44	39.51	11.67	13.39	EZMT332225	60.56	22.42	9.38	43.63	12.67	28.89
EZML313225D [CA]	53.06	19.44	9.44	39.51	11.67	13.39	EZMT333225	79.56	22.42	9.38	48.25	12.67	28.89

[69] Standard branch units are available without suffix added.

**Table 2.39: Enclosed Molded Case Switches**

System	Ampere Rating	Cat. No. Add Suffix [1]	600 Vac Short Circuit Withstand Ratings
LH—400 A Frame, 3P, 600 Vac Max.			
2P	400	LHE26000( )	25 kA
3P	400	LHE36000( )	25 kA

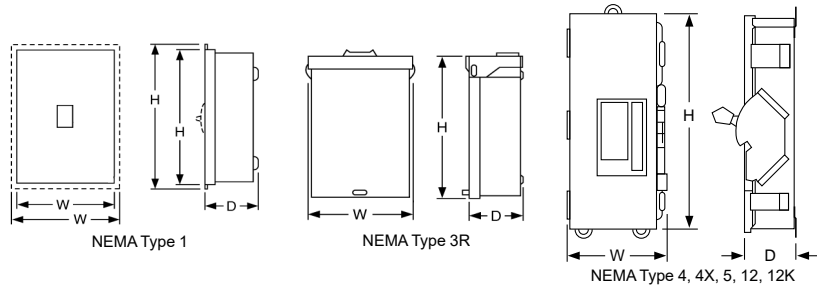
**Table 2.40: Enclosed Molded Case Switch Dimensions**

Cat. No. Prefix—Suffix	Series	Approximate Dimension					
		H		W		D	
		in.	mm	in.	mm	in.	mm
LHE—AWK	E05	42.25	1073	13.75	349	7.25	184
LHE—DS	E05	42.25	1073	13.75	349	7.25	184
LHE—F	A03	45.63	1159	16.50	419	6.50	165
LHE—R	A03	44.00	1118	15.38	391	7.88	200
LHE—S	E03	44.50	1130	15.38	391	6.50	165

### Lock-On Provisions

Lock-off provisions are standard on all NEMA Type 4, 4X, 5 stainless steel and NEMA Type 12, 12K circuit breaker enclosures. Provision for one inch hasp padlock is available factory installed. This modification will allow the circuit breaker to be locked in the ON position. When locked in the ON position, the external operator will not indicate if circuit breaker is tripped. UL Listed.

**Table 2.41: Enclosure**

Enclosure Prefix	Suffix for Lock-On Provision
FA, J, LA, L, M, P	SPLO

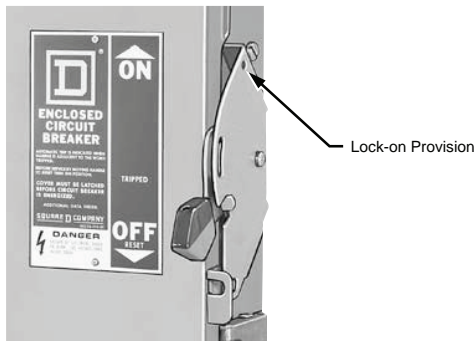

Lock-On Provision

### Pilot Light—Selector Switch—Push Button

Pilot lights, push buttons or selector switches are available factory installed in the cover of NEMA Type 4, 4X, 5 stainless steel or NEMA Type 12, 12K circuit breaker enclosures. Wiring to contact blocks is not available. Customer must furnish catalog number of device desired. Price = circuit breaker + enclosure + neutral + ground + pilot light, push button and/or selector switch + factory-installed adder. Order by description. L600 enclosures are UL Listed, other enclosures are not UL Listed.

### Phenolic Legend Plate

Available engraved and mounted on most circuit breaker enclosures. Legend engraved in 1/4-inch high white letters on black background. Customer must provide legend. UL Listed. Not available on NEMA Type 7 or 9 enclosures.

To order, add suffix NP to standard catalog number (i.e. LA400SNP).

### Stainless Steel Front Enclosure

The FA100F NEMA Type 1, flush-mount circuit breaker enclosure is available with a stainless steel front. This modification is desirable in food handling areas such as cafeterias and restaurants. Not UL Listed.

**Table 2.42: Stainless Steel Front Enclosure**

Cat. No.
FA100FSS

[1] Add suffix S or F for NEMA 1 surface mounted or NEMA 1 flush mounted, respectively. Add suffix RB for NEMA 3R with bolt-on hub provision (FHE prefix only) or suffix R for NEMA 3R with a blank top endwall (LHE prefix only), respectively. Add suffix AWK for NEMA 12. Add suffix DS for NEMA 4/4X/5 stainless steel.



**Key Interlock Systems for Circuit Breaker Enclosures**  
(Factory installed only.)

Interlocks are used to prevent the authorized operator from making an unauthorized operation. Available only on NEMA 4, 4X, 5, 12K, and 12/3R circuit breaker enclosures. The key interlock system is a simple and easy method of applying individual key interlock units and assemblies to the above equipment so as to require operation in a predetermined sequence. UL Listed.

**Quoting**

Contact local Field Sales office for catalog number, availability and pricing prior to quoting a job.

**Ordering**

Order cannot be released for production until the following information has been provided:

- End User—Company name, address
- Function of each lock (e.g., circuit breaker to be locked open with key removed, key held when circuit breaker is closed)
- Existing Equipment—if circuit breaker is to be interlocked with equipment already on site, provide brand of existing lock and key number
- Other New Equipment—if circuit breaker is to be interlocked with new equipment not yet installed at the site, then provide contact person and phone number so that locks may be coordinated
- Additional information may be required upon order entry

**Diagram Symbols**

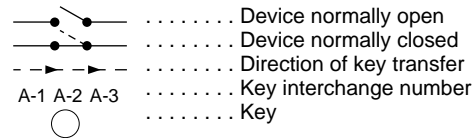

**Sample Application—1 (See Figure 1)**

To prevent two devices from being closed simultaneously.

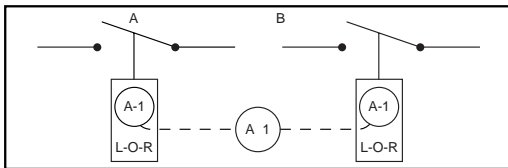

Figure 1

Two devices are shown in Figure 1. In operation they are not closed at the same time. With the interlocks arranged as shown only one key is required in the interlocking system. Both devices are shown open, therefore, the key is free. To close any one device the key is inserted and turned in that particular lock, the key is held in this lock until the device is again locked open. This simple interlocking sequence lends itself to a multitude of applications. The procedure is the same for two devices, neither of which is to be opened at the same time.

**Sample Application—2 (See Figure 2)**

To prevent opening of switch A when circuit breaker B is closed.

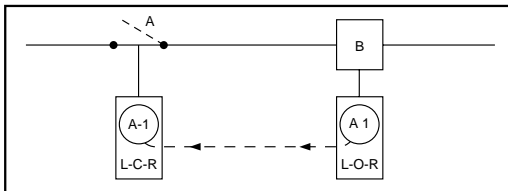

Figure 2

Switch A and circuit breaker B are in closed position. Key A-1 is held in circuit breaker B interlock.

- Open circuit breaker.
- Turn key A-1 in L-O-R interlock on circuit breaker B to lock open. Key A-1 is now free.
- Insert key A-1 in L-C-R interlock on switch A and turn to unlock.
- Open switch A. Key A-1 is now held. Reverse sequence to restore service.



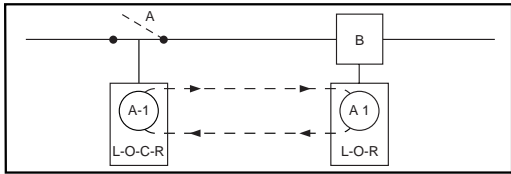

Figure 3

**Sample Application—3 (See Figure 3)**

To prevent operation of switch A when circuit breaker B is closed. Permits reclosing of circuit breaker for servicing when switch is locked open.

Switch A and circuit breaker B are in closed position. Key A-1 is held in circuit breaker interlock.

- Open circuit breaker.
- Turn key A-1 in L-O-R interlock on circuit breaker B to lock open. Key A-1 is now free.
- Insert key A-1 in L-O-C-R interlock on switch A and turn to unlock.
- Open switch A.
- Turn key A-1 in L-O-C-R interlock on switch A to lock open. Key A-1 is now free.
- Return key A-1 to circuit breaker interlock and unlock for operation during servicing period.

Reverse sequence to restore service.

**Sample Application—4 (Main-Tie-Main) (See Figure 4)**

To prevent paralleling of lines A and B.—Two loads, fed from either source.

Circuit breaker A is closed to supply load M. Circuit breaker B is closed to supply load N. Tie-circuit breaker C is open. Keys A-1 are held in interlocks on both circuit breakers A and B. Tie-circuit breaker C cannot be closed unless either A or B is locked open.

To transfer load N to circuit breaker A, proceed as follows:

- Open circuit breaker B.
- Turn key A-1 in L-O-R interlock on circuit breaker B to lock open. Key A-1 is now free.
- Insert Key A-1 in L-O-R interlock on tie-circuit breaker C and turn to unlock. Key A-1 is now held.
- Close tie-circuit breaker C.

Reverse sequence to restore service.

Load M can be supplied through circuit breaker B in a similar manner.

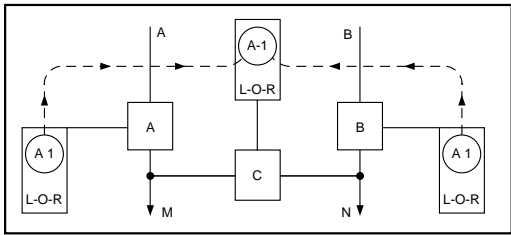

Figure 4

# Section 3

## Safety Switches



Light Duty



General Duty



Heavy Duty



Stainless Steel Heavy Duty

<b>EZ Selector - Selection Assistance</b>	<b>3-2</b>
Safety Switches EZ Selector - Selection Assistance	3-2
Safety Switches EZ Selector - Selection Assistance	3-2
Wiring Diagrams	3-3
<b>Light Duty Safety Switches</b>	<b>3-4</b>
Light Duty—Visible Blades 10 kA Short Circuit Current Rating	3-4
<b>General Duty Safety Switches</b>	<b>3-5</b>
General Duty—Up to 100 kA Short Circuit Current Rating	3-5
240 Volt—Single Throw Fusible Switches	3-5
240 Volt—Single Throw Non-Fusible Switches	3-5
UL Listed Maximum Short Circuit Current Ratings — AC Only	3-5
Accessories and Lug Data	3-7
Field-Installed Fuse Puller Kits	3-7
Field-Installed Electrical Interlock Kits	3-7
Equipment Grounding Kits	3-7
Field-Installed Lug Kit 400 A – 600 A	3-7
Terminal Lug Data	3-7
Dimensions for General Duty Safety Switches	3-8
<b>Heavy Duty Safety Switches</b>	<b>3-9</b>
240 Volt—Single Throw Fusible Switches	3-9
600 Volt—Single Throw Fusible Switches	3-10
600 Volt—Single Throw Non-Fusible Switches	3-11
UL Listed Maximum Short Circuit Current Ratings—AC only	3-12
Special Applications	3-13
Receptacle Switches	3-15
Accessories and Special Features	3-16
Dimensions for Heavy Duty Safety Switches	3-22
NEMA Type 1 and 3R	3-22
NEMA Type 4, 4X, 5, 7, 9, and 12	3-23
<b>Double Throw Safety Switches</b>	<b>3-25</b>
Fusible and Non-Fusible Overview	3-25
240 Volt — Double Throw Safety Switches	3-26
600 Volt — Double Throw Safety Switches	3-27
Accessories and Lug Data	3-28
Application Data	3-30
Terminal Lug Data	3-31
Dimensions for Double Throw Safety Switches	3-32
Series F Devices 30–100 A	3-32
Series A, E, and T4 Devices	3-32

SAFETY SWITCHES

3



## Safety Switches EZ Selector - Selection Assistance

### Safety Switches EZ Selector - Selection Assistance

#### EZ Selector

#### Steps to select a safety switch.

1. Select product type:
  - General duty safety switch
  - Heavy duty safety switch
  - Double throw safety switch
2. Select switch type.
3. Select fuse type: fused, non-fused, cartridge, class T or plug
4. Select maximum voltage: 240 Vac, 600 Vac
5. Select amperes:
  - General/light duty – 30 A, 60 A, 100 A, 200 A, 400 A, 800 A
  - Heavy duty – 30 A, 60 A, 100 A, 200 A, 225 A, 400 A, 600 A, 800 A, 1200 A
  - Double throw – 30 A, 60 A, 100 A, 200 A, 600 A
6. Select number of poles:
  - General/light duty – 1, 2 or 3
  - Heavy duty – 2, 3, 4 or 6
  - Double Throw– 2, 3, 4 or 6
7. Select if neutral is needed.
8. Select enclosure type:
  - General/light duty – NEMA 1, NEMA 3R
  - Heavy duty – NEMA1, NEMA 12K, NEMA 3R, 5, 12, NEMA 4, 4X, 5 (stainless steel 304), NEMA 4, 4X, 5 (stainless steel 316)
  - Double throw – NEMA1, NEMA 12K, NEMA 3R, 5, 12, NEMA 4, 4X, 5 (stainless steel 304)
  - Optional enclosure types for special heavy duty applications.

#### Additional Information

- Search “[Safety Switches](#)” from our technical FAQs page: [www.schneider-electric.us/en/faqs/home/](http://www.schneider-electric.us/en/faqs/home/)
- Refer to catalog [3100CT1602](#).

**Wiring Diagrams**

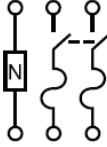
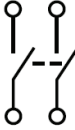
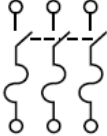
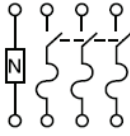
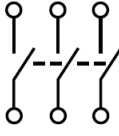
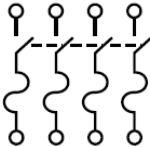
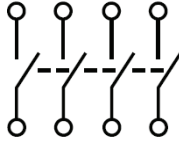
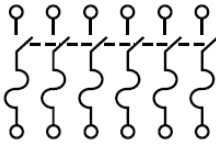
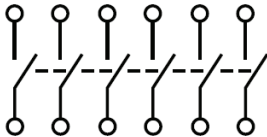
Fuse	Fused with Neutral Two-wire (1 blade and fuse holder)	Non-Fused
<p><b>Two-wire</b> (2 blades and fuse holder)</p> 	<p><b>Three-wire</b> (2 blades and fuse holder)</p> 	<p><b>Two-wire</b> (2 blades)</p> 
<p><b>Three-wire</b> (3 blades and fuse holders)</p> 	<p><b>Four-wire</b> (3 blades and fuse holders)</p> 	<p><b>Three-wire</b> (3 blades)</p> 
<p><b>Four-wire</b> (4 blades and fuse holders)</p> 		<p><b>Four wires</b> (4 blades)</p> 
<p><b>Six-wire</b> (6 blades and fuse holders)</p> 		<p><b>Six-wires</b> (6 blades)</p> 

### Light Duty—Visible Blades 10 kA Short Circuit Current Rating

The Square D light duty enclosed switch is ideal for home applications in disconnecting power to workshops, hobby rooms, furnaces, and garages. The light duty safety switch has visible blades and a ground lug as standard features.

**Table 3.1: Fusible**



L221N

System	Amperes	Fuse	NEMA Type 1 Indoor Cat. No.	Horsepower Ratings			
				120 Vac		240 Vac	
				Std. 1Ø	Max. 1Ø	Std. 1Ø	Max. 1Ø
<b>2 Wire (1 Blades and Fuseholders, 1 Neutral)—120 Vac</b>							
	30	Plug	L111N	—	—	—	—
<b>3 Wire (2 Blades and Fuseholders, 1 Neutral)—120/240 Vac</b>							
	30	Plug Cart	L211N L221N	1/2 1/2	2 2	1-1/2 1-1/2	3 3

**General Duty—Up To 100 kA Short Circuit Current Rating**

General duty safety switches are designed for residential and commercial applications where durability and economy are prime considerations. Typical loads are lighting, air conditioning, and appliances. They are suitable for use as service equipment when equipped with a factory or field-installed neutral assembly or a field-installed service grounding kit, (see page 3-7) as applicable. General duty safety switches are UL Listed, File E2875, and meet or exceed the NEMA Standard KS1.

**240 Volt—Single Throw Fusible Switches**

**Table 3.2: Fusible**

Amperes	Fuse	NEMA Type 1 Indoor	NEMA Type 3R [1] Rainproof	Class R Fuse Kits [2]	Line Side Barriers Factory Included[3]	Horsepower Ratings			
		Cat. No.	Cat. No.	Cat. No.		Std. (Fast Acting One-Time Fuses)		Max. (Dual Element Time-Delay Fuses)	
						1Ø	3Ø	1Ø	3Ø
<b>2 Wire (1 Blade and Fuseholder, 1 Neutral)—120 Vac</b>									
30	Plug	Use Light Duty Device for this Application (see above)			—	—	—	—	—
30	Cart.	Use three-wire devices for this application.			—	—	—	—	—
<b>3 Wire (2 Blades and Fuseholders, 1 Neutral)—120/240 Vac (Plug), 240 Vac (Cart.) Maximum</b>									
30	Plug	D211N	D211NRB	—	—	1-1/2	—	3	—
30	Cart.	D221N	D221NRB	DRK30	—	1-1/2	3 [4]	3	7-1/2 [4]
60	Cart.	D222N	D222NRB	RFK03H	Factory Included	3	7-1/2 [4]	10	15 [4]
100	Cart.	D223N	D223NRB	RFK10	Factory Included	7-1/2	15 [4]	15	30 [4]
200	Cart.	D224N [5]	D224NRB [5]	HRK1020	Factory Included	15	25 [4]	—	60 [4]
400	Cart.	D225N	D225NR	DRK40	—	—	—	—	—
600 [6]	Cart.	D226N	D226NR	DRK600	—	—	—	—	—
<b>4 Wire (3 Blades and Fuseholders, 1 Neutral)—240 Vac Maximum</b>									
30	Cart.	D321N	D321NRB	DRK30	—	1-1/2	3	3	7-1/2
60	Cart.	D322N	D322NRB	RFK03H	Factory Included	3	7-1/2 [7]	10	15 [7]
100	Cart.	D323N	D323NRB	RFK10	Factory Included	7-1/2	15 [7]	15	30 [7]
200	Cart.	D324N [5]	D324NRB [5]	HRK1020	Factory Included	15	25 [7]	—	60 [7]
400	Cart.	D325N	D325NR	DRK40	LSBI02	—	50	—	125
400 [8]	Class T	D325NT	D325NTR	—	LSBI02	—	50	—	—
600 [6]	Cart.	D326N	D326NR	DRK600	LSBI02	—	75	—	150
600 [8]	Class T	D326NT	D326NTR	—	LSBI02	—	75	—	—
800 [8]	Class T	T327N	T327NR	—	LSBI02	—	100	—	—



D223N

**240 Volt—Single Throw Non-Fusible Switches**

**Table 3.3: Non-Fusible**

System	Amperes	NEMA Type 1 Indoor	NEMA Type 3R Rainproof [9]	Line Side Barriers [10]	Horsepower Ratings (Max.)	
		Cat. No.	Cat. No.		1Ø	3Ø
<b>2 Wire (2 Blades)—240 Vac Maximum</b>						
	30	—	DU221RB	LSBD202	3	—
	60	—	DU222RB	LSBD202	10	—
	60	QO260NATS [11] [12] [13]	QO200TR [11] [12] [13]	LSBD202	10	—
	100	QO2000NS [11] [12]	QO2000NRB [11]	LSBD202	20	—
	200	Use 3P Switch	Use 3P Switch	—	—	—
	400	Use 3P Switch	Use 3P Switch	—	—	—
<b>3 Wire (3 Blades)—240 Vac Maximum</b>						
	30	DU321	DU321RB	LSBD202	3	7-1/2
	60	DU322	DU322RB	LSBD202	10	15
	100	DU323 [14]	DU323RB [14]	[10]	15	30
	200	DU324 [15]	DU324RB [15]	[10]	15	60
	400	DU325	—	LSBI02	—	125
	600	DU326 [16]	—	LSBI02	—	150

**UL Listed Maximum Short Circuit Current Ratings — AC Only**

**Table 3.4: Fusible Safety Switch Short Circuit Current Rating**

Fuse Class	UL Listed Short Circuit Rating
Plug	10 kA
H, K	10 kA

[1] Bolt-on hubs —Refer to Rainproof Bolt-On Hubs, Table 1.27, page 3-16.  
 [2] When properly installed, the Class R Fuse Kit rejects all but Class R fuses.  
 [3] Factory included to prevent inadvertent contact with live parts per UL 869A and NEC Service entrance barrier requirements.  
 [4] For corner grounded delta systems, use switching poles for ungrounded conductors. See data bulletin 2700DB0202 for additional information.  
 [5] For 200% neutral, order (1) additional neutral kit SN20A and (1) neutral jumper kit SN20NI.  
 [6] Order Class J Fuse Kit GDJK600 if using Class J fuses.  
 [7] If corner grounded delta system, use outer switching poles for ungrounded conductors.  
 [8] D325NT, D325NTR, D326NT, D326NTR, T327N and T327NR accept only 300Vac Class T fuses.  
 [9] Bolt-on hubs—Refer to Hubs, page 3-16.  
 [10] Factory included to prevent inadvertent contact with live parts per UL 869A and NEC Service entrance barrier requirements.  
 [11] Enclosed molded case switch—Refer to Section 1.  
 [12] Includes factory-installed grounding kit.  
 [13] Not service entrance rated—Refer to Table 3.34 for more information.  
 [14] If a neutral assembly is required, order and field install SN0610.  
 [15] If a neutral assembly is required, order and field install a SN20A Neutral Assembly Kit. For a 200% neutral application, order and field install (2) SN20A Neutral Assembly Kits and (1) SN20NI Neutral Jumper Kit.  
 [16] If a neutral assembly is required, order and field install D600SN.

**Table 3.4 Fusible Safety Switch Short Circuit Current Rating (cont'd.)**

Fuse Class	UL Listed Short Circuit Rating
J [17], R	100 kA
T [18]	100 kA

**Non-Fusible Safety Switches**

**Systems equal or less than 10 kAIR SCCR**—Any brand of circuit breaker or fuse not exceeding the ampere rating of the switch may be used in conjunction with a non-fusible safety switch.

**Systems above 10 kAIR SCCR**—The UL Listed short circuit current rating for Square D non-fusible switches is based upon the switch being used in conjunction with fuses or Square D circuit breakers or Mag-Gard motor circuit protectors.

**Table 3.5: Non-Fusible Safety Switch Short Circuit Current Rating**

Fuse Class or Circuit Breaker Type [19]	UL Listed Short Circuit Rating
Any Brand Circuit Breaker	10 kA
H or J PowerPact Circuit Breaker	Up to 65 kA [20]
H, K	10 kA
J, R	100 kA [21]
T	100 kA [22]

[17] Only applicable to 200 A - 600 A except D325NT, D325NTR, D326NT and D326NTR.

[18] Only applicable to D325NT, D325NTR, D326NT, D326NTR, T327N and T327NR.

[19] Ampere rating of fuse or circuit breaker not to exceed switch ampere rating.

[20] Only applicable to DU324 and DU324RB. HD, JD = 25 kA maximum.

[21] SCCR = 50 kA, applicable to DU222RB, DU322 and DU322RB.

[22] Only applicable to DU323, DU323RB, DU325 and DU326.

**Field-Installed Fuse Puller Kits**

Kit consists of three fuse pullers as required for a 3P, fusible, 60 or 100 A general duty switch. Kits can be installed only in 60 or 100 A Series F fusible switches.



Fuse Puller Kit  
Series F Fusible Switches  
Only

**Table 3.6: Fuse Puller Kits**

Switch Ampere Rating	Series No.	Cat. No.
60	F	FPK03
100	F	FPK0610

**Field-Installed Electrical Interlock Kits**

Electrical interlocks for Series F 100–200 A general duty safety switches & Series F 60 A fusible general duty safety switches are available in kit form for field installation. Each kit contains instructions for proper field mounting. A pivot arm operates from switch mechanism, breaking the control circuit before the main switch blades break. Switches with electrical interlocks installed are UL Listed.

**Table 3.7: Electrical Interlock Kit**

Switch Amperes Rating	Electrical Interlock Kit Cat. No. [23]
Fusible Series F 60	EIK031 or EIK032
Series F 100–200	EIK1 or EIK2

**Table 3.8: Electrical Interlock Contact Ratings [24]**

Interlock Type	AC 50 or 60Hz				DC		
	Volts	Make	Break	Cont.	Volts	Make / Break	Cont.
1 N. O. / 1 N. C. Contact (-1 Suffix [25])	120	40.00 A	15.00 A	15.00 A	115	0.50 A	15.00 A
	240	20.00 A	10.00 A	15.00 A	230	0.25 A	15.00 A
2 N. O. / 2 N. C. Contacts (-2 Suffix [26])	120	30.00 A	3.00 A	10.00 A	115	1.00 A	10.00 A
	240	15.00 A	1.5 A	10.00 A	230	0.30 A	10.00 A

**Equipment Grounding Kits**



PK3GTA1



GTK0610



PKOGTA2

**Table 3.9: Equipment Grounding Kits**

Switch Ampere Rating	Cat. No.	Lug Wire Range (AWG)
30 [27]	Std.	(1) 14 – 10 Cu or (1) 12 – 8 Al
30	PK3GTA1	(3) 14 – 4 Cu or (3) 12 – 4 Al or (6) 14 – 12 Cu or (6) 12 – 10 Al
60 [28]	GTK03	(2) 14 – 4 Cu or (2) 12 – 4 Al (4) 14 – 12 Cu or (4) 12 – 10 Al
100	GTK0610	(2) 14 – 1/0 Cu or (2) 12 – 1/0 Al (2) 14 – 6 Cu or (2) 12 – 6 Al
200	PKOGTA2	(2) 10 – 2/0 Cu or (2) 6 – 2/0 Cu Al
400, 600	PKOGTA2 [29]	(2) 10 – 2/0 Cu or (2) 6 – 2/0 Cu Al
800	PKOGTA3	(6) 6 – 3/0 Al/Cu Max.

**Field-Installed Lug Kit 400 A – 600 A**

**Table 3.10: Field-Installed Lug Kit 400 A – 600 A**

Switch Ampere Rating	Lug Kit Cat. No.	Wire Range/NEC	Lug Wire Range
400 or 600 Series [30]	GD4060LK	1-1/0-600 kcmil 2-1/0-500 kcmil 4-1/0-250 kcmil	2-1/0-600 kcmil 4-1/0-250 kcmil

**Terminal Lug Data**

**Table 3.11: Terminal Lug Data [31]**

Amperes	Conductors Per Phase	Wire Range Wire Bending Space Per NEC Table 312.6 AWG/kcmil	Lug Wire Range AWG/kcmil
30 [32]	1	12–8 (Al) or 14–8 (Cu)	12–8 (Al) or 14–8 (Cu)
30	1	12–6 (Al) or 14–6 (Cu)	12–6 (Al) or 14–6 (Cu)
60	1	12–3 (Al) or 14–3 (Cu)	12–2 (Al) or 14–2 (Cu)
100	1	12–1 (Al) or 14–1 (Cu)	12–1/0 (Al) or 14–1/0 (Cu)
200	1	6 –250 (Al/Cu)	6 –300 (Al/Cu)
400 NEMA Type 1	1 or 2	1/0 –600 (Al/Cu) or 1/0 –300 (Al/Cu)	(1) 1/0 –750 (Al/Cu) or (2) 1/0 –300 (Al/Cu)
400 NEMA Type 3R	2	1/0–250 (Al/Cu)	(1) 1 –600 (Al/Cu) or (2) 1/0 –250 (Al/Cu)
600	2	4 –500 (Al/Cu)	4 –600 (Al/Cu)
800	3	3/0–500 (Al/Cu)	3/0–500 (Al/Cu)

[23] Electrical interlock kit catalog numbers with -1 suffix indicate one normally open and one normally closed contact; -2 indicates two normally open and two normally closed contacts. Kits are UL Listed.

[24] Single-pole single-throw interlock kits are rated 1/2 hp at 110 and 220 Vac.

[25] -1 Suffix uses a 9007A01 limit switch.

[26] -2 Suffix uses a 9007C03 limit switch.

[27] Light duty safety switches.

[28] 60 A non-fusible switches accept PK3GTA1.

[29] Two required if ground conductors are run in parallel.

[30] Not suitable for use on 400 A NEMA Type 3R.

[31] 30–100 A switches suitable for 60°C or 75°C conductors. 200–800 A switches suitable for 75°C conductors.

[32] Light duty switches only.



Dimensions for General Duty Safety Switches

Table 3.12: Approximate Dimensions

Cat.No.	Series	H		W		W/H		D		Std. Pack
		in.	mm	in.	mm	in.	mm	in.	mm	
L111N	E2	7.63	194	5.00	127	127	156	4.00	102	1
L211N	E2	7.63	194	5.00	127	6.13	156	4.00	102	1
L221N	E2	7.63	194	5.00	127	6.13	156	4.00	102	1
D211N	E3	9.25	235	6.75	171	7.25	184	3.63	92	5
D211NRB	E2	9.63	245	7.25	184	7.75	197	3.75	95	5
D221N	E3	9.25	235	6.75	171	7.25	184	3.63	92	5
D221NRB	E3	9.63	245	7.25	184	7.75	197	3.75	95	5
D222N	F1	14.63	372	6.50	165	7.45	189	4.88	124	1
D222NRB	F1	14.88	378	6.63	168	7.45	189	4.88	124	1
D223N	F3	17.50	445	8.50	216	10.50	267	6.50	165	1
D223NRB	F3	17.50	445	8.50	216	10.50	267	6.50	165	1
D224N	F1	29.00	737	17.25	438	19.00	483	8.25	210	1
D224NRB	F1	29.25	743	17.25	438	19.00	483	8.25	210	1
D225N	E3	45.12	1146	24.00	610	24.88	632	8.88	226	1
D225NR	E1	30.63	778	21.38	543	22.25	565	10.13	257	1
D226N	E3	49.13	1248	24.00	610	24.88	632	8.88	226	1
D226NR	E1	49.13	1248	24.75	629	25.13	638	8.88	226	1
D321N	E3	9.25	235	6.75	171	7.25	184	3.63	92	5
D321NRB	E3	9.63	245	7.25	184	7.75	197	3.75	95	5
D322N	F1	14.63	372	6.50	165	7.45	189	4.88	124	1
D322NRB	F1	14.88	378	6.63	168	7.45	189	4.88	124	1
D323N	F3	17.50	445	8.50	216	10.50	267	6.50	165	1
D323NRB	F3	17.50	445	8.50	216	10.50	267	6.50	165	1
D324N	F1	29.00	737	17.25	438	19.00	483	8.25	210	1
D324NRB	F1	29.25	743	17.25	438	19.00	483	8.25	210	1
D325N	E3	45.12	1146	24.00	610	24.88	632	8.88	226	1
D325NT	E3	45.12	1146	24.00	610	24.88	632	8.88	226	1
D325NR	E1	30.63	778	21.38	543	22.25	565	10.13	257	1
D325NTR	E1	30.63	778	21.38	543	22.25	565	10.13	257	1
D326N	E3	49.13	1248	24.00	610	24.88	632	8.88	226	1
D326NT	E3	49.13	1248	24.00	610	24.88	632	8.88	226	1
D326NR	E1	49.13	1248	24.75	629	25.13	638	8.88	226	1
D326NTR	E1	49.13	1248	24.75	629	25.13	638	8.88	226	1
DU221RB	E2	9.63	245	7.25	184	7.75	197	3.75	95	5
DU222RB	E1	9.63	245	7.25	184	7.75	197	3.75	95	5
DU321	E2	9.25	235	6.75	171	7.25	184	3.63	92	5
DU321RB	E2	9.63	245	7.25	184	7.75	197	3.75	95	5
DU322	E1	9.25	235	6.75	171	7.25	184	3.63	92	5
DU322RB	E1	9.63	245	7.25	184	7.75	197	3.75	95	5
DU323	F3	17.50	445	8.50	216	10.50	267	6.50	165	1
DU323RB	F3	17.50	445	8.50	216	10.50	267	6.50	165	1
DU324	F1	29.00	737	17.25	438	19.00	483	8.25	210	1
DU324RB	F1	29.25	743	17.25	438	19.00	483	8.25	210	1
DU325	E3	45.12	1146	24.00	610	24.88	632	8.88	226	1
DU326	E3	49.13	1248	24.00	610	24.88	632	8.88	226	1
QO200TR	G3	6.50	165	4.63	118	—	—	3.88	99	5
QO260NATS	E2	9.25	235	4.88	124	—	—	3.25	83	1
QO200NRB	E1	14.00	356	7.75	197	—	—	4.50	114	1
QO200NS	E1	13.38	340	6.13	156	—	—	3.50	89	1
T327N	E1	49.13	1248	24.00	610	24.88	632	8.88	226	1
T327NR	E1	49.13	1248	24.75	629	25.13	638	8.88	226	1

3

SAFETY SWITCHES

**Heavy Duty Safety Switches**



Visible blade heavy duty safety switches are designed for application where maximum performance and continuity of service are required. All heavy duty safety switches feature quick-make, quick-break operating mechanism, a dual cover interlock and a color coded indicator handle. They are suitable for use as service equipment when equipped with a field- or factory-installed neutral assembly or equipment grounding kit, unless a 600Y/347 V or 480 Y/277 V, 1000 A or greater, solidly grounded WYE system is used, per NEC 230-95. Heavy duty safety switches are UL Listed (except as noted). Files E2875 and E154828 meet or exceed the NEMA Standard KS1. For UL Listed short circuit current ratings, see

UL Listed Maximum Short Circuit Current Ratings-AC only, page 3-12.

**Table 3.13: 240 Volt—Single Throw Fusible**

Amperes	NEMA Type 1 Indoor	NEMA Type 3R Rainproof (Bolt-on Hubs [1])	NEMA Type 4, 4X, 5, [2] 304 Stainless Steel [3] Dust tight, Watertight, Corrosion Resistant (Watertight Hubs [1])	NEMA Type 12K With Knockouts (Watertight Hubs [1])	NEMA Type 3R, 5 or 12 [4] Without Knockouts (Watertight Hubs [1])	Line Side Barriers Factory Included [5]	Horsepower Ratings				250 Vdc [6]	
							240 Vac					
							Std. (Using Fast Acting, One Time Fuses)	Max. (Using Dual Element, Time Delay Fuses)				
							1Ø	3Ø	1Ø	3Ø		
							Cat. No.	Cat. No.	Cat. No.	Cat. No.	Cat. No.	Cat. No.
<b>2-Wire (2 Blades and Fuseholders)—240 Vac, 250 Vdc</b>												
30	Use three-wire devices For two-wire applications		H221DS	H221A	H221AWK	Factory Included	1-1/2	3 [7]	3	7-1/2 [7]	5	
30			—	—	H2212AWK [8]	Factory Included	1-1/2	—	3	—	5	
60			H222DS	—	H222AWK	Factory Included	3	7-1/2 [7]	10	15 [7]	10	
100			H223DS	H223A	H223AWK	Factory Included	7-1/2	15 [7]	15	30 [9]	20	
200			H224DS	H224A	H224AWK	Factory Included	15	25 [7]	—	60 [7]	40	
400	H225	H225R	H225DS	—	H225AWK	LSBG202	—	—	—	50		
600	H226	H226R	H226DS	—	H226AWK	LSBG202	—	75 [7]	—	200 [7]	50	
800	H227	H227R [10]	—	—	H227AWK	LSBF202	50	—	—	—	50	
1200	H228	H228R [10]	—	—	H228AWK	LSBF202	50	—	—	—	50	
<b>3-Wire (2 Blades and Fuseholders, 1 Neutral)—240 Vac, 250 Vdc</b>												
30	H221N	H221NRB	Use two-wire devices, See Field-Installed Neutral Assemblies, page 3-19			Factory Included	1-1/2	3 [7]	3	7-1/2 [9]	5	
60	H222N	H222NRB				Factory Included	3	7-1/2 [7]	10	15 [7]	10	
100	H223N	H223NRB				Factory Included	7-1/2	15 [7]	15	30 [7]	20	
200	H224N	H224NRB				Factory Included	15	25 [7]	—	60 [7]	40	
400	H225N	H225NR	H225NDS	—	H225NAWK	LSBG202	—	50 [7]	—	125 [7]	50	
600	H226N	H226NR	H226NDS	—	H226NAWK	LSBG202	—	75 [7]	—	200 [7]	50	
800	H227N	H227NR [10]	—	—	H227NAWK	LSBF202	50	—	—	—	50	
1200	H228N	H228NR [10]	—	—	H228NAWK	LSBF202	50	—	—	—	50	
<b>3-Wire (3 Blades and Fuseholders)—240 Vac, 250 Vdc</b>												
30	Use four-wire devices For three-wire applications		H321DS	H321A	H321AWK	Factory Included	1-1/2	3	3	7-1/2	5	
60			H322DS	H322A	H322AWK	Factory Included	3	7-1/2	10	15	10	
100			H323DS	H323A	H323AWK	Factory Included	7-1/2	15	15	30	20	
200			H324DS	H324A	H324AWK	Factory Included	15	25	—	60	40	
400			H325	H325R	H325DS	—	H325AWK	LSBG203	—	50	—	125
600	H326	H326R	H326DS	—	H326AWK	LSBG203	—	75	—	200	50	
800	H327	H327R [10]	—	—	H327AWK	LSBF203	50	100	—	250	50	
1200	H328	H328R [10]	—	—	H328AWK	LSBF203	50	100	—	250	50	
<b>4-Wire (3 Blades and Fuseholders, 1 Neutral)—240 Vac, 250 Vdc</b>												
30	H321N	H321NRB	Use three-wire devices, See Field-Installed Neutral Assemblies, page 3-19			Factory Included	1-1/2	3	3	7-1/2	5	
60	H322N	H322NRB				Factory Included	3	7-1/2	10	15	10	
100	H323N	H323NRB				Factory Included	7-1/2	15	15	30	20	
200	H324N	H324NRB				Factory Included	15	25	—	60	40	
400	H325N	H325NR	H325NDS	—	H325NAWK	LSBG203	—	50	—	125	50	
600	H326N	H326NR	H326NDS	—	H326NAWK	LSBG203	—	75	—	200	50	
800	H327N	H327NR [10]	—	—	H327NAWK	LSBF203	50	100	—	250	50	
1200	H328N	H328NR [10]	—	—	H328NAWK	LSBF203	50	100	—	250	50	
<b>4-Wire (4 Blades and Fuseholders) Use 600 Vac devices. See 600 Volt—Single Throw Fusible Switches, page 1–10.</b>												

Accessories: see page 3-16  
 Dimensions: NEMA Type 1 and 3R, see page 3-22  
 Dimensions: NEMA Type 4, 4X and 5 Stainless and NEMA Type 12, see page 3-23

[1] For Rainproof Bolt-On Hubs and Watertight Hubs see Hubs, page 3-16.  
 [2] Complete rating is NEMA Type 3, 3R, 4, 4X, 5 and 12. For NEMA Type 3R applications, remove drain screw from bottom endwall.  
 [3] See 316 Grade Stainless Steel—NEMA Type 3, 3R, 4, 4X, 5, 12, page 3-13.  
 [4] Also suitable for NEMA Type 3R application by removing drain screw from bottom endwall.  
 [5] Factory included to prevent inadvertent contact with live parts per .UL 869A and NEC Service entrance barrier requirements.  
 [6] For switching dc, use two outside switching poles.  
 [7] For corner grounded delta systems, use switching poles for ungrounded conductors. See data bulletin 2700DB0202 for additional information.  
 [8] 60 ampere switch with 30 ampere fuse spacing and clips. Must use 60 A enclosure accessories including electrical interlocks.  
 [9] For corner grounded delta systems, use switching poles for ungrounded conductors.  
 [10] Suitable for NEMA Type 5 applications with drain screw installed.

600 Volt—Single Throw Fusible

Table 3.14: 600 Volt—Single Throw Fusible

Amperes	NEMA Type 1 Indoor	NEMA Type 3R Rainproof (Bolt-on Hubs [11])	NEMA Type 4, 4X, 5 [12] 304 Stainless Steel (316 stainless [13]) Dust tight, Watertight, Corrosion Resistant (Watertight Hubs [11])	NEMA Type 12K With Knockouts (Watertight Hubs [11])	NEMA Type 3R, 5 or 12 [14] Without Knockouts (Watertight Hubs [11])	Line Side Barriers Factory included [15]	Horsepower Ratings					
							480 Vac		600 Vac		dc [16]	
							Std. (Using Fast Acting, One Time Fuses)	Max. (Using Dual Element, Time Delay Fuses)	Std. (Using Fast Acting, One Time Fuses)	Max. (Using Dual Element, Time Delay Fuses)		
Cat. No.	Cat. No.	Cat. No.	Cat. No.	Cat. No.	Cat. No.	3Ø	3Ø	3Ø	3Ø	250	600	
<b>2-Wire (2 Blades and Fuseholders)—600 Vac, 600 Vdc</b>												
30	Use three-wire devices for two-wire applications					—	—	—	—	—	—	
60						—	—	—	—	—		
100						—	—	—	—	—		
200						—	—	—	—	—		
400	H265	H265R	H265DS	—	H265AWK	LSBG602	100 [17]	250 [17]	—	—	50	50
600	H266	H266R	H266DS	—	H266AWK	LSBG602	150 [17]	400 [17]	—	—	50	50
800	H267	H267R [18]	—	—	H267AWK	LSBF602	—	—	—	—	—	50
1200	H268	H268R [18]	—	—	H268AWK	LSBF602	—	—	—	—	—	50
<b>3-Wire (3 Blades and Fuseholders)—600 Vac, 600 Vdc</b>												
30	H361	H361RB	H361DS	H361A	H361AWK	Factory included	5	15	7-1/2	20	5	15
30	H3612 [19]	H3612RB [19]	—	H3612A [19]	H3612AWK [19]	Factory included	5	15	7-1/2	20	—	15
60	H362	H362RB	H362DS	H362A	H362AWK	Factory included	15	30	15	50	—	30
100	H363	H363RB	H363DS	H363A	H363AWK	Factory included	25	60	30	100	—	50
200	H364	H364RB	H364DS	H364A	H364AWK	Factory included	50	125	60	150	40	50
400	H365	H365R	H365DS	—	H365AWK	LSBG602	100	250	125	350	50	50
600	H366	H366R	H366DS	—	H366AWK	LSBG602	150	400	200	500	50	50
800	H367	H367R [18]	—	—	H367AWK	LSBF602	200	500	250	500	—	50
1200	H368	H368R [18]	—	—	H368AWK	LSBF602	200	500	250	500	—	50
<b>4-Wire (3 Blades and Fuseholders, 1 Neutral)—600 Vac, 600 Vdc</b>												
30	H361N	H361NRB	Use three-wire devices. See Field-Installed Neutral Assemblies, page 3-19			Factory included	5	15	7-1/2	20	—	15
60	H362N	H362NRB				Factory included	15	30	15	50	—	30
100	H363N	H363NRB				Factory included	25	60	30	75	—	50
200	H364N	H364NRB				H364NDS	H364NA	H364NAWK	Factory included	50	125	60
400	H365N	H365NR	H365NDS	—	H365NAWK	LSBG602	100	250	125	350	50	50
600	H366N	H366NR	H366NDS	—	H366NAWK	LSBG602	150	400	200	500	50	50
800	H367N	H367NR [18]	—	—	H367NAWK	LSBF602	200	500	250	500	—	50
1200	H368N	H368NR [18]	—	—	H368NAWK	LSBF602	200	500	250	500	—	50
<b>4-Wire (4 Blades and Fuseholders)—600 Vac, 600 Vdc [20]</b>												
30	H461	—	H461DS	—	H461AWK	Factory included	7-1/2	20	10	25	5	15
60	H462	—	H462DS	—	H462AWK	Factory included	15	40	20	50	10	30
100	H463	—	H463DS	—	H463AWK	Factory included	25	60	30	75	20	30
200	H464	—	H464DS	—	H464AWK	Factory included	50	125	60	150	40	50
400	H465	—	—	—	H465AWK	QTY (2): LSBG602	100	250	125	350	50	50
600	H466	—	—	—	—	QTY (2): LSBG602	150	400	200	500	50	50
<b>6-Wire (6 Blades and Fuseholders)—600 Vac [20]</b>												
100	—	—	H663DS	—	H663AWK	Factory included	25	60	30	75	—	—
200	—	—	H664DS	—	H664AWK	Factory included	For applications requiring motor disconnect capability, see Electrical Interlock Kits, page 3-17					

Accessories: see page 3-16  
 Dimensions: NEMA Type 1 and 3R, see page 3-22  
 Dimensions: NEMA Type 4, 4X and 5 Stainless and NEMA Type 12, see page 3-23

[11] For Rainproof Bolt-On Hubs and Watertight Hubs see Hubs, page 3-16.  
 [12] Complete rating is NEMA Type 3, 3R, 4, 4X, 5 and 12..  
 [13] See 316 Grade Stainless Steel 3 Pole 600 Vac, 600 Vdc, page .  
 [14] Also suitable for NEMA Type 3R application by removing drain screw from bottom endwall.  
 [15] Factory included to prevent inadvertent contact with live parts per UL 869A and NEC Service entrance barrier requirements.  
 [16] For switching dc, use two outside switching poles.  
 [17] For corner grounded delta systems, use switching poles for ungrounded conductors. See data bulletin 2700DB0202 for additional information.  
 [18] Suitable for NEMA Type 5 applications with drain screw installed.  
 [19] 60 A switch with 30 A fuse spacing and clips. Must use 60 A enclosure accessories including electrical interlocks.  
 [20] Not suitable for use as service equipment.

SAFETY SWITCHES

**Class H, R, J, and L Fuse Provisions:**

**Class H or K Fuse Provisions:** Fusible Square D 30–600 A heavy duty safety switches accept Class H or K fuses as standard. With Class H or K fuses installed, the switch is UL Listed for use on systems with up to 10 kA available fault current.

**Class R Fuse Provisions:** Fusible Square D 30–600 A heavy duty safety switches will accept Class R fuses as standard. A field-installed rejection kit is available which, when installed, rejects all but Class R fuses. With the installation of the rejection kit and Class R fuses, the switch is UL Listed for use on systems with up to 200 kA available fault current. See [Class R Fuse Kits, page 3-17](#).

**Class J Fuse Provisions:** Provisions for installing Class J fuses are included in 30–400 A 600 Volt, and 100–400 A 240 Volt, fusible heavy duty safety switches. Conversion to Class J fuse spacing requires relocating the load side fuse base assembly from the standard Class H fuse location to an alternate position as marked in the enclosure. With Class J fuses installed, the switch is UL Listed for use on systems with up to 200 kA available fault current. Switches rated 600 A, 240 or 600 Volt, require the addition of an adapter kit, H600J. One kit per three-pole switch.

**Class L Fuse Provisions:** Fusible 800 A and 1200 A safety switches use Class L bolt-in fuses and are rated for use on systems with up to 200 kA at 600 Vac maximum. 1200 A switches accept class L fuses from 601–1200 A, 800 A switches accept class L fuses from 601–800 A.

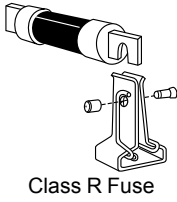

Class R Fuse

**600 Volt—Single Throw Non-Fusible**

**Table 3.15: 600 Volt—Single Throw Non-Fusible**

System	Amperes	NEMA Type 1 Indoor	NEMA Type 3R Rainproof [21]	NEMA Type 4, 4X, 5 [22] 304 Stainless Steel [23] Dust tight, Watertight Corrosion Resistant [21]	NEMA Type 12K With Knockouts [21]	NEMA Type 3R, 5 or 12 [24] Without Knockouts [21]	Line Side Barriers [25]	Horsepower Ratings (Max.)									
								Volts ac								dc [26]	
								240		Line 480		600		dc [26]			
								1Ø	3Ø	1Ø	3Ø	1Ø	3Ø	250	600		
<b>2-Wire (2 Blades)—600 Vac, 600 Vdc</b>																	
	30							—	—	—	—	—	—	—	—		
	60							—	—	—	—	—	—	—	—		
	100							—	—	—	—	—	—	—	—		
	200							—	—	—	—	—	—	—	—		
	400	HU265	HU265R	HU265DS	—	HU265AWK	LSBG602	—	125	—	250	—	—	50	50		
	600	HU266	HU266R	HU266DS	—	HU266AWK	LSBG602	—	200	—	400	—	—	50	50		
	800	HU267	HU267R [27]	—	—	HU267AWK	LSBF602	—	—	—	—	50	—	—	50		
1200	HU268	HU268R [27]	—	—	HU268AWK	LSBF602	—	—	—	—	50	—	—	50			
<b>3-Wire (3 Blades)—600 Vac, 600 Vdc</b>																	
	30	HU361	HU361RB	HU361DS	HU361A	HU361AWK	[25]	5	10	7-1/2	20	10	30	5	15		
	30	HU361EI [28]	HU361RBEI [28]	HU361DSEI [28]	HU361AEI [28]	HU361AWKEI [28]	[25]	5	10	7-1/2	20	10	30	5	15		
	30	—	HU3612RB [29]	—	HU3612A [29]	HU3612AWK [29]	[25]	5	10	7-1/2	20	10	30	5	15		
	60	HU362	HU362RB	HU362DS	HU362A	HU362AWK	[25]	10	20	25	50	30	60	10	30		
	60	—	—	HU362DSEI [28]	—	—	[25]	10	20	25	50	30	60	10	30		
	100	HU363	HU363RB	HU363DS	HU363A	HU363AWK	[25]	20	40	40	75	40	100	20	50		
	200	HU364	HU364RB	HU364DS	HU364A	HU364AWK	[25]	15	60	50	125	50	150	40	50		
	400	HU365	HU365R	HU365DS	—	HU365AWK	LSBG602	—	125	—	250	—	350	50	50		
	600	HU366	HU366R	HU366DS	—	HU366AWK	LSBG602	—	200	—	400	—	500	50	50		
	800	HU367	HU367R [27]	—	—	HU367AWK	LSBF602	—	—	—	500	50	500	—	50		
	1200	HU368	HU368R [27]	—	—	HU368AWK	LSBF602	—	—	—	50	500	—	—	50		
	<b>4-Wire (4 Blades)—600 Vac, 600 Vdc [30]</b>																
	30	HU461 [31]	—	HU461DS	—	HU461AWK [32]	[25]	10	10	20	20	25	30	10 [33]	15 [33]		
	60	HU462 [31]	—	HU462DS	—	HU462AWK	[25]	20	20	40	50	50	60	10	30		
	100	HU463 [31]	—	HU463DS	—	HU463AWK	[25]	30	40	50	75	50	75	20	30		
	200	HU464 [31]	—	HU464DS	—	HU464AWK	[34]	50	60	50	125	50	150	40	50		
	400	HU465	—	—	—	HU465AWK	QTY (2): LSBG602	—	125	—	250	—	350	50	50		
	600	HU466	—	—	—	—	QTY (2): LSBG602	—	200	—	400	—	500	50	50		
<b>6-Wire (6 Blades)—600 Vac [30]</b>																	
	30	—	—	HU661DS	—	HU661AWK	[25]	—	10	—	20	—	30	—	—		
	60	—	—	HU662DS	—	HU662AWK	[25]	—	20	—	50	—	60	—	—		
	100	—	—	HU663DS	—	HU663AWK	[25]	—	50	—	75	—	75	—	—		
	200	—	—	HU664DS	—	HU664AWK	[25]	—	60	—	125	—	150	—	—		

[21] For Rainproof Bolt-On Hubs and Watertight Hubs see [Hubs, page 3-16](#).  
 [22] Complete rating is NEMA Type 3, 3R, 4, 4X, 5 and 12.  
 [23] For 316 stainless, see [316 Grade Stainless Steel—NEMA Type 3, 3R, 4, 4X, 5, 12, page 3-13](#).  
 [24] Also suitable for NEMA Type 3R application by removing drain screw from bottom endwall.  
 [25] Factory Included to prevent inadvertent contact with live parts per UL 869A and NEC service entrance barrier requirements.  
 [26] For switching dc, use two outside switching poles.  
 [27] Suitable for NEMA Type 5 applications with drain screw installed.  
 [28] Switches with EI suffix are stocked with factory-installed electrical interlocks with one normally-open and one normally-closed contact.  
 [29] Use 60 A enclosure accessories, including electrical interlocks.  
 [30] Not suitable for use as service equipment.  
 [31] No knockouts are provided.  
 [32] Requires 60 A accessories. See [NEMA Type 4, 4X, 5, 7, 9, and 12, page 3-23](#) for series rating.  
 [33] HU461AWK (Series F6) is rated 5 hp@250 Vdc, 15 hp@600 Vdc.  
 [34] Factory Included to prevent inadvertent contact with live parts. UL 869A and NEC service entrance barrier requirements.

**UL Listed Maximum Short Circuit Current Ratings—AC only**

**Table 3.16: Fusible Safety Switches**

**NOTE:** Consult the wiring diagram of the switch to verify the UL Listed short circuit current rating.

Heavy Duty Safety Switch Type	UL Listed Fuse Class	UL Listed Short Circuit Current Ratings
Fusible	H, K	10 kA
	R, J, L	200 kA [35]

**Non-Fusible Safety Switches**

**Systems equal or less than 10 kAIR SCCR**—Any brand of circuit breaker or fuse not exceeding the ampere rating of the switch may be used in conjunction with a non-fusible safety switch.

**Systems above 10 kAIR SCCR**—The UL Listed short circuit current rating for Square D non-fusible switches is based upon the switch being used in conjunction with fuses or Square D circuit breakers or Mag-Gard motor circuit protectors.

**Table 3.17: Non-Fusible Safety Switches** [36] [37]

Switch Rating (A)	Fuse or Circuit Breaker Type [38]	3-Phase			250 Vdc / 600 Vdc
		240 Vac	480 Vac	600 Vac	
<b>With Upstream Fuse Protection</b>					
All	H, K	10 kA	10 kA	10 kA	Up to 10 kA
	R,T,J,L	200 kA	200 kA	200 kA	
<b>With Upstream Circuit Breaker Protection</b>					
All	Any brand circuit breaker	10 kA	10 kA	10 kA	Up to 10 kA
30–100	HD	25 kA	18 kA	14 kA	
30–100	HG	65 kA	35 kA	18 kA	
30–100	HJ	65 kA	35 kA	25 kA	
30–100	HL	65 kA	35 kA	35 kA	
30–100	HR	65 kA	35 kA	35 kA	
30–100	FA	14 kA	14 kA	14 kA	
30–100	FH	18 kA	18 kA	18 kA	
200	HD, JD	25 kA	18 kA	14 kA	
200	HG, JG	65 kA	35 kA	18 kA	
200	HJ, JJ	65 kA	35 kA	25 kA	
200	HL, JL	65 kA	35 kA	35 kA	
200	HR, JR	65 kA	35 kA	35 kA	
400	LA	22 kA	22 kA	22 kA	
400	LH	25 kA	25 kA	25 kA	
400–600	LD	25 kA	18 kA	14 kA	
400–600	LG	65 kA	35 kA	18 kA	
400–600	LJ	100 kA	65 kA	25 kA	
400–600	LL	100 kA	65 kA	50 kA	
400–600	LR	100 kA	65 kA	65 kA	

3

SAFETY SWITCHES

[35] On 600 V, 200 A switches, 100,000 A max. on corner grounded delta when protected by Class J or R fuses.

[36] For NEMA Type 4X Fiberglass Reinforced Polyester switches, see page 3-13.

[37] NEMA Type 7/9 SCCR 10 kAIR 600 Vac maximum.

[38] Ampere rating of fuse or circuit breaker not to exceed switch ampere rating.

**Special Application Heavy Duty Safety Switches**



H361SS



H363DF



H361DX

**316 Grade Stainless Steel—NEMA Type 3, 3R, 4, 4X, 5, 12**

316 stainless steel enclosure safety switches offer superior corrosion resistance to a wider range of chemicals than 304 stainless switches. 316 better resists chloride and is often used in marine, waste treatment and transportation applications. Use watertight hubs, see [Hubs, page 3-16](#). Equipment grounding lugs are supplied as standard through 200 A. See [Table 3.40 Terminal Lug Data, page 3-21](#) for wire Termination data for grounding lugs. (For 304 stainless switches, see [240 Volt, page 3-9](#) and [600 Volt, page 3-10](#).)

**Table 3.18: 316 Grade Stainless Steel 3 Pole 600 Vac, 600 Vdc**

Amperes	Cat. No	Line Side Barriers <sup>[39]</sup>	Horsepower Ratings— 3Ø				
			480 Vac <sup>[40]</sup>		600 Vac <sup>[40]</sup>		600 Vdc <sup>[41]</sup>
			Std.	Max.	Std.	Max.	Max.
<b>Fusible—3P, 600 Vac, 600 Vdc</b>							
30	H361SS	Factory Included	5	15	7-1/2	20	15
60	H362SS	Factory Included	15	30	15	50	30
100	H363SS	Factory Included	25	60	30	75	50
200	H364SS	Factory Included	50	125	60	150	50
400	H365SS	LSBG602	100	250	125	350	50
600	H366SS	LSBG602	150	400	200	500	50
<b>Non-Fusible—3P, 600 Vac, 600 Vdc</b>							
30	HU361SS	Factory Included	—	20	—	30	15
60	HU362SS	Factory Included	—	50	—	60	30
100	HU363SS	Factory Included	—	75	—	100	50
200	HU364SS	Factory Included	—	125	—	150	50
400	HU365SS	LSBG602	—	250	—	350	50
600	HU366SS	LSBG602	—	400	—	500	50

**Fiberglass Reinforced Polyester Enclosures—NEMA Type 4X**

Fiberglass reinforced polyester enclosures are watertight, corrosion resistant, and impervious to windblown dust, rain, and splashing liquid. The molded fiberglass is extremely stable in a wide range of operating temperatures and can withstand heavy impact. Switches are furnished with hubs, conduit provisions [Table 3.41](#), and equipment grounding lugs. See CAD drawings of the switch to verify the UL listed short circuit current rating or the enclosed safety switch catalog. UL Listed.

**Table 3.19: Fiberglass Reinforced Polyester Enclosures NEMA Type 4X 3 Pole 600 Vac, 600 Vdc**

Amperes	Cat. No.	Solid Neutral Assembly Kit	Class R Fuse Kits	Electrical Interlock Kits Field-Installed Cat. No.		Line Side Barriers Factory Included <sup>[39]</sup>	Horsepower Ratings— 3Ø					Hubs <sup>[42]</sup>	
				Cat. No.	1 NO/1 NC Contacts		2 NO/2 NC Contacts	480 Vac <sup>[43]</sup>		600 Vac <sup>[43]</sup>			600 Vdc <sup>[44]</sup>
								Std.	Max.	Std.	Max.		Max.
<b>Fusible—3P, 600 Vac, 600 Vdc</b>													
30	H361DF	SN03	RFK06	9999TC10	9999TC20	Factory Included	5	15	7-1/2	20	15	3/4	
60	H362DF	SN03	RFK06H	9999TC10	9999TC20	Factory Included	15	30	15	50	30	1-1/4	
100	H363DF	SN0610	RFK10	9999TC10	9999TC20	Factory Included	25	60	30	75	50	2	
200	H364DF	—	HRK1020	9999R8	9999R9	—	50	125	60	150	50	2-1/2	
<b>Non-Fusible—3P, 600 Vac, 600 Vdc</b>													
30	HU361DF	SN03	—	9999TC10	9999TC20	Factory Included	—	20	—	30	15	3/4	
60	HU362DF	SN03	—	9999TC10	9999TC20	Factory Included	—	50	—	60	30	1-1/4	
100	HU363DF	SN0610	—	9999TC10	9999TC20	Factory Included	—	75	—	75	50	2	
200	HU364DF	—	—	9999R8	9999R9	—	—	125	—	150	50	2-1/2	

[39] Factory included to prevent inadvertent contact with live parts per UL 869A and NEC service entrance barrier requirements.

[40] Std.—Using fast acting, one time fuses. Max.—Using dual element time delay fuses.

[41] For switching dc use two switching poles.

[42] Two hubs and hub drilling template are provided for field installation.

[43] Std.—Using fast acting, one time fuses. Max.—Using dual element time delay fuses.

[44] For switching dc use two switching poles.

**Krydon™ Enclosures—NEMA Type 4X**

Krydon enclosures are compression molded of fiberglass reinforced polyester, specially formulated to withstand attack from almost any corrosive atmosphere found in the toughest industrial application. Switches are furnished with watertight hubs and equipment grounding lugs. See CAD drawing of the switch to verify the UL listed short circuit current rating or the enclosed safety switch catalog. UL Listed.

**Table 3.20: Krydon™ Enclosures — NEMA Type 4X 3 Pole 600 Vac, 600 Vdc**

Amperes	Cat. No.	Solid Neutral Assembly Kit	Class R Fuse Kits	Electrical Interlock Kits Field-Installed Cat. No.		Line Side Barriers Factory Included [45]	Horsepower Ratings— 3Ø					Hubs [46]
				Cat. No.	1 NO/1 NC Contact		2 NO/2 NC Contacts	480 Vac [47]		600 Vac [47]		
			Std.		Max.		Std.	Max.	Max.			
<b>Fusible—3P, 600 Vac, 600 Vdc</b>												
30	H361DX	H60SN	RFK06	9999TC10	9999TC20	Factory Included	5	15	7-1/2	20	15	3/4
60	H362DX	H60SN	RFK06H	9999TC10	9999TC20	Factory Included	15	30	15	50	30	1-1/4
100	H363DX	SN0610	RFK10	9999TC10	9999TC20	Factory Included	25	60	30	75	50	2
<b>Non-Fusible—3P, 600 Vac, 600 Vdc</b>												
30	HU361DX	H60SN	—	9999TC10	9999TC20	Factory Included	—	20	—	30	15	3/4
60	HU362DX	H60SN	—	9999TC10	9999TC20	Factory Included	—	50	—	60	30	1-1/4
100	HU363DX	SN0610	—	9999TC10	9999TC20	Factory Included	—	75	—	75	50	2

[45] Factory included to prevent inadvertent contact with live parts per UL 869A and NEC service entrance barrier requirements.

[46] Two hubs and hub drilling template are provided for field installation.

[47] Std.—Using fast acting one time fuses. Max.—Using dual element time delay fuses.

[48] For switching dc, use two outside switching poles.



**Interlocked Receptacle Switches**

**Interlocked Receptacle Switches** [49] are furnished with a factory-installed three-phase four-wire Appleton Powertite™, Crouse-Hinds Style 2 Arkтите™, or Hubbellock™ receptacle. The fourth wire is connected to the switch equipment grounding terminal and is not a solid neutral termination. Interlocking linkage between the receptacle and switch mechanism prevents insertion or removal of the plug while the switch is in the "ON" position or insertion of any plug other than specified. Grounding lugs are included. See wiring diagram of the switch to verify the UL listed short circuit current rating or the enclosed safety switch catalog.

**Appleton Powertite Receptacle**

- UL Listed and CSA Certified
- Available in 30 -100 A, 600 Vac/250 Vdc, fused or non-fused, NEMA Type 1, NEMA Type 4/4X/5 stainless steel and NEMA Type 12/3R
- Suitable for use as service equipment (USA only)
- Receptacles are epoxy powder coated over copper-free cast aluminum

**Table 3.21: Appleton Powertite Receptacle Switches**

Amperes	NEMA Type 1	NEMA Type 3, 3R, 4, 4X, 5, 12 304 Stainless Steel Enclosure	NEMA Type 12, 3R	Use with Plug [50]	Horsepower Ratings—3Ø					
					480 Vac [51]		600 Vac [52]		250 Vdc[53]	
					Std.	Max.	Std.	Max.	Std.	Max.
<b>Fusible—3P, 600 Vac, 250 Vdc</b>										
30	H361WA	H361DSWA	H361AWA	ACP3034BC	5	15	7-1/2	20	5	—
60	H362WA	H362DSWA	H362AWA	ACP6034BC	15	30	15	50	10	—
100	H363WA	H363DSWA	H363AWA	ACP1034CD	25	60	30	75	20	—
<b>Non-Fusible—3P, 600 Vac, 250 Vdc</b>										
30	HU361WA	HU361DSWA	HU361AWA	ACP3034BC	—	20	—	30	—	5
60	HU362WA	HU362DSWA	HU362AWA	ACP6034BC	—	50	—	60	—	10
100	HU363WA	HU363DSWA	HU363AWA	ACP1034CD	—	75	—	100	—	20

**Table 3.22: Appleton Powertite 600 Vac Short Circuit Current Rating**

Amperes	10 kAIR Fuses	100 kAIR Fuses	200 kAIR Fuses	14 kAIR Circuit Breaker	18kAIR Circuit Breaker
<b>Fusible—3P, 600 Vac, 250 Vdc</b>					
30	H, K	—	J, R	—	—
60	H, K	—	J, R	—	—
100	H, K	—	J, R	—	—
<b>Non-Fusible—3P, 600 Vac, 250 Vdc</b>					
30	H, K	J, R, T [54]	J, R, T	FA	FH
60	H, K	—	J, R, T	FA	FH
100	H, K	—	J, R, T	FA	FH

[49] Accessories and Special Features, page 3-16

[50] Receptacle UL listed for use with Appleton™ ACP or CPH plugs; UL Classified for use with Crouse-Hinds APJ Arkтите™ plugs. (see Table 3.23.

[51] Std.—Using fast acting one time fuses. Max.—Using dual element time delay fuses.

[52] Std.—Using fast acting one time fuses. Max.—Using dual element time delay fuses.

[53] For switching dc, use two outside switching poles.

[54] SCCR when using 60 Amp Max fuse.



### Crouse-Hinds Arktite Receptacle

- UL Listed
- Available in 30 -100 A, 600 Vac/250 Vdc, fused or non-fused, NEMA Type 1, NEMA Type 4/4X/5 stainless steel and NEMA Type 12/3R
- Suitable for use as service equipment
- Receptacles are cast aluminum, copper free for NEMA Type 1 and NEMA Type 12/3R safety switches
- Receptacles are epoxy powder coated, copper free cast aluminum for NEMA Type 4/4X/5 stainless steel safety switches

Table 3.23: Crouse-Hinds Arktite Safety Switch

Amperes	NEMA Type 1	NEMA Type 4, 4X, 5 304 Stainless Steel Enclosure	NEMA Type 12, 3R	Use with Plug	Horsepower Ratings—3Ø					
					480 Vac [55]		600 Vac [56]		250 Vdc [57]	
	Cat. No.	Cat. No.	Cat. No.	Cat. No.	Std.	Max.	Std.	Max.	Std.	Max.
<b>Fusible—3P, 600 Vac, 250 Vdc</b>										
30	H361WC	H361DSWC	H361AWC	APJ3485	5	15	7-1/2	20	5	—
60	H362WC	H362DSWC	H362AWC	APJ6485	15	30	15	50	10	—
100	H363WC	H363DSWC	H363AWC	APJ10487	25	60	30	75	20	—
<b>Non-Fusible—3P, 600 Vac, 250 Vdc</b>										
30	HU361WC	HU361DSWC	HU361AWC	APJ3485	—	20	—	30	—	5
60	HU362WC	HU362DSWC	HU362AWC	APJ6485	—	50	—	60	—	10
100	HU363WC	HU363DSWC	HU363AWC	APJ10487	—	60	—	100	—	20

Table 3.24: Crouse-Hinds 600 Vac Short Circuit Current Rating

Amperes	10 kAIR Fuses	100 kAIR Fuses	200 kAIR Fuses	14 kAIR Circuit Breaker	18kAIR Circuit Breaker
<b>Fusible—3P, 600 Vac, 250 Vdc</b>					
30	H, K	—	J, R	—	—
60	H, K	—	J, R	—	—
100	H, K	—	J, R	—	—
<b>Non-Fusible—3P, 600 Vac, 250 Vdc</b>					
30	H, K	J, R, T [58]	J, R, T	FA	FH
60	H, K	—	J, R, T	FA	FH
100	H, K	—	J, R, T	FA	FH

### Hubbelock Receptacle

- UL Listed
- Available in 30 -100 A, 600 Vac/250 Vdc, fused or non-fused, NEMA Type 1, and NEMA Type 12
- Suitable for use as service equipment [59]
- Receptacles are zinc plated steel for NEMA Type 1 and 12 safety switches
- Short Circuit Current Rating for fusible switches is 10 kAIR maximum when used with Class H, K, J or R fuses
- Short Circuit Current Rating for non-fusible switches is 10 kAIR maximum when protected by Class H, K, J, R or T fuses

Table 3.25: Hubbelock Receptacle Safety Switch

Amperes	NEMA Type 1	NEMA Type 12	Use with Plug [60]	Horsepower Ratings—3Ø			
				480 Vac [56]		600 Vac [56]	
	Cat. No.	Cat. No.	Cat. No.	Std.	Max.	Std.	Max.
<b>Fusible—3P, 600 Vac</b>							
60	H362WH	H362AWH	SD12781	15	30	15	50
<b>Non-Fusible—3P, 600 Vac</b>							
60	HU362WH	HU362AWH	SD12781	—	50	—	60

Square D by Schneider Electric brand heavy duty safety switches are UL listed for use with the following accessories:

### Rainproof Bolt-On Hubs

- UL Listed for indoor or rainproof applications
- Suitable for use with conduit having ANSI standard taper pipe thread
- NEMA Type 3R switches with catalog number ending in RB have a bolt-on closing cap factory installed
  - Accepts 3/4 in. through 2-1/2 in. bolt-on hubs
  - No gaskets required
- NEMA Type 3R switches with R suffix have blank top endwalls
  - Accepts 3 in. through 4 in. bolt on hubs
  - Gaskets provided
  - Conduit entry holes must be cut in the field



Table 3.26: Rainproof Bolt-On Hubs [61]

Conduit Size	3/4	1	1-1/4	1-1/2	2	2-1/2	3	4	Closing Cap
Hub Cat. No.	B075	B100	B125	B150	B200	B250	B300	B400	BCAP

[55] Std.—Using fast acting one time fuses. Max.—Using dual element time delay fuses.

[56] Std.—Using fast acting one time fuses. Max.—Using dual element time delay fuses.

[57] For switching dc, use two outside switching poles.

[58] SCCR when using 60 Amp Max fuse.

[59] Receptacle only rated for NEMA Type 1 and 12 applications.

[60] Hubbell plug is furnished with a Kellems grip for 1-1/2 in. to 1-21/64 in. cable diameter.

[61] Gaskets are provided on 3 in. and larger hubs.

**Watertight Hubs**

- UL Listed for dusttight and watertight applications
- Suitable for use with conduit having ANSI standard taper pipe thread
- Watertight hubs are field installed on NEMA Type 4/4X/5 stainless steel and NEMA Type 12/3R and 12K enclosures
- Watertight hubs are available in zinc or chrome plated finish
- Gaskets provided



Watertight Hubs

**Table 3.27: Watertight Hubs** [62]

Conduit Size	1/2	3/4	1	1-1/4	1-1/2	2	2-1/2	3	3-1/2	4
Standard-Zinc Hub Cat. No.	H050	H075	H100	H125	H150	H200	H250	H300	H350	H400
Chrome Plated Hub Cat. No.	H050CP	H075CP	H100CP	H125CP	H150CP	H200CP	—	—	—	—

**Electrical Interlock Kits**

Electrical interlocks for heavy duty safety switches 30 A through 1200 A are available as field installed kits, or on Type 12 or Type 4X enclosure factory installed. A pivot arm operates from the switch mechanism, breaking the control circuit before the main switch blades break. See supplemental digest section 2 for contact ratings. UL Listed for factory or field installation. For factory installation catalog numbers available on Type 12 or 4X enclosures use the product configurator.

**Table 3.28: Electrical Interlock Kit** [63] [64]

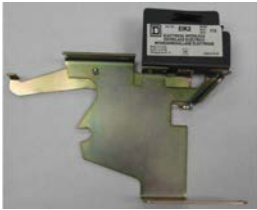

EIK2 Electrical Interlock Kit

Switch Amperes Rating	Series Number [65]	Electrical Interlock Kit Cat. No. [66]
30	F5-F6	EIK031
		EIK032
60 (600 V)	F5-F6	EIK1
		EIK2
60 (240 V)	F5-F6	EIK031
		EIK032
100-200	F5-F6	EIK1
		EIK2
30-100 Receptacle Switches	F5-F7	EIK1
		EIK2
30-200 Four- and Six-Pole Switches	F5-F6	EIK1
		EIK2
400-1200	E4-E5	EIK40601
		EIK40602

**Class R Fuse Kits**

When installed, kit limits switch to Class R fuses only. Kits are available for field installation. Each kit supports one three pole switch.

**Table 3.29: 240 Vac — Class R Fuse Kits** [67]

Amperes	Series Number	Class R Fuse Kit Cat. No.
30	F5-F6	RFK03L
60	F5-F6	RFK03H
100	F5-F6	RFK10
200	F5-F6	HRK1020
400-600	E4-E5	HRK4060

**Table 3.30: 600 Vac — Class R Fuse Kits** [67] [68]

Amperes	Series Number	Class R Fuse Kit Cat. No.
30 [69]	F5-F6	RFK03H
30 A Receptacle Switches	F7	RFK06
30 A Four-Pole Switches	F5-F6	RFK06
60	F5-F7	RFK06H
100	F5-F7	RFK10
200	F5-F6	HRK1020
400-600	E4-E5	HRK4060

[62] Gaskets are provided.

[63] For series not shown in table refer to the switch wiring diagram.

[64] Electrical interlocks for NEMA Type 4X fiberglass reinforced polyester and Krydon™ see Table 3.19 and Table 3.20 respectively.

[65] See page 3-22 and page 3-23 for safety switch series.

[66] Electrical interlock kit catalog numbers ending in 1 indicates one normally open and one normally closed contact. These kits use a 9007A01 industrial snap switch. Electrical interlock kit catalog numbers ending in 2 indicates two normally open and two normally closed contacts. These kits use a 9007C03 industrial snap switch.

[67] For series not shown in the table, refer to the switch wiring diagram.

[68] Class R Fuse Kits for Fiberglass Reinforced Polyester enclosures and Krydon™ enclosures see Table 3, page 3-13 and Table 5, page 3-14 respectively.

[69] H361-2, H361-2A, H361-2AWK and H361-2RB use RFK06.

### Line Side Barrier Kit

The field instable line side barrier kits are required to meet the code for service entrance applications. Barrier kits prevent accidental contact with line side, un-insulated, ungrounded or service terminal live parts.

**Table 3.31: Line Side Barrier Kit**

Catalog	Description	Blades / Fuses	Safety Switch Application
LSBD202	Line Side Barriers for General Duty and Heavy Duty	2 or 3	240 V — 30 A 240 V — 60 A
LSBC02	Line Side Barriers for General Duty and Heavy Duty	2 or 3	240 V — 100 A 600 V — 60 A 600 V — 100 A
LSBD602	Line Side Barriers for General Duty and Heavy Duty	2 or 3	600 V — 30 A
LSBE202	Line Side Barriers for General Duty and Heavy Duty	2	240 V — 200 A
LSBE203	Line Side Barriers for General Duty and Heavy Duty	3	240 V — 200 A
LSBE603	Line Side Barriers for General Duty and Heavy Duty	3	600 V — 200 A
LSBG202	Line Side Barriers for Heavy Duty	2	240 V — 400 A 240 V — 600 A
LSBG203	Line Side Barriers for Heavy Duty	3	240 V — 400 A 240 V — 600 A
LSBG602	Line Side Barriers for Heavy Duty	2 or 3	600 V — 400 A 600 V — 600 A
LSBI02	Line Side Barriers for General Duty	2 or 3	240 V — 400 A 240 V — 600 A 240 V — 800 A
LSBF202	Line Side Barriers for Heavy Duty	2	240 V — 800 A 240 V — 1200 A
LSBF203	Line Side Barriers for Heavy Duty	3	240 V — 800 A 240 V — 1200 A
LSBF602	Line Side Barriers for Heavy Duty	2 or 3	600 V — 800 A 600 V — 1200 A

### Internal Barrier Kits

Internal barrier kits provide an additional barrier that helps prevent accidental contact with live parts. Field-installed transparent barriers do not restrict visual inspection of the switch. Barrier provides IEC529 IP2X "finger safe" protection when door of enclosed disconnect switch is open. Designed with convenient door for accessing fuses for replacement without removing barrier, and allows use of test probes.

**Table 3.32: Internal Barrier Kits**

Cat. No.	Description	Blades / Fuses	Safety Switch Application
SS03 [70]	Barriers for Heavy Duty	2 or 3	240 / 600 V — 30 A 240 V — 60 A
SS06 [71]	Barriers for Heavy Duty	2 or 3	600 Vac — 60 A
SS10 [71]	Barriers for Heavy Duty	2 or 3	240 V — 100 A 600 V — 100 A
QTY (1)SS20 QTY (2) 4056677550	Barriers for Heavy Duty	2	240 V — 200 A
QTY (1)SS20 [71] QTY (3) 4056677550 [70]	Barriers for Heavy Duty	3	240 V — 200 A
SS20 [71]	Barriers for Heavy Duty	2 or 3	600 V — 200 A
SS4060LI	Barriers Line Side for Heavy Duty	2 or 3	240 V — 400 A 240 V — 600 A 600 V — 400 A 600 V — 600 A
SS4060LO [72]	Barriers Load Side for Heavy Duty	2 or 3	240 V — 400 A 240 V — 600 A 600 V — 400 A 600 V — 600 A
SS80120LI	Barriers Line Side for Heavy Duty	2 or 3	240 V — 800 A 240 V — 1200 A 600 V — 800 A 600 V — 1200 A
SS80120LO [72]	Barriers Load Side for Heavy Duty	2 or 3	240 V — 800 A 240 V — 1200 A 600 V — 800 A 600 V — 1200 A

### Fuse Puller Kits



Fuse Puller Kits

Fuse Puller Kits are standard equipment on the following 30 A - 100 A switches: NEMA Type 12 and 12K, NEMA Type 4/4X/5 stainless steel, NEMA Type 4X fiberglass reinforced polyester and Krydon™. Fuse Puller Kit available for field installation on NEMA Type 1 and NEMA Type 3R, 30 A – 100 A switches. One Fuse Puller Kit required for a 3 pole fusible 240 V or 600 V heavy duty switch. Fuse Puller Kits can be field installed on switches manufactured since February 1980.

Amperes	Series Number [73]	Fuse Puller Kit Cat. No.
30	F5-F7	FPK03 [74]
60	F5-F7 (600 V)	FPK0610
60	F5 (240 V)	FPK03
100	F5-F7	FPK0610

[70] Can only be applied to F series.

[71] Can only be applied to F series.

[72] Must buy line side also

[73] For series not shown in chart refer to the switch wiring diagram.

[74] 30 A 4 pole, H361-2 and H361-2RB Series F5, H361WA and H361WC Series F6 use FPK0610.

**Solid Neutral Assembly Kits**

**Table 3.33: Solid Neutral Assembly Kits** [75] [76] [77] [78]

Amperes	Series Number [79]	Standard Neutral Kit Cat. No.	Terminal Data AWG/kcmil	Optional Copper Only Neutral Kit Cat. No.	Terminal Data AWG/kcmil
30	F5-F6	SN03 [80]	(2) 14-3 Al/Cu plus (1) 14-3 Al/Cu Svc Ground	SN03C [80]	(2) 14-6 Cu plus (1) 14-6 Cu Svc Ground
60	F5-F6 (600 V)	SN0610	(2) 14-1/0 Al/Cu plus (2) 14-6 Al/Cu Svc Ground	SN0610C	(2) 14-1/0 Cu plus (2) 14-6 Cu Svc Ground
	F5-F6 (240 V)	SN03	(2) 14-3 Al/Cu plus (1) 14-3 Al/Cu Svc Ground	SN03C	(2) 14-1/0 Cu plus (2) 14-6 Cu Svc Ground
100	F5-F6,	SN0610	(2) 14-1/0 Al/Cu plus (2) 14-6 Al/Cu Svc Ground	SN0610C	(2) 14-1/0 Cu plus (2) 14-6 Cu Svc Ground
200 [81]	F5-F6	SN20A	(2) 6-250 Al/Cu plus (1) 14-10 Al/Cu Svc Ground	SN20C	(2) 6-250 Cu plus (1) 14-1/0 Cu Svc Ground
400 and 600	E4-E5	H600SN	(4) 1-750 Al/Cu plus (1) 4-300 Al/Cu Svc Ground	H600SNC	(2) 1-600 Cu and (2) 4-350 Cu plus (2) 6-250 Cu Svc Ground
800	E4	H800SNE4	(6) 3/0-750 Al/Cu plus (2) 6-350 Al/Cu Svc Ground	-	-
1200	E4	H1200SNE4	(8) 3/0-750 Al/Cu plus (2) 6-350 Al/Cu Svc Ground	-	-

**Equipment Grounding Kits**

Equipment grounding kits are available for field installation.

**Table 3.34: Equipment Grounding Kits and Terminal Data** [82] [83]

Amperes	Series Number	Standard Cat. No.	Terminal Data AWG/kcmil	Optional Copper Only Cat. No.	Terminal Data AWG/kcmil
30	F5-F6	GTK03 [84]	(2) 14-4 Cu or (2) 12-4 Al or (4) 14-12 Cu or (4) 12-10 Al	GTK03C [84] [85]	(2) 14-6 Cu
60	F5-F6 (600 V)	GTK0610	(2) 14-1/0 Cu or (2) 12-1/0 Al and (2) 14-6 Cu or (2) 12-6 Al	GTK0610C	(2) 14-1/0 Cu and (2) 14-6 Cu
60	F5-F6 (240 V)	GTK03	(2) 14-4 Cu or (2) 12-4 Al or (4) 14-12 Cu or (4) 12-10 Al	GTK03C	(2) 14-6 Cu
100	F5-F6	GTK0610	(2) 14-1/0 Cu or (2) 12-1/0 Al and (2) 14-6 Cu or (2) 12-6 Al	GTK0610C	(2) 14-1/0 Cu and (2) 14-6 Cu
200	F5-F6	PKOGTA2	(2) 10-2/0 Cu or (2) 6-2/0 Al	PKOGTC2	(2) 14-4 Cu
400 and 600	E4-E5	PKOGTA2 [86]	(2) 10-2/0 Cu or (2) 6-2/0 Al	PKOGTC3	(4) 14-1/0 Cu
800	E4	PKOGTA7	(4) 4-350 Al/Cu	-	-
1200	E4	PKOGTA8	(8) 4-350 Al/Cu	-	-

**Touch-Up Paint**

Description	Cat. No.
12 oz. Aerosol Paint Can, Square D ANSI-49 Gray Touch-Up Paint	PK49SP

**NOTE:** Standard package quantity is 6 cans.

**Lock OFF / Lock ON**

Lock off provisions are standard on all Heavy Duty Switches

Lock-on is also available as a factory modification on Type 12 and 304 Stainless Steel Type 4X enclosures. Obtain by selecting on product configurator.

**Lock Off Guard Kits**

For field installed kits, the lock off guard works by covering the lockout tagout openings whenever the switch is in the ON POSITION. This prevents a padlock from being inadvertently inserted into the switch lockplate. Available ONLY for use on Type 1, Type 3R, Type 12, Heavy Duty Safety Switches.



Optional Lock-OFF Guard Kit Installed

**Table 3.35: Lock-Off Guard Kits**

Switch Rating	Cat. No.
30 A	LOGK1
60 A 240 V	
60 A 600 V	
100 and 200 A	LOGK2

[75] For series not shown in chart refer to the switch wiring diagram.

[76] For solid Neutral Assembly Kits for Krydon™ enclosure see Table 3.20.

[77] For Solid Neutral Assembly Kits for Fiberglass Reinforced Ployester enclosures see Table 3.19.

[78] Neutrals cannot be installed in 4 or 6 pole switches or receptacle switches.

[79] See page 3-22 and page 3-23 for safety switch series.

[80] The following 30 A Series F5-F6 switches use SN0610 or SN0610C: H3612, H3612RB, H3612A, H3612AWK, HU3612, HU3612RB, HU3612A and HU3612AWK.

[81] For 200% neutral, order (2) SN20A Neutral Kits and (1) SN20NI Neutral Jumper Kit.

[82] For series not shown in table refer to the switch wiring diagram.

[83] Equipment Ground Kits (Al/Cu) are factory installed standard in 30-200 A Series F NEMA Type 4/4X/5 (stainless steel), 12 and 12K. Equipment Ground Kits are standard factory installed on all receptacle switches and all Series F 30-200 A, 4 and 6 pole switches.

[84] H2212AWK accepts GTK03 or GTK03C. H3612A or AWK accepts GTK03C. H3612 and H3612RB accepts GTK0610 HU3612AWK accepts GTK03C. HU3612A accepts GTK0610C. HU3612RB accepts GTK0610 or GTK0610C.

[85] Optional copper equipment grounding kit for the 4 and 6 pole 30 A F Series: H461DS, H461AWK, HU461DS, HU661DS and HU661AWK accepts GTK03C HU461AWK accepts GTK0610C.

[86] Two required if equipment grounding conductors are run in parallel.

### Key Interlock Systems



Key Interlock System

**Key Interlock Systems**

Factory installed only on heavy duty safety switches and double throw safety switches, from 30 amp to 1200 amp, Type 12 and 304 stainless steel Type 4X. The key interlock system is a simple and easy method of applying individual key interlock units and assemblies to the above equipment so as to require operation in a predetermined sequence. UL Listed.

**Quoting:** Contact Schneider Electric for catalog number, availability, and pricing prior to quoting a job. Detailed information is required before an order can be processed. Please see Supplemental Digest Section 2 for further information.

**Use these suffixes on switch catalog numbers:**

- KI = 1 lock per switch
- KI2 = 1 lock with 2 cylinders (2 keys) per switch
- KIKI = 2 separate locks per switch

### Cover Viewing Window

Optional cover viewing window is positioned over the blades to allow visual verification of "ON-OFF" status. Available on 30 through 1200 A heavy duty switches, NEMA Type 1, 3R, 4/4X/5 Stainless Steel, 12 and 12K. (Not available on NEMA Type 4X, Fiberglass, Krydon or NEMA Type 7 and 9 switches). Add VW suffix to the catalog number for factory installation.

### Voltage Monitors



Voltage monitors installed on safety switches indicate when voltage is present, helping to prevent arc-flash hazards and electric shocks during maintenance work. Voltage monitors can be combined with other safety features such as Key Interlock, Viewing Windows or Lock-ON provisions.

- UL Listed
- Factory installed only
- Order the voltage monitors by adding the appropriate suffix shown in the table below to the switch catalog number
- Not available on NEMA Type 7 and 9 and NEMA Type 4X Fiberglass and Krydon™ switches

**Table 3.36: Voltage Monitors** [87] [88] [89]

Description	Suffix [90]
Line Side Monitor	SI
Load Side Monitor	LI
Line and Load Side Monitors	LI2

### Copper Lug Kits

Lug kits that accept only copper wire are available for field or factory installation:

- UL Listed
- UL Marine Listed
  - UL Marine listing is applicable ONLY to 30 - 200 A, NEMA Type 12/3R, NEMA Type 12K and NEMA Type 4/4X/5 stainless steel, safety switches
  - When copper only lugs kits are factory installed the switch will bear the UL Marine mark and be suitable for use on vessels over 65 feet long
  - When the copper only lugs kits are field installed the switch will not bear the UL Marine mark and would not be suitable for use on vessels over 65 feet long
- Not available for use on NEMA Type 4X Fiberglass, Krydon or NEMA Type 7 and 9 switches
- For field installation, order copper lug kits. See Table below
- For factory installation of copper lugs, add the suffix SLC to the standard catalog number

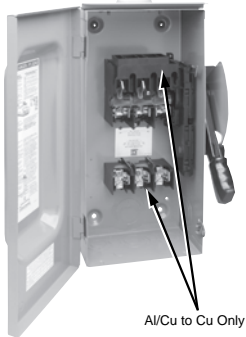

**Table 3.37: Copper Lug Kits** [91]

Amperes	Lug Kit Cat. No.	Lug Wire Range AWG/kcmil
30–60	CL0306F	(1) 14-8 Cu solid or 14-4 Cu stranded
100	CL10F	(1) 14-8 Cu solid or 14-1/0 Cu stranded
200	CL20F	(1) 6-250 Cu
400	CL40F	(1) 1-600 Cu plus (1) 6-250 Cu
600	CL60F	(1) 4-350 Cu
800	—	—
1200	—	—

[87] Available on 30–1200 A Heavy Duty Safety Switches.

[88] Order 600 Vac Heavy Duty Safety Switch for all 30–60 A 240 Vac applications.

[89] Available on 30–200 A Double Throw Safety Switches. Two and three-pole, 200 A Type 3R switches are not available with these voltage monitors.

[90] In addition to the suffix shown in the table above, a 3 must be added to the switch catalog number for all 30 and 60 A switches, i.e. H361AWK becomes H3613AWKLI. 30 and 60 A switches require 100 A enclosure accessories. Double Throw Safety Switches are exempt from this requirement.

[91] One kit includes all phase line/load lugs for a 3-pole switch. CL0306F, CL10F and CL20F includes six lugs. CL40F and CL60F includes twelve lugs.

**Double Lug Kits**

200 A heavy duty F-series switches are supplied standard with lugs suitable for one wire per phase. For two wires per phase and neutral, order the Double Lug Kit. Not UL Listed. Not listed on switch's wiring diagram as an accessory.

**Table 3.38: Double Lug Kits**

Amperes	Cat. No. [92]	Lug Wire Range per Phase and Neutral AWG/kcmil	Wire Range Wire Bending Space per NEC Table 312.6 AWG/kcmil
200	AL20DTF	(2) 6–300 Cu/Al	(2) 6–250 Cu/Al

**Compression Lug Kits — 800 A and 1200 A Safety Switches**

- UL Listed.
- Compression Lug Kits available for field installation
- Compression Lug Kits available for factory installation; Add suffix LK to standard catalog number
- Compression Lug Kits contain VCEL07512H1 Versa-Crimp™ compression lugs
- Order one Compression Lug Kit per switching pole and/or neutral (see Table below)

**Table 3.39: Compression Lug Kits**

Amperes	Lug Kit Cat. No.	Conductors per Phase	Lug Wire Range kcmil
800	H8LKE2	(3) Line and (3) Load	500-750 kcmil (Al) or 500 kcmil (Cu)
1200	H12LKE2	(4) Line and (4) Load	500-750 kcmil (Al) or 500 kcmil (Cu)

**Table 3.40: Terminal Lug Data [93]**

Rating (A)	Wires Per Phase and Neutral	Wire Range Wire Bending Space per NEC Table 312.6 AWG/kcmil	Lug Wire Range AWG/kcmil	Optional [94] Compression Lug Field-Installed	Optional Copper Only [94] Compression Lug Field-Installed [95]
30	1	12–6 (Al) or 14–6 (Cu)	12–2 (Al) or 14–2 (Cu)	C10–14, [96] D8–14–SK, or E6–14	—
	2	12–10 (Al) or 14–10 (Cu)			
60 [97]	1	12–3 (Al) or 14–3 (Cu)	12–2 (Al) or 14–2 (Cu)	C10–14, [96] D8–14–SK, or E6–14	—
100 [98]	1	12–1/0 (Al) or 14–1/0 (Cu)	12–1/0 (Al) or 14–1/0 (Cu)	VCEL02114S1	VCELC02114S1
200 [99]	1	6–250 (Al/Cu)	6–300 (Al/Cu)	VCEL030516H1	VCELC030516H1
400 [100]	1	1/0–750 (Al/Cu) or 1/0–300 (Al/Cu)	1/0–750 (Al/Cu) or 1/0–300 (Al/Cu)	VCEL07512H1 or VCEL030516H1 [101] and VCEL05012H1	VCEL07512H1 or VCELC030516H1 [102] and VCELC05012H1
	2				
600	2	3/0–500 (Al/Cu)	3/0–500 (Al/Cu)	VCEL05012H1	VCELC05012H1
800	3	3/0–750 (Al/Cu)	3/0–750 (Al/Cu)	H8LKE2 [103]	—
1200	4	3/0–750 (Al/Cu)	3/0–750 (Al/Cu)	H12LKE2 [103]	—

**Table 3.41: Conduit Provisions**

Amperes	Top and Bottom Endwall	
	NEMA Type 4X Fiberglass Reinforced Polyester and Krydon [104]	NEMA Type 7 and 9 [105]
30	3/4 in.	—
60	1-1/4 in.	3/4 in.
100	2 in.	1-1/4 in.
200	2-1/2 in.	2-1/2 in.

[92] Kit contains 3 lugs. Order two kits for line and load lugs.  
 [93] 30–100 A switches suitable for 60°C or 75°C conductors. 200–1200 A switches suitable for 75°C conductors.  
 [94] Hubbell Versa-Crimp™ unless otherwise noted.  
 [95] For NEMA Type 1, 12/3R, 12K and 4/4X/5 stainless steel switches only.  
 [96] Order from Thomas and Betts.  
 [97] H60XFA and H60XFA1212 — use 75°C copper wire only. #6 AWG copper wire required for 60 A rating.  
 [98] H100XFA and H100XFA1212 — use 75°C copper wire only. #3 AWG copper wire required for 100 A rating.  
 [99] H225XJG and H225XJGAA — use 75°C copper wire only. Lug wire range is #3 AWG – 350 kcmil. Not UL Listed due to inadequate wire bending space (5" on ON end, 6" on OFF end).  
 [100] Maximum wire bending space allows for (1) 600 kcmil or (2) 300 kcmil Al/Cu on NEMA Type 4/4X/5 stainless steel and NEMA Type 12 switches.  
 [101] Order two PK516KN mounting kits when installing VCEL030516H1 lugs. Only one kit is required on 2 pole switches. PK516KN consists of (4) 5/16-18 Keps Nuts.  
 [102] Order two PK516KN mounting kits when installing VCEL030516H1 or VCELC030516H1 lugs. Only one kit is required on 2 pole switches. PK516KN consists of (4) 5/16-18 Keps Nuts.  
 [103] For 800 and 1200 A compression lug kits see Table 3.39 for additional information.  
 [104] Hubs and hub drilling templates are provided for field-installation.  
 [105] Threaded conduit opening.







Table 3.43 Approximate Dimensions (cont'd.)

Cat. No.	Series	H		W		D		W/H		Cat. No.	Series	H		W		D		W/H	
		in.	mm	in.	mm	in.	mm	in.	mm			in.	mm	in.	mm	in.	mm	in.	mm
H363AWC	F7	20.50	521	9.00	229	7.00	178	10.50	267	HU464DS	F6	29.00	737	23.75	603	8.88	226	25.25	641
H363A	F6	20.50	521	9.00	229	7.00	178	10.50	267	HU465AWK	E5	46.25	1175	32.50	826	10.13	259	32.50	826
H363AWK	F6	20.50	521	9.00	229	7.00	178	10.50	267	HU661AWK	F6	20.50	521	14.75	375	6.80	173	16.13	410
H363DS	F6	20.82	529	9.36	238	6.97	177	11.25	286	HU661DS	F6	20.82	529	15.08	383	6.97	177	16.85	428
H363DSWA	F7	20.82	529	9.36	238	6.97	177	11.25	286	HU662AWK	F6	20.50	521	14.75	375	6.80	173	16.13	410
H363DSWC	F7	20.82	529	9.36	238	6.97	177	11.25	286	HU662DS	F6	20.82	529	15.08	383	6.97	177	16.85	428
H363DF	F1	24.80	630	13.70	348	12.00	305	13.70	348	HU663AWK	F6	20.50	521	14.75	375	6.80	173	16.13	410
H363DX	F1	25.25	641	11.40	290	8.60	218	11.40	290	HU663DS	F6	20.82	529	15.08	383	6.97	177	16.85	428
, H365SS	E5	46.25	1175	26.25	667	10.13	259	26.25	667	HU664AWK	F6	29.00	737	23.25	591	8.75	222	24.88	632
										HU664DS	F6	29.00	737	23.75	603	8.88	226	25.25	641



30–100 A DT, DTU (Series F)  
NEMA Type 1

**30–100 A Types DT, DTU (Series F)**

- Fusible (DT) and non-fusible (DTU) switches available
- Manually-operated switch suitable for use in accordance with article 702 of the NEC, ANSI/NFPA 70
- Standards: UL 98, Type KS1, CSA, and NOM
- Modular design—switch handle, lock-plate, switch mechanism; line and load bases are field replaceable
- UL Listed short circuit current ratings up to 200 kA (using with (fusible) or protected by (non-fusible) Class R, J, or T fuses—see table for rating)
- Load make/break rated
- Horsepower rated
- Dual cover interlock
- May be padlocked ON (I) or OFF (O)
- Lock-off accepts up to three padlocks
- Side-opening door
- Quick make / quick break mechanism
- Meets NEMA requirements as heavy duty switch
- Field-installed electrical interlock kits
- Field-installed neutral assembly kits (2P and 3P switches)
- UL Listed as suitable for use as service equipment
- Supplied as standard for switching one load between two power sources, and may be field-converted to switch one power source between two loads.



82,000 Line  
NEMA Type 1

**30 (Series T4), 200–600 A Types 82,000 and 200 A DTU (Series E, A)**

- Non-fusible
- Designed for manual transfer of one load between two power sources
- UL Listed switches are suitable for use in accordance with Article 702 of the National Electrical Code, ANSI / NFPA 70
- All 82,000 and DTU double throw switches are continuous duty rated for their nameplate ampere rating
- The 82,000 and DTU (Series E, A) switches are load make/break rated
- UL Listed as suitable for use as service equipment
- Horsepower rated only as footnoted

**Field-Installable Accessories**

- Neutral
- Electrical Interlock
- Grounding Terminals

Double-Throw Safety Switches

Table 3.44: 240 V Double Throw Safety Switches

System	Amperes	Current Series	NEMA Type 1	NEMA Type 3R	NEMA Type 4,4X,5 304 Stainless Steel	NEMA Type 12 Gasketed	Horsepower Ratings [1][2]				250 Vdc[3]
			Cat. No.	Cat. No.	Cat. No.	Cat. No.	240 Vac		1Ø	3Ø	
							Std.	Max.			
Fusible—2P, 240 Vac—250 Vdc											
	100	F	DT223	DT223RB	—	—	7.5	15 [4]	15	30 [4]	20
	Fusible—3P, 240 Vac—250 Vdc										
	30	F	DT321	DT321RB	—	—	1.5 [5]	3 [4]	3 [5]	7.5 [4]	5
	60	F	DT322	DT322RB	—	—	3 [5]	7.5 [4]	10 [5]	15 [4]	10
	100	F	DT323	DT323RB	—	—	7.5 [5]	15 [4]	15 [5]	30 [4]	20
Non-Fusible—2P, 240 Vac—250 Vdc											
	60	F	DTU222	—	—	—	—	—	10	—	10 [6]
	100	F	DTU223	DTU223RB	—	—	—	—	15	—	20 [6]
	30	T4	92251 [7]	—	—	—	—	—	—	—	—
	200	E	82254	DTU224NRB [7][8]	—	H82254	15	—	—	—	—
	400	A	DTU225	DTU225R	—	—	—	—	—	—	50
Non-Fusible—3P, 240 Vac—250 Vdc											
	30	F	DTU321	—	—	—	—	3 [4]	5 [5]	10 [4]	5 [6]
	60	F	DTU322	—	—	—	—	—	10 [5]	15 [4]	10 [6]
	100	F	DTU323	DTU323RB	—	—	—	—	15 [5]	30 [4]	20 [6]
	30	T4	92351 [7]	—	—	—	—	—	—	—	—
	200	E	82354 [7]	—	—	H82354 [7]	15	—	—	—	—
	200	E	DTU324N [7][8]	DTU324NRB [7][8]	—	—	15	—	—	—	—
	400	A	DTU325	DTU325R	—	—	125	—	—	—	50
	600	A	DTU326	DTU326R	—	—	125	—	—	—	50
Non-Fusible—4P, 240 Vac											
	30	T4	92451 [7]	—	—	—	—	—	—	—	—
	200	E	82454 [9]	82454R [9]	—	H82454 [10]	15	10 [10]	—	—	—
	600	A	DTU426	DTU426R	—	—	125	—	—	—	50

600 V Double Throw: page 3-27  
 Accessories: page 3-28  
 Application Data: Application Data, page 3-30  
 Dimensions, 30–100 A (Series F): page 3-32  
 Dimensions, 30, 200–600 A (Series E, T4, A): page 3-32

[1] The starting current of motors or more than standard horsepower may require the use of fuses with appropriate time delay characteristics.  
 [2] Std.—Using fast acting one time fuses. Max.—Using dual element time delay fuses.  
 [3] For switching dc, use two switching poles.  
 [4] If used on corner grounded delta systems, install neutral and use outer switching pole for ungrounded conductors. See data bulletin 2700DB0202 for additional information.  
 [5] Use outer switching poles.  
 [6] Maximum rating.  
 [7] 240 Vac only. Not Vdc rated.  
 [8] Neutral included with device.  
 [9] 240 Vac, 250 Vdc.  
 [10] Hp rating applies only to H82454.

**Double Throw Safety Switches**

**Table 3.45: 600 V Double Throw Safety Switches**

System	Amperes	Current Series	NEMA Type 1	NEMA Type 3R	NEMA Type 4,4X,5 304 Stainless Steel	NEMA Type 12 Gasketed	Horsepower Ratings [11][12]							
							240 Vac		480 Vac		600 Vac		Vdc [13]	
							Std	Max	Std	Max	Std	Max	250	600
Cat. No.							3Ø	3Ø	3Ø [14]	3Ø [14]	3Ø	3Ø		
<b>Fusible 3P, 600 Vac—600 Vdc</b>														
	30	F	DT361	DT361RB	—	—	—	—	5 [15]	15 [15]	7.5	20	5	15 [16]
	60	F	DT362	DT362RB	—	—	—	—	15 [17]	30 [17]	15	50	—	30 [18]
	100	F	DT363	DT363RB	—	—	—	—	25 [19]	60 [19]	30	75	—	50 [20]
<b>Non-Fusible 3P, 600 Vac—600 Vdc</b>							1Ø [13]	3Ø [14]	1Ø [13]	3Ø [14]	1Ø [13]	3Ø [21]		
	30	F	DTU361	DTU361RB	—	—	5	10	7.5	20	10	30	5	15
	60	F	DTU362	DTU362RB	DTU362DS	DTU362AWK [22]	10	20 [23]	25	50 [24]	30	60 [25]	10	30
	100	F	DTU363	DTU363RB	DTU363DS	DTU363AWK [22]	20	40 [26]	40	75 [26]	40	100 [26]	20	50
	200	E	82344 [27]	82344RB [27]	82344DS [27]	H82344 [27]	—	—	—	15 [29]	—	—	—	—
	400	A	DTU365	DTU365R	DTU365DS	DTU365AWK	—	125	—	250	—	350	50	—
	600	A	DTU366 [30]	DTU366R [30]	—	DTU366AWK [30]	—	125	—	250	—	350	50	—
<b>Non-Fusible 4P, 600 Vac—600 Vdc</b>							2Ø	3Ø	2Ø	3Ø	2Ø	3Ø		
	60	F	DTU462 [31]	Use NEMA Type 12	DTU462DS [31]	DTU462AWK [22] [31]	20	20	40	50	50	60	10	30
	100	F	DTU463 [31]		DTU463DS [31]	DTU463AWK [22] [31]	30	40	50	75	50	100	20	50
	200	E	82444 [30]	82444R [30]	82444DS [30]	H82444 [22] [31] [32] [30]	—	—	—	—	—	—	—	—
	400	A	DTU465 [30]	DTU465R [30]	—	—	—	125	—	250	—	350	50	—
	600	A	DTU466 [30]	DTU466R [30]	—	—	—	125	—	250	—	350	50	—
<b>Non-Fusible 6P, 600 Vac—600 Vdc</b>							1Ø	3Ø	1Ø	3Ø	1Ø	3Ø		
	60	F	—	—	—	DTU662AWK [22] [31]	—	20	—	50	—	60	10	30
	100	F	—	—	—	DTU663AWK [22] [31]	—	40	—	75	—	100	20	50

SAFETY SWITCHES

3

240 V Double Throw: page 3-26  
 Accessories: page 3-28  
 Application Data: page 3-30  
 Dimensions, 30–100 A (Series F): page 3-32  
 Dimensions, 30, 200–600 A (Series E, T4, A): page 3-32

[11] The starting current of motors of more than standard horsepower may require the use of fuses with appropriate time delay characteristics.  
 [12] Std.—Using fast acting one time fuses. Max.—Using dual element time delay fuses. (Non-fusible switches have max rating unless noted.)  
 [13] Use outer switching poles.  
 [14] If used on corner grounded delta systems, install neutral and use outer switching pole for ungrounded conductors. See data bulletin 2700DB0202 for additional information.  
 [15] 480 Vac 1 Phase HP = 3 Std, 7.5 Max  
 [16] 10 Std, 15 Max  
 [17] 480 Vac 1 Phase HP = 5 Std, 20 Max  
 [18] 25 Std, 30 Max  
 [19] 480 Vac 1 Phase HP = 10 Std, 30 Max  
 [20] 40 Std, 50 Max  
 [21] Maximum HP  
 [22] Complete rating on switch is NEMA Type 3R, 5 or 12. For 3R applications, remove drain screw from bottom endwall.  
 [23] Maximum HP is 15 for corner grounded delta systems.  
 [24] Maximum HP is 30 for corner grounded delta systems.  
 [25] Use 75°C #4 Cu or #2 Al conductors only on DTU362 and DTU362RB.  
 [26] Use 75°C #1 Cu conductors only.  
 [27] 480 Vac, 250 Vdc maximum  
 [28] Not UL Listed.  
 [29] Standard Hp rating.  
 [30] 250 Vdc maximum.  
 [31] Not suitable for use as service equipment.  
 [32] 480 Vac, 250 Vdc maximum.

**Accessories**

**Table 3.46: Electrical Interlocks (For Electrical Interlock Contact Ratings, see Supplemental Digest Section 2)**

Switch	Field-Installed Electrical Interlock Kit Cat. No. [33]
30–100 A Type DT, DTU (Series F)	EIK1, EIK2 [34][35]
200 A Type 82000 and DTU (Series E) [36]	[37]
400–600 A Type DTU (Series A)	DS200EK2D

**Table 3.47: Neutral Assembly**

Switch	Field-Installed Standard Neutral Kit Cat. No.	Terminal Data AWG/kcmil	Field-Installed Copper only Neutral Kit Cat. No.	Terminal Data AWG/kcmil
30–100 A Type DT, DTU (Series F) (2- and 3-pole switches only)	SN0310	(3) 14-1/0 Al/Cu plus (2) 14-6 Al/Cu Svc Ground	SN0310C	(3) 14-1/0 Cu plus (2) 14-6 Cu Svc Ground
30 A (Series T4) (2- and 3-pole switches only)	DT30SN	(3) 14-4 Al/Cu plus (2) 14-4 Al/Cu Svc Ground	—	—
200 A Type 82000 (Series E) (2- and 3-pole switches only) [38]	[39]	(3) 6-300 Al/Cu plus (1) 6-2/0 Al or 10-2/0 Cu Svc Ground	—	—
200 A Type DTU (Series E)	Factory Installed	(3) 4-300 Al/Cu plus (1) 4-300 Al/Cu Svc Ground	—	—
400 A Type DTU (Series A)	DT400NKD	(1) 1/0-720 Al/Cu or (2) 1/0-300 Al/Cu plus (2) 6-250 Al/Cu Svc Ground	—	—
600 A Type DTU (Series A)	DT600NKD	(6) 250-500 Al/Cu plus (1) 6-250 Al/Cu Svc Ground	—	—

**Table 3.48: Service Grounding Kit—Required for service equipment use**

Switch	Field-Installed Service Grounding Lug Kit Cat. No.	Terminal Data AWG/kcmil
30–60 A Type DT, DTU (Series F)	Included	(3) 14-2 Al/Cu or (6) 14-10 Al/Cu
100 A Type DT, DTU (Series F)	Included	(3) 14 - 1/0 Al/Cu
30 A Type 92,000 (Series T4)	DT30SG	(4) 14-4 Al/Cu
200 A Type 82000 and DTU (Series E)	DT100SG	(3) 14–1/0 Al/Cu
400–600 A Type DTU (Series A)	DS468GKD	(2) 6–250 Al/Cu [40]

**Table 3.49: Class R Fuse Kits**

When properly installed, this kit rejects all but Class R fuses. Kits are available for field installation. For factory installation add suffix CLR to the switch catalog number.		
Switch	Series Number	Class R Fuse Kit Cat. No.
Class R Fuse Kits—240 V (two kits per 3P switch)		
30 A	F5	RFK03
60 A	F5	RFK06
100 A	F5	RFK10
Class R Fuse Kits—600 V (two kits per 3P switch)		
30 A	F5	RFK06
60 A	F5	RFK06H
100 A	F5	RFK10

**Viewing Windows:** Accessory available on 30–100 A DT and DTU Series F switches only. Add the suffix VW to the catalog number.

**Key Interlock Systems:** For factory-installed key interlocks, refer to page 3-20.

**Lock-ON Provisions:** Standard feature on 30–100 A type DT and DTU (Series F), and type 92,000 switches.

Feature available as factory installed option for Type 82,000 (200 A only) and 200 A DTU (Series E) switches. Add the suffix SPLO to the catalog number.

[33] Electrical interlock kit catalog numbers with “1” suffix indicate one normally open and normally closed contact; “2” indicates two normally open and two normally closed contacts. See [Electrical Interlock Kit](#), page for electrical interlock ratings.

[34] 30–100 and 600 A Type DT, DTU (Series F) switches contain (2) separate switching mechanisms. Each mechanism will accept an electrical interlock. Some applications may therefore require (2) electrical interlocks.

[35] Double throw switches 92251, 92351, and 92451 are not available with factory or field installed electrical interlocks.

[36] Electrical interlock EK400DTU2 can be added to 200 A, 4-pole Type 82000 switches in the field.

[37] Type 82000 and DTU switches are available with electrical interlock factory-installed only. Not UL listed. Electrical interlocks are furnished with 2 N.O./N.C. contacts and are installed in both “ON” positions. To order, add suffix EI to standard switch catalog number.

[38] Neutral assembly catalog number DT200N can be added to 4P, 200 A, Type 82000 switches in the field.

[39] For 200 A Type 82000, a neutral assembly is available factory installed on 2P and 3P switches. Not UL Listed. To order, add suffix N to the standard catalog number. Neutral terminal lug data = (3) #4 - 250 kcmil Al/Cu wire and (1) #4 - 250 kcmil Al/Cu service ground.

[40] (3) 6-250 ground lugs are provided as standard. DS468GKD provides an additional (2) 6-250 ground lugs.



- UL Listed for indoor or rainproof applications
- Suitable for use with conduit having ANSI standard taper pipe thread
- NEMA Type 3R switches with catalog number ending in RB have a bolt-on closing cap factory installed
  - Accepts 3/4 in. through 2-1/2 in. bolt-on hubs
  - No gaskets required
- NEMA Type 3R switches with R suffix have blank top endwalls
  - Accepts 3 in. through 4 in. bolt on hubs
  - Gaskets provided
  - Conduit entry holes must be cut in the field

**Rainproof Bolt-On Hubs**

Conduit Size	3/4	1	1-1/4	1-1/2	2	2-1/2	3	3-1/2	4	Closing Cap
Hub Cat. No	B075	B100	B125	B150	B200	B250	B300	B350	B400	BCAP

**Watertight Hubs**



Watertight Hubs

- UL Listed for dusttight and watertight applications
- Suitable for use with conduit having ANSI standard taper pipe thread
- Watertight hubs are field installed on NEMA Type 4/4X/5 stainless steel and NEMA Type 12/3R and 12K enclosures
- Watertight hubs are available in zinc or chrome plated finish
- Gaskets provided

**Table 3.50: Watertight Hubs [41]**

Conduit Size	1/2	3/4	1	1-1/4	1-1/2	2	2-1/2	3	3-1/2	4
Standard-Zinc Hub Cat. No	H050	H075	H100	H125	H150	H200	H250	H300	H350	H400
Chrome Plated Hub Cat. No.	H050CP	H075CP	H100CP	H125CP	H150CP	H200CP	—	—	—	—

240 V Double Throw: page 3-26

600 V Double Throw: page 3-27

Application Data: page 3-30

Dimensions, 30–100 A (Series F): page 3-32

Dimensions, 30, 200–600 A (Series E, T4, A): page 3-32

[41] Gaskets are provided.

Application Data for Double Throw Safety Switches

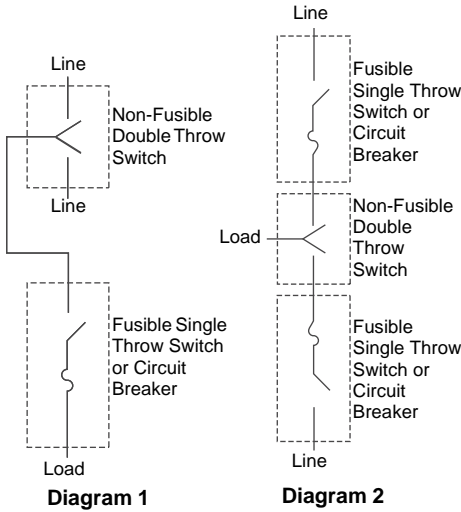

**Situations Requiring Fuses**

30–100 A Type DT (Series F):  
Select DT switches from 240 Volt Double-Throw Safety Switches, page 3-26 and 600 Volt Double Throw Safety Switches, page 3-27 which have provisions for accepting fuses.

30 A, 200–600 A Type 82,000 (Series E, T4, A), all DTU devices:  
Use the non-fusible double throw switches from 240 Volt Double-Throw Safety Switches, page 3-26 and 600 Volt Double Throw Safety Switches, page 3-27 in conjunction with standard fusible devices, and install them according to diagram 1 or 2, below.

**Table 3.51: UL Listed Short Circuit Current Ratings**

Switch Type	Amperes	Voltage Rating	UL Listed Fuse Class	Short Circuit Current Rating [42] (A)
Type 92000	30 A	240 V	H, K	10,000 [43]
Type DT (Series F)	30–100 A	240 V or 600 V	H, K	10,000
			R, J	200,000
Type DTU [44] (Series F)	30–100 A	240 V or 600 V	H or K	10,000 [43]
			R, J or T	200,000
DTU224NRB and DTU324NRB (Series E)	200 A	240 V	H, K	10,000 [43]
DTU324N (Series E)	200 A	240 V	H, K	10,000 [43]
			R, J	100,000
Type 82,000	All	240 V or 600 V	H, J	10,000 [43]
Type DTU (Series A)	400–600 A	240 V or 600 V	H, K	10,000
			R, J, T	100,000

[42] Rating applies to AC only. The UL Listed short circuit current rating for non-fusible switches is based on the switch being used in conjunction with the corresponding fuse type. Evaluation of non-fusible switches in conjunction with molded case circuit breakers has not been performed.

[43] Any brand of circuit breaker or fuse not exceeding the ampere rating of the switch may be used ahead of a non-fusible safety switch when there is up to 10 kA short circuit current available.

[44] The DTU361 and DTU361RB are also suitable for use on a circuit capable of delivering not more than (A) 18 kA, 600 Vac maximum when protected by Type FH circuit breaker rated 30 A maximum or (B) 14 kA, 600 Vac maximum when protected by Type FA circuit breaker rated 30 A maximum.

**Terminal Lug Data**
**Table 3.52: Terminal Lug Data for Type DT, DTU (Series F) Double Throw Safety Switches [45]**

Switch Type	Wires per Phase	NEMA Type 1, 3R, 4, 4X, 12			Optional Copper Only Lug
		Wire Range Wire Bending Space Per NEC Table 373-6 AWG/kcmil	Standard Lug Wire Range AWG/kcmil	Optional Compression Lug Field-Installed	
30–60 A Type DT, DTU (Series F)	1	12–2 Al or 14–2 Cu	12–2 Al or 14–2 Cu	C10-14, D8-14-SK, or E6-14 [46]	See Table 3.37 Copper Lug Kits, page 3-20 and Double Lug Kits, page 3-21 for appropriate kit. Order two kits per switch.
100 A Type DT, DTU (Series F)	1	12–1/0 Al or 14–1/0 Cu	12–1/0 Al or 14–1/0 Cu	VCEL02114S1 [47]	

**Table 3.53: Terminal Lug Data for Types 82,000 and for A and E-Series DTU devices [45]**

Amperes	Wires per Phase	Wire Range Wire Bending Space Per NEC Table 373-6 AWG/kcmil	Lug Wire Range AWG/kcmil	Optional Compression Lugs Field-Installed
30 A (Series T4)	1	14–8 Al/Cu	12–2 Al or 14–2 Cu	—
200	1	6–300 Al/Cu	6–300 Al/Cu	VCEL030516H1 [47]
400	1 or 2	1/0–600 Al/Cu or 1/0–300 Al/Cu	1/0 - 750 Al/Cu or 1/0 - 300 Al/Cu	—
600	2	250–500 Al/Cu	250–500 Al/Cu	—

240 V Double Throw: page 3-26

600 V Double Throw: page 3-27

Accessories: page 3-28

Dimensions, 30–100 A (Series F): page 3-32

Dimensions, 30, 200–600 A (Series E, T4, A): page 3-32

[45] 30-100 A switches suitable for 60° C or 75° C conductors. 200-600 A switches suitable for 75° C conductors.

[46] Order from Thomas and Betts

[47] Hubbell Versa-Crimp™ catalog numbers.



**Series F Devices 30–100 A**

**Table 3.54: 30–100 A Type DT, DTU (Series F)—Approximate Dimensions**

Cat. No.	Series	H		W		W/H		D	
		in.	mm	in.	mm	in.	mm	in.	mm
DT223	F5	38.00	965	9.88	251	11.13	283	6.75	171
DT223RB	F5	38.00	965	6.87	174	8.12	206	6.60	168
DT321	F5	38.00	965	10.25	260	11.50	292	6.75	171
DT321RB	F5	38.00	965	10.25	260	11.80	300	6.60	168
DT322	F5	38.00	965	10.25	260	11.50	292	6.75	171
DT322RB	F5	38.00	965	10.25	260	11.80	300	6.60	168
DT323	F5	38.00	965	9.88	251	11.13	283	6.75	171
DT323RB	F5	38.00	965	6.87	174	8.12	206	6.60	168
DT361	F5	38.00	965	10.25	260	11.50	292	6.75	171
DT361RB	F5	38.00	965	10.25	260	11.80	300	6.60	168
DT362	F5	38.00	965	10.25	260	11.50	292	6.75	171
DT362RB	F5	38.00	965	10.25	260	11.80	300	6.60	168
DT363	F5	38.00	965	9.88	251	11.13	283	6.75	171
DT363RB	F5	38.00	965	6.87	174	8.12	206	6.60	168
DTU222	F5	29.94	760	10.25	260	11.96	304	6.93	176
DTU223	F5	29.94	760	10.25	260	11.96	304	6.93	176
DTU223RB	F5	30.50	775	10.25	260	11.96	304	6.93	176
DTU321	F5	29.94	760	10.25	260	11.96	304	6.93	176
DTU322	F5	29.94	760	10.25	260	11.96	304	6.93	176
DTU323	F5	29.94	760	10.25	260	11.96	304	6.93	176
DTU323RB	F5	30.50	775	10.25	260	11.96	304	6.93	176
DTU361	F5	29.94	760	10.25	260	11.96	304	6.93	176
DTU361RB	F5	30.50	775	10.25	260	11.96	304	6.93	176
DTU362	F5	29.94	760	10.25	260	11.96	304	6.93	176
DTU362AWK	F6	29.94	760	10.25	260	11.96	304	6.93	176
DTU362DS	F6	30.26	769	10.25	260	11.50	292	7.12	181
DTU362RB	F5	30.50	775	10.25	260	11.96	304	6.93	176
DTU363	F5	29.94	760	10.25	260	11.96	304	6.93	176
DTU363AWK	F6	29.94	760	10.25	260	11.96	304	6.93	176
DTU363DS	F6	30.26	769	10.25	260	11.50	292	7.12	181
DTU363RB	F5	30.50	775	10.25	260	11.96	304	6.93	176
DTU462	F5	29.94	760	10.25	260	11.96	304	6.93	176
DTU462AWK	F6	30.26	769	15.50	394	16.75	425	7.12	181
DTU462DS	F6	30.26	769	15.50	394	16.75	425	7.12	181
DTU463	F5	29.94	760	10.25	260	11.96	304	6.93	176
DTU463AWK	F6	30.26	769	15.50	394	16.75	425	7.12	181
DTU463DS	F6	30.26	769	15.50	394	16.75	425	7.12	181
DTU463AWK	F6	30.26	769	15.50	394	16.75	425	7.12	181
DTU662AWK	F6	30.26	769	15.50	394	16.75	425	7.12	181
DTU663AWK	F6	30.26	769	15.50	394	16.75	425	7.12	181

240 V Double Throw: page 3-26  
600 V Double Throw: page 3-27

Accessories: page 3-28  
Application Data: page 3-30

Dimensions, 30, 200–600 A (Series E, T4, A): page 3-32

**Series A, E, and T4 Devices**

**Table 3.55: 200–600 A Types 82,000 and E-Series DTU and 30 A devices—Approximate Dimensions**

Cat. No.	Series	H		W		W/H		D	
		in.	mm	in.	mm	in.	mm	in.	mm
DTU224NRB	E1	32.50	826	20.63	524	24.00	610	10.63	270
82254	E1	30.88	784	15.75	400	19.63	499	9.75	248
82254NW	E1	30.88	784	20.00	508	23.88	607	11.75	298
82344	E2	30.88	784	20.00	508	23.88	607	11.75	298
82344RB	E1	32.50	826	20.63	524	24.00	610	10.63	270
82354	E1	30.88	784	20.00	508	23.88	607	11.75	298
92251	T4	10.00	254	8.00	203	9.75	248	4.75	121
82344DS	E1	30.88	784	20.00	508	23.88	607	11.75	298
DTU324N	E1	32.50	826	24.50	622	26.25	667	10.63	270
DTU324NRB	E1	32.50	826	24.50	622	26.25	667	10.63	270
H82344	E2	32.50	826	24.50	622	26.25	667	10.63	270
H82444	E2	32.50	826	30.21	767	33.61	854	10.63	270
H82454	E3	32.50	826	30.21	767	33.61	854	10.63	270
82454	E3	38.00	965	29.62	753	33.02	839	10.63	270
82444	E3	38.00	965	29.62	753	33.02	839	10.63	270
82454R	E3	38.00	965	29.62	753	33.02	839	10.63	270
82444R	E3	38.00	965	29.62	753	33.02	839	10.63	270
H82254	E3	32.50	826	24.50	622	26.25	667	10.63	270
H82354	E3	32.50	826	24.50	622	26.25	667	10.63	270
82444DS	E3	38.00	965	29.62	753	33.02	839	10.63	270
DTU326	A1	63.31	1608	23.66	601	24.46	621	8.88	226
DTU426	A1	63.31	1608	27.00	686	27.80	706	8.88	226
DTU366	A1	63.31	1608	23.66	601	24.46	621	8.88	226
DTU466	A1	63.31	1608	27.00	686	27.80	706	8.88	226
DTU326R	A1	63.76	1619	23.66	601	24.46	621	8.88	226
DTU426R	A1	63.76	1619	27.00	686	27.80	706	8.88	226
DTU366R	A1	63.76	1619	23.66	601	24.46	621	8.88	226
DTU466R	A1	63.76	1619	27.00	686	27.80	706	8.88	226
DTU366AWK	A1	63.76	1619	23.66	601	24.46	621	8.88	226
DTU225	A1	53.81	1367	23.13	588	23.88	607	7.25	184
DTU225R	A1	53.81	1367	23.13	588	23.88	607	7.25	184
DTU325	A1	53.81	1367	23.13	588	23.88	607	7.25	184
DTU325R	A1	53.81	1367	23.13	588	23.88	607	7.25	184
DTU365	A1	53.81	1367	23.13	588	23.88	607	7.25	184
DTU325R	A1	53.81	1367	23.13	588	23.88	607	7.25	184
DTU365AWK	A1	57.50	1461	23.00	584	23.75	603	7.25	184
DTU365DS	A1	57.50	1461	23.00	584	23.75	603	7.25	184
DTU465	A1	53.81	1367	23.13	588	23.88	607	7.25	184

SAFETY SWITCHES

**Table 3.55 200–600 A Types 82,000 and E-Series DTU and 30 A devices—Approximate Dimensions (cont'd.)**

Cat. No.	Series	H		W		W/H		D	
		in.	mm	in.	mm	in.	mm	in.	mm
<a href="#">DTU465R</a>	A1	53.81	1367	23.13	588	23.88	607	7.25	184

240 V Double Throw: [page 3-26](#)  
 600 V Double Throw: [page 3-27](#)

Accessories: [page 3-28](#)  
 Application Data: [page 3-30](#)

Dimensions, 30–100 A (Series F): [page 3-32](#)

# Section 4

## Power Monitoring and Control



EcoStruxure Power Monitoring Expert Software

ION9000 Power and Energy Meters



PowerLogic PM8000 Power and Energy Meters



Ethernet Gateways

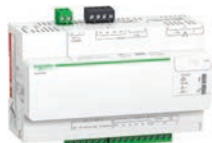

Com'X Data Loggers and Energy Servers



AccuSine PCS+

AccuSine PFV+



VarSet Low-Voltage Capacitor Banks

### PowerLogic™ Energy and Power Management Systems 4-2

Power Monitoring Software	4-4
EcoStruxure Power Monitoring Expert Software	4-4
EcoStruxure PowerSCADA Operation	4-6
Power Quality Meters — Selection	4-7
Power Quality Meters — ION9000	4-8
ION9000 Series Advanced Power Quality Meters	4-8
Power Quality Meters — ION8650	4-10
PowerLogic ION7400 Utility Feeder Meter	4-12
PowerLogic PM8000 Advance Power Quality Meters	4-14
Power and Energy Meters	4-15
Series 5000 Power Meters	4-15
Series PM2000 Power Meters	4-15
Series 3500 Energy and Power Meter	4-16
PowerLogic PM3000 Power and Energy Meters	4-17
iEM3000 Energy Meters	4-18
Power and Energy Meter Selection	4-20
PowerLogic Energy Meter	4-21
PowerLogic EM4200 Enercept Meter	4-21
Multi Circuit Energy Meters	4-22
PowerLogic Branch Circuit Power Meter	4-23
PowerLogic EM4900 Series Multi-Circuit Meters	4-25
Communications	4-26
Com'X Data Loggers and Energy Servers	4-26
Link150 Ethernet Gateway	4-27
Engineering Services	4-27
Integration and Equipment	4-31
System Integration	4-31
Factory Assembled Equipment	4-31
PowerLogic High Density Metering	4-33

### Power Quality Improvement Solutions 4-34

Power Factor Correction	4-35
VarSet Standard Capacitor Banks	4-36
VarSet Detuned Capacitor Banks	4-37
VarSet Fast Capacitor Banks	4-39
VarSet Current Transformers	4-40
AccuSine PFV+ Electronic VAR Control	4-41
AccuSine Current Transformers	4-42
VarSet Hybrid	4-44
Harmonic Filtration	4-45
AccuSine PCS+ Active Harmonic Filter (AHF)	4-45
AccuSine PCSn Active Harmonic Filter (AHF)	4-46

POWER MONITORING AND CONTROL  
4

**Join the Next Generation of Power and Energy Management**  
**More performance. More intelligence. More integration.**

Our industry-leading systems offer the latest in technological advancements to help you simultaneously maximize reliability, availability, and quality, as well as improve operational and cost efficiency for your entire enterprise. You'll benefit from:

- **Holistic approach**  
 Our solutions aggregate data from all your energy assets, including power, building, and process systems, into one user-friendly view so you can make more informed decisions and address problems efficiently.
- **Actionable intelligence**  
 Our solutions provide real-time and historical information to multiple stakeholders anywhere in the world, including easy-to-use analytics, alarms and controls, as well as regulatory compliance and financial reporting.
- **Proactive capabilities**  
 Our sophisticated products help you analyze and identify future needs so you can develop a long-term plan for things like energy purchasing, demand response, load changes, and equipment maintenance or replacement.



**Advanced Power Management**

Delivers power quality, availability, and reliability

- Maximize facility uptime by reducing power outages and ensuring back-up power generation
- Verify reliable power equipment operation and proactively optimize power networks
- Improve power reliability, availability, and quality through proactive analytics and diagnostics
- Optimize existing infrastructure capacity and avoid over-building
- Prolong asset life with proactive maintenance and optimization
- Reduce peak demand and power factor penalties with monitoring, alerts, and corrective actions
- Deliver enhanced network protection and control with data integration and automation

**Superior Energy Management**

Delivers cost and operational efficiencies

- Identify, prioritize, and verify savings through automated load management, benchmarking, and progress reporting
- Improve sustainability performance with greenhouse gas emissions tracking and industry compliance reporting
- Improve rates with energy suppliers through demand response programming
- Confirm ROI for system improvements with advanced reporting and analysis
- Identify billing discrepancies and avoid contract penalties by validating utility bills and confirming onsite generation benefits
- Encourage conservation among tenants, departments, and processes through cost allocation reporting

**Don't settle for fragmented views and unreliable data**

Maximize performance with a fully integrated power management solution

You'll benefit from our decades of expertise in electrical system management, hardware and software development, and integration. Our solutions are designed for compatibility so your installation is both optimized and more efficient. Our systems are modular and interoperable for better continuity of supply, enhanced safety for people and equipment, and more effective monitoring and control. Plus, our full range of in-person and remote services keep your system operating at peak performance.

Application

	Data Presentation & Management		Data Acquisition, Alarms & Monitoring			
	Enterprise	Online Energy Analysis	Supervisory Control & Data Acquisition	Power Monitoring System	Tenant Submetering	
	Data Centers; Industrial Buildings, Property Management, Utilities	Utilities	Water/Wastewater, Heavy Process Industry, Data Centers, Critical Power	Industrial, large commercial buildings, Military Bases, Healthcare	Commercial Buildings, Government Buildings, Military Bases	
Cost Management	Meter Application					
	Automatic Meter Reading			.	....	..
	Revenue Metering			.	....	..
	WAGES Utility Pulses				...	
	Sub-billing	...	...			....
	Measurement & Verification	....	..		...	
	Cost Allocation & Utility Billing					
	Energy Usage Analysis	....	...	.	..	.
	Procurement Optimization	..	...	.	.	
	Allocate Energy Costs	.			.	
	Interval Benchmarking & Profiling	....	...	.	..	
	Total Load Aggregation	....				
	Energy Efficiency					
	Emissions Tracking	..	...			
	Power Factor Correction	.	.		...	
	Peak Demand Reduction	..	.	...	...	
	Demand Response & Curtailment			...	...	
Ensure Power Quality	Improve Maintenance Practices					
	Commissioning & Troubleshooting			...	....	
	Equipment Monitoring: transformers, MCCs, switchgear, switchboards, circuit breaker status, protective equipment, capacitors, generators, panelboards, PDU, UPS, etc.			...	....	
	Facility Planning					
	Identify Equipment Capacity				...	
	Determine Transformer Stress				...	
	Equipment Asset Optimization	..		..	...	
	Improve Efficiency					
	Balance Circuit Loading				...	
	Balance Generator Usage				...	
	Optimize Chiller & Mechanical Equipment				.	
Network Management	System Monitoring & Analysis					
	Transient Voltage Detection				....	
	Sag/Swell Disturbance Monitoring				....	
	Power Quality & Harmonic Analysis				....	
	Power Quality Compliance	....		.	...	
	Alarm & System Diagnostics					
	Electrical Distribution Alarm & Event Analysis	.		...	....	
	Waveform capture viewing				....	
Remote alarm notification			....	...		
Engineering Services	Energy Services					
	Total Energy Control Services	....	see Engineering Services, page 4-27		...	
	Peak Shaving/Generator Control			....	..	see Engineering Services, page 4-27
	Load Management/Shedding	see Engineering Services, page 4-27		....	..	
	WAGES				...	
	Advanced Reliability Services					
	Auto Throw Over (ATO)			....	..	see Engineering Services, page 4-27
	Emergency Power Supply System Test Reporting				....	
	Sequence of Events Recording (1ms time/stamp)	see Engineering Services, page 4-27		....	...	
	GPS Time Stamping			....	...	
	Power System Control			....	.	
	Network Protection			....	..	
	Consulting Services					
	System Studies (SC/TCC/ Arc Flash)			see Engineering Services, page 4-27		
Power System Assessments						



- Manage power quality, availability, and reliability
- Optimize use of your electrical and infrastructure assets
- Drive energy efficiency initiatives and improve financial performance

## EcoStruxure Power Monitoring Expert Software

### EcoStruxure Power Monitoring Expert

EcoStruxure™ Power Monitoring Expert is an integrated power & energy management software platform that enables you to optimize your power distribution infrastructure, maximize operational efficiency, and improve your bottom-line performance. This complete, interoperable, and scalable solution will help you

- Maximize facility uptime and reliability
- Analyze and mitigate power quality related issues
- Track and optimize equipment performance
- Analyze energy consumption, uncover savings opportunities and accurately allocate energy related costs
- Enable compliance with power quality and energy standards such as ANSI/IEEE and ISO50001

#### Typical Applications

- Monitor the facility electrical network to verify reliable operation and proactively optimize performance
- Maximize facility uptime by improving response to power-related events and restore operations quickly
- Perform root cause analysis to power-related disturbances through sequence of events reporting
- Analyze and isolate the source of power quality problems
- Analyze total energy use from all electrical and piped utilities identify waste and reduce cost
- Improve sustainability performance with greenhouse gas emissions tracking and industry compliance reporting
- Identify billing discrepancies and avoid contract penalties by validating utility bills to verify accuracy
- Allocate energy costs to departments to drive accountability, awareness and support energy action programs like ISO50001
- Reduce peak demand and power factor penalties with monitoring, alerts, and corrective actions
- Negotiate rates with energy suppliers and enable participation in demand response programs
- Confirm return on investment for infrastructure improvements with advanced reporting and analysis
- Optimize existing infrastructure capacity and avoid over-building
- Prolong asset life with proactive maintenance and optimization

#### Functional Components:

- Power quality analytics
  - Monitor events and waveform plotting system-wide
  - Monitor harmonics, K-factor, crest factor, symmetrical components
  - Diagnose and isolate PQ problems to increase reliability
  - Automatically detect and report on voltage disturbances
  - Quickly evaluate PQ events plotted on standard ITIC curve
- Customized real-time monitoring
  - Access real-time status of sensitive power distribution components
  - Trend chart tools with customized views to reveal patterns and anomalies quickly
- Data analytics and visualization
  - Smart dashboards with configurable presentation widgets and kiosk options
  - Powerful graphics templates and libraries
  - Automated power quality reports and waveform analysis tools
  - Comprehensive templates for energy and power reporting, with flexible report distribution options
- Alarm and event management
  - Powerful alarm triggering, notification, and analysis tools
  - Accurate time-stamped sequence of events reporting for power system event root cause analyses
- Robust technical infrastructure
  - Solid data acquisition architecture including ready-to-use communications drivers with many electrical distribution devices
  - Fully compatible with current operating systems and databases
  - Interoperable with integration to other systems and devices through open data and protocol standards (ODBC, OPC, XML, Modbus, Web/SOAP Services)
  - Scalable to thousands of metered points through flexible deployment options



#### Modular Design:

Power Monitoring Expert also features many application modules that add specific functionality to extend the base platform. Available modules include

- Energy Analysis
- UPS Performance
- Breaker Performance
- Energy Cost Allocation & Billing
- Automated Generator Testing

**Segment Editions:**

Power Monitoring Expert also features segment-specific solutions for data centers, healthcare, industry and buildings, delivering pre-engineered functionality customized to meet your needs.



**EcoStruxure Power Monitoring Expert Data Center Edition**

- Decrease the number and duration of unplanned outages
- Manage power capacity and redundancy
- Improve effectiveness of maintenance activities
- Improve power distribution efficiency
- Support energy cost allocation and billing



**EcoStruxure Power Monitoring Expert Data Healthcare Edition**

- Improve energy availability
- Manage power system reliability
- Perform power quality analysis and management
- Support energy efficiency initiatives to improve financial performance



**EcoStruxure Power Monitoring Expert Data Buildings Edition**

- Ensure electrical system health
- Optimize operational efficiency
- Gain energy insight
- Improve energy accountability

Description	Catalog Number
Power Monitoring Expert Standard Edition BASE license (includes 1 Engineering Client)	PSWSANCZZSPEZZ
Power Monitoring Expert Data Center Edition BASE license (includes 1 Engineering Client)	PSWSDNCZZSPEZZ
Power Monitoring Expert Healthcare Edition BASE license (includes 1 Engineering Client)	PSWSHNCZZSPEZZ
Power Monitoring Expert Buildings Edition BASE license (includes 1 Engineering Client)	PSWSBNCZZSPEZZ
5 Device Pack for Power Monitoring Expert software	PSWDANCZZNPEZZ
25 Device Pack for Power Monitoring Expert software	PSWDBNCZZNPEZZ
50 Device Pack for Power Monitoring Expert software	PSWDCNCZZNPEZZ
100 Device Pack for Power Monitoring Expert software	PSWDDNCZZNPEZZ
200 Device Pack for Power Monitoring Expert software	PSWDFNCZZNPEZZ
Unlimited Devices for Power Monitoring Expert software	PSWDZNCZZSPEZZ
Engineering Client for Power Monitoring Expert software	PSWCENCZZNPEZZ
Web Client for Power Monitoring Expert software	PSWCWNCZZNPEZZ
Unlimited Engineering and Web Clients for Power Monitoring Expert software	PSWCZNCZZSPEZZ
Event Notification Module for Power Monitoring Expert software	PSWVMNCZZSPEZZ
Cost Allocation & Billing Module for Power Monitoring Expert software	PSWMBNCZZSPEZZ
Breaker Performance Module for Power Monitoring Expert software	PSWVMXNCZZSPEZZ
Energy Analysis Module for Power Monitoring Expert software	PSWVMZNCZZSPEZZ
Energy Awareness Module for Power Monitoring Expert software	PSWVMYNCZZSPEZZ
UPS Performance Module for Power Monitoring Expert software	PSWVMUNCZZSPEZZ
EPSS Module for Power Monitoring Expert software (HealthCare)	PSWVMENCZZSPEZZ
Generator Performance Module for Power Monitoring Expert software (Data Centers)	PSWVMGNCZZSPEZZ
IT Billing Module for Power Monitoring Expert software (Data Centers)	PSWVMTNCZZSPEZZ
Power Capacity Module for Power Monitoring Expert software (Data Centers)	PSWVMPCZZSPEZZ
Power Efficiency Module for Power Monitoring Expert software (Data Centers)	PSWVMNCCZZSPEZZ
SQL Server 2012 License - 2 COREs	IE7SQLCZSNPEZZ



## EcoStruxure PowerSCADA Operation

- Increase uptime of power systems
- Provides accurate and actionable information in real time
- Highlights issues, remediation, and their impacts

EcoStruxure™ PowerSCADA Operation is electrical distribution network monitoring and control software that provides vital tools to enhance your power system reliability and operational efficiency. Its powerful architecture combines our proven expertise in electrical distribution with the speed and control of high-performance SCADA to reduce outages while increasing power system efficiency. An excellent fit for virtually every industry and application, PowerSCADA Operation delivers exceptional scalability so that it can grow to match your changing business requirements while driving down the total cost of ownership. Components interact seamlessly across Schneider Electric's extensive product portfolio and third party suppliers.

- Dynamic electrical network view to improve production, reduce costs and boost safety
- Highly reliable monitoring and control tailored to unique electrical network needs
- Detailed electrical information across the multi-vendor network
- Fast issue resolution and reporting to improve electrical network quality and energy use
- Report KPIs, energy costs, and filtered alarming
- Real-time visualization of the network
- Disturbance waveform views for analysis and control for remediation

For quoting and pricing, please contact PowerLogic Sales at 615-287-3535.



**Power Quality Meter Selection**

Features [1]	ION9000	ION9000T	ION8650			ION7400	PM8000
			A	B	C		
<b>Inputs, outputs and control power</b>							
3-phase / single-phase	*/*	*/*	*/*	*/*	*/*	*/*	*/*
Digital in and out / analog in and out	46 / 24	46 / 24	16 / 4	16 / 4	16 / 4	36/24	36/24
Power supply options	AC / -	AC / -	AC/DC	AC/DC	AC/DC	AC/DC	AC/DC
<b>Power and energy measurements</b>							
Voltage, current, frequency, power factor	*	*	*	*	*	*	*
Power / Demand	*	*	*/*	*/*	*/*	*/*	*/*
Energy / time-of-use (energy per shift)	*/*	*/*	*/*	*/*	*/*	*/*	*/*
IEC / ANSI energy accuracy class (% of reading)	0.1	0.1	0.2(1)	0.2(1)	0.2(1)	0.2	0.2
Loss compensation	*	*	*	*	*	-	-
<b>Power quality analysis</b>							
EN50160 compliance reporting / IEC 61000-4-30 Class A or S	*/A	*/A	*/A	*/S	-/-	*/S	*/S
Flicker measurement	*	*	*	*	-	-	-
Transient detection duration	20 µs	100 ns	17 µs	-	-	-	-
Sag and swell monitoring / disturbance direction detection	*/*	*/*	*/-	*/-	*/-	*/*	*/*
Harmonic distortion: total/ individual / inter	*/*/*	*/*/*	*/*/*	*/*/-	*/*/-	*/*/-	*/*/-
Waveform capture	*	*	*	-	-	*	*
<b>On-board data and event logging</b>							
Trending / forecasting / billing	*/*/*	*/*/*	*/-/*	*/-/*	*/-/*	*/*/*	*/*/*
Minimum and maximum	*/*	*/*	*	*	*	*	*
Events and alarms with timestamps	*	*	*	*	*	*	*
Timestamp resolution (seconds)	0.001	0.001	0.001	0.001	0.001	0.001	0.001
Time sync: Network / GPS / IRIG-B / DCF77-B / PTP	*/*/*/*/*	*/*/*/*/*	*/*/*/-/-	*/*/*/-/-	*/*/*/-/-	*/*/*/-/-	*/*/*/-/-
<b>Setpoints, alarms and control</b>							
Log alarm conditions / call out on alarm	*/*	*/*	*/*	*/*	*/*	*/*	*/*
Trigger data logging / waveform capture	*/*	*/*	*/*	*/-	*/-	*/*	*/*
Trigger relay or digital output	*	*	*	*	*	*	*
<b>Special features</b>							
Custom programming	*	*	*	*	*	*	*
Downloadable firmware	*	*	*	*	*	*	*
<b>Communications</b>							
<b>Ports:</b>							
Ethernet: Copper / Fiber	2 / -	2 / -	*/*	*/*	*/*	2 / -	2 / -
Ethernet-to-serial gateway	*	*	*	*	*	*	*
Telephone modem	-	-	*	*	*	-	-
Modem-to-serial gateway	-	-	*	*	*	-	-
Infrared port	*	*	*	*/*	*/*	*	*
RS485/RS232	*/-	*/-	*/*	*/*	*/*	*/-	*/-
Misc: Web server / Email / SNMP / XML	*/*/*/*	*/*/*/*	*/*/-/*	*/*/-/*	*/*/-/*	*/*/*/*	*/*/*/*
Protocols: Modbus / DNP / MV-90 / DLMS	*/*/*/-	*/*/*/-	*/*/*/-	*/*/*/-	*/*/*/-	*/*/*/-	*/*/*/-
Protocols: IEC61850 / Jbus / M-Bus / LON / BACnet	*/-/-/-/-	*/-/-/-/-	*/-/-/-/-	*/-/-/-/-	*/-/-/-/-	*/-/-/-/-	*/-/-/-/-

**NOTE:**

1. The ION8650 is two times more accurate than the 0.2 IEC/ANSI accuracy classes according to the same conditions used to specify the 0.2 accuracy class.
2. ION8800, ION8650, ION8600, PM8000 also offer Modbus Master capabilities.

[1] Specifications represent maximum capabilities with all options installed. Some options are not available concurrently. This is not a complete feature list, please refer to detailed product specifications.

New!

## ION9000 Series Advanced Power Quality Meters

Web enabled PowerLogic ION9000 series meters are used to monitor electric distribution networks, service entrances and substations. It enables businesses to manage complex energy supply contracts that include power quality guarantees. Low-range current accuracy makes it ideal for independent power producers and cogeneration applications that require the accurate bi-directional measurement of energy. It is well suited to load curtailment, equipment monitoring and control and energy pulsing and totalization applications. Integrate it with Power Management Software applications. The ION9000T captures extremely fast voltage events that are missed by most other power meters, enabling advanced diagnostics and high-resolution event associations for fast, conclusive diagnosis and resolution to transient voltages.



### ION9000 Power and Energy Meter Features

PQ compliance reporting and basic PQ analysis:

- Monitors and logs parameters in support of international PQ standards
  - IEC 61000-4-30 Class A (test methods as per IEC 62586-2)
- High resolution waveform capture: triggered manually or by alarm. Captured waveforms available directly from the meter via FTP in a COMTRADE format, and viewable in the meter's web interface.
- Generates PQ compliance reports accessible via onboard web pages:
- Harmonic analysis:
  - THD and TDD per phase, min/max, custom alarming
  - Individual harmonic magnitudes and angles on voltage and current, up to the 63rd harmonic
- Disturbance detection and capture: sag/swell on any current and voltage channel, alarm on disturbance event, waveform capture with per-event information
- Patented disturbance direction detection: provides indication of the captured disturbance occurring upstream or downstream of the meter; timestamped results provided in the event log, with degree of certainty of disturbance direction
- Transient capture of events 20 microseconds or longer in duration on any voltage channel with waveform capture and per-event information
- PowerLogic ION9000T provides high-speed transient capture (HSTC) of voltage events 100 nanoseconds or longer in duration and up to 10,000 V in magnitude on voltage channels and with an alarm on the event, the ION9000T provides high-speed and disturbance waveform captures, as well as per-event statistics on each transient.

Metering precision:

- IEC 61557-12 PMD/SD/K70/0.2 and PMD/SS/K70/0.2 3000m (performance measuring and monitoring devices (PMD))
- Class 0.1S accuracy IEC 62053-22, ANSI C12.20 Class 0.1 (active energy)
- Industry leading Class 0.5S accuracy for reactive energy (IEC 62053-24)
- Cycle-by-cycle RMS measurements updated every cycle
- Full 'multi-utility' WAGES metering support
- Net metering
- Anti-tamper protection seals and hardware metrology lock

Cybersecurity:

- Security events logging with Syslog protocol support
- HTTPS secure protocol
- Ability to enable or disable any communication port and any protocol per port
- Anti-tamper protection seals and hardware metrology lock
- User accounts with strong passwords
- Used with Schneider Electric's advanced software tools, provides detailed PQ reporting across entire network:
- EN 50160 compliance report
- IEEE 519 harmonic compliance report
- IEC 61000-4-30 report
- Power quality compliance summary
- Energy reports for consumption analysis and cost management
- WAGES dashboards and reports
- Display of waveforms and PQ data from all connected meters
- Onboard web-based waveform viewer
- EcoStruxure Power Events Analysis, including alarm management, sequency of events, and root cause analysis

Data and event logging:

- Onboard data and event logging
- 2 GB of standard non-volatile memory
- No data gaps due to network outages or server downtime
- Min/max log for standard values
- 100 user-definable data logs, recording up to 16 parameters on a cycle-by-cycle or other user definable interval
- Continuous logging or snapshot, triggered by setpoint and stopped after defined duration

- Trend energy, demand and other measured parameters
- Forecasting via web pages: average, minimum and maximum for the next four hours and next four days
- Advanced time-of-use capability
- Security/event log: alarm conditions, metering configuration changes, power outages, firmware download, and user login/logout all timestamped to ±1 millisecond

**Alarming and control:**

- 50+ definable alarms to log critical event data, trigger waveform recording, or perform control function
- Trigger on any condition, with 1/2-cycle and 1-second response time
- Combine alarms using Boolean logic enabling customization of alarms
- Alarm notification via email
- In conjunction with Schneider Electric's EcoStruxure software, alarms, software alarms, and alarm frequency are categorized and trended enabling sequence of events and root cause analyses

**Table 4.1: Typical PowerLogic ION9000 Power and Energy Meter Ordering Configurations**

Description <sup>[2]</sup>	Catalog Number
ION9000 meter, DIN mount, no display, HW kit	<a href="#">METSEION92030</a>
ION9000 meter, DIN mount, 192 mm display, B2B adapter, HW kit	<a href="#">METSEION92040</a>
ION9000 meter, LVDC control power, DIN mount, no display, HW kit	<a href="#">METSEION92130</a>
ION9000 meter, LVDC control power, DIN mount, 192mm display, B2B adapter, HW kit	<a href="#">METSEION92140</a>
ION9000 meter, low voltage current sensor inputs, DIN mount, no display, HW kit	<a href="#">METSEION93030</a>
ION9000 Meter, low voltage current sensor inputs, DIN mount, 192mm display, B2B adapter, HW kit	<a href="#">METSEION93040</a>
ION9000 meter, low voltage current sensor inputs, LVDC control power, DIN mount, no display, HW kit	<a href="#">METSEION93130</a>
ION9000 meter, low voltage current sensor inputs, LVDC control power, DIN mount, 192mm display, B2B adapter, HW kit	<a href="#">METSEION93140</a>
ION9000 meter, high-speed transient capture, DIN mount, no display, HW kit	<a href="#">METSEION95030</a>
ION9000 meter, high-speed transient capture, DIN mount, 192 mm display, B2B adapter, HW kit	<a href="#">METSEION95040</a>
Remote display, color LCD, 96 x 96 mm	<a href="#">METSEPM89RD96</a>
Remote display, color touchscreen, 192 x 192 mm	<a href="#">METSERD192</a>
I/O module, 2 relay outputs, 6 digital inputs	<a href="#">METSEPM89M2600</a>
I/O module, 2 analog outputs, 4 analog inputs	<a href="#">METSEPM89M0024</a>
ION9000 meter hardware kit – plugs, terminal guards, spare grounding screw, DIN clips	<a href="#">METSE9HWK</a>
ION9000 meter hardware kit for low voltage current sensor models	<a href="#">METSE9HWKLVCS</a>
RD192 remote display hardware kit	<a href="#">METSERD192HWK</a>
ION9000 B2B adapter	<a href="#">METSE9B2BMA</a>
ION9000 USB cover hardware kit	<a href="#">METSE9USBK</a>
ION9000 Current Input hardware kit – terminal screws, CT covers	<a href="#">METSE9CTHWK</a>
Battery replacement kit – ION7400/ION9000/PM8000	<a href="#">METSEPMBATK</a>
ION7x50 Mounting Adapter Kit	<a href="#">METSE7x4MAK</a>

[2] NOTE: Contact your local Schneider Electric representative for complete ordering information.



## ION8650 Power and Energy Meters

The web-enabled PowerLogic ION8650 is used to monitor electric distribution networks, service entrances and substations. It enables businesses to manage complex energy supply contracts that include power quality guarantees. Low-range current accuracy makes it ideal for independent power producers and cogeneration applications that require the accurate bi-directional measurement of energy. It is well suited to load curtailment, equipment monitoring and control and energy pulsing and totalization applications. Integrate it with Power Management Software applications to get the most out of the meter's capabilities and data produced.

### Applications

- Revenue metering
- Cogeneration and IPP monitoring
- Power Quality Compliance monitoring
- Power quality analysis
- Demand and power factor control
- Load curtailment
- Equipment monitoring and control
- Energy pulsing and totalization
- Instrument transformer correction
- Outage Notification

### ION8650 Power and Energy Meter Features

#### Feature set C includes:

- 9S, 35S, 36S socket and switchboard cases
- True RMS 3-phase voltage, current, power and meets stringent ANSI revenue metering standards including ANSI C12.20 0.2 and Class 2, 10, & 20
- Power quality: sag/swell, individual, even, odd, total harmonics to the 31st and symmetrical components
- 32 Mb log/event memory, min/max for any parameter, historical logs up to 80 channels, timestamp resolution to 0.001 seconds and GPS time synchronization
- Transformer/line loss compensation and Instrument transformer correction
- Communications: Ethernet, Serial, Modem, Internet and Ethernet to serial gateway and ION, DNP 3.0, Modbus RTU, Modbus TCP, MV-90 protocols, IEC 61850
- C model limited to IR + 2 other ports at one time. Ports can be enabled/disabled by user
- Dial-out capability when memory is near full
- Multi-user, multi-level security with control and customized access to sensitive data for up to 50 users
- Data push capability through SMTP (email)
- 65 setpoints — math, logic, trig, log, linearization formulas
- Password protection and anti-tamper seal protection
- Built-in I/O: 4 KYZ digital outs and 3 form A digital ins, 4 KYZ digital outs and 1 form A digital out and 1 form A digital in, an optional external I/O expander provides additional I/O
- Optional Outage Notification Card for JSON outage notification message over ethernet

#### Feature set B adds the following to feature set C:

- Harmonics—individual, total even, total odd up to the 63rd
- 64 Mb standard memory
- Historical logs up to 320 channels
- Modbus RTU Master on serial ports
- Cycle setpoint minimum response time

#### Feature set A adds the following to feature sets C and B:

- Waveform capture up to 1024 samples/cycle, PQ compliance monitoring, flicker to EN50160 Ed2, IEC 61000-4-7/4-15 (also configurable to IEEE519 2014, IEEE159, SEMI) CBEMA/ITIC
- Transient detection to 17µs at 60 Hz
- Harmonics: magnitude, phase and inter-harmonics to the 50th
- 128 Mb standard memory
- Max 96 cycles of waveform logs and 800 channels of historical logs

Table 4.2: Typical PowerLogic ION8650 Power and Energy Meter Ordering Configurations

Description	Catalog Number
ION8650, feature set A, 9S socket base, 5 A nominal current inputs, 10 MB memory, 127–177 Vac, 60 Hz, communications card with: 10BaseT, RS-232/485, RS-485, Optical port, 4 Digital Outputs, 3 Digital Inputs	S8650A0C0E6E1B0A
ION 8650; feature set A, 9S socket base, 5 A nominal current inputs, 128 MB memory, 120–277 VAC, 60 Hz, comms card with: 10/100BaseT, RS-232/485 port, RS-485, 56k internal modem (RJ11), Infrared Optical Port; No I/O, Password Protected, no security lock	S8650A0C0E6C7A0A
ION8650, feature set C, 9S socket base, 5 A nominal current inputs, 2 MB memory, 120–277 Vac, 60 Hz, communications card with: RS-232/ 485, RS-485, Optical port, 4 Digital Outputs, 3 Digital Inputs	S8650C0C0E6A0B0A
ION 8650; feature set C, 9S socket base, 5 A nominal current inputs, 32 MB memory, 120–277 VAC, 60 Hz, comms card with 10/100BaseT, RS-232/485 port, RS-485 port, Infrared Optical Port, No I/O, Password Protected, no security lock	S8650C0C0H6E1A0A

**Table 4.3: ION8650 Order Codes/Descriptions**

Brand	Model	Feature Set	Form Factor	Current Inputs	Voltage Inputs	Power Supply	System Freq	Comm	I/O	Security	Special Order	AA Code
S	8650				C	0					A	-Axxx
ION8650		Order Code	Description									
Brand		S	Schneider branded									
Model		8650	ION8650 advanced revenue meter with Class 0.1 accuracy + IRIG-B									
Feature Set		A	128MB Memory Class A power quality analysis, waveforms and transient capture with 1024 samples/cycle.									
		B	64MB memory, energy meter Class S EN50160 power quality monitoring.									
		C	32MB memory, basic tariff/energy metering (4 data recorders, 64 channels).									
Form Factor		0	Form 9/29/36S Base - 57-277 VLN (autoranging) 3-Element, 4-Wire / 2 1/2-Element, 4-Wire									
		1	Form 35S Base - 120-480 VLL (autoranging) 2-Element, 3-Wire									
		4	Form 9/29/35/36S FT21 Switchboard (meter + case) with break out panel									
		7	Form 9/29/35/36S FT21 Switchboard (meter + case) with break out cable									
Current Inputs		C	1, 2 or 5 Amp nominal, 20 Amp full scale current input (24 Amp fault capture, start at 0.001A)									
Voltage Inputs		0	Standard (see Form Factor above)									
Power Supply		E	Form 9S, 36S (socket) and Form 9,36 (FT21 switchboard): 120-277 Vac. Form 35S (socket) and Form 35 (FT21 switchboard): 120-480 Vac. Powered from the meter's voltage connections.									
		H	Auxiliary Power Pigtail: 65-120 Vac, 80-160 Vdc (power from external source), North American Plug Style									
		J	Auxiliary Power Pigtail: 160-277 Vac, 200-350 Vdc (power from external source), North American Plug Style									
System Frequency		5	50 Hz									
		6	60 Hz									
Communications <sup>[3]</sup>		C7	Ethernet (10/100BASE-T), 56k universal internal modem (RJ11), RS-232/485 port, RS-485 port, Infrared Optical port									
		E1	Ethernet (10/100BASE-T), RS-232/485 port, RS-485 port, Infrared Optical port									
		F1	Ethernet (100BASE-FX multi-mode) with male ST connectors, RS-232/485 port, RS-485 port, Infrared Optical port (available on socket meters only, Forms 0 & 1 above. I/O card not available if this option is ordered.)									
		S1	Ethernet (10/100-BASE-T), Verizon 4G cell modem - SIM CARD OPTION, RS 232/485 port, RS 485 port, Infrared optical port									
Input/Output Option		A	None									
		B	4 Form C Digital Outputs, 3 Digital Inputs (not available with Communications option F1)									
		C	4 Form C Digital Outputs, 1 Form A Digital Output, 1 Digital Input									
		D	Ride-Through Module for JSON outage notification message over Ethernet. (only available with comms option E1, C7 & S1)									
Security		0	Password protected, no security lock									
		1	Password protected with security lock enabled									
		7	Password protected, no security lock (available in US only)									
		8	Password protected with security lock enabled (available in US only)									
Special Order Options		A	None									

[3] In addition to Infrared Optical port Feature Set C can use any two ports (configurable).



PowerLogic ION7400

### PowerLogic ION7400 Utility Feeder Meter

The PowerLogic ION7400 utility feeder meter is a highly accurate, extremely reliable power and energy meter with unmatched flexibility and usability. The meter combines accurate 3-phase energy and power measurements with data logging, power quality analysis, alarming and I/O capabilities not typically available in such a compact meter.

The panel or DIN mounted ION7400 meter is flexible enough to fit into a utility's existing billing or SCADA system, providing industry leading cost management (Class 0.2) and network management (Class S PQ) data. It is compliant with stringent international standards that guarantee their metering accuracy and power quality measurements. Ideal for installations that are responsible for maintaining the operation and profitability of a facility.

#### Applications and benefits

- Maximize profits by providing the highest output possible with the least amount of risk to availability.
- Optimize availability and reliability of electrical systems and equipment.
- Monitor power quality (PQ) for compliance and to prevent problems.
- Meters fully supported by EcoStruxure Power Monitoring Expert and PowerSCADA Operation Software.

#### Main Characteristics

- Precision metering
- PQ compliance reporting and basic PQ analysis
- Used with EcoStruxure Power Monitoring Expert software, provides detailed PQ reporting across entire network
- Onboard data and event logging
- Alarming and control
- Excellent quality: ISO 9001 and ISO 14000 certified manufacturing.

Table 4.4: PowerLogic ION7400 Meters

Description	Catalog Number
ION7400 Panel mount meter (integrated display with optical port and 2 energy pulse LEDs)	<a href="#">METSEION7400</a>
DIN rail mount - utility meter base	<a href="#">METSEION7403</a>
ION7400 Panel mount meter (integrated display with optical port and 2 energy pulse LEDs), 20-60 Vdc control power	<a href="#">METSEION7410</a>
DIN rail mount - utility meter base, 20-60 Vdc control power	<a href="#">METSEION7413</a>

Table 4.5: PowerLogic ION7400 Accessories

Description	Catalog Number
Remote display, 3 metre cable, mounting hardware for 30mm hole (nut & centering pin), mounting hardware for DIN96 cutout (92x92mm) adapter plate	<a href="#">METSEPM89RD96</a>
Digital I/O module (6 digital inputs & 2 relay outputs)	<a href="#">METSEPM89M2600</a>
Analog I/O module (4 analog inputs & 2 analog outputs)	<a href="#">METSEPM89M0024</a>
Display Cable, 10 meters	<a href="#">METSECAB10</a>



PowerLogic ION7400 showing active alarms.



PowerLogic ION7400 with harmonics display.



PowerLogic ION7400 with phasor display.

**Table 4.6: PowerLogic ION7400 Features**

Description		ION7400
<b>General</b>		
Use on LV and MV systems		■
Current accuracy (5A Nominal)		0.1 % reading
Voltage accuracy (90-690 V AC L-L, 50, 60, 400 Hz)		0.1 % reading
Active energy accuracy		0.2 %
Number of samples/cycle or sample frequency		256
<b>Instantaneous rms values</b>		
Current, voltage, frequency		■
Active, reactive, apparent power	Total and per phase	■
Power factor	Total and per phase	■
Current measurement range (autoranging)		0.05 - 10 A
<b>Energy values</b>		
Active, reactive, apparent energy		■
Settable accumulation modes		■
<b>Demand values</b>		
Current	Present and max. values	■
Active, reactive, apparent power	Present and max. values	■
Predicted active, reactive, apparent power		■
Synchronisation of the measurement window		■
Setting of calculation mode	Block, sliding	■
<b>Power quality measurements</b>		
Harmonic distortion	Current and voltage	■
	Via front panel and web page	63
Individual harmonics	Via EcoStruxure software	127
Waveform capture		■
Detection of voltage swells and sags		■
Flicker		■
Fast acquisition	1/2 cycle data	■
EN 50160 compliance checking		■
Customizable data outputs (using logic and math functions)		■
<b>Data recording</b>		
Min/max of instantaneous values		■
Data logs		■
Event logs		■
Trending/forecasting		■
SER (Sequence of event recording)		■
Time stamping		■
GPS synchronization (+/- 1 ms)		■
Memory (in Mbytes)		512 10 MB for Frameworks
<b>Display and I/O</b>		
Front panel display 89 mm (3.5 in.) TFT		■
Wiring self-test		■
Pulse output		1
Digital		6 in / 2 out
Analogue		4 in / 2 out
Digital or analogue outputs (max, including pulse output)		1 digital 8 relay 8 analog
<b>Communication</b>		
RS 485 port		1
10/100BaseTX		2
Serial port (Modbus, ION, DNP3)		■
Ethernet port (Modbus/TCP, ION TCP, DNP3 TCP, IEC 61850 [4])		■
USB port (mini type B)		■
ANSI C12.19 Optical port		■
<b>Standards</b>		
IEC 61000-4-30, IEC 61000-4-7, IEC 61000-4-15, IEC 61326-1, ANSI C12.20, IEC 62052-11, IEC 62053-22, CLC/TR50579		

[4] All the communication ports may be used simultaneously.



### PowerLogic PM8000 Advance Power Quality Meters

These compact meters help ensure the reliability and efficiency of your facility by making the management of power quality, availability, and reliability easy. Measure, understand, and act on insightful power and energy data gathered from your entire system.

#### The best choice for power management

PM8000 meters combine accurate 3-phase energy and power measurements with data logging, power quality analysis, alarming and I/O capabilities not typically available in such compact meters. Four-metered current inputs allow direct measurement of 3-phase currents and neutral current for enhanced view of harmonics. Dual Ethernet ports support daisy-chaining, removing need for an Ethernet switch inside power equipment, while redundant ring topology provides enhanced availability. Modular, field installable I/O provides expandable scalability. Patented ION technology combines convenient, pre-configured functionality with the ability to customize the meter configuration to meet unique requirements. This embedded capability can save the expense and complexity of additional equipment, both today and tomorrow. Plus, simple installation and networking make energy information quickly accessible, while integration with EcoStruxure™ software and your energy management system make it immediately actionable.

#### Address power issues before they cause problems

- Monitor harmonics to mitigate excessive heating and premature failure of transformers
- Use trending and alarming to detect fluctuations in current pull of critical equipment to prevent motor failure
- Utilize millisecond time stamping to analyze sequence of events
- Identify root cause by analyzing electrical faults with patented disturbance direction detection
- Identify power quality issues per EN 50160, including frequency inconsistency, voltage fluctuations and unbalance, and harmonic contribution
- Allocate costs for water, air, gas, electricity, and steam (WAGES) across departments, phases of industrial process, or cost centers
- Utilize time-of-use calendar to capture electrical consumption for specific times, including on/off peak and holidays

Table 4.7: PM8000 Power and Energy Meter Catalog Numbers

Description	Catalog Number
96 x 96 panel mount meter, LV DC power	METSEPM8210
DIN rail mount meter, LV DC power	METSEPM8213
DIN rail mount meter with remote display, LV DC power	METSEPM8214
PM8000 Panel Mount Meter with Integrated Display	METSEPM8240
PM8000 DIN Rail Mount Meter without Display	METSEPM8243
PM8000 DIN Rail Mount Meter + Remote Display	METSEPM8244
Remote Display, Color LCD, 96 x 96	METSEPM89RD96
I/O module, 2 relay outputs, 6 digital inputs	METSEPM89M2600
I/O module, 2 analog outputs, 4 analog inputs	METSEPM89M0024
Display Cable, 10 meters	METSECAB10
Display Cable, 3 meters	METSECAB3
Display Cable, 1 meters	METSECAB1
Sealing kit	METSEPM8000SK
Mounting adapter kit (ANSI 4")	METSEPM8
Replacement hardware kit, PM8000 meter	METSEPM8HWK
Replacement hardware kit, PM8000 remote display	METSEPM8RDHWK

Table 4.8: PM8000 Series Features

Intermediate meter		
<b>General</b>		
Use on LV and MV systems		■
Current accuracy (5A Nominal)		0.1 % reading
Voltage accuracy (57 V LN/100 V LL to 400 V LN/690 V LL)		0.1 % reading
Active energy accuracy		0.2 %
Number of samples/cycle or sample frequency		256
<b>Instantaneous rms values</b>		
Current, voltage, frequency		■
Active, reactive, apparent power	Total and per phase	■
Power factor	Total and per phase	■
Current measurement range (autoranging)		0.05–10 A
<b>Energy values</b>		
Active, reactive, apparent energy		■
Settable accumulation modes		■
<b>Demand values</b>		
Current	Present and max. values	■
Active, reactive, apparent power	Present and max. values	■
Predicted active, reactive, apparent power		■
Synchronization of the measurement window		■
Setting of calculation mode	Block, sliding	■
<b>Power quality measurements</b>		
Harmonic distortion	Current and voltage	■
Individual harmonics	Via front panel and web page	63
	Via EcoStruxure software	127
Waveform capture		■
Detection of voltage swells and sags		■
Fast acquisition	1/2 cycle data	■
EN 50160 compliance checking		■
Customizable data outputs (using logic and math functions)		■
<b>Data recording</b>		
Min/max of instantaneous values		■
Data logs		■
Event logs		■
Trending/forecasting		■
SER (Sequence of event recording)		■
Time stamping		■
GPS synchronization (+/- 1 ms)		■
Memory (in Mbytes)		512
<b>Display and I/O</b>		
Front panel display		■
Wiring self-test		■
Pulse output		1
Digital or analog inputs(max)		27 digital 16 analog
Digital or analog outputs (max, including pulse output)		1 digital 8 relay 8 analog
<b>Communication</b>		
RS 485 port		1
Ethernet ports		2
Serial port (Modbus, ION, DNP3)		■
Ethernet port (Modbus/TCP, ION TCP, DNP3 TCP, DHCP, DNS, IPv4, IPv6, IEC 61850)		■
Ethernet gateway		■
Alarm notification via email		■
HTTP web server with waveform viewer		■
SNMP with custom MIB and traps for alarms		■
SMTP email		■
PTP and NTP time synchronization		■
FTP File transfer		■





PM5000 Series Power Meter

### Series 5000 Power Meters

The PowerLogic PM5000 series power meters are the new benchmark in affordable, precision metering. It is the ideal fit for high-end cost management applications, providing measurement capabilities needed to allocate energy usage, perform tenant metering and sub-billing, pin-point energy savings, optimize equipment efficiency and utilization, and perform a high level assessment of the power quality in electrical networks.

All meters provide Modbus serial communications. PM5500 level meters are also capable of simultaneous Modbus TCP and BTL-certified BACnet IP communications over Ethernet.

- Panel instrumentation (OEMs)
- Sub-billing and cost allocation
- Remote monitoring of an electrical installation
- Harmonic monitoring (THD)

Table 4.9: Series 5000 Power Meters

Description	Catalog No.
Power Meter, Class 0.5 Serial Port	METSEPM5110
Meter, Class 0.5 Alarms TOU Serial Port	METSEPM5330
Power Meter, Class 0.5 Alarms TOU Ethernet Port	METSEPM5340
Power Meter Class 0.2 Serial Port and Dual Ethernet	METSEPM5560
Power Meter without Display Class 0.2 Serial Port and Dual Ethernet	METSEPM5563
Power Meter Class 0.2 Serial Port and Dual Ethernet, LVDC Control Power	METSEPM5580
Power Meter Class 0.2 Serial Port and Dual Ethernet, Waveform Capture, Sag/Swell	METSEPM5650
Remote Display for METSEPM5563	METSEPM5RD
Power Meter with Remote Display Class 0.2 Serial Port and Dual Ethernet	METSEPM5563RD <sup>[5]</sup>

### Series PM2000 Power Meters

The PM2000 series meter is a next-generation energy and power meter that offers all the measurement capabilities required to monitor an electrical installation in a single 96 x 96 mm unit. The PM2000 series offers simplicity and reliability for basic energy cost and network management applications at a value price. PM2000 meters are available in LED and LCD display variants:

- LED display type (PM2100 series): Intuitive navigation with self-guided, three buttons, bright red color LEDs of 14.2 mm height. Two columns of LEDs indicate the parameter name chosen for display.
- LCD display type (PM2200 series): Monochrome graphical LCD of 128 x 128 resolution lets users read all three phase values simultaneously. The bright display enables easy reading even in extreme lighting conditions and viewing angles with intuitive menus, multi-language text, icons and graphics.

PM2130 and PM2230 meter models have provisions to attach one input/output expansion module. Choose from: two digital inputs, two digital outputs; two analog inputs, two analog outputs; or two digital inputs, two relay outputs.



PM2100 Series LED Display Meter



PM2200 Series LCD Display Meter

Table 4.10: PM2000 Series Power Meters and Options

Description	Catalog Number
<b>Meters</b>	
PM2110, THD, LED display, Energy pulse output, Class 1	METSEPM2110
PM2120, 15th Harmonic, LED display, Modbus RS485, Class 1	METSEPM2120
PM2130, 31st Harmonic, LED display, Modbus RS485, Class 0.5S	METSEPM2130
PM2110, THD, LCD display, Energy pulse, Class 1	METSEPM2210
PM2220, 15th Harmonic, LCD display, Modbus RS485, Class 1	METSEPM2220
PM2230, 31st Harmonic, LCD display, Modbus RS485, Class 0.5S	METSEPM2230
<b>Optional Input/Output Modules</b>	
PM2X30 I/O Module - 2 Digital In, 2 Digital Out	METSEPM2KDGTLIO22
PM2X30 I/O Module - 2 Analog In, 2 Analog Out	METSEPM2KANLGIO22
PM2X30 I/O Module - 2 Digital In, 2 Relay Out	METSEPM2K2DI2RO

[5] METSEPM5563RD includes both METSEPM5563 and METSEPM5RD.



EM3500 Series Energy and Power Meter

### Series 3500 Energy and Power Meter

The EM3500 series Energy and Power Meter combines exceptional performance and easy installation to deliver a cost-effective solution for power monitoring applications. The EM3500 series can be installed on standard DIN rail or surface mounted, and has bi-directional monitoring designed expressly for renewable energy applications.

- Pulse output and phase alarms
- Data logging capability in some models
- Modbus and BACnet output options

**Table 4.11: Series 3500 Energy and Power Meters**

Description	Catalog Number
Power Meter, DIN-rail, Pulse Output Only, for LVCTs	METSEEM3502
Power Meter, DIN-rail Pulse Output Only, for METSECTR Rope CTs	METSEEM3502A
Power Meter, DIN-rail Modbus Output for LVCTs	METSEEM3550
Power Meter, DIN-rail, Modbus Output, for METSECTR Rope CTs	METSEEM3550A
Power Meter, DIN-rail Modbus Output, Bi-Directional, Logging for LVCTs	METSEEM3555
Power Meter, DIN-rail Modbus Output, Bi-Directional, Logging for METSECTR Rope CTs	METSEEM3555A
Power Meter, DIN-rail, BACnet Output, Logging for LVCTs	METSEEM3560
Power Meter, DIN-rail, BACnet Output, Logging for METSECTR Rope CTs	METSEEM3560A
Power Meter, DIN-rail, BACnet Output, for LVCTs	METSEEM3561
Power Meter, DIN-rail, BACnet Output, for METSECTR Rope CTs	METSEEM3561A

### METSECTR Series Rope-Style Current Transformers

The METSECTR series works with the EM3500A, EM4236, and iEM35xx series power and energy meters. These meters have a built in power supply and integrator, so CT connection is fast and simple. The coil opens at the connector junction for fast and easy installation onto an existing cable or bus-bar. The flexible core makes it easy to fit in tight enclosure.

- Agency Approvals cURus, ANSI/IEEE 57.13, CE, RoHS
- Accuracy ±1% from 50 A to 5000 A
- Insulation up to 600 Vac

**Table 4.12: METSECTR Series Rope-Style Current Transformers**

Description	Catalog Number
Rogowski CT, 300 mm (12"), 600 Vac, 5 kA, U018 equivalent	METSECTR30500
Rogowski CT, 460 mm (18"), 600 Vac, 5 kA, U018 equivalent	METSECTR46500
Rogowski CT, 600 mm (24"), 600 Vac, 5 kA, U018 equivalent	METSECTR60500
Rogowski CT, 900 mm (35"), 600 Vac, 5 kA, U018 equivalent	METSECTR90500

### LVCT Series Current Transformers

LVCT current transducers provide a 0.333 V output for use with EM3500, EM4236, iEM34xx, and EM4900 series energy meters. Available in both solid and split core styles.

- Solid core accuracy ±0.5 of reading from 5% to 120% of rated current
- Split core accuracy 1% from 10% to 100% of rated current
- Leads 22 AWG, 600 Vac, UL 1015 bonded pair, 6 ft. (1.8 m) standard length

**Table 4.13: LVCT Series Current Transformers**

Description	Catalog Number
<b>Split core</b>	
Low-Voltage CT, Split Core, Size 0, 50 A:0.33 V	LVCT00050S
Low-Voltage CT, Split Core, Size 1, 100 A:0.33 V	LVCT00101S
Low-Voltage CT, Split Core, Size 2, 100 A:0.33 V	LVCT00102S
Low-Voltage CT, Split Core, Size 1, 200 A:0.33 V	LVCT00201S
Low-Voltage CT, Split Core, Size 2, 200 A:0.33 V	LVCT00202S
Low-Voltage CT, Split Core, Size 2, 300 A:0.33 V	LVCT00302S
Low-Voltage CT, Split Core, Size 3, 400 A:0.33 V	LVCT00403S
Low-Voltage CT, Split Core, Size 3, 600 A:0.33 V	LVCT00603S
Low-Voltage CT, Split Core, Size 3, 800 A:0.33 V	LVCT00803S
Low-Voltage CT, Split Core, Size 4, 800 A:0.33 V	LVCT00804S
Low-Voltage CT, Split Core, Size 4, 1000 A:0.33 V	LVCT01004S
Low-Voltage CT, Split Core, Size 4, 1200 A:0.33 V	LVCT01204S
Low-Voltage CT, Split Core, Size 4, 1600 A:0.33 V	LVCT01604S
Low-Voltage CT, Split Core, Size 4, 2000 A:0.33 V	LVCT02004S
Low-Voltage CT, Split Core, Size 4, 2400 A:0.33 V	LVCT02404S
<b>Solid core</b>	
Low-Voltage CT, Solid Core, Size 0, 50 A:0.33 V	LVCT20050S
Low-Voltage CT, Solid Core, Size 0, 100 A:0.33 V	LVCT20100S
Low-Voltage CT, Solid Core, Size 2, 200 A:0.33 V	LVCT20202S
Low-Voltage CT, Solid Core, Size 3, 400 A:0.33 V	LVCT20403S



PM3000 Series Power Meter

**PowerLogic PM3000 Power and Energy Meters**

PM3000 series power meters are a cost-attractive, feature-rich range of DIN rail-mounted power meters that offers all the measurement capabilities required to monitor an electrical installation. Ideal for power metering and network monitoring applications that seek to improve the availability and reliability of your electrical distribution system, the meters are also fully capable of supporting sub billing and cost allocation applications. Four different models are available. Choose from models that provide Display Only, Display + Pulse Output, Display + Modbus, and Display + Modbus + DI/DO + Logging. All models use 1A/5A CTs.

**Table 4.14: PM3000 Features**

Available Features	PM3200 Range			
	PM3200	PM3210	PM3250	PM3255
<b>Performance Standard</b>				
IEC61557-12 PMD/Sx/K55/0.5	•	•	•	•
<b>General</b>				
Use on LV and HV systems	•	•	•	•
Number of samples per cycle	32	32	32	32
CT input 1A/5A	•	•	•	•
VT input	•	•	•	•
Multi-tariff	4	4	4	4
Multi-lingual backlit display	•	•	•	•
<b>Instantaneous rms Values</b>				
Current, voltage Per phase and average	•	•	•	•
Active, reactive, apparent power Total and per phase	•	•	•	•
Power factor Total and per phase	•	•	•	•
<b>Energy Values</b>				
Active, reactive and apparent energy; import and export	•	•	•	•
<b>Demand Values</b>				
Current, power (active, reactive, apparent) demand; present	•	•	•	•
Current, power (active, reactive, apparent) demand; peak	•	•	•	•
<b>Power Quality Measurements</b>				
THD Current and voltage		•	•	•
<b>Data Recording</b>				
Min/max of the instantaneous values	•	•	•	•
Power demand logs				•
Energy consumption log (day, week, month)				•
Alarms with time stamping		5	5	15
Digital inputs/digital outputs		0/1		2/2
<b>Communication</b>				
RS-485 port			•	•
Modbus protocol			•	•

**Table 4.15: PM3000 Series Power Meters**

Description	Catalog Number
PM3200 3PH energy meter, DIN rail mount, 1A or 5A CT, Class 0.5S, no communications	METSEPM3200
PM3210 3PH energy meter, DIN rail mount, 1A or 5A CT, Class 0.5S, pulse out, THD, one (1) DO	METSEPM3210
PM3250 3PH energy meter, DIN rail mount, 1A or 5A CT, Class 0.5S, Modbus, THD	METSEPM3250
PM3255 3PH energy meter, DIN rail mount, 1A or 5A CT, Class 0.5S, Modbus, THD, two (2) DI, two (2) DO	METSEPM3255



iEM3000 Series Energy Meter

**NOTE:**

- For meter part number replace “i” in model name with “A9M”. (Example: iEM3150 = A9MEM3150)
- DIN rail housing size is 18mm x 5 width. (iEM33xx is 18mm x 7 width.)
- Digital input is selectable for Tariff control or WAGES
- Digital output is selectable for kWh pulse or kW alarm. (iEM3x10 is kWh pulse only.)

**iEM3000 Energy Meters**

The economical iEM3000 energy meters are ideal for helping facilities become more energy efficient. These feature-rich meters reduce installation and commissioning costs thanks to their efficient design and include native support for a variety of protocols, including Modbus, BACnet, LON, and M-Bus, for seamless integration into networks. Choose from models supporting a variety of current-sensing methods, including standard 1A/5A current transformers, 0.333 V low-voltage CTs, and METSECTR Rogowski coils. There are also direct connect models with internal current sensors that save installation time. The compact size is ideal for new and retrofit installations. Whether metering for energy awareness, billing, or advanced energy programs requiring full-featured, multi-tariff energy meters, there is an iEM3000 meter that fits the application.

**Table 4.16: iEM3000 Features**

Function	Acti 9 iEM3000 Series Three-Phase Meters						
<b>Current Input / Accuracy</b>							
63A Direct / Class 1	iEM3100	iEM3110	iEM3135	iEM3150	iEM3155	iEM3165	iEM3175
1A or 5A CT / Class 0.5S	iEM3200	iEM3210	iEM3235	iEM3250	iEM3255	iEM3265	iEM3275
125A Direct / Class 1	iEM3300	iEM3310	iEM3335	iEM3350	iEM3355	iEM3365	iEM3375
0.333V or 1.0V LVCT / Class 0.5S					iEM3455	iEM3465	
Rogowski coil / Class 0.5S					iEM3555	iEM3565	
<b>Protocol</b>							
M-Bus			*				
Modbus				*	*		
BACnet						*	
LonWorks							*
<b>Measurement</b>							
MID compliant		*	*		*	*	*
4 quadrant energy			*		*	*	*
Demand					[6]	[6]	
Peak demand					[6]	[6]	
<b>Multi Tariff</b>							
Internal clock			4		4	4	4
External control			2		4	4	4
<b>Digital I/O</b>							
Number of inputs/outputs		-1	1/1		1/1	1/1	1/1

**Measurement parameters**

- Total and partial kWh shows consumption behavior
- Four-quadrant metering differentiates energy consumption
- Target green technologies (delivered/received)
- Reduce utility penalties (active/reactive)
- Additional parameters (P, Q, S, 3xI, V, PF, F) to monitor network balance and overload behavior

**Smart Alarm**

- kW overload alarm helps prevent utility demand charges

**Multiple Tariffs**

- Save up to four different time slots to manage multiple tariffs (peak/off-peak, workday/weekend)
- Control tariffs via digital inputs, internal clock, or communication

**Digital Inputs**

- Use the meter as a pulse counter for another meter (WAGES monitoring)
- Manage double-source applications (e.g., utility main plus on-site generator)
- Monitor circuit breaker status or cabinet door opening

**Digital Outputs**

- Use to trip a light or sound an alarm
- Configure as a pulse output

**Table 4.17: iEM3000 Series Energy Meters**

Description	Catalog Number
iEM3100 3PH energy meter, DIN rail mount, direct connect 63A, Class 1	A9MEM3100
iEM3110 3PH energy meter, DIN rail mount, direct connect 63A, Class 1, pulse out, MID, one (1) DO	A9MEM3110
iEM3135 3PH energy meter, DIN rail mount, direct connect 63A, Class 1, M-Bus, MID, 4-quadrant energy, one (1) DI, one (1) DO	A9MEM3135
iEM3150 3PH energy meter, DIN rail mount, direct connect 63A, Class 1, Modbus	A9MEM3150
iEM3155 3PH energy meter, DIN rail mount, direct connect 63A, Class 1, Modbus, MID, 4-quadrant energy, one (1) DI, one (1) DO	A9MEM3155
iEM3165 3PH energy meter, DIN rail mount, direct connect 63A, Class 1, BACnet, MID, 4-quadrant energy, one (1) DI, one (1) DO	A9MEM3165
iEM3175 3PH energy meter, DIN rail mount, direct connect 63A, Class 1, LON, MID, 4-quadrant energy, one (1) DI, one (1) DO	A9MEM3175
iEM3200 3PH energy meter, DIN rail mount, 1A or 5A CT, Class 0.5S	A9MEM3200
iEM3210 3PH energy meter, DIN rail mount, 1A or 5A CT, Class 0.5S, pulse out, MID, one (1) DO	A9MEM3210
iEM3235 3PH energy meter, DIN rail mount, 1A or 5A CT, Class 0.5S, M-Bus, MID, 4-quadrant energy, one (1) DI, one (1) DO	A9MEM3235
iEM3250 3PH energy meter, DIN rail mount, 1A or 5A CT, Class 0.5S, Modbus	A9MEM3250
iEM3255 3PH energy meter, DIN rail mount, 1A or 5A CT, Class 0.5S, Modbus, MID, 4-quadrant energy, one (1) DI, one (1) DO	A9MEM3255
iEM3265 3PH energy meter, DIN rail mount, 1A or 5A CT, Class 0.5S, BACnet, MID, 4-quadrant energy, one (1) DI, one (1) DO	A9MEM3265
iEM3275 3PH energy meter, DIN rail mount, 1A or 5A CT, Class 0.5S, LON, MID, 4-quadrant energy, one (1) DI, one (1) DO	A9MEM3275
iEM3300 3PH energy meter, DIN rail mount, direct connect 125A, Class 1	A9MEM3300
iEM3310 3PH energy meter, DIN rail mount, direct connect 125A, Class 1, pulse out, MID, one (1) DO	A9MEM3310
iEM3335 3PH energy meter, DIN rail mount, direct connect 125A, Class 1, M-Bus, MID, 4-quadrant energy, one (1) DI, one (1) DO	A9MEM3335
iEM3350 3PH energy meter, DIN rail mount, direct connect 125A, Class 1, Modbus	A9MEM3350
iEM3355 3PH energy meter, DIN rail mount, direct connect 125A, Class 1, Modbus, MID, 4-quadrant energy, one (1) DI, one (1) DO	A9MEM3355
iEM3365 3PH energy meter, DIN rail mount, direct connect 125A, Class 1, BACnet, MID, 4-quadrant energy, one (1) DI, one (1) DO	A9MEM3365
iEM3375 3PH energy meter, DIN rail mount, direct connect 125A, Class 1, LON, MID, 4-quadrant energy, one (1) DI, one (1) DO	A9MEM3375
iEM3455 3PH energy meter, DIN rail mount, LVCT, Class 0.5S, Modbus, MID, 4-quadrant energy, one (1) DI, one (1) DO	A9MEM3455
iEM3465 3PH energy meter, DIN rail mount, LVCT, Class 0.5S, BACnet, MID, 4-quadrant energy, one (1) DI, one (1) DO	A9MEM3465
iEM3555 3PH energy meter, DIN rail mount, Rogowski coil, Class 0.5S, Modbus, MID, 4-quadrant energy, one (1) DI, one (1) DO	A9MEM3555
iEM3565 3PH energy meter, DIN rail mount, Rogowski coil, Class 0.5S, BACnet, MID, 4-quadrant energy, one (1) DI, one (1) DO	A9MEM3565

[6] Available on iEM3455, iEM3465, iEM3555, iEM3565 models only

**Multiple Meter Unit Enclosures for iEM3000 Energy Meters**

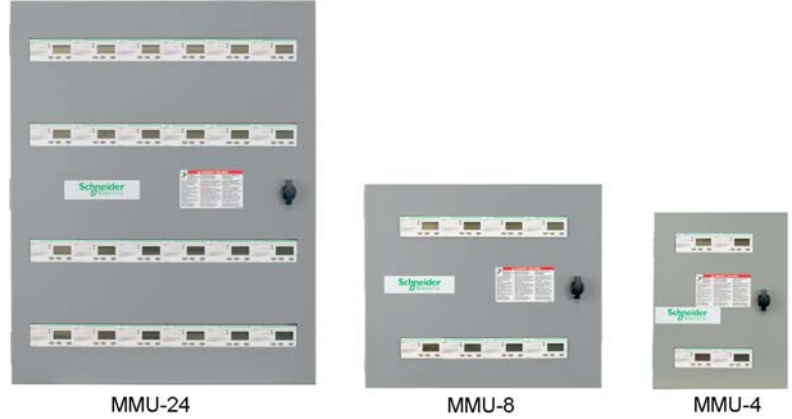

Schneider Electric's Multi-Meter Unit (MMU) enclosures are the ideal complement for the iEM3000 Series of energy meters. This compact solution saves wall space and is scalable for the exact number of meters required. Factory-assembled, pre-wired, and tested enclosures can speed installation, reduce the amount of field wiring, and save time troubleshooting.

Multi-meter unit enclosures and iEM3000 meters provide the highest quality, best value hardware for tenant sub-metering, and are designed for contractor convenience and simplicity.

MMU enclosures are available in three sizes:

- Small MMU enclosures with capacity for up to 4 iEM3000 meters.
- Medium size MMU enclosures with capacity for up to 8 iEM3000 meters, plus one gateway/data logger/energy server.
- Extra-large MMU enclosures with capacity for up to 24 iEM3000 meters, plus one gateway/ data logger/energy server.

Multi meter units are configured to order as described below.

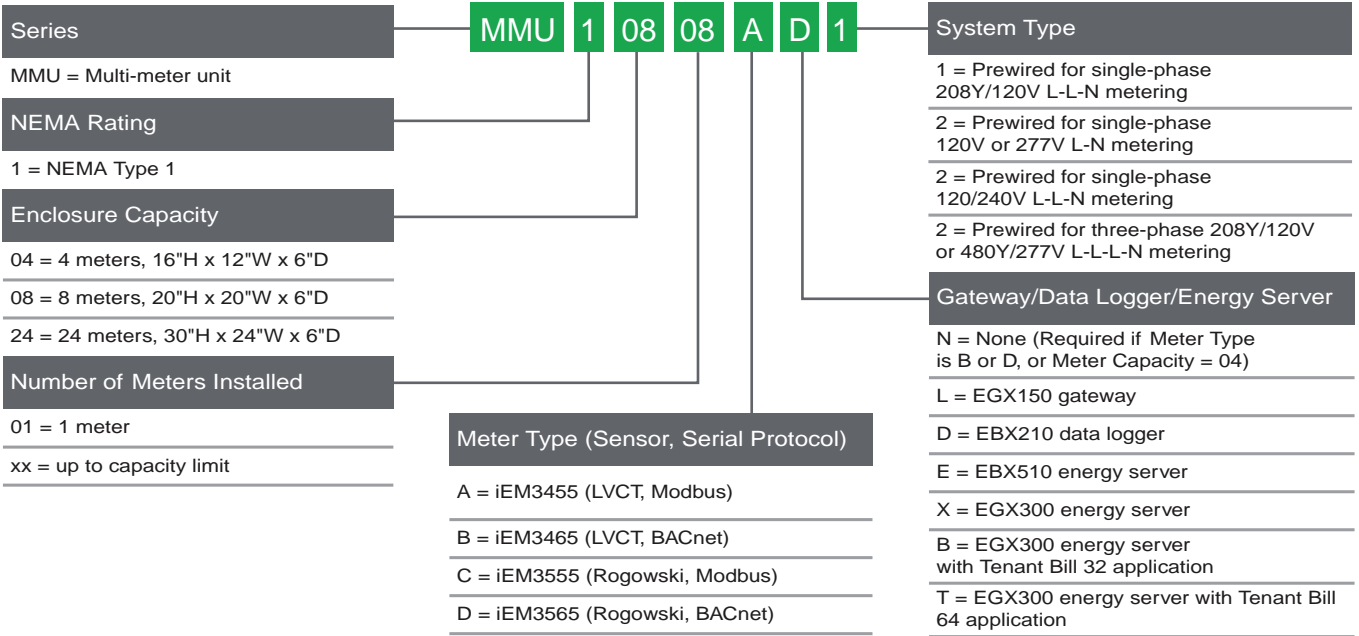

**Power and Energy Meter Selection**

Features [7]	PM5600	PM5500	PM5340	PM5330	PM5110	PM2x30	PM2x20	PM2x10	EM3500	PM3000	IEM3000
<b>Inputs, outputs and control power</b>											
3-phase / single-phase	*/*	*/*	*/*	*/*	*/*	*/*	*/*	*/*	*/*	*/*	*/*
Digital in and out / analog in and out	6 / 0	6 / 0	4 / 0	4 / 0	1 / 0	option	option	option	2 or 3 / 0	up to 2/2	up to 1/1
Power supply options	AC/DC	AC/DC/ LVDC	AC/DC	AC/DC	AC/DC	AC/DC	AC/DC	AC/DC	AC/DC	AC/DC	AC
<b>Power and energy measurements</b>											
Voltage, current, frequency, power factor	*	*	*	*	*	*	*	*	*	*	*
Power / Demand	*/*	*/*	*/*	*/*	*/*	*/*	*/*	*/*	*/*	*/*	*/-
Energy / time-of-use (energy per shift)	*/*	*/*	*/*	*/*	*/-	*/*	*/*	*/*	-/-	*/*	*/*
IEC / ANSI energy accuracy class (% of reading)	0.2	0.2	0.5	0.5	0.5	0.5	1.0	1.0	0.2	0.5	0.5
Loss compensation	-	-	-	-	-	-	-	-	-	-	-
<b>Power quality analysis</b>											
EN50160 compliance reporting / IEC 61000-4-30 Class A or S	-/-	-/-	-/-	-/-	-/-	-/-	-/-	-/-	-/-	-/-	-/-
Flicker measurement	-	-	-	-	-	-	-	-	-	-	-
Transient detection duration	-	-	-	-	-	-	-	-	-	-	-
Sag and swell monitoring / disturbance direction detection	*/-	-/-	-/-	-/-	-/-	-/-	-/-	-/-	-/-	-/-	-/-
Harmonic distortion: total/ individual / inter	*/*/-	*/*/-	*/*/-	*/*/-	*/*/-	*/*/-	*/*/-	*/*/-	-/-/-	*/*/-	-/-/-
Waveform capture	yes	-	-	-	-	-	-	-	-	-	-
<b>On-board data and event logging</b>											
Trending / forecasting / billing	-/-/-	-/-/-	-/-/-	-/-/-	-/-/-	-/-/-	-/-/-	-/-/-	-/-/-	-/-/-	-/-/-
Minimum and maximum	*	*	*	*	*	*	*	*	*	*	*
Events and alarms with timestamps	*	*	*	*	*	*	*	*	*	*	*
Timestamp resolution (seconds)	1	1	1	1	1	1	1	1	1	1	1
Time sync: Network / GPS / IIRIG-B / DCF77-B	-/-/-/-	-/-/-/-	-/-/-/-	-/-/-/-	-/-/-/-	-/-/-/-	-/-/-/-	-/-/-/-	-/-/-/-	-/-/-/-	-/-/-/-
<b>Setpoints, alarms and control</b>											
Log alarm conditions / call out on alarm	*/*	*/*	*/*	*/-	*/-	*/-	*/-	*/-	-/-	*/-	-/-
Trigger data logging / waveform capture	-/-	-/-	-/-	-/-	-/-	-/-	-/-	-/-	-/-	-/-	-/-
Trigger relay or digital output	*	*	*	*	*	*	*	*	*	*	*
<b>Special features</b>											
Custom programming	-	-	-	-	-	-	-	-	-	-	-
Downloadable firmware	*	*	*	*	*	*	*	*	*	*	*
<b>Communications</b>											
<b>Ports:</b>											
Ethernet: Copper / Fiber	2/-	2/-	1/-	-/-	-/-	-/-	-/-	-/-	-/-	-/-	-/-
Ethernet-to-serial gateway	*	*	-	-	-	-	-	-	-	-	-
Telephone modem	-	-	-	-	-	-	-	-	-	-	-
Modem-to-serial gateway	-	-	-	-	-	-	-	-	-	-	-
Infrared port	-	-	-	-	-	-	-	-	-	-	-
RS485/RS232	*/-	*/-	-/-	*/-	*/-	*/-	*/-	*/-	*/-	*/-	*/-
Misc: Web server / Email / SNMP / XML	*/*/*/-	*/*/*/-	-/-/-/-	-/-/-/-	-/-/-/-	-/-/-/-	-/-/-/-	-/-/-/-	-/-/-/-	-/-/-/-	-/-/-/-
Protocols: Modbus / DNP / MV-90 / DLMS	*/-/-/-	*/-/-/-	*/-/-/-	*/-/-/-	*/-/-/-	*/-/-/-	*/-/-/-	*/-/-/-	*/-/-/-	*/-/-/-	*/-/-/-
Protocols: IEC61850 / Jbus / M-Bus / LON / BACnet	-/-/-/-/*	-/-/-/-/*	-/-/-/-/*	-/-/-/-/-	-/-/-/-/-	-/-/-/-/-	-/-/-/-/-	-/-/-/-/-	-/-/-/-/*	-/-/-/-/-	-/-/*/*/*/*

4

POWER MONITORING AND CONTROL

[7] Specifications represent maximum capabilities with all options installed. Some options are not available concurrently. This is not a complete feature list, please refer to detailed product specifications.



Energy Meter

### PowerLogic Energy Meter

The Energy Meter is ideal for stand-alone and systems-based submetering applications. It is easy to install and provides exceptional metering accuracy. Available in Basic and Extended Range models. The Basic model is designed for metering of 120/240 and 208Y/120 volt services. The Extended Range model will meter 120/240 volt up to 480 volt Wye connected services. Extended Range meters come with pulse output and phase loss output not available on the Basic unit. Optional Modbus™ RS-485 serial communications are provided with the Energy Meter Comms Board, EMCB. Optional kW demand is also provided by the EMCB.

Meter up to 3 individual services with one Energy Meter. The Energy Meter will allow the addition of up to 3 sets of parallel CTs for metering multiple electric loads. Additional sets of CTs can be ordered separately. Please refer to the multiple CT application notes in the Energy Meter instruction bulletin for the proper installation procedures.

Table 4.18: Extended Range 120/240 V to 480Y/277 V

Description	Catalog No.
Extended Range 100 A, .518"x1.28" ID, 1 CT	EME1010
Extended Range 200 A, 0.75" x 1.10" ID, 1 CT	EME1021
Extended Range 300 A, .90"x1.90" ID, 1 CT	EME1032
Extended Range 100 A, n.518"x1.28" ID, 2 CTs	EME2010
Extended Range 200 A, 0.75" x 1.10" ID, 2 CTs	EME2021
Extended Range 300 A, .90"x1.90" ID, 2 CTs	EME2032
Extended Range 400 A, 2.45"x2.89" ID, 2 CTs	EME2043
Extended Range 800 A, 2.45"x2.89" ID, 2 CTs	EME2083
Extended Range 100 A, .518"x1.28" ID, 3 CTs	EME3010
Extended Range 200 A, 0.75" x 1.10" ID, 3 CTs	EME3021
Extended Range 300 A, .90"x1.90" ID, 3 CTs	EME3032
Extended Range 400 A, 2.45"x2.89" ID, 3 CTs	EME3043
Extended Range 800 A, 2.45"x2.89" ID, 3 CTs	EME3083
Extended Range 800 A, 2.45"x5.50" ID, 3 CTs	EME3084
Extended Range 1600 A, 2.45"x5.50" ID, 3 CTs	EME3164

Table 4.19: Energy Meter Accessories

Description	Catalog No.
Energy Meter Communication Board [8]	EMCB
Energy Meter Fuse Pack, Set of 1	EMFP1
Energy Meter Fuse Pack, Set of 2	EMFP2
Energy Meter Fuse Pack, Set of 3	EMFP3
Energy Meter Bonding Kit	EMBOND

Table 4.20: Additional CT Sets

Description	Catalog No.
100 A, .518" x 1.28" ID, 1 CT	EMCT010
200 A, 0.75" x 1.10" ID, 1 CT	EMCT021
300 A, .90" x 1.90" ID, 1 CT	EMCT032
400 A, 2.45" x 2.89" ID, 1 CT	EMCT043
800 A, 2.45" x 2.89" ID, 1 CT	EMCT083
800 A, 2.45" x 5.50" ID, 1 CT	EMCT084
1600 A, 2.45" x 5.50" ID, 1 CT	EMCT164

**NOTE:** CT quantity and amperage must match meter model. Total of combined loads must not exceed rating of meter. All additional CTs shipped with 6 ft. white and black color-coded wire leads.

### PowerLogic EM4200 Enercept Meter

Next generation Enercept meters provide a unique solution for measuring energy data. The small form factor enables retrofit installation in existing panels to save wall space, installation time, and material cost.

Designed to simplify the ordering process, the meter is available in two major options:

- **System calibrated Enercept** offers the simplest way to order. The meter comes with pre-mounted low voltage (LVCT) or Rogowski coil current transducers, as well as pre-mounted fuse packs. Ordering one part number provides a system calibrated 1% overall accuracy metering system for 100 A, 200 A, 400 A, or 5,000 A range applications.
- **Enercept Flex** offers the flexibility required for many sites where selecting the type and size of current transducer is desired. The Enercept Flex is compatible with the current transducers on . Choose split core or solid core LVCTs from [Table 4.13 LVCT Series Current Transformers, page 4-16](#), or rope style current transducers from [Table 4.12 METSECTR Series Rope-Style Current Transformers, page 4-16](#). Choose fuse packs from [Table 4.19 Energy Meter Accessories, page 4-21](#).

#### Features

- Uni- and bi-directional metering to support to power generation application
- Data logging
- Modbus and BACnet serial communication with auto-protocol and baud rate detection.
- Configurable with or without power
- Compact size for easy in-panel mounting, DIN rail or screw mount options, includes mounting brackets for easy installation
- Seamless integration with EcoStruxure™ Power Management software products.
- Wide 90 to 480 Vac input range
- High reliability with ANSI C12.20 0.2% accuracy, IEC 62053-22 Class 0.2S (EM4236)



EM4200 Flex Power Meter



EM4200 System Calibrated with Calibrated Rogowski Coils

[8] Energy Meter communication board (EMCB) can be used with all models of the Energy Meter. Order one EMCB for each Energy Meter where either kW demand and/or communication is specified.

**Table 4.21: EM4200 Enercept Meter**

Description	Catalog Number
Enercept Flex power meter, Class 0.2S, Modbus/BACnet RS485, ANSI wire code, compatible with LVCT and Rogowski coils, order current transducers and fuse packs separately	METSEEM4236
System calibrated Enercept power meter, Modbus/BACnet RS485, ANSI wire code, includes 12-inch length Rogowski coil current transducers for up to 5,000 A and fuse packs	METSEEM4236A12
System calibrated Enercept power meter, Modbus/BACnet RS485, ANSI wire code, includes 18-inch length Rogowski coil current transducers for up to 5,000 A and fuse packs	METSEEM4236A18
System calibrated Enercept power meter, Modbus/BACnet RS485, ANSI wire code, includes LVCT current transducers for up to 100 A and fuse packs	METSEEM4236B101
System calibrated Enercept power meter, Modbus/BACnet RS485, ANSI wire code, includes LVCT current transducers for up to 200 A and fuse packs	METSEEM4236B201
System calibrated Enercept power meter, Modbus/BACnet RS485, ANSI wire code, includes LVCT current transducers for up to 400 A and fuse packs	METSEEM4236B401

**Multi Circuit Energy Meters**

The PowerLogic EM4800 and EM4000 multi-circuit energy meters combine accurate electricity sub-metering with advanced communications technology. They are ideal for multi-tenant or departmental metering and M&V applications within office towers, condominiums, apartment buildings, shopping centers and other multipoint environments, or small footprint retail. This meter is available separately or as part of a Square D integrated power center (IPC) for use in building retrofits or new construction.

Each compact multipoint meter provides energy measurement for up to 24 (1CT) or 12 (2CT) single-phase circuits or 8 (3CT) 3-phase circuits. Select a model to match the desired CT type. The 0.333 V output CT option does not require shorting blocks, making it the ideal choice for retrofit installations.

All meters have an accuracy of Class 0.5%, have onboard interval logging, and feature flexible communication options with an Ethernet port that supports multiple protocols: Modbus TCP/IP, HTTP, BACnet/IP, FTP, and SNMP. EM4800 series meters have a V.90 modem while EM4000 series meters provide Modbus RTU over RS-485.

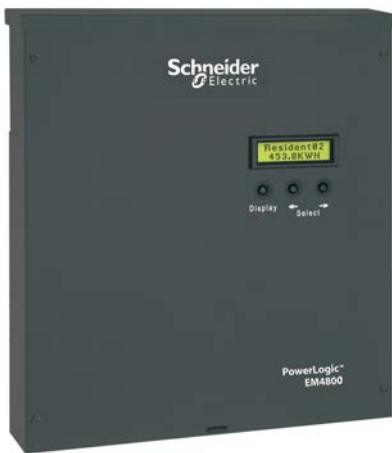

**Table 4.22: Multi Circuit Energy Meters**

Description	Catalog No.
EM4800 series; Ethernet; modem; compatible with 80mA low-power CTs; 120V control power 60 Hz	METSEEM488016
EM4800 series; Ethernet; modem; compatible with 333mV low-power CTs; 120V control power 60 Hz	METSEEM483316
EM4800 series; Ethernet; modem; compatible with standard 5A CTs; 120V control power 60 Hz	METSEEM480516
EM4000 series; Ethernet; Modbus RTU over RS-485; compatible with 80mA low-power CTs; 120V control power 60 Hz	METSEEM408016
EM4000 series; Ethernet; Modbus RTU over RS-485; compatible with 80mA low-power CTs; 277V control power 60 Hz	METSEEM408036
EM4000 series; Ethernet; Modbus RTU over RS-485; compatible with 333mV low-power CTs; 120V control power 60 Hz	METSEEM403316
EM4000 series; Ethernet; Modbus RTU over RS-485; compatible with 333mV low-power CTs; 277V control power 60 Hz	METSEEM403336
200 A current transformer (CT), 80 mA secondary, solid-core (1 CT)	METSECT80200
400 A current transformer (CT), 80 mA secondary, solid-core (1 CT)	METSECT80400
600 A current transformer (CT), 80 mA secondary, solid-core (1 CT)	METSECT80600
50 A .333 V Split Core Current Transformer with 0.75 in Window Size	ECT075050SC
100 A .333 V Split Core Current Transformer with 0.75 in Window Size	ECT075100SC
150 A .333 V Split Core Current Transformer with 0.75 in Window Size	ECT075150SC
200 A .333 V Split Core Current Transformer with 0.75 in Window Size	ECT075200SC
100 A .333 V Split Core Current Transformer with 1.25 in Window Size	ECT125100SC
150 A .333 V Split Core Current Transformer with 1.25 in Window Size	ECT125150SC
200 A .333 V Split Core Current Transformer with 1.25 in Window Size	ECT125200SC
400 A .333 V Split Core Current Transformer with 1.25 in Window Size	ECT125400SC
200 A .333 V Split Core Current Transformer with 2.00 in Window Size	ECT200200SC
400 A .333 V Split Core Current Transformer with 2.00 in Window Size	ECT200400SC
600 A .333 V Split Core Current Transformer with 2.00 in Window Size	ECT200600SC
600 A .333 V Split Core Current Transformer with 3 x 5 in Window Size	ECT300600SC
800 A .333 V Split Core Current Transformer with 3 x 5 in Window Size	ECT300800SC





### PowerLogic Branch Circuit Power Meter

The ideal solution for data center managers, energy or facility managers, engineers and operational executives who are responsible for delivering power to critical applications. In corporate and hosted data center facilities, this technology helps you plan and optimize the critical power infrastructure to meet the demands of continuous availability.

The PowerLogic BCPM is a highly accurate, full-featured metering product designed for the unique, multi-circuit and minimal space requirements of a high performance power distribution unit (PDU) or remote power panel (RPP). It offers class 1 (1%) power and energy system accuracy (including 50 A or 100 A CTs) on all branch channels.

The BCPM monitors up to 84 branch circuits with a single device and also monitors the incoming power mains to provide information on a complete PDU. It also offers multi-phase measurement totals with flexible support for any configuration of multi-phase breakers. Full alarming capabilities ensure that potential issues are dealt with before they become problems.

Unlike products designed for specific hardware, the flexible BCPM will fit any PDU or RPP design and supports both new and retrofit installations. It has exceptional dynamic range and accuracy, and optional feature sets to meet the energy challenges of mission critical data centers.

#### Key Features:

- Integrated Ethernet with advanced SNMP, BACnet, and Modbus TCP support on BCPME models
- Class 1% system accuracy (including 50 A or 100 A branch CTs)
- Flexible configuration of Logical Meters for multi-phase loads
- Full PDU monitoring
- Flexible configuration
- Split core version for retrofit installations
- Wide monitoring range
- Low current monitoring
- Advanced alarming
- Easily integrates into a PowerLogic system or other existing networks using Modbus™ communications



Table 4.23: BCPM with Solid-Core CTs

Description	Catalog Number
42-circuit solid-core power & energy meter, 100 A CTs (2 strips), ¼ in. spacing	BCPMA042S
84-circuit solid-core power & energy meter, 100 A CTs (4 strips), ¼ in. spacing	BCPMA084S
42-circuit solid-core power & energy meter, 100 A CTs (2 strips), 1 in. spacing	BCPMA142S
84-circuit solid-core power & energy meter, 100 A CTs (4 strips), 1 in. spacing	BCPMA184S
24-circuit solid-core power & energy meter, 100 A CTs (2 strips), 18 mm spacing	BCPMA224S
36-circuit solid-core power & energy meter, 100 A CTs (2 strips), 18 mm spacing	BCPMA236S
42-circuit solid-core power & energy meter, 100 A CTs (2 strips), 18 mm spacing	BCPMA242S
48-circuit solid-core power & energy meter, 100 A CTs (4 strips), 18 mm spacing	BCPMA248S
72-circuit solid-core power & energy meter, 100 A CTs (4 strips), 18 mm spacing	BCPMA272S
84-circuit solid-core power & energy meter, 100 A CTs (4 strips), 18 mm spacing	BCPMA284S
42-circuit solid-core branch current, mains power meter, 100 A CTs (2 strips), ¼ in. spacing	BCPMB042S
84-circuit solid-core branch current, mains power meter, 100 A CTs (4 strips), ¼ in. spacing	BCPMB084S
42-circuit solid-core branch current, mains power meter, 100 A CTs (2 strips), 1 in. spacing	BCPMB142S
84-circuit solid-core branch current, mains power meter, 100 A CTs (4 strips), 1 in. spacing	BCPMB184S
24-circuit solid-core branch current, mains power meter, 100 A CTs (2 strips), 18 mm spacing	BCPMB224S
36-circuit solid-core branch current, mains power meter, 100 A CTs (2 strips), 18 mm spacing	BCPMB236S
42-circuit solid-core branch current, mains power meter, 100 A CTs (2 strips), 18 mm spacing	BCPMB242S
48-circuit solid-core branch current, mains power meter, 100 A CTs (4 strips), 18 mm spacing	BCPMB248S
72-circuit solid-core branch current, mains power meter, 100 A CTs (4 strips), 18 mm spacing	BCPMB272S
84-circuit solid-core branch current, mains power meter, 100 A CTs (4 strips), 18 mm spacing	BCPMB284S
42-circuit solid-core branch current meter, 100 A CTs (2 strips), ¼ in. spacing	BCPMC042S
84-circuit solid-core branch current meter, 100 A CTs (4 strips), ¼ in. spacing	BCPMC084S
42-circuit solid-core branch current meter, 100 A CTs (2 strips), 1 in. spacing	BCPMC142S
84-circuit solid-core branch current meter, 100 A CTs (4 strips), 1 in. spacing	BCPMC184S
24-circuit solid-core branch current meter, 100 A CTs (2 strips), 18 mm spacing	BCPMC224S
36-circuit solid-core branch current meter, 100 A CTs (2 strips), 18 mm spacing	BCPMC236S
42-circuit solid-core branch current meter, 100 A CTs (2 strips), 18 mm spacing	BCPMC242S
48-circuit solid-core branch current meter, 100 A CTs (4 strips), 18 mm spacing	BCPMC248S
72-circuit solid-core branch current meter, 100 A CTs (4 strips), 18 mm spacing	BCPMC272S
84-circuit solid-core branch current meter, 100 A CTs (4 strips), 18 mm spacing	BCPMC284S
42-circuit solid-core power & energy meter w/ Ethernet, 100 A CTs (2 strips), ¼ in. spacing	BCPME042S
84-circuit solid-core power & energy meter w/ Ethernet, 100 A CTs (4 strips), ¼ in. spacing	BCPME084S
42-circuit solid-core power & energy meter w/ Ethernet, 100 A CTs (2 strips), 1 in. spacing	BCPME142S
84-circuit solid-core power & energy meter w/ Ethernet, 100 A CTs (4 strips), 1 in. mm spacing	BCPME184S
24-circuit solid-core power & energy meter w/ Ethernet, 100 A CTs (2 strips), 18 mm spacing	BCPME224S
36-circuit solid-core power & energy meter w/ Ethernet, 100 A CTs (2 strips), 18 mm spacing	BCPME236S
42-circuit solid-core power & energy meter w/ Ethernet, 100 A CTs (2 strips), 18 mm spacing	BCPME242S
48-circuit solid-core power & energy meter w/ Ethernet, 100 A CTs (4 strips), 18 mm spacing	BCPME248S
72-circuit solid-core power & energy meter w/ Ethernet, 100 A CTs (4 strips), 18 mm spacing	BCPME272S
84-circuit solid-core power & energy meter w/ Ethernet, 100 A CTs (4 strips), 18 mm spacing	BCPME284S

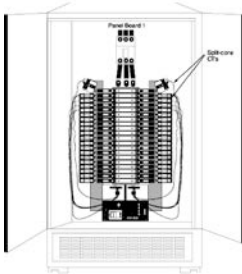

Typical BCPMSC panelboard installation

Table 4.24: BCPM with Split-Core CTs

Description	Catalog Number
42-circuit split-core power and energy meter, CTs and cables sold separately	BCPMSCA1S
84-circuit split-core power and energy meter, CTs and cables sold separately	BCPMSCA2S
30-circuit split-core power and energy meter, (30) 50 A CTs & (2) 4 ft. cables	BCPMSCA30S
42-circuit split-core power and energy meter, (42) 50 A CTs & (2) 4 ft. cables	BCPMSCA42S
60-circuit split-core power and energy meter, (60) 50 A CTs & (4) 4 ft. cables	BCPMSCA60S
42-circuit split-core power and energy meter, all boards on backplate, CTs and cables sold separately	BCPMSCAY63S
84-circuit split-core power and energy meter, with (84) 50 A CTs & (4) 4 ft. cables	BCPMSCA84S
42-circuit split-core branch current, mains power meter, CTs and cables sold separately	BCPMSCB1S
84-circuit split-core branch current, mains power meter, CTs and cables sold separately	BCPMSCB2S
30-circuit split-core branch current, mains power meter, (30) 50 A CTs & (2) 4 ft. cables	BCPMSCB30S
42-circuit split-core branch current, mains power meter, (42) 50 A CTs & (2) 4 ft. cables	BCPMSCB42S
60-circuit split-core branch current, mains power meter, (60) 50 A CTs & (4) 4 ft. cables	BCPMSCB60S
42-circuit split-core branch current, mains, all boards on backplate, CTs and cables sold separately	BCPMSCBY63S
84-circuit split-core branch current, mains power meter, (84) 50 A CTs & (4) 4 ft. cables	BCPMSCB84S
42-circuit split-core current meter, CTs and cables sold separately	BCPMSCC1S
84-circuit split-core current meter, CTs and cables sold separately	BCPMSCC2S
30-circuit split-core current meter, (30) 50 A CTs & (2) 4 ft. cables	BCPMSCC30S
42-circuit split-core current meter, (42) 50 A CTs & (2) 4 ft. cables	BCPMSCC42S
60-circuit split-core current meter, (60) 50 A CTs & (4) 4 ft. cables	BCPMSCC60S
42-circuit split-core current meter, all boards on backplate, CTs and cables sold separately	BCPMSCCY63S
84-circuit split-core current meter, (84) 50 A CTs & (4) 4 ft. cables	BCPMSCC84S
42-circuit split-core power and energy meter w/ Ethernet, CTs and cables sold separately	BCPMSCCE1S
84-circuit split-core power and energy meter w/ Ethernet, CTs and cables sold separately	BCPMSCCE2S
30-circuit split-core power and energy meter w/ Ethernet, (30) 50 A CTs & (2) 4 ft. cables	BCPMSCCE30S
42-circuit split-core power and energy meter w/ Ethernet, (42) 50 A CTs & (2) 4 ft. cables	BCPMSCCE42S
60-circuit split-core power and energy meter w/ Ethernet, (60) 50 A CTs & (4) 4 ft. cables	BCPMSCCE60S
84-circuit split-core power and energy meter w/ Ethernet, (84) 50 A CTs & (4) 4 ft. cables	BCPMSCCE84S

Table 4.25: 1/3 V Low-Voltage Split-Core CTs for Aux Inputs (Mains)

Amperage Rating	Inside Dimensions	Catalog Number
50 A	10 x 11 mm	LVCT00050S
200 A	16 x 20 mm	LVCT00101S
200 A	32 x 32 mm	LVCT00202S
100 A	30 x 31 mm	LVCT00102S
200 A	30 x 31 mm	LVCT00202S
300 A	30 x 31 mm	LVCT00302S
400 A	62 x 73 mm	LVCT00403S
600 A	62 x 73 mm	LVCT00603S
800 A	62 x 73 mm	LVCT00803S
800 A	62 x 139 mm	LVCT00804S
1000 A	62 x 139 mm	LVCT01004S
1200 A	62 x 139 mm	LVCT01204S
1600 A	62 x 139 mm	LVCT01604S
2000 A	62 x 139 mm	LVCT02004S
2400 A	62 x 139 mm	LVCT02404S

Table 4.26: 1/3 V Low-Voltage Solid-Core CTs for Aux Inputs (Mains)

Amperage Rating	Inside Dimensions	Catalog Number
50 A	10 mm	LVCT20050S
100 A	10 mm	LVCT20100S
200 A	25 mm	LVCT20202S
400 A	31 mm	LVCT20403S

Table 4.27: BCPM Split-Core Branch CTs and Adapter Boards

Description	Catalog Number
BCPM adapter boards, quantity 2, for split core BCPM	BCPMSCADPBS
BCPM 50 A split core CTs, Quantity 6, 1.8 m lead lengths	BCPMSCCT0
BCPM 50 A split core CTs, quantity 6, 6 m lead lengths	BCPMSCCT0R20
BCPM 100 A split core CTs, Quantity 6, 1.8 m lead lengths	BCPMSCCT1
BCPM 100 A split core CTs, Quantity 6, 6 m lead lengths	BCPMSCCT1R20
BCPM 200 A split core CTs, Quantity 1, 1.8 m lead lengths	BCPMSCCT3
BCPM 200 A split core CTs, Quantity 1, 6 m lead lengths	BCPMSCCT3R20

Table 4.28: Additional Accessories for use with BCPM Products

Description	Catalog Number
BCPM circuit board cover	BCPMCOVERS
CT repair kit for solid core BCPM (includes one CT)	BCPMREPAIR
Additional 100 A split core CT for use with solid core repair kit	H6803R-0100
Modbus to BACnet protocol converter	E8951
Flat Ribbon cable (quantity 1) for BCPM, length = 0.45 m	CBL008
Flat Ribbon cable (quantity 1) for BCPM, length = 1.2 m	CBL016
Flat Ribbon cable (quantity 1) for BCPM, length = 1.5 m	CBL017
Flat Ribbon cable (quantity 1) for BCPM, length = 1.8 m	CBL018
Flat Ribbon cable (quantity 1) for BCPM, length = 2.4 m	CBL019
Flat Ribbon cable (quantity 1) for BCPM, length = 3.0 m	CBL020
Flat Ribbon cable (quantity 1) for BCPM, length = 6.1 m	CBL021
Round Ribbon cable (quantity 1) for BCPM, length = 0.5 m	CBL031
Round Ribbon cable (quantity 1) for BCPM, length = 1.2 m	CBL022
Round Ribbon cable (quantity 1) for BCPM, length = 2.4 m	CBL033
Round Ribbon cable (quantity 1) for BCPM, length = 3 m	CBL023
Round Ribbon cable (quantity 1) for BCPM, length = 6.1 m	CBL024

*New!*

**PowerLogic EM4900 Series Multi-Circuit Meters**

The PowerLogic EM4900 Series Multi-Circuit Meters make it easy to add many metering points without having to purchase, mount, wire and commission individual energy meters. Simply add a single device with common voltage inputs and communication interface that can measure the current, voltage, power, energy consumption, and Total harmonic Distortion (THD) of up to (14) 3-phase circuits with a single board or up to (28) 3-phase circuits with a two board configuration. Save on both equipment cost and installation.

**Applications**

- Commercial and residential subtenant billing
- Load-based cost allocation
- Measuring for load balancing and demand response
- Overload protection



EM49xxE Main Unit

**Table 4.29: EM4900 Series Part Numbers - BCPM with Solid Core CTs**

Item	Code	Description
1 Model	METSEEM49	Multi-Circuit Meter
2 Number of 3-phase Meters	04	Up to (4) 3-phase Meters (see Table 4.31 for variations)
	08	Up to (8) 3-phase Meters (see Table 4.31 for variations)
	14	Up to (14) 3-phase Meters (see Table 4.31 for variations)
	28	Up to (28) 3-phase Meters (see Table 4.31 for variations)
3 Communication Interfaces & Protocols	A	RS-485 Serial with Modbus RTU (add E8951 for other protocols)
	E	Ethernet with Modbus TCP, BACnet IP and SNMP protocols and RS-485 Serial with Modbus RTU or BACnet IP

**Table 4.30: Part Number Example**

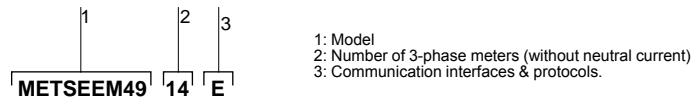

**Number of Meters Supported**

EM4900 models are all factory-configured as all 3-phase meters (w/o neutral). They can be easily re-configured to any combination of 1-ph, 2-ph, or 3-ph meters (with ION setup). Any unused channels can be used to measure neutral current. Label overlays (to re-number CT connections) are provided for 1-ph/2-ph applications.

**Table 4.31: Number of Meters**

Catalog No.	"E" - Integrated Ethernet	3 PH No Neutral	3 PH With Neutral	2 PH	1 PH
METSEEM4904A	METSEEM4904E	4	3	6	12
METSEEM4908A	METSEEM4908E	8	6	12	24
METSEEM4914A	METSEEM4914E	14	10	21	42
METSEEM4928A	METSEEM4928E	28	21	42	84

**Table 4.32: EM4900 Multi-Circuit Meters**

Catalog No.	EM4900 Multi-Circuit Meters
METSEEM4904A	Multi-Circuit Meter – (4) 3-phase meters - Modbus RTU only
METSEEM4908A	Multi-Circuit Meter – (8) 3-phase meters - Modbus RTU only
METSEEM4914A	Multi-Circuit Meter – (14) 3-phase meters - Modbus RTU only
METSEEM4928A	Multi-Circuit Meter – (28) 3-phase meters - Modbus RTU only
METSEEM4904E	Multi-Circuit Meter – (4) 3-phase meters - Ethernet and Serial (Modbus, BACnet & SNMP)
METSEEM4908E	Multi-Circuit Meter – (8) 3-phase meters - Ethernet and Serial (Modbus, BACnet & SNMP)
METSEEM4914E	Multi-Circuit Meter – (14) 3-phase meters - Ethernet and Serial (Modbus, BACnet & SNMP)
METSEEM4928E	Multi-Circuit Meter – (28) 3-phase meters - Ethernet and Serial (Modbus, BACnet & SNMP)

**Table 4.33: EM4900 Multi-Circuit Meters**

Catalog No.	Description
BCPMCOVERS	EM4900 circuit board cover
E8951	Modbus to BACnet protocol converter
<b>Ribbon cables for 28-meter models</b>	
1.22 m cables are standard – others must be ordered separately	
CBL008	Flat Ribbon cable (quantity 1) for BCPM, length = 0.45 m
CBL016	Flat Ribbon cable (quantity 1) for BCPM, length = 1.2 m
CBL017	Flat Ribbon cable (quantity 1) for BCPM, length = 1.5 m
CBL018	Flat Ribbon cable (quantity 1) for BCPM, length = 1.8 m
CBL019	Flat Ribbon cable (quantity 1) for BCPM, length = 2.4 m
CBL020	Flat Ribbon cable (quantity 1) for BCPM, length = 3.0 m
CBL021	Flat Ribbon cable (quantity 1) for BCPM, length = 6.1 m
CBL022	Round Ribbon cable (quantity 1) for BCPM, length = 1.2 m
CBL023	Round Ribbon cable (quantity 1) for BCPM, length = 3 m
CBL024	Round Ribbon cable (quantity 1) for BCPM, length = 6.1 m
CBL031	Round Ribbon cable (quantity 1) for BCPM, length = 0.5 m
CBL033	Round Ribbon cable (quantity 1) for BCPM, length = 0.8 m



EM49xxA Main Board

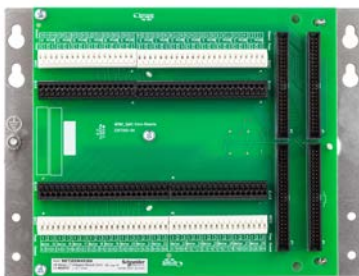

CT Adapter Assembly (28-Meter models only)



Flat ribbon cable



Round ribbon cable

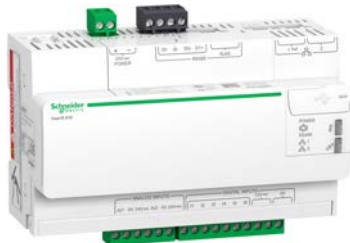

Com'X 510 Energy Server

## Com'X Data Loggers and Energy Servers

### Powerful data logging with flexible communication options

Connect your entire power system with Com'X data loggers and energy servers. Com'X surpasses conventional gateways and data loggers by incorporating multiple capabilities into one compact device. In addition to being a real-time gateway to downstream devices, Com'x logs all essential WAGES and environmental readings through a broad range of downstream data feeds and local I/O. Logged data can be automatically pushed to a hosted platform or downloaded for report generation. Ethernet and Wi-Fi ready, Com'x leverages on the building's existing IT infrastructure to reduce cost. Its GPRS capability makes it ideal for sites with no access to IT networks.

### Easy configuration and commissioning

Configuration and commissioning is made easy by automatic device detection, and IP address setting and allocation. No additional software is needed for the intuitive, web-based configuration pages. A device library enables quick configuration for more than 70 Modbus devices and also provides for custom configuration of additional devices. Configuration via Wi-Fi lets technicians use tablets or notebooks to work comfortably away from switchboard rooms.

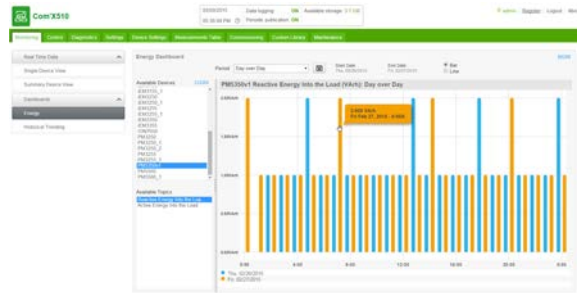

Com'X 510 Energy Dashboard

### Embedded energy management software

The Com'X 510 Energy Server further includes embedded web pages that display data in a meaningful way so you can make informed decisions about your energy usage. Web pages display real-time data in easy to understand tabular and summary formats. In addition, you can access simple analysis of historical data in bar graph or trending formats. Pages are accessible via any standard web browser without plug-ins or additional components.

Table 4.34: Com'X Data Loggers, Energy Services, and Accessories

Description	Catalog Number
Com'X210 Data logger, requires 24 VDC power supply	<a href="#">EBX210</a>
Com'X510 Energy server, requires 24 VDC power supply	<a href="#">EBX510</a>
Wi-Fi USB stick	<a href="#">EBXAUSBWIFI</a>
Zigbee USB stick	<a href="#">EXBAUSBZIGBEE</a>
GPRS modem with SIM card	<a href="#">EBXAGPRSSIM</a>
GPRS modem without SIM card	<a href="#">EBXAGPRS</a>
External GPRS antenna	<a href="#">EBXAANT5M</a>



Link150 Ethernet Gateway

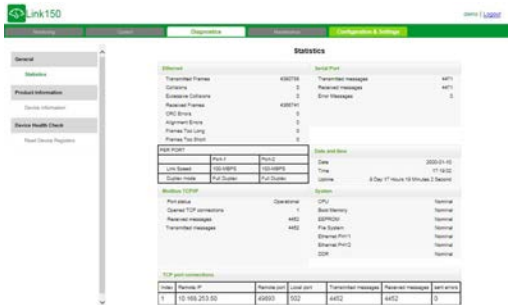

Link150 has embedded web pages for easy setup and maintenance

## Link150 Ethernet Gateway

### Communications for high-speed access to critical information

The Link150 gateway provides fast, reliable Ethernet connectivity in the most demanding applications, from a single building to a multi-site enterprise. This gateway supports meters, monitors, protective relays, trip units, motor controls and other devices that need to communicate data quickly and efficiently. It is your simple, cost-effective serial line to full Ethernet connectivity.

#### Applications

- Energy management
- Power distribution
- Building automation
- Factory automation

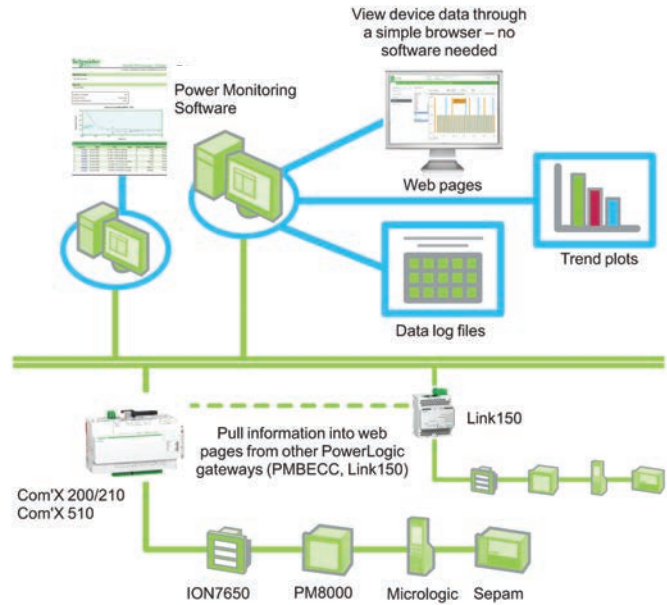

#### Security

- Secure user interface including user's name and password for login
- Advanced security features to allow users to specify which Modbus TCP/IP master devices may access attached serial slave devices
  - Modbus TCP/IP filtering feature
  - Allows user to specify the level of access for each master device as Read-only or Full access

- Web pages provide easy configuration and setup

#### Advantages

- Easy to install and setup
- Easy to maintain
- Compatible with Schneider Electric software offerings (EcoStruxure Power Monitoring Expert, EcoStruxure PowerSCADA Operation, etc.)
- Compatible with Com'X 200/210 and Com'X 510 Energy Servers
- Reliable Modbus to Ethernet protocol conversion

**Table 4.35: Ethernet Gateway**

Type	Catalog Number
Link150 Ethernet gateway	EGX150
Modbus 3 m cable RJ-45 to free wires	VW3A8306D30



Modbus 3 m cable RJ-45 to free wires

## Engineered Solutions

Schneider Electric provides an engineered solution approach to your specific power system applications. Our total solutions for power monitoring and power system controls allow greater safety, reliability, and energy efficiency of your power systems. As a long standing industry leader in Power Monitoring and Control Systems, we understand your power system requirements and needs.

All of our Engineered Solutions are tailored to your specific system requirements. Schneider Electric is your total solution provider.

### The Basics of a Comprehensive Power and Energy Management System

**Measure:** Gather energy and power data throughout your facility. Stand-alone or embedded meters measure, collect, and deliver essential data from key distribution points across your entire electrical network.

**Understand:** Turn data into actionable information. Power management software brings intelligent analytics and visualization to power and energy data.

**Act:** Use actionable information to make intelligent decisions and operational shifts to create change or correct issues.

### The Benefits of Power and Energy Management

- Reduce energy and operational costs
- Improve power and equipment reliability
- Optimize operations
- Increase system capacity
- Minimize expensive downtime
- Meet sustainability goals
- Improve productivity

### Power System Control Applications

**Automated solutions for increased Reliability and Energy Efficiency:** Schneider Electric engineers provide Power System Control Applications with automated solutions for addressing your system reliability and efficiency control needs. Our offer covers Automatic Throwover Schemes, Load Shedding/Peak Shaving, and Load Preservation and Microgrids.

- **Automatic Throwover Systems** – Automatic selection of available utility or generator sources to maintain service continuity to connected loads.
- **Load Shedding/Peak Shaving** – Control peak demand levels or ensure service continuity to critical load or operate breakers in accordance with user specified sequences and time delays such as bringing large motors online across several billing kw demand periods to avoid demand penalties.
- **Load Preservation** – Fast acting sophisticated control systems designed to stabilize critical power systems to the greatest extent possible by monitoring frequency and power sources from utility plus generator capacity versus total circuit load.

### Power System Engineering

The Square D Power System Engineering team offers a wide range of engineering services to improve the safety, efficiency and reliability of your power distribution system. The team is comprised of registered professional engineers, safety trained and equipped, to perform a variety of engineering functions.

### Power System Studies

The Square D Power System Engineering Team provides expertise for a variety of electrical power system studies. Some of the more common system studies include:

- Short-circuit analysis
- Time-current coordination
- Motor starting/voltage drop
- Motor starting/torque-speed
- Safe motor re-energization
- Harmonic analysis
- Transient analysis
- Power factor correction analysis
- Other system specific analysis

### Arc Flash Analysis

Square D offers on-site services to perform arc flash analysis for a facility, complex, office, or campus. An Arc flash analysis is used to determine:

- Flash Protection Boundary
- Incident Energy Value
- Hazard/Risk Category
- Appropriate Personal Protective Equipment (PPE)
- Low cost arc flash reduction methods

### Features of Square D arc flash analysis include:

- Time current coordination analysis showing both existing and recommended over/current device settings
- Short-circuit study to ensure adequacy of equipment
- Onsite verification and documentation of equipment
- Arc flash labels (populated with the results of the arc flash analysis)
- Arc flash label affixation
- NFPA 70E—Safe Workplace Practices Training provided by OSHA authorized outreach instructors
- Recommendations and solutions to reduce potential arc flash hazards

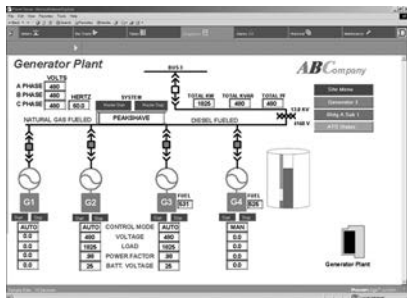

PowerLogic Engineers provide graphic solutions for realtime monitoring of power systems.

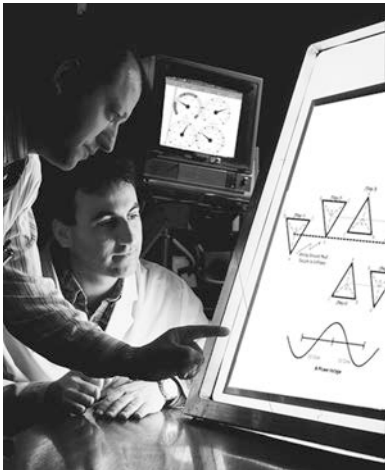

**Power Quality Studies**

Square D offers onsite power quality engineering studies and solutions to eliminate process disruptions, power system shutdowns, and equipment damage due to electrical power system disturbances. A power quality study is used to:

- Determine compliance with the IEEE 519-Recommended Practices and Requirements for Harmonic Control in Electrical Power Systems guidelines
- Identify most cost-effective solution to power quality problems
- Solve process disruptions due to power disturbances
- Reduce economic effects of poor power quality
- Identify disturbances originating on electric utility system and improvements to reduce the number and severity

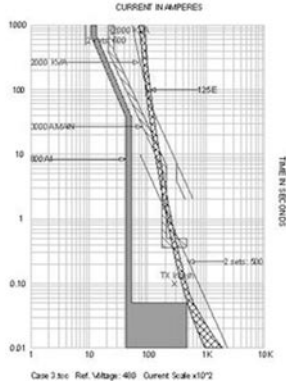

**Power System Assessment**

Square D offers engineering services to meet a variety of power system needs:

- Basic codes and standards compliance
- Protective coordination assessment
- Maintenance program review
- Recommendations for power system optimization
- Power quality troubleshooting and analysis
- Power factor and harmonics analysis
- Electrical safety hazards
- Short-circuit withstand overview
- Single-line documentation of power system
- Power monitoring recommendations
- Loading measurements

**Power System Design Services**

Schneider Electric Engineering Services offers three levels of design services based on the customer need:

- Design Assurance
- Design Assistance
- Primary Design Agent

Other areas of expertise include:

- New equipment installation
- Existing equipment modification
- Protection Control Automation
- Ground Fault Systems
- Generator Control Systems

Square D professional engineers - safety trained and equipped - will listen to your concerns and goals, define the problem or enhancement, and engineer the solution that best satisfies your needs.

For additional information on power system engineering services and pricing, contact your nearest Square D/Schneider Electric office.

**Advanced Microgrid Solutions and Distributed Energy Resource Management**

With our custom solutions and proven expertise, we deliver advanced microgrids that offer the advantages of grid independence – without forfeiting the benefits of being part of the central grid. Our flexible microgrid architecture features a scalable set of grid components designed to efficiently manage your entire energy infrastructure, including distributed generation, energy storage, and load demand, while giving you the ability to easily adapt the system to your changing needs. **Learn more at [www.schneider-electric.us/en/work/solutions/microgrids/](http://www.schneider-electric.us/en/work/solutions/microgrids/)**

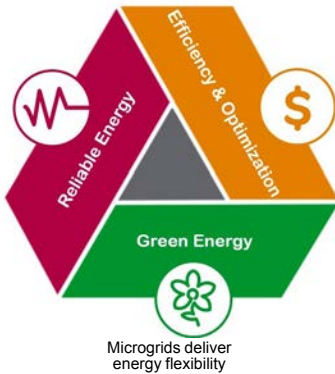

**Total Energy Control**

Schneider Electric Certified Energy Managers (CEM's) work on-site with knowledgeable plant personnel to develop a long-term, comprehensive, "Energy Action Plan", that serves as the blueprint for energy savings. Unlike performance contracts or one-time energy audits, the Total Energy Control<sup>SM</sup> program offers a strategic partnership for energy-intensive industrials who want to improve energy efficiency.

**Total Energy Control**

- **Utility Analysis:** evaluating both the commodity supply side and the demand side areas of the operation.
- **Demand Side Usage:** profiling facility loads and consumption patterns.
- **Opportunity Identification / Prioritization:** projects that make sense today and those that should be considered in the future as energy prices change.
- **Project Implementation:** Client can choose which projects to implement or Square D can provide turn-key implementation.
- **Supply Management:** forecasting and making adjustments to reflect current conditions.
- **On-Going Accountability:** accountable along with you for the ongoing success of your energy plan.



**Leverage in-person and remote services**

Take advantage of EcoStruxure Power Advisor Digital Service Plans to increase the reliability of your critical systems, extend the life of your equipment, and improve your energy performance. You won't believe what your power management system can do with our help! Easily manage your electrical system and keep your operations running smoothly without needing extra time or main-power to do it.

Access the benefits of EcoStruxure Power Advisor, a key component of Digital Service Plans that is the analytical engine that turns your data into information. Using data from your power monitoring software, it combines advanced algorithms with expert analysis, and provides the insight that you need to make the right decisions.

**Table 4.36: EcoStruxure Power Advisor Digital Service Plans**

	Standard	Prime	Ultra
<b>Support</b>			
Basic product support (phone and email; 8am-8pm EST)	•	•	•
Direct access to advanced support & priority case escalation		•	•
Software Assurance <sup>[9]</sup>		•	•
Remote access troubleshooting		•	•
On demand online training classes		•	•
24/7 support		Option	Option
<b>Maintenance</b>			
On-site preventative, condition based maintenance <sup>[10]</sup>	Option	Option/Semi-annual	Option/Quarterly
Software diagnostics (disc usage, server, communication status)			•
Designated engineer(s) assigned			•
Real-time monitoring			•
<b>Reliability/Improvement</b>			
Power Advisor system & network analysis		Semi-annual	Quarterly
Expert design and customization services (remote)	Option	Discounted	Discounted
Power Management University training class	Option	Discounted	Discounted

**NOTE:** Three Year Digital Service Plans are available at a discounted rate.

**Power Management University (PMU)**

Attending a PMU sponsored course will enable attendees to better utilize their Schneider-Electric power monitoring solution thus enabling them to realize energy savings as quickly as possible. PMU offers a variety of options with instructor led options being 80% hands-on, with each student having their own lab workstation. Below is a list of the different training options offered by PMU.

Course	Course Number	Length
<b>Factory Courses: Software Solutions</b>		
PME 8.x Fundamentals Bundle (with 12 mo. On-Demand Campus access)	3000PMUFUNDSPMCR	4 Days
PME 8.x Fundamentals Bundle (without 12 mo. On-Demand Campus access)	3000PMUFUNDSPM	4 Days
PME 8.x Virtual ION Processor — Intro to Advanced System Programming	3000PMUPROG	4 Days
PME 8.x Designer — Advanced Device Programming	3000PMUPROG2	3 Days
PME 8.x Administrator	3000PMUADMINSPM	4 Days
PME Project Deployment for System Integrators	3000PLUC4DAY	4 Days
<b>EcoStruxure PowerSCADA Operation Software</b>		
PSO 8.2 Project Deployment for System Integrators	3000PMUPSO	4 Days
<b>Other Software Courses</b>		
Power Quality — Identification, Causation and Mitigation	3000PMUPQ	3 Days
Hardware Installation and Troubleshooting	3000PLUC100	4 Days
Power SCADA Operation and Maintenance (onsite only)	CONTACT FOR OPTIONS	CUSTOM
EEM Operation and Maintenance (onsite only)	CONTACT FOR OPTIONS	CUSTOM
<b>Online Training Solutions</b>		
On-Demand Campus (one-year subscription — online access)	3000PMUDEMAND12	12 mo.
SMS Trainer (one-year subscription — online access)	3000PMUSMSTRAINER	12 mo.
EEM Trainer (one-year subscription — online access)	3000PMUEEMTRAINER	12 mo.
<b>Educational Hardware</b>		
PMU Education Kit	PMUTRAINLAB	N/A

[9] Upgrade labor not included.  
 [10] Exceptional travel may result in additional charges.



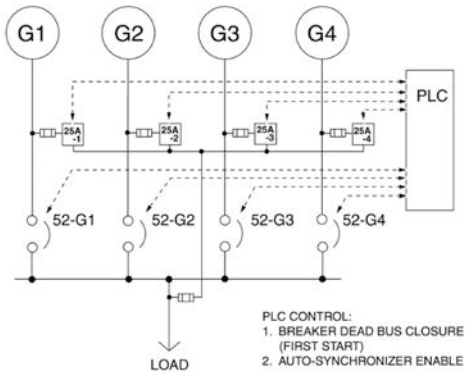

PowerLogic Engineers design power control systems that meet your operational requirements

### System Integration System Design and Engineering

Our Power Solutions specialists can work with you to design or upgrade your existing system to best achieve your energy and power management objectives and informational needs. With expertise in electrical systems, communications, and automatic control systems, we can integrate, install, and commission your system for optimal performance.

- System Design and Bill of Material Recommendations
- Power Monitoring and Control
- WAGES (Water, Air, Gas, Electric, Steam)
- Enterprise web-based monitoring
- Specification development, drawings, documentation
- Enclosure panel design and build
- Metering Connection Verification/Testing
- Power distribution automation
- On-Site Installation Assistance, Component Configuration & Startup
- Turn-key project management
- Third Party Device and communication interfaces
- Configured Workstations, User Software Interfaces
- Interactive Graphic Design to mimic facility layout, one-lines, equipment status
- Custom Software, Reports & Applications – Billing and Event Notification



PowerLogic Engineers specialize in the design and setup of Emergency Power Supply Systems (EPSS).

For additional information, contact your nearest Square D / Schneider Electric office.

### Factory Assembled Equipment

Square D™ PowerLogic™ Factory Assembled Equipment offers a wide range of designs for metering, communications, and control applications to simplify retrofit installations. Our equipment is designed to order as a free-standing or wallmounted system. With PowerLogic™ Factory Assembled Equipment, you'll receive professionally crafted, factory tested, pre-wired equipment that will greatly improve the speed of your system startup. All backed by the Square D™ quality standard of excellence.

- Assemblies include meters & devices wired to terminal blocks, disconnects, and shorting blocks or test switches
- Tailored to any system voltage :
  - 208/120 V, 480/277 V & 600/347 V Wye
  - 240 V, 480 V & 600 V Delta
  - Utilization of PT's required for higher voltage levels
- Wall mountable and easy to install using concealed holes in the back of the enclosure.
- Complete with necessary documentation and mounting hardware for quick and easy installation
- Carbon steel construction, with industry standard ANSI 61 gray powder coat finish
- Equipped with concealed hinged door, and universal pad-lockable latch.
- Custom engraved nameplates available for all units.



Table 4.37: Industrial Enclosure Types 12 & 4, UL & CUL 508A Listed

Available Meter Types	Digital Inputs	Digital Outputs	Analog Inputs	Analog Outputs
ION6200	N/A	Up to 2/ Meter	N/A	N/A
PM5563RD	Up to 4 / Meter	Up to 2 / Meter	N/A	N/A
PM8244	Up to 15 / Meter	Up to 5 / Meter	Up to 4 / Meter	Up to 2 / Meter

- Supports Single or Multiple Voltage Sources for Indoor (Types 1 and 12) & Outdoor (Type 4) applications
- Available with 1–4 meters per panel. Serial & Ethernet Communications are options for all units
- EGX & ION RTU Communication Enclosures with 1–4 devices per panel also available



**Light Industrial Enclosure Type 1, UL & CUL 508A Listed**

- Available for the following meter types: PM8244, PM5563RD, and ION6200
- Supports Single Voltage Source only for Indoor (Type 1) applications.
- Available with 1–12 meters per panel. Serial Communications are standard for all units.
- No Digital or Analog I/O is available for this option.

**Service Entrance/Utility Socket Enclosure Type 3R, UL & CUL 508A Listed**

- Available for ION8650 only, with up to 3 Digital Inputs and 4 Digital Outputs.
- Supports Single Voltage Source only for Indoor & Outdoor (Type 3R) applications.
- Units are Ring Type with removable cover.
- Available with 1 meter per panel. Serial & Ethernet Communications options available.
- Supports Form 9S, 35S, 36S, 39S and 76S configurations for ION8600 and forms 9S and 36S for E5600.
- Options available for remote mounted CTs
- Options available for integrated, bar type CTs
- Optional Test Switch.

**Additional engineered to order products are available for a wide variety of design solutions.**

- Switchgear Transfer Control Panels
- Generator Control Panels
- Load Shed Control Panels
- Sequence of Events Recording (SER) Panels
- Control System Mimic Panels
- Lighting Control Interface Panels
- Programmable Logic Controller (PLC) Control Panels (Hot Standby, Relay Control, Data Concentration etc. ...)
- Emergency Power Supply Systems (EPSS) Control Panels
- Water, Air, Gas, Electrical, and Steam (WAGES) Monitoring Panels
- Input Status Monitoring & Alarming Panels
- Remote Annunciator Control Panels
- Remote Operator Control Panels
- Serial, Ethernet, and Cellular Wireless Systems
- Server Rack and Network Equipment (Servers, Switches, UPS's) for Energy Management Systems.
- Industrialized PC's, Touch Screens (Magelis), and Human Machine Interfaces (HMI's) with Custom System Graphics.
- Designed to fit any environment – Indoor (Type 1 & 12) & Outdoor (Type 3R & 4) applications

**For additional information and pricing please contact your local PowerLogic sales specialist or PowerLogic Inside Sales Support at 615-287-3535. Equipment pricing and literature available for download on our website at [www.powerlogic.com/products/enclosures](http://www.powerlogic.com/products/enclosures).**

**To better serve you please have the following information on hand when calling.**

- Enclosure type (Indoor or Outdoor) and Environment details (Corrosive or Non-Corrosive)
- Power System Voltage Level and Type (Direct Current (DC) or Alternating Current (AC))
- Digital & Analog Input and Output requirements
- Device Type and Quantity per enclosure
- Ethernet and Serial Communication Requirements
- For Drawout Retrofits, need existing cradle type (i.e. GE, Westinghouse, etc.)

**PowerLogic High Density Metering**

High Density Metering (HDM) is engineered to answer the metering and billing needs of multi-tenant properties:

**Features and Benefits**

- HDM comes standard with PowerLogic PM5000 series.
- Lockable, 16 gauge NEMA Type 1 enclosure provides tamper-resistant security.
- NEMA Type 3R also available. Please consult factory.
- Mounting channel and surface-mount flanges simplify installation.
- Factory installed cover plates are included to cover empty meter spaces.
- Factory installed wiring harness simplifies installation of additional meters and provides future system expansion.
- Each High Density Metering cabinet is provided with RS485 Modbus® or Modbus Ethernet TCP communications. For wireless communications, please consult factory.
- Supports 120/208V & 277/480V WYE, and 240V & 480V Delta System Types, 1Ph or 3Ph
- CTs required. Must select separately.

**High Density Meter System Includes:**

- Enclosure
- Power Meters, installed
- Installation bulletin for Enclosure
- Wall hanging bracket
- Installation bulletin for Meters



High Density Metering factory assembled enclosure for multi-tenant properties

**Table 4.38: High Density Metering Cabinet**

Category	Meter	Enclosure Size	Number of Meters [11]	Enclosure Rating	Description
HDM	PM5110	1, 4 or 8	1–8	Type 1 or Type 3R	High Density Meter Enclosure with PM5110 meters; Modbus RTU serial communications; Ideal for single or three phase indoor commercial building applications
HDM	PM5330	1, 4 or 8	1–8	Type 1 or Type 3R	High Density Meter Enclosure with PM5330 meters; Modbus RTU serial communications; Ideal for single or three phase indoor commercial building applications
HDM	PM5340	1	1	Type 1 or Type 3R	High Density Meter Enclosure with PM5340 meters; Modbus TCP Ethernet communications; Ideal for single or three phase indoor commercial building applications
HDM	PM5560	1, 4 or 8	1–8	Type 1 or Type 3R	High Density Meter Enclosure with PM5560 meters; Dual wiring for both Modbus RTU serial and Modbus TCP Ethernet communications; Ideal for single or three phase indoor commercial building applications

**Table 4.39: Accessories**

Description	Catalog No.
50 Amp HDM Solid Core Current Transformer, 1.13" window size	<a href="#">HDMCT050S1</a>
100 Amp HDM Solid Core Current Transformer, 1.13" window size	<a href="#">HDMCT100S1</a>
125 Amp HDM Solid Core Current Transformer, 1.13" window size	<a href="#">HDMCT125S1</a>
150 Amp HDM Solid Core Current Transformer, 1.13" window size	<a href="#">HDMCT150S1</a>
200 Amp HDM Solid Core Current Transformer, 1.13" window size	<a href="#">HDMCT200S1</a>
250 Amp HDM Solid Core Current Transformer, 1.13" window size	<a href="#">HDMCT250S1</a>
400 Amp HDM Solid Core Current Transformer, 1.13" window size	<a href="#">HDMCT400S1</a>

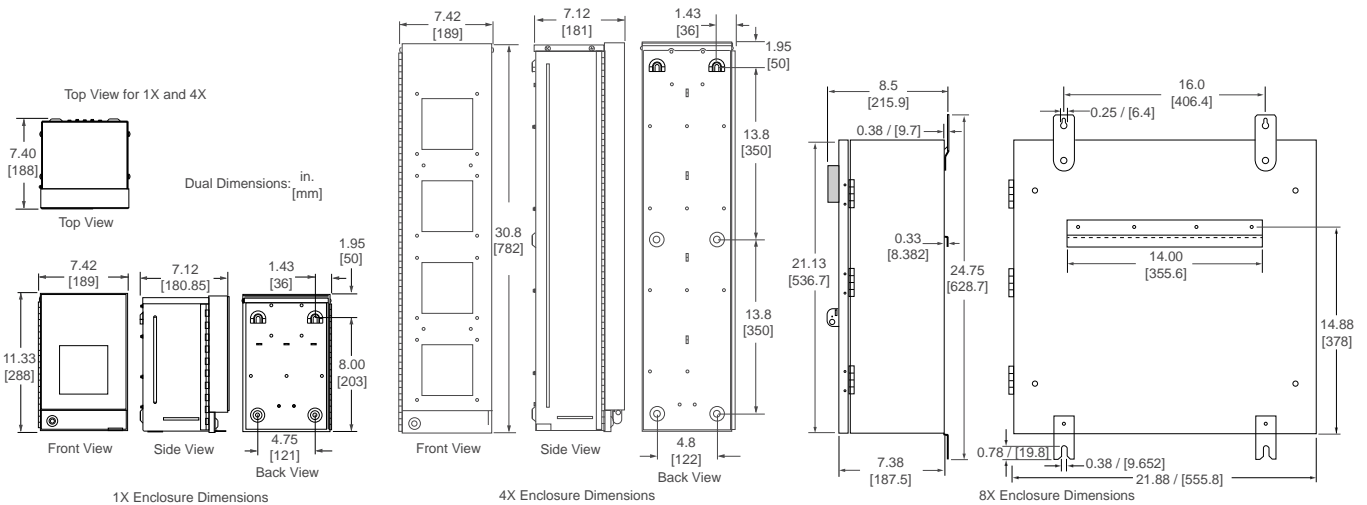

[11] Meters Ordering Notes: Please indicate the number of meters to be pre-installed when placing your order. You may order any number of meters in the enclosure between one and the maximum number of meters each cabinet will hold.

## Reactive Power Compensation and Harmonic Mitigation Solutions

How can reactive power compensation and harmonic mitigation solutions be part of your energy efficiency programs?

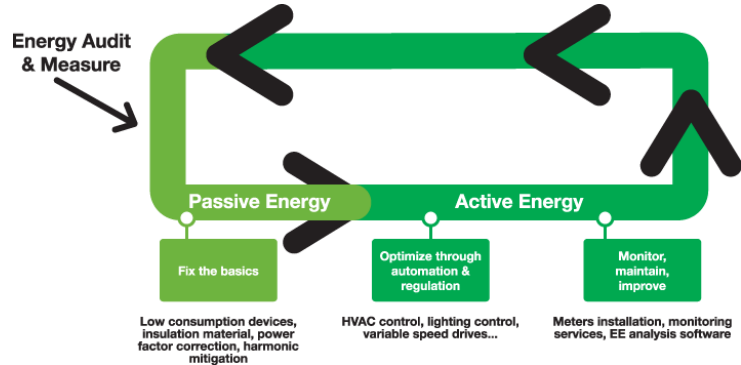

Power factor is a measure of how efficiently you are using electricity. In an electric power system, a load with low power factor draws more current than a load with a high power factor for the same amount of real power transferred. Utility customers with a low power factor could realize an increase or penalty in their electric bill. Over time, these penalties may reach into thousands of dollars, depending upon the utility's rate structure.

Harmonics may disrupt normal operation of other devices and increase operating costs. Symptoms of problematic harmonic levels include overheating of transformers, motors and cables, thermal tripping of protective devices, logic faults of digital devices and drives. Harmonics can cause vibrations and noise in electrical machines (motors, transformers, reactors). The life span of many devices can be reduced by elevated operating temperature.

**As a leader in the field of power quality, Schneider Electric offers the products and services needed to ensure that the most reliable and cost effective solution is applied within your facility. We can help you select the right solution for your application, for greenfield or brownfield projects. Please visit us at <https://www.se.com/us/powerandenergy>.**

Table 4.40: Descriptions, Applications, and Features

Product Description	Application	Product Features
VarSet Standard	Power Factor Correction	Suited for centralized power factor correction in applications where plant loading is constantly changing, resulting in the need for varying amounts of reactive power. Designed for electrical networks with little or no harmonic content.
VarSet Detuned	Power Factor Correction	Suited for centralized power factor correction in applications containing harmonic energies that would otherwise damage standard automatic capacitor banks
VarSet Fast	Power Factor Correction	Contains enhanced technology utilizing solid state switching elements that replace standard electromechanical contactors. Provides quicker response to load fluctuations with transient free capacitor switching.
VarSet Hybrid	Power Factor Correction and Harmonic Filtering	Provides instantaneous and infinitely variable reactive power compensation for industrial networks containing highly transient or unstable loads, as well as system compensation for large AC motor inrush current. It integrates conventional power factor correction systems and the latest IGBT-based solutions to provide ultra rapid response and infinitely variable KVAR control.
AccuSine PFV+	Power Factor Correction	Provides reactive current compensation for specific and high performance systems. It can eliminate leading or lagging power factor, reduce voltage fluctuations, enhance equipment operating life, and improve system power capacity.
AccuSine PCS+ and PCSn	Power Factor Correction and Harmonic Filtering	It is a flexible, high performance, cost-effective solution to stabilize electrical networks by providing harmonic mitigation, power factor correction, and load balancing. It monitors a distorted electrical signal and determines the frequency and magnitude of harmonics in the signal. It cancels the harmonic content with the dynamic injection of opposing phase current in the distribution system or individual load.

**VarSet Capacitor Banks**

Rebranded!

**Your load variation**

**Variable or unstable load**

**Load sensitive to transient switching**

**Automatic compensation**

**Network harmonic pollution level**

TDDI	<8%	TDDI	<20%
THD(U)	<3%	THD(U)	<7%

Choose  
**VarSet Standard**

**480 V - 60 Hz**  
from 75 kvar to 300 kvar

Choose  
**VarSet Detuned**

**480 V - 60 Hz**  
from 75 to 800 kvar

**Automatic and transient-free compensation**

TDDI	< 8%
THD(U)	<5%

Choose  
**VarSet Fast**

**480 V - 60 Hz**  
from 450 kvar to 1200 kvar



**EcoStruxure™**  
Innovation At Every Level

**EcoStruxure™ Power ready**

- Seamless integration thanks to embedded Modbus communication
- Remote equipment follow up & control
- Remote troubleshooting
- Enable analytics & mobile benefits of EcoStruxure™ Power

Rebranded!



VLVAV2N

**Environment**

- Installation: Indoor
- Ambient temperature: 15 °F to 104 °F (-10 °C to 40 °C)
- Humidity: Up to 95%
- Maximum altitude: 6500 feet (2000 m)

**Standards**

- CSA 22.2 No. 190
- UL810, UL508a

**Environmental Certifications**

- Produced in 14001 certified plants, product environmental profile available

**VarSet Standard Capacitor Banks**

The VarSet™ standard automatic capacitor banks provide an easy way to maintain your facility's power factor at an ideal level for maximum system efficiency and savings. Designed for easy installation, this series of wall-mounted capacitor banks has a small footprint, provides you with power factor improvement and improved reliability while saving valuable space.

**Table 4.41: General Characteristics**

VarSet Standard Capacitor Banks	
<b>Electrical Characteristics</b>	
Rated voltage ( U <sub>n</sub> ) / Frequency	480 V / 60 Hz
Capacitance Tolerance	-5% +10%
Connection type	Three-phase
Power losses	< 2.5 W per kvar
Maximum permissible over current	1.35 x I <sub>n</sub>
Maximum permissible over voltage	1.1 x U <sub>n</sub> , 8 h per 24 h
<b>Enclosure</b>	
Degree of protection	NEMA 1
Color	RAL 7035
<b>Controller</b>	
VarPlus Logic	VarPlus Logic controller with embedded Modbus communication
<b>Head Circuit Breaker Protection</b>	
Without incoming circuit breaker	Lug connection LV PFC Bank must be protected by a circuit breaker or by a fused disconnect on upstream switchboard
With incoming circuit breaker	PowerPact with rotary handle
<b>Step</b>	
Capacitors Type	Varplus Can 575 V for network voltage 480 V Maximum overcurrent 1.8 x I <sub>n</sub> 3 ph overpressure disconnection system Discharge resistor 50 V - 1 min
Contactors	Dedicated to capacitor switching
Circuit breaker protection	PowerPact
<b>Temperature Control</b>	
Double control	By thermostat and by controller
<b>Communication</b>	
ModBus	RS485
<b>Installation</b>	
Customer connection	Top Entry
Auxiliary transformer	120 V included, no need for additional supply
CT not included (see <a href="#">Current Transformer Selection, page 4-40</a> )	5 VA - secondary 1 or 5 A To be installed upstream of the load and capacitor bank
GenSet contact	Available for disconnection with generator
Alarm contact	Available for remote warning signal

**Table 4.42: VarSet Standard Capacitor Banks**

Catalog No.	Power (kVAr)	Smallest step	Resolution	No. of electrical steps	No. of physical steps	Enclosure size (H * W * D)	Max weight
<b>With incoming circuit breaker</b>							
VLVAV2N66075AB	75	12.5	12.5 + 25 + 37.5	6	3	33.5 x 31.5 x 15.7 inch (850 x 800 x 400 mm)	80 kgs / 175 lbs
VLVAV2N66100AB	100	25	25 + 25 + 50	4	3		
VLVAV3N66125AB	125	25	25 + 50 + 50	5	3	47.2 x 39.4 x 15.7 inch (1200 x 1000 x 400 mm)	125 kgs / 275 lbs
VLVAV3N66150AB	150	25	25 + 25 + 2 x 50	6	4		
VLVAV3N66175AB	175	25	25 + 3 x 50	7	4		
VLVAV3N66200AB	200	25	25 + 25 + 3 x 50	5	5		
VLVAV3N66225AB	225	25	25 + 4 x 50	9	5		
VLVAV3N66250AB	250	25	5 x 50	5	5		
VLVAV3N66275AB	275	25	25 + 5 x 50	11	6		
VLVAV3N66300AB	300	50	6 x 50	6	6		
<b>With main lugs</b>							
VLVAV2N66075AA	75	12.5	12.5 + 25 + 37.5	6	3	33.5 x 31.5 x 15.7 inch (850 x 800 x 400 mm)	80 kgs / 175 lbs
VLVAV2N66100AA	100	25	25 + 25 + 50	4	3		
VLVAV3N66125AA	125	25	25 + 50 + 50	5	3	47.2 x 39.4 x 15.7 inch (1200 x 1000 x 400 mm)	125 kgs / 275 lbs
VLVAV3N66150AA	150	25	25 + 25 + 2 x 50	6	4		
VLVAV3N66175AA	175	25	25 + 3 x 50	7	4		
VLVAV3N66200AA	200	25	25 + 25 + 3 x 50	5	5		
VLVAV3N66225AA	225	25	25 + 4 x 50	9	5		
VLVAV3N66250AA	250	25	5 x 50	5	5		

**VarSet Detuned Capacitor Banks**

The VarSet Detuned automatic capacitor banks provide power factor correction in electrical distribution networks with moderate levels of harmonic content. The series capacitor and reactor combination is tuned below the first dominant harmonic order (usually the 5th). This prevents resonance and harmonic amplification.

Rebranded!



AV6000



VLVAF4P

**Environment**

- Installation: Indoor
- Ambient temperature: 15 °F to 104 °F (-10 °C to 40 °C)
- Humidity: Up to 95%
- Maximum altitude: 6500 feet (2000 m)

**Standards**

- CSA 22.2 No. 190
- UL810, UL508a

**Environmental Certifications**

- Produced in 14001 certified plants, product environmental profile available

**Table 4.43: General Characteristics**

VarSet Detuned Capacitor Banks	
<b>Electrical Characteristics</b>	
Rated voltage ( Un ) / Frequency	480 V / 60 Hz
Capacitance Tolerance	-5% +10%
Connection type	Three-phase
Power losses	< 6 W per kvar
Maximum permissible over current	1.3 x In
Maximum permissible over voltage	1.1 x Un, 8h per 24h
<b>Enclosure</b>	
Degree of protection	NEMA 1
Color	RAL 7035 (VLV model ) or ASA 49 ( AV/BV Model )
<b>Controller</b>	
VarPlus Logic	VarPlus Logic controller with embedded Modbus communication
<b>Head Protection</b>	
Without incoming circuit breaker	Lug connection LV PFC Bank must be protected by a circuit breaker or by a fused disconnect on upstream switchboard
With incoming circuit breaker	PowerPact with rotary handle
<b>Step</b>	
Capacitors	Varplus Can 575 V for network voltage 480 V
	Maximum overcurrent 1.8 xIn
	3 ph overpressure disconnection system
Contactors	Discharge resistor 50 V - 1 mn
	Dedicated to capacitor switching
Detuned reactor	Varplus DR Overheating protection by thermostat
Circuit breaker protection	PowerPact
<b>Temperature Control</b>	
Double control	By thermostat and by controller
<b>Communication</b>	
ModBus	RS485
<b>Installation</b>	
Customer connection	Top Entry
Auxiliary transformer	120 V included, no need of additional supply
CT not included (see <a href="#">Current Transformer Selection, page 4-40</a> )	5 VA - secondary 1 or 5 A To be installed upstream of the load and capacitor bank
GenSet contact	Available for disconnection with generator
Alarm contact	Available for remote warning signal

**Options available by request:**

- Fixed stages (by controller programming)
- Custom staging ratios
- Other voltages and frequencies
- Outdoor arrangement - Built to NEMA 3R (AV/BV models only)
- Bottom cable entry to main lugs (AV models only)
- Bottom cable entry to main breaker (BV models only)

Table 4.44: VarSet Detuned Capacitor Banks

Catalog No.	Power (kVAR)	Smallest step	Resolution	No. of electrical steps	No. of physical steps	Enclosure size (H * W * D)	Max weight	
<b>With incoming circuit breaker</b>								
VLVAF4P66075AB	75	25	25 + 50	6	6	47.2 x 51.2 x 15.7 inch (1200 x 1300 x 400 mm)	265 kgs / 585 lbs	
VLVAF4P66100AB	100	25	25 + 25 + 50	4	4			
VLVAF4P66125AB	125	25	25 + 2 x 50	5	5			
VLVAF4P66150AB	150	25	25 + 25 + 2 x 50	6	6			
VLVAF4P66175AB	175	25	25 + 3 x 50	7	7			
VLVAF4P66200AB	200	50	4 x 50	5	5			
BV025046CV5F1N	250	50	50 + 2 x 100	5	5	91.5 x 30 x 36 inch (2324 x 762 x 915 mm)	747 kgs / 1650 lbs	
BV030046BV5F1N	300	50	50 + 50 + 2 x 100	6	6	91.5 x 60 x 36 inch (2324 x 1524 x 915 mm)	793 kgs / 1750 lbs	
BV035046CV5F2N	350	50	50 + 3 x 100	7	7		1110 kgs / 2450 lbs	
BV040046AV8F2N	400	100	4 x 100	4	4		1155 kgs / 2550 lbs	
BV045046CV5F2N	450	50	50 + 4 x 100	9	9		1223 kgs / 2700 lbs	
BV050046AV8F2N	500	100	5 x 100	5	5		1291 kgs / 2850 lbs	
BV055046CV5F2N	550	50	50 + 5 x 100	11	11		1359 kgs / 3000 lbs	
BV060046AV8F2N	600	100	6 x 100	6	6		1427 kgs / 3150 lbs	
BV065046CV5F2N	650	50	50 + 6 x 100	13	13		1495 kgs / 3300 lbs	
BV070046AV8F2N	700	100	7 x 100	7	7		1563 kgs / 3450 lbs	
BV075046CV5F3N	750	50	50 + 7 x 100	15	15		1835 kgs / 4050 lbs	
BV080046AV8F3N	800	100	8 x 100	8	8		1903 kgs / 4200 lbs	
<b>With main lugs</b>								
VLVAF4P66075AA	75	25	25 + 50	6	2		47.2 x 51.2 x 15.7 inch (1200 x 1300 x 400 mm)	265 kgs / 585 lbs
VLVAF4P66100AA	100	25	25 + 25 + 50	4	3			
VLVAF4P66125AA	125	25	25 + 2 x 50	5	3			
VLVAF4P66150AA	150	25	25 + 25 + 2 x 50	6	4			
VLVAF4P66175AA	175	25	25 + 3 x 50	7	4			
VLVAF4P66200AA	200	50	4 x 50	5	4			
AV025046CV5F1N	250	50	50 + 2 x 100	5	3	91.5 x 30 x 36 inch (2324 x 762 x 915 mm)	612 kgs / 585 lbs	
AV030046BV5F1N	300	50	50 + 50 + 2 x 100	6	4		657 kgs / 1450 lbs	
AV035046CV5F1N	350	50	50 + 3 x 100	7	4		725 kgs / 1600 lbs	
AV040046AV8F1N	400	100	4 x 100	4	4		793 kgs / 1750 lbs	
AV045046CV5F2N	450	50	50 + 4 x 100	9	5		1132 kgs / 2500 lbs	
AV050046AV8F2N	500	100	5 x 100	5	5		1200 kgs / 2650 lbs	
AV055046CV5F2N	550	50	50 + 5 x 100	11	6		1268 kgs / 2800 lbs	
AV060046AV8F2N	600	100	6 x 100	6	6		1336 kgs / 2950 lbs	
AV065046CV5F2N	650	50	50 + 6 x 100	13	7		1404 kgs / 3100 lbs	
AV070046AV8F2NN	700	100	7 x 100	7	7		1472 kgs / 3250 lbs	
AV075046CV5F2N	750	50	50 + 7 x 100	15	8		1540 kgs / 3400 lbs	
AV080046AV8F2N	800	100	8 x 100	8	8		1608 kgs / 3550 lbs	

4

POWER MONITORING AND CONTROL



**VarSet Fast Capacitor Banks**

Rebranded!

The VarSet Fast detuned automatic capacitor banks are suitable for nearly all electrical networks and are ideal for correcting poor power factor in electrical networks with a high concentration of electronic loads. Instead of traditional electromechanical contactor switching, it uses an advanced controller to precisely activate electronic switching elements to connect capacitor stages and avoid the creation of transients.



AT6000 Transient Free Capacitor Bank

**Environment**

- Installation: Indoor
- Ambient temperature: 15 °F to 104 °F (-10 °C to 40 °C)
- Humidity: Up to 95%
- Maximum altitude: 6500 feet (2000 m)

**Standards**

- CSA 22.2 No. 190
- UL810, UL508a

**Environmental Certifications**

- Produced in 14001 certified plants, product environmental profile available

**Table 4.45: General Characteristics**

VarSet Fast Capacitor Banks	
<b>Electrical Characteristics</b>	
Rated voltage ( U <sub>n</sub> ) / frequency	480 V, 600 V / 60 Hz
Capacitance tolerance	-5% +10%
Connection type	Three-phase
Power losses	< 13 W per kvar
Maximum permissible over current	1.3 x I <sub>n</sub>
Maximum permissible over voltage	1.1 x U <sub>n</sub> , 8 h per 24 h
<b>Enclosure</b>	
Degree of protection	NEMA 1
Color	ASA 49
<b>Controller</b>	
VarPlus logic	VarPlus logic controller with embedded Modbus communication
<b>Head Protection</b>	
Without incoming circuit breaker	Lug connection LV PFC Bank must be protected by a circuit breaker or by a fused disconnect on upstream switchboard
With incoming circuit breaker	RKL type with rotary handle
<b>Step</b>	
Capacitors	Varplus Can 575 V for network voltage 480 V
	Maximum overcurrent 1.8 x I <sub>n</sub>
	3 ph overpressure disconnection system
Transient free switches	Discharge resistor 50 V - 1 mn
	Electronically controlled to avoid capacitor switching transients
Detuned reactor	VarPlus DR
Circuit breaker protection	Overheating protection by thermostat HLL or JLL type according to step size
<b>Temperature Control</b>	
Double control	By thermostat and by controller
<b>Communication</b>	
ModBus	RS485
<b>Installation</b>	
Customer connection	Top entry
Auxiliary transformer	120 V included, no need of additional supply
CT not included ( See <a href="#">Current Transformer Selection, page 4-40</a> )	5 VA - secondary 1 or 5 A To be installed upstream of the load and capacitor bank
GenSet contact	Available for disconnection with generator
Alarm contact	Available for remote warning signal

**Options available by request:**

- Fixed stages (by controller programming )
- Custom staging ratios
- Other voltages and frequencies
- Outdoor arrangement - Built to NEMA 3R (AV/BV models only)
- Bottom cable entry to main lugs or main breaker requires incoming cubicle

**Table 4.46: VarSet Fast Capacitor Banks**

Catalog No.	Power (kVAR)	Smallest step	Resolution	No. of electrical and physical steps	Enclosure size ( H * W * D )	Max weight
<b>With incoming circuit breaker</b>						
BT045046AVBF2N	450	150	3 x 150	6	91.5 x 30 x 36 inch (2324 x 762 x 915 mm)	900 kgs / 2000 lbs
BT060046AVBF2N	600	150	4 x 150	4	91.5 x 60 x 36 inch (2324 x 1524 x 915 mm)	1400 kgs / 3100 lbs
BT090046AVBF3N	900	150	6 x 150	5	91.5 x 60 x 36 inch (2324 x 1524 x 915 mm)	1540 kgs / 3400 lbs
BT120046AVBF3N	1200	150	8 x 150	6	91.5 x 90 x 36 inch (2324 x 2286 x 915 mm)	2310 kgs / 5100 lbs
<b>With main lugs</b>						
AT045046AVBF2N	450	150	3 x 150	6	91.5 x 30 x 36 inch (2324 x 762 x 915 mm)	770 kgs / 1700 lbs
AT060046AVBF2N	600	150	4 x 150	4	91.5 x 60 x 36 inch (2324 x 1524 x 915 mm)	1360 kgs / 3000 lbs
AT090046AVBF3N	900	150	6 x 150	5	91.5 x 60 x 36 inch (2324 x 1524 x 915 mm)	1500 kgs / 3300 lbs
AT120046AVBF3N	1200	150	8 x 150	6	91.5 x 90 x 36 inch (2324 x 2286 x 915 mm)	2270 kgs / 5000 lbs

### VarSet Current Transformers

A current transformer is required for automatic control and must be ordered in addition to the VarSet capacitor bank.

CT must be sized to your network and have a secondary rating of 5 A. When selecting a CT be sure to use proper rating factors for ambient temperature conditions.

For more information, please refer to the VarSet catalog.

**Table 4.47: Current Transformer Selection**

Catalog Number	Current Ratio
TRAI600SC07	600:5
TRAI800SC07	800:5
TRAI1000SC07	1000:5
TRAI1200SC07	1200:5
TRAI1500SC07	1500:5
TRAI1600SC07	1600:5
TRAI2000SC07	2000:5
TRAI2500SC07	2500:5
TRAI3000SC07	3000:5
TRAI3500SC07	3500:5
TRAI4000SC07	4000:5
TRAI1200SC11	1200:5
TRAI2000SC11	2000:5
TRAI2500SC11	2500:5
TRAI3000SC11	3000:5
TRAI3500SC11	3500:5
TRAI4000SC11	4000:5
TRAI5000SC11	5000:5
TRAI6000SC11	6000:5



**AccuSine PFV+ Electronic VAR Control**

AccuSine PFV+ is a very simple and effective means to eliminate leading or lagging power factor, reduce voltage fluctuations, enhance equipment operating life, and improve system power capacity. AccuSine PFV+ offers many features in one package that others require multiple models to accomplish.

AccuSine PFV+ can help you solve:

- Power factor
- Imbalance (specifically important for motor applications)
- Voltage stability (such as localized photovoltaic networks)
- Flicker
- AccuSine PFV+ integrates with EcoStruxure™ Power's edge control power management and control software and analytics services that scale to your demands and adapt to your needs.

**AccuSine PFV+ Sizing**

For proper sizing of AccuSine units, contact the Schneider Electric sales office or visit us at <https://www.se.com/us/powerandenergy>. To expedite the product selection process, please have a single line diagram and/or details of the application including sizes of transformers, non-linear and linear loads, and any existing filters and capacitors.

**Table 4.48: AccuSine PFV+ Selection**

PF Correction and Load Balancing (380-480V models 50/60Hz)							
Rated Current (A)	KVAR Rating @ Voltage	Catalog Number	Rating	Enclosure Style	Cable Entry	Frame	Weight lb (kg)
60 <sup>[1]</sup>	39.5 @ 380 41.6 @ 400 43.1 @ 415 49.9 @ 480	EVCP060D5IP00	IP00 (chassis)	Wall Mount	Bottom	1	194 (88)
		EVCP060D5N2	UL Type 2	Floor Standing	Top or Bottom	2	611 (277)
		EVCP060D5IP31	IP31				642 (291)
		EVCP060D5N12	UL Type 12				
		EVCP060D5IP54	IP54				
120 <sup>[2]</sup>	79.0 @ 380 83.1 @ 400 86.3 @ 415 99.8 @ 480	EVCP120D5IP00	IP00 (chassis)	Wall Mount	Bottom	3	249 (113)
		EVCP120D5N2	UL Type 2	Floor Standing	Top or Bottom	4	615 (279)
		EVCP120D5IP31	IP31				646 (293)
		EVCP120D5N12	UL Type 12				
		EVCP120D5IP54	IP54				
200 <sup>[3]</sup>	131.6 @ 380 138.6 @ 400 143.8 @ 415 166.3 @ 480	EVCP200D5IP00	IP00 (chassis)	Wall Mount	Bottom	5	377 (171)
		EVCP200D5N1	UL Type N1	Floor Standing	Top or Bottom	6	800 (363)
		EVCP200D5N2	UL Type 2				846 (384)
		EVCP200D5IP31	IP31				887 (402)
		EVCP200D5N12	UL Type 12				
300 <sup>[4]</sup>	197.5 @ 380 207.8 @ 400 215.6 @ 415 249.4 @ 480	EVCP300D5IP00	IP00 (chassis)	Wall Mount	Bottom	7	463 (210)
		EVCP300D5N1	UL Type N1	Floor Standing	Top or Bottom	8	887 (402)
		EVCP300D5N2	UL Type 2				930 (422)
		EVCP300D5IP31	IP31				961 (436)
		EVCP300D5N12	UL Type 12				
		EVCP300D5IP54	IP54				

POWER MONITORING AND CONTROL

4

**Table 4.49: AccuSine PCS+ and AccuSine PFV+ Exterior Dimensions**

Frame Size	Exterior Dimensions		
	Height in (mm)	Width in (mm)	Depth in (mm)
1	51.18 (1300)	16.57 (421)	13.74 (349)
2	82.68 (2100)	31.50 (800)	19.69 (500)
3	55.12 (1400)	16.57 (421)	15.12 (384)
4	82.68 (2100)	31.50 (800)	19.69 (500)
5	52.09 (1323)	22.91 (582)	17.24 (438)
6	82.68 (2100)	35.43 (900)	23.62 (600)
7	61.42 (1560)	22.91 (582)	17.24 (438)
8	82.68 (2100)	35.43 (900)	23.62 (600)
9	82.68 (2100)	51.18 (1300)	19.69 (500)
10	82.68 (2100)	55.12 (1400)	23.62 (600)
11	78.74 (2000)	31.50 (800)	23.62 (600)

**AccuSine+ Wall Mount Conversion Kit**

- Converts IP00 (UL Type Open) to IP20 (UL Type 1) wall mounted enclosed assemblies.
- Includes HMI mounting plate and cable entry enclosure for mounting on the bottom of the IP00 assemblies.

**Table 4.50: AccuSine+ Wall Mount Kits**

Wall Mount Kit Reference	Assembled Dimensions — IP20				IP20 Assembly Weight lb (kg)	Cable Entry Enclosure Weight lb (kg)
	Unit Rating (A)	Height in (mm)	Width in (mm)	Depth in (mm)		
PCSPWMKIT60A	60	60.24 (1530)	16.57 (421)	13.7 (349)	214.51 (97.3)	19.18 (8.7)
PCSPWMKIT120A	120	64.17 (1630)	16.57 (421)	15.12 (384)	269 (122)	20.5 (9.3)
PCSPWMKIT300A	200	64.64 (1642)	22.64 (575)	17.13 (435)	396.83 (180)	19 (8.6)
PCSPWMKIT300A	300	74 (1882)	22.64 (575)	17.13 (435)	481.93 (218.6)	19 (8.6)

[1] 60 A IP20/UL Type 1 configuration requires ordering two items: EVCP060D5IP00 and PCSPWMKIT60A; adds 9.12 in (232 mm) to length and 19.18 lb (8.7 kg).  
 [2] 120 A IP20/UL Type 1 configuration requires ordering two items: EVCP120D5IP00 and PCSPWMKIT120A; adds 9.13 in (232 mm) to length and 20.5 lb (9.3 kg).  
 [3] 200 A IP20/UL Type 1 configuration requires ordering two items: EVCP200D5IP00 and PCSPWMKIT300A; adds 10.75 in (273 mm) to length and 19 lb (8.6 kg).  
 [4] 300 A IP20/UL Type 1 configuration requires ordering two items: EVCP300D5IP00 and PCSPWMKIT300A; adds 10.75 in (273 mm) to length and 19 lb (8.6 kg).

**AccuSine Current Transformers**  
**Split-Core Design**

Construction

Directional silicon steel is used for the flexible core. Secondary windings are of copper. Unit is encapsulated in silicone rubber, which protects against moisture, dirt, oil, and corona.

**Table 4.51: Specifications**

Description		Specification
Insulation Level		0.72 kV BIL 10 kV Full Wave
Frequency		50-400 Hz
Thermal Factor		1.25 at 30 °C; 1.0 at 55 °C
Operating Temp Range		-45 °C to +55 °C
Altitude		Up to 4000 Meters
Accuracy (Primary rating)	200 through 300	4 %
	400 through 500	3 %
	600 through 800	2 %
	1000 through 6000	1 %
Secondary Leads		3.65 m with spade connectors
Color		Transformer (red) - Leads (yellow)
Remains flexible from -45° to +200 °C		



Twisting motion opens to CT diameter of round CT and smaller distance of rectangular CT.  
NOTE: Open split-core with a twisting motion only.

**Table 4.52: Round Split-Core Design**

Reference Number by Secondary Current		Maximum load (A)	Inside diameter (ID) in (mm) - A	Burden Capacity (Ω)		Weight lb (kg)
5 A	1 A			5 A	1 A	
PCSPCTFCL50054	PCSPCTFCL50014	500	4 (101.6)	0.120	2.0	3.35 (1.6)
PCSPCTFCL100054	PCSPCTFCL100014	1000	4 (101.6)	0.200	10.0	3.53 (1.6)
PCSPCTFCL150054	—	1500	4 (101.6)	0.375	15.0	3.53 (1.6)
PCSPCTFCL160054	—	1600	4 (101.6)	0.375	15.0	3.53 (1.6)
PCSPCTFCL50056	—	500	6 (152.4)	0.120	2.0	4.19 (1.9)
—	PCSPCTFCL100016	1000	6 (152.4)	0.200	10.0	4.19 (1.9)
PCSPCTFCL120056	—	1200	6 (152.4)	0.200	15.0	4.19 (1.9)
PCSPCTFCL150056	PCSPCTFCL150016	1500	6 (152.4)	0.375	15.0	4.19 (1.9)
PCSPCTFCL200056	PCSPCTFCL200016	2000	6 (152.4)	1.000	18.0	4.19 (1.9)
PCSPCTFCL250056	—	2500	6 (152.4)	1.400	20.0	4.19 (1.9)
PCSPCTFCL300056	—	3000	6 (152.4)	1.800	20.0	4.19 (1.9)
—	PCSPCTFCL200018	2000	8 (203.2)	1.000	18.0	5.51 (2.5)
PCSPCTFCL250058	—	2500	8 (203.2)	1.400	20.0	5.51 (2.5)
PCSPCTFCL400058	—	4000	8 (203.2)	1.800	20.0	5.51 (2.5)
PCSPCTFCL500058	—	5000	8 (203.2)	1.800	20.0	5.51 (2.5)
PCSPCTFCL2500511	—	2500	11 (279.4)	1.400	20.0	7.5 (3.4)



Twisting motion opens to CT diameter of round CT and smaller distance of rectangular CT.  
NOTE: Open split-core with a twisting motion only.

**Table 4.53: Rectangular Split-Core Design**

Reference Number by Secondary Current		Maximum load (A)	Inside diameter (ID) in (mm)		Burden Capacity (Ω)		Weight lb (kg)
5 A	1 A		A	B	5 Amp	1 Amp	
PCSPCTFCL5005R	PCSPCTFCL5001R	500	2.74 (69.8)	6.6 (168.2)	0.12	2.0	4.19 (1.9)
PCSPCTFCL10005R	PCSPCTFCL10001R	1000	2.74 (69.8)	6.6 (168.2)	0.2	10.0	4.19 (1.9)
PCSPCTFCL12005R	PCSPCTFCL12001R	1200	2.74 (69.8)	6.6 (168.2)	0.2	15.0	4.19 (1.9)
PCSPCTFCL15005R	PCSPCTFCL15001R	1500	2.74 (69.8)	6.6 (168.2)	0.375	15.0	4.19 (1.9)
PCSPCTFCL16005R	PCSPCTFCL16001R	1600	2.74 (69.8)	6.6 (168.2)	0.375	15.0	4.19 (1.9)
PCSPCTFCL20005R	—	2000	2.74 (69.8)	6.6 (168.2)	1	18.0	4.19 (1.9)
PCSPCTFCL30005R	—	3000	2.74 (69.8)	6.6 (168.2)	1.8	20.0	4.19 (1.9)
PCSPCTFCL25005R411	PCSPCTFCL25001R411	2500	4 (101.6)	11 (279.4)	1.4	20.0	6.17 (2.8)
PCSPCTFCL30005R411	—	3000	4 (101.6)	11 (279.4)	1.8	20.0	6.17 (2.8)
PCSPCTFCL40005R411	—	4000	4 (101.6)	11 (279.4)	1.8	20.0	6.17 (2.8)
PCSPCTFCL50005R411	—	5000	4 (101.6)	11 (279.4)	1.8	20.0	6.17 (2.8)

**Round Solid-Core Design**

**Table 4.54: Specifications**



Description	Specification
Frequency	50-400 Hz
Class	0.6 kV, 10 kV BIL Full Wave
Flexible Leads	UL 1015, 105 °C; CSA approved; 16 AWG (1.31 mm <sup>2</sup> ), 609.6 mm
Weight	Approximately 0.68 kg
Accuracy	1 %

**Table 4.55: Round Solid-Core Design**

Reference Number by secondary current		Maximum load (Amps)	Burden Capacity (Ω)	
5 Amps	1 Amp		5 Amp	1 Amp
—	PCSPCT7RL2011	200	0.5	5.0
PCSPCT7RL3015	PCSPCT7RL3011	300	0.5	5.0
PCSPCT7RL4015	PCSPCT7RL4011	400	0.6	7.5
PCSPCT7RL5015	PCSPCT7RL5011	500	1.0	10.0
PCSPCT7RL6015	PCSPCT7RL6011	600	1.2	12.5
PCSPCT7RL7515	PCSPCT7RL7511	750	1.2	12.5
PCSPCT7RL8015	PCSPCT7RL8011	800	1.4	20.0
PCSPCT7RL1025	PCSPCT7RL1021	1000	1.4	25.0
PCSPCT7RL1225	PCSPCT7RL1221	1200	1.4	15.0
PCSPCT7RL1525	PCSPCT7RL1521	1500	1.6	20.0
PCSPCT7RL1625	PCSPCT7RL1621	1600	2.0	25.0

## VarSet Hybrid

Rebranded!

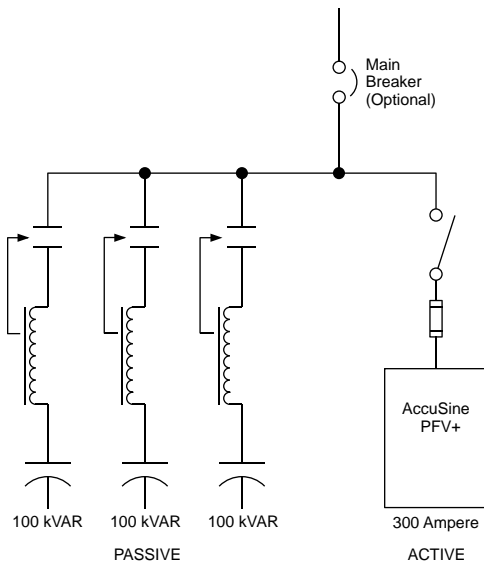

Topology (Typical)

### Main Features:

- Ultra fast reactive current compensation for transient or cyclical loads
- Infinitely variable control
- Instantaneous response for inrush support
- Independently compensates each phase
- Heavy duty dry capacitors provide no risk of fluid leakage, no environmental pollution, and no need for drip pans
- Detuned iron core reactors prevent resonance
- IGBT based power electronic technology
- Stepless power factor correction
- Best-in-class harmonic cancellation up to 50th harmonic and less than 3% THDi
- Energy efficient 3-level IGBT inverter technology
- All major components from Schneider Electric

Power quality issues like harmonics and reactive power can cause problems including equipment damage and reduced reliability. In industrial networks, highly fluctuating loads like spot welders can cause voltage fluctuations and/or flicker that can lead to process malfunctions. The detrimental effects are increased operating expenses, expensive downtime, overheating equipment or poor quality on manufactured parts.

VarSet Hybrid systems provide instantaneous and infinitely variable power factor correction for industrial networks containing highly transient or unstable loads, as well as system compensation for large AC motor inrush current.

The VarSet Hybrid system integrates conventional power factor correction systems and the latest IGBT-based solutions to provide ultra rapid response and infinitely variable kVAR control never before seen in a power factor correction product. Specifically designed for the instantaneous support required by welding equipment, the VarSet Hybrid eliminates voltage sags and voltage flicker while increasing system capacity, providing energy savings and improving weld quality. It also provides current inrush support for applications such as large horsepower motor starting. The VarSet Hybrid is comprised of a Detuned Capacitor Bank with either an Active Harmonic Filter or an Electronic Var Compensator.

Active Harmonic Filters (AHF) are static power electronic products that employ digital logic and IGBT semiconductors to synthesize a current waveform that is injected into the electrical network to cancel harmonic currents caused by nonlinear loads. AHF employ current transformers to measure the load current to determine the content of harmonic current present. By injecting the synthesized current, network harmonic currents are greatly mitigated, thus reducing the heating effects of harmonic current and reducing voltage distortion.

AHF also have the ability to correct for poor displacement power factor (DPF) and provide for mains current balancing. DPF correction can be provided for either leading (capacitive) or lagging (inductive) loads. Mains current balancing is achieved by measuring the negative sequence current present and injecting the inverse negative sequence current to balance the current for the upstream network.

An Electronic Var Compensator (EVC) is a power electronic device consisting of insulated gate bipolar transistors (IGBT) that switch into the AC lines to modulate the output to correct the displaced reactive current (leading or lagging) and balance the current for the power source (also known as negative sequence current).

Detuned Capacitor Banks are automatic capacitor banks made of several capacitor steps controlled by a power factor (PF) controller. They are able to adjust PF to any value between 0.8 lagging and unity. When the PF differs from the target setting for more than 1 second, the capacitor switching modules switch stages as needed to bring the PF as close as possible to the target PF. Switching can be accomplished by electro-mechanical contactors or solid state switches.

The VarSet Hybrid is a custom solution that is engineered to order. Your local Schneider Electric representative can help you select the correct hybrid solution for your specific needs. To learn more, visit us at <https://www.se.com/us/powerandenergy>.



**AccuSine PCS+ Active Harmonic Filter (AHF)**

AccuSine PCS+ Active Harmonic Filter (AHF) injects harmonic current to cancel harmonic current in the electrical distribution system. This reduced harmonic level results in improved electrical network reliability and reduced operating cost. AccuSine PCS+ is simple to size, install, set up and operate. In addition, AccuSine PCS+ eliminates the complex harmonic compliance limit calculations and removes nuisance harmonics from the electrical network.

**The Problem:** Power electronic devices that have rapid and frequent load variations have become abundant today due to their many process control related and energy saving benefits. However, they also bring a few major drawbacks to electrical distribution systems; harmonics and rapid change of reactive power requirement. Harmonics may disrupt normal operation of other devices and increase operating costs. Symptoms of problematic harmonic levels include overheating of transformers, motors, drives, cables, thermal tripping of protective devices and logic faults of digital devices. In addition, the life span of many devices can be reduced by elevated operating temperature.

**The Solution:** The AccuSine PCS+ AHF provides the simplest and most effective means to mitigate harmonics, to reduce process related voltage fluctuations. The AccuSine PCS+ AHF actively injects opposite harmonics current on the source side of the load and it:

- Decreases harmonic related overheating of cables, switchgear and transformers
- Reduces downtime caused by nuisance thermal tripping of protective devices
- Increases electrical network reliability and reduces operating costs
- Corrects to the 51st harmonic, reduce harmonics level to meet IEEE 519, IEC 61000 3-4, and UK G5/4-1 standards.
- Compensates entire network or specific loads depending on installation point

**Standard Features:**

- Real-time dynamic current injection for harmonic cancellation and VAR compensation (lead or lag power factor)
- Load balancing capability
- Parallel connection allows for easy retrofit and installation of multiple units for large networks
- Response to load fluctuations within 2 cycles for harmonics, 1/4 cycle for power factor or load balancing
- Full color touch screen HMI (Human Machine Interface)
- UL Type 1, UL Type 2, UL Type 12, IP31, and IP54 enclosures
- Seismic rated per ICC IBC and ASCE 7
- UL, CE, ABS, and CSA certified
- AccuSine PCS+ integrates with EcoStruxure™ Power's edge control power management and control software and analytics services that scale to your demands and adapt to your needs.

**AccuSine PCS+ Sizing:** For proper sizing of AccuSine units, contact your local Schneider Electric representative or visit us at <https://www.se.com/us/powerandenergy>. To expedite the product selection process, please have a single line diagram and/or details of the application including sizes of transformers, non-linear and linear loads, and any existing filters and capacitors.

**Table 4.56: PCS+ Active Harmonic Filter Selection**

AccuSine PCS+ (380–480 V, 50/60 Hz)							
Rated Current	KVAR Rating @ Voltage	Catalog Number	Enclosure			Frame	Weight lb (kg)
			Rating	Style	Cable Entry		
60[5]	39.5 @ 380 41.6 @ 400 43.1 @ 415 49.9 @ 480	PCSP060D5IP00	IP00 (chassis)	Wall Mount	Bottom	1	194 (88)
		PCSP060D5N2	UL Type 2	Floor Standing	Top or Bottom	2	611 (277)
		PCSP060D5IP31	IP31				
		PCSP060D5N12	UL Type 12				
		PCSP060D5IP54	IP54				
PCSP120D5IP00	IP00 (chassis)	Wall Mount	Bottom	3	249 (113)		
120[6]	79.0 @ 380 83.1 @ 400 86.3 @ 415 99.8 @ 480	PCSP120D5N2	UL Type 2	Floor Standing	Top or Bottom	4	615 (279)
		PCSCP120D5IP31	IP31				
		PCSP120D5N12	UL Type 12				
		PCSP120D5IP54	IP54				
		PCSP200D5IP00	IP00 (chassis)	Wall Mount	Bottom	5	377 (171)
200[7]	131.6 @ 380 138.6 @ 400 143.8 @ 415 166.3 @ 480	PCSP200D5N1	UL Type N1	Floor Standing	Top or Bottom	6	846 (384)
		PCSP200D5N2	UL Type 2				
		PCSP200D5IP31	IP31				
		PCSP200D5N12	UL Type 12				
		PCSP200D5IP54	IP54				
PCSP300D5IP00	IP00 (chassis)	Wall Mount	Bottom	7	463 (210)		
300[8]	197.5 @ 380 207.8 @ 400 215.6 @ 415 249.4 @ 480	PCSP300D5N1	UL Type N1	Floor Standing	Top or Bottom	8	930 (422)
		PCSP300D5N2	UL Type 2				
		PCSP300D5IP31	IP31				
		PCSP300D5N12	UL Type 12				
		PCSP300D5IP54	IP54	Wall Mount	Bottom	11	887 (402)

[5] 60 A IP20/UL Type 1 configuration requires ordering two items: PCSP060D5IP00 and PCSPWMKIT60A; adds 9.13 in (232 mm) to IP00 length and 19.18 lb (8.7 kg).  
 [6] 120 A IP20/UL Type 1 configuration requires ordering two items: PCSP120D5IP00 and PCSPWMKIT120A; adds 9.13 in (232 mm) to IP00 length and 20.5 lb (9.3 kg).  
 [7] 200 A IP20/UL Type 1 configuration requires ordering two items: PCSP200D5IP00 and PCSPWMKIT300A; adds 10.75 in (273 mm) to IP00 length and 19 lb (8.6 kg).  
 [8] 300 A IP20/UL Type 1 configuration requires ordering two items: PCSP300D5IP00 and PCSPWMKIT300A; adds 10.75 in (273 mm) to IP00 length and 19 lb (8.6 kg).

### AccuSine PCSn Active Harmonic Filter (AHF)

Part of the AccuSine+ family, the AccuSine PCSn is the ideal solution for harmonic mitigation in commercial buildings, light industry, and other less-harsh environments. In addition to 3-phase mitigation, AccuSine PCSn can compensate for neutral harmonic currents, typically present in building and commercial environments where single-phase non-linear loads are present.



- Configurable: One solution for multiple needs, AccuSine PCSn can be configured for Harmonic Mitigation + PF Improvement + Mains Load Balancing.
- Best-in-class performance to reduce THDi < 3%: Built on award winning AccuSine+ technology, this guarantees a harmonic-free system, improving system reliability, and increasing operational efficiency and uptime.
- Power Factor (cosφ), THDi, and THDv setpoint features provide system-level visibility and control, ensuring that you comply with utility code, and that your system is running at optimal efficiency.
- Harmonic mitigation eliminates harmonic current in the neutral. In a 3-phase system, unbalanced loads introduce a current in the neutral. Applying the mains load balancing function reduces the neutral current to zero, resulting in a perfectly stable system.
- Smart commissioning: Automatic CT polarity detection and correction, intelligent paralleling algorithm saves you time through unit self-identification, system view allows commissioning of the entire system from any one unit.
- Simple Scalability: Add more AccuSine modules as your harmonic mitigation needs change with your load requirements, easily integrating new modules through intelligent paralleling capabilities.
- With conventional power quality solutions you need high capital investment, incur large operating costs and may find it difficult to comply with IEEE 519 guidelines. The PCSn is the perfect alternative to conventional solutions like Harmonic Mitigation Transformers, Isolation Transformers, Passive Filters, Dual winding transformers.
- AccuSine PCSn integrates with EcoStruxure™ Power's edge control power management and control software and analytics services that scale to your demands and adapt to your needs.
- CE and cULus certified.

**AccuSine PCSn Sizing:** For proper sizing of AccuSine units, contact your local Schneider Electric representative or visit us at <https://www.se.com/us/powerandenergy>. To expedite the product selection process, please have a single line diagram and/or details of the application including sizes of transformers, non-linear and linear loads, and any existing filters and capacitors.

Table 4.57: AccuSine PCSn Commercial References

AccuSine PCSn 208–415 V, 50/60 Hz, UL Type 1, Wall Mount								
Catalog Number	Rated Current (A)	Neutral Rated Current (A)	Rated kVAR @ 208 V	Unit Type	Breaker Rating Required (A) <sup>[9]</sup>	Exterior Dimensions (H x W x D)	Mass	Cable Entry
PCSN020Y4N1	20 A	60 A	7.02	Main	25 A	57 in x 17.5 in x 10.5 in	163 lb	Bottom
PCSN030Y4N1	30 A	90 A	10.8	Main	40 A		163 lb	
PCSN050Y4N1	50 A	150 A	18.0	Main	63 A		163 lb	
PCSN060Y4N1	60 A	180 A	21.6	Main	80 A		196 lb	
PCSN060Y4N1E	60 A	180 A	21.6	Expansion	80 A		196 lb	

**NOTE:** All dimensions are indicative. Please refer to the dimensions in the installation manual and engineering drawings for design purposes.

<sup>[9]</sup> Applicable for TN-C, TN-S, TN-C-S grounding systems. For detailed information please refer to the AccuSine PCSn installation manual.



# Section 5

## Protection, Control, and Energy Automation

### Protection Relays



ECOFIT™ 50/51



V125



Sepam™



MiCOM™

### SAGE RTUs



2400

1410

1430

1450



4400



3030 Magnum

### Easergy™ T300 RTUs



HU250



SC150



LV150



PS50



PS25

### Introduction — Energy Automation Solutions 5-2

Schneider Electric Energy Automation Solutions	5-2
Overview of System Protection Products	5-2

### V125 Protection Relays 5-3

### ECOFIT Protection Relays 5-4

### Sepam™ Protection Relays 5-5

The Sepam™ Range — Introduction	5-5
Sepam™ Protection Configurations	5-6
Sepam™ Characteristics	5-7
Sepam™ 20 Ordering Configurations	5-8
Sepam™ 40 Ordering Configurations	5-8
Sepam™ 80 Ordering Configurations	5-9
Sepam™ Substation Applications	5-10
Sepam™ Motor Applications	5-11
Sepam™ Transformer Applications	5-12
Sepam™ Generator Applications	5-13
Sepam™ Busbar Applications	5-14
Sepam™ Capacitor Applications	5-15

### MiCOM Protection Relays 5-16

The MiCOM Range — Introduction	5-16
MiCOM Series Characteristics	5-16
MiCOM Self-Powered Applications	5-18
MiCOM Substation Applications	5-18
MiCOM Motor Applications	5-20
MiCOM Transformer Applications	5-21
MiCOM Generator Applications	5-22
MiCOM Busbar Applications	5-23
MiCOM Distance Applications	5-24
MiCOM Line Differential Applications	5-25
MiCOM Railway Applications	5-26

### SAGE RTUs (Remote Terminal Units) 5-27

The SAGE RTU Range	5-27
SAGE 2400 RTUs	5-28
SAGE 3030 Magnum RTUs	5-29
SAGE 4400 RTUs	5-29
SAGE 1410 RTUs	5-30
SAGE 1430 RTUs	5-30
SAGE 1450 RTUs	5-31
SAGE Sales and Support	5-31

### Easergy™ T300 RTUs (Remote Terminal Units) 5-32

The Easergy T300 RTU Range	5-32
Easergy™ HU250 Communication Gateway	5-33
Easergy™ SC150 MV Switch Controller	5-33
Easergy™ LV150 LV Transformer Monitor	5-33
Easergy™ Backup Power Supplies	5-34

### Network Protection Relays - Easergy™ P Series 5-35

Easergy P3 Range	5-35
Easergy P3 Characteristics	5-35
Easergy P3 Applications	5-36

## Introduction — Schneider Electric Energy Automation Solutions

Schneider Electric has proven solutions for the protection, monitoring and control of any critical infrastructure power system, whether large or small. Starting with a full range of Protective Relays for Medium or Low voltage distribution systems that provide dependability and reliability, Schneider Electric fits the bill. Sepam, MiCOM and ECOFIT are the front line of protection. Add the V125 for Arc Flash protection and you have a robust system for equipment protection. Let Schneider Electric's Energy Automation Solutions provide the Protection, Monitoring, and Control you need!

Schneider Electric's ranges for Remote Terminal Units (RTU) includes SAGE and T300. SAGE is a rack mount solution offering IED integration, NERC CIP security, IEC 61131-based logic functions, communications protocols, and a custom applications library.

T300 is a modular form factor feeder RTU for Medium Voltage and Low Voltage public distribution network management.

### System Protection Solutions

Schneider Electric's family of protective relays have been protecting power systems world wide for over 100 years. From electric utilities to commercial buildings and data centers, customers know that Schneider Electric has the right relay solution for them. Today's modern relays are much more than simple overcurrent devices. They provide power system protection as well as arc flash protection in one device all while communicating to SCADA or DCS systems seamlessly. Whether it is a new installation or a retrofit opportunity, Schneider Electric has the answer.



V125 Arc Flash Module

#### V125 Arc Flash Module

Arc flash incidents are very real and very dangerous. The Schneider Electric V125 arc flash module provides detection in as low as 2 milliseconds to help mitigate equipment damage. Up to four (4) point sensors are brought into the V125 from different compartments in switchgear, such as the cable, breaker and bus compartments. The module is set with simple DIP switches and can be set up to deliver zones of arc flash protection. Installation is easy with a DIN rail or a door mount option.



ECOFIT 50/51

#### ECOFIT 50/51

The ECOFIT 50/51 Plug and Protect numerical relay is a direct replacement for many GE IAC and IFC relays that are still in service today. No re-wiring is required. Remove the old relay and install the ECOFIT 50/51 and its cover. The relay has 31 different overcurrent curves built in and features an instantaneous element that can trip in as little as 1.5 cycles. Gain the benefits of waveform capture, sequence of events and metering that were not possible with the older electromechanical relays.



Sepam Digital Relays

#### Sepam™ Digital Relays

Sepam relays feature outstanding modularity and are ideal for a myriad of applications, including industrial and commercial feeder, motor, transformer, generator, busbar, and capacitor applications. Built-in breaker control, automatic throwover, and zone selective interlocking logic makes Sepam easy to configure and test. The family consists of three (3) ranges, Series 20, Series 40 and Series 80, allowing customers to purchase the right amount of relay for their particular application.



MiCOM Relays

#### MiCOM Relays

MiCOM relays provide utility grade protection with deep cyber security features. Large or small power systems; simple or complex applications are all covered in the MiCOM line of products.

**V125 Arc Flash Protection Solutions**

Critical infrastructure depends heavily on an uninterrupted supply of electric power. Arc flash protection devices help accomplish this and are used to improve safety and mitigate equipment damage. Schneider Electric is the pioneer in the field of arc flash protection with close to 50,000 arc flash systems and 600,000 sensors in service worldwide. The V125 arc flash protection module can detect an arc flash event in as little as 2 milliseconds and send a control command to an interrupting device. It can accommodate up to four (4) point sensors and has a wide range 24 to 240 volt ac or dc power supply. It can be DIN rail mounted or door mounted and is easily set via DIP switches.



V125 Arc Flash Protection Unit

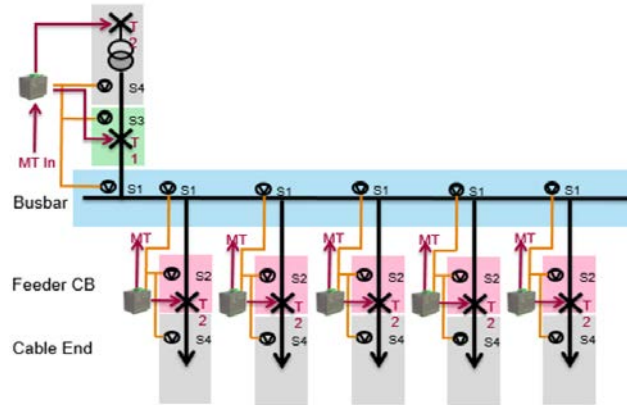

V125 Arc Flash Protection Unit with Optional REL52901 Door Mount Bracket



REL52901 Door Mount Bracket

**Table 5.1: V125 Arc Flash Protection Units**

Description	Cortec Type	Note	Catalog Number
Arc flash protection unit	V125		REL52900
Arc Sensor	VA 1 DA-6	Cable length 19.69 ft	REL52804
Arc Sensor	VA 1 DA-20	Cable length 65.62 ft	REL52801
Arc Sensor (Pipe type)	VA 1 EH-6	Cable length 19.69 ft	REL52809
Arc Sensor (Pipe type)	VA 1 EH-20	Cable length 65.62 ft	REL52807
Arc Sensor (Pipe type, IP65)	VA 1 EH-6-IP	Cable length 19.69 ft	
Arc Sensor (Pipe type, IP65)	VA 1 EH-20-IP	Cable length 65.62 ft	
Arc Sensor, shielded (metal pipe)	VA 2 DV-15	Cable length 49.22 ft	
Arc Sensor, shielded (metal pipe)	VA 2 DV-20	Cable length 65.62 ft	
Door mount bracket		For V125	REL52901
Surface Mounting Plate for Sensors	VYX001	Z-shaped	REL52828
Surface Mounting Plate for Sensors	VYX002	L-shaped	REL52829
Surface Mounting Plate for VA 1 DV Sensor	VYX628	U-shaped	
I/O unit 3 phase current 1 trip contact, ring lug connections	VAM4CSE-RL		



VAM4CSE-RL current module



Arc Flash point sensor Type VA 1D

**VYX 001**

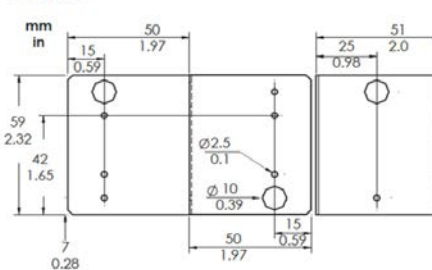

VYX 001 Surface Mounting Plate for sensors

**VYX 002**

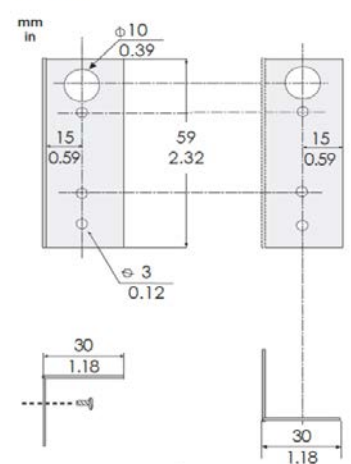

VYX 002 Surface Mounting Plate for sensors

### ECOFIT 50/51 Retrofit Relays

The Schneider Electric ECOFIT 50/51 single phase or ground time overcurrent relays are direct plug and protect replacements for many GE IAC or GE IFC electromechanical, GE DIAC and Basler BE1-50/51B replacements for GE IAC relays. The relays are self-powered from 50 or 60 Hz systems and are designed to be one to one replacements for existing electromechanical or digital relays. The relays are equipped with 31 built-in protection curves. ECOFIT 50/51 provides information that was not available in the E/M relays: (1) Twenty (20) overcurrent fault records time-tagged to the millisecond; (2) 200 events records time stamped to the millisecond; (3) Ten (10) Disturbance records up to 4 seconds per record at a sample rate of 32 samples per cycle. Plug and Protect reduces costs in installation time because it saves existing wiring and reduces engineering costs over other options. A 10-year warranty is standard.

Also refer to [ECOFIT 50/51](http://www.schneider-electric.us) on the [www.schneider-electric.us](http://www.schneider-electric.us) website.

#### Catalog Number Configuration



The Schneider Electric ECOFIT 50/51 is a direct replacement for many GE IAC relays.

The Schneider Electric ECOFIT 50/51 is a direct replacement for many GE IFC relays.

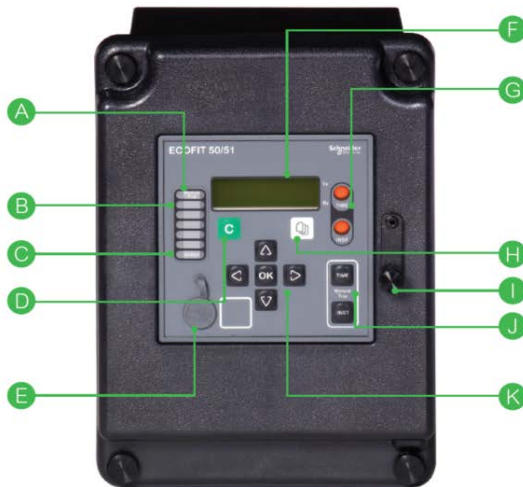

Function Reference	Control or Indicator
A	Manual Trip Mode LED
B	Programmable LEDs
C	Active LED
D	Clear Button
E	USB Port
F	HMI Display
G	Trip Indicators
H	Read button
I	Mechanical Reset
J	Manual Trips
K	Navigation Buttons

## The Sepam™ Range

Sepam protection relays are time-tested, high-performance devices that ensure dependability. This range of products was designed with a simple idea in mind: All users should be able to find a solution corresponding exactly to their needs with the right balance between performance, simplicity and cost. With Series 20, 40 and 80, the Sepam range does just this. This family of relays offers a solution for every application need, specifically targeting industrial installations. These multi-functional protection devices allow an easy and hassle-free startup with simple-to-use programming software. Sepam relays also comply with the latest communication protocols on the market, including IEC61850, DNP3 and Modbus. In addition, all relays within this range come with a standard 10-year warranty and conformal coating for protection against harsh environments.

### Features and Benefits

- Compact devices with clearly defined connection terminals for easy installation
- Predefined control logic for circuit breaker control or contactor control
- Predefined control logic for Zone Selective Interlocking applications
- Predefined control logic for Automatic Transfer applications
- User-friendly software (SFT2841) with built-in manuals for every relay
- Support for offline programming
- Application-specific design ensuring appropriate protection for any given application
- Low power CT options for the use of relays on new installations where the load is low
- Field-upgradable technology to stay up-to-date on the latest hardware and software

### Sepam Series 20

The Series 20 consists of high-performing solutions suited for standard applications requiring current or voltage protection.

Applications Covered:

- Substation (feeder)
- Transformer
- Motor
- Busbar

### Sepam Series 40

The Series 40 family of protection relays are designed for demanding applications requiring current, voltage and/or frequency protection.

- Substation (feeder)
- Transformer
- Motor
- Generator

### Sepam Series 80

The Series 80 relays are for custom applications requiring enhanced protection of electrical distribution networks.

Applications Covered:

- Substation (feeder)
- Transformer
- Motor
- Generator
- Busbar
- Capacitor



Sepam Series 20 and 40



Sepam Series 80

### Sepam Protection Configurations

Three relay series with increasing protection capabilities for six types of applications to provide all possible protection configurations

**Table 5.2: Sepam 20, 40 and 80 Protection Functions**

ANSI Device Number	Description	Sepam 20/40 Relay Models								Sepam 80 Relay Models								
		S24	M20	B22	S40	T40	T42	M41	G40	S84	M87	M88	T87	G87	G88	C86	B80	B83
12/14	Speed Switch		•					•			•	•		•	•			
21B	Underimpedance													•	•			
24	Volts/Hertz												•	•				
25	Synch Check								•				•	•			•	•
26	Thermostat					•	•				•	•		•				
27	Phase-to-phase Undervoltage			•	•	•	•	•	•	•	•	•	•	•	•	•	•	•
27D	Positive sequence Undervoltage			•				•		•	•	•	•	•	•	•	•	•
27R	Remnant Undervoltage			•				•		•	•	•	•	•	•	•	•	•
27S	Phase-to-neutral Undervoltage			•	•	•	•	•	•	•	•	•	•	•	•	•	•	•
27TN	Third Harmonic Neutral Undervoltage												•	•				
32P	Directional Power							•	•	•	•	•	•	•	•	•	•	•
32Q/40/55	Directional Reactive Power							•	•	•	•	•	•	•	•	•	•	•
37	Phase Undercurrent		•					•		•	•	•	•	•	•	•	•	•
38	Bearing Temperature		•					•		•	•	•	•	•	•	•	•	•
40	Loss of Excitation							•	•	•	•	•	•	•	•	•	•	•
46	Negative Sequence Current/Unbalance	•	•		•	•	•	•	•	•	•	•	•	•	•	•	•	•
47	Negative Sequence Undervoltage			•	•	•	•	•	•	•	•	•	•	•	•	•	•	•
48	Excessive Starting Time		•					•		•	•	•	•	•	•	•	•	•
49	Thermal Overload		•					•		•	•	•	•	•	•	•	•	•
49T	RTD Monitoring		•					•		•	•	•	•	•	•	•	•	•
50BF	Breaker Failure	•			•	•	•	•	•	•	•	•	•	•	•	•	•	•
50/27	Inadvertent Energization												•	•				
50	Instantaneous Phase Overcurrent	•	•		•	•	•	•	•	•	•	•	•	•	•	•	•	•
50G	Instantaneous Ground Overcurrent (Measured)		•		•	•	•	•	•	•	•	•	•	•	•	•	•	•
50N	Instantaneous Ground Overcurrent (Calculated)	•	•		•	•	•	•	•	•	•	•	•	•	•	•	•	•
50V	Voltage Restrained Instantaneous Overcurrent												•	•	•	•	•	•
51	Time Phase Overcurrent	•	•		•	•	•	•	•	•	•	•	•	•	•	•	•	•
51C	Capacitor Bank Unbalance															•	•	•
51G	Time Ground Overcurrent (Measured)		•		•	•	•	•	•	•	•	•	•	•	•	•	•	•
51N	Time Ground Overcurrent (Calculated)	•	•		•	•	•	•	•	•	•	•	•	•	•	•	•	•
51LR	Locked Rotor		•					•		•	•	•	•	•	•	•	•	•
50V	Voltage Restrained Instantaneous Overcurrent								•									
51V	Voltage Restrained Time Overcurrent								•					•	•			
59	Phase-to-phase Overvoltage			•	•	•	•	•	•	•	•	•	•	•	•	•	•	•
59N	Neutral Voltage Displacement			•	•	•	•	•	•	•	•	•	•	•	•	•	•	•
63	Buchholz Pressure					•	•						•	•				
64G	100% Stator Ground Fault													•	•			
64REF	Restricted Ground Fault												•	•				
66	Starts per hour		•					•		•	•	•	•	•	•	•	•	•
67	Directional Phase Overcurrent								•				•	•	•	•	•	•
67N	Directional Ground Overcurrent								•	•	•	•	•	•	•	•	•	•
78	Pole Slip									•	•	•	•	•	•	•	•	•
79	Reclosing	•			•					•								
81H	Overfrequency			•	•	•	•	•	•	•	•	•	•	•	•	•	•	•
81L	Underfrequency			•	•	•	•	•	•	•	•	•	•	•	•	•	•	•
81R	Rate of Change of Frequency			•						•								
87M	Machine Differential									•			•	•	•	•	•	•
87T	2 Winding Transformer Differential											•	•	•	•	•	•	•

Sepam™ 20/40/80 Characteristics

Table 5.3: Protection Configurations

Characteristics	Series 20	Series 40	Series 80
Logic inputs	0-10	0-10	0-42
Logic outputs	4-8	4-8	5-23
Temperature sensors	0-8	0-16	0-16
Channels	Current 3I + I0	Current 3I + I0	Current 2 x 3I + 2 x I0
	Voltage 3V + V0	Voltage 3V + V0	Voltage 2 x 3V + V0
	LPCT [1]	LPCT [1]	LPCT [1]
Communication Ports	1-2	1-2	2-4
	ModBus, IEC 103, DNP3, IEC 61850	ModBus, IEC 103, DNP3, IEC 61850	ModBus, IEC 103, DNP3, IEC 61850
	—	Redundancy	Redundancy
Control	—	—	Goose Messaging
	Matrix [2]	Matrix [2]	Matrix [2]
	—	Logic equation editor	Logic equation editor
Other	—	—	Logipam [3]
	—	—	Front memory cartridge with settings
	—	Backup 48 hours (capacitor)	Backup lithium battery [4]

Table 5.4: Metering Measurements (Basic — Sepam Series 20)

Metering	Measurement Range	Accuracy
Phase Current / Residual Current (Calculated)	0.1 to 40 In	±1%
Residual Current (Measured)	0.1 to 20 In0	±1%
Demand Current / Peak Demand Current	0.1 to 40 In	±1%
Phase-to-Phase Voltage / Phase-to-Neutral Voltage	0.05 to 1.2 Vnp	±1%
Residual Voltage	0.015 to 3 Vnp	±1%
Positive Sequence Voltage	0.05 to 1.2 Vnp	±5%
Frequency	50 ± 5 Hz or 60 ± 5 Hz	±0.05 Hz
Temperature	-22 to +392 °F (-30 to +200 °C)	±1 °C from -20 to +140 °C

Table 5.5: Metering Measurements (Standard — Sepam Series 40)

Metering	Measurement Range	Accuracy
Phase Current / Residual Current (Calculated)	0.1 to 40 In	±0.5%
Residual Current (Measured)	0.1 to 20 In0	±1%
Demand Current / Peak Demand Current	0.1 to 40 In	±0.5%
Phase-to-Phase Voltage / Phase-to-Neutral Voltage	0.06 to 1.2 Vnp	±0.5%
Residual Voltage	0.04 to 3 Vnp	±1%
Positive Sequence Voltage / Negative Sequence Voltage	0.05 to 1.2 Vnp	±2%
Frequency	25 to 65 Hz	±0.02 Hz
Active Power	0.015 Sn to 999 MW	±1%
Reactive Power	0.015 Sn to 999 MVar	±1%
Apparent Power	0.015 Sn to 999 MVA	±1%
Peak Demand Active Power	0.015 Sn to 999 MW	±1%
Peak Demand Reactive Power	0.015 Sn to 999 MVar	±1%
Power Factor	-1 to +1 (CAP/IIND)	±1%
Calculated Active Energy	0 to 2.1x108 MWH	±1% ±1 digit
Calculated Reactive Energy	0 to 2.1x108 MVARH	±1% ±1 digit
Temperature	-22 to +392 °F (-30 to +200 °C)	±1 °C from -20 to +140 °C

Table 5.6: Metering Measurements (Advanced — Sepam Series 80)

Metering	Measurement Range	Accuracy
Phase Current	0.02 to 40 In	±0.5%
Residual Current (Calculated)	0.005 to 40 In	±1%
Residual Current (Measured)	0.005 to 20 In0	±1%
Demand Current / Peak Demand Current	0.02 to 40 In	±0.5%
Phase-to-Phase Voltage / Phase-to-Neutral Voltage	0.05 to 1.2 Vnp	±0.5%
Residual Voltage / Neutral Point Voltage	0.015 to 3 Vnp	±1%
Positive Sequence Voltage / Negative Sequence Voltage	0.05 to 1.2 Vnp	±2%
Frequency	50 ± 5 Hz or 60 ± 5 Hz	±0.01 Hz
Active Power	0.008 Sn to 999 MW	±1%
Reactive Power	0.008 Sn to 999 MVar	±1%
Apparent Power	0.008 Sn to 999 MVA	±1%
Peak Demand Active Power	0.008 Sn to 999 MW	±1%
Peak Demand Reactive Power	0.008 Sn to 999 MVar	±1%
Power Factor	-1 to +1 (CAP/IIND)	±1%
Calculated Active Energy	0 to 2.1x108 MWH	±1% ±1 digit
Calculated Reactive Energy	0 to 2.1x108 MVARH	±1% ±1 digit
Temperature	-22 to +392 °F (-30 to +200 °C)	±1 °C from -20 to +140 °C
Rotation Speed	0 to 7200 RPM	±1 RPM

[1] LPCT: low-power current transducer complying with standard IEC 60044-8.

[2] Control matrix for simple assignment of information from the protection, control and monitoring functions.

[3] Logipam ladder language (PC programming environment) to make full use of Sepam series 80 functions.

[4] Standard lithium battery 1/2 AA format 3.6 V front face exchangeable.

Sepam™ 20 Configuration

Table 5.7: Sepam Series 20 Configuration

Model	Description	Relay Base Model	–	–	–	–	–	–	–	–	–
S24	S24 — Substation Relay	SQ1S24	Display	Current	Coms	I/O	RTDs	Analog Out	Logipam	Synch Check	
B22	B22 — Busbar Relay	SQ1B22									
M20	M20 — Motor Relay	SQ1M20									
T24	T24 — Transformer Relay	SQ1T24									
	Advanced Display		A								
DSM303	Remote Advanced Display		R								
	Voltage Inputs Only (Required for Busbar Relays)			0							
CCA634	1A/5A CT inputs			1							
CCA630	Alt. 1A/5A CT inputs (requires CSH120, 200 or 30)			2							
CCA670	Low Power CT (LPCT)			3							
MES114	10In/4Out, 24–48Vdc/120–250Vac			A							
MES114E	10In/4Out, 110–125Vdc/110Vac			B							
MES114F	10In/4Out, 220–250Vdc/220–220Vac			C							
ACE959	1 x RS485			1							
ACE969TP2	2 x RS485			2							
ACE969FO2	1 x RS485/ 1 x Fiber Optic			3							
	without (not available on Substation or Busbar relays)			A							
MET1482	8 Temp sensor inputs			B							
	without			0							
MSA141	1 x Analog 0–1mA, 0–10mA, 0–20mA, 4–20mA output			1							
	Without (80 Series Only)			A							
	Without (80 Series Only)			0							

Table 5.8: Sepam Series 20 Typical Catalog Numbers

Catalog Numbers	Description
SQ1S24A1B1A0A0	Series 20 - Substation/Feeder Protection S24 (24-250Vdc & 120-240Vac), 1/5A CT inputs, 10In/8Out (110-125 Vdc, 110Vac), RS485
SQ1M20A1B1B0A0	Series 20 - Motor Protection M20 (24-250Vdc & 120-240Vac), 1/5A CT inputs, 10In/8Out (110-125 Vdc, 110Vac), 8 RTD's, RS485
SQ1T24A1B1A0A0	Series 20 - Transformer Protection T24 (24-250Vdc & 120-240Vac), 1/5A CT inputs, 10In/8Out (110-125 Vdc, 110Vac), RS485
SQ1B22A0B1A0A0	Series 20 - Voltage Protection B22 (24-250Vdc & 120-240Vac), Voltage Inputs ONLY, 10In/8Out (110-125 Vdc, 110Vac), RS485

Also refer to Sepam Series 20 on www.schneider-electric.us.

Sepam 40 Configuration

Table 5.9: Sepam Series 40 Configuration

Model	Description	Relay Base Model	–	–	–	–	–	–	–	–
S42	S42 - Substation Relay	SQ1S42	Display	Current	Coms	I/O	RTDs	Analog Out	Logipam	Synch Check
G40	G40 - Generator Relay	SQ1G40								
M41	M41 - Motor Relay	SQ1M41								
T42	T42 - Transformer Relay	SQ1T42								
	Advanced Display		A							
DSM303	Remote Advanced Display		R							
CCA634	1A/5A CT inputs			1						
CCA630	Alt. 1A/5A CT inputs (requires CSH120, 200 or 30)			2						
CCA670	Low Power CT (LPCT)			3						
MES114	10In/4Out, 24-48Vdc/120-250Vac			A						
MES114E	10In/4Out, 110-125Vdc/110Vac*			B						
MES114F	10In/4Out, 220-250Vdc/220-240Vac			C						
ACE959	1 x RS485			1						
ACE969TP2	2 x RS485			2						
ACE969FO2	1 x RS485/ 1 x Fiber Optic			3						
ACE850TP	2 x Ethernet Ports (Copper, IEC61850/ModbusTCP)			5						
ACE850FO	2 x Ethernet Ports (Fiber, IEC61850/ModbusTCP)			6						
	without			A						
MET1482	8 Temp sensor inputs (One Module)			B						
2 x MET1482	16 Temp sensor inputs (Two Modules)			C						
	without			0						
MSA141	1 x Analog 0-1mA, 0-10mA, 0-20mA, 4-20mA output			1						
	without (80 Series Only)			A						
	without (80 Series Only)			0						

Table 5.10: Sepam Series 40 Typical Catalog Numbers

Catalog Numbers	Description
SQ1S42A1B1A0A0	Series 40 Substation/Feeder Protection S42 (24-250Vdc & 120-240Vac), 1/5A CT inputs, 10In/8Out (110-125 Vdc, 110Vac), RS485
SQ1S42A1B5A0A0	Series 40 Substation/Feeder Protection S42 (24-250Vdc & 120-240Vac), 1/5A CT inputs, 10In/8Out (110-125 Vdc, 110Vac), 2 x RJ-45 Ethernet - Modbus/IEC61850
SQ1M41A1B1B0A0	Series 40 Motor Protection M41 (24-250Vdc & 120-240Vac), 1/5A CT inputs, 10In/8Out (110-125 Vdc, 110Vac), 8 RTD's, RS485
SQ1T42A1B1A0A0	Series 40 Transformer Protection T42 (24-250Vdc & 120-240Vac), 1/5A CT inputs, 10In/8Out (110-125 Vdc, 110Vac), RS485
SQ1G40A1B1A0A0	Series 40 Generator Protection G40 (24-250Vdc & 120-240Vac), 1/5A CT inputs, 10In/8Out (110-125 Vdc, 110Vac), RS485

Also refer to Sepam Series 40 on www.schneider-electric.us.



**Sepam 80 Configuration**

**Table 5.11: Sepam Series 40 Configuration**

Model	Description	Relay Base Model	–	–	–	–	–	–	–	–
S84	S84 - Substation Relay	SQ1S84	Display	Current	Coms	I/O	RTD's	Analog Out	Logipam	Synch Check
B80	B80 - Busbar Relay	SQ1B80								
B83	B83 - Busbar Relay	SQ1B83								
G87	G87 - Generator Relay	SQ1G87								
G88	G88 - Generator Relay	SQ1G88								
M87	M87 - Motor Relay	SQ1M87								
M88	M88 - Motor Relay	SQ1M88								
T87	T87 - Transformer Relay	SQ1T87								
C86	C86 - Capacitor Bank Relay	SQ1C86								
	Advanced Display									
MimicBus	MimicBus Display		P							
DSM303	Remote Advanced Display		C							
CCA634	1A/5A CT inputs		1							
CCA630	Alt. 1A/5A CT inputs (requires CSH120, 200 or 30)		2							
CCA671(80)	Low Power CT (LPCT)		3							
MES120	14In/6Out, 24-48Vdc		D							
2 x MES120	28In/12Out, 24-48Vdc		E							
3 x MES120	42In/18Out, 24-48Vdc		F							
MES120G	14In/6Out, 220-250Vdc		G							
2 x MES120G	28In/12Out, 220-250Vdc		H							
3 x MES120G	42In/18Out, 220-250Vdc		I							
MES120H	14In/6Out, 110-125Vdc		J							
2 x MES120H	28In/12Out, 110-125Vdc		K							
3 x MES120H	42In/18Out, 110-125Vdc		L							
ACE959	1 x RS485		1							
ACE969TP2	2 x RS485		2							
ACE969FO2	1 x RS485/ 1 x Fiber Optic		3							
ACE850TP	2 x Ethernet Ports (Copper, IEC61850/ModbusTCP)		5							
ACE850FO	2 x Ethernet Ports (Fiber, IEC61850/ModbusTCP)		6							
	without		A							
MET1482	8 Temp sensor inputs (One Module)		B							
2 x MET1482	16 Temp sensor inputs (Two Modules)		C							
	without		0							
MSA141	1 x Analog 0-1mA, 0-10mA, 0-20mA, 4-20mA output		1							
	without		A							
SFT080	Logipam Firmware		B							
	without		0							
MCS025	Sync-Check Module (required for ANSI-25)		1							

**Table 5.12: Sepam Series 80 Typical Catalog Numbers**

Catalog Numbers	Description
SQ1S84P1J5A0B0	Series 80 - Substation/Feeder Protection S84 (24-250Vdc), mimicBus Graphical Display, 1/5A CT inputs, 14In/11Out Digital Module (110-125Vdc/mid p.u.), 2 x RJ-45 ports (Modbus or IEC61850 with GOOSE), ladder logic firmware (PLC base).
SQ1B83P1J5A0B1	Series 80 - Busbar Protection B83 (24-250Vdc), mimicBus Graphical Display, 1/5A CT inputs, 14In/11Out Digital Module (110-125Vdc/mid p.u.), 2 x RJ-45 ports (Modbus or IEC61850 with GOOSE), ladder logic firmware (PLC base), Synchro-check
SQ1G87P1J5A0B0	Series 80 - Generator Differential Protection G87 (24-250Vdc), mimicBus Graphical Display, 1/5A CT inputs, 14In/11Out Digital Module (110-125Vdc/mid p.u.), 2 x RJ-45 ports (Modbus or IEC61850 with GOOSE), ladder logic firmware (PLC base).
SQ1M87P1J5B0B0	Series 80 - Motor Differential Protection M87 (24-250Vdc), mimicBus Graphical Display, 1/5A CT inputs, 14In/11Out Digital Module (110-125Vdc/mid p.u.), 8 RTD's, 2 x RJ-45 ports (Modbus or IEC61850 with GOOSE), ladder logic firmware (PLC base).
SQ1T87P1J5A0B0	Series 80 - Transformer Differential Protection T87 (24-250Vdc), mimicBus Graphical Display, 1/5A CT inputs, 14In/11Out Digital Module (110-125Vdc/mid p.u.), 2 x RJ-45 ports (Modbus or IEC61850 with GOOSE), ladder logic firmware (PLC base).

Also refer to [Sepam Series 80](http://www.schneider-electric.us) on [www.schneider-electric.us](http://www.schneider-electric.us).

### Sepam Substation / Feeder Applications

Substation/Feeder protection is broken into three sections Basic, Standard, and Advanced. The Basic protection is covered with our Sepam S24 protection relay and handles overcurrent (50/51) and ground faults (50G/51G or 50N/51N). The Standard protection is covered with the Sepam S42 protection relay and covers a host of current, voltage, and frequency protection elements. The Advanced protection is covered with the Sepam S84 and covers current, voltage, frequency, and synchro check protection functions.



S24/S42

S84

#### Basic Protection Relay S24

Typical Catalog Number: **SQ1S24A1B1A0A0** Series 20 Substation/Feeder Protection S24 (24-250Vdc & 120-240Vac), 1/5A CT inputs, 10In/8Out (110-125 Vdc, 110Vac), RS485

#### Standard Protection Relay S42

Typical Catalog Number: **SQ1S42A1B1A0A0** Series 40 - Substation/Feeder Protection S42 (24-250Vdc & 120-240Vac), 1/5A CT inputs, 10In/8Out (110-125 Vdc, 110Vac), RS485

#### Advanced Protection Relay S84

Typical Catalog Number: **SQ1S84P1J5A0B0** Series 80 - Substation/Feeder Protection S84 (24-250Vdc), mimicBus Graphical Display, 1/5A CT inputs, 14In/11Out Digital Module (110-125Vdc/mid p.u.), 2 x RJ-45 ports (Modbus or IEC61850 with GOOSE), ladder logic firmware (PLC base).

Table 5.13: Features

Feature	Basic Protection Relay S24 Sepam 20 Series	Standard Protection Relay S42 Sepam 40 Series	Advanced Protection Relay S84 Sepam 80 Series	
Current Protection	•	•	•	
Built in CB Control	•	•	•	
Native Zone Selective Interlocking	•	•	•	
Waveform Captures	•	•	•	
Event Records	•	•	•	
Voltage Protection		•	•	
Frequency Protection		•	•	
Field Expandable Communications		•	•	
Synchro-check Protection (optional)			•	
Native Automatic Throw over Scheme			•	
Field expandable I/O			•	
Ladder Logic PLC custom programming (optional)			•	
Mimic-bus graphical display (optional)			•	
Onboard data logging			•	
Communications options	Modbus RTU	•	•	
	DPN	•	•	
	Modbus TCP/IP		•	•
	IEC61850-MMS		•	•
	IEC61850-MMS + GOOSE			•

Table 5.14: Functions

ANSI Device Number	Description	Basic Protection Relay S24 Sepam 20 Series	Standard Protection Relay S42 Sepam 40 Series	Advanced Protection Relay S84 Sepam 80 Series
25	Synch Check			•
27	Phase-to-phase undervoltage		•	•
27D	Positive sequence undervoltage			•
27R	Remnant undervoltage			•
27S	Phase-to-neutral undervoltage		•	•
32P	Directional Power		•	•
37	Phase Undercurrent			•
46	Negative Sequence Current/Unbalance	•	•	•
47	Negative Sequence undervoltage		•	•
49	Thermal Overload			•
50	Instantaneous Phase Overcurrent	•	•	•
50BF	Breaker Failure	•	•	•
50G	Instantaneous Ground Overcurrent (Measured)		•	•
50N	Instantaneous Ground Overcurrent (Calculated)	•	•	•
51	Time Phase Overcurrent	•	•	•
51G	Time Ground Overcurrent(Measured)		•	•
51N	Time Ground Overcurrent(Calculated)	•	•	•
59	Phase-to-phase overvoltage		•	•
59N	Neutral Voltage Displacement		•	•
67	Directional Phase Overcurrent		•	•
67N	Directional Ground Overcurrent		•	•
79	Reclosing	•	•	•
81H	Overfrequency		•	•
81L	Underfrequency		•	•
81R	Rate of Change of Frequency			•



M20/M41



M87/M88

### Sepam Motor Applications

Motor protection is broken into three sections Basic, Standard, and Advanced. The Basic protection is covered with our Sepam M20 protection relay and handles overcurrent (50/51) and ground faults (50G/51G or 50N/51N). The Standard protection is covered with the Sepam M41 protection relay and covers a host of current, voltage, and frequency protection elements. The Advanced protection is covered with the Sepam M87/M88 and covers current, voltage, frequency, and differential protection functions.

#### Basic Protection Relay (M20 - Sepam 20 Series)

Typical Part Number: **SQ1M20A1B1A0A0** Series 20 - Motor Protection M20 (24-250Vdc & 120-240Vac), 1/5A CT inputs, 10In/8Out (110-125 Vdc, 110Vac), RS485

#### Standard Protection Relay (M41 – Sepam 40 Series)

Typical Part Number: **SQ1M41A1B1A0A0** Series 40 - Motor Protection M41 (24-250Vdc & 120-240Vac), 1/5A CT inputs, 10In/8Out (110-125 Vdc, 110Vac), RS485

#### Advanced Protection Relay (M87/M88 – Sepam 80 Series)

Typical Part Number: **SQ1M87P1J5A0B0** Series 80 - Motor Protection S84 (24-250Vdc), mimicBus Graphical Display, 1/5A CT inputs, 14In/11Out Digital Module (110-125Vdc/ mid p.u.), 2 x RJ-45 ports (Modbus or IEC61850 with GOOSE), ladder logic firmware (PLC base).

Table 5.15: Features

Feature	M20	M41	M87/M88
Current Protection	•	•	•
Built in CB Control	•	•	•
Native Zone Selective Interlocking	•	•	•
Waveform Captures	•	•	•
Event Records	•	•	•
Voltage Protection		•	•
Frequency Protection		•	•
Field Expandable Communications		•	•
Synchro-check Protection (optional)			•
Native Automatic Throw over Scheme			•
Field expandable I/O			•
Ladder Logic PLC custom programming (optional)			•
Mimic-bus graphical display (optional)			•
Onboard data logging			•
Native Load Shedding and Motor Restart			•
Ability to incorporate a transformer into the same zone of protection (M88 only)			•
Built in Motor start and trending reports			•
Communications options	Modbus RTU	•	•
	DPN	•	•
	Modbus TCP/IP		•
	IEC61850-MMS		•
	IEC61850-MMS + GOOSE		•

Table 5.16: Functions

ANSI Device Number	Description	M20	M41	M87	M88
12/14	Speed Switch	•	•	•	•
26	Thermostat			•	•
27	Phase-to-phase undervoltage		•	•	•
27D	Positive sequence undervoltage		•	•	•
27R	Remnant Undervoltage		•	•	•
27S	Phase-to-neutral undervoltage		•	•	•
32P	Directional Power		•	•	•
32Q/40/55	Directional Reactive Power		•	•	•
37	Phase Overcurrent	•	•	•	•
38	Bearing Temperature	•	•	•	•
40	Loss of Excitation		•	•	•
46	Negative Sequence Current/Unbalance	•	•	•	•
47	Negative Sequence undervoltage		•	•	•
48	Excessive Starting Time	•	•	•	•
49	Thermal Overload	•	•	•	•
49T	RTD Monitoring	•	•	•	•
50BF	Breaker Failure		•	•	•
50	Instantaneous Phase Overcurrent	•	•	•	•
50G	Instantaneous Ground Overcurrent(Measured)	•	•	•	•
50N	Instantaneous Ground Overcurrent(Calculated)	•	•	•	•
51	Time Phase Overcurrent	•	•	•	•
51G	Time Ground Overcurrent(Measured)	•	•	•	•
51N	Time Ground Overcurrent(Calculated)	•	•	•	•
51LR	Locked Rotor	•	•	•	•
59	Phase-to-phase overvoltage		•	•	•
59N	Neutral Voltage Displacement		•	•	•
66	Starts per hour	•	•	•	•
67N	Directional Ground Overcurrent			•	•
78	Pole Slip			•	•
81H	Overfrequency		•	•	•
81L	Underfrequency		•	•	•
87M	Machine Differential			•	
87T	2 Winding Transformer Differential				•

### Sepam Transformer Applications

Transformer protection is broken into three sections Basic, Standard, and Advanced. The Basic protection is covered with our Sepam T24 protection relay and handles overcurrent (50/51) and ground faults (50G/51G or 50N/51N). The Standard protection is covered with the Sepam T42 protection relay and covers a host of current, voltage, and frequency protection elements. The Advanced protection is covered with the Sepam T87 and covers current, voltage, frequency, differential, and synchro check protection functions.



T24/T42

T87

#### Basic Protection Relay (T24 - Sepam 20 Series)

Typical Part Number: **SQ1T24A1B1A0A0** Series 20 - Transformer Protection T24 (24-250Vdc & 120-240Vac), 1/5A CT inputs, 10In/8Out (110-125 Vdc, 110Vac), RS485

#### Standard Protection Relay (T42 – Sepam 40 Series)

Typical Part Number: **SQ1T42A1B1A0A0** Series 40 - Transformer Protection T42 (24-250Vdc & 120-240Vac), 1/5A CT inputs, 10In/8Out (110-125 Vdc, 110Vac), RS485

#### Advanced Protection Relay (T87 – Sepam 80 Series)

Typical Part Number: **SQ1T87P1J5A0B0** Series 80 - Transformer Protection S84 (24-250Vdc), mimicBus Graphical Display, 1/5A CT inputs, 14In/11Out Digital Module (110-125Vdc/mid p.u.), 2 x RJ-45 ports (Modbus or IEC61850 with GOOSE), ladder logic firmware (PLC base).

Table 5.17: Features

Feature	T24	T42	T87
Current Protection	•	•	•
Built in CB Control	•	•	•
Native Zone Selective Interlocking	•	•	•
Waveform Captures	•	•	•
Event Records	•	•	•
Voltage Protection		•	•
Frequency Protection		•	•
Field Expandable Communications		•	•
Synchro-check Protection (optional)			•
Native Automatic Throw over Scheme			•
Field expandable I/O			•
Ladder Logic PLC custom programming (optional)			•
Mimic-bus graphical display (optional)			•
Onboard data logging			•
Communications options	Modbus RTU	•	•
	DPN	•	•
	Modbus TCP/IP		•
	IEC61850-MMS		•
	IEC61850-MMS + GOOSE		•

Table 5.18: Functions

ANSI Device Number	Description	T24	T42	T87
24	Volts/Hertz			•
25	Synch Check			•
26	Thermostat	•	•	•
27	Phase-to-phase undervoltage		•	•
27D	Positive sequence undervoltage			•
27R	Remnant Undervoltage			•
27S	Phase-to-neutral undervoltage		•	•
32P	Directional Power			•
38	Bearing Temperature	•	•	•
46	Negative Sequence Current/Unbalance	•	•	•
47	Negative Sequence undervoltage		•	•
49	Thermal Overload	•	•	•
49T	RTD Monitoring	•	•	•
50BF	Breaker Failure	•	•	•
50	Instantaneous Phase Overcurrent	•	•	•
50G	Instantaneous Ground Overcurrent (Measured)	•	•	•
50N	Instantaneous Ground Overcurrent (Calculated)	•	•	•
50V	Voltage Restrained Instantaneous overcurrent			•
51	Time Phase Overcurrent	•	•	•
51G	Time Ground Overcurrent (Measured)	•	•	•
51N	Time Ground Overcurrent (Calculated)	•	•	•
59	Phase-to-phase overvoltage		•	•
59N	Neutral Voltage Displacement		•	•
63	Buchholz Pressure	•	•	•
64REF	Restricted Ground Fault			•
67N	Directional Ground Overcurrent		•	•
67	Directional Phase Overcurrent		•	•
81H	Overfrequency		•	•
81L	Underfrequency		•	•
87T	2 Winding Transformer Differential			•

**Sepam Generator Applications**

Generator protection is broken into two sections Standard and Advanced. The Standard protection is covered with the Sepam G40 protection relay and covers a host of current, voltage, and frequency protection elements. The Advanced protection is covered with the Sepam G87/G88 and covers current, voltage, frequency, differential, and synchro check protection functions.



G40



G87/G88

**Standard Protection Relay (G40 – Sepam 40 Series)**

Typical Part Number: **SQ1G40A1B1A0A0** Series 40 - Generator Protection G40 (24-250Vdc & 120-240Vac), 1/5A CT inputs, 10In/8Out (110-125 Vdc, 110Vac), RS485

**Advanced Protection Relay (G87/G88 – Sepam 80 Series)**

Typical Part Number: **SQ1G87P1J5A0B0** Series 80 – Generator Protection G87 (24-250Vdc), mimicBus Graphical Display, 1/5A CT inputs, 14In/11Out Digital Module (110-125Vdc/mid p.u.), 2 x RJ-45 ports (Modbus or IEC61850 with GOOSE), ladder logic firmware (PLC base).

**Table 5.19: Features**

Feature	G40	G87	G88
Current Protection	•	•	•
Built in CB Control	•	•	•
Native Zone Selective Interlocking	•	•	•
Waveform Captures	•	•	•
Event Records	•	•	•
Voltage Protection	•	•	•
Frequency Protection	•	•	•
Field Expandable Communications	•	•	•
Synchro-check Protection (optional)		•	•
Native Automatic Throw over Scheme		•	•
Field expandable I/O		•	•
Ladder Logic PLC custom programming (optional)		•	•
Mimic-bus graphical display (optional)		•	•
Onboard data logging		•	•
Native Load Shedding and Motor Restart		•	•
Ability to incorporate a transformer into the same zone of protection (M88 only)		•	•
Built in Motor start and trending reports		•	•
Communications options	Modbus RTU	•	•
	DPN	•	•
	Modbus TCP/IP	•	•
	IEC61850-MMS	•	•
	IEC61850-MMS + GOOSE		•

**Table 5.20: Functions**

ANSI Device Number	Description	G40	G87	G88
12/14	Speed Switch		•	•
21B	Underimpedance		•	•
24	Volts/Hertz		•	•
25	Synch Check		•	•
27	Phase-to-phase undervoltage	•	•	•
27D	Positive sequence undervoltage		•	•
27R	Remnant Undervoltage		•	•
27S	Phase-to-neutral undervoltage	•	•	•
27TN	Third Harmonic Neutral Undervoltage		•	•
32P	Directional Power	•	•	•
32Q/40/55	Directional Reactive Power		•	•
38	Bearing Temperature	•	•	•
40	Loss of Excitation	•	•	•
46	Negative Sequence Current/Unbalance	•	•	•
47	Negative Sequence undervoltage	•	•	•
49	Thermal Overload	•	•	•
49T	RTD Monitoring	•	•	•
50/27	Inadvertent energization		•	•
50BF	Breaker Failure	•	•	•
50	Instantaneous Phase Overcurrent	•	•	•
50G	Instantaneous Ground Overcurrent(Measured)	•	•	•
50N	Instantaneous Ground Overcurrent(Calculated)	•	•	•
50V	Voltage Restrained Instantaneous overcurrent	•	•	•
51	Time Phase Overcurrent	•	•	•
51G	Time Ground Overcurrent(Measured)	•	•	•
51N	Time Ground Overcurrent(Calculated)	•	•	•
51V	Voltage Restrained Time Overcurrent	•	•	•
59	Phase-to-phase overvoltage	•	•	•
59N	Neutral Voltage Displacement	•	•	•
66	Starts per hour	•		
64G	100% Stator Ground Fault		•	•
67	Directional Phase Overcurrent		•	•
67N	Directional Ground Overcurrent		•	•
78	Pole Slip		•	•
81H	Overfrequency	•	•	•
81L	Underfrequency	•	•	•
87M	Machine Differential		•	
87T	2 Winding Transformer Differential			•



B22

B80/B83

### Sepam Busbar Applications

Busbar protection is broken into two sections Basic and Advanced. The Basic protection is covered with our Sepam B22 protection relay and handles voltage and frequency protection. The Advanced protection is covered with the Sepam B80/B83 and covers current, voltage, frequency, and synchro check protection functions.

#### Basic Protection Relay (B22 - Sepam 20 Series)

Typical Part Number: **SQ1G40A1B1A0A0** Series 20 - Busbar Protection B22 (24-250Vdc & 120-240Vac), VT inputs, 10In/8Out (110-125 Vdc, 110Vac), RS485

#### Advanced Protection Relay (B80/B83 – Sepam 80 Series)

Typical Part Number: **SQ1B83P1J5A0B0** Series 80 - Busbar Protection S84 (24-250Vdc), mimicBus Graphical Display, 1/5A CT inputs, 14In/11Out Digital Module (110-125Vdc/mid p.u.), 2 x RJ-45 ports (Modbus or IEC61850 with GOOSE), ladder logic firmware (PLC base).

Table 5.21: Features

Feature	B22	B80	B83
Current Protection		•	•
Built in CB Control	•	•	•
Native Zone Selective Interlocking	•	•	•
Waveform Captures	•	•	•
Event Records	•	•	•
Voltage Protection (2 sets of VTs on B83)	•	•	•
Frequency Protection	•	•	•
Field Expandable Communications		•	•
Synchro-check Protection (optional)		•	•
Native Automatic Throw over Scheme		•	•
Field expandable I/O		•	•
Ladder Logic PLC custom programming (optional)		•	•
Mimic-bus graphical display (optional)		•	•
Onboard data logging		•	•
Communications options	Modbus RTU	•	•
	DPN	•	•
	Modbus TCP/IP		•
	IEC61850-MMS + GOOSE		•

Table 5.22: Functions

ANSI Device Number	Description	B22	B80	B83
25	Synch Check		•	•
27	Phase-to-phase undervoltage	•	•	•
27D	Positive sequence undervoltage	•	•	•
27R	Remnant Undervoltage	•	•	•
27S	Phase-to-neutral undervoltage	•	•	•
46	Negative Sequence Current/Unbalance		•	•
47	Negative Sequence undervoltage	•	•	•
50BF	Breaker Failure		•	•
50	Instantaneous Phase Overcurrent		•	•
50G	Instantaneous Ground Overcurrent(Measured)		•	•
50N	Instantaneous Ground Overcurrent(Calculated)		•	•
51	Time Phase Overcurrent		•	•
51G	Time Ground Overcurrent(Measured)		•	•
51N	Time Ground Overcurrent(Calculated)		•	•
59	Phase-to-phase overvoltage	•	•	•
59N	Neutral Voltage Displacement	•	•	•
81H	Overfrequency	•	•	•
81L	Underfrequency	•	•	•
81R	Rate of Change of Frequency	•		

### Sepam Capacitor Applications

Busbar protection is broken into two sections Basic and Advanced. The Basic protection is covered with our Sepam B22 protection relay and handles voltage and frequency protection. The Advanced protection is covered with the Sepam B80/B83 and covers current, voltage, frequency, and synchro check protection functions. .

#### Advanced Protection Relay (C86 – Sepam 80 Series)

Typical Part Number: **SQ1C86P1J5A0B0** Series 80 - Transformer Protection S84 (24-250Vdc), mimicBus Graphical Display, 1/5A CT inputs, 14In/11Out Digital Module (110-125Vdc/mid p.u.), 2 x RJ-45 ports (Modbus or IEC61850 with GOOSE), ladder logic firmware (PLC base).



C86

Table 5.23: Features

Feature	C86	
Current Protection	•	
Built in CB Control	•	
Built in protection and control for Capacitors, up to 4 steps	•	
Native Zone Selective Interlocking	•	
Waveform Captures	•	
Event Records	•	
Voltage Protection	•	
Frequency Protection	•	
Field Expandable Communications	•	
Native Automatic Throw over Scheme	•	
Field expandable I/O	•	
Ladder Logic PLC custom programming (optional)	•	
Mimic-bus graphical display (optional)	•	
Onboard data logging	•	
Communications options	Modbus RTU	•
	DPN	•
	Modbus TCP/IP	•
	IEC61850-MMS + GOOSE	•

ANSI Device Number	Description	C86
27	Phase-to-phase undervoltage	•
27D	Positive sequence undervoltage	•
27R	Remnant Undervoltage	•
27S	Phase-to-neutral undervoltage	•
38	Bearing Temperature	•
46	Negative Sequence Current/Unbalance	•
47	Negative Sequence undervoltage	•
49	Thermal Overload	•
49T	RTD Monitoring	•
50BF	Breaker Failure	•
50	Instantaneous Phase Overcurrent	•
50G	Instantaneous Ground Overcurrent (Measured)	•
50N	Instantaneous Ground Overcurrent (Calculated)	•
51	Time Phase Overcurrent	•
51C	Capacitor Bank Unbalance	•
51G	Time Ground Overcurrent (Measured)	•
51N	Time Ground Overcurrent (Calculated)	•
59	Phase-to-phase overvoltage	•
59N	Neutral Voltage Displacement	•
81H	Overfrequency	•
81L	Underfrequency	•

### The MiCOM Range





The MiCOM protection relay range provides capability for a wide variety of protection, control, measurement, monitoring, and communication. MiCOM protection relays offer scalable levels of functionality and hardware options to best suit your protection requirements and allows you to choose the most cost-effective solution for your application. The versatile hardware and common relay management software (Easergy Studio) allows simple configuration and installation in different applications.

#### Features and Benefits

- Advanced communications capabilities including IEC61850 with PRP and HSR
- Self-powered options on the MiCOM 10 series
- Native cyber security including IEEE 1686 and NERC-CIP
- Wide range of frequency protections including 16.5, 16.67, 25, 50, and 60Hz
- User-friendly programmable scheme logic for custom programming
- Application-specific design ensuring appropriate protection for any given application

### MiCOM Characteristics

Table 5.24: MiCOM Series Characteristics

Series	MiCOM 10 Series	MiCOM 20 Series	MiCOM 30 Series	MiCOM 40 Series
				
Description	The MiCOM 10 series provides for self-powered protection.	The MiCOM 20 series provides for basic current based protections.	The MiCOM 30 series provides for a full range of protection features and is focused on Utility and Railway applications.	The MiCOM 40 series fulfils the protection requirements for a wide range of Utility and industrial applications.
<b>Applications Covered</b>				
Substation (Feeder)	•	•	•	•
Motor		•	•	•
Transformer			•	•
Distance			•	•
Line Differential			•	•
Railway			•	
Busbar				•
Mesh breaker arrangements				•
Generator				•
<b>Characteristics</b>				
Frequency 50/60 Hz			•	•
Logic inputs	max 8	max 12	max 82	max 64
Opto inputs			max 82	max 64
Output contacts			max 48	max 60
Logic outputs	max 8	max 8	max 48	max 60
Continuous carry			5 A / 8 A / 10 A	10 A
Short duration current			30 A for 0.5 (3s)	30 A for 3s
LED indication (programmable)			23 (19)	22 (18)
Settings groups			4	4
High break contacts	NA	NA	max 16	max 8
Function keys / hot keys	NA	NA	6	10 / 2
Fault records	20	25	8	15
Event records	200	250	1000	250–512
Disturbance records	5	5	16.4s (max 8 rec.)	75s (max 10. s/rec.)
Programmable logic	NA	Flexible Logic	Fully programmable	Graphical / Fully programmable
IRIG-B	NA	Optional	Optional	Optional
LCD display			Alphanumeric / Graphical	Alphanumeric
Front port			EIA(RS) 232	EIA(RS) 232
Rear port			Yes / Optional	Yes / Optional
Counter			EIA(RS)485 or fiber	K-Bus / EIA(RS)485 or fiber
Modbus			EIA(RS)485 or fiber	EIA(RS)485 or fiber
IEC 60870–5–103			EIA(RS)485 or fiber	EIA(RS)485 or fiber
IEC 60870–5–101			EIA(RS)485 or fiber	EIA(RS)485 or fiber
DNP3.0			EIA(RS)485 or fiber	EIA(RS)485 or Ethernet (RJ45, fiber)
IEC 61850			Wire RJ45 or fiber	Wire RJ45 or fiber
Terminals			Pin or Ring	Ring
Analog I/O	NA	max 0/2	1/2	4/4
Temperature sensors	NA	max 10	max 10	max 10
Communication Ports	1	1	1–4	1–4
	ModBus, IEC 103, DNP3	ModBus, IEC 103, DNP3	ModBus, IEC 103, DNP3, IEC 61850	ModBus, IEC 103, DNP3, IEC 61850
	—	—	Redundancy	Redundancy
	—	—	Goose Messaging	Goose Messaging



**Table 5.25: Feeder Management and Overcurrent Relays**

Easergy MiCOM series / model	10			20							30		40			
	P111	P115	P116	P120	P121	P122	P123	P125	P126	P127	P132	P139	P141	P142	P143	P145
Case size				20TE	20TE	20TE	20TE	30TE	30TE	30TE	24, 40 or 84TE	40 or 84TE	40TE	40TE	60 or 80TE	60TE
CT Inputs	4	4	4	1	4	4	4	1	4	4	4	4	5	5	5	5
VT Inputs								1	1	3	4 or 5	4 or 5	3	3	3 or 4	3 or 4
Opto Inputs (max)	8	2	6	2	2	3	5	4	7	12	70	70	8	16	32	32
Output Contacts (max)	8	4	7	4	4	6	8	6	8	8	32	28	8	15	30	32
High Break Contacts (max)											16	16		4	8	8
RTDs (max)											10	10				
Analogue Input / Output (max)											1/2	1/2				
Function Keys / Hotkeys											•	•	•	•	•	•
Bay Control and Monitoring											Mimic	Graphical				
Interlocking Logic											•	•				

**Table 5.26: Transformer Protection Relays**

Easergy MiCOM series / model	30 / P631	30 / P632	30 / P633	30 / P634	40 / P642	40 / P643	40 / P645
Case size	24 or 40TE	40 or 84TE	40 or 84TE	40 or 84TE	40TE	60TE	80TE
CT Inputs	6	8	12	15	8	12	18
VT Inputs		1	1	1	1 or 2	1 or 4	1 or 4
Opto Inputs (max)	4	34	40	34	12	24	24
Output Contacts (max)	14	22	30	22	12	24	24
Analogue Input / Output (max)		1/2	1/2	1/2	4/4	4/4	4/4
High Break Contacts	4	4	4	4	4	4	8
RTDs (option)		1	1	1	10	10	10
Function keys / Hotkeys	•	•	•	•		•	•
Bay Control & Monitoring		Mimic	Mimic				
Interlocking Logic		•	•				

**Table 5.27: Generator Management Relays**

Easergy MiCOM series / model	40 / P342	40 / P343	40 / P344	40 / P345
Case size	40 or 60TE	60 or 80TE	80TE	80TE
CT Inputs	5	8	8	9
VT Inputs	4	4	5	6
Opto Inputs (max) / Output Contacts (max)	24	32	32	32
High Break Contacts	4	8	8	8
RTDs (option)	10	10	10	10
Analogue Input / Output (max)	4/4	4/4	4/4	4/4
Function keys / Hotkeys	•	•	•	•
Interlocking Logic	•	•	•	•

**Table 5.28: Busbar Protection Relays**

Easergy MiCOM series / model	40 / P741* (CU)	40 / P742* (PU)	40 / P743* (PU)	40 / P746
Case size	80TE	40TE	60TE	80TE
CT Inputs		4	4	18/21
VT Inputs				3/0
Opto Inputs (max)	8	16	24	40
Output Contacts (max)	8	8	21	32
Function keys / Hotkeys	•		•	•

**Table 5.29: Rail Protection Relays**

Easergy MiCOM series / model	30 / P138	30 / P436	30 / P438	30 / P638
Case size	40 or 84TE	40 or 84TE	40 or 84TE	84TE
CT Inputs	2	3	3	5
VT Inputs	1	2	2	1
Opto Inputs (max)	22	34	28	38
Output Contacts (max)	48	46	46	64
RTDs (option)	1	1	1	1
Analogue Input / Output (max)	1/2	1/2	1/2	1/2
Function keys / Hotkeys	•	•	•	•



MiCOM 10 Series  
P11x Self-Powered or Dual Powered  
P115 and P116

### MiCOM Self-Powered Applications

Self-powered applications are special and require specific hardware to handle the necessary protection of equipment. Schneider Electric offers the MiCOM P116 relay for this application. The P116 provides a number of advantages including dual power options, communications, withdrawable case, and electromagnetic flag indicators.

- Current Protection
- Electromagnetic flag indicators
- Withdrawable case
- Waveform captures
- Event records
- Communications options:
  - Modbus RTU
  - Event records

Table 5.30: Functions

ANSI Device Number	Description	P116
37	Undercurrent	•
46	Negative Sequence Current/Unbalance	•
46BC	Broken conductor detection	•
50BF	Breaker Failure	•
50	Instantaneous Phase Overcurrent	•
50N	Instantaneous Ground Overcurrent(Calculated)	•
51	Time Phase Overcurrent	•
51N	Time Ground Overcurrent(Calculated)	•
50HS	Switch on to fault	•
79	Reclosing	•

Table 5.31: Typical Catalog Number

Catalog Number	Description
P116A1N6N25115111W	Series 10 - Substation/Feeder Protection, Dual powered P116 (CT powered and 60-250Vdc & 60-240Vac), 5A CT inputs, 6In/7Out (24-250 Vdc, 24-240Vac), RS485, 5 electromagnetic flags, withdrawable case

### MiCOM Substation / Feeder Applications

The MiCOM range of relays offers varying levels of functionality and hardware options to best suit the protection requirements and allows the customer to choose the most cost effective solution for their application.

The versatile hardware allows for application in many installations and a common relay management software (MiCOM S1 Studio) makes for easy configuration and application.

#### Basic Feeder Protection Relays — MiCOM 10 and 20 Series

The 10 and 20 series hardware platforms are the building blocks of the MiCOM protection relay range providing the capability for a wide variety of protection, control, measurement, monitoring and communication functions.

The MiCOM P11x relays are suitable for all the applications where overcurrent and/or ground fault protection are required. P11x can be applied to medium and low voltage electrical systems as an optimized and cost-efficient solution tailored to user's needs.

MiCOM P120, P121, P122 and P123 relays provide comprehensive overcurrent phase and ground fault protection for utilities networks, industrial plants and networks as well as for other applications where overcurrent protection is required. The ground fault protection is sensitive enough to be applied in electrical networks where the ground fault current is low.

#### Standard and Advanced Feeder Protection Relays — MiCOM 30 and 40 Series

- Easergy MiCOM P132 offers a flexible and powerful feeder management device housed in a 4U case in 24TE, 40TE or 84TE widths. Easergy MiCOM P132 offers bay control for up to 3 devices and a library of 80 pre-engineered templates to reduce engineering time.
- Easergy MiCOM P139 one-box solution is the most advanced in the range. It's available in 40TE or 84TE width, 4U case sizes. It offers bay control for up to 10 devices. It uses a pre-engineered library of up to 300 templates for efficient engineering and commissioning.
- Easergy MiCOM P14x Feeder Management and Overcurrent Protective Relays are especially suitable where a complete or advanced power system protection scheme solution is required.



MiCOM P11x

MiCOM P12x

**The following models are available:**

- Easergy MiCOM P141 – Feeder management relay
- Easergy MiCOM P142 – Feeder management with integrated Autoreclose
- Easergy MiCOM P143 – Feeder management, integrated Autoreclose and Check Synchronism
- Easergy MiCOM P145 – Feeder management, Autoreclose, Check Synchronism and Enhanced operator control functions

**Table 5.32: Functions of Feeder Management Relays**

ANSI	Protection Function	P111	P115	P116	P120	P121	P122	P123	P125	P126	P127	P132	P139	P141	P142	P143	P145
25	Check synchronizing											•	•			•	•
32	Directional power										•	•	•	•	•	•	•
32V	Voltage controlled direct. reactive power											•	•				
34	Master sequence device											•	•				
37	Undercurrent			•			•	•		•	•	•	•	•	•	•	•
46	Negative sequence overcurrent			•			•	•		•	•	•	•	•	•	•	•
46BC	Broken conductor			•			•	•		•	•	•	•	•	•	•	•
47	Negative sequence over voltage										•	•	•	•	•	•	•
48	Incomplete sequence relay											•	•				
49	Thermal overload	•		•			•	•		•	•	•	•	•	•	•	•
50/51N	Ground fault	•	•	•		•	•	•	•	•	•	•	•	•	•	•	•
50/51P	3 Phase overcurrent	•	•	•		•	•	•	•	•	•	•	•	•	•	•	•
50/51P/N	1 Phase or ground overcurrent				•				•			•	•				
50BF	Circuit breaker failure	•	•	•			•	•		•	•	•	•	•	•	•	•
51LR	Motor											•	•				
51V	Voltage controlled overcurrent										•	•	•	•	•	•	•
59/27	Over / Under voltage										•	•	•	•	•	•	•
59N	Residual over voltage								•	•	•	•	•	•	•	•	•
64	Restricted ground fault				•	•	•	•		•	•	•	•	•	•	•	•
66	Startup monitoring											•	•				
67N	Ground fault directional								•	•	•	•	•	•	•	•	•
67N	Transient ground fault detection											•	•				
67N	Sensitive directional ground fault											•	•	•	•	•	•
67P	Phase directional										•	•	•	•	•	•	•
67W	Wattmetric ground fault								•	•	•	•	•	•	•	•	•
79	Autoreclose			•				•		•	•	•	•	•	•	•	•
81	Under / Over frequency										•	•	•	•	•	•	•
81P	Under frequency load shedding											•	•				
81R	Rate of change of frequency										•	•	•	•	•	•	•
85	Protective signaling											•	•				
86	Lock-out	•	•	•	•	•	•	•	•	•	•	•	•	•	•	•	•
CTS	Current transformer supervision											•	•	•	•	•	•
SOTF	Switch on to fault	•		•				•		•	•	•	•	•	•	•	•
TCS	Trip circuit supervision	•		•				•		•	•	•	•	•	•	•	•
VTS	Voltage transformer supervision											•	•	•	•	•	•
YN	Neutral admittance											•	•	•	•	•	•
	Circuit breaker monitoring	•		•			•	•		•	•	•	•	•	•	•	•
	Cold load pick-up	•		•			•	•		•	•	•	•	•	•	•	•
	Inrush blocking	•		•			•	•		•	•	•	•	•	•	•	•
	InterMiCOM											•	•	•	•	•	•
	Limit value monitoring											•	•				

**Table 5.33: Typical Catalog Numbers**

	Catalog Numbers	Description
Basic	P123A00Z412EC0	Series 20 - Substation/Feeder Protection, P123 (24-250Vdc & 48-240Vac), 1/5A CT inputs, 5In/8Out (24-250 Vdc, 24-240Vac), RS485, DNP3
Standard	P14121RABM0B48L	Series 40 - Substation/Feeder Protection, P141 (48-110Vdc), 1/5A CT inputs, 8In/7Out (user configurable voltage thresholds), 3xRJ-45, IEC61850, DNP3
Advanced	P14521RHBM0B48M	Series 40 - Substation/Feeder Protection, P141 (48-110Vdc), 1/5A CT inputs, 16In/20Out (user configurable voltage thresholds), 4 high break outputs, 3xRJ-45, IEC61850, DNP3

**MiCOM Motor Applications**

The MiCOM 10, 20, 30 and 40 series protection relays are designed for various motor protection applications.

**Basic Motor Protection Relay (MiCOM P 10 and 20 Series Relays)**

The MiCOM P211 and P22x protection relay range are particularly adapted to oil refinery, chemical plant, metallurgy, glass and cement manufacturing, paper mills, electrical and mechanical engineering, food production, mining etc. It is also suitable for water treatment and in pumping stations as well as in steam power plants.

MiCOM P22x range of protection relays is designed for motor protection applications and includes a complete set of protection functions. Models available: MiCOM P220 MiCOM P225

A complete set of protection functions is performed on the measurement of current, voltage and temperature.

In addition to above basic functions, the relay carries out a large number of other functions that enable it to protect and run the motor more effectively.

**Advanced Motor Protection Relay (MiCOM P 30 and 40 Series Relays)**

Easergy™ MiCOM P24x relays offer advanced protection, control and monitoring of motors and rotating machines. Models available: MiCOM P241, MiCOM P242, MiCOM P243

Easergy™ MiCOM P24x comprehensive protection package includes 87 differential protection and optimization of thermal image monitoring for machines.

These relays not only improve monitoring conditions, but they also facilitate machine maintenance and save on wiring costs.



**Table 5.34: Functions available for the different models of the Motor protection MiCOM range of relays**

ANSI	Protection Function	P211	P220	P225	P130C	P132	P139	P241	P242	P243
14	Speed switch input	•		•		•	•	•	•	•
25	Check synchronizing					•	•	•		
27LV	Reacceleration		•	•	•	•	•	•	•	•
30/46/86	Unbalance / Lock out		•	•	•	•	•	•	•	•
32L/O/R	Directional power				•	•	•			
32R	Reverse power				•	•	•	•	•	•
37	Loss of load	•	•	•	•	•	•	•	•	•
37	Undercurrent		•	•	•	•	•	•	•	•
38/49	Thermal overload	•	•	•	•	•	•	•	•	•
40	Loss of field							•	•	•
46	negative sequence overcurrent	•		•	•	•	•	•	•	•
47	Negative sequence over voltage				•	•	•	•	•	•
47N	Neutral over voltage				•	•	•	•	•	•
50/51P	Phase overcurrent	•	•	•	•	•	•	•	•	•
50BF	Circuit breaker failure			•	•	•	•	•	•	•
50N/51N	Ground fault	•	•	•	•	•	•	•	•	•
50S/51LR/51S	Locked rotor	•	•	•	•	•	•	•	•	•
55	Out of step							•	•	•
59/27	Under / Over voltage			•	•	•	•	•	•	•
59N	Residual over voltage				•	•	•	•	•	•
64N/32N	Wattmetric ground fault				•	•	•	•	•	•
66/48/51	Startup monitoring	•	•	•	•	•	•	•	•	•
67N	Ground fault directional				•	•	•	•	•	•
67N	Sensitive directional ground fault				•	•	•	•	•	•
67P	Phase directional				•	•	•	•	•	•
81O	Over frequency				•	•	•			
81U	Under frequency				•	•	•	•	•	•
81R	Rate of change frequency				•	•	•			
87M	Motor differential									•
CTS	Current transformer supervision		•	•	•	•	•	•	•	•
TCS	Trip current supervision		•	•	•	•	•	•	•	•
VTS	Voltage transformer supervision				•	•	•	•	•	•
	anti backspin			•				•	•	•
	Circuit breaker monitoring		•	•		•	•	•	•	•

**Table 5.35: Typical Catalog Numbers**

	Catalog Number	Description
Basic	P225CA0Z112A0CB	Series 20 - Motor Protection, P225 (24-250Vdc & 48-240Vac), 1/5A CT inputs, 6In/5Out (24-250 Vdc, 24-240Vac), 10 RTD's, RS485, Modbus
Standard	P24121RB6M0D18L	Series 40 - Motor Protection, P241 (48-110Vdc), 1/5A CT inputs, 8In/7Out (user configurable voltage thresholds), 10 RTD's, 3xRJ-45, IEC61850
Advanced	P24321RB6M0D08M	Series 40 - Differential Motor Protection, P243 (48-110Vdc), 1/5A CT inputs, 16In/16Out (user configurable voltage thresholds), 10 RTD's, 3xRJ-45, IEC61850

### MiCOM Transformer Applications

Easergy™ MiCOM P63x and P64x Transformer Differential Protection and Control Devices are designed for fast, selective, short-circuit protection of transformers, motors, generators and other installations.

Models available:

- Easergy MiCOM P631
- Easergy MiCOM P632
- Easergy MiCOM P633
- Easergy MiCOM P634
- Easergy MiCOM P642
- Easergy MiCOM P643
- Easergy MiCOM P645



P631 / P632 / P633 / P634 / P642 / P643 / P645

These devices also incorporate many supplementary protective backup functions.

**Table 5.36: Functions available for the different models of the Transformer protection MiCOM range of relays**

ANSI	Protection Function	P631	P632	P633	P634	P642	P643	P645
24	Overexcitation		•	•	•	•	•	•
46	Negative sequence overcurrent	•	•	•	•	•	•	•
47	Negative sequence over voltage					•	•	•
49	Thermal overload	•	•	•	•	•	•	•
50/51N	Ground fault	•	•	•	•	•	•	•
50/51P	Phase overcurrent	•	•	•	•	•	•	•
50BF	Circuit breaker failure	•	•	•	•	•	•	•
59/27	Under / Over voltage		•	•	•	•	•	•
67N	Ground fault directional					•	•	•
67P	Phase directional					•	•	•
81	Under / over frequency		•	•	•	•	•	•
87G/64	Restricted ground fault		2	3	3	2	3	3
87T	Transformer differential (windings)	2	2	3	4	2	3	3
CTS	Current transformer (CT) supervision	•	•	•	•	•	•	•
TCS	Trip current supervision	•	•	•	•	•	•	•
VTS	Voltage Transformer (VT) supervision					•	•	•
	2nd harmonic restraint	•	•	•	•	•	•	•
	Overfluxing / 5th harmonic	•	•	•	•	•	•	•

**Table 5.37: Typical Catalog Numbers**

	Catalog Number	Description
Basic	P64221RABM0B48L	Series 40 - Transformer differential (2 sets of CT's) Protection, P642 (48-110Vdc), 1/5A CT inputs, 8In/8Out (user configurable voltage thresholds), 3xRJ-45, IEC61850, DNP3
Standard	P64321RABM0B48M	Series 40 - Transformer differential (3 sets of CT's) Protection, P643 (48-110Vdc), 1/5A CT inputs, 16In/16Out (user configurable voltage thresholds), 3xRJ-45, IEC61850, DNP3
Advanced	P64521RABM0B48M	Series 40 - Transformer differential (5 sets of CT's) Protection, P645 (48-110Vdc), 1/5A CT inputs, 16In/16Out (user configurable voltage thresholds), 3xRJ-45, IEC61850, DNP3



P342 / P343 / P344 / P345

### MiCOM Generator Applications

The Easergy™ MiCOM P34x generator protection relays provide flexible and reliable integration of protection, control, monitoring and measurement functions for small, medium and large generators.

Models available:

- MiCOM P342
- MiCOM P343
- MiCOM P344
- MiCOM P345

P34x range covers small generators with all necessary industry standard protection and increasing through larger or more important generators with 100% stator ground fault protection via a 3rd harmonic measuring technique, pole slipping and unintentional energization at standstill protection.

Advanced models in the range offer leading techniques for large generators including second neutral voltage inputs for ground fault/inter-turn protection and 100% stator ground fault protection via a low frequency injection technique.

**Table 5.38: Functions available for the different models of the Generator protection MiCOM range of relays**

ANSI	Protection Function	P342	P343	P344	P345
21	Under-impedance	•	•	•	•
24	Overexcitation	•	•	•	•
25	Check synchronizing	•	•	•	•
27TN/59TN	100% stator ground fault (3rd)	•	•	•	•
32L/O/R	Directional power	•	•	•	•
37N/37P	Sensitive phase and ground fault undercurrent	•	•	•	•
38/49	Thermal overload	•	•	•	•
40	Loss of field	•	•	•	•
460C	Negative sequence overcurrent	•	•	•	•
46T	Negative sequence thermal	•	•	•	•
47	Negative sequence over voltage	•	•	•	•
49T	Thermal overload	•	•	•	•
50/27	Unintentional energization	•	•	•	•
50/51P	Phase overcurrent	•	•	•	•
50BF	Circuit breaker failure	•	•	•	•
50N/51N	Ground fault	•	•	•	•
50DT	Interturn / split phase	•	•	•	•
51V	Voltage dependent O/C	•	•	•	•
59/27	Under / over voltage	•	•	•	•
59N	Residual over voltage	•	•	•	•
64	Restricted ground fault	•	•	•	•
64N/32N	Wattmetric ground fault	•	•	•	•
64R	Rotor ground fault (MiCOM P391 option)	•	•	•	•
64S	100% stator ground fault (low frequency)	•	•	•	•
67N	Sensitive directional ground fault	•	•	•	•
67P	Phase directional	•	•	•	•
67W	Wattmetric sensitive ground fault	•	•	•	•
78	Pole slipping	•	•	•	•
81AB	Turbine abnormal frequency	•	•	•	•
81	Under / over frequency	•	•	•	•
87G/87GT	Generator differential	•	•	•	•
CTS	Current transformer supervision	•	•	•	•
TCS	Trip circuit supervision	•	•	•	•
VTS	Voltage transformer supervision	•	•	•	•
	Circuit breaker monitoring	•	•	•	•

**Table 5.39: Typical Catalog Numbers**

	Catalog Number	Description
Basic	P34221RBBM0B38L	Series 40 - Generator Protection, P342 (48-110Vdc), 1/5A CT inputs, 8In/7Out (user configurable voltage thresholds), 10 RTD's, 3xRJ-45, IEC61850, DNP3
Standard	P34321RBBM0B38M	Series 40 - Generator Protection, P342 (48-110Vdc), 1/5A CT inputs, 16In/14Out (user configurable voltage thresholds), 10 RTD's, 3xRJ-45, IEC61850, DNP3
Advanced	P34521RBBM0B38M	Series 40 - Generator Protection, P345 (48-110Vdc), 1/5A CT inputs, 24In/24Out (user configurable voltage thresholds), 10 RTD's, 3xRJ-45, IEC61850, DNP3

### MiCOM Busbar Differential Applications High Impedance Differential Protection Relays

MiCOM P72x high impedance differential protection series provides high impedance differential protection for generators, reactors, motor and busbar applications.

Models available:

- MiCOM P721
- MiCOM P723



P721 / P723

MiCOM P72x apart from offering the same application benefits as traditional high impedance electromechanical protection schemes, it combines the added benefits of numerical technology to provide advanced communications, event records, fault records, disturbance records and ancillary protection features.

Combined with the MiCOM P79x, a standalone metrosil and resistor unit, it provides simplified scheme engineering for single or three-phase differential applications.

### Numerical Busbar Protection Relay Scheme (Centralized)

Easergy™ MiCOM P746 numerical busbar protection provides centralized complete protection for all voltages level up to extra high voltage busbar configurations.

Models available:

- MiCOM P746

Simple configuration for centralized architecture. The Easergy MiCOM P746 differential busbar protection provides a centralized one box or three boxes architecture and is very simple to use.

It does not need to be deeply engineered and supports easy operation and maintenance of the busbar.



P741 / P742 / P743 / P746

### Numerical Busbar Protection Relay Scheme (Distributed)

The Easergy MiCOM P740 numerical busbar protection scheme provides scalable and complete protection for all voltage levels, from low to extra or ultra high-voltage busbar configurations.

Models available:

- MiCOM 741
- MiCOM 742
- MiCOM 743

Easergy MiCOM P740 is one of the fastest and complete in its class, providing secure and sensitive protection for all types of voltage busbar configurations. It is easily adapted to any configuration and can operate with different types of CT.

**Table 5.40: Functions available for the different models of the Busbar protection MiCOM range of relays**

ANSI	Protection Function	P741	P742	P743	P746
50N/51N	Ground fault		•	•	•
50/51P	Phase overcurrent		•	•	•
50BF	Circuit breaker failure	•	•	•	•
87BB	Busbar	•	•	•	•
87CZ	Check Zones	•			•
87P	Phase segregated differential	8 zones			4 zones
87P	Sensitive ground fault differential	8 zones			
CTS	Current transformer supervision	•	•	•	•
TCS	Trip circuit supervision	•	•	•	•
VTS	Voltage transformer supervision		•	•	•
	Phase comparison				•
	CT saturation detection		•	•	
	CT supervision		•	•	•

**Table 5.41: Typical Catalog Numbers**

Catalog Number	Description
Standard — High Impedance Busbar Differential P723 with external stabilizing resistor P793	P723000Z112CB0 Series 20 - High Impedance bus differential Protection, P723 (24-250Vdc & 48-240Vac), 1/5A CT inputs, 5In/8Out (24-250 Vdc, 24-240Vac), RS485, Modbus P793CF0E2 External stabilizing resistor, 20kJ
Advanced — Low impedance Busbar Differential (1 or 3 box mode)	P74622RABM0C48M Series 40 - Low Impedance bus differential (7 sets of CT's) Protection, P746 (48-110Vdc), 1/5A CT inputs, 16In/16Out (user configurable voltage thresholds), 3xRJ-45, IEC61850, DNP3

**MiCOM Distance Applications**

**Easergy™ MiCOM P43x distance protection and One-Box devices**

Applied for selective short circuit, ground fault and overload protection in all kinds of medium, high and extra-high voltage systems.

Easergy MiCOM P43x offers a comprehensive range of protection functions as standard with optional hardware and software features available to satisfy customer needs.

Easergy MiCOM P439 One-Box solution includes Bay Control up to 10 devices, including a library of more than 300 pre-engineered bay templates, to reduce engineering time.



P433 / P435 / P437 / P439 / P430C

**Table 5.42: Easergy™ MiCOM P43x Models Available:**

Easergy MiCOM P433	MiCOM P439
Easergy MiCOM P435	MiCOM P430C
Easergy MiCOM P437	

**Easergy MiCOM P44x - High Performance Relay Distance Protection**

Easergy MiCOM P44x provides high speed and high performance distance protection for all overhead lines and cable applications and offers a comprehensive range of protection functions as standard.

Easergy MiCOM P44x is complemented by various serial and Ethernet communication protocols including IEC61850. Protection is further enhanced by the use of Programmable Scheme Logic within the device.

The range offers quadrilateral (polygon) or mho characteristics with a long history of high performance, load blinding areas, comprehensive range of teleprotection schemes, Power swing alarm and blocking and Multishot autoreclosure with check synchronism.



P441 / P442 / P443 / P444 / P445 / P446

**Table 5.43: Easergy MiCOM P44x Models Available:**

MiCOM P441	MiCOM P444
MiCOM P442	MiCOM P445
MiCOM P443	MiCOM P446

**Table 5.44: Functions available for the different models of the Distance protection MiCOM range of relays**

ANSI	Protection Function	P433	P435	P437	P439	P441	P442	P443	P444	P445	P446
21/21N	Distance	•	•	•	•	•	•	•	•	•	•
25	Check synchronising	•	•	•	•	•	•	•	•	•	•
32	Directional power	•	•	•	•						
32V	Voltage controlled directional reactive power	•	•		•						
46	Negative sequence overcurrent	•	•	•	•	•	•	•	•	•	•
46/67	Directional negative sequence			•	•	•	•	•	•	•	•
46BC	Broken conductor	•	•	•	•	•	•	•	•	•	•
49	Thermal overload	•	•	•	•	•	•	•	•	•	•
50/27	Switch on-to fault	•	•	•	•	•	•	•	•	•	•
50/51N	Ground fault	•	•	•	•	•	•	•	•	•	•
50/51P	Phase overcurrent	•	•	•	•	•	•	•	•	•	•
50ST	Stub bus protection	•	•	•	•	•	•	•	•	•	•
59/27	Over / under voltage	•	•	•	•	•	•	•	•	•	•
59N	Residual over voltage	•	•	•	•	•	•	•	•	•	•
62/50BF	Circuit breaker failure	•	•	•	•	•	•	•	•	•	•
67N	Ground fault directional	•	•	•	•	•	•	•	•	•	•
67N	Transient ground fault detection	•	•	•	•						
67P	Phase directional					•	•	•	•	•	•
67W	Wattmetric ground fault	•	•		•						
68	Out of step tripping	•	•	•	•			•			•
78	Power swing blocking	•	•	•	•	•	•	•	•	•	•
79	Auto-reclose	3 pole	1/3 p	1/3 p	3 pole	3 pole	1/3 p	1/3 p	1/3 p	3 pole	1/3 p
81	Over / under frequency	•	•	•	•	•	•	•	•	•	•
81R	Rate of change of frequency	•	•	•	•			•	•	•	•
81P	Under-frequency load shedding	•	•	•	•						
85	Channel aided scheme logic	•	•	•	•	•	•	•	•	•	•
CVTS	Capacitive voltage transformer supervision					•	•	•	•	•	•
TCS	Trip circuit supervision	•	•	•	•	•	•	•	•	•	•
VTS/CTS	Voltage / current transformer supervision	•	•	•	•	•	•	•	•	•	•
ΔI/ΔV	Delta directional comparison							•			•
YN	Neutral admittance	•	•		•						
	Process Bus interface for SV						•	•	•	•	•
	Mutual compensation			•		•	•	•	•	•	•

**Table 5.45: Typical Catalog Numbers**

	Catalog Numbers	Description
Standard Version	P44321RMBM0H98M	Series 40 - Distance Protection, P443 (48-110Vdc), 1/5A CT inputs, 16In/24Out (user configurable voltage thresholds), 1300nm single-mode dual channel, 3xRJ-45, IEC61850, DNP3
Advanced Version	P44521ROBM0J98L	Series 40 - Distance Protection, P445 (48-110Vdc), 1/5A CT inputs, 16In/16Out (user configurable voltage thresholds), 1300nm single-mode dual channel, 3xRJ-45, IEC61850, DNP3



**MiCOM Line Differential Applications**

**MiCOM P521 - Feeder Differential Protection Relays**

MiCOM P521 provides high speed, two ended current differential unit protection of overhead lines and underground cables in applications such as ring mains and parallel feeders.

Models available: MiCOM P521

MiCOM P521 relay provides fast, efficient current differential protection. It is very flexible and can be applied to a wide range of power systems. Offering a variety of communications interface options, MiCOM P521 provides valuable local and remote back-up protection



P251 / P532

**Easergy™ MiCOM P532 - Line Differential Protection and Bay Control Device**

Easergy MiCOM P532 provides a two-ended line differential protection function with all of the necessary protection communication interfaces.

Easergy MiCOM P532 is an inexpensive line differential protection device that features optional control functions for rapid and selective short-circuit and overload protection of cables and power lines.

It provides a rapid three-stage differential protection system using a tripping characteristic with multiple knee points amongst the numerous supplementary functions. The optional control functions enable Easergy MiCOM P532 to control up to six switchgear units fitted to a bay panel, and to monitor their contact positions.

**Easergy MiCOM P54x - Line Differential Protection Relays**

Easergy MiCOM P54x is designed for high performance overhead line and cable applications, it interfaces readily with the longitudinal (end to end) communications channels and has optional distance backup protection.

Models available:

- MiCOM P541, P542, P543, P544, P545, P546

Easergy MiCOM P541-P546 series provides high-speed current differential unit protection. The P54x is designed for all overhead line and cable applications, as it interfaces readily with the longitudinal (end to end) communications channel between line terminals.

A full range of back-up protection is integrated. This enhances the dependability of the protection, as hot-standby elements (such as distance zones and overcurrent) can be brought into service whenever a signaling channel outage may occur.



P541 / P542 / P543 / P544 / P545 / P546

**Table 5.46: Functions available for the different models of the Line Differential protection MiCOM range of relays**

ANSI	Protection Function	P521	P530C	P532	P541	P542	P543	P544	P545	P546	P547
21	Distance						•	•	•	•	•
25	Check synchronizing			•			•	•	•	•	•
37	Loss of load / undercurrent										
46	Negative sequence overcurrent	•		•			•	•	•	•	•
49	Thermal overload	•	•	•	•	•	•	•	•	•	•
50/51N	Ground fault	•	•	•	•	•	•	•	•	•	•
50/51P	Phase overcurrent	•	•	•	•	•	•	•	•	•	•
50BF	Circuit breaker failure	•	•	•	•	•	•	•	•	•	•
59/27	Over / under voltage		•	•			•	•	•	•	•
64W	Wattmetric ground fault		•	•			•	•	•	•	•
67N	Ground fault directional		•	•			•	•	•	•	•
67N	Sensitive directional ground fault			•			•	•	•	•	•
67P	Phase directional		•	•			•	•	•	•	•
78	Power swing blocking						•	•	•	•	•
79	Auto-reclose	3 pole	3 pole	3 pole		3 pole	1/3 pole	1/3 pole	1/3 pole	1/3 pole	1/3 pole
81	Under / over frequency			•			•	•	•	•	•
87L	Line differential (terminal)	2	2	2	2/3	2/3	2/3	2/3	2/3	2/3	
87L	Phase comparison										•
CTS	CT supervision	•					•	•	•	•	•
TCS	Trip circuit supervision	•	•	•	•	•	•	•	•	•	•
	2 breaker configuration							•	•	•	
	2nd harmonic restraint	•	•	•	•	•	•	•	•	•	
	Copper wire signaling	•	•	•			•	•	•	•	
	Direct / permissive inter tripping	•	•	•	•	•	•	•	•	•	
	FO signaling	•	•	•	•	•	•	•	•	•	
	In Zone transformer	•			•	•	•	•	•	•	
	PLC signaling										•
	SDH / Sonet networks						•	•	•	•	
	Vector compensation	•			•	•	•	•	•	•	

**Table 5.47: Typical Catalog Numbers**

Catalog Number	Description
Basic Version	P521A0GZ412DG0 Series 20 - Line differential Protection, P521 (24-250Vdc & 48-240Vac), 1/5A CT inputs, 5In/8Out (24-250 Vdc, 24-240Vac), 1300nm single-mode single channel, RS485, DNP
Standard Version	P54321RCBM0H98M Series 40 - Line differential Protection, P543 (48-110Vdc), 1/5A CT inputs, 16In/14Out (user configurable voltage thresholds), 1300nm single-mode dual channel, 3xRJ-45, IEC61850, DNP3
Advanced Version	P54521RCBM0H98M Series 40 - Line differential Protection, P545 (48-110Vdc), 1/5A CT inputs, 24In/32Out (user configurable voltage thresholds), 1300nm single-mode dual channel, 3xRJ-45, IEC61850, DNP3

**MiCOM Railway Applications**

**Easergy™ MiCOM P138 - Overcurrent Protection Device for Rail Applications**

The Easergy MiCOM 30 series rail devices are dedicated to railway catenary protection. The Easergy MiCOM P138 specifically provides directional overcurrent protection for rail applications

The Easergy MiCOM P138 enables a wide range of applications to protect supplies and catenaries in classic and autotransformer-fed (AT) systems. With easy connection to virtually all substation and catenary network management systems, it is enhanced by a complete range of backup protection and automation functions

**Easergy MiCOM P638 - Transformer Protection Device for Rail Applications**

Easergy MiCOM Px30 rail devices are dedicated to railway catenary protection. The Easergy MiCOM P638 provides transformer differential protection

Easergy MiCOM P638 enables a wide range of applications to protect supplies and catenaries in classic and autotransformer-fed (AT) systems. With easy connection to virtually all substation and catenary network management systems, Easergy MiCOM P638 is enhanced by a complete range of backup protection and automation functions

**Easergy MiCOM P436 and P438 - Distance Protection Devices for Rail Applications**

Easergy MiCOM 30 series rail devices are dedicated to railway catenary protection. The Easergy MiCOM P436 provides catenary protection for classic and two-phase AT feeders.

Easergy MiCOM P436 and Easergy MiCOM P438 enable a wide range of applications to protect supplies and catenaries in classic and autotransformer-fed (AT) systems. With easy connection to virtually all substation and catenary network management systems, the two models are enhanced by a complete range of backup protection and automation functions.



P138 / P436 / P438

**Table 5.48: Functions available for the different models of the Railway protection MiCOM range of relays**

ANSI	Protection Function	P138	P436	P438	P638
21/21N	Distance		•	•	
27/59	Over / under voltage	•	•	•	•
49	Thermal overload	•	•	•	•
50/27	Switch on-to fault	•	•	•	
50H	High current supervision	•	•	•	
50/51N	High current ground fault (tank protection)	•			•
50/51P	Phase overcurrent	•	•	•	•
62/50BF	Circuit breaker failure	•	•	•	•
67P	Phase directional	•	•	•	•
81	Under / over frequency	•	•	•	•
86	Lock-out	•	•	•	•
87T	Transformer differential (windings)				2
di/dt, dv/dt, dΦ /dt	Train startup detection		•	•	
Hz	Rail catenary protection		16 2/3	25/50/60	
TCS	Trip circuit supervision	•	•	•	•
CTS	Current transformer supervision		•	•	
VTS	Voltage transformer supervision	•	•	•	
	2nd harmonic restraint	•	•	•	•
	3rd, 5th, 7th harmonic blocking	•	•	•	
	Defrost protection	•	•	•	
	High impedance fault detection	•	•	•	
	InterMiCOM	•	•	•	

**Table 5.49: Typical Catalog Numbers**

Catalog Numbers	Descriptions
P138849011M0303409612947	Series 30, Feeder relay, 60-250 Vdc/100-230 Vac with 4 high break contact plus 10 inputs and 16 outputs , 61850
P438849020M0308417616947	Series 30, Distance relay, 60-250 Vdc/100-230 Vac with 4 high break contact plus 10 inputs and 16 outputs , 61850
P638849011M0303406612947	Series 30, Transformer Relay, 60-250 Vdc/100-230 Vac with 4 high break contact plus 10 inputs and 16 outputs , 61850

**SAGE RTUs — Introduction**





A variety of SAGE RTU models allow you to choose the right solution for your application. You can deploy the hardware that meets the requirements of each installation. Important distinctions such as physical size, physical I/O quantities, and communications port medium allow you to choose the RTU meeting each application's requirements — no more and no less. Each SAGE RTU provides the same browser-based user interface for easy configuration and setup. Each offers IED integration, NERC CIP security, IEC 61131-based logic functions, communications protocols, and a custom applications library. Each RTU uses the same CPU, firmware, and configuration files, which simplifies spare parts stocking and engineering effort, saving time and money.

Schneider Electric has many years of experience offering custom designed retrofit solutions that provide improved functionality over obsolete RTUs while minimizing the field installation and commissioning time required for the change out of equipment. Each retrofit RTU is specifically designed to make use of as much of the existing equipment as possible. Special interface cards are delivered to connect to the existing termination boards. Terminations are left in place, eliminating the need for field personnel to buzz-out field wiring. Retrofits for Westinghouse Redac, GE GETac, CDC 44-500, CDC 44-550, Harris 5000, L&G 8000/9000, and Tasnet are already available [1]

**Features and Benefits**

- Time Saving
- Easy Upgrade
- Scalable I/O
- Excellent Support
- Made in America
- Cyber-Secure
- Intuitive Configuration
- All Protocols & Apps Included
- Extensive Protocol Suite
- Math and Logic Apps
- Alarming & Annunciation
- SEL Relay Integration
- Grid Automation Apps
- Custom Retrofit Solutions
- Common CPU and Firmware

**Table 5.50: SAGE Product Matrix**

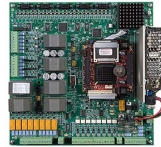
Model	2400	4400	3030M	1410	1430	1450
						
	2400	4400	3030M	1410	1430	1450
<b>Applications Covered</b>						
Substation Data Concentrator		•	•	•		
Substation RTU	Large Substation	Large Substation				
Automation Controller	•	•	•	•	•	•
Protocol Converter	•	•	•	•	•	•
NERC CIP Cybersecure IED Gateway	•	•	•			
Sectionalizer	•					•
Cap Bank Controller	•					•
Feeder RTU					Built in Status and Control	Built in AC Analog Inputs
Flexible Communications Interfaces				•	•	
<b>Characteristics</b>						
Physical Size	12" x 15"	19" x 7" x 10.5"	19" x 5.25" x 10.5"	8" x 5"	12" x 8"	11" x 11"
RS-232	4 / 12	16	16	2 / 10	2 / 10	4 / 12
Serial Fiber	0	0	0	1	0	0
RS-485	0	0	0	1	2	0
Ethernet	2 / 6	2 / 5	2 / 5	2 / 6	2 / 6	2 / 6
Digital Input	16 / 240	224	224	0	16	8
Analog Input	8 / 232	256	0 / 256	0	0 / 256	6 (AC)
Digital Output	128	128 SBO / 256 DO	64	0	4	4
1 ms SOE	0 / 512	256 / 512	0 / 512	0 / 512	0 / 512	0
Analog Output	12	0	0	0	0	0
Mount	Panel	Rack	Rack	Panel / Din	Panel	Panel

- First # indicates built-in capacity, second # indicates maximum expansion capacity
- All units have the same software functionality (Protocols, Applications, User Interface)
- SAGE 1450 Analogs are AC Input type and allow 3 Current and 3 Voltage Inputs. All other models represent milliamp transducer DC Analog Input
- SAGE 4400 has capacity for 128 SBO type Trip / Close pairs and up to 256 Digital Output Points, all on scalable XT Boards
- All Inputs and Outputs in this table are Hardware wired points. Does not include points from IED's.

[1] Visit our website at [www.sage-rtu.com](http://www.sage-rtu.com) for more details.

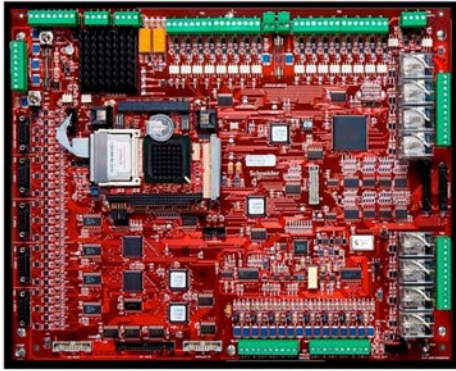

SAGE 2400

## SAGE 2400 RTU

In the SAGE RTU family, the SAGE 2400 RTU offers the most comprehensive physical I/O capabilities and versatile application. Designed for traditional RTU applications, it can accommodate hundreds of analog, digital, and control I/Os along with the easy configuration, protocols, and applications from all SAGE RTUs.

Each SAGE RTU provides the same browser-based user interface for easy configuration and setup. Each RTU offers IED integration, NERC CIP security, IEC 61131-based logic functions, communications protocols, and a custom applications library. [2]

### Applications

- Large Substation RTU
- Automation Controller
- Protocol Converter
- NERC CIP Cybersecure IED Gateway

### Features Onboard

- Size: 12 x 15 Inches
- AMD LX-800 500 MHz CPU with 1 GB flash memory (Common to all SAGE RTU)
- 4x RS232 Serial Ports: Options up to 8 additional RS-232 Serial Ports [3] (12 total serial ports)
- 2x 10/100 Fast Ethernet: Optional 4 Port Switch Available [3]
- 10-33 VDC Power Input
- LEDs for visual indications of communications, digital ins & outs, and other functions
- -40 C to +85 C operating temperature range for reliability in the harshest environments.
- All field connections designed to pass:
  - ANSI C37.90-1979 (R1982)
  - ANSI C37.90.1-1989
  - IEEE 472-1974
- Removable I/O terminal blocks
- Full three-year warranty standard

### Baseboard I/O

- 16 Digital Input / Accumulator Points
- 8 DC Analog Inputs ( $\pm 5$  VDC, 0-5 VDC, 1-5 VDC,  $\pm 1$  mA, 0-1 mA, 4-20 mA, 10-50 mA)
- 4x SBO or 8x DO Control points (Configurable)
- 2x Alarm Contact points

### I/O Expansion Capabilities

- Up to 240 Digital Input Points (5 ms)
- Up to 232 DC Analog Input Points (Several Variances Available)
- Up to 128 SBO Trip Close Pairs / 256 Digital Output Points
- Up to 512 1ms SOE Digital Input Points [3]
- Up to 12 Analog Output Points [4]
- A combination of Special Function Bus Cards
  - ACI [4]
  - 1MS SOE [4]
  - Digital Output
- IRIG-B [3]
- GPS [3]

### Same Firmware Capabilities in all SAGE RTUs

- Intuitive config@WEB Browser Based User Interface: No proprietary Software Required
- Extensive Protocol Suite included with every unit
- Configurable Math, Logic, and Automation Applications
- IEC 61131 Compliant IsaGRAF Programming Interface
- NERC CIP Cybersecurity
- Advanced Logging with Syslog Client
- Force Point Data
- SEL IED Management (AutoConfig, EVE File Storing, Config Change Management)
- Detailed Comm Diagnostics and Counters: PCAP, Protocol Captures
- Secure Ethernet Protocols
  - IPSec / IKE
  - HTTPS
  - SSL / SSH
  - SFTP
  - Embedded Firewall

[2] See our website for a full catalog of I/O Expansion Options.

[3] On PC/104 Expansion Cards

[4] On Discontinued Cards



SAGE 3030

Designed for Substation Gateway applications, the SAGE 3030 Magnum can accommodate many vendor agnostic IED's via Serial and Ethernet communications. The SAGE 3030M RTU offers the most communications ports while allowing traditional hardwire I/O options from other SAGE models.

Each SAGE RTU provides the same browser-based user interface for easy configuration and setup. Each RTU offers IED integration, NERC CIP security, IEC 61131-based logic functions, communications protocols, and a custom applications library. [5]

**SAGE 3030 Magnum RTU**

**Applications**

- Substation Data Concentrator
- Substation RTU
- Automation Controller
- Protocol Converter
- NERC CIP Cybersecure IED Gateway

**Features Onboard**

- Size: 19 x 5.25 x 10.5 Inches
- Serial Ports: 16 x RS-232
- 40° to +80° C Operating Temperature
- Ethernet Ports: 2 x 10/100 Mbps (Optional 3 port Ethernet switch)
- AMD LX-800 500 MHz CPU with 1 GB flash memory (Common to all SAGE RTU)
- Non Windows® OS (VxWorks)
- PC/104™ bus architecture
- Time Syncing
  - Continuous IRIG-B output with built-in bus to all communication ports for IRIG-B In, GPS, RTC, or protocol time synchronization
  - GPS [6]
  - Protocols
  - Arbiter
- 2x Alarm Contacts
- Wide range Power Input Options
- 85-254 VAC, 85-350 VDC
- Designed for Electric Utility applications
- Meet IEEE 472, ANSI C37.90 SWC
- Meet C37.90.1 standards
- Full 3 Year Warranty Standard
- Rugged relay-style metal enclosure for easy rack mounting
- Over 100 LEDs for positive visual Indications
  - Serial Communications (TX, RX, DCD/+5V, CTS, RTS) x 18 Power, Run, Reset, Local, Time Source Fail, IED Failed, User Logged In, Config Changed, RLL Running, Ethernet Lik, and Alarm 1 & 2

**Hardware I/O Options**

- Up to 224 Status / Acc Inputs (5 ms)
- Up to 64 SBO Trip Close Pairs (momentary and latching)
- Up to 256 DC Analog Input points [6]
- Up to 512 1ms SOE Status inputs [6]

**Same Firmware Capabilities in all SAGE RTUs**

- Intuitive config@WEB Browser Based User Interface
- No proprietary Software Required
- Extensive Protocol Suite included with every unit
- Configurable Math, Logic, and Automation Applications
- IEC 61131 Compliant IsaGRAF Programming Interface
- NERC CIP Cybersecurity
- Advanced Logging with Syslog Client
- SEL IED Management (AutoConfig, EVE File Storing, Config Change Management)
- Force Point Data
- Detailed Comm Diagnostics and Counters
- PCAP, Protocol Captures
- Secure Ethernet Protocols
  - IPsec / IKE
  - HTTPS
  - SSL / SSH
  - SFTP
- Embedded Firewall



SAGE 4400

The SAGE 4400 combines the best features of the SAGE 3030M and the SAGE 2400. The 4400 is a rack mounted RTU with all the communications capabilities of the 3030M and the I/O flexibility of the SAGE 2400. The 4400 uses the same I/O cards as the other SAGE products for maximum retrofit capability and is designed for applications that require a significant capability for discrete I/O. It includes enough processor power for integration of many IED's as well as intelligent embedded applications and logic functions.

Each SAGE RTU provides the same browser-based user interface for easy configuration and setup. Each RTU offers IED integration, NERC CIP security, IEC 61131-based logic functions, communications protocols, and a custom applications library. [5]

**SAGE 4400 RTU**

**Applications**

- Substation Data Concentrator
- Large Substation RTU
- Automation Controller
- Protocol Converter
- NERC CIP Cybersecure IED Gateway

**Features Onboard**

- Size: 19 x 7 x 10.5 Inches
- -40° to +80° C Operating Temperature
- AMD LX-800 500 MHz CPU with 1 GB flash memory (Common to all SAGE RTU)
- Serial Ports: 16 x RS232 with Comm Status LED's on Front Panel
  - RTU status LED's on Front Panel
  - 5VDC available on each port (up to 5W total)
  - 300-115,000 bps available
- Ethernet Ports: 2 x 10/100 Mbps (Optional 3 port switch [6])
- 2x Alarm Contacts Onboard
- Remote/Local Switch with available Dry Contacts
- Time Syncing
  - IRIG-B In -> Distributed to all 16 Serial ports
  - GPS [6]
  - Protocols
  - Arbiter
- Power Input Options
  - 10-33 VDC
  - With Input Fusing and power switch
  - Grounding Bar

**Hardware I/O Options**

- Options with more user friendly cable interface (See attached brochure for I/O details)
- Up to 224 Status Inputs (5 ms)
- Up to 256 - 1 ms SOE Status Inputs
- Up to 128 SBO Trip Close Pairs
- Up to 256 DC Analog Input points
- Up to 256 DO Digital Output Points

**Same Firmware Capabilities in all SAGE RTUs**

- Intuitive config@WEB Browser Based User Interface. No proprietary Software Required
- Extensive Protocol Suite included with every unit
- Configurable Math, Logic, and Automation Applications
- IEC 61131 Compliant IsaGRAF Programming Interface
- NERC CIP Cybersecurity
- Advanced Logging with Syslog Client
- SEL IED Management (AutoConfig, EVE File Storing, Config Change Management)
- Force Point Data
- Detailed Comm Diagnostics and Counters
- PCAP, Protocol Captures
- Secure Ethernet Protocols
  - IPsec / IKE
  - HTTPS
  - SSL / SSH
  - SFTP
- Embedded Firewall

[5] See our website for a full catalog of I/O Expansion Options.  
 [6] Available with PC/104 Expansion Cards



SAGE 1410

Smart and compact data concentrator / protocol converter / gateway solution.

Each SAGE RTU provides the same browser-based user interface for easy configuration and setup. Each RTU offers IED integration, NERC CIP security, IEC 61131-based logic functions, communications protocols, and a custom applications library.

### SAGE 1410 RTU

#### Applications

- Substation Data Concentrator
- Automation Controller
- Protocol Converter
- Flexible Communications Interfaces

#### Features

- Compact Footprint 8 x 5 x 2 (W x L x H) Inches
- 40° to +85° C Operating Temperature
- Two — Built-in 10/100 Mbps Ethernet® ports (independent IPs) : Optional four port Ethernet switch [7]
- Two RS232 w/LEDs for DCD, RX, RTS, CTS and TX (Expands to 10 [7])
- One RS485 w/LEDs for RX and TX (2 wire operation)
- One Fiber Optic communications w/LEDs for RX and TX
- AMD LX-800 500 MHz CPU with 1 GB flash memory (Common to all SAGE RTU)
- PC/104™ bus architecture for easy future upgrades
- Optional 125 VDC/20-60 VDC/120 VAC power supply
- Separate PPP port for serial dial-up
- Non-Windows® OS (VxWorks)
- Designed for Electric Utility applications
  - Meet IEEE 472, ANSI C37.90 SWC
  - Meet C37.90.1 standards
- Optional on board GPS Receiver
- Optional IRIG-B Input/Output
- On board LEDs show operational status: Power / Full Comm Status indications
- Full three Year Warranty Standard
- Accepts 12-33VDC Input Power directly

#### Same Firmware Capabilities in all SAGE RTUs

- Intuitive config@WEB Browser Based User Interface. No proprietary Software Required
- Extensive Protocol Suite included with every unit
- Configurable Math, Logic, and Automation Applications
- IEC 61131 Compliant IsaGRAF Programming Interface
- NERC CIP Cybersecurity
- Advanced Logging with Syslog Client
- SEL IED Management (AutoConfig, EVE File Storing, Config Change Management)
- Force Point Data
- Detailed Comm Diagnostics and Counters
- PCAP, Protocol Captures
- Secure Ethernet Protocols
  - IPsec / IKE
  - HTTPS
  - SSL / SSH
  - SFTP
  - Embedded Firewall

### SAGE 1430 RTU

#### Applications

- Feeder RTU with built in Status and Control
- Automation Controller
- Protocol Converter
- Flexible Communications Interfaces

#### Features

- Compact Footprint: 8 x 12.5 x 4 (W x L x H) Inches
- 40° to +85° C Operating Temperature
- 2 - Built-in 10/100 Mbps Ethernet® ports (independent IPs)
- Optional – 4 port Ethernet switch
- 2 RS232 w/LEDs for DCD, RX, RTS, CTS and TX (Expandable to 10)
- 2 RS485 w/LEDs for RX and TX (2 wire operation)
- Separate PPP port for serial dial-up
- AMD LX-800 500 MHz CPU with 1 GB flash memory (Common to all SAGE RTU)
- Non Windows® OS (VxWorks)
- PC/104™ bus architecture

#### Hardware I/O

- 16 Digital Inputs (Status/Accumulator/SOE)
- 4 T/C Momentary Controls (8 relays)
- Easy to connect removable Phoenix® type terminal blocks
- Designed for Electric Utility applications
  - Meet IEEE 472, ANSI C37.90 SWC
  - Meet C37.90.1 standards
- Optional on board GPS Receiver
- Optional IRIG-B Input/Output
- Optional DC Analog Input Module
- On board LEDs show operational status (Power / Full Comm Status indications)
- Full 3 Year Warranty Standard
- Built-in 125 VDC/20-60 VDC/120 VAC power supply

#### Same Firmware Capabilities in all SAGE RTUs

- Intuitive config@WEB Browser Based User Interface. No proprietary Software Required
- Extensive Protocol Suite included with every unit
- Configurable Math, Logic, and Automation Applications
- IEC 61131 Compliant IsaGRAF Programming Interface
- NERC CIP Cybersecurity
- Advanced Logging with Syslog Client
- Force Point Data
- SEL IED Management (AutoConfig, EVE File Storing, Config Change Management)
- Detailed Comm Diagnostics and Counters
- PCAP, Protocol Captures
- Secure Ethernet Protocols
  - IPsec / IKE
  - HTTPS
  - SSL / SSH
  - SFTP
  - Embedded Firewall

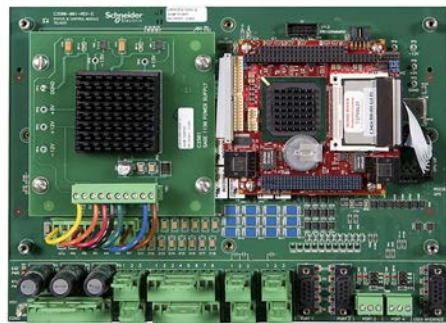

SAGE 1430

Compact status and control module with powerful IED integration capabilities.

Each SAGE RTU provides the same browser-based user interface for easy configuration and setup. Each RTU offers IED integration, NERC CIP security, IEC 61131-based logic functions, communications protocols, and a custom applications library.

[7] With PC/104 Expansion Cards

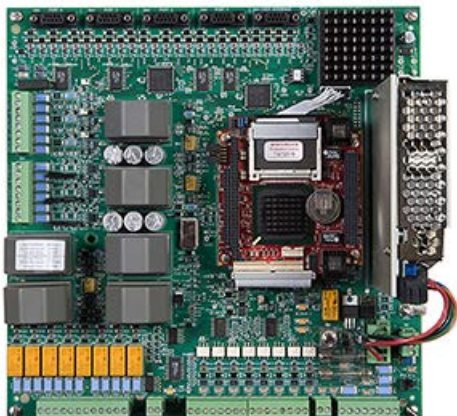

SAGE 1450

## SAGE 1450 RTU

A powerful pole-top distribution automation platform with all the functionality of a gateway. AC Input (ACI) option provides an advanced transducer-less AC analog input capability. The SAGE 1450 can be used for interfacing to conventional PTs and CTs as well as standard current/voltage linepost sensors such as the Square D LSCV Line Post Sensors or Lindsey CVMI linepost sensors. These terminations include custom instrument-grade transformers, designed for high linearity and ultra low phase shift, which provide the high impedance inputs required for the linepost sensor resistor divider voltage outputs.

Each SAGE RTU provides the same browser-based user interface for easy configuration and setup. Each RTU offers IED integration, NERC CIP security, IEC 61131-based logic functions, communications protocols, and a custom applications library.

### Applications

- Feeder RTU with built in AC Analog Inputs
- Automation Controller
- Protocol Converter
- Sectionalizer
- Cap Bank Controller

### Features

- Compact Footprint: 11 x 11 x 4 Inches
- 40° to +85° C Operating Temperature
- Two Built-in independent Ethernet Ports
- Optional 4 Port Ethernet switch [8]
- Four Built-in serial ports (expands to 12 [8])
- Separate PPP port for serial dial-up
- AMD LX800 500 Mhz CPU w/ 1 GB Flash Memory
- Built-in Battery Charger w/low voltage disconnect
- On Board I/O with removable terminal blocks
  - 8 Digital Inputs (Sts/Accum/SOE)
  - 4 T/C Mom Pairs (8 relays - 2A@30VDC )
  - 6 Transducerless AIs (3 current & 3 voltage)
  - 2 DC Analog Inputs (Input Voltage and Battery Voltage)
- On board LEDs show operational status
  - Power, status, control indications
  - Full Comm Status indications
- Accepts 9-33 VDC Input Power directly
- Optional 125 VDC/20-60 VDC/120 VAC on-board power supply
- Designed for Electric Utility applications
  - Meet IEEE 472, ANSI C37.90 SWC
  - Meet C37.90.1 standards
- Optional On-Board GPS Receiver [8]
- Optional IRIG-B Input/Output [8]
- Full 3 Year Warranty Standard

### Same Firmware Capabilities in all SAGE RTUs

- Intuitive config@WEB Browser Based User Interface. No proprietary Software Required
- Extensive Protocol Suite included with every unit
- Configurable Math, Logic, and Automation Applications
- IEC 61131 Compliant IsaGRAF Programming Interface
- NERC CIP Cybersecurity
- Advanced Logging with Syslog Client
- SEL IED Management (AutoConfig, EVE File Storing, Config Change Management)
- Force Point Data
- Detailed Comm Diagnostics and Counters
- PCAP, Protocol Captures
- Secure Ethernet Protocols
  - IPsec / IKE
  - HTTPS
  - SSL / SSH
  - SFTP
  - Embedded Firewall

## SAGE Sales and Support

### New RTU Sales

Email:	USUtilityQuotes@schneider-electric.com
Tips:	Tips: Power Input Requirements, Hard wired I/O Requirements, Communications Ports Needed, Mounting, Other options needed will expedite the quotation process.

### Spares and Upgrades

Phone:	(713) 920-6897
Email:	USUtilityQuotes@schneider-electric.com
Tips:	Having the Part Number from the Baseboard or CPU will help choose the right spare for your application.

### Technical Support

Phone:	(713) 920-6832
Email:	sagertu_support@schneider-electric.com
Tips:	Generally a copy of the configuration, data traps, and the firmware version will help us diagnose any problems.

### Repairs

Email:	USUtilityQuotes@schneider-electric.com
Tips:	Have the Tag numbers from the affected products, and the Serial Number. Remove known good parts to minimize any repair costs.

[8] With PC/104 Expansion Cards

New!

### Easergy™ T300 RTUs — Introduction

The Easergy T300 is a single, powerful feeder RTU designed to prepare your business for the future. It helps you evolve with the grid, improve downtime tolerance, and manage increasing energy demand. It also helps you meet increased quality and performance requirements, optimize costs, and improve the efficiency of your electrical distribution network. Easergy T300 Remote Terminal Unit (RTU) is a modular platform of hardware and firmware, and an application building block for Medium Voltage and Low Voltage public distribution network management. It offers a single solution for control and monitoring from a simple pole-top device to a large MV/MV or MV/LV substation. [1]

#### Features and Benefits

- Reduce MV and LV outage durations (SAIDI)
- Centralized and decentralized MV and LV distribution network management: fault location, isolation, and service restoration
- Private network management (MV loops): Self-healing network management – Automatic Transfer Switch
- Volt/VAR optimization support for distributed generation integration
- MV and LV power and quality measurement according to standard EN 50160
- Synchronize voltage measurements on the feeder in order to facilitate distributed generation integration
- Asset management efficiency. Reduce CAPEX with a single, multi-application, modular offer
- Strong Cybersecurity Management

Table 5.51: Easergy T300 RTUs — Overview





HU250 Head Unit and Communication Gateway	SC150 MV Switchgear Controller	LV150 Transformer and LV Switchboard Monitoring
		
HU250	SC150	LV150
<b>Applications covered:</b>	<b>Applications covered:</b>	<b>Applications covered:</b>
<ul style="list-style-type: none"> <li>• Communication Gateway</li> <li>• Automation Controller</li> <li>• Sectionalizer</li> <li>• Cap Bank Controller &amp; Volt Var Optimization</li> <li>• Distributed energy resources control and monitoring</li> <li>• Cybersecurity Gateway                             <ul style="list-style-type: none"> <li>– Compliant with IEC 62351 and IEEE P1686</li> <li>– SCADA communication security (IEC 62351-5)</li> <li>– Local and remote access security based on RBAC (IEC 62351-8)</li> <li>– Connection security for maintenance (local and remote): HTTPS, SSH</li> <li>– Protocol security for file transfer: SFTP</li> <li>– Authentication by centralized Radius client</li> </ul> </li> </ul>	<ul style="list-style-type: none"> <li>• MV Network Management. Modular up to 24 Load Break Switches</li> <li>• Non-Directional and Directional Fault Detection</li> <li>• Sectionalizer and Auto Transfer Source Automation</li> <li>• Power measurement (IEC 61557-12)</li> <li>• Power Quality (IEC 61000-4-30 Class S)</li> <li>• Underground MV/MV and MV/LV substation control and monitoring</li> <li>• Overhead load break switch (LBS) control</li> </ul>	<ul style="list-style-type: none"> <li>• LV network distribution monitoring</li> <li>• LV Power measurement according to IEC 61557-12</li> <li>• LV Power quality according IEC 61000-4-30 Class S</li> <li>• Pad-mounted and Overhead Transformer temperature monitoring</li> <li>• LV Broken conductor detection (fuse detection)</li> </ul>

Table 5.52: Easergy T300 Power Supplies

PS50 and PS25 Power Supplies	
	
PS50	PS25
Wide range of smart power supplies. The Easergy T300 back-up power supplies are designed for power supply interruptions in order to maintain control and monitoring of the MV substation during the outage.	

[1] Refer to catalog (document number NRJED314621EN) or the Easergy T300 product range for more information.





HU250

### Easergy HU250 Communication Gateway

Easergy™ HU250 is a powerful and flexible communication gateway for all Easergy T300 configurations. [2]

- Easergy HU250 can also be used as a standalone gateway for third-party IEDs
- Open to any communication system and protocol
- Compliant with cyber security standards
- Advanced configuration tools
- Open to IEC 61131 applications
- Web server for easy commissioning and maintenance
- Easy remote and local firmware updates
- Secure Wi-Fi connectivity

**Table 5.53: Easergy HU250**

Description	Catalog Number
Easergy HU250: head unit communication gateway with cyber security management	EMS59000



SC150

### Easergy SC150 Medium Voltage Switch Controller

All advanced functions for MV line and switchgear management in a compact box. [2]

- Switchgear control and monitor
- Advanced fault detection
- Power measurement
- Power quality
- Sectionalizer automation
- Embedded operator HMI
- Automation systems
  - Automatic Transfer Source (ATS), self healing, etc., are hosted in HU250 and are designed in a IEC 61131-3 PLC workbench.
  - The sectionalizer automation (SEC) concerning one switchgear is managed by the SC150 module. This automation is factory predefined but configurable on site. This automation provides the autonomous ability to open the MV switch following detection of a number of fault currents.

**Table 5.54: Easergy SC150**

Description	Catalog Number
SC150 Medium Voltage Switch Controller CT-LPVT/VT, 1/5 A - LPVT/VT sensors	EMS59201
SC150 Medium Voltage Switch Controller CT-CAPA, 1/5 A - VPIS/VDS/PPACS sensors	EMS59202



LV150

### Easergy LV150 Low Voltage Transformer Monitor

The Easergy LV150 is an unmatched low voltage monitoring module designed for the public MV/LV substation. It combines accurate 3-phase energy and power measurements with data logging, power quality analysis, alarming and temperature capabilities not typically available in such a compact RTU. The Easergy LV150 is compliant with stringent international standards that enhance its metering accuracy and power quality measurements, as specified by the safety standard requirement for the MV/LV substation. Easergy LV150 gives you the energy intelligence and control needed to track performance, stay informed in real time of critical conditions and empower you to make strategic decisions. It will help you increase reliability, maximize the use of resources and improve service. [2]

#### Applications

- Transformer temperature monitoring
- LV incomer power monitoring
- LV incomer power quality monitoring
- LV network voltage fault detection (loss of neutral at transformer level)

**Table 5.55: Easergy LV150**

Description	Catalog Number
Low Voltage Transformer Monitor	EMS59300

[2] Refer to catalog (document number NRJED314621EN) or the Easergy T300 product range for more information.



### Easergy PS50 and PS25 Backup Power Supplies

The Easergy T300 PS50 and PS25 backup power supplies are designed for long power supply interruption and to maintain control and monitoring of the entire MV substation during outages. Designed to supply all components in the substation including switchgear mechanics and motors. The Easergy PS50 is ideal for isolated sites that are regularly struck by lightning. [3]

- 10 kV insulation and 20 kV surge
- Protected against neutral cutout
- High temperature range: -40° C to 70° C and easy maintenance
- Only a unique battery (PS50 and PS25-12) for easy maintenance and robust lifespan (> 10 years)
- Battery end-of-life monitoring for preventive maintenance

#### Applications

- Designed for severe environments with a high level of insulation
- Designed for very long outage times
- Easy maintenance with only one battery

**Table 5.56: Easergy T300 PS50 and PS25 Backup Power Supplies**

Description	Catalog Numbers
Easergy PS25-12V: Power supply and battery charger single 12V 48W output	<a href="#">EMS58585</a>
Easergy PS25-24V: Power supply and battery charger single 24V 48W output	<a href="#">EMS58586</a>
Easergy PS50-24V: Power supply and battery charger 12V and 24V outputs	<a href="#">EMS58587</a>
Easergy PS50-48V: Power supply and battery charger 12V and 48V outputs	<a href="#">EMS58588</a>

[3] Refer to catalog (document number NRJED314621EN) or the Easergy T300 product range for more information.

## Easergy P Series — Introduction

Easergy protective relays are a complete range of devices for medium voltage applications, including feeder, motor, transformer, line, and generator protection. Built on more than 100 years of experience in medium-voltage protection relays with MiCOM, SEPAM, and Vamp, the new Easergy protective relays have been designed to meet the most demanding needs for electrical protection, connectivity, and safety, while taking a step forward in efficiency.

### The Easergy P3 Range

#### Features and Benefits

- Simplified configuration with the new eSetup Easergy Pro setting tool
- Faster delivery with on-the-shelf availability of standard configurations
- Simpler operation and maintenance with the Schneider Electric Power Device App
- Native support for a wide range of communication protocols: IEC 61850, Modbus TCP/IP, Modbus RTU, DNP 3.0, SPA-bus, IEC 60870-5-101, IEC 60870-5-103, ProfibusDP, and DeviceNet
- Embedded arc protection
- Built-in virtual injection testing
- Compliant with international standards



Refer to catalog [NRJCAT17764EN](#) for the Easergy P3 Series.

### Easergy P3 Characteristics

Table 5.57: Easergy P3 Characteristics

Characteristics	Easergy P3 Standard		Easergy P3 Advanced						
	P3U20	P3U30	P3F30	P3L30	P3M30	P3G30	P3T32	P3M32	P3G32
Application	Feeder	•	•	•	•	—	—	—	—
	Transformer	•	•	—	—	—	•	—	—
	Motor	•	•	—	—	•	—	•	—
	Generator	•	•	—	—	—	•	—	•
Measuring inputs	Phase current	1/5A CT (x3) <sup>[1]</sup>		1/5A CT (x3) <sup>[1]</sup>			1/5A CT (x6)		
	Residual current	1/5A CT or 0.2/1A CT		(1/5A+0.2/1A) CT			2 x (1/5A+0.2/1A) CT		
	Voltage	VT (x1)	VT (x4) or LPVT (x5) <sup>[1]</sup>	VT (x4)			VT (x4)		
Arc-flash sensor inputs	—	—	Loop sensor: 1 Point sensor: 2, 4 or 6 <sup>[2][3]</sup>			Loop sensor: 1 Point sensor: 2, 4 or 6 <sup>[2]</sup>			
Digital	Inputs	8/10	14/16	6 to 36			6 to 16		
	Outputs	5/8 + SF	11/8 + SF	10 to 21 + SF			10 to 13 + SF		
Analogue	Inputs	0 or 4 <sup>[2]</sup>		0 or 4 <sup>[2]</sup>			0 or 4 <sup>[2]</sup>		
	Outputs	0 or 4 <sup>[2]</sup>		0 or 4 <sup>[2]</sup>			0 or 4 <sup>[2]</sup>		
Temperature sensor inputs	0 or 8 or 12 <sup>[2]</sup>		0 or 8 or 12 <sup>[2]</sup>			0 or 8 or 12 <sup>[2]</sup>			
Front port	USB type B		USB type B			USB type B			
Nominal power supply	24V dc or 24–48V dc or 48–230V ac/dc <sup>[4]</sup>		24 to 48V dc or 110–240V ac/dc			24 to 48V dc or 110–240V ac/dc			
Ambient temperature, in service	–40 to 60°C (–40 to 140°F)		–40 to 60°C (–40 to 140°F)			–40 to 60°C (–40 to 140°F)			
<b>Communication</b>									
Rear Ports	•		•			•			
RS232, IRIG/B, RS485, Ethernet	•		•			•			
Protocols	IEC61850 Ed1 & Ed2	•		•			•		
	IEC 60870-5-101 & 103	•		•			•		
	DNP3 over Ethernet	•		•			•		
	DNP3 serial	•		•			•		
	Modbus serial	•		•			•		
	Modbus over Ethernet	•		•			•		
	EtherNet IP <sup>[5]</sup>	•		•			•		
	DeviceNet	•		•			•		
	Profibus DP	•		•			•		
	SPAbus	•		•			•		
Redundancy protocols (RSTP/PRP)	•		•			•			
Control	4 objects 4 display	4 objects 8 display	5–6 objects 3–8 display			5–6 objects 3–8 display			
<b>Others</b>									
Logic (Matrix + Logic equation)	•		•			•			
Withdrawable CT connector with shorting	•		—			—			
Remote HMI	—		•			•			
Hardware dimensions (W/H/D)	171 x 176 x 214 <sup>[6]</sup> mm / 6.73 x 6.93 x 8.43 in		264 x 177 x 208 mm / 10.39 x 6.97 x 8.19 in			264 x 177 x 208 mm / 10.39 x 6.97 x 8.19 in			

[1] P3U30 and P3F30 relays only. Consult us for other models  
 [2] Depends on optional module  
 [3] P3L30 can have 1 loop or 2 point sensors only  
 [4] Check the available power supply range from the device's serial number label  
 [5] Consult us for availability  
 [6] 226 mm (8.90 in) with ring-lug connectors

Easergy P3 Applications

Table 5.58: Protection Functions

Protection functions	ANSI code	Standard (P3U)				Advanced (P3x)				
		P3U20	P3U30	P3F30	P3L30	P3M30	P3M32	P3G30	P3G32	P3T32
Distance	21	—	—	—	1	—	—	—	—	—
Under-impedance	21G	—	—	—	—	—	—	2	2	—
Fault locator	21FL	—	1	1	1	—	—	—	—	—
Overfluxing	24	—	—	—	—	—	—	1	1	1
Synchro-check	25	—	2	2	2	2	2	2	2	2
Undervoltage	27	—	3	3	3	3	3	3	3	3
Positive sequence undervoltage	27P	—	—	—	—	—	—	2	2	—
Stator ground-fault detection	27TN/64G	—	—	—	—	—	—	1	1	—
Directional active underpower	32	—	2	2	2	2	2	2	2	2
Phase undercurrent	37	1	1	—	—	1	1	—	—	—
Temperature monitoring	38/49T	12 [7][8]	12 [7]	12 [7]	12 [7]	12 [7]	12 [7]	12 [7]	12 [7]	12 [7]
Loss of field	40	—	—	—	—	—	—	1	1	—
Under-reactance	21/40	—	—	—	—	—	—	2	2	—
Negative sequence overcurrent (motor, generator)	46	2	2	—	—	2	2	2	2	2
Current unbalance, broken conductor	46BC	—	—	1	1	—	—	—	—	—
Incorrect phase sequence	47	1	1	—	—	1	1	—	—	—
Excessive start time, locked rotor	48/51LR	1	1	—	—	1	1	—	—	—
Thermal overload	49	1	1	1	1	1	1	1	1	1
Phase overcurrent	50/51	3	3	3	3	3	3	3	3	3
Ground fault overcurrent	50N/51N	5	5	5	5	5	5	5	5	5
Breaker failure	50BF	1	1	1	1	1	1	1	1	1
Switch On To Fault (SOTF)	50HS	1	1	1	1	1	1	1	1	1
Capacitor bank unbalance	51C	2	2	2	2	2	2	2	2	2
Voltage dependant overcurrent	51V	—	1	1	1	—	—	1	1	—
Overvoltage	59	—	3	3	3	3	3	3	3	3
Capacitor overvoltage	59C	—	—	1	1	—	—	—	—	—
Neutral voltage displacement	59N	3	3	2	2	2	2	2	2	2
CT supervision	60	1	1	1	1	1	1	1	2	2
VT supervision	60FL	—	1	1	1	1	1	1	1	1
Stator ground fault	64S	—	—	—	—	—	—	1	1	—
Frequent start inhibition	66	1	1	—	—	1	1	—	—	—
Directional phase overcurrent	67	—	4	4	4	4	4	4	4	4
Directional ground-fault o/c	67N	3	3	3	3	3	3	3	3	3
Transient intermittent	67NI	—	—	1	1	—	—	—	—	—
Magnetizing inrush detection	68F2	1	1	1	1	1	1	1	1	1
Fifth harmonic detection	68H5	1	1	1	1	1	1	1	1	1
Pole slip	78PS	—	—	—	—	—	—	1	1	—
Auto-recloser	79	—	—	5	5	—	—	—	—	—
Over or under frequency	81	—	2/2	2/2	2/2	2/2	2/2	2/2	2/2	2/2
Rate of change of frequency	81R	—	1	1	1	1	1	1	1	1
Under frequency	81U	—	2	2	2	2	2	2	2	2
Lockout	86	1	1	1	1	1	1	1	1	1
Line differential	87L	—	—	—	2	—	—	—	—	—
Machine differential	87M	—	—	—	—	—	2	—	—	—
Transformer differential	87T	—	—	—	—	—	—	—	—	2
Programmable stages	99	8	8	8	8	8	8	8	8	8
Arc-flash detection stages		—	—	8	8	8	8	8	8	8
Cold load pick-up		1	1	1	1	1	1	1	1	1
Programmable curves		3	3	3	3	3	3	3	3	3
Setting groups[9]		4	4	4	4	4	4	4	4	4

Table 5.59: Control Functions

Control functions	Standard (P3U)				Advanced (P3x)				
	P3U20	P3U30	P3F30	P3L30	P3M30	P3M32	P3G30	P3G32	P3T32
Switchgear control and monitoring	1/6	6	6	6	6	6	6	6	6
Switchgear monitoring only	2	2	2	2	2	2	2	2	2
Programmable switchgear interlocking	•	•	•	•	•	•	•	•	•
Local control on single-line diagram	•	•	•	•	•	•	•	•	•
Local control with O/I keys	•	•	•	•	•	•	•	•	•
Local/remotely function	•	•	•	•	•	•	•	•	•
Function keys	2	2	2	2	2	2	2	2	2
Custom logic (logic equations)	•	•	•	•	•	•	•	•	•
Control with Smart application	•	•	•	•	•	•	•	•	•

Table 5.60: Measurement

Measurement	Standard (P3U)				Advanced (P3x)				
	P3U20	P3U30	P3F30	P3L30	P3M30	P3M32	P3G30	P3G32	P3T32
RMS current values	•	•	•	•	•	•[10]	•	•[10]	•[10]
RMS voltage values	•	•	•	•	•	•	•	•	•
RMS active, reactive and apparent power	—	•	•	•	•	•	•	•	•

[7] Using external RTD module  
 [8] 12 optional temperature sensors for P3U20  
 [9] Not all protection functions have 4 setting groups. See details in the manual.  
 [10] Function available on both sets of CT inputs

**Table 5.60 Measurement (cont'd.)**

Measurement	Standard (P3U)			Advanced (P3x)					
	P3U20	P3U30	P3F30	P3L30	P3M30	P3M32	P3G30	P3G32	P3T32
Frequency	•	•	•	•	•	•	•	•	•
Fundamental frequency current values	•	•	•	•	•	• <sup>[11]</sup>	•	• <sup>[11]</sup>	• <sup>[11]</sup>
Fundamental frequency voltage values	—	•	•	•	•	•	•	•	•
Fundamental frequency active, reactive and apparent power values	—	•	•	•	•	•	•	•	•
Power factor	—	•	•	•	•	•	•	•	•
Energy values active and reactive	—	•	•	•	•	•	•	•	•
Energy transmitted with pulse outputs	—	•	•	•	•	•	•	•	•
Demand values: phase currents	•	•	•	•	•	•	•	•	•
Demand values: active, reactive, apparent power and power factor	—	•	•	•	•	•	•	•	•
Minimum and maximum demand values: phase currents	•	•	•	•	•	•	•	•	•
Minimum and maximum demand values: RMS phase currents	•	•	•	•	•	•	•	•	•
Minimum and maximum demand values: active, reactive, apparent power and power factor	—	•	•	•	•	•	•	•	•
Maximum demand values over the last 31 days and 12 months: active, reactive, apparent power	—	•	•	•	•	•	•	•	•
Minimum demand values over the last 31 days and 12 months: active, reactive power	—	•	•	•	•	•	•	•	•
Maximum and minimum values: currents	•	•	•	•	•	•	•	•	•
Maximum and minimum values: voltages	•	•	•	•	•	•	•	•	•
Maximum and minimum values: frequency	•	•	•	•	•	•	•	•	•
Maximum and minimum values: active, reactive, apparent power and power factor	—	•	•	•	•	•	•	•	•
Harmonic values of phase current and THD	•	•	•	•	•	• <sup>[11]</sup>	•	• <sup>[11]</sup>	• <sup>[11]</sup>
Harmonic values of voltage and THD	—	•	•	•	•	•	•	•	•
Voltage sags and swells	—	•	•	•	•	•	•	•	•

**Table 5.61: Logs and Records**

Logs and Records	Standard (P3U)			Advanced (P3x)					
	P3U20	P3U30	P3F30	P3L30	P3M30	P3M32	P3G30	P3G32	P3T32
Sequence of event record	•	•	•	•	•	•	•	•	•
Disturbance record	•	•	•	•	•	•	•	•	•
Tripping context record	•	•	•	•	•	•	•	•	•

**Table 5.62: Monitoring Functions**

Monitoring functions	Standard (P3U)			Advanced (P3x)					
	P3U20	P3U30	P3F30	P3L30	P3M30	P3M32	P3G30	P3G32	P3T32
Trip circuit supervision (ANSI 74)	1	1	1	1	1	1	1	1	1
Circuit breaker monitoring	1	1	1	1	1	1	1	1	1
Relay monitoring	•	•	•	•	•	•	•	•	•

[11] Function available on both sets of CT inputs

# Section 6

## Surge Protective Devices (SPDs) and Easy UPS 3S

Commercial and Industrial Applications



SurgeLogic™ Type EMA



SurgeLogic™ Type IMA

SurgeLogic™ Type XDSE



SurgeLogic™ NQ SurgeLoc

Residential & Light Commercial Applications



SurgeLogic™ Type SDSA



HEPD80



Square D™ QO/HOM PON SPDs



Whole House SPDs



Easy UPS 3S

<b>Externally Mounted SPDs</b>	<b>6-2</b>
Overview	6-2
EMA Series SPDs	6-2
Replacement Modules	6-3
<b>Internally Mounted SPDs</b>	<b>6-3</b>
Overview	6-3
Internally Mounted—New Construction/Factory Assembled	6-4
Internally Mounted SPDs—Retrofit/Ready to Install	6-5
Internally Mounted—Retrofit/Ready to Install	6-5
SurgeLogic™ SurgeLoc for NQ Panelboards	6-6
OEM/Assembler Kits	6-7
<b>Nipple-Mounted SPDs</b>	<b>6-8</b>
XDSE Surge Protective Devices	6-8
SurgeLogic™ Type XDSE Surge Protective Devices	6-8
HWA SPDs	6-9
XR Surge Protective Devices	6-9
SDSA1175 and SDSA 3-Phase SPDs	6-10
<b>Residential SPDs</b>	<b>6-11</b>
Whole House SPDs	6-11
Surgebreaker Plus Whole House Accessories	6-11
Surgebreaker Plus Whole House Accessories	6-11
HEPD Whole Home Surge Protective Devices	6-12
Whole Home Surge Protection	6-12
Plug on Neutral QO™ and Homeline™ Load Center SPDs	6-12
QO™, NQ, and Homeline™ Load Center Surge Protective Devices	6-12
<b>Square D™ Easy UPS 3S</b>	<b>6-13</b>
Square D Easy UPS 3S (UL 208 V)	6-13

## Externally Mounted Surge Protective Devices SurgeLogic™ Type EMA

SurgeLogic™ Type EMA series SPDs offer a full range of externally mounted surge suppression solutions. These units are designed to provide surge suppression from service entrance panels to point-of-use equipment. Complies with requirements of US and Canadian UL® Listed to the UL 1449 standard. Complies with requirements of NEC® Article 285 and CSA 22.2 No. 8-M1986 as appropriate. Complies with UL 96A 12th Edition Master Label requirements for Lightning Protection Systems.



EMA Series SPDs



Remote Monitor

- 10 year product warranty
- 10 modes of protection
- 200 kA SCCR
- EMI/RFI filtering
- Audible alarm with enable/disable switch, dry contacts and surge counter standard
- Indicator LEDs; normal (green) and fault condition (red) for each phase
- UL 1449 Type 1 to be used in both Type 1 and Type 2 applications
- **Standard.** UL 1449 Type 1 SPDs can be located at any point in the electrical system, on the line or load side of the equipment overcurrent device.
- **Remote Monitor.** This option displays the alarm status of the surge protective device up to 1000 feet from the unit.

## SurgeLogic™ Type EMA Series SPD

EMA SPD products feature a design based on replaceable modules for a flexible, cost effective way to achieve superior surge suppression at every level of the electrical distribution system. Modularity results in lower life cycle costs and fast, easy service or replacement.

### EMA SPD Options:

- **Enhanced Filtering Module.** Sine wave tracking circuitry provides enhanced EMI/RFI filtering of -54 dB at 100 kHz and establishes the power surge clamping window relative to the sine wave voltage to increase performance at distribution and branch panel applications.
- **Disconnect Switch.** The integral switch provides a mechanical means to electrically isolate the entire surge suppressor before opening the enclosure door to facilitate servicing of the unit's components.

### External Modular Options ( )

(D) [1]	Disconnect Switch
(F)	Enhanced Filtering Module (not applicable for Delta, HRG or HLD)
(DF) [1]	Disconnect Switch and Enhanced Filtering Module (not applicable for Delta, HRG or HLD)

Accessory Description	Cat. No.
Remote Monitor	TVS12RMU

Table 6.1: EMA SPDs

Service Voltage	Peak Surge Current Rating per Phase (kA)	NEMA 1 Cat. No.	NEMA 4X Stainless Steel Cat. No.
120/240 V, 1-phase, 3-wire + ground [2]	120	SSP01EMA12( )	SSP01EMA12S( )
	160	SSP01EMA16( )	SSP01EMA16S( )
	240	SSP01EMA24( )	SSP01EMA24S( )
	320	SSP01EMA32( )	SSP01EMA32S( )
	480	SSP01EMA48( )	SSP01EMA48S( )
208Y/120 V, 3-phase, 4-wire + ground [3] [4] [2] Wye	120	SSP02EMA12( )	SSP02EMA12S( )
	160	SSP02EMA16( )	SSP02EMA16S( )
	240	SSP02EMA24( )	SSP02EMA24S( )
	320	SSP02EMA32( )	SSP02EMA32S( )
	480	SSP02EMA48( )	SSP02EMA48S( )
240/120 V, 3-phase, 4-wire + ground [2] High-leg Delta	120	SSP03EMA12( )	SSP03EMA12S( )
	160	SSP03EMA16( )	SSP03EMA16S( )
	240	SSP03EMA24( )	SSP03EMA24S( )
	320	SSP03EMA32( )	—
	480	SSP03EMA48( )	—
240 V, 3-phase, 3-wire + ground Delta	100	SSP06EMA10( )	SSP06EMA10S( )
	120	SSP06EMA12( )	SSP06EMA12S( )
	160	SSP06EMA16( )	SSP06EMA16S( )
	200	SSP06EMA20( )	SSP06EMA20S( )
	240	SSP06EMA24( )	SSP06EMA24S( )
	320	SSP06EMA32( )	SSP06EMA32S( )
480	SSP06EMA48( )	SSP06EMA48S( )	
480Y/277 V, 3-phase, 4-wire + ground [4] [5] [2] Wye	120	SSP04EMA12( )	SSP04EMA12S( )
	160	SSP04EMA16( )	SSP04EMA16S( )
	240	SSP04EMA24( )	SSP04EMA24S( )
	320	SSP04EMA32( )	SSP04EMA32S( )
	480	SSP04EMA48( )	SSP04EMA48S( )
480 V, 3-phase, 3-wire + ground [6] Delta	100	SSP05EMA10( )	SSP05EMA10S( )
	120	SSP05EMA12( )	SSP05EMA12S( )
	160	SSP05EMA16( )	SSP05EMA16S( )
	200	SSP05EMA20( )	SSP05EMA20S( )
	240	SSP05EMA24( )	SSP05EMA24S( )
320	SSP05EMA32( )	SSP05EMA32S( )	
480	SSP05EMA48( )	SSP05EMA48S( )	
600Y/347 V, 3-phase, 4-wire + ground, [2] [4] WYE	120	SSP08EMA12( )	SSP08EMA12S( )
	160	SSP08EMA16( )	SSP08EMA16S( )
	240	SSP08EMA24( )	SSP08EMA24S( )
	320	SSP08EMA32( )	SSP08EMA32S( )
480	SSP08EMA48( )	SSP08EMA48S( )	
600 V, 3-phase, 3-wire + ground [7] Delta	100	SSP09EMA10( )	SSP09EMA10S( )
	120	SSP09EMA12( )	SSP09EMA12S( )
	160	SSP09EMA16( )	SSP09EMA16S( )
	180	SSP09EMA18( )	SSP09EMA18S( )
	240	SSP09EMA24( )	SSP09EMA24S( )
	320	SSP09EMA32( )	SSP09EMA32S( )

[1] Not available in stainless steel for 320 and 480 kA.

[2] Do not use on ungrounded systems. Systems must be solidly grounded.

[3] 208Y/120 series also applies to the following voltage 220Y/127.

[4] Can be used on 4-wire or 3-wire grounded wye systems with or without neutral.

[5] 480Y/277 series applies to the following voltages 380Y/220, 400Y/230, and 415Y/240.

[6] 480 V Delta series also applies to the following voltage 480Y/277V HRG.

[7] 600 V Delta series also applies to the following voltage 600Y/347V HRG.

**SurgeLogic™ MA Replacement Modules**

All module assemblies are US and Canadian UL® Recognized to UL 1449 standards.

Complies with requirements of NEC® Article 285 and CSA C22.2 No. 8-M1986 as appropriate.



MA Replacement Module

**Table 6.2: MA Replacement Modules**

System Voltage	Peak Surge Current Rating (kA)	Catalog Numbers [8]		
		Phase A	Phase B	Phase C
120/240 V, 1-phase, 3-wire + ground	120	MA11MA12	—	MA11MA12
	160	MA11MA16	—	MA11MA16
	240	MA11MA24	—	MA11MA24
208Y/120 V, 3-phase, 4-wire + ground [9] Wye	120	MA11MA12	MA11MA12	MA11MA12
	160	MA11MA16	MA11MA16	MA11MA16
	240	MA11MA24	MA11MA24	MA11MA24
240/120 V, 3-phase, 4-wire + ground [10] High-Leg Delta	120	MA11MA12	MA31MA12	MA11MA12
	160	MA11MA16	MA31MA16	MA11MA16
	240	MA11MA24	MA31MA24	MA11MA24
240 V, 3-phase, 3-wire + ground Delta	100	MA61MA10	MA61MA10	MA61MA10
	120	MA61MA12	MA61MA12	MA61MA12
	160	MA61MA16	MA61MA16	MA61MA16
	200	MA61MA20	MA61MA20	MA61MA20
	240	MA61MA24	MA61MA24	MA61MA24
480Y/277 V, 3-phase, 4-wire + ground [11] Wye	120	MA41MA12	MA41MA12	MA41MA12
	160	MA41MA16	MA41MA16	MA41MA16
	240	MA41MA24	MA41MA24	MA41MA24
480 V, 3-phase, 3-wire + ground [12] Delta	100	MA51MA10	MA51MA10	MA51MA10
	120	MA51MA12	MA51MA12	MA51MA12
	160	MA51MA16	MA51MA16	MA51MA16
	200	MA51MA20	MA51MA20	MA51MA20
	240	MA51MA24	MA51MA24	MA51MA24
600Y/347 V, 3-phase, 4-wire + ground Wye	120	MA81MA12	MA81MA12	MA81MA12
	160	MA81MA16	MA81MA16	MA81MA16
	240	MA81MA24	MA81MA24	MA81MA24
600 V, 3-phase, 3-wire + ground [13] Delta	100	MA91MA10	MA91MA10	MA91MA10
	120	MA91MA12	MA91MA12	MA91MA12
	160	MA91MA16	MA91MA16	MA91MA16
	180	MA91MA18	MA91MA18	MA91MA18

[8] For UL 1449 Type 1 Modules, add suffix (1). Example: MA11MA121  
 [9] 208Y/120 series also applies to the following voltage 220Y/127.  
 [10] High-leg delta (Phase B modules are different than Phase A and Phase C modules).  
 [11] 480Y/277 series applies to the following voltages 380Y/220, 400Y/230, and 415Y/240.  
 [12] 480 V Delta series also applies to the following voltage 480Y/277V HRG.  
 [13] 600 V Delta series also applies to the following voltage 600Y/347V HRG.



Refer to Catalog **6671CT9701**

**Internally Mounted Surge Protective Devices  
SurgeLogic™ Type IMA**

Internally mounted surge protective devices are installed integrally to systems for service entrance and branch panel surge suppression. Internally mounted SPDs installed next to the supply bus provide maximum performance inside Square D™ systems. Built-in performance is the best way to ensure cost effective power quality and continuous operation (especially important for critical power facilities).

US and Canadian UL® Recognized as a Type 2 (or 1 with optional suffix in catalog number) SPD Component Assembly to UL 1449 and UL 1283 standards. Complies with requirements of NEC® Article 285 and CSA C22.2 No. 8-M1986 as appropriate. Complies with UL 96A 12th Edition Master Label requirements for Lightning Protection Systems.

**Internally Mounted—New Construction / Factory Assembled**

Factory installed integral/internal SurgeLogic™ SPD products make adding surge suppression to new construction projects easy. Refer to the sections listed below to identify the correct product for your application or contact SurgeLogic™ TAG at 1-800-577-7353 for assistance.

Panelboards  
Refer to Section 9



NF

NQ

Switchboards and Switchgear  
Refer to Section 11



PZ4

QED

Motor Control  
Centers  
Refer to Section 17



MCC

Integrated Power and  
Control Centers  
Refer to Section 10



IPAC2



I-Line™ SurgeLogic™ SPD Unit



QMB SurgeLogic™ SPD Unit



Busway SurgeLogic™ SPD Unit



MCC SurgeLogic™ SPD Unit

**Internally Mounted—Retrofit/Ready to Install**

To ensure high-performance surge suppression at critical power locations, a variety of SurgeLogic™ products have been designed specifically for retrofitting into commonly used Square D™ systems. The QMB fusible switch, 6 in. MCC bucket, I-Line & Busway plug-on units and the SurgeLoc for the NQ panelboards come ready to install. Retrofitting SPD units into I-Line, QMB, MCC, Busway and NQ Panelboard applications is simple.

- Audible alarm with enable/disable switch, dry contacts and surge counter standard
- 200 kA SCCR
- Indicator LEDs
- EMI/RFI filtering

**Table 6.3: Internally Mounted—Retrofit / Ready To Install**

Voltage	Surge Current Rating	I-Line Branch Units [1]		QMB Branch Units [2]	Busway Units	Model 6 MCC Units [3]
		Cat. No.	Cat. No.	Cat. No.	Cat. No. [4]	Cat. No. [4]
120/240 V, 1-phase, 3-wire + ground	120 kA	HL1IMA12C()	HR1IMA12C()	QMB1IMA12	—	—
	160 kA	HL1IMA16C()	HR1IMA16C()	QMB1IMA16	—	—
	240 kA	HL1IMA24C()	HR1IMA24C()	QMB1IMA24	—	—
208Y/120 V, 3-phase, 4-wire + ground [5] [6] Wye	120 kA	HL2IMA12C()	HR2IMA12C()	QMB2IMA12	—	MCC2IMA12
	160 kA	HL2IMA16C()	HR2IMA16C()	QMB2IMA16	PIU2IMA16	MCC2IMA16
	240 kA	HL2IMA24C()	HR2IMA24C()	QMB2IMA24	PIU2IMA24	MCC2IMA24
240/120 V, 3-phase, 4-wire + ground High-leg Delta	120 kA	HL3IMA12C()	HR3IMA12C()	QMB3IMA12	—	MCC3IMA12
	160 kA	HL3IMA16C()	HR3IMA16C()	QMB3IMA16	PIU3IMA16	MCC3IMA16
	240 kA	HL3IMA24C()	HR3IMA24C()	QMB3IMA24	PIU3IMA24	MCC3IMA24
240 V, 3-phase, 3-wire + ground, Delta	120 kA	HL6IMA12C()	HR6IMA12C()	—	—	—
	160 kA	HL6IMA16C()	HR6IMA16C()	—	—	—
	240 kA	HL6IMA24C()	HR6IMA24C()	—	—	—
480Y/277 V, 3-phase, 4-wire + ground [5] [7] Wye	120 kA	HL4IMA12C()	HR4IMA12C()	QMB4IMA12	—	MCC4IMA12
	160 kA	HL4IMA16C()	HR4IMA16C()	QMB4IMA16	PIU4IMA16	MCC4IMA16
	240 kA	HL4IMA24C()	HR4IMA24C()	QMB4IMA24	PIU4IMA24	MCC4IMA24
480 V, 3-phase, 3-wire + ground, Delta [8]	120 kA	HL5IMA12C()	HR5IMA12C()	—	—	—
	160 kA	HL5IMA16C()	HR5IMA16C()	—	—	—
	240 kA	HL5IMA24C()	HR5IMA24C()	—	—	—
600Y/347 V, 3-phase, 4-wire + ground [5] Wye	120 kA	—	HR8IMA12C()	QMB8IMA12	—	MCC8IMA12
	160 kA	—	HR8IMA16C()	QMB8IMA16	PIU8IMA16	MCC8IMA16
	240 kA	—	HR8IMA24C()	QMB8IMA24	PIU8IMA24	MCC8IMA24
600V, 3-phase, 3-wire + ground, [9] Delta	120 kA	—	HR9IMA12C()	—	—	—
	160 kA	—	HR9IMA16C()	—	—	—
	180 kA	—	HR9IMA18C()	—	—	—

( ) For a Type 1 SPD, add a "1" suffix to the catalog number.

[1] Requires 13.5-inch mounting height.  
 [2] Requires 9-inch mounting height.  
 [3] Requires 6-inch mounting height.  
 [4] PE7 Discount Schedule.  
 [5] Can be used on 4-wire or 3-wire grounded wye systems with or without neutral.  
 [6] 208Y/120 series also applies to the following voltage 220Y/127.  
 [7] 480Y/277 series applies to the following voltages 380Y/220, 400Y/230, and 415Y/240.  
 [8] 480 V Delta series also applies to the following voltage: 480Y/277V HRG.  
 [9] 600 V Delta series also applies to the following voltage: 600Y/347V HRG.

Refer to Catalog 6671CT9701



SurgeLogic™ SurgeLoc

### SurgeLogic™ SurgeLoc for NQ Panelboards

SurgeLogic™ SurgeLoc is the industry's first Field Installable Internally Mounted SPD in NQ panelboards - fully installed in approximately 2 minutes. SurgeLogic (TM) SurgeLoc can be ordered as factory assembled in NQ Panelboards or can be ordered from your local Schneider Electric distributor for retrofit opportunities for NQ panelboards.

US and Canadian UL® Recognized to UL 1449 and UL 1283 standards. Complies with requirements of NEC® Article 285 and CSA 22.2 No. 8-M1986 as appropriate. Complies with UL 96A 12th Edition Master Label requirements for Lightning Protection Systems.

- Retrofit into existing NQ Panelboards
- 10 year product warranty
- 10 modes of protection
- 200 kA SCCR
- Audible alarm with enable/disable switch, dry contacts and surge counter standard
- Indicator LEDs; normal (green) and fault condition (red) for each phase

**\*\* FOR SURGELOC PART NUMBERS, PLEASE REFERENCE Table 6.4 Internally Mounted—Retrofit / Ready to Install, page 6-6.**

**Table 6.4: Internally Mounted—Retrofit / Ready to Install**

Voltage	Surge Current Rating	NQ Panelboard Units—SurgLoc [10]
		Cat. No.
120/240 V, 1-phase, 3-wire + ground	80 kA	SSP01SBA08D
	100 kA	SSP01SBA10D
	120 kA	SSP01SBA12D
	160 kA	SSP01SBA16D
	200 kA	SSP01SBA20D
	240 kA	SSP01SBA24D
208Y/120 V, 3-phase, 4-wire + ground [11] [12] Wye	80 kA	SSP02SBA08D
	100 kA	SSP02SBA10D
	120 kA	SSP02SBA12D
	160 kA	SSP02SBA16D
	200 kA	SSP02SBA20D
	240 kA	SSP02SBA24D
240Y/120 V, 3-phase, 4-wire + ground High-leg Delta	240 kA	SSP03SBA24D [13]

[10] Requires 12 circuit positions (6 adjacent mounting spaces per side).

[11] Can be used on 4-wire or 3-wire grounded neutral system.

[12] 208/120 series also applies to the following voltage 220Y/127.

[13] SSP03SBA24D will be available late 2021.

**OEM/Assembler Kits**

SurgeLogic™ OEM/assembler kits allow manufacturers to add industry-leading surge suppression directly to customized equipment. Manufacturers benefit from shorter wire lengths that optimize the clamping voltage of the SPD. Products come with a backplane-mounted SPD, mounting hardware and diagnostic display with 36-inch cables. Audible alarm, silence switch, remote monitoring contacts, and surge counter are standard. Available as UL 1449 Type 2 (or 1 with optional suffix in catalog number).

US and Canadian UL® Recognized to UL 1449 and UL 1283 standards. Complies with requirements of NEC® Article 285 and CSA 22.2 No. 8-M1986 as appropriate. Complies with UL 96A 12th Edition Master Label requirements for Lightning Protection Systems.



OEM Kit

**Table 6.5: OEM/Assembler Kits**

Service Voltage	Peak Surge Current Rating per Phase (kA)	Cat. No. [14]
120/240 V, 1-phase, 3-wire + ground	120	TVS1IMA12O()
	160	TVS1IMA16O()
	240	TVS1IMA24O()
208Y/120 V, 3-phase, 4-wire + ground [15] [16] Wye	120	TVS2IMA12O()
	160	TVS2IMA16O()
	240	TVS2IMA24O()
240/120 V, 3-phase, 4-wire + ground High-leg Delta	120	TVS3IMA12O()
	160	TVS3IMA16O()
	240	TVS3IMA24O()
240 V, 3-phase, 3-wire + ground [15] [17] Delta	120	TVS6IMA12O()
	160	TVS6IMA16O()
	240	TVS6IMA24O()
480Y/277 V, 3-phase, 4-wire + ground [15] [17] Wye	120	TVS4IMA12O()
	160	TVS4IMA16O()
	240	TVS4IMA24O()
480 V, 3-phase, 3-wire + ground [18] Delta	120	TVS5IMA12O()
	160	TVS5IMA16O()
	240	TVS5IMA24O()
600Y/347 V, 3-phase, 4-wire + ground [15] Wye	120	TVS8IMA12O()
	160	TVS8IMA16O()
	240	TVS8IMA24O()
600 V, 3-phase, 3-wire + ground [19] Delta	120	TVS9IMA12O()
	160	TVS9IMA16O()
	180	TVS9IMA18O()

( ) For a Type 1 SPD, add a "1" suffix to the catalog number.

[14] Note the last character of the catalog number is the letter "O", not a zero.  
 [15] Can be used on 4-wire or 3-wire grounded wye systems with or without neutral.  
 [16] 208Y/120 series also applies to the following voltage 220Y/127.  
 [17] 480Y/277 series applies to the following voltages 380Y/220, 400Y/230, and 415Y/240.  
 [18] 480 V Delta series also applies to the following voltage: 480Y/277V HRG.  
 [19] 600 V Delta series also applies to the following voltage: 600Y/347V HRG.

New!

### SurgeLogic™ Type XDSE Surge Protective Devices

SurgeLogic™ XDSE surge protective devices feature a compact design that allows surge suppression to be externally installed adjacent to electrical distribution equipment. XDSE systems are designed to provide high-quality surge suppression for a wide variety of commercial, industrial or institutional applications. XDSEs incorporate patented overvoltage technology innovations that provide superior overvoltage withstand capability for systems with unstable power, without compromising transient clamping performance.

US and Canadian UL Listed to the UL 1449 standard. Complies with requirements of NEC Article 285 and CSA 22.2 269.1 and 269.2 as appropriate. Complies with UL 96A 12<sup>th</sup> Edition Master Label requirements for Lightning Protection Systems



XDSE Series

- LED light indicates operation status
- Short circuit current rating up to 200 kA
- Suitable for indoor and outdoor applications (NEMA Type 4X rated)
- Convenient lug connection inside enclosure
- -50db EMI/RFI filtering
- Audible alarm
- Dry contacts
- Optional flush mount kit: XDSEMKF

**Table 6.6: XDSE Surge Protective Devices**

Voltage	Surge Current per Phase	Modes of Protection	Configuration	Model Number	MCOV	I <sub>n</sub>	L-N	L-G	L-L	N-G
120/240V	100	6	1Ø, 3-wire + ground	SSP01XDSE10A()	150V	20 kA	700V	700V	600V	1000V
208Y/120V [1]	100	10	3Ø, WYE, 4-wire + ground	SSP02XDSE10A()	150V	20 kA	700V	700V	600V	1000V
240/120 HLD	100	10	3Ø, HLD[2], 4-wire + ground	SSP03XDSE10A()	150/320V	20 kA	700/1200V	700V	600V	1000/2000V
480Y/277V [3]	100	10	3Ø, Wye, 4-wire + ground	SSP04XDSE10A()	320V	20 kA	1200V	1200V	1200V	2000V
480V Delta [4]	100	6	3Ø, Delta, 3-wire + ground	SSP05XDSE10A()	552V	20 kA	N/A	1800V	N/A	2000V
240V Delta	100	6	3Ø, Delta, 3-wire + ground	SSP06XDSE10A()	300/320V	20 kA	N/A	320 V	300 V	N/A
600Y/347V	100	10	3Ø, WYE, 4-wire + ground	SSP08XDSE10A()	420V	20 kA	1500V	1500V	1500V	2500V
600V Delta [5]	100	6	1Ø, 3-wire + ground	SSP09XDSE10A()	690V	20 kA	N/A	2500V	2500V	N/A
120/240 V	150	6	1Ø, 3-wire + ground	SSP01XDSE15A()	150V	20 kA	700V	700V	600V	1000V
208Y/120V [1]	150	10	3Ø, WYE, 4-wire + ground	SSP02XDSE15A()	150V	20 kA	700V	700V	600V	1000V
120/240V HLD	150	10	3Ø, HLD[2], 4-wire + ground	SSP03XDSE15A()	150/320V	20 kA	700/1200V	700/1200V	600V	1000/2000V
480Y/277V [3]	150	10	3Ø, WYE, 4-wire + ground	SSP04XDSE15A()	320V	20 kA	1200V	1200V	1200V	2000V
480V Delta [4]	150	6	3Ø, Delta, 3-wire + ground	SSP05XDSE15A()	552V	20 kA	N/A	1800V	N/A	2000V
240V Delta	150	6	3Ø, Delta, 3-wire + ground	SSP06XDSE15A()	300/320V	20 kA	N/A	320V	300V	N/A
600Y/347V	150	10	3Ø, WYE, 4-wire + ground	SSP08XDSE15A()	420V	20 kA	1500V	1500V	1500V	2500V
120/240V	200	6	1Ø, 3-wire + ground	SSP01XDSE20A()	150V	20 kA	700V	700V	600V	1000V
208Y/120V [1]	200	10	3Ø, WYE, 4-wire + ground	SSP02XDSE20A()	150V	20 kA	700V	700V	600V	1000V
240/120 HLD	200	10	3Ø, HLD[2], 4-wire + ground	SSP03XDSE20A()	150/320V	20 kA	700/1200V	700V	600V	1000/2000V
480Y/277V [3]	200	10	3Ø, Wye, 4-wire + ground	SSP04XDSE20A()	320 V	20 kA	1200V	1200 V	1200V	2000 V
480V Delta [4]	200	6	3Ø, Delta, 3-wire + ground	SSP05XDSE20A()	552V	20 kA	N/A	1800V	N/A	2000V
240V Delta	200	6	3Ø, Delta, 3-wire + ground	SSP06XDSE20A()	300/320V	20 kA	N/A	320V	300V	N/A
600Y/347V	200	10	3Ø, WYE, 4-wire + ground	SSP08XDSE20A()	420V	20 kA	1500V	1500V	1500V	2500V

( ) For a Type 1 SPD, add a "1" suffix to the catalog number.

6

 SURGE PROTECTIVE DEVICES  
 (SPDS) AND EASY UPS 3S

[1] 208Y/120 series also applies to the following voltage 220Y/127.

[2] HLD= High-leg delta.

[3] 480Y/277 series also applies to the following voltages 380Y/220, 400Y/230, and 415Y/240.

[4] 480V Delta series also applies to the following voltage 480Y/277V HRG.

[5] 600 V Delta series also applies to the following voltages 600Y/347V HRG.



HWA Series

**SurgeLogic™ HWA Surge Protective Devices**

SurgeLogic™ HWA surge protective devices are compact, nipple-mounted parallel-connected surge suppressors that come in a variety of voltage configurations, including Delta. A surge suppression path is provided for each mode, and the product is rated NEMA Type 4X. Internal diagnostics continuously monitor the device status.

US and Canadian UL® Listed as a Type 2 SPD to UL 1449 and UL 1283 standards. Complies with requirements of NEC® Article 285 and CSA C22.2 No. 8-M1986 as appropriate. Complies with UL 96A 12th Edition Master Label requirements for Lightning Protection Systems.

- LEDs indicate operational status
- Short circuit current rating 200 kA
- Suitable for indoor and outdoor applications (NEMA Type 4X rated)
- Convenient side-nipple mounting
- Compact design provides easy mounting inside or outside the equipment cabinets
- -54 dB EMI/RFI filtering
- Sine wave tracking
- Audible alarm indicates loss of suppression (does not contain alarm enable/disable switch)
- Dry contacts
- Optional flush mount kit TVSHWAFMK

**Table 6.7: HWA Surge Protective Devices**

Service Voltage	Peak Surge Current Rating per Phase (kA)	NEMA 4X Cat. No.
120/240 V, 1-phase, 3-wire + ground [6]	50	TVS1HWA50X
	80	TVS1HWA80X
	100	TVS1HWA10X
208Y/120 V, 3-phase, 4-wire + ground [7] [8] [6]	50	TVS2HWA50X
	80	TVS2HWA80X
	100	TVS2HWA10X
240/120 V, 3-phase, 4-wire + ground [6] High-leg Delta	50	TVS3HWA50X
	80	TVS3HWA80X
	100	TVS3HWA10X
240 V, 3-phase, 3-wire + ground Delta	50	TVS6HWA50X
	80	TVS6HWA80X
	100	TVS6HWA10X
480Y/277 V, 3-phase, 4-wire + ground [7] [9] [6]	50	TVS4HWA50X
	80	TVS4HWA80X
	100	TVS4HWA10X
480 V, 3-phase, 3-wire + ground Delta	50	TVS5HWA50X
	80	TVS5HWA80X
	100	TVS5HWA10X
600Y/347 V, 3-phase, 4-wire + ground [6]	50	TVS8HWA50X
	80	TVS8HWA80X
	100	TVS8HWA10X
600 V, 3-phase, 3-wire + ground Delta	50	TVS9HWA50X
	80	TVS9HWA80X
	100	TVS9HWA10X

**SurgeLogic™ XR Surge Protective Devices**

The SurgeLogic™ Type XR surge protective device provides high-quality surge suppression in a compact and versatile package. This product is ideal for panel builders as well as manufacturers and integrators of instrumentation cabinets for industrial and commercial applications for single-phase power systems.

US and Canadian UL® Listed as Type 1 SPD to the UL 1449 standard. Complies with requirements of NEC® Article 285, CSA 233.1-87, and CSA C22.2 No. 8-M1986 as appropriate.

- LEDs indicate operational status
- Short circuit current rating 25 kA
- Convenient side nipple mounting
- Suitable for indoor and outdoor applications (NEMA Type 4X rated)
- Optional flush mount kit TVSXRFMK



XR Series

**Table 6.8: XR Nipple-Mounted Surge Protective Devices**

System Voltage	Peak Surge Current Rating per Phase (kA)	Cat. No.
120/240 V, 1-phase, 3-wire + ground	50	TVS120XR50S
	80	TVS120XR80S

[6] Do not use on ungrounded systems. Systems must be solidly grounded.  
 [7] Can be used on 4-wire or 3-wire grounded wye systems with or without neutral.  
 [8] 208Y/120 series also applies to the following voltage 220Y/127.  
 [9] 480Y/277 series applies to the following voltages 380Y/220, 400Y/230, and 415Y/240.



SDSA1175



SDSA 3-Phase

## SDSA1175 and SDSA 3-Phase Surge Protective Devices

SurgeLogic™ SDSA1175 surge protective devices are designed and listed for indoor or outdoor installation and surge suppression for single-phase three-wire 120/240 Vac or two-wire 120 Vac 60 Hz electrical services. This product is ideal for panel builders as well as manufacturers and integrators of instrumentation cabinets for industrial and commercial applications for single-phase power systems. Two SDSA1175 surge protection devices can be installed to provide suppression for 208Y/120 Vac three-phase four-wire services.

SurgeLogic™ SDSA 3-Phase surge protective devices are designed and listed for indoor or outdoor installation and surge suppression for three-phase electrical services up to 600 Vac. The SDSA 3-Phase series is used extensively in service entrance panels to provide an efficient and economical means of surge suppression and also ideal for point of use applications for that added level of protection.

US and Canadian UL® Listed as Type 1 SPD to the UL 1449 standard. Complies with requirements of NEC® Article 285, CSA 233.1-87, and CSA C22.2 No. 8-M1986 as appropriate.

- LED indicates operational status
- Short circuit current rating 25 kA (SDSA1175), 200 kA (SDSA 3-Phase)
- Suitable for indoor and outdoor applications (NEMA Type 4X rated)
- Convenient back-nipple mounting
- Optional mounting bracket QOSAMK (for SDSA1175/SDSA1175T)

**Table 6.9: SDSA1175 and SDSA 3-Phase Surge Protective Devices**

System Voltage	Peak Surge Current Rating per Phase (kA)	Cat. No.
<b>SDSA1175</b>		
120/240 V, 1-phase, 3-wire	36	SDSA1175
120 V, 1-phase, 2-wire	36	SDSA1175T
<b>SDSA 3-Phase</b>		
208Y/120 V, 3-phase, 4-wire [10] [11]	40	SDSA2040
240 V Delta, 3-phase, 3-wire [12]	40	SDSA2040D
480Y/277 V, 3-phase, 4-wire [13] [10]	40	SDSA4040
480 V Delta, 3-phase, 3-wire	40	SDSA4040D
600Y/347 V, 3-phase, 4-wire [10]	40	SDSA3650
600 V Delta, 3-phase, 3-wire	40	SDSA3650D

[10] Do not use on ungrounded systems. Systems must be solidly grounded.

[11] Applicable voltages: 220Y/127V, 208Y/120V.

[12] Applicable voltages: 240V Delta, 240/120V High-Leg Delta.

[13] Applicable voltages: 480Y/277V, 415Y/240V, 400Y/230V, 380Y/220V.



SDSB80111

**Surgebreaker Plus Whole House Surge Protective Device**

The Surgebreaker Plus Whole House device is designed to deliver surge suppression that addresses the entire home. AC modules are connected to the circuit breaker load center and provide suppression for all equipment connected to the power system. This Whole House system incorporates AC modules as well as modules for other metallic lines coming into the home including telephone/DSL and coaxial video/data.

US and Canadian UL® Listed as Type 2 SPD to the UL 1449 standard. Complies with requirements of NEC® Article 285, CSA 233.1-87, and CSA C22.2 No. 8-M1986 as appropriate. Telephone and coaxial video modules US and Canadian UL® Recognized to UL 497A 4th Edition and UL 497B 4th Edition.

- 120/240 Vac, 80 kA/phase AC surge suppression
- LED status indicators for AC surge suppression
- Telephone surge suppression module supports one RJ45 cable up to four lines.
- Coaxial surge suppression module supports one line of video/data
- Network suppression module supports one RJ45 modem/fax/DSL

**Table 6.10: Whole House Surge Protective Devices**

Description	Included Modules	Cat. No.
Whole House NEMA 1	AC, Telephone, Coax, Network	SDSB80111

**Table 6.11: SDSB80111 Replacement Modules**

Description	Cat. No.
Telephone Suppression Module	PTEL2R
Video Suppression Module	PVR
Network Suppression Module	PNETR6
Home Electronics Protective Device	HEPD80

\*\* To purchase Telephone, Video or Network Replacement Modules - go online to: <http://www.apc.com/products/family/index.cfm?id=219>

**Surgebreaker Plus Whole House Accessories**

Add additional surge suppression or replace existing modules in Whole House products.

**Coaxial, telephone and network modules:** US and Canadian UL® Recognized to UL 497A 4th Edition and UL 497B 4th Edition.



HEPD50



HEPD80



HEPD58MKF



## Whole Home Surge Protection

HEPD Whole House devices are designed to deliver superior AC surge protection for the entire AC power system in a home. HEPDs are compact in size and are designed to protect AC wires in the home from surges that could affect home electronics and appliances not connected to surge strips.

cULus Listed to the latest UL 1449 standard, UL Type 1 SPD, CSA C22.2 No. \*-M1986, C233.1-87.

- 120/240 Vac
- Max surge current ratings available: 50 and 80 kA
- NEMA 4X rate for indoor or outdoor applications
- LED status indicators
- Compatible with all brands of load centers
- Flush Mount Kit sold separately - see table below
- HEPD50: 3 year/\$50,000 connected equipment warranty
- HEPD80: 5 year/\$75,000 connected equipment warranty

**Table 6.12: HEPD Whole House Surge Protective Devices**

Description	Surge Current Rating	Cat. No.
50kA Home Electronic Protective Device	50 kA	HEPD50
80kA Home Electronic Protective Device	80 kA	HEPD80
Flush Mount Kit for HEPD50/HEPD80		HEPD58MKF

## Plug-on Neutral QO™ and Homeline™ Load Center Surge Protective Devices

The industry's first exclusive Plug on Neutral (PoN) Surge Protective Device (SPD). Square D™ load center PoN SPDs are a simple and quick installation. It's as easy as snap, click, done! PoN SPDs are easier to install than a standard circuit breaker. No wires are needed for installation. The PoN SPD simply plugs on to the bus and neutral bar. The surge suppressors use two-pole spaces in a QO™ or Homeline™ load center.

US and Canadian UL® Listed as Type 2 SPD to the UL 1449 standard. Complies with requirements of NEC® Article 285, CSA 233.1-87, and CSA C22.2 No. 8-M1986 as appropriate.



QO250PSPD



HOM250PSPD

- Industry First: No wires or tools required for installation
- Installation Flexibility: Works on Plug-on Neutral design QO or HOM loadcenters using two-pole spaces
- Whole House Protection: 50 kA surge current capacity per phase
- LED indicates operational status
- Peace of mind: 5 year/ \$50,000 connected equipment warranty

**Table 6.13: QO™, NQ, and Homeline™ Load Center Surge Protective Device**

Description	Cat. No.
Plug on Neutral QO™ Surgebreaker	QO250PSPD
Plug on Neutral Homeline™ Surgebreaker	HOM250PSPD

## QO™, NQ, and Homeline™ Load Center Surge Protective Devices

Square D™ load center surge protective devices are easy to install plug-in units that install as quickly as a standard circuit breaker. The surge suppressors use two pole spaces in a QO™ or Homeline™ load center, or NQ panelboard.

US and Canadian UL® Listed as Type 2 SPD to the UL 1449 standard. Complies with requirements of NEC® Article 285, CSA 233.1-87, and CSA C22.2 No. 8-M1986 as appropriate.



QO217SB



HOM217SB

- QO2175SB for QO™ load centers, combination devices, and NQ panelboards
- HOM2175SB for Homeline™ load centers and combination devices
- Requires two pole spaces
- LED indicates operational status
- 22.5 kA per phase

**Table 6.14: QO™, NQ, and Homeline™ Load Center Surge Protective Devices**

Description	Cat. No.
QO™ Surgebreaker for QO and NQ	QO2175SB
Homeline™ Surgebreaker	HOM2175SB

### Square D™ Easy UPS 3S (UL 208 V)

The Square D Easy UPS 3S is an easy-to-install, easy-to-use and easy-to-service 10-40 kVA 3-phase 208 V UPS ideal for non-IT applications. Easy UPS 3S combines power stability with robust electrical specifications and long-lasting performance to ensure your business continuity.



UPS



Battery String



Modular Battery Cabinet

- US listed to the UL 1778 standard
- Complies with the requirements of CSA C22.2 No. 107.3-14 + G11
- IP20 rated
- Optimize efficiency
  - Double Conversion Mode (up to 94%)
  - ECO Mode (98% efficiency)
- 1.0 power factor kVA = kW
- Parallel up to 4 units for 10-30 kVA. Parallel 3 units for 40 kVA.
- Robustness against harsh environment
  - Conformal coating on PCBA
  - Replaceable dust filter
  - 60s @ 150% overload, 10 min. @ 125% overload.
  - Operating temperature: 32 - 104°F
- Flexibility for wider application
  - Modular battery cabinet for longer runtime
  - SNMP / Modbus TCP/IP / dry contact for connectivity
  - 5 years lifespan battery module
- Connectivity
  - Startup service included with every UPS
  - EcoStructure™ ready
  - Network management card to remotely monitor and control

**Please Note:** Batteries are not included with the UPS. Use the selection tables below to determine number of batteries.

Using the selection table, choose what percentage of the total kVA will be backed up. Then, choose the runtime.

**Example:** A 20 kVA UPS backing up 75% of its kVA for a runtime of 1 hour will require (1) E3SUPS20KFBS, (1) E3SXR7, and (12) E3SFBTH2. Then, choose accessories if needed.

The maximum number of battery strings that can be installed in a modular battery cabinet (E3SXR7) is 12.



Square D Easy UPS 3S is configurable in SE Advantage. Access via MySE homepage. <https://www.myseus.schneider-electric.com/mySchneider#!/login>

Table 6.15: Selection Table for 10 kVA UPS

Part Number	Measurement	% Load			Battery Strings E3SFBTH2
		50%	75%	100%	
E3SUPS10KFBS + (#) of battery strings needed E3SFBTH2	KW	5	7.5	10	—
	kVA	5	7.5	10	—
	Runtime (Minutes)	10.5	5.8	—	1
		26.5	15.5	10.5	2
E3SUPS10KFBS + 1 modular battery cabinet E3SXR7 + (#) of battery strings needed E3SFBTH2	kVA	44.5	26.5	18	3
		5	7.5	10	—
	Runtime (Minutes)	5	7.5	10	—
		63.5	38.5	26.5	4
		83.5	51	35	5
		100	63.5	44	6
		125	77	53.5	7
		145	90.5	63	8
		170	100	73	9
		190	115	83	10
		215	130	93	11
		240	145	100	12
		265	160	110	13
		285	175	120	14
		300	190	135	15

Table 6.16: Selection Table for 15 kVA UPS

Part Number	Measurement	% Load			Battery Strings E3SFBTH2
		50%	75%	100%	
E3SUPS15KFBS + (#) of battery strings needed E3SFBTH2	KW	7.5	11.25	15	—
	kVA	7.5	11.25	15	—
	Runtime (Minutes)	5.8	—	—	1
		15.5	8.9	5.7	2
		26.5	15.5	10.5	3
E3SUPS15KFBS + 1 modular battery cabinet E3SXR7 + (#) of battery strings needed E3SFBTH2	KW	7.5	11.25	15	—
	kVA	7.5	11.25	15	—
	Runtime (Minutes)	38.5	23	15.5	4
		51	30.5	21	5
		63.5	38.5	26.5	6
		77	46.5	32.5	7
		90.5	55	38	8
		100	63.5	44.5	9
		115	72	50.5	10
		130	81	57	11
		145	90	63.5	12
		160	99.5	70	13
		175	105	76.5	14
		190	115	83	15
		E3SUPS15KFBS + 2 of E3SXR7 + (#) of battery strings needed E3SFBTH2	KW	7.5	11.25
kVA	7.5		11.25	15	—
Runtime (Minutes)	205		125	90	16
	225		135	97	17
	240		145	100	18
	255		155	110	19
	270		165	115	20
	285		175	125	21
	300		185	130	22
	300		195	135	23
	300		205	145	24
	300		215	150	25
	300		225	160	26
	300		235	165	27

Table 6.17: Selection Table for 20 kVA UPS

Part Number	Measurement	% Load			Battery Strings E3SFBTH2
		50%	75%	100%	
E3SUPS20KFBS + (#) of battery strings needed E3SFBTH2	KW	10	15	20	—
	kVA	10	15	20	—
	Runtime (Minutes)	10.5	5.8	—	1
		18.5	10.5	6.9	3
E3SUPS20KFBS + 1 of E3SXR7 + (#) of battery strings needed E3SFBTH2	KW	10	15	20	—
	kVA	10	15	20	—
	Runtime (Minutes)	27	15.5	10.5	4
		36	21	14	5
		45	26.5	18	6
		54.5	32.5	22.5	7
		64.5	38.5	26.5	8
		74.5	44.5	31	9
		84.5	51	35.5	10
		95	57.5	40	11
		105	63.5	44.5	12
		115	70.5	49	13
		125	77	53.5	14
		135	83.5	58.5	15
		E3SUPS20KFBS + 2 of E3SXR7 + (#) of battery strings needed E3SFBTH2	KW	10	15
kVA	10		15	20	—
Runtime (Minutes)	145		90.5	63.5	16
	160		97.5	68.5	17
	170		100	73	18
	180		110	78	19
	195		115	83.5	20
	205		125	88.5	21
	215		130	93.5	22
	230		140	98.5	23
	240		145	100	24
	255		155	105	25
	265		160	110	26
	280		170	120	27

**Table 6.18: Selection Table for 30 kVA UPS**

Part Number	Measurement	% Load			Battery Strings E3SFBTH2	
		50%	75%	100%		
E3SUPS30KFBS + (#) of battery strings needed E3SFBTH2	KW	15	22.5	30	—	
	kVA	15	22.5	30	—	
	Runtime (Minutes)	—	—	—	—	1
		5.9	—	—	—	2
		10.5	5.9	—	—	3
		16	9.1	5.8	—	4
21.5		12.5	8.2	—	5	
27.5	16	10.5	—	6		
E3SUPS30KFBS + 1 of E3SXR7 + (#) of E3SFBTH2 below	KW	15	22.5	30	—	
	kVA	15	22.5	30	—	
	Runtime (Minutes)	33.5	19.5	13	—	7
		39.5	23.5	16	—	8
		45.5	27	18.5	—	9
		52	31	21	—	10
		58.5	35	24	—	11
		65	39	27	—	12
		72	43	30	—	13
		79	47.5	33	—	14
		85.5	51.5	36	—	15
		92.5	56	39	—	16
		100	60.5	42	—	17
		105	64.5	45	—	18
E3SUPS30KFBS + 2 of E3SXR7 + (#) of E3SFBTH2 below	KW	15	22.5	30	—	
	kVA	15	22.5	30	—	
	Runtime (Minutes)	110	69	48	—	19
		120	73.5	51.5	—	20
		125	78	54.5	—	21
		135	82.5	57.5	—	22
		140	87.5	61	—	23
		150	92	64	—	24
		155	96.5	67.5	—	25
		165	100	71	—	26
		170	105	74	—	27
		180	110	77.5	—	28
		190	115	81	—	29
		195	120	84.5	—	30
E3SUPS30KFBS + 3 of E3SXR7 + (#) of E3SFBTH2 below	KW	15	22.5	30	—	
	kVA	15	22.5	30	—	
	Runtime (Minutes)	205	125	88	—	31
		210	130	91.5	—	32
		220	135	95	—	33
		230	140	98.5	—	34
		235	145	100	—	35
		245	150	105	—	36
		250	155	105	—	37
		260	160	110	—	38
		270	165	115	—	39
		275	170	115	—	40
		285	175	120	—	41
		295	180	125	—	42

**Table 6.19: Selection Table for 40 kVA UPS**

Part Number	Measurement	% Load			Battery Strings E3SFBTH2	
		50%	75%	100%		
E3SUPS40KFBS + (#) of battery strings needed E3SFBTH2	KW	20	30	40	—	
	kVA	20	30	40	—	
	Runtime (Minutes)	—	—	—	—	1
		7.2	—	—	—	2
		11	5.9	—	—	3
		15	8.4	5.3	—	4
19		10.5	7.1	—	5	
E3SUPS40KFBS + 1 of E3SXR7 + (#) of battery strings needed E3SFBTH2	KW	20	30	40	—	
	kVA	20	30	40	—	
	Runtime (Minutes)	23	13.5	8.9	—	6
		27.5	16	10.5	—	7
		32	19	12.5	—	8
		36.5	21.5	14.5	—	9
		41	24.5	16.5	—	10
		46	27.5	18.5	—	11
		51	30.5	20.5	—	12
		55.5	33.5	23	—	13
		60.5	36.5	25	—	14
		65.5	39.5	27	—	15
		70.5	42.5	29.5	—	16
		76	45.5	31.5	—	17
E3SUPS40KFBS + 2 of E3SXR7 + (#) of battery strings needed E3SFBTH2	KW	20	30	40	—	
	kVA	20	30	40	—	
	Runtime (Minutes)	81	49	34	—	18
		86	52	36	—	19
		91.5	55.5	38.5	—	20
		97	58.5	40.5	—	21
		100	62	43	—	22
		105	65	45.5	—	23
		110	68.5	48	—	24
		115	72	50	—	25
		120	75.5	52.5	—	26
		125	79	55	—	27
		135	82	57.5	—	28
		140	85.5	60	—	29

Table 6.19 Selection Table for 40 kVA UPS (cont'd.)

Part Number	Measurement	% Load			Battery Strings E3SFBTH2
		50%	75%	100%	
E3SUPS40KFBS + 3 of E3SXR7 + (#) of battery strings needed E3SFBTH2	KW	20	30	40	—
	kVA	20	30	40	—
	Runtime (Minutes)	145	89	62.5	31
		150	92.5	65	32
		155	96	67.5	33
		160	100	70	34
		165	100	72.5	35
		175	105	75	36
		180	110	77.5	37
		185	110	80	38
		190	115	82.5	39
		195	120	85	40
		205	125	88	41
		210	125	90.5	42
E3SUPS40KFBS + 4 of E3SXR7 + (#) of battery strings needed E3SFBTH2	KW	20	30	40	—
	kVA	20	30	40	—
	Runtime (Minutes)	215	130	93	43
		220	135	95.5	44
		225	140	98.5	45
		235	140	100	46
		240	145	100	47
		245	150	105	48
		250	155	105	49
		260	155	110	50
		265	160	110	51
		270	165	115	52
		275	170	120	53
		285	170	120	54

Table 6.20: Accessories

Part Number	Description
E3SBPSU10K20F	Easy UPS 3S Maint Bypass Panel, 10-20 kVA 208 V
E3SBPSU30K40F	Easy UPS 3S Maint Bypass Panel, 30-40 kVA 208 V
E3SBPAR10K40F	Easy UPS Parallel MBP for 3 UPS, 10-40 kVA 208 V
E3SXR7	Easy UPS 3S Modular Battery Cabinet 208 V
E3SFBTH2	Easy UPS 3S High Capacity Battery String 208 V
E3SOPT010	Easy UPS 3S Dry Contact Card
E3SOPT014	Easy UPS 3S Cold Start Kit 15-40 kVA 208 V
E3SOPT015	Easy UPS 3S Kirk Key Kit
E3SOPT001	Easy UPS 3S Series Network Card
E3SOPT002	Easy UPS 3S Parallel Kit



Maint Bypass Panel



Modular Battery Cabinet



Battery String



Dry Contact Card



Cold Start Kit



Kirk Key Kit



Series Network Card



Parallel Kit

# Section 7

## Miniature and Molded Case Circuit Breakers



<b>Selection Information</b>	<b>7-1</b>
<b>QO™ and QOU Miniature Circuit Breakers</b>	<b>7-11</b>
<b>Homeline™ Miniature Circuit Breakers</b>	<b>7-22</b>
<b>Multi 9™ Miniature Circuit Breakers</b>	<b>7-25</b>
<b>PowerPact™ Molded Case Circuit Breakers</b>	<b>7-31</b>
<b>Mission Critical Circuit Breakers</b>	<b>7-44</b>
<b>500 Vdc Circuit Breakers</b>	<b>7-45</b>
<b>Automatic Switches</b>	<b>7-46</b>
<b>Motor Circuit Protectors</b>	<b>7-47</b>
<b>PowerPact™ Circuit Breaker Accessories</b>	<b>7-51</b>
<b>MicroLogic™ Electronic Trip Units</b>	<b>7-61</b>
<b>MasterPact™ Power Circuit Breakers</b>	<b>7-66</b>
<b>Enerlin'X Digital Solutions</b>	<b>7-81</b>
<b>Ground-Fault Protection</b>	<b>7-85</b>
<b>Dimensions and Shipping Weights</b>	<b>7-86</b>
<b>Circuit Breaker Enclosures</b>	<b>7-88</b>

QO Miniature Circuit Breakers

QO™ Circuit Breakers																			
Circuit Breaker Type	Plug-on	QO			QO-H			QO-VH			QH			QOT	QO-CAFI	QO-VHCAFI	QO-AFGF	QOVH-AFGF	
	Bolt-on	QOB			QOB-H			QOB-VH			QHB			QOB-CAFI		QOB-VHCAFI	QOB-AFGF	QOB-VHAFDF	
	Unit Mount	—			—			—			—			—		—		—	
Number of Poles	1	2	3	2	1	2	3	1	2, 3 [1]	1, 2	3	1	1, 2	1, 2	1	1			
Current Range (A)	10-70	10-200 [2]	10-100	15-100	15-70	15-125	15-100	15-70	15-150	15-30	15-30	15-30	15-20	15-20	15-20	15-20			
Interrupting Ratings																			
UL/CSA Rating (kA) (50/60 Hz)	120 Vac	10	10	10	10	22	22	22	22	22	65	65	10	10	22	10	22		
	120/240 Vac	10	10	10	10	22	22	22	22	22	65	65	10	10	22	—	—		
	208Y/120	—	—	—	—	—	—	—	—	—	—	—	—	—	—	—	—		
	240 Vac [3]	—	—	10	10	—	—	22	—	22 [4]	—	65	—	—	—	—	—		
	277 Vac	—	—	—	—	—	—	—	—	—	—	—	—	—	—	—	—		
DC Ratings	480Y/277 Vac	—	—	—	—	—	—	—	—	—	—	—	—	—	—	—			
	48 Vdc	5 [5]	5 [5]	5 [5]	—	—	—	—	—	—	—	—	—	—	—	—			
	60 Vdc	—	—	—	—	—	—	—	—	—	—	—	—	—	—	—			
	65 Vdc	—	—	—	—	—	—	—	—	—	—	—	—	—	—	—			
	125 Vdc	—	—	—	—	—	—	—	—	—	—	—	—	—	—	—			
	250 Vdc	—	—	—	—	—	—	—	—	—	—	—	—	—	—	—			
IEC 60947-2 (50/60 Hz) [6]	IEC (Icu)	—	—	—	—	—	—	—	—	—	—	—	—	—	—	—			
Special Ratings																			
CCC	—																		
Fed. Specs W-C-375B/GEN	X	—	—	—	X	—	—	—	—	X	—	X	X	—	X	X			
Other Standard	HACR [7] NOM			HACR [7]						—	—	—	HACR [7]	—	HACR [7]	HACR [7]			
Accessories and Modifications																			
Shunt Trip [8]	X	X	X	X	X	X	X	X	X	X [9]	X	X	X	—	—	—	—		
Undervoltage Trip	—	—	—	—	—	—	—	—	—	—	—	—	—	—	—	—			
Auxiliary Switches [8]	X	X	X	X	X	X	X	X	X	X [9]	X	X	X	—	X	—	—		
Alarm Switch [8]	X	X	X	X	X	X	X	X	X	X [9]	X	X	X	—	X	—	—		
Handle Operators	—	—	—	—	—	—	—	—	—	—	—	—	—	—	—	—			
Handle Padlock Attachment	X	X	X	X	X	X	X	X	X	X	X	X	X	X	X	X	X		
Trip System Type																			
Thermal-magnetic	X	X	X	X	X	X	X	X	X	X	X	X	X	X	X	X	X		
Molded Case Switch	X	X	X	—	—	—	—	—	—	—	—	—	—	—	—	—			
Dimensions (1P Unit Mount)																			
Dimensions (1P Unit Mount) in. (mm)	Height	3.5 (89) [1]										4.75 (121)							
	Width											0.75 (19) [1]							
	Depth											2.92 (74) [1]							
Pages	page 7-11																		

[1] For dimensions for QOB2150VH, QOB3110VH, QOB3125VH and QOB3150VH, see page 7-86

[2] 2P 150-200 A requires 4P width.

[3] See the Supplemental Digest, Section 3 for 3Ø corner grounded systems.

[4] 22 kA @ 240 Vac for 3P only.

[5] 1P and 2P, 10-70 A and 3P 10-60 A only.



[6] See the Supplemental Digest Section 10 for circuit breakers with IEC ratings.

[7] HACR on QO, QOB 1P 10-70 A, 2P 15-100 A, 3P 10-100 A; QOB-VH 1P 15-70 A, 2P 15-125 A, 3P 15-100 A.

[8] Factory-installed option only.

[9] Factory-installed accessories are not available on QOB-VH 2P150 A and 3P 110-150 A.

QO-GFI, QO-EPD, QOU, QOM Miniature Circuit Breakers

		QO Circuit Breakers						QOU Circuit Breakers				QOM1 and QOM2 Main Circuit Breakers		
														
Circuit Breaker Type	Plug-on	QO-GFI			QO-VHGF	QO-EPD QO-EPE		—				—		
	Bolt-on	QOB-GFI			QOB-VHGF	QOB-EPD QOB-EPE		—				QOM1-VH QOM2-VH		
	Unit Mount	—	—	—	—	—	—	QOU				QYU [10]	—	
Number of Poles	1	2	3	1	1	2	3	1	2	3	1	2	2	
Current Range (A)	15–30		15–60	15–50	15–30	15–30	15–60	15–50	10–100	10–125	10–100	10–30	50–125	100–225
<b>Interrupting Ratings</b>														
UL/CSA Rating (kA RMS) (50/60 Hz)	120 Vac	10	10	—	22	10	10	—	10	10	10	—	22	22
	120/240 Vac	—	10	—	—	—	10	—	10	10	10	—	22	22
	208Y/120	—	—	10	—	—	—	—	—	—	—	—	—	—
	240 Vac [11]	—	—	—	—	—	—	10	—	—	10	—	—	—
	277 Vac	—	—	—	—	—	—	—	—	—	—	5	—	—
DC Ratings	480Y/277 Vac	—	—	—	—	—	—	—	—	—	—	—	—	—
	48 Vdc	—	—	—	—	—	—	—	5 [12]	5 [12]	5 [12]	—	—	—
	60 Vdc	—	—	—	—	—	—	—	5 [13]	5 [13]	5 [13]	—	—	—
	65 Vdc	—	—	—	—	—	—	—	—	—	—	—	—	—
	125 Vdc	—	—	—	—	—	—	—	—	—	—	—	—	—
	250 Vdc	—	—	—	—	—	—	—	—	—	—	—	—	—
IEC 60947-2 (50/60 Hz) Icu	240 Vac	—	—	—	—	—	—	—	—	—	—	—	—	—
	415 Vac	—	—	—	—	—	—	—	—	—	—	—	—	—
<b>Special Ratings</b>														
CCC	—		—	—	—	—	—	—	X [14]	X [14]	X [14]	—	—	—
Fed. Specs W-C-375B/GEN	X		—	—	—	X	—	—	X	X	X	X	X	X
Other Standard	NOM			—	NOM			—	HACR [15]			—	—	—
<b>Accessories and Modifications</b>														
Shunt Trip	—		—	—	—	—	—	—	X [16]	X [16]	X [16]	X [16]	—	X [16]
Undervoltage Trip	—		—	—	—	—	—	—	—	—	—	—	—	—
Auxiliary Switches	X		X	X	X	X	X	X	X [16]	X [16]	X [16]	X [16]	—	—
Alarm Switch	X		X	X	X	X	X	X	X [16]	X [16]	X [16]	X [16]	—	—
Handle Operators	—		—	—	—	—	—	—	—	—	—	—	—	—
Handle Padlock Attachment	X		X	X	X	X	X	X	X	X	X	X	X	X
<b>Trip System Type</b>														
Thermal-magnetic	X		X	X	X	X	X	X	X	X	X	X	X	X
Molded Case Switch	—		—	—	—	—	—	—	—	X	X	—	—	—
<b>Dimensions (1P Unit Mount)</b>														
Dimensions (1P Unit Mount) in. (mm)	Height	4.12 (103)						4.05 (103)				5.09 (129) [17]	5.60 (142) [17]	
	Width	0.75 (19)						0.75 (19)				5.00 (127) [17]	5.07 (129) [17]	
	Depth	2.92 (74)						2.92 (74)				3.47 (88) [17]	3.60 (91) [17]	
Pages	page 7-11						page 7-19				See Section 1			

NOTE: All circuit breakers on this chart are UL Listed and CSA Certified unless otherwise noted.

[10] QYU is a UL 1077 supplementary protector.  
 [11] For information regarding 3Ø corner grounded systems see the Supplemental Digest, Section 3.  
 [12] 1P and 2P, 10–70 A and 3P 10–60 A only.  
 [13] QOU is UL Listed for 60 Vdc per pole 80–100 A, 1P; 80–125 A, 2P; and 70–100 A, 3P.  
 [14] 15–70 A 1P and 2P, 15–60 A 3P  
 [15] HACR on QOU 1P and 3P 15–100 A, 2P 15–125 A;  
 [16] Factory-installed option only.  
 [17] QOM1 and QOM2 dimensions are for 2-pole unit.



HOM Circuit Breakers



Circuit Breaker Type	Plug-on	HOM		HOM-CAFI	HOM-DF	HOM-GFI		HOM-EPD		HOMT
	Bolt-on	—	—	—	—	—	—	—	—	—
	Unit Mount	—	—	—	—	—	—	—	—	—
Number of Poles		1	2	1, 2	1	1	2	1	2	1
Current Range (A)		15-50	15-200 [18]	15-20	15-20	15-20	15-50	15-20	15-50	15-50 [19]
<b>Interrupting Ratings</b>										
UL/CSA Rating (kA) (50/60 Hz)	120 Vac	10	10	10	10	10	10	10	10	10
	120/240 Vac	10	10	10	—	—	10	—	10	10
	208Y/120	—	—	—	—	—	—	—	—	—
	240 Vac [20]	—	—	—	—	—	—	—	—	—
	277 Vac	—	—	—	—	—	—	—	—	—
DC Ratings	480Y/277 Vac	—	—	—	—	—	—	—	—	—
	48 Vdc	—	—	—	—	—	—	—	—	—
	60 Vdc	—	—	—	—	—	—	—	—	—
	65 Vdc	—	—	—	—	—	—	—	—	—
	125 Vdc	—	—	—	—	—	—	—	—	—
IEC 60947-2 (50/60 Hz) [21]	250 Vdc	—	—	—	—	—	—	—	—	—
	IEC (Icu)	—	—	—	—	—	—	—	—	—
<b>Special Ratings</b>										
CCC		—	—	—	—	—	—	—	—	—
Fed. Specs W-C-375B/GEN		X	X	X	X	X	X	X	X	X
Other Standard		HACR [22] NOM			HACR [22]					
<b>Accessories and Modifications</b>										
Shunt Trip [23]		—	—	—	—	—	—	—	—	—
Undervoltage Trip		—	—	—	—	—	—	—	—	—
Auxiliary Switches [23]		—	—	—	—	—	—	—	—	—
Alarm Switch [23]		—	—	—	—	—	—	—	—	—
Handle Operators		—	—	—	—	—	—	—	—	—
Handle Padlock Attachment		X	X	X	X	—	—	—	—	X [24]
<b>Trip System Type</b>										
Thermal-magnetic		X	X	X	X	X	X	X	X	X
Molded Case Switch		—	—	—	—	—	—	—	—	—
<b>Dimensions (1P Unit Mount)</b>										
Dimensions (1P Unit Mount) in. (mm)	Height	3.13 (79)								
	Width	1.00 (25)								
	Depth	2.98 (76)								
Pages		page 7-22								

[18] 2P 150-200 A requires 4P width.  
 [19] HOMT tandem is 30 A maximum. HOMT quad tandem has 20 A maximum on outside poles, and 50 A maximum on the inside poles.  
 [20] See the Supplemental Digest, Section 3 for 3Ø corner grounded systems.  
 [21] See the Supplemental Digest Section 10 for circuit breakers with IEC ratings.  
 [22] HACR on HOM 1P 15-50 A and 2P 15-100 A.  
 [23] Factory-installed option only.  
 [24] Handle padlock attachment available for HOMT quad tandem only.

**Multi 9, EDB Miniature Circuit Breakers**

		Multi 9 <sup>TM</sup> Circuit Breakers and Supplementary Protectors						EDB Circuit Breakers									
Circuit Breaker Type	Plug-on	—		—		—		—		EDB		EGB		EJB			
	Bolt-on	—		—		—		—		—		—		—			
	Unit Mount	UL 489 C60BP		UL 1077 C60SP [25]		C60H-DC		—		—		—		—			
Number of Poles		1	2	3	1	2	3,4	1	2	1	2,3	1	2,3	1	2,3		
Current Range (A)		0.5-63	0.5-63	0.5-63	0.5-63	1-63	1-63	0.5-63	0.5-63	15-70	15-125	15-70	15-125	15-70	15-125		
Interrupting Ratings																	
UL/CSA Rating (kA RMS) (50/60 Hz)	120 Vac	14 [26]	14 [26]	14 [26]	14 [27]	14 [27]	14 [27]	—	—	25	25	65	65	100	100		
	120/240 Vac	14 [26]	14 [26]	14 [26]	14 [27]	14 [27]	14 [27]	—	—	18	25	35	65	65	100		
	240 Vac [28]	14 [26]	14 [26]	14 [26]	14 [27]	14 [27]	14 [27]	—	—	18	25	35	65	65	100		
	277 Vac	—	—	—	10 [29]	10 [29]	10 [29]	—	—	18	18	35	35	65	65		
DC Ratings	480Y/277 Vac	10 [30]	10 [31]	10 [31]	—	10 [29]	10 [29]	—	—	—	18	—	35	—	65		
	48 Vdc	—	—	—	—	10	—	5	5	—	—	—	—	—	—		
	60 Vdc	—	—	—	—	20	—	5	5	—	—	—	—	—	—		
	65 Vdc	—	—	—	—	—	—	5	5	—	—	—	—	—	—		
	125 Vdc	—	10	—	—	—	—	5	5	—	—	—	—	—	—		
	250 Vdc	—	—	—	—	—	—	5	5	—	—	—	—	—	—		
IEC 60947-2 (50/60 Hz) Icu	500 Vdc	—	—	—	—	—	—	—	5 [32]	—	—	—	—	—	—		
	240 Vac	10	20	20	10	20	20	—	—	20	—	—	—	—	—		
415 Vac	—	10	10	—	5	5	—	—	10	—	—	—	—	—			
Special Ratings																	
CCC	X		X	X	X	X	X	X	X	—	—	—	—	—	—		
Fed. Specs W-C-375B/GEN	X		X	X	—	—	—	—	—	X	X	X	X	X	X		
Other Standard	IEC						HACR										
Accessories and Modifications																	
Shunt Trip	X		X	X	X	X	X	X	X	X [33]	X [33]	X [33]	X [33]	X [33]	X [33]		
Undervoltage Trip	X		X	X	X	X	X	X	X	—	—	—	—	—	—		
Auxiliary Switches	X		X	X	X	X	X	X	X	X [33]	X [33]	X [33]	X [33]	X [33]	X [33]		
Alarm Switch	X		X	X	X	X	X	X	X	X [33]	X [33]	X [33]	X [33]	X [33]	X [33]		
Handle Operators	X		X	X	X	X	X	X	X	—	—	—	—	—	—		
Handle Padlock Attachment	X		X	X	X	X	X	X	X	X	X	X	X	X	X		
Trip System Type																	
Thermal-magnetic	X		X	X	X	X	X	X	X	X	X	X	X	X	X		
Molded Case Switch	—		—	—	—	—	—	—	—	—	—	—	—	—	—		
Dimensions (1P Unit Mount)																	
Dimensions (1P Unit Mount) in. (mm)	Height	4.05 (103)			3.19 (81)			3.19 (81)			5.66 (144)						
	Width	0.71 (18)			0.71 (18)			0.71 (18)		1.42 (36)		0.98 (25)					
	Depth	2.76 (70)			2.76 (70)			2.56 (65)			4.05 (103)						
Pages	page 7-25								See Section 9								

**NOTE:** All circuit breakers on this chart are UL Listed and CSA Certified unless otherwise noted.

- [25] C60 are recognized components per UL 1077.
- [26] 14 kA up to 35 A, 10 kA from 40 to 63 A.
- [27] 14 kA up to 32 A, 10 kA from 40 to 63 A.
- [28] For information regarding 3Ø corner grounded systems see the Supplemental Digest, Section 3.
- [29] 10 kA up to 32 A, 5 kA from 40 to 63 A.
- [30] Up to 35 A.
- [31] 10 kA up to 35 A.
- [32] 2 poles must be wired in series for 500 Vdc.
- [33] Factory-installed option only.

B-, H-, J-Frame Molded Case Circuit Breakers

	PowerPact™ 125 A B-Frame				PowerPact 150 A H-Frame					PowerPact 250 A J-Frame						
	Electronic Trip Version				Electronic Trip Version					Electronic Trip Version						
Circuit Breaker Type	BD	BG	BJ	BK	HD	HG	HJ	HL	HR	JD	JG	JJ	JL	JR		
Number of Poles	1, 2, 3, 4	1, 2, 3, 4	1, 2, 3, 4	1, 2	2, 3	2, 3	2, 3 [34]	2, 3 [34]	3	2, 3 [34]	2, 3 [34]	2, 3 [34]	2, 3 [34]	3		
Current Range (A)	15–125	15–125	15–125	15–30	15–150	15–150	15–150	15–150	15–150	70–250 [35]	70–250 [35]	70–250 [35]	70–250 [35]	70–250 [35]		
Interrupting Ratings																
UL/CSA/ NOM AC Rating (kA RMS) (50/60 Hz)	240 Vac	25	65	100	100	25	65	100	125	200	25	65	100	125	200	
	480Y/277 Vac	18	35	65	65	18	35	65	100	200	18	35	65	100	200	
	480 Vac	18	35	65	65	18	35	65	100	200	18	35	65	100	200	
	600Y/347 Vac	14	18	25	65	14	18	25	50	100	14	18	25	50	100	
UL/CSA/ NOM DC Ratings	600 Vac	—	—	—	—	14	18	25	50	100	14	18	25	50	100	
	250 Vdc [36]	10	20	50	—	20	20	20	20	—	20	20	20	20	—	
IEC AC Rating (kA RMS) (50/60 Hz) (cu/lcs [38])	500 Vdc [36]	—	—	—	—	—	20	—	50	—	—	20	—	50	—	
	220/240 Vac	25	65	100	100	25	65	100	125	150	25	65	100	125	150	
	380/415 Vac	18	35	65	65	18	35	65	100	125	18	35	65	100	125	
	440/480 Vac	18	35	65	65	18	35	65	100	125	18	35	65	100	125	
	500/525 Vac	14	18	25	25	14	18	25	50	75	14	20	20	20	75	
IEC DC Ratings	690 Vac	—	—	—	—	—	—	—	20	—	—	—	—	20		
	250 Vdc	—	—	—	—	—	—	—	—	20	20	20	20	—		
Special Ratings	500 Vdc	—	—	—	—	—	—	—	—	20	20	20	20	—		
	CCC	X	X	X	X	X	X	X	X	X	X	X	X	X		
Fed. Specs W-C-375B/GEN	X	X	X	X	X	X	X	X	X	X	X	X	X	X		
HACR	X	X	X	X	X	X	X	X	X	X	X	X	X	X		
Connections/Terminations																
Unit Mount	X	X	X	X	X	X	X	X	X	X	X	X	X	X		
I-Line™	X	X	X	X	X	X	X	X	X	X	X	X	X	X		
Rear Connection	—	—	—	—	X [39]	X [39]	X	X	X	X	X	X	X	X		
Drawout	—	—	—	—	X [39]	X [39]	X	X	X	X	X	X	X	X		
Optional Lugs	X	X	X	X	X [39]	X [39]	X	X	X	X	X	X	X	X		
Accessories and Modifications																
Shunt Trip	X	X	X	X	X	X	X	X	X	X	X	X	X	X		
Undervoltage Trip	X	X	X	X	X	X	X	X	X	X	X	X	X	X		
Auxiliary Switches	X	X	X	X	X	X	X	X	X	X	X	X	X	X		
Alarm Switch	X	X	X	X	X	X	X	X	X	X	X	X	X	X		
Motor Operator	—	—	—	—	X [39]	X [39]	X	X	X	X	X	X	X	X		
Handle Operators	X	X	X	X	X [39]	X [39]	X	X	X	X	X	X	X	X		
Mechanical Interlocks (3P)	X	X	X	—	X	X	X	X	X	X	X	X	X	X		
Handle Padlock Attachment	X	X	X	X	X [39]	X [39]	X	X	X	X	X	X	X	X		
Cylinder Lock (3P)	—	—	—	—	—	—	—	—	—	—	—	—	—	—		
Optional GF Protection	—	—	—	—	X	X	X	X	X	X	X	X	X	X		
Trip System Type																
Thermal-magnetic	X	X	X	X	X	X	X	X	—	X	X	X	X	X		
Instantaneous-only (MCP)	—	—	—	—	—	X	X [40]	X [40]	X [40]	—	X [40]	X [40]	X	X		
Molded Case Switch (Automatic)	X	X	X	X	—	X	—	X	—	—	X	—	X	X		
Electronic	—	—	—	—	X [40]	X [40]	X [40]	X [40]	X [40]	X [40]	X [40]	X [40]	X [40]	X [40]		
Enclosures (page 7-86–page 7-88)																
General Purpose (NEMA 1)	—	—	—	—	X	X	X	X	—	X	X	X	X	—		
Raintight (NEMA 3R)	—	—	—	—	X	X	X	X	—	X	X	X	X	—		
Dust-tight (NEMA 12)	—	—	—	—	X	X	X	X	—	X	X	X	X	—		
Watertight (NEMA 4, 4X, 5)	—	—	—	—	X	X	X	X	—	X	X	X	X	—		
Explosion Proof (NEMA 7, 9)	—	—	—	—	—	—	—	—	—	X [41]	X [41]	—	—	—		
Dimensions (3P Unit Mount) in. (mm)	Height	5.4 (137)					6.4 (163)					7.5 (191)				
	Width	3.2 (81)					4.1 (104)					4.1 (104)				
	Depth	3.5 (89)					3.4 (86)					3.4 (86)				
Pages (Unit Mount) / (I-Line)		page 7-32 / Section 9					page 7-33 / Section 9					page 7-33 / Section 9				

NOTE: All circuit breakers on this chart are UL Listed and CSA Certified unless otherwise noted.

- [34] 2P in a 3P module.
- [35] 70–250 A with electronic trip system
- [36] Not available with electronic trip units
- [37] 1P Available at 125 Vdc
- [38] Dual UL and IEC ratings and CE markings on circuit breakers. For additional IEC ratings, see the Supplemental Digest, Section 10.
- [39] Not available in HD and HG 2P rating (2P module).
- [40] 3P only.
- [41] Not UL Listed due to wire bending space.

### PowerPact™ Q-Frame, Q4, LA, LH, L-Frame Molded Case Circuit Breakers

		PowerPact 250 A Q-Frame				Q4	400 A LA/LH		PowerPact 600 A L-Frame			
												
Circuit Breaker Type		QB	QD	QG	QJ	Q4	LA	LH	LG	LJ	LL	LR
Number of Poles		2, 3	2, 3	2, 3	2, 3	2, 3	2, 3	2, 3	3, 4	3, 4	3, 4	3, 4
Current Range (A)		70–250 [42]	70–250 [42]	70–250 [42]	70–250 [42]	250–400	125–400	125–400	70–600	70–600	70–600	70–600
<b>Interrupting Ratings</b>												
UL/CSA/NOM AC Rating (kA RMS) (50/60 Hz)	240 Vac	10	25	65	100	25	42	65	65	100	125	200
	480Y/277 Vac	—	—	—	—	—	30	35	35	65	100	200
	480 Vac	—	—	—	—	—	30	35	35	65	100	200
	600Y/347 Vac	—	—	—	—	—	22	25	18	25	50	100
UL/CSA/NOM DC Ratings	600 Vac	—	—	—	—	—	22	25	18	25	50	100
	250 Vdc [43]	—	—	—	—	—	10	50	—	—	—	—
IEC AC Rating (kA RMS) (50/60 Hz) Icu/Ics [45]	500 Vdc [44][43]	—	—	—	—	—	—	20	20	—	50	—
	220/240 Vac	10/5	10/5	10/5	10/5	—	—	—	65	100	125	150
	380/415 Vac	10/5	10/5	10/5	10/5	—	20/5[46]	20/5[46]	18	65	100	125
	440/480 Vac	—	—	—	—	—	—	—	18	65	100	125
	500/525 Vac	—	—	—	—	—	—	—	14	25	50	75
IEC DC Ratings	690 Vac	—	—	—	—	—	—	—	—	—	—	20
	250 Vdc	—	—	—	—	—	—	—	—	—	—	—
	500 Vdc	—	—	—	—	—	—	—	—	—	—	—
<b>Special Ratings</b>												
CCC		—	—	—	—	—	—	—	X	X	X	X
Fed. Specs W-C-375B/GEN		X	X	X	X	X	X	X	X	X	X	X
HACR (2P, 3P)		X	X	X	—	—	X	X	X	X	X	X
<b>Connections/Terminations</b>												
Unit Mount		X	X	X	X	X	X	X	X	X	X	X
I-Line™		X	X	X	X	X	X	X	X	X	X	X
Rear Connection		—	—	—	—	X	X	X	X	X	X	X
Drawout		—	—	—	—	—	—	—	X	X	X	X
Optional Lugs		—	—	—	—	X	X	X	X	X	X	X
<b>Accessories and Modifications</b>												
Shunt Trip		—	—	—	—	X	X	X	X	X	X	X
Undervoltage Trip		—	—	—	—	X	X	X	X	X	X	X
Auxiliary Switches		—	—	—	—	X	X	X	X	X	X	X
Alarm Switch		—	—	—	—	X	X	X	X	X	X	X
Motor Operator		—	—	—	—	X	X	X	X	X	X	X
Handle Operators		—	—	—	—	X	X	X	X	X	X	X
Mechanical Interlocks (3P)		X	X	X	X	—	X [47]	X [47]	X	X	X	X
Handle Padlock Attachment		X	X	X	X	X	X	X	X	X	X	X
Cylinder Lock (3P [48])		—	—	—	—	X	X	X	—	—	—	—
Optional GF Protection [49]		—	—	—	—	—	—	—	X	X	X	X
<b>Trip System Type</b>												
Thermal-magnetic		X	X	X	X	X	X	X	—	—	—	—
Instantaneous-only (MCP)		—	—	—	—	—	X	X	X	X	X	X
Molded Case Switch (Automatic)		X	—	—	—	—	—	X	X	—	X	X
Electronic		—	—	—	—	—	—	—	X	X	X	X
<b>Enclosures (page 7-86–page 7-88)</b>												
General Purpose (NEMA 1)		X	X	X	X	X	X	X	—	—	—	—
Raintight (NEMA 3R)		X	X	X	X	X	X	X	—	—	—	—
Dust-tight (NEMA 12)		—	—	—	—	X	X	X	X [50]	X [50]	X [50]	X [50]
Watertight (NEMA 4, 4X, 5)		—	—	—	—	X	X	X	—	—	—	—
Explosion Proof (NEMA 7, 9)		—	—	—	—	—	—	—	—	—	—	—
Dimensions (3P Unit Mount)	Height	6.47 (164)				11 (279)			13.38 (340)			
	Width	4.5 (114)				6 (152)			5.51 (140)			
	Depth	3.93 (100)				5.84 (148)			4.33 (110)			
Pages (Unit Mount) / (I-Line)		page 7-36 / Supplemental Section 9				page 7-37 / Supplemental Section 9			page 7-38 / Supplemental Section 9			

**NOTE:** All circuit breakers on this chart are UL Listed and CSA Certified unless otherwise noted.

- [42] I-Line Q-frame circuit breakers are available 70–225 A only. 250 A Q-frame unit-mount circuit breakers are limited to Cu conductors only.
- [43] Not available with electronic trip units.
- [44] Ungrounded UPS systems only. See page 7-45. Special DC J-Frame only.
- [45] Dual UL and IEC ratings and CE markings on circuit breakers. For additional IEC ratings, see the Supplemental Digest, Section 10.
- [46] For additional IEC ratings, see the Supplemental Digest Section 10.
- [47] Requires circuit breaker with WB suffix .
- [48] Factory-installed option only.
- [49] Requires factory-installed "G" shunt trip and 3P module.
- [50] Enclosure rating 1, 3R, 5 and 12.,

**M-, P-, and R-Frame Molded Case Circuit Breakers**

		PowerPact 800 A M-Frame			PowerPact 1200 A P-Frame				PowerPact 3000 A R-Frame			
												
Circuit Breaker Type		MG	MJ	PG	PJ	PK	PL	RG	RJ	RK	RL	
Number of Poles		2, 3	2, 3	2, 3, 4	2, 3, 4	2, 3, 4	2, 3, 4	2, 3, 4	2, 3, 4	2, 3, 4	2, 3, 4	
Current Range (A)		300–800	300–800	100–1200	100–1200	100–1200	100–1200	240–3000	240–3000	240–3000	240–3000	
<b>Interrupting Ratings</b>												
UL/CSA/NOM Rating (kA RMS) (50/60 Hz)	240 Vac	65	100	65	100	65	125	65	100	65	125	
	480Y/277 Vac	35	65	35	65	50	100	35	65	65	100	
	480 Vac	35	65	35	65	50	100	35	65	65	100	
	600Y/347 Vac	18	25	18	25	50	25	18	25	65	50	
DC Ratings	600 Vac	18	25	18	25	50	25	18	25	65	50	
	250 Vdc	—	—	—	—	—	—	—	—	—	—	
	500 Vdc [51]	—	—	—	—	—	—	—	—	—	—	
IEC (kA RMS) (50/60 Hz) Icu/Ics [52]	240 Vac	50/25	65/35	50/25	65/35	50/25	125/65	50/25	65/35	85/65	125/65	
	415 Vac	35/20	50/25	35/20	50/25	50/25	85/45	35/20	50/25	70/55	85/45	
<b>Special Ratings</b>												
CCC		X	X	X	X	X	X	X	X	X	X	
Fed. Specs W-C-375B/GEN		X	X	X	X	X	X	X	X	X	X	
HACR (2P, 3P)		X	X	X	X	X	X	X	X	X	X	
<b>Connections/Terminations</b>												
Unit Mount		X	X	X	X	X	X	X	X	X	X	
I-Line <sup>TM</sup>		X	X	X	X	X	X	X [53]	X [53]	X [53]	X [53]	
Rear Connection		—	—	—	—	—	—	—	—	—	—	
Drawout		—	—	X [54]	X [54]	X [54]	X [54]	—	—	—	—	
Optional Lugs		X	X	X	X	X	X	X	X	X	X	
<b>Accessories and Modifications</b>												
Shunt Trip		X	X	X	X	X	X	X	X	X	X	
Undervoltage Trip		X	X	X	X	X	X	X	X	X	X	
Auxiliary Switches		X	X	X	X	X	X	X	X	X	X	
Alarm Switch		X	X	X	X	X	X	X	X	X	X	
Motor Operator		—	—	X [54]	X [54]	X [54]	X [54]	—	—	—	—	
Handle Operators		—	—	X [54]	X [54]	X [54]	X [54]	—	—	—	—	
Mechanical Interlocks (3P)		—	—	X	X	X	X	—	—	—	—	
Handle Padlock Attachment		X	X	X	X	X	X	X	X	X	X	
Cylinder Lock (3P)		—	—	—	—	—	—	—	—	—	—	
Optional GF Protection		—	—	X	X	X	X	X	X	X	X	
<b>Trip System Type</b>												
Thermal-magnetic		—	—	—	—	—	—	—	—	—	—	
Instantaneous-only (MCP)		—	—	—	X	X	—	—	—	—	—	
Molded Case Switch (Automatic)		X	X	X	X	X	X	X	X	X	X	
Electronic		X	X	X	X	X	X	X	X	X	X	
<b>Enclosures (page 7-86–page 7-88)</b>												
General Purpose (NEMA 1)		X	X	X	X	X	X	—	—	—	—	
Raintight (NEMA 3R)		X	X	X	X	X	X	—	—	—	—	
Dust-tight (NEMA 12)		X	X	X	X	X	X	—	—	—	—	
Watertight (NEMA 4, 4X, 5)		X	X	—	—	—	—	—	—	—	—	
Explosion Proof (NEMA 7, 9)		—	—	—	—	—	—	—	—	—	—	
Dimensions (3P Unit Mount)	Height—in. (mm)	12.80 (325)			16.20 (413)				15 (381)			
	Width—in. (mm)	8.30 (210)			8.30 (210)				16.50 (420)			
	Depth—in. (mm)	8.10 (205)			8.10 (205)				14.40 (366)			
Pages (Unit Mount) / (I-Line)		page 7-40 / Section 9			page 7-41, page 7-46 / Section 9				page 7-42, page 7-46 / Section 9			

**NOTE:** All circuit breakers on this chart are UL Listed and CSA Certified unless otherwise noted.



[51] Ungrounded UPS systems only. See page 7-45.

[52] Dual UL and IEC ratings and CE markings on circuit breakers. For additional IEC ratings, see the Supplemental Digest, Section 10.

[53] 1000 A and 1200 A only.

[54] 65/50 kA Icu/Ics for 450–600 A ratings.

### MasterPact MTZ Molded Case Circuit Breakers

	MasterPact MTZ1 800–1600 A					MasterPact MTZ2 800–6000 A				MasterPact MTZ3 4000–6000 A				
														
Circuit Breaker Type	MTZ1-N	MTZ1-H	MTZ1-L1	MTZ1-L	MTZ1-LF <small>[55]</small>	MTZ2-N	MTZ2-H	MTZ2-L	MTZ2-LF <small>[55]</small>	MTZ2-H	MTZ2-L	MTZ3-H	MTZ3-L	
Number of Poles	3, 4	3, 4	3	3	3	3, 4	3, 4	3	3	3, 4	3	3, 4	3	
Current Range	400–1200	400–1200	400–1200	400–1200	400–1200	400–2000	400–2000	400–2000	400–2000	1200–3000	1200–3000	2000–6000	2000–6000	
<b>Interrupting Ratings</b>														
UL/CSA Rating (kA RMS) (50/60 Hz)	240 Vac	50	65	100	200	200	65	100	200	200	100	200	100	200
	480Y/277 Vac	50	50	65	100	100	65	100	150	150	100	150	100	150
	480 Vac	50	50	65	100	100	65	100	150	150	100	150	100	150
	600Y/347 Vac	35	50	—	—	—	50	85	100	100	85	100	85	100
DC Ratings	600 Vac	35	50	—	—	—	50	85	100	100	85	100	85	100
	250 Vdc	—	—	—	—	—	—	—	—	—	—	—	—	
IEC <small>[56]</small> (kA RMS) Icu/ Ics	500 Vdc	—	—	—	—	—	—	—	—	—	—	—	—	
	240 Vac	—	—	—	—	—	—	—	—	—	—	—	—	
Special Ratings	415 Vac	—	—	—	—	—	—	—	—	—	—	—	—	
	CCC	—	—	—	—	—	—	—	—	—	—	—	—	
	Fed. Specs W-C-375B/GEN	—	—	—	—	—	—	—	—	—	—	—	—	
HACR (2P, 3P)	—	—	—	—	—	—	—	—	—	—	—	—		
<b>Connections/Terminations</b>														
Unit Mount	X	X	X	X	X	X	X	X	X	X	X	X	X	
I-Line™	—	—	—	—	—	—	—	—	—	—	—	—	—	
Rear Connection	X	X	X	X	X	X	X	X	X	X	X	X	X	
Drawout	X	X	X	X	X	X	X	X	X	X	X	X	X	
Optional Lugs	—	—	—	—	—	—	—	—	—	—	—	—	—	
<b>Accessories and Modifications</b>														
Shunt Trip	X	X	X	X	X	X	X	X	X	X	X	X	X	
Undervoltage Trip	X	X	X	X	X	X	X	X	X	X	X	X	X	
Auxiliary Switches	X	X	X	X	X	X	X	X	X	X	X	X	X	
Alarm Switch	X	X	X	X	X	X	X	X	X	X	X	X	X	
Motor Operator	X	X	X	X	X	X	X	X	X	X	X	X	X	
Handle Operators	—	—	—	—	—	—	—	—	—	—	—	—	—	
Mechanical Interlocks	X	X	X	X	X	X	X	X	X	X	X	X	X	
Padlock Attachment	X	X	X	X	X	X	X	X	X	X	X	X	X	
Optional GF Protection	X	X	X	X	X	X	X	X	X	X	X	X	X	
<b>Trip System Type</b>														
Thermal-magnetic	—	—	—	—	—	—	—	—	—	—	—	—	—	
Instantaneous-only (MCP)	—	—	—	—	—	—	—	—	—	—	—	—	—	
Electronic	X	X	X	X	X	X	X	X	X	X	X	X	X	
<b>Enclosures</b>														
General Purpose (NEMA 1)	—	—	—	—	—	—	—	—	—	—	—	—	—	
Raintight (NEMA 3R)	—	—	—	—	—	—	—	—	—	—	—	—	—	
Dust-tight (NEMA 12)	—	—	—	—	—	—	—	—	—	—	—	—	—	
Watertight (NEMA 4, 4X, 5)	—	—	—	—	—	—	—	—	—	—	—	—	—	
Explosion Proof (NEMA 7, 9)	—	—	—	—	—	—	—	—	—	—	—	—	—	
Dimensions (3P Drawout) in. (mm)	Height	12.67 (322)					17.28 (439)				17.28 (439)		17.28 (439)	
	Width	11.25 (286)					17.74 (450)				17.74 (450)		30.94 (786)	
	Depth	13.54 (344)					18.50 (470)				18.50 (470)		18.50 (470)	
Pages	MasterPact™ Power Circuit Breakers, page 7-66 and Catalog 0614CT1701													

**NOTE:** All circuit breakers on this chart are UL Listed and CSA Certified unless otherwise noted.

[55] Tested to show arc flash hazard risk category as reference by NFPA70E.

[56] See Catalog 0614CT1701 for additional ratings and other information.

MasterPact NT, NW Molded Case Circuit Breakers

		MasterPact 1200 A					MasterPact 6000 A							
Circuit Breaker Type		NT-N	NT-H	NT-L1	NT-L	NT-LF [57]	NW-N	NW-H	NW-L	NW-LF [57]	NW-H	NW-L	NW-H	NW-L
Number of Poles		3, 4	3, 4	3	3	3	3, 4	3, 4	3	3	3, 4	3	3, 4	3
Current Range		100–1200	100–1200	100–1200	100–1200	100–1200	100–2000	100–2000	100–2000	100–2000	640–3000	640–3000	1200–6000	1200–6000
<b>Interrupting Ratings</b>														
UL/CSA/NOM Rating (kA RMS) (50/60 Hz)	240 Vac	50	65	100	200	200	65	100	200	200	100	200	100	200
	480Y/277 Vac	50	50	65	100	100	65	100	150	150	100	150	100	150
	480 Vac	50	50	65	100	100	65	100	150	150	100	150	100	150
	600Y/347 Vac	35	50	—	—	—	50	85	100	100	85	100	85	100
DC Ratings	250 Vdc	—	—	—	—	—	—	—	—	—	—	—	—	—
	500 Vdc	—	—	—	—	—	—	—	—	—	—	—	—	—
IEC [58] (kA RMS) Icu/Ics	240 Vac	—	—	—	—	—	—	—	—	—	—	—	—	—
	415 Vac	—	—	—	—	—	—	—	—	—	—	—	—	—
<b>Special Ratings</b>														
CCC		—	—	—	—	—	—	—	—	—	—	—	—	—
Fed. Specs W-C-375B/GEN		—	—	—	—	—	—	—	—	—	—	—	—	—
HACR (2P, 3P)		—	—	—	—	—	—	—	—	—	—	—	—	—
<b>Connections/Terminations</b>														
Unit Mount		X	X	X	X	X	X	X	X	X	X	X	X	X
I-Line™		—	—	—	—	—	—	—	—	—	—	—	—	—
Rear Connection		X	X	X	X	X	X	X	X	X	X	X	X	X
Drawout		X	X	X	X	X	X	X	X	X	X	X	X	X
Optional Lugs		—	—	—	—	—	—	—	—	—	—	—	—	—
<b>Accessories and Modifications</b>														
Shunt Trip		X	X	X	X	X	X	X	X	X	X	X	X	X
Undervoltage Trip		X	X	X	X	X	X	X	X	X	X	X	X	X
Auxiliary Switches		X	X	X	X	X	X	X	X	X	X	X	X	X
Alarm Switch		X	X	X	X	X	X	X	X	X	X	X	X	X
Motor Operator		X	X	X	X	X	X	X	X	X	X	X	X	X
Handle Operators		—	—	—	—	—	—	—	—	—	—	—	—	—
Mechanical Interlocks		X	X	X	X	X	X	X	X	X	X	X	X	X
Padlock Attachment		X	X	X	X	X	X	X	X	X	X	X	X	X
Cylinder Lock		—	—	—	—	—	—	—	—	—	—	—	—	—
Optional GF Protection		X	X	X	X	X	X	X	X	X	X	X	X	X
<b>Trip System Type</b>														
Thermal-magnetic		—	—	—	—	—	—	—	—	—	—	—	—	—
Instantaneous-only (MCP)		—	—	—	—	—	—	—	—	—	—	—	—	—
Molded Case Switch (Automatic)		X	X	X	X	X	X	X	X	X	X	X	X	X
Electronic		X	X	X	X	X	X	X	X	X	X	X	X	X
<b>Enclosures</b>														
General Purpose (NEMA 1)		—	—	—	—	—	—	—	—	—	—	—	—	—
Raintight (NEMA 3R)		—	—	—	—	—	—	—	—	—	—	—	—	—
Dust-tight (NEMA 12)		—	—	—	—	—	—	—	—	—	—	—	—	—
Watertight (NEMA 4, 4X, 5)		—	—	—	—	—	—	—	—	—	—	—	—	—
Explosion Proof (NEMA 7, 9)		—	—	—	—	—	—	—	—	—	—	—	—	—
Dimensions (3P Drawout) in. (mm)	Height	12.67 (322)					17.28 (439)				17.28 (439)		17.28 (439)	
	Width	11.25 (286)					17.74 (450)				17.74 (450)		30.94 (786)	
	Depth	13.00 (331)					18.38 (467)				18.38 (467)		18.38 (467)	
Pages		page 7-79 and Catalog 0613CT0001						page 7-79 and Catalog 0613CT0001						

NOTE: All circuit breakers on this chart are UL Listed and CSA Certified unless otherwise noted.

MINIATURE AND MOLDED CASE  
CIRCUIT BREAKERS

[57] Tested to show arc flash hazard risk category as reference by NFPA70E.  
[58] See Catalog 0613CT0001 for additional ratings and other information.

**QO Standard Plug-On Circuit Breakers**

Square D brand QO miniature circuit breakers are plug-on products for use in QO load centers, NQOD and NQ panelboards, NQOD and NQ OEM interiors or Speed-D™ switchboard distribution panels. Bolt-on QOB circuit breakers are for use in NQOD and NQ panelboards or interiors. [1]

The Square D exclusive Qwik-Open™ mechanism, with a trip reaction within 1/60th of a second, is standard on all 1P 15 and 20 A QO circuit breakers.

**Table 7.1: Standard QO Plug-On Circuit Breakers**

Amperes Rating [2]	1P—120/240 Vac	2P—120/240 Vac Common Trip	2P—240 Vac [3] Common Trip	3P—240 Vac Common Trip
<b>10 k AIR</b>				
10 A	QO110	QO210	—	QO310
15 A	QO115 [4] [5]	QO215 [4]	QO215H	QO315 [4]
20 A	QO120 [4] [5]	QO220 [4]	QO220H	QO320 [4]
25 A	QO125 [4]	QO225 [4]	QO225H OBS	QO325 [4]
30 A	QO130 [4]	QO230 [4]	QO230H	QO330 [4]
35 A	QO135 [4]	QO235 [4]	—	QO335 [4]
40 A	QO140 [4]	QO240 [4]	QO240H	QO340 [4]
45 A	QO145 OBS	QO245 [4]	—	QO345 [4]
50 A	QO150 [4]	QO250 [4]	QO250H OBS	QO350 [4]
60 A	QO160 [4]	QO260 [4]	QO260H OBS	QO360 [4]
70 A	QO170 [4]	QO270 [4]	QO270H OBS	QO370 [4]
80 A	—	QO280 [4]	QO280H OBS	QO380 [4]
90 A	—	QO290 [4]	QO290H OBS	QO390 [4]
100 A	—	QO2100 [4]	QO2100H	QO3100 [4]
110 A	—	QO2110 [4]	—	—
125 A	—	QO2125 [4]	—	—
150 A	—	QO2150 [4] [6] [7]	—	—
175 A	—	QO2175 [4] [6] [7]	—	—
200 A	—	QO2200 [4] [6] [7]	—	—
Molded Case Switch 60 A max.—240 Vac		—	QO200	QO300 OBS
Molded Case Switch 100 A max.—240 Vac		—	QO2000 OBS	QO3000 OBS
<b>22 k AIR [4]</b>				
15 A	QO115VH [5]	QO215VH [8]	—	QO315VH [8]
20 A	QO120VH [5]	QO220VH [8]	—	QO320VH [8]
25 A	QO125VH OBS	QO225VH [8]	—	QO325VH [8]
30 A	QO130VH	QO230VH [8]	—	QO330VH [8]
40 A	QO140VH	QO240VH [8]	—	QO340VH [8]
50 A	QO150VH	QO250VH [8]	—	QO350VH [8]
60 A	QO160VH	QO260VH [8]	—	QO360VH [8]
70 A	QO170VH	QO270VH [8]	—	QO370VH [8]
80 A	—	QO280VH [8]	—	QO380VH [8]
90 A	—	QO290VH [8]	—	QO390VH [8]
100 A	—	QO2100VH [8] [9]	—	QO3100VH [8]
110 A	—	QO2110VH [8] [9]	—	—
125 A	—	QO2125VH [8] [9]	—	—
150 A	—	QO2150VH [6] [8] [7]	—	—
175 A	—	QO2175VH OBS	—	—
200 A	—	QO2200VH [6] [8] [7]	—	—
<b>42 k AIR [4]</b>				
40 A	—	QOH240 OBS	—	—
45 A	—	QOH245 OBS	—	—
50 A	—	QOH250 OBS	—	—
60 A	—	QOH260 [10]	—	—
70 A	—	QOH270	—	—
80 A	—	QOH280	—	—
90 A	—	QOH290	—	—
100 A	—	QOH2100	—	—
110 A	—	QOH2110 [10]	—	—
125 A	—	QOH2125	—	—
<b>65 k AIR [4]</b>				
15 A	QH115 OBS	QH215 OBS	—	QH315 OBS
20 A	QH120 [5]	QH220	—	QH320 OBS
25 A	QH125 OBS	QH225 OBS	—	QH325 [10]
30 A	QH130 OBS	QH230	—	QH330 OBS

OBS This product is obsolete.

Refer to page 7-2 for Interrupting Ratings, Accessories, and Dimensions.



QO 1P  
1 Space Required



QO 2P  
2 Spaces Required



QO 3P  
3 Spaces Required



QO2200 2P 200 A  
4 Spaces Required

- [1] See Digest Section 1 for load centers, and Section 9 for panelboards and interiors.
- [2] 10–30 A circuit breakers are suitable for use with 60°C or 75°C conductors. 35–125 A circuit breakers are suitable for use with 75°C conductors.
- [3] UL Listed 5 k AIR on corner grounded Delta systems.
- [4] UL Listed as HACR type for use with air conditioning, heating and refrigeration equipment having motor group combinations and marked for use with HACR type circuit breakers.
- [5] UL Listed as SWD (switching duty) rated. Suitable for switching 120 Vac fluorescent lighting loads.
- [6] Requires four spaces (1 AWG–300 kcmil Al/Cu.) Suitable for switching 120 Vac fluorescent lighting loads.
- [7] Not suitable for use in 3Ø panels. Use only in 1Ø panel rated 150 A or greater.
- [8] UL Listed for use ahead of QO, QO-GFI, QO-EPD, QOT, QO-AFI, and QO-PL 10 k AIR circuit breakers to permit their application at 22 kA fault level.
- [9] 100 A maximum branch mounted opposite.
- [10] Order only. Contact your local Field Office.



### QO/QOB Ring Terminal

Table 7.2: QO/QOB Ring Terminal—Factory-Installed Only

Ampere Rating	Poles	Suffix
10–30 A	1, 2, 3	5237
35–60 A	1, 2	5238
35–50 A	3	
70–110 A	2	
60–100 A	3	5273

### Wire Sizes for QO/QOB Circuit Breakers

Table 7.3: Wire Sizes for QO/QOB Circuit Breakers

Circuit Breaker Type	Ampere Rating [11]	Wire Size (AWG/kcmil)
QO 1P	10–30 A	14–8 Al/Cu
	10–30 A	(2) 14–10 Cu
	35–70 A	8–2 Al/Cu
QO 2P	10–30 A	14–8 Al/Cu
	10–30 A	(2) 14–10 Cu
	35–70 A	8–2 Al/Cu
	80–125 A	4–2/0 Al/Cu
	150–200 A	4–300 Al/Cu
QO 3P	10–30 A	14–8 Al/Cu, (2) 14–10 Cu
	35–70 A	8–2 Al/Cu
	80–125 A	4–2/0 Al/Cu
QOB-VH	110–150 A	4–300 Al/Cu
QOT	15–20 A	12–8 Al 14–8 Cu
QO-AFI, QO-GFI or QO-EPD	15–30 A	12–8 Al 14–8 Cu
	40, 50, 60 A	12–4 Al 14–6 Cu
QO-PL	10–60 A	12–2 Al 14–2 Cu

### QOT and QO Tandem Circuit Breakers

QOT tandem circuit breakers have a mounting cam as shown. Installation into a QO load center can only be made in those positions having a mounting pan rail slot. Meets Paragraph 408.54 of the NEC®. UL Listed as Class CTL.



QOT 1P Tandem  
1 Space Required

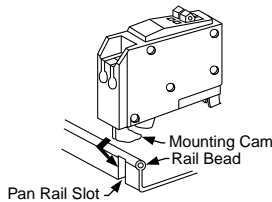

Table 7.4: QOT Tandem Circuit Breakers (CTL)—Not Compatible with Plug-on Neutral Systems

Ampere Rating [11]	Cat. No. [12]
<b>1P—120/240 Vac</b>	
15 A and 15 A	QOT1515
15 A and 20 A	QOT1520
20 A and 20 A	QOT2020
<b>2P—120/240 Vac Common Trip</b>	

Order two QOT1515 or QOT2020 circuit breakers and handle tie QOTHT for common switching of center two poles.

Table 7.5: QO Tandem Circuit Breakers (non-CTL)—Compatible with Plug-on Neutral Systems

Ampere Rating [11]	Cat. No. [12]
<b>1P—120/240 Vac—1 Space Required</b>	
15 A and 15 A	QO1515
15 A and 20 A	QO1520
20 A and 20 A	QO2020
20 A and 30 A	QO2030
30 A and 20 A	QO3020
<b>Two 1P Individual Trip—120/240 Vac—2 Spaces Required</b>	
15 A and 15 A	Order two QO1515 or QO2020 circuit breakers and handle tie QOTHT
15 A and 20 A	
20 A and 20 A	—
20 A and 30 A	QO20303020 [13]
30 A and 20 A	—

[11] 10–30 A circuit breakers are suitable for use with 60°C or 75°C conductors. 35–125 A circuit breakers are suitable for use with 75°C conductors.

[12] UL Listed as HACR type for use with air conditioning, heating and refrigeration equipment having motor group combinations and marked for use with HACR type circuit breakers.

[13] Includes two circuit breakers (one QO2030 and one QO3020) and handle tie QOTHT.

**QO Arc-Fault Circuit Breaker (QO-CAFI)**

QO arc-fault circuit breakers provide protection for Series and Parallel Type Arcing as required by the NEC and local code adoption, and comply with UL 1699.



1P QO-CAFI Plug-On Neutral

1P QO-CAFI Pigtail

**Table 7.6: QO-CAFI Circuit Breakers**

Circuit Breaker Type [14]	Ampere Rating	One-Pole 120 Vac		Two-Pole 120/240 Vac	
		10 k AIR 1 Space Required	22 k AIR 1 Space Required	10 k AIR 2 Space Required	22 k AIR 2 Space Required
Combination Arc-fault Interrupter (Pigtail Neutral)	15 20	QO115CAFI QO120CAFI	QO115VHCAFI QO120VHCAFI	QO215CAFI [15] QO220CAFI [15]	QO215VHCAFI OBS QO220VHCAFI OBS
Plug-On Neutral Combination Arc-fault Interrupter	15 20	QO115PCAFI QO120PCAFI	QO115VHPCAFI QO120VHPCAFI	—	—

OBS This product is obsolete.

**QO Dual Function Circuit Breaker**

QO Combination Arc Fault and Ground Fault Circuit Interrupters (Dual Function) provide overload and short circuit protection, plus arc fault and ground fault protection in accordance with the NEC, UL 1699 and UL 943.



1P QO-DF Plug-on Neutral

1P QO-DF Pigtail

**Table 7.7: QO-DF Circuit Breakers**

Circuit Breaker Type [14]	Ampere Rating	1P 120 Vac 10 k AIR 1 Space Required	1P 120 Vac 22 k AIR 1 Space Required
Combination Arc-fault and Ground Fault Circuit Interrupter (Pigtail Neutral)	15 20	QO115DF QO120DF	QO115VHDF OBS QO120VHDF
Plug-On Neutral Combination Arc-fault and Ground Fault Circuit Interrupter	15 20	QO115PAFGF QO120PAFGF	QO115VHPAFGF QO120VHPAFGF

OBS This product is obsolete.

**QO Ground-Fault Circuit Breakers (GFI)**

Qwik-Gard™ circuit breakers provide overload and short circuit protection, combined with Class A ground fault protection. Class A denotes a ground fault circuit interrupter that will trip when a fault current to ground is 6 mA or more, for people protection. Do not connect to more than 250 feet of load conductor for the total one-way run to prevent nuisance tripping.



1P QO-GFI

2P QO-GFI

**Table 7.8: QO-GFI Circuit Breakers**

Circuit Breaker Type	Ampere Rating [16]	Qwik-Gard Circuit Breakers With Ground Fault Circuit Interrupter			
		1P 120 Vac		2P Common Trip 120/240 Vac	3P Common Trip 208Y/120 Vac
		10 k AIR 1 Space Required	22 k AIR 1 Space Required	10 k AIR 2 Spaces Required	10 k AIR 3 Spaces Required
Ground-Fault Circuit Interrupter (Pigtail Neutral)	15	QO115GFI	QO115VHGFI	QO215GFI	QO315GFI
	20	QO120GFI	QO120VHGFI	QO220GFI	QO320GFI
	25	—	—	QO225GFI	—
	30	QO130GFI	QO130VHGFI OBS	QO230GFI	QO330GFI
	35	—	—	QO235GFI	—
	40	—	—	QO240GFI	QO340GFI
	45	—	—	QO245GFI	—
	50	—	—	QO250GFI	QO350GFI
Plug-On Neutral Ground-Fault Circuit Interrupter	15	QO115PGFI [18]	—	—	—
	20	QO120PGFI [18]	—	—	—

OBS This product is obsolete.

[14] UL Listed as HACR type for use with air conditioning, heating and refrigeration equipment haing motor group combinations and marked for use with HACR type circuit breakers.

[15] For 120/240 V only, not for 208Y/120 V.

[16] 10–30 A circuit breakers are suitable for use with 60°C or 75°C conductors. 35–60 A circuit breakers are suitable for use with 75°C conductors.

[17] Suitable only for feeding 240 Vac and 208 Vac two-wire loads. Does not contain load neutral connection.

[18] New Plug-On Neutral

**QO-EPD/EPE Circuit Breakers**

QO-EPD/EPE circuit breakers provide overload and short circuit protection combined with Class B ground fault protection. They are designed to provide ground fault protection of equipment at a 30 mA level (EPD) or 100 mA level (EPE). They are not designed to protect people from electrical shock.



QO 1P With Shunt Trip

**Table 7.9: QO-EPD Circuit Breakers**

Ampere Rating [19]	1P 120 Vac 10 k AIR 1 Space Required	2P Common Trip 120/240 Vac 10 k AIR 2 Spaces Required	3P Common Trip 240 Vac 10 k AIR 3 Spaces Required	
15	QO115EPD	QO215EPD	QO315EPD <sup>OBS</sup>	QO315EPE [20]
20	QO120EPD	QO220EPD	QO320EPD [20]	QO320EPE [20]
25	QO125EPD <sup>OBS</sup>	QO225EPD	—	—
30	QO130EPD	QO230EPD	QO330EPD [20]	QO330EPE [20]
40	—	QO240EPD	QO340EPD [20]	QO340EPE [20]
50	—	QO250EPD	QO350EPD [20]	QO350EPE [20]
60	—	QO260EPD [21]	—	—

<sup>OBS</sup> This product is obsolete.

**QO Switch Neutral Common Trip Circuit Breakers (QO-SWN)**

Switch Neutral Common Trip 2008 NEC® 514.11



Two-wire QO-SWN



Three-wire QO-SWN

**Table 7.10: QO-SWN Circuit Breakers**

Ampere Rating [22]	2 Wire 120 Vac 10 k AIR 2 Spaces Required	3 Wire 120/240 Vac 10 k AIR 3 Spaces Required
10	QO210SWN <sup>OBS</sup>	QO310SWN
15	QO215SWN	QO315SWN <sup>OBS</sup>
20	QO220SWN	QO320SWN
25	QO225SWN <sup>OBS</sup>	QO325SWN
30	QO230SWN <sup>OBS</sup>	QO330SWN <sup>OBS</sup>
40	QO240SWN <sup>OBS</sup>	QO340SWN <sup>OBS</sup>
50	QO250SWN <sup>OBS</sup>	QO350SWN <sup>OBS</sup>

<sup>OBS</sup> This product is obsolete.

**QO High Intensity Discharge Circuit Breakers (QO-HID)**

HID circuit breakers are for use on circuits feeding fluorescent and high intensity discharge (HID) lighting systems such as mercury vapor, metal halide, or high pressure sodium. These circuit breakers are physically interchangeable with QO circuit breakers.

**Table 7.11: QO-HID Circuit Breakers**

Ampere Rating [22]	1P 120/240 Vac 10 k AIR 1 Space Required	2P Common Trip 120/240 Vac 10 k AIR 2 Spaces Required	3P Common Trip 240 Vac 10 k AIR 3 Spaces Required
15	QO115HID <sup>OBS</sup>	QO215HID <sup>OBS</sup>	QO315HID <sup>OBS</sup>
20	—	QO220HID	QO320HID
25	QO125HID <sup>OBS</sup>	QO225HID <sup>OBS</sup>	QO325HID <sup>OBS</sup>
30	QO130HID <sup>OBS</sup>	QO230HID <sup>OBS</sup>	QO330HID <sup>OBS</sup>
40	QO140HID <sup>OBS</sup>	QO240HID <sup>OBS</sup>	—
50	QO150HID <sup>OBS</sup>	QO250HID <sup>OBS</sup>	—

<sup>OBS</sup> This product is obsolete.

**QO Key Operated Circuit Breakers (QO-K)**

Key operated QO circuit breakers are available in single-pole construction and can be mounted in any single-pole space which will accept a standard QO circuit breaker. These circuit breakers can be turned ON or OFF or to RESET with a special key (catalog number QOK10) included with the circuit breaker. These circuit breakers are UL Listed and available as shown in the table.



QO-K Key Operated

**Table 7.12: QO-K Circuit Breakers**

120 Vac—10 k AIR (1 Space Required)			
Ampere Rating [22]	Cat. No.	Ampere Rating [22]	Cat. No.
10	QO110K <sup>OBS</sup>	25	QO125K
15	QO115K <sup>OBS</sup>	30	QO130K <sup>OBS</sup>
20	QO120K <sup>OBS</sup>	—	—

<sup>OBS</sup> This product is obsolete.

[19] 10–30 A circuit breakers are suitable for use with 60°C or 75°C conductors. 35–60 A circuit breakers are suitable for use with 75°C conductors.  
 [20] See note in Instruction Bulletin when using in an enclosure with a QO403 or QON prefix.  
 [21] Suitable only for feeding 240 Vac and 208 Vac two-wire loads. Does not contain load neutral connection.  
 [22] 10–30 A circuit breakers are suitable for use with 60°C or 75°C conductors. 35–60 A circuit breakers are suitable for use with 75°C conductors.

### QO High Magnetic Trip Circuit Breakers (QO-HM)

High magnetic trip circuit breakers are recommended for applications where high initial inrush may occur and for individual dimmer applications.

**Table 7.13: QO-HM Circuit Breakers**

Ampere Rating [23]	120 Vac—10 k AIR	
	1P	
15 A	QO115HM [24] [25]	
20 A	QO120HM [24] [25]	

### Non-Automatic (Standard) Miniature Switches

Miniature non-automatic switches have the same physical packaging as miniature circuit breakers, but open only when the handle is switched to the OFF position.

Non-automatic switches provide no overcurrent protection or short circuit protection. They must not be used on systems that have an available fault current greater than the values listed in the table. Non-automatic switches are UL Listed per UL 1087 and are CSA certified.

**Table 7.14: QO Non-Automatic Miniature Switches, 240 Vac 10 kA**

Ampere Rating	2P	3P
60	QO200	QO300
100	QO2000 <sup>OBS</sup>	QO3000

<sup>OBS</sup> This product is obsolete.

[23] 10–30 A circuit breakers are suitable for use with 60oC or 75oC conductors. 35–60 A circuit breakers are suitable for use with 75oC conductors.

[24] UL Listed as HACR type for use with air conditioning, heating and refrigeration equipment having motor group combinations and marked for use with HACR type circuit breakers.

[25] UL Listed as SWD (switching duty) rated. Suitable for switching 120 Vac fluorescent lighting loads.

Accessories for QO/QOB Circuit Breakers

Table 7.15: Accessories for use with QO and QOB Miniature Circuit Breakers

Description		Cat. No.	Schedule
<b>Handle Attachments</b>			
Handle Tie	Converts any two adjacent 120/240 Vac 1P QO circuit breakers to independent trip 2P Converts any two adjacent 120/240 Vac1P side-by-side QOT circuit breakers to independent trip 2P	QO1HT QOTHT QO3HT	DE2E DE2E
Handle Clamp	Clamp for holding QO 1P handle in ON or OFF position Clamp for holding QO or Q1 either 1P, 2P or 3P circuit breaker handles in ON or OFF position	QO1LO HLO1	DE2E DE2E
Handle Padlock Attachment for Padlocking in ON or OFF position	For padlocking 1P QO circuit breaker in ON or OFF position Loose attachment	QOHPL QO1PA	DE2E DE2E
	Fixed attachment	QOTHPA <sup>obs</sup>	DE2E
	For padlocking 1P side-by-side QOT circuit breaker in ON or OFF position	QO1PAF	DE2E
	For padlocking 2P QO-GFI circuit breakers in either ON or OFF position, fixed attachment.	GFI2PA	DE2A
Handle Padlock Attachment for Padlocking in OFF position	For 2P and 3P QO and Q1 standard circuit breakers which require padlocking in either ON or OFF position. Loose attachment	QO1HPL QO1PL	DE2E DE2E
	Fixed attachment	QO1PAF	DE2E
	For padlocking 1P QO circuit breaker in OFF position only, fixed attachment.	QO2PAF	DE2E
	For padlocking 2P and 3P QO circuit breakers in OFF position only, fixed attachment.	QOGF1PAF QOGF12PAF	DE2E DE2E
Ring Terminal	Ring terminals are available as a factory-installed option.	See Section 7	DE2A
Sub-feed Lugs	60 A 2P plug-on – 2 spaces required (6–2 Al/Cu) 125 A 2P plug-on – 2 spaces required (12–2/0 Al/Cu) 225 A 2P plug-on – 4 spaces required (4–300 Al/Cu) 125 A 3P plug-on – 3 spaces required (12–2/0 Al/Cu)	QO60SL <sup>obs</sup> QO2125SL QO2225SL [26] QO3125SL	DE2A DE2A DE2A DE3
Mechanical Interlock Attachment	For interlocking the handles of two 2P or one 2P and one 1P QO and Q1 circuit breakers mounted side-by-side so that only one circuit breaker can be ON at a time (Not QOU)	QO2DTI	DE2E
With Retaining Kit	QO2DTI mechanical interlock attachment with retaining kits for securing two adjacent back-fed circuit breakers in dual power supply applications. Can be used with (2) 2Ps or (1) 2P and (1) 1P QO circuit breakers in QO816L100 load centers.	QO2DTIM	DE2E

<sup>obs</sup> This product is obsolete.



QO1PA



QO1PL



QO1HT



HLO1



QO1PAF



QO2DTI



QO1HPL



QOTHPA



QO1LO



QOHPL



QO2PAF



QOGF12PAF

Factory-Installed Accessories for QO and QOB Miniature Circuit Breakers

Factory-installed electrical accessories take up an additional pole space on QO, QO-GFI, QO-EPD, QO-SWN and QOU circuit breakers. All AC electrical accessories shown below are rated for 50/60 Hz. Accessories are not available for QOB-VH (2P 150 A and 3P 110–150 A) circuit breakers or QO, QOU molded case switches. QO circuit breakers will accept only one accessory per circuit breaker. Undervoltage trip is not available on

[26] Not suitable for use in 3Ø panels. Use only in 1Ø panel rated 150 A or greater.

miniature circuit breakers. Factory-installed accessories are not available for QO-AFI or QO-CAFI Arc Fault Circuit Breakers, QO-CAFI, QO-DF, or QO-PDF circuit breakers, or on QO2150, QO2175, or QO2200 circuit breakers.

Table 7.16: Factory-Installed Accessories for QO/QOB Circuit Breakers

Accessory	Description	Rated Voltage	Coil Burden	Cat. No. Suffix	Accessory	Description	Contact Comb.	Max. Voltage	Max.	Cat. No. Suffix
Shunt Trip	Trips the circuit breaker from a remote location by means of a trip coil energized from a separate circuit. A 120 Vac shunt trip will operate at 55% or more of rated voltage. All other shunt trips will operate at 75% or more of rated voltage. <b>Application</b> <ul style="list-style-type: none"> <li>For use with momentary or maintained push button.</li> <li>Not available on QO-GFI, QO-EPD, QO-AFI, QO-CAFI, QO-DF, or QO-PDF.</li> <li>Shunt trip terminals accept (2) 0.14–0.12 AWG Cu.</li> </ul>	12 Vac/Vdc 24 Vac/Vdc	60 VA 168 VA	-1042	Auxiliary Switches	Monitors circuit breaker contact status and provides a remote signal indicating the circuit breaker contacts are OPEN or CLOSED. <b>Application</b> <ul style="list-style-type: none"> <li>Auxiliary switch terminals accept (2) 14–12 AWG Cu leads.</li> <li>Leads (EH): Yellow for "A", Blue for "B", Striped common 18 AWG Cu.</li> </ul>	1A 1B	120 Vac 120 Vac	5 A 5 A	-1200 -1201
		120 Vac 208 Vac 240 Vac	72 VA 228 VA 288 VA	-1021	Alarm Switches	Used with control circuits and is actuated only when the circuit breaker has tripped. Standard construction includes a normally-open contact. <b>Application</b> <ul style="list-style-type: none"> <li>Leads: Alarm switch terminals accept (2) 14–12 AWG Cu leads.</li> </ul>	1A	120 Vac	5 A	-2100

QO Mounting Bases

Table 7.17: QO OEM Mounting Bases—UL Recognized Components

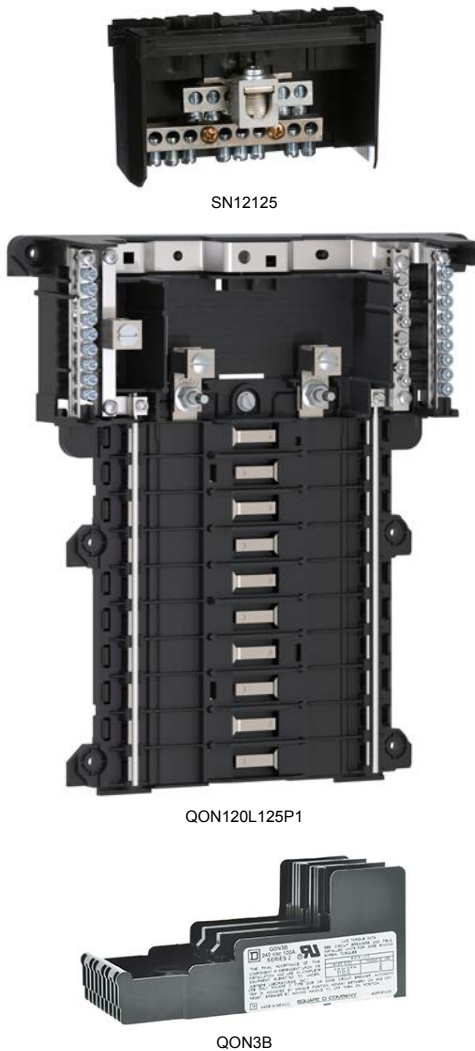

Voltage System	Main Lug Rating	Spaces	Max. No. 1P Circuits	Mounting Bases Cat. No.	Main Wire Size AWG/kcmil
<b>QO Plug-On Mounting Bases—Accepts Only QO Plug-On Circuit Breakers - Not Compatible With QO Plug-On Neutral Circuit Breakers</b>					
1Ø2W 240 Vac Max. 10 k AIC (Without Neutral Assembly)	70 A	2	2	QON2L70	14–4 Cu, 12–3 Al
	125 A	4	4	SK9948BW	12–1/0 Cu/Al
	125 A	4	4	SK9842	12–1/0 Cu/Al
	125 A	6	6	SK9795	12–1/0 Cu/Al
	125 A	6	6	SK9801	12–1/0 Cu/Al
	150 A	6	6	SK9796BW	8–3/0 Cu/Al
	150 A	8	8	SK9797	8–3/0 Cu/Al
<b>QO Plug-On Mounting Bases—Accepts Only QO Plug-On Circuit Breakers - Not Compatible With QO Plug-On Neutral Circuit Breakers</b>					
1Ø3W 240 Vac Max. 10 k AIC	40 A	2	2	QON2L40	14–6 Cu, 12–6 Al
	70 A	2	4	QON24L70	14–4 Cu, 12–3 Al
	100 A	6	12	QON612L100	8–1/0 Cu/Al
	100 A	8	16	QON816L100	8–1/0 Cu/Al
<b>QO Plug-On Neutral Mounting Bases - Compatible with QO Plug-On Circuit Breakers and QO Plug-On Neutral Circuit Breakers</b>					
1Ø3W 240 Vac Max. 10 k AIC	125 A	12	24	QON112L125PI	4–2/0 Cu/Al
	125 A	20	24	QON120L125PI	4–2/0 Cu/Al
	200 A	12	24	QON112L200PI	4–250 Cu/Al
	200 A	24	36	QON124L200PI	4–250 Cu/Al
	200 A	24	36	QON124L200PDL	(2) 4–300 Cu/Al
	200 A	30	40	QON130L200PI	4–250 Cu/Al
	225 A	42	52	QON142L225PI	4–300 Cu/Al
	225 A	52	72	QON154L225P	4–300 Cu/Al
225 A	60	72	QON160L225P	4–300 Cu/Al	
<b>QO Plug-On Mounting Bases—Accepts Only QO Plug-On Circuit Breakers - Not Compatible With QO Plug-On Neutral Circuit Breakers</b>					
3Ø3W 240 Vac Max. 10 k AIC (Without Neutral Assy.)	125 A	12	12	QON312L125	4–2/0 Cu/Al
	125 A	20	20	QON320L125	4–2/0 Cu/Al
	125 A	24	24	QON324L125	4–2/0 Cu/Al
	200 A	18	18	QON318L200	4–300 Cu/Al
	200 A	24	24	QON324L200	4–300 Cu/Al
	200 A	30	30	QON330L200	4–300 Cu/Al
	225 A	42	42	QON342L225	4–300 Cu/Al
<b>QO Plug-On Mounting Bases—Accepts Only QO Plug-On Circuit Breakers - Not Compatible With QO Plug-On Neutral Circuit Breakers</b>					
3Ø4W 240 Vac Max. 10 k AIC	60 A	3	3	QON403L60N	12–6 Cu/Al
	125 A	12	12	QON312L125I	4–2/0 Cu/Al
	125 A	20	20	QON320L125I [27]	4–2/0 Cu/Al
	125 A	24	24	QON324L125I	4–2/0 Cu/Al
	200 A	18	18	QON318L200I	4–300 Cu/Al
	200 A	24	24	QON324L200I	4–300 Cu/Al
	200 A	30	30	QON330L200I [27]	4–300 Cu/Al
	225 A	42	42	QON342L225I	4–300 Cu/Al
<b>QO Plug-On Mounting Bases—Accepts Only QO Plug-On Circuit Breakers - Not Compatible With QO Plug-On Neutral Circuit Breakers</b>					
1Ø2W 240 Vac Max. 10 k AIC (Without Neutral Assembly)	70 A	1	1	QOMB1	14–4 Cu 12–2 Al
	70 A	2	2	QOMB2	14–4 Cu 12–2 Al
	70 A	3	3	QOMB3	14–4 Cu 12–2 Al
<b>QOB Bolt-On Mounting Bases—Accepts only QOB Bolt-On Circuit Breakers</b>					
3Ø3W 240 Vac Max. 10 k AIC (Without Neutral Assembly)	100 A	3	3	QON3B	12–1 Cu/Al

MINIATURE AND MOLDED CASE CIRCUIT BREAKERS

[27] Also IEC rated and CE marked for IEC 60439-1. Use only Square D brand Type QOXC, QOXD, QOHX and QOE circuit breakers for 415Y/240 Vac max. systems.

**Table 7.18: Solid Neutral Assemblies**

Main Lug Rating	Number of Branch Neutral Terminals	Cat. No.	Main Neutral Lug Wire Size Cu/Al	Branch Neutral Terminal Wire Size	
				Cu	Al
125 A	12	SN12125	4-2/0 AWG	14-4 AWG	12-4 AWG
125 A	20	SN20	4-2/0 AWG	14-4 AWG	12-4 AWG
200 A	12	SN12200	4 AWG-300 kcmil	14-4 AWG	12-4 AWG
200 A	30	SN30	4 AWG-300 kcmil	14-4 AWG	12-4 AWG
225 A	42	SN42	4 AWG-300 kcmil	14-4 AWG	12-4 AWG

**Table 7.19: Accessories for US Mounting Base for UL489 C60**

Description	Cat. No.
Main lug kit for US mounting bases, 1 lug per kit, for 6 AWG to 300 kcmil cable	USMBLK
Terminal cover for US mounting base; provides IP20 ingress protection per IEC 60529; suitable for jumper bars or cable	USMBTC

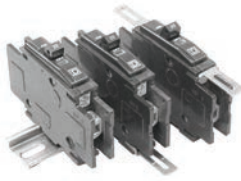

Low Ampere QOU

**Low Ampere QOU Miniature Circuit Breakers**

QOU unit mount miniature circuit breakers (cable-in/cable-out) are ideal for OEM applications. They have the Square D™ circuit breaker's unique Visi-Trip™ feature and can be DIN rail-mounted or surface- or flush-mounted using mounting feet. Mounting feet not provided [28].

**General Specifications Common to All Low Ampere QOU Circuit Breakers**

- For convenient flush mount, surface mount or DIN mount (symmetrical rail 35 x 7.5 DIN/EN 50 022)
- Single handle with internal common trip
- Terminal lug wire size (1) 14–2 AWG Cu or Al
- Reversible line and load lugs
- Field-installable quick connectors
- UL Listed 48 Vdc (5 k AIR)
- UL Listed as HACR Type: 10–70 A
- High magnetic trip circuit breakers (QOU-HM) are recommended for applications where high initial inrush may occur and for individual dimmer applications.
- For DIN mounting rails, see IEC Starters and Relays, Section 18.

**Table 7.20: QOU Low Ampere Miniature Circuit Breakers**

Ampere Rating	Cat. No.			
	1P 120/240 Vac	2P 120/240 Vac	2P 240 Vac [29]	3P 240 Vac
<b>10 k AIR</b>				
10 A	QOU110	QOU210	—	QOU310
15 A	QOU115	QOU215	QOU215H	QOU315
20 A	QOU120	QOU220	QOU220H	QOU320
25 A	QOU125	QOU225	QOU225H OBS	QOU325
30 A	QOU130	QOU230	QOU230H	QOU330
35 A	QOU135	QOU235	—	QOU335
40 A	QOU140	QOU240	—	QOU340
45 A	QOU145 OBS	QOU245	—	QOU345
50 A	QOU150	QOU250	—	QOU350
60 A	QOU160	QOU260	—	QOU360
70 A	QOU170	QOU270	—	QOU370
<b>22 k AIR</b>				
15 A	QOU115VH	QOU215VH	—	QOU315VH OBS
20 A	QOU120VH	QOU220VH	—	QOU320VH
25 A	QOU125VH OBS	QOU225VH OBS	—	QOU325VH OBS
30 A	QOU130VH	QOU230VH	—	QOU330VH
35 A	QOU135VH OBS	QOU235VH OBS	—	—
40 A	QOU140VH OBS	QOU240VH OBS	—	—
45 A	QOU145VH OBS	QOU245VH OBS	—	—
50 A	QOU150VH OBS	QOU250VH	—	—
60 A	QOU160VH	QOU260VH	—	—

<sup>OBS</sup> This product is obsolete.

**Table 7.21: QOU-HM Miniature Circuit Breakers (10 k AIR)**

Ampere Rating	Cat. No.			
	1P 120/240 Vac	2P 120/240 Vac	2P 240 Vac	3P 240 Vac
15 A	QOU115HM	—	—	—
20 A	QOU120HM	—	—	—

**Table 7.22: QYU UL1077 Recognized Supplementary Protectors (5 k AIR)**

Ampere Rating	Cat. No.			
	1P 277 Vac	2P 120/240 Vac	2P 240 Vac	3P 240 Vac
10 A	QYU110 OBS	—	—	—
15 A	QYU115 OBS	—	—	—
20 A	QYU120 OBS	—	—	—
25 A	QYU125 OBS	—	—	—
30 A	QYU130 OBS	—	—	—

<sup>OBS</sup> This product is obsolete.

[28] See QOU Accessories, page 7-21.  
[29] QOU-H interrupting rating is 10 kA at 240 Vac.



Class 720 / Refer to Catalog 0730CT9801

**High Ampere QOU Circuit Breakers**

**General Specifications Common to All High Ampere QOU Circuit Breakers**

- Flush mount, surface mount, and DIN rail mount.
- Internal common trip.
- Non-reversible line and load lugs.
- Terminal lug wire size (1) 12– 2/0 AWG Cu or Al.
- UL Listed 60 Vdc per pole (5 k AIR). (**Note:** except switches)
- UL Listed as HACR type, 80–125 A.
- Non-automatic switches have the same physical packaging as miniature circuit breakers, but provide no overcurrent or short circuit protection. They are UL Listed per UL1087 and are CSA certified.



High Ampere QOU

**Table 7.23: QOU High Ampere Miniature Circuit Breakers (10 k AIR)**

Ampere Rating	Cat. No.			
	1P 120/240 Vac	2P 120/240 Vac	2P 240 Vac	3P 240 Vac
80 A	QOU180	QOU280	—	QOU380
90 A	QOU190 <sup>OBS</sup>	QOU290	—	QOU390
100 A	QOU1100	QOU2100	—	QOU3100
125 A	—	QOU2125	—	—

<sup>OBS</sup> This product is obsolete.

**Table 7.24: QOU Non-Automatic Switches**

Ampere Rating	Cat. No.			
	1P 120 Vac	2P 120/240 Vac	2P 240 Vac	3P 240 Vac
60 A	—	—	QOU200	QOU300
100 A	—	—	QOU2000 <sup>OBS</sup>	QOU3000 <sup>OBS</sup>
125 A	—	—	QOU20001	QOU30001 <sup>OBS</sup>

<sup>OBS</sup> This product is obsolete.

Interrupting ratings see [page 7-3](#)

Accessories see [page 7-21](#)

Dimensions see [page 7-86](#)

**QOU Accessories**

**Table 7.25: Accessories for QOU Low Ampere Circuit Breakers (Except as Noted)**

Description	Order Qty.	Cat. No.
Factory-installed ring tongue terminal, 10–32 screw, for 1P, 2P, 3P QOU, 10–60 A	—	Suffix -5283
Hex drive 5/32 in. wire binding screw for QOU	—	Suffix -5280
For padlocking 1P low ampere QOU circuit breaker in OFF or ON position	—	QOU1PA <sup>OBS</sup>
For padlocking 2P and 3P low ampere QOU circuit breaker in OFF or ON position	—	QOU1PL
For padlocking 1P low ampere QOU circuit breaker in OFF position only	—	QOU1PAFLA
For padlocking 2P and 3P low ampere QOU circuit breaker in OFF position only	—	QOU2PAFLA
For padlocking 2P and 3P high ampere QOU circuit breaker in OFF position only	—	Suffix -7100
Handle lock-out, ON or OFF position	—	HLO1
4P 100 A Jumper bar assy. w/front wiring with base, cover and screw	1	QOU14100JBAF
4P 100 A Jumper bar assy. w/right side wiring with base, cover and screw	1	QOU14100JBAR <sup>OBS</sup>
4P 100 A Jumper bar assy. w/left side wiring with base, cover and screw	1	QOU14100JBAL
1Ø, 4P, 100 A Jumper bar base with front wiring	40	QOU14100BAFB
1Ø, 4P, 100 A Jumper bar base with left side wiring	40	QOU14100BALB
1Ø, 4P, 100 A Jumper bar base with right side wiring	40	QOU14100BARB
4P Jumper bar cover	40	QOU14100CAB
Mounting screw for jumper bar cover	40	QOU1CMSB <sup>OBS</sup>
6P 150 A Jumper bar assy. w/front wiring with base, cover and screw	1	QOU16150JBAF
1Ø, 6P, 150 A Jumper bar base with front wiring	40	QOU16150BAFB
1Ø, 6P, 150 A Jumper bar base with left side wiring	40	QOU16150BALB <sup>OBS</sup>
1Ø, 6P, 150 A Jumper bar base with right side wiring	40	QOU16150BARB <sup>OBS</sup>
6P jumper bar cover	40	QOU16150CAB <sup>OBS</sup>
Vertical rainproof cover 2P and 3P QO, QOU, FA and KA	1 10	BCV [30] BCVB <sup>OBS</sup>
Horizontal rainproof cover 2P QO, QOU, and 3P Q2, EH	1 10	BCH [30] BCHB [30]
1P Fingersafe™ cover for high ampere QOU circuit breaker	1 40	QOUHFSC1 QOUHFSC1B <sup>OBS</sup>
1P Fingersafe cover for low ampere QOU circuit breaker	1 40	QOULFSC1 QOULFSC1B
Cover plate for one 2P QOU circuit breaker	1 40	QOUCP2 <sup>OBS</sup> QOUCP2B
Cover plate for one 3P QOU circuit breaker	1 40	QOUCP3 <sup>OBS</sup> QOUCP3B
Cover plate for two 2P QOU circuit breakers	1 40	QOUCP4 <sup>OBS</sup> QOUCP4B
Cover plate for three 2P QOU circuit breakers	1 40	QOUCP6 <sup>OBS</sup> QOUCP6B
Field-installable ring tongue terminal adaptor	1 80	QOURT QOURTB
Quick connector end connection wiring	1 40	QOUEC QOUECB
Quick connector forward or reverse wiring	1 40	QOUFR <sup>OBS</sup> QOUFRB
1P QOU mounting foot	1 80	QOUMF1 [30] QOUMF1B [30]
2P QOU mounting foot	1 40	QOUMF2 [30] QOUMF2B [30]
3P QOU mounting foot	1 24	QOUMF3 <sup>OBS</sup> QOUMF3B [30]
Tapped mounting foot for QOU, 1P and 2P 10–70 A, 3P 10–60 A		
Packaged with circuit breaker		Suffix -3100
Individually packaged	1	QOUMFS1
Bulk packed	80	QOUMFS1B <sup>OBS</sup>
Mechanical interlock attachment: Used to interlock two circuit breakers mounted side-by-side so that only one circuit breaker can be ON at a time. A 1P or 2P circuit breaker can be mounted on the left and interlocked with a 2P or 3P circuit breaker on the right.	1	QOU2DTILA [31]

<sup>OBS</sup> This product is obsolete.

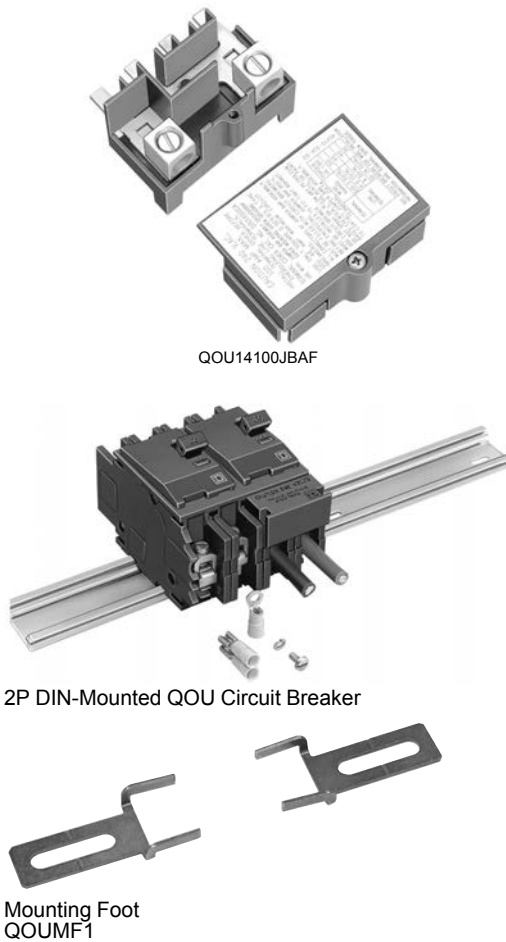

**QOUQ Low Ampere Circuit Breakers**

QOUQ low ampere circuit breakers with four-point quick-connect terminals are provided with permanent factory-installed terminals which are affixed to the Load or OFF end of the circuit breaker. This special terminal will accommodate up to four 1/4-inch insulated female quick connect wire terminations. Total ampacity of these connections must not exceed the rating of the circuit breaker.

**Table 7.26: QOUQ Four-Point Quick-Connect Terminals**

	Poles	Order Qty.	Cat. No.
Four-Point Quick-Connect Terminals	1	1	Change QOU to QOUQ
	2	1	
	3	1	

The QOU uses the same electrical accessories as the QO. See the QO information for available electrical accessories.

[30] For use on low and high ampere QOU.  
[31] 10–70 A 1P and 2P, 10–60 A 3P.

### Homeline Standard Plug-On Circuit Breakers

The Square D Homeline circuit breakers are in a 1 in. wide format for 1-pole circuit breakers. They are designed to plug into Homeline load centers.

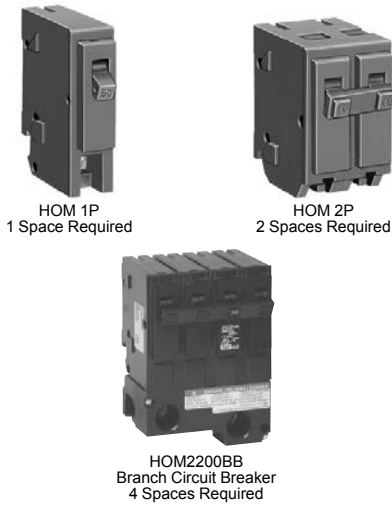

Table 7.27: Standard HOM Plug-on Circuit Breakers

Ampere Rating	AIR	1P—120 Vac, 1 Space Required	2P—120/240 Vac Common Trip 2 Spaces Required.
15 A	10 kA	HOM115 [1][2]	HOM215 [2]
20 A	10 kA	HOM120 [1][2]	HOM220 [2]
25 A	10 kA	HOM125 [2]	HOM225 [2]
30 A	10 kA	HOM130 [2]	HOM230 [2]
35 A	10 kA	—	HOM235 [2]
40 A	10 kA	HOM140 [2]	HOM240 [2]
45 A	10 kA	—	HOM245 [2]
50 A	10 kA	HOM150 [2]	HOM250 [2]
60 A	10 kA	—	HOM260 [2]
70 A	10 kA	—	HOM270 [2]
80 A	10 kA	—	HOM280 [2]
90 A	10 kA	—	HOM290 [2]
100 A	10 kA	—	HOM2100 [2]
110 A	10 kA	—	HOM2110 [2]
125 A	10 kA	—	HOM2125 [2]
150 A	10 kA	—	HOM2150BB [2][3]
175 A	10 kA	—	HOM2175BB [2][3]
200 A	10 kA	—	HOM2200BB [2][3]

### Homeline High Magnetic Circuit Breakers (HOM-HM)

High magnetic trip circuit breakers are recommended for applications where high initial inrush current may occur.

Table 7.28: HOM-HM Circuit Breakers

Amperes	1P—120/240 Vac	2Ps
15 A	HOM115HM <sup>Obs</sup>	—
20 A	HOM120HM [2]	—

<sup>Obs</sup> This product is obsolete.

### Homeline Combination Arc Fault Circuit Interrupters (HOM-CAFI)

Homeline Combination Arc Fault Circuit Interrupters—Provide overload and short circuit protection, plus arc fault protection in accordance with the NEC and UL1699.

Table 7.29: HOM-CAFI Circuit Breakers

Circuit Breaker Type	Ampere Rating	Poles 120 Vac	Cat. No.
<b>One-Pole</b>			
Combination Arc-Fault Circuit Interrupter with Pigtail Neutral	15 A	1	HOM115CAFI [2]
	20 A	1	HOM120CAFI [2]
Plug-On Neutral Combination Arc-Fault Interrupter	15 A	1	HOM115PCAFI [2]
	20 A	1	HOM120PCAFI [2]
<b>Two-Pole</b>			
Combination Arc-Fault Circuit Interrupter with Pigtail Neutral	15 A	2	HOM215CAFI [2] [4]
	20 A	2	HOM220CAFI [2] [4]



### Homeline Dual Function Circuit Breaker (HOM-DF)

Homeline Combination Arc Fault and Ground Fault Circuit Interrupters (Dual Function)—Provide overload and short circuit protection, plus arc fault and ground fault protection in a single device in accordance with the NEC, UL1699 and UL943.

Table 7.30: HOM-DF Circuit Breakers

Circuit Breaker Type	Ampere Rating	Poles 120 Vac	Cat. No.
Combination Arc-Fault and Ground Fault Circuit Interrupter with Pigtail Neutral	15 A	1	HOM115DF [2]
	20 A	1	HOM120DF [2]
Plug-On Neutral Combination Arc-Fault and Ground Fault Circuit Interrupter	15 A	1	HOM115PDF [2]
	20 A	1	HOM120PDF [2]



[1] UL Listed as SWD (switching duty) rated. Suitable for switching 120 Vac fluorescent lighting loads.  
 [2] UL Listed as HACR type for use with air conditioning, heating and refrigeration equipment having motor group combinations and marked for use with HACR type circuit breakers.  
 [3] Requires four spaces (1 AWG–300 kcmil Al/Cu). Use only in 1Ø panel rated 150 A or greater.  
 [4] For 120/240 V only, not for 208Y/120 V.

**Homeline Ground-Fault Circuit Breaker (HOM-GFI)**

HOM-GFI circuit breakers provide overload and short circuit protection, combined with Class A ground fault protection. Class A denotes a ground fault circuit interrupter that will trip when a fault current to ground is 6 milliamperes or more.



HOM 1P GFI  
(With Ground Fault  
Circuit Interrupter)  
1 Space Required



HOM 2P GFI  
(With Ground Fault  
Circuit Interrupter)  
2 Spaces Required

**Table 7.31: HOM-GFI Circuit Breakers**

Circuit Breaker Type	Ampere Rating	AIR	1P—120 Vac 1 Space Required	2P—120/240 Vac Common Trip 2 Spaces Required
Ground-Fault Circuit Interrupter (Pigtail Neutral)	15 A	10 kA	HOM115GFI	HOM215GFI
	20 A	10 kA	HOM120GFI	HOM220GFI
	25 A	10 kA	—	HOM225GFI
	30 A	10 kA	—	HOM230GFI
	35 A	10 kA	—	HOM235GFI
	40 A	10 kA	—	HOM240GFI
	45 A	10 kA	—	HOM245GFI
	50 A	10 kA	—	HOM250GFI
Plug-On Neutral Ground-Fault Circuit Interrupter	15 A	10 kA	HOM115PGFI <sup>[5]</sup>	—
	20 A	10 kA	HOM120PGFI <sup>[5]</sup>	—

**Homeline Equipment Protection Device (HOM-EPD)**

Homeline Equipment Protection Device—Circuit Breakers with 30 mA Equipment Ground Fault Protection (UL Listed).

**Table 7.32: HOM-EPD Circuit Breakers**

Amperes	1P—120 Vac	2P—120/240 Vac Common Trip
15 A	HOM115EPD	HOM215EPD <sup>OBS</sup>
20 A	HOM120EPD	HOM220EPD
25 A	—	HOM225EPD
30 A	—	HOM230EPD
40 A	—	HOM240EPD
50 A	—	HOM250EPD

<sup>OBS</sup> This product is obsolete.

**Homeline Tandem and Quad Tandem Circuit Breakers (HOMT)**

**Table 7.33: HOMT Tandem Circuit Breakers**

Ampere Rating <sup>[6]</sup>	AIR	1P Tandem—120/240 Vac (One Space Required)
15 and 15 A	10 kA	HOMT1515 <sup>[7]</sup>
15 and 20 A	10 kA	HOMT1520 <sup>[7]</sup>
20 and 20 A	10 kA	HOMT2020 <sup>[7]</sup>
30 and 15 A	10 kA	HOMT3015 <sup>[7]</sup>
30 and 20 A	10 kA	HOMT3020 <sup>[7]</sup>

**Table 7.34: HOMT Quad Tandem 1P Circuit Breakers**



HOMT Quad  
Circuit Breaker  
2 Spaces Required

Ampere Rating <sup>[6]</sup>		AIR	2P Tandem—120/240 Vac (Two Spaces Required)
1P	2P		
(2) 15 A	15 A	10 kA	HOMT1515215
(2) 15 A	20 A	10 kA	HOMT1515220
(2) 15 A	25 A	10 kA	HOMT1515225 <sup>OBS</sup>
(2) 15 A	30 A	10 kA	HOMT1515230
(2) 15 A	40 A	10 kA	HOMT1515240
(2) 15 A	50 A	10 kA	HOMT1515250
(2) 20 A	20 A	10 kA	HOMT2020220
(2) 20 A	25 A	10 kA	HOMT2020225
(2) 20 A	30 A	10 kA	HOMT2020230
(2) 20 A	40 A	10 kA	HOMT2020240
(2) 20 A	50 A	10 kA	HOMT2020250

<sup>OBS</sup> This product is obsolete.

**NOTE:** Typical catalog no. (e.g. HOMT 1515230) represents two 1P, outer poles (two 15 A 1P CBs) and one 2P inner circuit breaker with common trip (one 30 A 2P CB).

**Table 7.35: HOMT Quad Tandem 2P Circuit Breakers**

Ampere Rating <sup>[6]</sup>		AIR	(2) 2P Tandem—120/240 Vac (Two Spaces Required)
2P	2P		
15 A	15 A	10 kA	HOMT215215
15 A	20 A	10 kA	HOMT215220
15 A	25 A	10 kA	HOMT215225
15 A	30 A	10 kA	HOMT215230
15 A	40 A	10 kA	HOMT215240
15 A	50 A	10 kA	HOMT215250
20 A	20 A	10 kA	HOMT220220
20 A	25 A	10 kA	HOMT220225
20 A	30 A	10 kA	HOMT220230
20 A	40 A	10 kA	HOMT220240
20 A	50 A	10 kA	HOMT220250
25 A	25 A	10 kA	HOMT225225
25 A	30 A	10 kA	HOMT225230
25 A	40 A	10 kA	HOMT225240
25 A	50 A	10 kA	HOMT225250

[5] New Plug-on Neutral

[6] 15–20 A tandem or quad tandem circuit breakers are suitable for use with 60°C or 75°C conductors. 25–50 A tandem or quad tandem circuit breakers are suitable for use with 75°C conductors only.

[7] UL Listed as HACR type for use with air conditioning, heating and refrigeration equipment having motor group combinations and marked for use with HACR type circuit breakers.

Table 7.35 HOMT Quad Tandem 2P Circuit Breakers (cont'd.)

Ampere Rating [8]		AIR	(2) 2P Tandem—120/240 Vac (Two Spaces Required)
2P	2P		
30 A	30 A	10 kA	HOMT230230
30 A	40 A	10 kA	HOMT230240
30 A	50 A	10 kA	HOMT230250

NOTE: Typical catalog no. (i.e. HOMT215230) represents two 2P; outer poles (one 15 A 2P with common trip) and inner poles (one 30 A 2P with common trip).

Homeline Circuit Breaker Wire Sizes

Table 7.36: Wire Sizes for Homeline Circuit Breakers

Breaker Type	Ampere Rating	Wire Size (AWG/kcmil) [9]	
		Aluminum	Copper
HOM 1P	15–30 A	14–8 AWG	14–8 AWG or (2) 14–10 AWG
	40–50 A	8–2 AWG	8–2 AWG
HOM 2P	15–30 A	14–8 AWG	14–8 AWG or (2) 14–10 AWG
	35–70 A	8–2 AWG	8–2 AWG
	80–125 A	4–2/0 AWG	4–2/0 AWG
	150–200 A	4 AWG–300 kcmil	4 AWG–300 kcmil
HOMT and Quad	15–30 A	14–8 AWG	14–8 AWG
Quad Only	40–50 A	6–12 AWG	6–14 AWG
HOM-GFI - 1P	15–20 A	14–10 AWG	14–10 AWG
HOM-GFI - 2P	15–50 A	12–4 AWG	14–6 AWG

Accessories for Homeline Circuit Breakers

Table 7.37: Accessories for Use with Homeline Circuit Breakers

Description	Cat. No.	
<b>Handle Attachments</b>		
Handle Tie: Converts any two adjacent 120/240 Vac single HOM circuit breakers to independent trip 2P	HOM1HT	
Handle Tie: Converts any two adjacent 120/240 Vac 1P side-by-side HOMT circuit breakers to independent trip 2P	HOMTHT	
Handle Clamp: Clamp for holding HOM 1P handle in the ON or OFF position	QO1LO	
Handle Blocking Device: Attaches to standard HOM 2P circuit breakers for holding the handle in the OFF position	HOM2HBD	
Handle Padlock Attachment: For padlocking 1P Standard HOM breakers in the ON or OFF position	HOM1PA	
Handle Padlock Attachment: For padlocking 2P Standard HOM circuit breakers in ON or OFF position	15–70 A	HOM2PALA
	80–125 A	HOM2PAHA
	150–200 A	HOM2PAVHA
Handle Padlock Attachment: For padlocking 1P CAFI, DF, GFI, and EPD HOM breakers in ON or OFF position	HOMELEC1PA	
Handle Padlock Attachment: For padlocking 2P CAFI, GFI, and EPD HOM breakers in ON or OFF position	HOMELEC2PALA	
Handle Padlock Attachment: For padlocking center poles of Homeline Quad breakers in the OFF position	HOMQPA	
Handle Padlock Attachment: For padlocking main circuit breakers in convertible load center in OFF position	50–125 A	QOM1PA [10]
	100–225 A	QOM2PA [10]
<b>Sub-Feed Lugs</b>		
125 A 2P plug-on—2 spaces required	HOML2125	
225 A 2P plug-on—4 spaces required	HOML2225 [11]	

[8] 15–20 A tandem or quad tandem circuit breakers are suitable for use with 60°C or 75°C conductors. 25–50 A tandem or quad tandem circuit breakers are suitable for use with 75°C conductors only.  
 [9] 15–30 A circuit breakers are suitable for use with 60°C or 75°C conductors. 40–125 A circuit breakers are suitable for use with 75°C conductors.  
 [10] 50–125 A QOM1 frame size; 100–225 A QOM2 frame size.  
 [11] Requires four spaces (1 AWG–300 kcmil Al/Cu). Use only in 1Ø panel rated 150 A or greater.



UL489 / CSA C22.2 No 5 / IEC/EN 60947-2 / GB14048-2  
 Miniature Circuit Breakers

**Multi 9 C60<sub>BP</sub> and C60<sub>BPR</sub> Miniature Circuit Breakers**

C60<sub>BP</sub> and C60<sub>BPR</sub> are multi-standard miniature circuit breakers and branch circuit protection as defined by UL489. They combine the following functions:

- circuit protection against short-circuit curves
- circuit protection against overload currents
- tripping and fault indication by the addition of auxiliary accessories

Number of 18 mm (0.71 in.) Poles	Rating (A) 25°C/77°F	Breaking Capacity (kA rms)							
		UL 489 / CSA C22.2 No 5				IEC 60947-2			
	Voltage (Ue)	277 Vac	240 Vac	120 Vac	60 Vdc	440 Vac	415 Vac	240 Vac	60 Vdc
1P	0.5 to 35	10	14	14	10	—	3	10	20
	40 to 63	—	10	10	10	—	3	10	20
	Voltage (Ue)	480Y/277 Vac		240 Vac	125 Vdc	440 Vac	415 Vac	240 Vac	125 Vdc
2P	1 to 25	10		14	10	6	10	20	—
	30 to 35	10		14	—	6	10	20	—
3P	1 to 35	10		14	—	6	10	20	—
2P/3P	40 to 63	—		10	—	6	10	20	—

**Table 7.38: C60<sub>BP</sub> and C60<sub>BPR</sub> Catalog Numbers**



Type	UL489 and CSA Voltages	Rating (In)							
		1P			2P		3P		
		Curve			Curve		Curve		
		Z	C	D (= K)	C	D (= K)	C	D (= K)	
<b>C60<sub>BP</sub> (Tunnel Terminal Connection)</b>									
0.5	480Y/277 V and 240 V	M9F44170	M9F42170	M9F43170	—	—	—	—	
1		M9F44101	M9F42101	M9F43101	M9F42201	M9F43201	M9F42301	M9F43301	
2		M9F44102	M9F42102	M9F43102	M9F42202	M9F43202	M9F42302	M9F43302	
3		M9F44103	M9F42103	M9F43103	M9F42203	M9F43203	M9F42303	M9F43303	
4		M9F44104	M9F42104	M9F43104	M9F42204	M9F43204	M9F42304	M9F43304	
5		M9F44105	M9F42105	M9F43105	M9F42205	M9F43205	M9F42305	M9F43305	
6		M9F44106	M9F42106	M9F43106	M9F42206	M9F43206	M9F42306	M9F43306	
8		M9F44108	M9F42108	M9F43108	M9F42208	M9F43208	M9F42308	M9F43308	
10		M9F44110	M9F42110	M9F43110	M9F42210	M9F43210	M9F42310	M9F43310	
15		M9F44115	M9F42115	M9F43115	M9F42215	M9F43215	M9F42315	M9F43315	
20		M9F44120	M9F42120	M9F43120	M9F42220	M9F43220	M9F42320	M9F43320	
25		M9F44125	M9F42125	M9F43125	M9F42225	M9F43225	M9F42325	M9F43325	
30		M9F44130	M9F42130	M9F43130	M9F42230	M9F43230	M9F42330	M9F43330	
35		M9F44135	M9F42135	M9F43135	M9F42235	M9F43235	M9F42335	M9F43335	
40		M9F44140	M9F42140	M9F43140	M9F42240	M9F43240	M9F42340	M9F43340	
45		240 V only	M9F44145	M9F42145	M9F43145	M9F42245	M9F43245	M9F42345	M9F43345
50	M9F44150		M9F42150	M9F43150	M9F42250	M9F43250	M9F42350	M9F43350	
63	M9F44163		M9F42163	M9F43163	M9F42263	M9F43263	M9F42363	M9F43363	
	M9F44163		M9F42163	M9F43163	M9F42263	M9F43263	M9F42363	M9F43363	
<b>C60<sub>BPR</sub> (Ring Tongue Terminal Connection)</b>									
1	480Y/277 V and 240 V	M9F54101	M9F52101	M9F53101	M9F52201	M9F53201	M9F52301	M9F53301	
2		M9F54102	M9F52102	M9F53102	M9F52202	M9F53202	M9F52302	M9F53302	
4		M9F54104	M9F52104	M9F53104	M9F52204	M9F53204	M9F52304	M9F53304	
6		M9F54106	M9F52106	M9F53106	M9F52206	M9F53206	M9F52306	M9F53306	
8		M9F54108	M9F52108	M9F53108	M9F52208	M9F53208	M9F52308	M9F53308	
10		M9F54110	M9F52110	M9F53110	M9F52210	M9F53210	M9F52310	M9F53310	
15		M9F54115	M9F52115	M9F53115	M9F52215	M9F53215	M9F52315	M9F53315	
20		M9F54120	M9F52120	M9F53120	M9F52220	M9F53220	M9F52320	M9F53320	
25		M9F54125	M9F52125	M9F53125	M9F52225	M9F53225	M9F52325	M9F53325	
30		M9F54130	M9F52130	M9F53130	M9F52230	M9F53230	M9F52330	M9F53330	
35		M9F54135	M9F52135	M9F53135	M9F52235	M9F53235	M9F52335	M9F53335	
40		M9F54140	M9F52140	M9F53140	M9F52240	M9F53240	M9F52340	M9F53340	
45		240 V only	M9F54145	M9F52145	M9F53145	M9F52245	M9F53245	M9F52345	M9F53345
50			M9F54150	M9F52150	M9F53150	M9F52250	M9F53250	M9F52350	M9F53350
63			M9F54163	M9F52163	M9F53163	M9F52263	M9F53263	M9F52363	M9F53363
			M9F54163	M9F52163	M9F53163	M9F52263	M9F53263	M9F52363	M9F53363



UL 1077 / CSA C22.2 No 235 / IEC/EN 60947-2 / GB14048-2  
Multi 9 Miniature Circuit Breaker

### Multi 9 C60<sub>SP</sub> Miniature Circuit Breakers

C60<sub>SP</sub> circuit breakers are multi-standard miniature circuit breakers and supplementary protection as defined by UL1077. They combine the following functions:

- circuit protection against short-circuit curves
- circuit protection against overload currents
- tripping and fault indication by the addition of auxiliary accessories

Number of 18 mm (0.71 in.) Poles	Rating (A) 25°C/77°F	Breaking capacity (kA rms)							
		AIR UL 489 / CSA C22.2 No 235				Icu IEC 60947-2			
	Voltage (Ue)	277 Vac	240 ac	120 Vac	65 Vdc	440 Vac	415 Vac	240 Vac	60 Vdc
1P	0.5 to 32	10	14	14	10	—	3	10	20
	40 to 63	5	10	10	10	—	3	10	20
	Voltage (Ue)	480Y/277 Vac		240 Vac	125 Vdc	440 Vac	415 Vac	240 Vac	125 Vdc
2P	1 to 25	10		14	10	6	10	20	—
	32	10		14	—	6	10	20	—
3P/4P	2 to 32	10		14	—	6	10	20	—
2P/3P/4P	40 to 63	5		10	—	6	10	20	—



Table 7.39: C60<sub>SP</sub> Catalog Numbers

Tunnel Terminal Connection						
Rating (In)	Curve			Curve		
	B	C	D (= K)	B	C	D (= K)
	1P			2P		
0.5	M9F21170	M9F22170	M9F23170	—	—	—
1	M9F21101	M9F22101	M9F23101	M9F21201	M9F22201	M9F23201
2	M9F21102	M9F22102	M9F23102	M9F21202	M9F22202	M9F23202
3	M9F21103	M9F22103	M9F23103	M9F21203	M9F22203	M9F23203
4	M9F21104	M9F22104	M9F23104	M9F21204	M9F22204	M9F23204
5	M9F21105	M9F22105	M9F23105	M9F21205	M9F22205	M9F23205
6	M9F21106	M9F22106	M9F23106	M9F21206	M9F22206	M9F23206
8	M9F21108	M9F22108	M9F23108	M9F21208	M9F22208	M9F23208
10	M9F21110	M9F22110	M9F23110	M9F21210	M9F22210	M9F23210
13	M9F21113	M9F22113	M9F23113	M9F21213	M9F22213	M9F23213
16	M9F21116	M9F22116	M9F23116	M9F21216	M9F22216	M9F23216
20	M9F21120	M9F22120	M9F23120	M9F21220	M9F22220	M9F23220
25	M9F21125	M9F22125	M9F23125	M9F21225	M9F22225	M9F23225
32	M9F21132	M9F22132	M9F23132	M9F21232	M9F22232	M9F23232
40	M9F21140	M9F22140	M9F23140	M9F21240	M9F22240	M9F23240
45	M9F21145	M9F22145	M9F23145	M9F21245	M9F22245	M9F23245
50	M9F21150	M9F22150	M9F23150	M9F21250	M9F22250	M9F23250
63	M9F21163	M9F22163	M9F23163	M9F21263	M9F22263	M9F23263
	3P			4P		
0.5	—	—	—	—	—	—
1	—	—	—	—	—	—
2	M9F21302	M9F22302	M9F23302	M9F21402	M9F22402	M9F23402
3	—	—	—	—	—	—
4	—	—	—	—	—	—
5	—	—	—	—	—	—
6	M9F21306	M9F22306	M9F23306	M9F21406	M9F22406	M9F23406
8	M9F21308	M9F22308	M9F23308	M9F21408	M9F22408	M9F23408
10	M9F21310	M9F22310	M9F23310	M9F21410	M9F22410	M9F23410
13	M9F21313	M9F22313	M9F23313	M9F21413	M9F22413	M9F23413
16	M9F21316	M9F22316	M9F23316	M9F21416	M9F22416	M9F23416
20	M9F21320	M9F22320	M9F23320	M9F21420	M9F22420	M9F23420
25	M9F21325	M9F22325	M9F23325	M9F21425	M9F22425	M9F23425
32	M9F21332	M9F22332	M9F23332	M9F21432	M9F22432	M9F23432
40	M9F21340	M9F22340	M9F23340	M9F21440	M9F22440	M9F23440
45	M9F21345	M9F22345	M9F23345	M9F21445	M9F22445	M9F23445
50	M9F21350	M9F22350	M9F23350	M9F21450	M9F22450	M9F23450
63	M9F21363	M9F22363	M9F23363	M9F21463	M9F22463	M9F23463



UL 1077, IEC/EN 60947-2, GB14048.2  
Multi 9 Miniature Circuit Breakers

**Multi 9 C60<sub>H-DC</sub> Miniature Circuit Breakers for DC Circuits**

C60<sub>H-DC</sub> circuit breakers are multi-standard miniature circuit breakers and supplementary protection as defined by UL1077, dedicated to direct current applications. They combine the following functions:

- circuit protection against short-circuit curves
- circuit protection against overload currents
- tripping and fault indication by the addition of auxiliary accessories

Number of 18 mm (0.71 in.) Poles	Rating (A) 25°C/77°F	Breaking capacity (kA rms)			
		AIR UL 1077SA C22.2 No 5	Icu IEC 60947-2		
		12–250 Vdc	110 Vdc	220 Vdc	250 Vdc
1P	0.5 to 63	5	20	10	6
		12–250 Vdc	—	220 Vdc	440 Vdc
2	0.5 to 63	5	—	20	10



C60<sub>H-DC</sub> 1P



C60<sub>H-DC</sub> 2P

**Table 7.40: C60<sub>H-DC</sub> Catalog Numbers**

Rating (In)	Curve			Curve		
	B	C	K (= D)	B	C	K (= D)
	1P			2P		
0.5	—	M9U21170	—	—	M9U21270	—
1	—	M9U21101	M9U31101	—	M9U31201	M9U31201
2	—	M9U21102	M9U31102	—	M9U21202	M9U31202
3	—	M9U21103	M9U31103	—	M9U21203	M9U31203
4	—	M9U21104	M9U31104	—	M9U21204	M9U31204
6	M9U11106	M9U21106	M9U31106	M9U11206	M9U21206	M9U31206
10	M9U11110	M9U21110	M9U31110	M9U11210	M9U21210	M9U31210
13	M9U11113	M9U21113	M9U31113	M9U11213	M9U21213	M9U31213
16	M9U11116	M9U21116	M9U31116	M9U11216	M9U21216	M9U31216
20	M9U11120	M9U21120	M9U31120	M9U11220	M9U21220	M9U31220
25	M9U11125	M9U21125	M9U31125	M9U11225	M9U21225	M9U31225
32	M9U11132	M9U21132	M9U31132	M9U11232	M9U21232	M9U31232
40	M9U11140	M9U21140	M9U31140	M9U11240	M9U21240	M9U31240
50	M9U11150	M9U21150	M9U31150	M9U11250	M9U21250	M9U31250
63	M9U11163	M9U21163	M9U31163	M9U11263	M9U21263	M9U31263

**Multi 9 GFP Ground Fault Protectors**

UL 1053 residual current circuit breakers already protected upstream by a short circuit and overload protection device are used for:

- control and disconnection of electric circuits
- protection of people against electric shock by direct and indirect contacts
- protection of installations against insulation faults
- enhanced continuity of supply, during a series of close lightning strokes, IT earthing system, equipment including interference suppression filters, variable speed controllers, frequency converters, electronic ballasts for lighting
- enhanced earth leakage protection: in presence of harmonics or high frequency ejections.

A-SI type GFPs are ideal for operation in environments with a humid atmosphere and/or polluted by aggressive agents: swimming pools, marinas, agri-food industries, water treatment stations, industrial sites, etc.



UL 1053, IEC/EN 61008  
Multi 9 Ground Fault Protectors



Multi 9 GFP 2P



Multi 9 GFP 4P

**Table 7.41: GFP UL 1053 Type A-SI**

A-S1 Type	Rating (A)	Sensitivity (mA)		Catalog No		Width in modules of 9 mm (0.354 in.)
		UL 1053	IEC/EN 61008	120 or 240 V 230 or 240 V	240 V 480V/277 V 230/400 or 240/415 V	
	25	26	30	M9R81225	M9R41225	4
		86	100	M9R12225	M9R44225	
		260	300	M9R84225	—	
	40	26	30	M9R81240	M9R41240	
		260	300	M9R84240	—	
	63	26	30	M9R81263	—	
	25	26	30	—	M9R81425	8
		86	100	—	M9R12425	
		260	300	—	M9R84425	
	40	26	30	—	M9R81440	
		260	300	—	M9R84440	
	63	26	30	—	M9R81463	
		86	100	—	M9R12463	
	100	86	100	—	M9R12491	
		260	300	—	M9R84491	





**C60<sub>BP</sub> (UL489) Comb Busbars**

These comb busbars are aimed to be used only with C60<sub>BP</sub> circuit-breakers.

They perform distribution and subdistribution of the electric power supply and allow rapid assembly and disassembly of equipment.

**Table 7.42: C60<sub>BP</sub> Comb Busbars**

Connection Accessories	Comb Busbars						Insulated Connectors	Tooth Covers	End-Piece	
Function	<ul style="list-style-type: none"> <li>The comb busbars make it easier to install C60<sub>BP</sub> UL489 circuit breakers.</li> <li>They must not be cut.</li> </ul>						<ul style="list-style-type: none"> <li>Comb busbar power supply</li> <li>Vertical incoming feeder</li> </ul>	<ul style="list-style-type: none"> <li>Insulation of teeth remaining free</li> </ul>	<ul style="list-style-type: none"> <li>Ensures the correct comb busbar insulation</li> </ul>	
Use	Power supply by insulated connector <ul style="list-style-type: none"> <li>Use with rigid and flexible copper cable</li> <li>6 to 35 mm<sup>2</sup> (AWG #10 to #2):</li> </ul>						Tightening torque: 3.5 N•m (31 lb.in.)			
<b>Standard Comb Busbars</b>										
Number of poles	1P		2P			3P		All	All	—
Catalogue numbers	M9XUP106	M9XUP312	M9XUP312	M9XUP312	M9XUP312	M9R81425	M9XUPC04	M9XCTC18	—	
Number of 18 mm modules	6	12	6	12	6	12	—	—	—	
Set of	1		1		1		4	5 x 3	—	
<b>Cuttable Comb Busbars</b>										
Number of poles x	1P	2P	3P	1P+Aux	3P+Aux		All	All	—	
Catalogue numbers	M9XCP157	M9XCP256	M9XCP357	M9XCA137	M9XCA348		M9XCPC04	M9XUTC18	M9XCEC10	
Number of 18 mm modules	57	56	57	37	37		—	—	—	
Set of	1	1	1	1	1		4	5 x 3	—	
<b>Technical Specifications</b>										
Acceptable current at 40°C (Ie)	Standard comb busbars: 115 A Cuttable comb busbars: 80 A									
Resistance to short-circuit currents	Compatible with the breaking capacity of Schneider Electric modular circuit breakers									
Voltage rating (Ue)	480Y/277 V									
Insulation voltage (Ui)	1000 V AC									
Pollution degree	3									
Fire resistance	Self-extinguishability 960°C 30 s/30 s									
Colour	RAL 7035									
Standards	UL508									





**C60<sup>SP</sup> (UL1077) Comb Busbars**

The comb busbars are used only for C60<sup>SP</sup> circuit breakers UL 1077 supplementary protection in conformity with standards:

- UL 1077 / CSA C22.2 No. 235 / IEC 60947-2 / GB 14048-2.

They perform distribution and subdistribution of the electric power supply and allow rapid assembly and disassembly of equipment.

**Table 7.43: C60<sup>SP</sup> Comb Busbars**

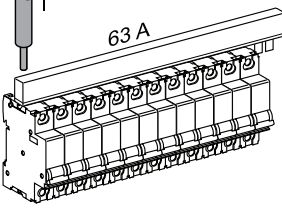
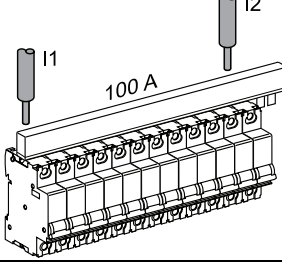
Connection Accessories	Comb Busbars			Tooth Cover End-Piece
				
<b>Function</b>	<ul style="list-style-type: none"> <li>• The comb busbars make it easier to install Schneider Electric circuit breakers UL1077 supplementary protection.</li> <li>• Power supply directly in the cage of the circuit breaker.</li> </ul>			<ul style="list-style-type: none"> <li>• The Tooth Caps are insulated protectors which may be slipped onto the unused teeth of the comb busbar.</li> <li>• They come in strips with 1-pole spacing, but can be snapped apart to be used individually.</li> </ul>
Number of poles	1P	2P	3P	All
Voltage rating (Ue)	480Y/277 Vac	480Y/277 Vac	480Y/277 Vac	—
Catalogue numbers	10285	10286	10287	60488
Number of 18 mm modules	12 (8.5 in./216 mm)	12 (8.5 in./216 mm)	12 (8.5 in./216 mm)	—
Set of	1	1	1	20
<b>Technical Specifications</b>				
Insulation voltage (Ui)	690 Vac			—
Impulse withstand voltage (Uimp)	12 kV under 240 V 5 kV under 480Y/277 V or 277 V			—
Acceptable current at 40°C (Ie)	63 A with 1 central power supply point		100 A with 2 power supply points	—
				—
	Power supply via cable directly in the cage of the device:			—
	<ul style="list-style-type: none"> <li>• cross section max: 3 AWG (25 mm<sup>2</sup>)</li> <li>• cross section min: 10 AWG (5.27 mm<sup>2</sup>)</li> </ul>			—

**Multi 9 C60 Accessories**

Electrical Accessories for C60 Circuit Breakers and Supplementary Protectors

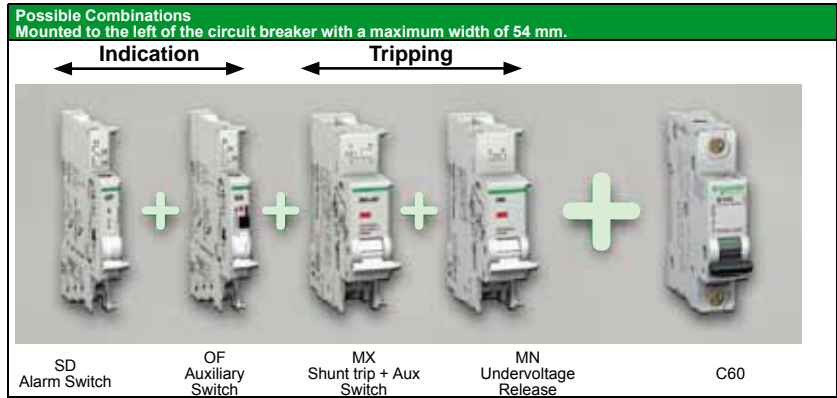

**Table 7.44: Multi 9 C60 Electrical Accessories**

Descriptions	Control Voltage		Width in 9 mm Modules	C60 UL/IEC Cat. No.
	Vac	Vdc		
OF Auxiliary Switch (1a1b)	12–277	12–125	1	M9A26924
SD Alarm Switch (1a1b)	12–277	12–125	1	M9A26927
MX Shunt Trip + OF Auxiliary Switch (1a1b)	24	24	2	M9A26948
	48	48	2	M9A26947
	110–240–277	125	2	M9A26946
MN Undervoltage Release	24	24	2	M9A27108
	48	48	2	M9A26961
	120	—	2	M9A27107
	240	—	2	M9A26960
Multi-9 GFP UL 1053 Listed Ground Fault Protectors	120 to 480Y/277 Vac; 30, 100, and 300 mA; 2P and 4Ps. See Multi 9 GFP Ground Fault Protectors, page 7-27 or Catalog LVCM90EM_EN			

**Table 7.45: Multi 9 C60 Mechanical Accessories**

Descriptions		C60 Cat. No.
Ring tongue terminal kit for UL1077 C60	For one pole	M9A17400
Spacer for DIN rail, Not UL Recognized	9 mm wide	27062
Padlock Attachment (1 per for 1P, 2P, 3P or 4P)	2 per pack	26970
Heavy-duty Padlock Attachment for C60, Locks OFF only	2 per pack	M9PAF
Padlocking Device Left Side Mount, Locks OFF only [1]	1 per pack	MGN26380
Padlocking Device Right Side Mount, Locks OFF only [2]		MGN26381
Front Mounting Kit	1P	MG26983
	2P	MG26984
	3P	MG26985
	4P	MG26989
Terminal Screw Shield (Not UL Recognized)	Bag of two 4P shields	26981
Terminal cover (Not UL Recognized)	1P	26975
	2P	26976
	3P	26975 + 26976
	4P	26978
Rotary Handle for C60 (Non UL Recognized)		
Operating Subassembly	2P/3P/4P	27046
Door Interlock Handle		27047
Fixed Handle (Front or Lateral)		27048
<b>Multi-pole Front Mounting Kit</b>		
Rail Support (20 of 9 mm modules)		14211
Hinged Transparent Cover		14210

[1] Left-side mounted padlocking device cannot be used in conjunction with accessories SD, OF, MX or MN. Use right-side mounted padlocking device when accessories are required.  
[2] Right-side mounted padlocking device cannot be used in conjunction with VIGI module. Use left-side mounted padlocking device when VIGI Module is required.

**The PowerPact Advantage**

- **Proven Performance:** Industry-leading circuit breaker innovation and protection for heavy-duty commercial and industrial applications.
- **Smart:** Integrated metering options provide a cost-effective solution to reduce energy consumption, optimize energy costs, and improve energy availability for your facilities.
- **Flexible:** Full range of thermal-magnetic and electronic trip molded case circuit breakers from 15 to 3000 A, delivering the ratings, configurations, and operators for your unique applications.
- **Simple:** Common catalog numbers, standardized ratings, and a full range of field-installable accessories make product selection, installation and maintenance easier than ever.
- **Common Design Features:** Mounting holes, door trim, and handle accessories

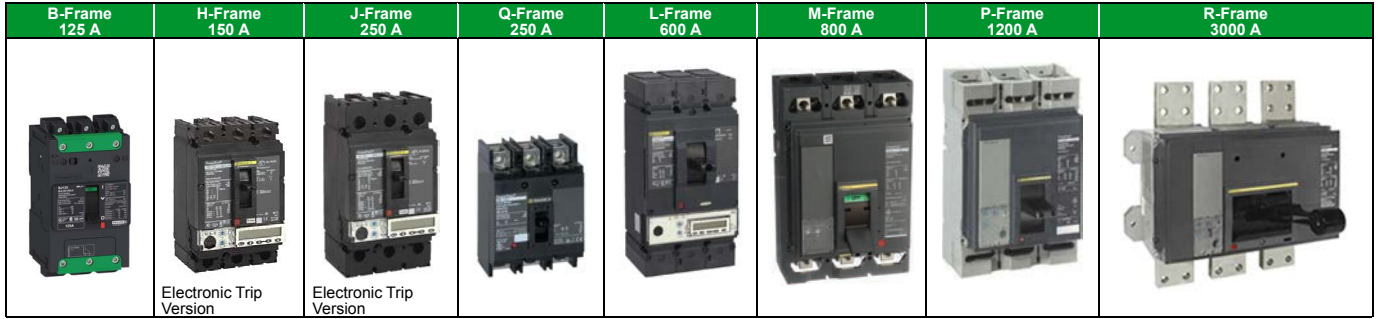

**Table 7.46: PowerPact Interrupting Ratings**

Voltage	Interrupting Rating						
	B	D	G	J	K	L	R
240 Vac	10 kA	25 kA	65 kA	100 kA	65 kA [1]	125 kA	200 kA
480 Vac	—	18 kA	35 kA	65 kA	65 kA [2]	100 kA	200 kA
600 Vac	—	14 kA	18 kA	25 kA	65 kA [2]	50 kA [3]	100 kA

**Table 7.47: Common Catalog Numbering System**

Frame	Rating	Termination	Poles	Voltage	Amperage <sup>[4]</sup>	Suffix Code	Suffix Code				
H	G	L	3	6	1	5	0	A	B	S	A
			1=1Pole 2=2Pole 3=3Pole 4=4Pole	4=480 V 6=600 V				2A/2B Auxiliary Switch		110 Vac Shunt Trip	

Frame Designation		Interrupting Rating			Terminations		
B	125 A Frame		240 Vac	480 Vac	600Vac	A	I-Line
H	150 A Frame	B	10 kA	—	—	L	Lugs on Both Ends
J	250 A Frame	D	25 kA	18 kA	14 kA	F	Bus Bar (No Lugs)
Q	250 A Frame	G	65 kA	35 kA	18 kA	M	Lugs Line Side Only
L	600 A Frame	J	100 kA	65 kA	25 kA	P	Lugs Load End Only
M	800 A Frame	K	100 kA	65 kA	65 kA	N	Plug-in
P	1200 A Frame	L	125 kA	100 kA	50 kA	D	Drawout
R	3000 A Frame	R	200 kA	200 kA	100 kA	S	Rear Connected Studs

**For more information:**

- B-Frame Circuit Breakers, page 7-32
- H- and J-Frame Circuit Breakers, page 7-33
- Q-Frame Circuit Breakers, page 7-36
- L-Frame Circuit Breakers, page 7-38
- P-Frame Circuit Breakers, page 7-41
- R-Frame Circuit Breakers, page 7-42
- H, J, and L-Frame Motor Protectors, page 7-50
- Motor Circuit Protectors and Motor Protector Circuit Breakers, page 7-50
- Automatic Switches, page 7-46
- 500 Vdc Circuit Breakers, page 7-45
- Mission Critical Circuit Breakers, page 7-44
- Electrical Accessories for Circuit Breakers, page 7-51
- Motor Operators, page 7-52 and Rotary Handles, page 7-53
- Locks, Installation Accessories, and Rear Connectors, page 7-54
- Mechanical Lugs, page 7-56
- Compression Lugs, page 7-57 and Power Distribution Connectors, page 7-58
- Terminal Nuts, Terminal Pads, Terminal Shields, and Accessories, page 7-59
- Plug-In and Drawout Mountings, page 7-60
- MicroLogic Electronic Trip Units, page 7-61
- Trip Unit Accessories, page 7-64

[1] B-frame K interrupting rating is 100 kA at 240 Vac

[2] P-frame K interrupting is 50 kA at 480 and 600 Vac.

[3] P-frame L interrupting is 25 kA at 600 Vac.

[4] For amperage of M-, P- or R-frame circuit breakers, add a zero to the three amperage digits; for example, 120 = 1200 A.



B-Frame Thermal-Magnetic Trip Unit



With EverLink Lug Technology

**PowerPact B-Frame Molded Case Circuit Breakers (125 A)**

PowerPact B-frame circuit breakers provides economical thermal-magnetic circuit protection in a compact size.

- Fixed 15-125 A thermal-magnetic protection up to 600Y/347 Vac and 250 Vdc
- 1- to 4-pole unit mount construction; 1- to 3-pole I-Line construction
- UL listed interrupting ratings from 18 kA to 65 kA at 480 Vac
- EverLink lugs, a cable connection method that helps maintain low resistance connections
- UL, CSA, NOM, IEC, CCC certified and CE marked for global acceptance

**Table 7.48: PowerPact B-Frame 125 A Thermal-Magnetic Circuit Breakers (600Y/347 Vac) with EverLink Lugs**

Current Rating @ 40° C	Interrupting Rating													
	D				G				J				K	
	1 Pole 347 Vac 125 Vdc	2 Pole 600Y/347 Vac 250 Vdc	3 Pole 600Y/347 Vac 250 Vdc	4 Pole 600Y/347 Vac 250 Vdc	1 Pole 347 Vac 125 Vdc	2 Pole 600Y/347 Vac 250 Vdc	3 Pole 600Y/347 Vac 250 Vdc	4 Pole 600Y/347 Vac 250 Vdc	1 Pole 347 Vac 125 Vdc	2 Pole 600Y/347 Vac 250 Vdc	3 Pole 600Y/347 Vac 250 Vdc	4 Pole 600Y/347 Vac 250 Vdc	1 Pole 347 Vac	2 Pole 600Y/347 Vac
15 A	BDL16015	BDL26015	BDL36015	BDL46015	BGL16015	BGL26015	BGL36015	BGL46015	BJL16015	BJL26015	BJL36015	BJL46015	BKL16015	BKL26015
20 A	BDL16020	BDL26020	BDL36020	BDL46020	BGL16020	BGL26020	BGL36020	BGL46020	BJL16020	BJL26020	BJL36020	BJL46020	BKL16020	BKL26020
25 A	BDL16025	BDL26025	BDL36025	BDL46025	BGL16025	BGL26025	BGL36025	BGL46025	BJL16025	BJL26025	BJL36025	BJL46025	BKL16025	BKL26025
30 A	BDL16030	BDL26030	BDL36030	BDL46030	BGL16030	BGL26030	BGL36030	BGL46030	BJL16030	BJL26030	BJL36030	BJL46030	BKL16030	BKL26030
35 A	BDL16035	BDL26035	BDL36035	BDL46035	BGL16035	BGL26035	BGL36035	BGL46035	BJL16035	BJL26035	BJL36035	BJL46035	—	—
40 A	BDL16040	BDL26040	BDL36040	BDL46040	BGL16040	BGL26040	BGL36040	BGL46040	BJL16040	BJL26040	BJL36040	BJL46040	—	—
45 A	BDL16045	BDL26045	BDL36045	BDL46045	BGL16045	BGL26045	BGL36045	BGL46045	BJL16045	BJL26045	BJL36045	BJL46045	—	—
50 A	BDL16050	BDL26050	BDL36050	BDL46050	BGL16050	BGL26050	BGL36050	BGL46050	BJL16050	BJL26050	BJL36050	BJL46050	—	—
60 A	BDL16060	BDL26060	BDL36060	BDL46060	BGL16060	BGL26060	BGL36060	BGL46060	BJL16060	BJL26060	BJL36060	BJL46060	—	—
70 A	BDL16070	BDL26070	BDL36070	BDL46070	BGL16070	BGL26070	BGL36070	BGL46070	BJL16070	BJL26070	BJL36070	BJL46070	—	—
80 A	BDL16080	BDL26080	BDL36080	BDL46080	BGL16080	BGL26080	BGL36080	BGL46080	BJL16080	BJL26080	BJL36080	BJL46080	—	—
90 A	BDL16090	BDL26090	BDL36090	BDL46090	BGL16090	BGL26090	BGL36090	BGL46090	BJL16090	BJL26090	BJL36090	BJL46090	—	—
100 A	BDL16100	BDL26100	BDL36100	BDL46100	BGL16100	BGL26100	BGL36100	BGL46100	BJL16100	BJL26100	BJL36100	BJL46100	—	—
110 A	BDL16110	BDL26110	BDL36110	BDL46110	BGL16110	BGL26110	BGL36110	BGL46110	BJL16110	BJL26110	BJL36110	BJL46110	—	—
125 A	BDL16125	BDL26125	BDL36125	BDL46125	BGL16125	BGL26125	BGL36125	BGL46125	BJL16125	BJL26125	BJL36125	BJL46125	—	—

**Table 7.49: B-Frame Termination Options**

Termination Letter and Description	Example
A I-Line (See Section 9, Panelboards)	B D L 3 6 1 0 0 For factory-installed termination, place termination letter in the third block of the circuit breaker catalog number.
F No Lugs (includes terminal nut kit on both ends)	In this example "L" indicates EverLink Lugs for both ON and OFF ends.
L EverLink lugs both ends	
M EverLink ON end, Terminal Nut Kit OFF end	
P Terminal Nut ON end, EverLink OFF end	

**Table 7.51: B-Frame Lug Options**

Lug Option Suffix	Example
No Suffix = EverLink Lugs both ends	B D L 3 6 1 0 0 L U
LU = EverLink Lug with Control Wire Terminal ON end; EverLink Lug OFF end	For factory-installed lug option, place suffix after the amperage in the circuit breaker catalog number.
LV = EverLink Lug ON end; EverLink Lug with Control Wire Terminal OFF end	
LW = EverLink Lug with Control Wire Terminal both ends	
LC = Copper Mechanical Lugs both ends	
LH = Aluminum Mechanical Lugs both ends	

**Table 7.50: B-Frame Interrupting Ratings**

Voltage	Interrupting Rating			
	D	G	J	K
240 Vac	25 kA	65 kA	100 kA	100 kA
480Y/277 Vac	18 kA	35 kA	65 kA	65 kA
480 Vac	18 kA	35 kA	65 kA	65 kA
600Y/347 Vac	14 kA	18 kA	25 kA	65 kA
125 Vdc	10 kA	20 kA	50 kA	—
250 Vdc	10 kA	20 kA	50 kA	—

**Table 7.52: PowerPact B-Frame 125 A Magnetic Trip Values**

Current Rating @ 40° C	Fixed AC Magnetic Trip	
	Hold	Trip
15 A	400 A	600 A
20 A	400 A	600 A
25 A	480 A	720 A
30 A	480 A	720 A
35 A	480 A	720 A
40 A	480 A	720 A
45 A	480 A	720 A
50 A	480 A	720 A
60 A	640 A	960 A
70 A	800 A	1200 A
80 A	800 A	1200 A
90 A	1000 A	1500 A
100 A	1000 A	1500 A
110 A	1000 A	1500 A
125 A	1000 A	1500 A

Accessories see [page 7-51](#)  
Optional Lugs see [page 7-56](#)  
Dimensions see [page 7-87](#)

**PowerPact H- and J-Frame Molded-Case Circuit Breakers (150 A and 250 A)**

A flexible, high performance offer certified to global standards.

- Thermal magnetic or MicroLogic™ trip protection from 15–250 A up to 600 Vac and 250 Vdc
- 2 and 3-pole unit mount and I-Line constructions<sup>[5]</sup>
- High performance UL listed interrupting ratings from 18 to 200 kA at 480 Vac
- H- and J-Frame have common mounting holes, handle locations and trim dimensions with many shared accessories and auxiliaries.
- UL, CSA, NOM, IEC, CCC certified and CE marked for global acceptance.



J-Frame MicroLogic™ Trip Unit



J-Frame 3-Pole Thermal-Magnetic Trip Unit

**Table 7.53: Lug Kit Wire Ranges**

Sensor Rating	Standard Lug Kit	Terminal Wire Range
60–150 A	AL150HD	14–3/0 AWG Al or Cu
250 A	AL250JD	3/0 AWG–350 kcmil Al or Cu

**Table 7.54: H- and J-Frame Interrupting Ratings**

Voltage	Interrupting Rating				
	D	G	J	L	R
240 Vac	25 kA	65 kA	100 kA	125 kA	200 kA
480 Vac	18 kA	35 kA	65 kA	100 kA	200 kA
600 Vac	14 kA	18 kA	25 kA	50 kA	100 kA
250 Vdc <sup>[6]</sup>	20 kA	20 kA	20 kA	20 kA	—

**Table 7.55: H- and J-Frame Termination Options**

Termination Letter	
A - I-Line (See Section 9—Panelboards)	H D L 3 6 0 1 5 For factory-installed termination, place termination letter in the third block of the circuit breaker catalog number.
F = No Lugs (includes terminal nut kit on both ends)	
L = Lugs both ends	
M = Lugs ON end Terminal Nut Kit OFF end	
P = Lugs OFF end Terminal Nut Kit ON end	
N = Plug-in	
D = Drawout	
S = Rear Connected	

Accessories see [page 7-51](#)  
 Optional Lugs see [page 7-56](#)  
 Dimensions see [page 7-87](#)  
 Enclosures see [page 7-88](#)

[5] H- and J- frame circuit breakers can be used as a main or sub-feed circuit breaker in an NQ or NF panelboard.  
 [6] Not available with electronic trip units.

**PowerPact H-Frame Thermal-Magnetic Circuit Breakers**

**Table 7.56: Powerpact H-Frame 150 A Thermal-Magnetic UL Current-Limiting [7] Circuit Breakers (600 Vac, 250 Vdc) [8] With Factory Sealed Trip Unit Suitable for Reverse Connection [9]**

Current Rating @ 40° C	Fixed AC Magnetic Trip		Interrupting Rating							
			D		G		J [8]		L [8]	
	Hold	Trip	Standard (80% Rated)	100% Rated	Standard (80% Rated)	100% Rated	Standard (80% Rated)	100% Rated	Standard (80% Rated)	100% Rated
<b>H-Frame, 150A 2P, 600 Vac 50/60 Hz, 250 Vdc [10]</b>										
15 A	350 A	750 A	HDL26015	HDL26015C	HGL26015	HGL26015C	HJL26015	HJL26015C	HLL26015	HLL26015C
20 A	350 A	750 A	HDL26020	HDL26020C	HGL26020	HGL26020C	HJL26020	HJL26020C	HLL26020	HLL26020C
25 A	350 A	750 A	HDL26025	HDL26025C	HGL26025	HGL26025C	HJL26025	HJL26025C	HLL26025	HLL26025C
30 A	350 A	750 A	HDL26030	HDL26030C	HGL26030	HGL26030C	HJL26030	HJL26030C	HLL26030	HLL26030C
35 A	400 A	850 A	HDL26035	HDL26035C	HGL26035	HGL26035C	HJL26035	HJL26035C	HLL26035	HLL26035C
40 A	400 A	850 A	HDL26040	HDL26040C	HGL26040	HGL26040C	HJL26040	HJL26040C	HLL26040	HLL26040C
45 A	400 A	850 A	HDL26045	HDL26045C	HGL26045	HGL26045C	HJL26045	HJL26045C	HLL26045	HLL26045C
50 A	400 A	850 A	HDL26050	HDL26050C	HGL26050	HGL26050C	HJL26050	HJL26050C	HLL26050	HLL26050C
60 A	800 A	1450 A	HDL26060	HDL26060C	HGL26060	HGL26060C	HJL26060	HJL26060C	HLL26060	HLL26060C
70 A	800 A	1450 A	HDL26070	HDL26070C	HGL26070	HGL26070C	HJL26070	HJL26070C	HLL26070	HLL26070C
80 A	800 A	1450 A	HDL26080	HDL26080C	HGL26080	HGL26080C	HJL26080	HJL26080C	HLL26080	HLL26080C
90 A	800 A	1450 A	HDL26090	HDL26090C	HGL26090	HGL26090C	HJL26090	HJL26090C	HLL26090	HLL26090C
100 A	800 A	1700 A	HDL26100	HDL26100C	HGL26100	HGL26100C	HJL26100	HJL26100C	HLL26100	HLL26100C
110 A	900 A	1700 A	HDL26110	HDL26110C	HGL26110	HGL26110C	HJL26110	HJL26110C	HLL26110	HLL26110C
125 A	900 A	1700 A	HDL26125	HDL26125C	HGL26125	HGL26125C	HJL26125	HJL26125C	HLL26125	HLL26125C
150 A	900 A	1700 A	HDL26150	HDL26150C	HGL26150	HGL26150C	HJL26150	HJL26150C	HLL26150	HLL26150C
<b>H-Frame 150A 3P, 600 Vac 50/60 Hz, 250 Vdc</b>										
15 A	350 A	750 A	HDL36015	HDL36015C	HGL36015	HGL36015C	HJL36015	HJL36015C	HLL36015	HLL36015C
20 A	350 A	750 A	HDL36020	HDL36020C	HGL36020	HGL36020C	HJL36020	HJL36020C	HLL36020	HLL36020C
25 A	350 A	750 A	HDL36025	HDL36025C	HGL36025	HGL36025C	HJL36025	HJL36025C	HLL36025	HLL36025C
30 A	350 A	750 A	HDL36030	HDL36030C	HGL36030	HGL36030C	HJL36030	HJL36030C	HLL36030	HLL36030C
35 A	400 A	850 A	HDL36035	HDL36035C	HGL36035	HGL36035C	HJL36035	HJL36035C	HLL36035	HLL36035C
40 A	400 A	850 A	HDL36040	HDL36040C	HGL36040	HGL36040C	HJL36040	HJL36040C	HLL36040	HLL36040C
45 A	400 A	850 A	HDL36045	HDL36045C	HGL36045	HGL36045C	HJL36045	HJL36045C	HLL36045	HLL36045C
50 A	400 A	850 A	HDL36050	HDL36050C	HGL36050	HGL36050C	HJL36050	HJL36050C	HLL36050	HLL36050C
60 A	800 A	1450 A	HDL36060	HDL36060C	HGL36060	HGL36060C	HJL36060	HJL36060C	HLL36060	HLL36060C
70 A	800 A	1450 A	HDL36070	HDL36070C	HGL36070	HGL36070C	HJL36070	HJL36070C	HLL36070	HLL36070C
80 A	800 A	1450 A	HDL36080	HDL36080C	HGL36080	HGL36080C	HJL36080	HJL36080C	HLL36080	HLL36080C
90 A	800 A	1450 A	HDL36090	HDL36090C	HGL36090	HGL36090C	HJL36090	HJL36090C	HLL36090	HLL36090C
100 A	800 A	1700 A	HDL36100	HDL36100C	HGL36100	HGL36100C	HJL36100	HJL36100C	HLL36100	HLL36100C
110 A	900 A	1700 A	HDL36110	HDL36110C	HGL36110	HGL36110C	HJL36110	HJL36110C	HLL36110	HLL36110C
125 A	900 A	1700 A	HDL36125	HDL36125C	HGL36125	HGL36125C	HJL36125	HJL36125C	HLL36125	HLL36125C
150 A	900 A	1700 A	HDL36150	HDL36150C	HGL36150	HGL36150C	HJL36150	HJL36150C	HLL36150	HLL36150C

HJ and HL are UL certified as current limiting circuit breakers.

**PowerPact J-Frame Thermal-Magnetic Circuit Breakers**

**Table 7.57: J-Frame 250 A Thermal-Magnetic UL Current-Limiting [11] Circuit Breakers (600 Vac, 250 Vdc) With Factory Sealed Trip Unit Suitable for Reverse Connection [9]**

Current Rating @ 40° C	Adjustable AC Magnetic Trip		Interrupting Rating									
			D		G		J [11]		L [11]		R [11]	
	Low	High	Standard (80% Rated)	100% Rated	Standard (80% Rated)	100% Rated	Standard (80% Rated)	100% Rated	Standard (80% Rated)	100% Rated	Standard (80% Rated)	100% Rated
<b>J-Frame 250 A 2P, 600 Vac 50/60 Hz, 250 Vdc [12]</b>												
150 A	750 A	1500 A	JDL26150	JDL26150C	JGL26150	JGL26150C	JJL26150	JJL26150C	JLL26150	JLL26150C	—	—
175 A	875 A	1750 A	JDL26175	JDL26175C	JGL26175	JGL26175C	JJL26175	JJL26175C	JLL26175	JLL26175C	—	—
200 A	1000 A	2000 A	JDL26200	JDL26200C	JGL26200	JGL26200C	JJL26200	JJL26200C	JLL26200	JLL26200C	—	—
225 A	1125 A	2250 A	JDL26225	JDL26225C	JGL26225	JGL26225C	JJL26225	JJL26225C	JLL26225	JLL26225C	—	—
250 A	1250 A	2500 A	JDL26250	JDL26250C	JGL26250	JGL26250C	JJL26250	JJL26250C	JLL26250	JLL26250C	—	—
<b>J-Frame 250 A 3P, 600 Vac 50/60 Hz, 250 Vdc</b>												
150 A	750 A	1500 A	JDL36150	JDL36150C	JGL36150	JGL36150C	JJL36150	JJL36150C	JLL36150	JLL36150C	JRL36150	JRL36150C
175 A	875 A	1750 A	JDL36175	JDL36175C	JGL36175	JGL36175C	JJL36175	JJL36175C	JLL36175	JLL36175C	JRL36175	JRL36175C
200 A	1000 A	2000 A	JDL36200	JDL36200C	JGL36200	JGL36200C	JJL36200	JJL36200C	JLL36200	JLL36200C	JRL36200	JRL36200C
225 A	1125 A	2250 A	JDL36225	JDL36225C	JGL36225	JGL36225C	JJL36225	JJL36225C	JLL36225	JLL36225C	JRL36225	JRL36225C
250 A	1250 A	2500 A	JDL36250	JDL36250C	JGL36250	JGL36250C	JJL36250	JJL36250C	JLL36250	JLL36250C	JRL36250	JRL36250C

JJ, JL and JR are UL certified as current limiting circuit breakers.

[7] Circuit breakers with J and L interrupting ratings are UL certified as current limiting.  
 [8] Standard lug kit: AL150HD. Terminal wire range: 14–3/0 AWG Al or Cu.  
 [9] See Supplemental Digest Section 3 for circuit breakers with field interchangeable trip units.  
 [10] HD and HG circuit breakers are true two-pole construction.  
 [11] Circuit breakers with J, L, and R interrupting ratings are UL certified as current limiting.  
 [12] 2P in a 3P module

**PowerPact H- and J-Frame Electronic Trip Current Limiting Circuit Breakers (150 A and 250 A)**



**Table 7.58: H-Frame 150 A and J-Frame 250 A Electronic Trip UL Current-Limiting [13] Standard (80% Rated) Circuit Breakers (600 Vac) With Factory Sealed Trip Unit [14] Suitable for Reverse Connection [15]**

Electronic Trip Unit			Sensor Rating	Interrupting Rating (80% Rated)				
Type	Function	Trip Unit		D	G	J [13]	L [13]	R [13]
600 Vac, 50/60 Hz, 3P								
MicroLogic Standard	LI	3.2 [16]	60 A	HDL36060U31X	HGL36060U31X	HJL36060U31X	HLL36060U31X	HRL36060U31X
			100 A	HDL36100U31X	HGL36100U31X	HJL36100U31X	HLL36100U31X	HRL36100U31X
			150 A	HDL36150U31X	HGL36150U31X	HJL36150U31X	HLL36150U31X	HRL36150U31X
			250 A	JDL36250U31X	JGL36250U31X	JJL36250U31X	JLL36250U31X	JRL36250U31X
MicroLogic Standard	LSI	3.2S [16] [17]	60 A	HDL36060U33X	HGL36060U33X	HJL36060U33X	HLL36060U33X	HRL36060U33X
			100 A	HDL36100U33X	HGL36100U33X	HJL36100U33X	HLL36100U33X	HRL36100U33X
			150 A	HDL36150U33X	HGL36150U33X	HJL36150U33X	HLL36150U33X	HRL36150U33X
			250 A	JDL36250U33X	JGL36250U33X	JJL36250U33X	JLL36250U33X	JRL36250U33X
MicroLogic Ammeter	LSI	5.2A	60 A	HDL36060U43X	HGL36060U43X	HJL36060U43X	HLL36060U43X	HRL36060U43X
			100 A	HDL36100U43X	HGL36100U43X	HJL36100U43X	HLL36100U43X	HRL36100U43X
			150 A	HDL36150U43X	HGL36150U43X	HJL36150U43X	HLL36150U43X	HRL36150U43X
			250 A	JDL36250U43X	JGL36250U43X	JJL36250U43X	JLL36250U43X	JRL36250U43X
MicroLogic Energy	LSI	5.2E	60 A	HDL36060U53X	HGL36060U53X	HJL36060U53X	HLL36060U53X	HRL36060U53X
			100 A	HDL36100U53X	HGL36100U53X	HJL36100U53X	HLL36100U53X	HRL36100U53X
			150 A	HDL36150U53X	HGL36150U53X	HJL36150U53X	HLL36150U53X	HRL36150U53X
			250 A	JDL36250U53X	JGL36250U53X	JJL36250U53X	JLL36250U53X	JRL36250U53X
MicroLogic Ammeter	LSIG	6.2A [18]	60 A	HDL36060U44X	HGL36060U44X	HJL36060U44X	HLL36060U44X	HRL36060U44X
			100 A	HDL36100U44X	HGL36100U44X	HJL36100U44X	HLL36100U44X	HRL36100U44X
			150 A	HDL36150U44X	HGL36150U44X	HJL36150U44X	HLL36150U44X	HRL36150U44X
			250 A	JDL36250U44X	JGL36250U44X	JJL36250U44X	JLL36250U44X	JRL36250U44X
MicroLogic Energy	LSIG	6.2E	60 A	HDL36060U54X	HGL36060U54X	HJL36060U54X	HLL36060U54X	HRL36060U54X
			100 A	HDL36100U54X	HGL36100U54X	HJL36100U54X	HLL36100U54X	HRL36100U54X
			150 A	HDL36150U54X	HGL36150U54X	HJL36150U54X	HLL36150U54X	HRL36150U54X
			250 A	JDL36250U54X	JGL36250U54X	JJL36250U54X	JLL36250U54X	JRL36250U54X

**Table 7.59: H-Frame 150 A and J-Frame 250 A Electronic Trip UL Current-Limiting [13] 100% Rated Circuit Breakers (600 Vac) With Factory Sealed Trip Unit [14] Suitable for Reverse Connection [15]**

Electronic Trip Unit			Sensor Rating	Interrupting Rating (100% Rated)				
Type	Function	Trip Unit		D	G	J [13]	L [13]	R [13]
600 Vac, 50/60 Hz, 3P [19]								
MicroLogic Standard	LI	3.2 [16]	60 A	HDL36060CU31X	HGL36060CU31X	HJL36060CU31X	HLL36060CU31X	HRL36060CU31X
			100 A	HDL36100CU31X	HGL36100CU31X	HJL36100CU31X	HLL36100CU31X	HRL36100CU31X
			150 A	HDL36150CU31X	HGL36150CU31X	HJL36150CU31X	HLL36150CU31X	HRL36150CU31X
			250 A	JDL36250CU31X	JGL36250CU31X	JJL36250CU31X	JLL36250CU31X	JRL36250CU31X
MicroLogic Standard	LSI	3.2S [16] [17]	60 A	HDL36060CU33X	HGL36060CU33X	HJL36060CU33X	HLL36060CU33X	HRL36060CU33X
			100 A	HDL36100CU33X	HGL36100CU33X	HJL36100CU33X	HLL36100CU33X	HRL36100CU33X
			150 A	HDL36150CU33X	HGL36150CU33X	HJL36150CU33X	HLL36150CU33X	HRL36150CU33X
			250 A	JDL36250CU33X	JGL36250CU33X	JJL36250CU33X	JLL36250CU33X	JRL36250CU33X
MicroLogic Ammeter	LSI	5.2A	60 A	HDL36060CU43X	HGL36060CU43X	HJL36060CU43X	HLL36060CU43X	HRL36060CU43X
			100 A	HDL36100CU43X	HGL36100CU43X	HJL36100CU43X	HLL36100CU43X	HRL36100CU43X
			150 A	HDL36150CU43X	HGL36150CU43X	HJL36150CU43X	HLL36150CU43X	HRL36150CU43X
			250 A	JDL36250CU43X	JGL36250CU43X	JJL36250CU43X	JLL36250CU43X	JRL36250CU43X
MicroLogic Energy	LSI	5.2E	60 A	HDL36060CU53X	HGL36060CU53X	HJL36060CU53X	HLL36060CU53X	HRL36060CU53X
			100 A	HDL36100CU53X	HGL36100CU53X	HJL36100CU53X	HLL36100CU53X	HRL36100CU53X
			150 A	HDL36150CU53X	HGL36150CU53X	HJL36150CU53X	HLL36150CU53X	HRL36150CU53X
			250 A	JDL36250CU53X	JGL36250CU53X	JJL36250CU53X	JLL36250CU53X	JRL36250CU53X
MicroLogic Ammeter	LSIG	6.2A [18]	60 A	HDL36060CU44X	HGL36060CU44X	HJL36060CU44X	HLL36060CU44X	HRL36060CU44X
			100 A	HDL36100CU44X	HGL36100CU44X	HJL36100CU44X	HLL36100CU44X	HRL36100CU44X
			150 A	HDL36150CU44X	HGL36150CU44X	HJL36150CU44X	HLL36150CU44X	HRL36150CU44X
			250 A	JDL36250CU44X	JGL36250CU44X	JJL36250CU44X	JLL36250CU44X	JRL36250CU44X
MicroLogic Energy	LSIG	6.2E	60 A	HDL36060CU54X	HGL36060CU54X	HJL36060CU54X	HLL36060CU54X	HRL36060CU54X
			100 A	HDL36100CU54X	HGL36100CU54X	HJL36100CU54X	HLL36100CU54X	HRL36100CU54X
			150 A	HDL36150CU54X	HGL36150CU54X	HJL36150CU54X	HLL36150CU54X	HRL36150CU54X
			250 A	JDL36250CU54X	JGL36250CU54X	JJL36250CU54X	JLL36250CU54X	JRL36250CU54X

Accessories see page 7-51  
Optional Lugs see page 7-56  
Dimensions see page 7-87  
Enclosures see page 7-88

[13] Circuit breakers with J, L, and R interrupting ratings are UL certified as current limiting.  
[14] See Supplemental Digest Section 3 for circuit breakers with field interchangeable trip units.  
[15] For applications requiring communications see page 7-64.  
[16] 3P circuit breakers with this trip unit can be used for 2P applications.  
[17] Fixed ST and LT delays.  
[18] 3P circuit breakers with this trip unit can be used for 2P applications requiring ground fault protection. Additional metering capabilities will not work properly on the unconnected phase.  
[19] 3-pole PowerPact H- and J-frame circuit breakers can be used for 2-pole applications. (For such instances, MicroLogic 6.2 Ammeter and Energy trip units can be used for ground fault protection. Additional metering capabilities are not guaranteed when using MicroLogic Ammeter and Energy trip units for this type of application.)



**Q-Frame Molded Case Circuit Breakers (250 A)**

PowerPact Q-frame circuit breakers are used for overcurrent protection and switching on 240 Vac applications.<sup>[20]</sup>

- Fixed thermal magnetic protection from 70–250 A at 240 Vac
- 2- and 3-pole unit mount and I-Line constructions<sup>[21]</sup>
- UL listed interruption ratings from 10 kA to 100 kA at 240 Vac
- Available in standard (80%) rating only
- UL 489 Listed, CSA, NOM and IEC certified



2-Pole Q-Frame with Thermal-Magnetic Trip Unit 70–250

3-Pole Q-Frame with Thermal-Magnetic Trip Unit 70–250 A

**Table 7.60: PowerPact Q-Frame 250 A Thermal-Magnetic Circuit Breaker (240 Vac)**

Ampere Rating	Fixed AC Magnetic Trip		Interrupting Rating				Terminal Wire Range	
	Hold	Trip	B	D	G	J		
<b>2P, 240 Vac</b>								
70 A	1000 A	1800 A	QBL22070	QDL22070	QGL22070	QJL22070	#4 AWG - 300 kcmil Al/Cu	
80 A	1000 A	1800 A	QBL22080	QDL22080	QGL22080	QJL22080		
90 A	1000 A	1800 A	QBL22090	QDL22090	QGL22090	QJL22090		
100 A	1200 A	2400 A	QBL22100	QDL22100	QGL22100	QJL22100		
110 A	1200 A	2400 A	QBL22110	QDL22110	QGL22110	QJL22110		
125 A	1200 A	2400 A	QBL22125	QDL22125	QGL22125	QJL22125		
150 A	1200 A	2400 A	QBL22150	QDL22150	QGL22150	QJL22150		
175 A	1200 A	2400 A	QBL22175	QDL22175	QGL22175	QJL22175		
200 A	1200 A	2400 A	QBL22200	QDL22200	QGL22200	QJL22200		
225 A	1200 A	2400 A	QBL22225	QDL22225	QGL22225	QJL22225		
250 A <sup>[22]</sup>	1200 A	2400 A	QBL22250	QDL22250	QGL22250	QJL22250		
<b>3P, 240 Vac</b>								
70 A	1000 A	1800 A	QBL32070	QDL32070	QGL32070	QJL32070		#4 AWG - 300 kcmil Al/Cu
80 A	1000 A	1800 A	QBL32080	QDL32080	QGL32080	QJL32080		
90 A	1000 A	1800 A	QBL32090	QDL32090	QGL32090	QJL32090		
100 A	1200 A	2400 A	QBL32100	QDL32100	QGL32100	QJL32100		
110 A	1200 A	2400 A	QBL32110	QDL32110	QGL32110	QJL32110		
125 A	1200 A	2400 A	QBL32125	QDL32125	QGL32125	QJL32125		
150 A	1200 A	2400 A	QBL32150	QDL32150	QGL32150	QJL32150		
175 A	1200 A	2400 A	QBL32175	QDL32175	QGL32175	QJL32175		
200 A	1200 A	2400 A	QBL32200	QDL32200	QGL32200	QJL32200		
225 A	1200 A	2400 A	QBL32225	QDL32225	QGL32225	QJL32225		
250 A <sup>[23]</sup>	1200 A	2400 A	QBL32250	QDL32250	QGL32250	QJL32250		

**Table 7.61: Q-Frame Interrupting Ratings**

Voltage	Interrupting Rating			
	B	D	G	J
240 Vac	10 kA	25 kA	65 kA	100 kA <sup>[24]</sup>

**Table 7.62: Q-Frame Termination Options**

Termination Letter	
A = I-Line (See Section 9—Panelboards)	Q G L 3 2 2 0 0
E = Bolt-on I-Line (See Section 9)	For factory-installed termination, place termination letter in the third block of the circuit breaker catalog number.
F = No lugs	
L = Lugs both ends	
M = Lugs ON end, studs on OFF end	
P = Lugs OFF end, studs on ON end	

Dimension see page 7-87

Enclosures see page 7-88

<sup>[20]</sup> Replacement lugs and electrical accessories are not available for PowerPact Q-frame circuit breakers.

<sup>[21]</sup> Q-frame can be used as main or sub-feed circuit breaker in a NQ panelboard.

<sup>[22]</sup> 250 A lugs are suitable for copper conductors only.

<sup>[23]</sup> 250 A circuit breakers are suitable for copper conductors only.

<sup>[24]</sup> 3P QJ circuit breakers are rated at 208Y/120 Vac only.



Q4L  
2P and 3P  
250-400 A

**Q4-Frame Molded Case Circuit Breaker (400 A)**

- Thermal magnetic protection from 250 A up to 400 A at 240 Vac
- 2- and 3-pole unit mount and I-Line constructions
- 25 kA at 240 Vac UL interrupting rating
- UL, CSA and IEC certified

**NOTE:** Consider using PowerPact™ circuit breakers for situations requiring circuit breaker accessories. See [PowerPact Accessories](#), page 7-51 for more information.

**Table 7.63: Q4-Frame, 400 A, Thermal-Magnetic Circuit Breakers, Individually-Mounted, 240 Vac**

Ampere Rating	Adjustable AC Magnetic Trip [25]		Standard Interrupting Cat. No.	Terminal Wire Range
	Low	High		
<b>2P, 240 Vac</b>				
250	1250 A	2500 A	Q4L2250	AL400LA (1) 1 AWG–600 kcmil Al or (2) 1 AWG–250 kcmil Al
300	1500 A	3000 A	Q4L2300	
350	1750 A	3500 A	Q4L2350	
400	2000 A	4000 A	Q4L2400	
<b>3P, 240 Vac</b>				
250	1250 A	2500 A	Q4L3250	AL400LA (1) 1 AWG–600 kcmil Al or (2) 1 AWG–250 kcmil Al
300	1500 A	3000 A	Q4L3300	
350	1750 A	3500 A	Q4L3350	
400	2000 A	4000 A	Q4L3400	

Accessories see [PowerPact Accessories](#), page 7-51 through [Plug-In and Drawout Mountings](#), page 7-60

Optional Lugs see [Mechanical Lugs](#), page 7-56

Dimensions see [Dimensions and Shipping Weights](#), page 7-86

Enclosures see [Circuit Breaker Enclosures](#), page 7-88



LA/LHL  
2P and 3P 125-400 A

**LAL/LH-Frame Molded Case Circuit Breaker (600 A)**

- Thermal magnetic protection from 125-400 A up to 600 Vac and 250 Vdc
- 2- and 3-pole unit mount and I-Line constructions
- UL listed interrupting ratings from 30 kA to 35 kA at 480 Vac
- UL, CSA and IEC certified

**NOTE:** Consider using PowerPact™ circuit breakers for situations requiring circuit breaker accessories. See [PowerPact Accessories](#), page 7-51 for more information.

**Table 7.64: L-Frame, 600 A, Thermal-Magnetic, Individually-Mounted Circuit Breakers, 600 Vac**

Ampere Rating	Adjustable AC Magnetic Trip		Cat. No.		Terminal Wire Range
	Low	High	Standard Interrupting	High Interrupting	
<b>2P, 600 Vac, 250 Vdc</b>					
125 A	625 A	1250 A	LAL26125	LHL26125	AL400LA (1) 1 AWG–600 kcmil Al or (2) 1 AWG–250 kcmil Al
150 A	750 A	1500 A	LAL26150	LHL26150	
175 A	875 A	1750 A	LAL26175	LHL26175	
200 A	1000 A	2000 A	LAL26200	LHL26200	
225 A	1125 A	2250 A	LAL26225	LHL26225	
250 A	1250 A	2500 A	LAL26250	LHL26250	
300 A	1500 A	3000 A	LAL26300	LHL26300	
350 A	1750 A	3500 A	LAL26350	LHL26350	
400 A	2000 A	4000 A	LAL26400	LHL26400	
<b>3P, 600 Vac, 250 Vdc</b>					
125 A	625 A	1250 A	LAL36125	LHL36125	AL400LA (1) 1 AWG–600 kcmil Al or (2) 1 AWG–250 kcmil Al
150 A	750 A	1500 A	LAL36150	LHL36150	
175 A	875 A	1750 A	LAL36175	LHL36175	
200 A	1000 A	2000 A	LAL36200	LHL36200	
225 A	1125 A	2250 A	LAL36225	LHL36225	
250 A	1250 A	2500 A	LAL36250	LHL36250	
300 A	1500 A	3000 A	LAL36300	LHL36300	
350 A	1750 A	3500 A	LAL36350	LHL36350	
400 A	2000 A	4000 A	LAL36400	LHL36400	

**Table 7.65: Interrupting Ratings**

Voltage	LAL	LHL
240 Vac	42 kA	65 kA
480 Vac	30 kA	35 kA
600 Vac	22 kA	25 kA

Accessories see [PowerPact Accessories](#), page 7-51 through [Plug-In and Drawout Mountings](#), page 7-60

Optional Lugs see [Mechanical Lug Information](#), page Supplemental Digest Section 3.

Dimensions see [Dimensions and Shipping Weights](#), page 7-86

Enclosures see [Circuit Breaker Enclosures](#), page 7-88

[25] UL magnetic trip setting tolerances are ±25% for low and ±20% for high from nominal value shown.

**PowerPact L-Frame Molded Case Circuit Breakers (600 A)**

A flexible, high performance offer certified to global standards.

- Basic Electronic and MicroLogic trip protection from 250–600 Vac
- 2-, 3- and 4-pole design; wide range of trip units to protect most applications
- High performance UL listed interrupting ratings from 35 kA to 200 kA at 480 Vac
- Standard (80%) or 100% rating
- UL, CSA, NOM, IEC, CCC certified and CE marked for global acceptance



PowerPact L-Frame with MicroLogic™ Trip Unit

**Table 7.66: PowerPact L-Frame 600 A, (80% Rated) UL Current-Limiting [26] Circuit Breakers (600 Vac) with Lugs and Factory-Sealed Electronic Trip Units Suitable for Reverse Connection [27]**

Electronic Trip Unit		Ampere Rating	Instantaneous Adjustment		Interrupting	J Interrupting
Type	Protection		Low	High	Cat. No.	Cat. No.
2P, 600 Vac 50/60 Hz						
Basic	Electronic with Fixed Long-time, Adjustable Instantaneous Trip	250	1.5x	12x	LGL26250	LJL26250
		300	1.5x	12x	LGL26300	LJL26300
		350	1.5x	12x	LGL26350	LJL26350
		400	1.5x	12x	LGL26400	LJL26400
		500	1.5x	11x	LGL26500	LJL26500
		600	1.5x	11x	LGL26600	LJL26600
3P, 600 Vac 50/60 Hz						
Basic	Electronic with Fixed Long-time, Adjustable Instantaneous Trip	250	1.5x	12x	LGL36250	LJL36250
		300	1.5x	12x	LGL36300	LJL36300
		350	1.5x	12x	LGL36350	LJL36350
		400	1.5x	12x	LGL36400	LJL36400
		500	1.5x	11x	LGL36500	LJL36500
		600	1.5x	11x	LGL36600	LJL36600

**Table 7.67: L-Frame 600 A Standard (80% Rated) UL Current-Limiting [26] Circuit Breakers (600 Vac) with Lugs and Factory-Sealed Electronic Trip Units Suitable for Reverse Connection [28][27]**

Electronic Trip Unit			Sensor Rating	Interrupting Rating (80% Rated)				
Type	Function	Trip Unit		G	J [26]	L [26]	R [26]	Terminal
600 Vac, 50/60 Hz, 3P								
MicroLogic Standard	LI	3.3 [29]	250 A	LGL36250U31X	LJL36250U31X	LLL36250U31X	LRL36250U31X	AL400L61K3 [30]
			400 A	LGL36400U31X	LJL36400U31X	LLL36400U31X	LRL36400U31X	
			600 A	LGL36600U31X	LJL36600U31X	LLL36600U31X	LRL36600U31X	
MicroLogic Standard	LSI	3.3S [29] [31]	250 A	LGL36250U33X	LJL36250U33X	LLL36250U33X	LRL36250U33X	AL400L61K3 [32]
			400 A	LGL36400U33X	LJL36400U33X	LLL36400U33X	LRL36400U33X	
			600 A	LGL36600U33X	LJL36600U33X	LLL36600U33X	LRL36600U33X	
MicroLogic Ammeter	LSI	5.3A	400 A	LGL36400U43X	LJL36400U43X	LLL36400U43X	LRL36400U43X	AL600LS52K3
			600 A	LGL36600U43X	LJL36600U43X	LLL36600U43X	LRL36600U43X	
MicroLogic Energy	LSI	5.3E	400 A	LGL36400U53X	LJL36400U53X	LLL36400U53X	LRL36400U53X	
			600 A	LGL36600U53X	LJL36600U53X	LLL36600U53X	LRL36600U53X	
MicroLogic Ammeter	LSIG	6.3A	400 A	LGL36400U44X	LJL36400U44X	LLL36400U44X	LRL36400U44X	
			600 A	LGL36600U44X	LJL36600U44X	LLL36600U44X	LRL36600U44X	
MicroLogic Energy	LSIG	6.3E [33]	400 A	LGL36400U54X	LJL36400U54X	LLL36400U54X	LRL36400U54X	
			600 A	LGL36600U54X	LJL36600U54X	LLL36600U54X	LRL36600U54X	
600 Vac, 50/60 Hz, 4P								
MicroLogic Standard	LI	3.3	250 A	LGL46250U31X	LJL46250U31X	LLL46250U31X	LRL46250U31X	AL400L61K4
			400 A	LGL46400U31X	LJL46400U31X	LLL46400U31X	LRL46400U31X	
			600 A	LGL46600U31X	LJL46600U31X	LLL46600U31X	LRL46600U31X	
MicroLogic Standard	LSI	3.3S [31]	250 A	LGL46250U33X	LJL46250U33X	LLL46250U33X	LRL46250U33X	AL400L61K4
			400 A	LGL46400U33X	LJL46400U33X	LLL46400U33X	LRL46400U33X	
			600 A	LGL46600U33X	LJL46600U33X	LLL46600U33X	LRL46600U33X	
MicroLogic Ammeter	LSI	5.3A	400 A	LGL46400U43X	LJL46400U43X	LLL46400U43X	LRL46400U43X	AL600LS52K4
			600 A	LGL46600U43X	LJL46600U43X	LLL46600U43X	LRL46600U43X	
MicroLogic Energy	LSI	5.3E	400 A	LGL46400U53X	LJL46400U53X	LLL46400U53X	LRL46400U53X	
			600 A	LGL46600U53X	LJL46600U53X	LLL46600U53X	LRL46600U53X	
MicroLogic Ammeter	LSIG	6.3A	400 A	LGL46400U44X	LJL46400U44X	LLL46400U44X	LRL46400U44X	
			600 A	LGL46600U44X	LJL46600U44X	LLL46600U44X	LRL46600U44X	
MicroLogic Energy	LSIG	6.3E	400 A	LGL46400U54X	LJL46400U54X	LLL46400U54X	LRL46400U54X	
			600 A	LGL46600U54X	LJL46600U54X	LLL46600U54X	LRL46600U54X	

[26] Circuit breakers with J, L, and R interrupting ratings are UL certified as current limiting.

[27] For applications requiring communications see page 7-64.

[28] See Supplemental Digest Section 3 for circuit breakers with field interchangeable trip units.

[29] 3P circuit breakers with this trip unit can be used for 2P applications.

[30] AL600LS52K3 terminal wire range is (2) 2/0 AWG 500 kcmil Al/Cu

[31] Fixed ST and LT delays.

[32] AL400L61K3 terminal wire ranges are (1) 2 AWG–600 kcmil Cu or (1) 2 AWG–500 kcmil Al.

[33] 3-pole circuit breakers can be used for 2-pole applications. (For such instances, MicroLogic 6.2 Ammeter and Energy trip units can be used for ground fault protection. Additional metering capabilities are not guaranteed when using MicroLogic Ammeter and Energy trip units for this type of application.)

**Table 7.68: L-Frame 600 A 100% Rated UL Current-Limiting [34] Circuit Breakers with Lugs and Factory-Sealed Electronic Trip Units Suitable for Reverse Connection [35][36]**

Electronic Trip Unit			Sensor Rating	Interrupting Rating (100% Rated)					Terminal
Type	Function	Trip Unit		D	G	J [34]	L [34]	R [34]	
600 Vac, 50/60 Hz, 3P									
MicroLogic Standard	LI	3.3 [37]	250 A	LDL36250CU31X	LGL36250CU31X	LJL36250CU31X	LLL36250CU31X	LRL36250CU31X	AL400L61K3
			400 A	LDL36400CU31X	LGL36400CU31X	LJL36400CU31X	LLL36400CU31X	LRL36400CU31X	AL600LS52K3
MicroLogic Standard	LSI	3.3S [37] [38]	250 A	LDL36250CU33X	LGL36250CU33X	LJL36250CU33X	LLL36250CU33X	LRL36250CU33X	AL400L61K3
			400 A	LDL36400CU33X	LGL36400CU33X	LJL36400CU33X	LLL36400CU33X	LRL36400CU33X	AL600LS52K3
MicroLogic Ammeter	LSI	5.3A	400 A	LDL36400CU43X	LGL36400CU43X	LJL36400CU43X	LLL36400CU43X	LRL36400CU43X	AL600LS52K3
MicroLogic Energy	LSI	5.3E	400 A	LDL36400CU53X	LGL36400CU53X	LJL36400CU53X	LLL36400CU53X	LRL36400CU53X	
MicroLogic Ammeter	LSIG	6.3A	400 A	LDL36400CU44X	LGL36400CU44X	LJL36400CU44X	LLL36400CU44X	LRL36400CU44X	
MicroLogic Energy	LSIG	6.3E [39]	400 A	LDL36400CU54X	LGL36400CU54X	LJL36400CU54X	LLL36400CU54X	LRL36400CU54X	
600 Vac, 50/60 Hz, 4P									
MicroLogic Standard	LI	3.3	250 A	LDL46250CU31X	LGL46250CU31X	LJL46250CU31X	LLL46250CU31X	LRL46250CU31X	AL400L61K4
			400 A	LDL46400CU31X	LGL46400CU31X	LJL46400CU31X	LLL46400CU31X	LRL46400CU31X	AL600LS52K4
MicroLogic Standard	LSI	3.3S	250 A	LDL46250CU33X	LGL46250CU33X	LJL46250CU33X	LLL46250CU33X	LRL46250CU33X	AL400L61K4
			400 A	LDL46400CU33X	LGL46400CU33X	LJL46400CU33X	LLL46400CU33X	LRL46400CU33X	AL600LS52K4
MicroLogic Ammeter	LSI	5.3A	400 A	LDL46400CU43X	LGL46400CU43X	LJL46400CU43X	LLL46400CU43X	LRL46400CU43X	AL600LS52K4
MicroLogic Energy	LSI	5.3E	400 A	LDL46400CU53X	LGL46400CU53X	LJL46400CU53X	LLL46400CU53X	LRL46400CU53X	
MicroLogic Ammeter	LSIG	6.3A	400 A	LDL46400CU44X	LGL46400CU44X	LJL46400CU44X	LLL46400CU44X	LRL46400CU44X	
MicroLogic Energy	LSIG	6.3E	400 A	LDL46400CU54X	LGL46400CU54X	LJL46400CU54X	LLL46400CU54X	LRL46400CU54X	

**Table 7.69: PowerPact L-Frame Terminal Wire Ranges**

Terminal	Wire Range
AL400L61K3	(1) 2 AWG–600 kcmil Cu or 1) 2 AWG–500 kcmil Al.
AL600LS52K3	(2) 2/0 AWG–500 kcmil Al/Cu.

**Table 7.70: PowerPact L-Frame Termination Options**

Termination Letter	Termination Option
A	I-Line (See Section 9—Panelboards)
F	No lugs
L	Lugs both ends
M	Lugs ON end, terminal nut kit OFF end
P	Lugs OFF end, terminal nut kit ON end
N	Plug In
D	Drawout
S	Rear Connected

For factory-installed termination, place termination letter in the third block of the circuit breaker catalog number.  
Termination Letter  
L G L 3 6 6 0 0 U 4 4 X

**Table 7.71: Powerpact L-Frame Interrupting Ratings**

Voltage	Interrupting Rating				
	D	G	J	L	R
240 Vac	25 kA	65 kA	100 kA	125 kA	200 kA
480 Vac	18 kA	35 kA	65 kA	100 kA	200 kA
600 Vac	14 kA	18 kA	25 kA	50 kA	100 kA

Accessories see page 7-51  
Optional Lugs see page 7-56  
Dimensions see page 7-87  
Enclosures see page 7-88

[34] Circuit breakers with J, L, and R interrupting ratings are UL certified as current limiting.  
[35] See Supplemental Digest Section 3 for circuit breakers with field interchangeable trip units.  
[36] For applications requiring communications see page 7-64.  
[37] 3P circuit breakers with this trip unit can be used for 2P applications.  
[38] Fixed ST and LT delays.  
[39] 3-pole circuit breakers can be used for 2-pole applications. (For such instances, MicroLogic 6.2 Ammeter and Energy trip units can be used for ground fault protection. Additional metering capabilities are not guaranteed when using MicroLogic Ammeter and Energy trip units for this type of application.)



PowerPact M-Frame Circuit Breaker with Basic Electronic Trip Unit

**PowerPact M-Frame Molded Case Circuit Breakers (800 A)**

PowerPact M-frame circuit breakers use an electronic trip system with the simplicity of a thermal magnetic breaker.

- Basic electronic trip protection from 300 to 800 A up to 600 Vac
- 2- and 3-pole unit mount and I-line construction
- UL listed interrupting ratings from 35 to 65 kA at 480 Vac
- Common mounting holes, handle locations and trim dimensions with shared auxiliaries and accessories with P-frame devices
- Available in standard (80%) rating only
- UL, CSA, NOM, CCC and IEC certified and CE marked for global acceptance

**Table 7.72: M-Frame 800 A, Basic Electronic Trip System Type ET 1.0 [40] Factory-Sealed Trip Unit**

Electronic Trip Unit		Ampere Rating	Adjustable Instantaneous Trip Range		Interrupting Rating	
Type	Function		Low	High	G	J
2P, 600 Vac 50/60 Hz						
Basic	Fixed Long-time, Adjustable Instantaneous Trip	400 A	800	4000	MGL26400	MJL26400
		600 A	1200	6000	MGL26800[41]	MJL26800[41]
3P, 600 Vac 50/60 Hz						
Basic	Fixed Long-time, Adjustable Instantaneous Trip	400 A	800	4000	MGL36400	MJL36400
		600 A	1200	6000	MGL36800[41]	MJL36800[41]

**Table 7.73: M-Frame 800 A, Adjustable Amperage Electronic Trip Unit**

Electronic Trip Unit		Adjustable Long-Time Settings	Adjustable Instantaneous		Interrupting Rating	
Type	Function		Low	High	G	J
2P, 600 Vac 50/60 Hz						
Basic	Adjustable Long-Time Adjustable Instantaneous Trip	300–800	2x	10x	MGL26800E10	MJL26800E10
3P, 600 Vac 50/60 Hz						
Basic	Adjustable Long-Time Adjustable Instantaneous Trip	300–800	2x	10x	MGL36800E10	MJL36800E10

**Table 7.74: M-Frame Termination Options**

Termination Letter	Termination Option
A	I-Line (See Section 9—Panelboards)
F	No lugs
L	Lugs both ends
M	Lugs ON end, terminal nut kit OFF end
P	Lugs OFF end, terminal nut kit ON end

M G L 3 6 4 0 0  
For factory-installed termination, place termination letter in the third block of the circuit breaker catalog number.

**Table 7.75: PowerPact M-Frame Interrupting Ratings**

Voltage	Interrupting Rating	
	G	J
240 Vac	65 kA	100 kA
480 Vac	35 kA	65 kA
600 Vac	18 kA	25 kA

Accessories see page 7-51  
Optional Lugs see page 7-56

Dimensions see page 7-87  
Enclosures see page 7-88

[40] The ET 1.0 trip unit cannot be field replaced or have the long-time trip point setting adjusted. It is considered an electronic equivalent of a thermal-magnetic circuit breaker.  
[41] This item is entering obsolescence. The purchase opportunity will extend until December 2021.



P-Frame 1200 A Unit-Mount      Electrically Operated P-Frame 800 A Unit-Mount

**Table 7.76: P-Frame Interrupting Ratings**

Voltage	P-Frame Interrupting Rating			
	G	J	K	L
240 Vac	65 kA	100 kA	65 kA	125 kA
480 Vac	35 kA	65 kA	50 kA	100 kA
600 Vac	18 kA	25 kA	50 kA	25 kA

**Table 7.77: P-Frame Termination Options**

Termination Letter
A = I-Line (See Section 9—Panelboards)
D = Drawout
F = No Lugs (Includes terminal nut kit on both ends)
L = Lugs both ends
M = Lugs ON end, terminal nut kit OFF end
P = Lugs OFF end, terminal nut kit ON end
P G L 3 6 0 4 0 U 4 1 A
For factory-installed termination, place termination letter in the third block of the circuit breaker catalog number.

Dimensions see page 7-87

Trip Unit Options see page 7-62

Optional Lugs see page 7-56

Alternate Rating Plugs see page 7-64

Enclosures see page 7-88

Accessories see page 7-51

**PowerPact P-Frame Molded Case Circuit Breakers (1200 A)**

- MicroLogic trip protection from 250 to 1200 A up to 600 Vac
- 2-, 3- and 4-pole unit-mount construction
- UL listed interrupting ratings from 35 kA to 100 kA at 480 Vac
- Same dimensions, common mounting, bussing, cabling and door cut-out as PowerPact M-frame circuit breakers
- Standard (80%) and 100% rating
- UL, CSA, NOM, CCC and IEC certified and CE marked for global acceptance

**Table 7.78: P-Frame 1200 A (600 Vac, 50/60 Hz) 3P [42] Circuit Breaker with Electronic Trip Unit**

Type	Electronic Trip Unit		Sensor Rating	Cat. No.[43]	Terminal Wire Range
	Function	Trip Unit			
Basic Electronic Trip Unit (Not Interchangeable)	Fixed long-time, Adjustable Instantaneous	E-T1.01	600 A	P■L36060	AL800M23K (3) 3/0 AWG–500 kcmil Al or Cu
			800 A	P■L36080	
			1000 A	P■L36100	AL1200P25K
			1200 A	P■L36120	(4) 3/0 AWG–500 kcmil Al or Cu
MicroLogic Interchangeable Standard Trip Unit	LI	3.0	250 A	P■L36025(C)U31A	AL800M23K (3) 3/0 AWG–500 kcmil Al or Cu
			400 A	P■L36040(C)U31A	
			600 A	P■L36060(C)U31A	
			800 A	P■L36080(C)U31A	
			1000 A	P■L36100(C)U31A	
			1200 A	P■L36120(C)U31A	
	LSI	5.0	250 A	P■L36025(C)U33A	AL800M23K (3) 3/0 AWG–500 kcmil Al or Cu
			400 A	P■L36040(C)U33A	
			600 A	P■L36060(C)U33A	
			800 A	P■L36080(C)U33A	
			1000 A	P■L36100(C)U33A	
			1200 A	P■L36120(C)U33A	
MicroLogic Interchangeable Ammeter Trip Unit	LI	3.0A	250 A	P■L36025(C)U41A	AL800M23K (3) 3/0 AWG–500 kcmil Al or Cu
			400 A	P■L36040(C)U41A	
			600 A	P■L36060(C)U41A	
			800 A	P■L36080(C)U41A	
			1000 A	P■L36100(C)U41A	
			1200 A	P■L36120(C)U41A	
	LSI	5.0A	250 A	P■L36025(C)U43A	AL800M23K (3) 3/0 AWG–500 kcmil Al or Cu
			400 A	P■L36040(C)U43A	
			600 A	P■L36060(C)U43A	
			800 A	P■L36080(C)U43A	
			1000 A	P■L36100(C)U43A	
			1200 A	P■L36120(C)U43A	
LSIG	6.0A	250 A	P■L36025(C)U44A	AL800M23K (3) 3/0 AWG–500 kcmil Al or Cu	
		400 A	P■L36040(C)U44A		
		600 A	P■L36060(C)U44A		
		800 A	P■L36080(C)U44A		
		1000 A	P■L36100(C)U44A		
		1200 A	P■L36120(C)U44A		AL1200P25K (4) 3/0 AWG–500 kcmil Al or Cu
MicroLogic Interchangeable Power Trip Unit	LSI	5.0P	250 A	P■L36025(C)U63AE1	AL800M23K (3) 3/0 AWG–500 kcmil Al or Cu
			400 A	P■L36040(C)U63AE1	
			600 A	P■L36060(C)U63AE1	
			800 A	P■L36080(C)U63AE1	
			1000 A	P■L36100(C)U63AE1	
			1200 A	P■L36120(C)U63AE1	
	LSIG	6.0P	250 A	P■L36025(C)U64AE1	AL800M23K (3) 3/0 AWG–500 kcmil Al or Cu
			400 A	P■L36040(C)U64AE1	
			600 A	P■L36060(C)U64AE1	
			800 A	P■L36080(C)U64AE1	
			1000 A	P■L36100(C)U64AE1	
			1200 A	P■L36120(C)U64AE1	
MicroLogic Interchangeable Harmonic Trip Unit	LSI	5.0H	250 A	P■L36025(C)U73AE1	AL800M23K (3) 3/0 AWG–500 kcmil Al or Cu
			400 A	P■L36040(C)U73AE1	
			600 A	P■L36060(C)U73AE1	
			800 A	P■L36080(C)U73AE1	
			1000 A	P■L36100(C)U73AE1	
			1200 A	P■L36120(C)U73AE1	
	LSIG	6.0H	250 A	P■L36025(C)U74AE1	AL800M23K (3) 3/0 AWG–500 kcmil Al or Cu
			400 A	P■L36040(C)U74AE1	
			600 A	P■L36060(C)U74AE1	
			800 A	P■L36080(C)U74AE1	
			1000 A	P■L36100(C)U74AE1	
			1200 A	P■L36120(C)U74AE1	

[42] For 2P and 4P information see Catalog 0612CT0101.

[43] To complete the catalog number:

Replace the ■ with the appropriate interrupting rating (G, J, K or L).

For all L interrupting ratings, change the 5th character (voltage rating) from a 6 (600 V) to a 4 (480V). The 480 V AIR is standard 100 kA.

For 100% rated circuit breakers, add a "C" in the 9th character place. For example, the catalog number for a 100% rated trip unit with LI trip functions at 250 A would be PBL36025CU31A.



R-Frame Unit-Mount

Table 7.79: R-Frame Interrupting Ratings

Voltage	R-Frame Interrupting Rating			
	G	J	K	L
240 Vac	65 kA	100 kA	65 kA	125 kA
480 Vac	35 kA	65 kA	65 kA	100 kA
600 Vac	18 kA	25 kA	65 kA	50 kA

Table 7.80: R-Frame Termination Options

Termination Letter
A = I-Line (See Section 9—Panelboards)
F = No Lugs (Includes terminal nut kit on both ends)
RJ F 3 6 3 0 0 U 4 1 A
For factory-installed termination, place termination letter in the third block of the circuit breaker catalog number.

Dimensions see [page 7-87](#)  
 Trip Unit Options see [page 7-62](#)  
 Optional Lugs see [page 7-56](#)  
 Alternate Rating Plugs see [page 7-64](#)  
 Enclosures see [page 7-88](#)  
 Accessories see [page 7-51](#)

PowerPact R-Frame Molded Case Circuit Breakers (3000 A)

- MicroLogic electronic trip protection from 600–3000A up to 600 Vac
- 2-, 3- and 4-pole construction
- UL listed interrupting ratings from 35 to 100 kA at 480Vac
- Built-in Modbus protocol
- Standard (80%) and 100% rating
- UL, CSA, NOM, CCC and IEC certified and CE marked for global acceptance

Table 7.81: R-Frame 3000 A (600 Vac, 50/60 Hz) 3P Circuit Breaker with Electronic Trip Unit

Type	Electronic Trip Unit [44]		Sensor Rating	Cat. No. [45]
	Function	Trip Unit		
Basic Electronic Trip Unit (Not Interchangeable)	Fixed long-time, Adjustable Instantaneous	ET1.0I	1200 A	R■F36120
			1600 A	R■F36160
			2000 A	R■F36200
			2500 A	R■F36250
MicroLogic Interchangeable Standard Trip Unit	LI	3.0	600 A	R■F36060(C)U31A
			800 A	R■F36080(C)U31A
			1000 A	R■F36100(C)U31A
			1200 A	R■F36120(C)U31A
			1600 A	R■F36160(C)U31A
			2000 A	R■F36200(C)U31A
			2500 A	R■F36250(C)U31A
			3000 A	R■F36300(C)U31A
	LSI	5.0	600 A	R■F36060(C)U33A
			800 A	R■F36080(C)U33A
			1000 A	R■F36100(C)U33A
			1200 A	R■F36120(C)U33A
			1600 A	R■F36160(C)U33A
			2000 A	R■F36200(C)U33A
			2500 A	R■F36250(C)U33A
			3000 A	R■F36300(C)U33A
MicroLogic Interchangeable Ammeter Trip Unit	LI	3.0A	600 A	R■F36060(C)U41A
			800 A	R■F36080(C)U41A
			1000 A	R■F36100(C)U41A
			1200 A	R■F36120(C)U41A
			1600 A	R■F36160(C)U41A
			2000 A	R■F36200(C)U41A
			2500 A	R■F36250(C)U41A
			3000 A	R■F36300(C)U41A
	LSI	5.0A	600 A	R■F36060(C)U43A
			800 A	R■F36080(C)U43A
			1000 A	R■F36100(C)U43A
			1200 A	R■F36120(C)U43A
			1600 A	R■F36160(C)U43A
			2000 A	R■F36200(C)U43A
			2500 A	R■F36250(C)U43A
			3000 A	R■F36300(C)U43A
LSIG	6.0A	600 A	R■F36060(C)U44A	
		800 A	R■F36080(C)U44A	
		1000 A	R■F36100(C)U44A	
		1200 A	R■F36120(C)U44A	
		1600 A	R■F36160(C)U44A	
		2000 A	R■F36200(C)U44A	
		2500 A	R■F36250(C)U44A	
		3000 A	R■F36300(C)U44A	
MicroLogic Interchangeable Power Trip Unit	LSI	5.0P	600 A	R■F36060(C)U63AE1
			800 A	R■F36080(C)U63AE1
			1000 A	R■F36100(C)U63AE1
			1200 A	R■F36120(C)U63AE1
			1600 A	R■F36160(C)U63AE1
			2000 A	R■F36200(C)U63AE1
			2500 A	R■F36250(C)U63AE1
			3000 A	R■F36300(C)U63AE1
	LSIG	6.0P	600 A	R■F36060(C)U64AE1
			800 A	R■F36080(C)U64AE1
			1000 A	R■F36100(C)U64AE1
			1200 A	R■F36120(C)U64AE1
			1600 A	R■F36160(C)U64AE1
			2000 A	R■F36200(C)U64AE1
			2500 A	R■F36250(C)U64AE1
			3000 A	R■F36300(C)U64AE1
MicroLogic Interchangeable Harmonic Trip Unit	LSI	5.0H	600 A	R■F36060(C)U73AE1
			800 A	R■F36080(C)U73AE1

[44] For 2P and 4P information see Catalog 0612CT0101.

[45] To complete the catalog number: Replace the ■ with the appropriate interrupting rating (G, J, K or L); For 100% rated circuit breakers, add a "C" in the 9th character place. For example, the catalog number for a 100% rated trip unit with LI trip functions at 2500 A would be RGF36025CU31A.

**Table 7.81 R-Frame 3000 A (600 Vac, 50/60 Hz) 3P Circuit Breaker with Electronic Trip Unit (cont'd.)**

Electronic Trip Unit [46]			Sensor Rating	Cat. No. [47]
Type	Function	Trip Unit		
			1000 A	R■F36100(C)U73AE1
			1200 A	R■F36120(C)U73AE1
			1600 A	R■F36160(C)U73AE1
			2000 A	R■F36200(C)U73AE1
			2500 A	R■F36250(C)U73AE1
			3000 A	R■F36300(C)U73AE1
	LSIG	6.0H	600 A	R■F36060(C)U74AE1
			800 A	R■F36080(C)U74AE1
			1000 A	R■F36100(C)U74AE1
			1200 A	R■F36120(C)U74AE1
			1600 A	R■F36160(C)U74AE1
			2000 A	R■F36200(C)U74AE1
			2500 A	R■F36250(C)U74AE1
			3000 A	R■F36300(C)U74AE1

**Unit-Mount R-Frame Standard Bus Connection**

R-frame circuit breakers can be bus- or cable-connected.

- For cable connections, an optional terminal pad kit RLTB or equivalent bus structure is required.
- RLTB kits comes standard with bus bar connections.

**RLTB / RT3B Kits**

- RLTB kits are included with 2500 A 100% rated circuit breakers.
- Each kit contains terminal pads for one end of the circuit breaker only
- Has provisions for mounting a maximum of 8 lugs per phase (9 lugs for 3000 A).
- RL3TB kits are included with the 3000 A, 80% and 100% rated circuit breakers.

R-Frame I-Line circuit breakers come with lugs on the load side. (See Panelboards—Section 9).

For other circuit breakers, order terminal pad kit (RLTB) and optional lugs separately. See [Terminal Nuts](#), [Terminal Pads](#), [Terminal Shields and Accessories](#), page 7-59 and [Mechanical Lugs](#), page 7-56.

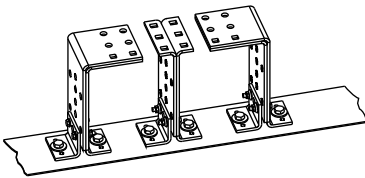

RLTB Terminal Pad Kit

[46] For 2P and 4P information see Catalog 0612CT0101.

[47] To complete the catalog number: Replace the ■ with the appropriate interrupting rating (G, J, K or L.); For 100% rated circuit breakers, add a "C" in the 9th character place. For example, the catalog number for a 100% rated trip unit with LI trip functions at 2500 A would be RGF36025CU31A.





PowerPact J-Frame

**PowerPact Mission Critical Circuit Breakers**

Delivering high levels of selective coordination in a flexible design that can be easily configured for a variety of applications.

- Adjustable long-time settings in three sensor sizes provide coverage from 70-600 A on 120-240, 208Y/120, 240, and 480Y/277 Vac systems
- Undergone rigorous testing procedures to certify the coordination with downstream circuit breakers
- Available in J-Frame (250A) and L-Frame (600A)
- UL 489 listed, CSA Certified Voltage: 480Y/277V

**Table 7.82: J-Frame 250 A Electronic Trip Mission Critical 80% Rated Circuit Breakers (480/277 Vac) with Factory Sealed Trip Units Suitable for Reverse Connection**

Electronic Trip Unit Type	Trip Function	Trip Unit	Continuous Current	Cat. No.				Terminal
				D Interrupting	G Interrupting	J Interrupting	L Interrupting	
Standard	LI	3.2 W	250 A	JDL34250WU31X	JGL34250WU31X	JJL34250WU31X	JLL34250WU31X	AL250JD [1]
Standard	LSI	3.2S-W	250 A	JDL34250WU33X	JGL34250WU33X	JJL34250WU33X	JLL34250WU33X	AL250JD [1]
High Perf. Ammeter	LSI	5.2A-W	250 A	JDL34250WU43X	JGL34250WU43X	JJL34250WU43X	JLL34250WU43X	AL250JD [1]
High Perf. Energy	LSI	5.2E-W	250 A	JDL34250WU53X	JGL34250WU53X	JJL34250WU53X	JLL34250WU53X	AL250JD [1]
High Perf. Ammeter	LSIG	6.2A-W	250 A	JDL34250WU44X	JGL34250WU44X	JJL34250WU44X	JLL34250WU44X	AL250JD [1]
High Perf. Energy	LSIG	6.2E-W	250 A	JDL34250WU54X	JGL34250WU54X	JJL34250WU54X	JLL34250WU54X	AL250JD [1]

**Table 7.83: L-Frame 600 A Electronic Trip Mission Critical Circuit Breakers (480/277 Vac) with Factory Sealed Trip Units Suitable for Reverse Connection [2]**

Electronic Trip Unit Type	Trip Function	Trip Unit	Continuous Current	Cat. No.				Terminal
				D Interrupting	G Interrupting	J Interrupting	L Interrupting	
480/277 Vac, 50/60 Hz, 3P								
Standard	LI	3.3 W	250 A	LDL34250WU31X	LGL34250WU31X	LJL34250WU31X	LLL34250WU31X	AL400L61K3 [3]
			400 A	LDL34400WU31X	LGL34400WU31X	LJL34400WU31X	LLL34400WU31X	AL600LS52K3 [4]
			600 A	LDL34600WU31X	LGL34600WU31X	LJL34600WU31X	LLL34300WU31X	
Standard	LSI	3.3S-W	250 A	LDL34250WU33X	LGL34250WU33X	LJL34250WU33X	LLL34250WU33X	AL400L61K3 [3]
			400 A	LDL34400WU33X	LGL34400WU33X	LJL34400WU33X	LLL34400WU33X	AL600LS52K3 [4]
			600 A	LDL34600WU33X	LGL34600WU33X	LJL34600WU33X	LLL34300WU33X	
High Perf. Ammeter	LSI	5.3A-W	400 A	LDL34400WU43X	LGL34400WU43X	LJL34400WU43X	LLL34400WU43X	AL600LS52K3 [4]
High Perf. Energy	LSI	5.3E-W	400 A	LDL34400WU53X	LGL34400WU53X	LJL34400WU53X	LLL34400WU53X	AL600LS52K3 [4]
			600 A	LDL34600WU53X	LGL34600WU53X	LJL34600WU53X	LLL34300WU53X	
			High Perf. Ammeter	LSIG	6.3A-W	400 A	LDL34400WU44X	LGL34400WU44X
High Perf. Energy	LSIG	6.3E-W	600 A	LDL34600WU44X	LGL34600WU44X	LJL34600WU44X	LLL34300WU44X	AL600LS52K3 [4]
			400 A	LDL34400WU54X	LGL34400WU54X	LJL34400WU54X	LLL34400WU54X	
			600 A	LDL34600WU54X	LGL34600WU54X	LJL34600WU54X	LLL34300WU54X	
480/277 Vac, 50/60 Hz, 4P								
Standard	LI	3.3 W	250 A	LDL44250WU31X	LGL44250WU31X	LJL44250WU31X	LLL44250WU31X	AL400L61K4 [3]
			400 A	LDL44400WU31X	LGL44400WU31X	LJL44400WU31X	LLL44400WU31X	AL600LS52K4 [4]
			600 A	LDL44600WU31X	LGL44600WU31X	LJL44600WU31X	LLL44300WU31X	
Standard	LSI	3.3S-W	250 A	LDL44250WU33X	LGL44250WU33X	LJL44250WU33X	LLL44250WU33X	AL400L61K4 [3]
			400 A	LDL44400WU33X	LGL44400WU33X	LJL44400WU33X	LLL44400WU33X	AL600LS52K4 [4]
			600 A	LDL44600WU33X	LGL44600WU33X	LJL44600WU33X	LLL44300WU33X	
High Perf. Ammeter	LSI	5.3A-W	400 A	LDL44400WU43X	LGL44400WU43X	LJL44400WU43X	LLL44400WU43X	AL600LS52K4 [4]
High Perf. Energy	LSI	5.3E-W	400 A	LDL44400WU53X	LGL44400WU53X	LJL44400WU53X	LLL44400WU53X	AL600LS52K3 [4]
			600 A	LDL44600WU53X	LGL44600WU53X	LJL44600WU53X	LLL44300WU53X	
			High Perf. Ammeter	LSIG	6.3A-W	400 A	LDL44400WU44X	LGL44400WU44X
High Perf. Energy	LSIG	6.3E-W	600 A	LDL44600WU44X	LGL44600WU44X	LJL44600WU44X	LLL44300WU44X	AL600LS52K4 [4]
			400 A	LDL44400WU54X	LGL44400WU54X	LJL44400WU54X	LLL44400WU54X	
			600 A	LDL44600WU54X	LGL44600WU54X	LJL44600WU54X	LLL44300WU54X	

**Table 7.84: Terminal Wire Ranges**

Terminal	Wire Range
AL250JD	(1) 3/0 AWG 350 kcmil AL or Cu
AL400L61K3	(1) #2 AWG–500 kcmil Al or (1) #2 AWG–600 kcmil Cu.
AL600LS52K3	(2) 2/0 AWG–500 kcmil Al or Cu.

Accessories see page 7-51  
 Optional Lugs see page 7-56  
 Compression and PDC Lugs see Supplemental Digest, Section 3  
 Dimensions see page 7-87  
 Enclosures see page 7-88

**Table 7.85: J- and L-Frame Termination Options**

Termination Letter	
A = I-Line (See Section 9)	J G L 3 6 1 0 0
F = No Lugs (includes terminal nut kit on both ends) [5]	For factory-installed termination, place termination letter in the third block of the circuit breaker catalog number.
L = Lugs both ends	Termination Letter
M = Lugs ON end Terminal Nut Kit OFF end	
P = Lugs OFF end Terminal Nut Kit ON end	
N = Plug-in	
D = Drawout	
S = Rear Connected	

**Table 7.86: J- and L-Frame Interrupting Ratings**

Voltage	Interrupting Rating			
	D	G	J	L
240 Vac	25 kA	65 kA	100 kA	125 kA
480 Vac	18 kA	35 kA	65 kA	100 kA

[1] AL250JD terminal wire range is (1) 3/0 AWG–350 kcmil Al or Cu.  
 [2] 100% rated for 250 A and 400 A. 80% rated for 600 A.  
 [3] AL400L61K3 terminal wire ranges are (1) #2 AWG–500 kcmil Al or (1) #2 AWG–600 kcmil Cu.  
 [4] AL600LS52K3 terminal wire ranges are (2) 2/0 AWG–500 kcmil Al or Cu.  
 [5] Add TS suffix for circuit breaker without terminal nut kit.

**PowerPact 500 Vdc Circuit Breakers**

Designed for use on ungrounded dc systems having a maximum short-circuit voltage of 500 Vdc or a maximum floating (unloaded) voltage of 600 Vdc. Suitable for use only with UPS (ungrounded uninterruptible power supplies systems).

This two-level voltage rating allows these circuit breakers to be applied to battery sources having a short-circuit availability of 20,000 amperes or 50,000 amperes for PowerPact H-, J-, and L-frame DC circuit breakers at 500 Vdc. IEC 500 Vdc rating is available on PowerPact J-frame circuit breakers.

PowerPact H-frame DC circuit breakers have a fixed magnetic trip system. PowerPact J- and L-frame DC circuit breakers are provided with an adjustable magnetic trip that is readily accessible by means of a single adjustment on the face of the circuit breaker.

PowerPact H- and J-frame circuit breakers are UL Listed for the interrupting ratings shown only if applied with three poles connected in series (series connection is external to circuit breaker). (See figure for example of diagram.)

PowerPact L-frame circuit breakers are UL Listed for the interrupting ratings shown with two or three poles connected in series (series connection is external to circuit breaker).

**NOTE:** Due to external series connection, I-Line™ circuit breakers are not available for this application.

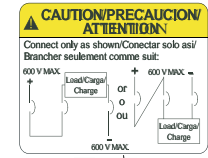

Connection Diagram

**Table 7.87: 500 Vdc Termination Options**

Termination Letter	Termination Option
F	No Lugs (bus bar connection)
L	Lugs Both Ends
S	Rear Connection
JGL37125D81—Place termination letter in third block of circuit breaker catalog number.	

**Table 7.88: 500 Vdc Molded Case Circuit Breakers**

Ampere Rating	Circuit Breaker Cat. No.	Fixed Magnetic Trip —DC Amperes	Adjustable Magnetic Trip Range—DC Amperes [1]		Interrupting Rating @ 500 Vdc	
			Low	High		
30 A	HGL37030D87	450	—	—	20 k AIR	
50 A	HGL37050D87	450	—	—		
70 A	HGL37070D87	450	—	—		
100 A	JGL37100D81	—	400	600	20 k AIR	
125 A	JGL37125D81	—	400	600		
150 A	JGL37150D81	—	400	600		
175 A	JGL37175D81	—	400	600		
200 A	JGL37200D82	—	500	850		
225 A	JGL37225D82	—	500	850	20 k AIR	
250 A	JGL37250D82	—	500	850		
300 A	LGL37030D27	—	750	1500		
350 A	LGL37035D29	—	875	1750	20 k AIR	
400 A	LGL37040D30	—	1000	2000		
450 A	LGL37045D31	—	1125	2250		
500 A	LGL37050D32	—	1250	2500		
600 A	LGL37060D33	—	1500	3000		
700 A	LGL47070D35	—	1750	3500		
800 A	LGL47080D36	—	2000	4000		
900 A	LGL47090D86	—	2250	4500		
1000 A	LGL47100D40	—	2500	5000		
1200 A	LGL47120D42	—	3000	6000		
30A	HLL37030D87	450	—	—		50 k AIR
50A	HLL37050D87	450	—	—		
70A	HLL37070D87	450	—	—		
100A	JLL37100D81	—	400	600	50 k AIR	
125A	JLL37125D81	—	400	600		
150A	JLL37150D81	—	400	600		
175A	JLL37175D81	—	400	600		
200A	JLL37200D82	—	500	850		
225A	JLL37225D82	—	500	850		
250A	JLL37250D82	—	500	850		
300A	LLL37030D27	—	750	1500		
350A	LLL37035D29	—	875	1750		
400A	LLL37040D30	—	1000	200		
450 A	LLL36045D31	—	1125	2250		
500 A	LLL37050D32	—	1250	2500		
600 A	LLL37060D33	—	1500	3000		
700 A	LLL47070D35	—	1750	3500		
800 A	LLL47080D36	—	2000	4000		
900 A	LLL47090D86	—	2250	4500		
1000 A	LLL47100D40	—	2500	5000		
1200 A	LLL47120D42	—	3000	6000		

**Table 7.89: Automatic Molded Case Switch**

Frame	Poles	Ampere Rating	Trip Point	Interrupting Rating	
				G	J
2P, 600 Vac 50/60 Hz					
M	2	800	10 kA	—	MJL26000S80
3P, 600 Vac 50/60 Hz					
M	3	800	10 kA	—	MJL36000S80

Accessories see page 7-51 and Supplemental Digest Section 3  
Optional Lugs see page 7-56 and Supplemental Digest Section 3  
Dimensions see page 7-87 and Supplemental Digest Section 3  
Enclosures see page 7-91

[1] Magnetic trip tolerances are -20%/+30% from the nominal values shown.



J-Frame Switch



L-Frame Switch

**PowerPact Automatic Switches**

Automatic molded case switches open instantaneously at a factory preset magnetic trip point. Calibrated to protect only the molded case switch itself, when it is subjected to high fault currents. The trip point is nonadjustable and provides no overload or low level fault protection.

- PowerPact™ H-, J-, and L-frame automatic switches are available in unit mount, I-Line™, plug-in and drawout versions.
- Accept the same lugs and accessories as equivalent thermal-magnetic circuit breakers<sup>[1]</sup>.
- May be interlocked with another switch or circuit breaker to form a source-changeover system
- UL Listed per UL 489 and CSA Certified.

**Table 7.90: PowerPact™ B-Frame Automatic Molded Case Switches, 600 Vac**

Circuit Breaker	Poles	Ampere Rating	D Withstand		G Withstand		J Withstand		Terminal	Wire Range
			Cat. No.	Trip Point	Cat. No.	Trip Point	Cat. No.	Trip Point		
B-Frame	2 [2]	125 A	BDL26000S12	1625 A	BGL26000S12	1625 A	BJL26000S12	1625 A	LV426973	14–2/0 AWG Cu
	3	125 A	BDL36000S12	1625 A	BGL36000S12	1625 A	BJL36000S12	1625 A	LV426974	14–2/0 AWG Cu

**Table 7.91: H-, J-, and L-Frame PowerPact™ Automatic Molded Case Switches, 600 Vac**

Circuit Breaker	Poles	Ampere Rating	G Withstand		L Withstand		R Withstand		Terminal	Wire Range
			Cat. No.	Trip Point	Cat. No.	Trip Point	Cat. No.	Trip Point		
H-Frame J-Frame	2	150 A	HGL26000S15 [2]	2250 A	HLL26000S15	2250 A	—	—	AL150HD	14 AWG–3/0 AWG Al/Cu
		175 A	JGL26000S17	3125 A	JLL26000S17	3125 A	—	—	AL175JD	4–4/0 AWG Al/Cu
		250 A	JGL26000S25	3125 A	JLL26000S25	3125 A	—	—	AL250JD	3/0 AWG–350 kcmil Al/Cu
	3	150 A	HGL36000S15	2250 A	HLL36000S15	2250 A	—	—	AL150HD	14 AWG–3/0 AWG Al/Cu
		175 A	JGL36000S17	3125 A	JLL36000S17	3125 A	JRL36000S17	3125 A	AL175JD	4–4/0 AWG Al/Cu
		250 A	JGL36000S25	3125 A	JLL36000S25	3125 A	JRL36000S25	3125 A	AL250JD	3/0 AWG–350 kcmil Al/Cu
L-Frame	3	400 A	LGL36000S40X	4800 A	LLL36000S40X	4800 A	LRL36000S40X	4800 A	AL150HD	AL600LS52K3
		600 A	LGL36000S60X	6600 A	LLL36000S60X	6600 A	LRL36000S60X	6600 A	AL250JD	(2) 2/0 AWG–500 kcmil Al/Cu
	4	400 A	LGL46000S40X	4800 A	LLL46000S40X	4800 A	LRL46000S40X	4800 A	AL150HD	AL600LS52K4
		600 A	LGL46000S60X	6600 A	LLL46000S60X	6600 A	LRL46000S60X	6600 A	AL250JD	(2) 2/0 AWG–500 kcmil Al/Cu

**Table 7.92: P-Frame and R-Frame PowerPact™ Automatic Molded Case Switches [3], 600 Vac**

Frame	Poles	Ampere Rating	J Withstand		K Withstand		L Withstand		Terminal	Wire Range
			Cat. No.	Trip Point	Cat. No.	Trip Point	Cat. No.	Trip Point		
M	2	800 A	MJL26000S80	10 kA	—	—	—	—	AL800M23K	(3) 3/0 AWG–500 kcmil Al or Cu
	3	800 A	MJL36000S80	10 kA	—	—	—	—	AL800M23K	(3) 3/0 AWG–500 kcmil Al or Cu
P	2	600 A	PJL26000S60	10 kA	PKL26000S60	24 kA	PLL24000S60 [4]	10 kA	AL800M23K	(3) 3/0 AWG–500 kcmil Al or Cu
		800 A	PJL26000S80	10 kA	PKL26000S80	24 kA	PLL24000S80 [4]	10 kA		
		1000 A	PJL26000S10	10 kA	PKL26000S10	24 kA	PLL24000S10 [4]	10 kA		
	3	1200 A	PJL26000S12	10 kA	PKL26000S12	24 kA	PLL24000S12 [4]	10 kA	AL1200P25K	(4) 3/0 AWG–500 kcmil Al or Cu
		600 A	PJL36000S60	10 kA	PKL36000S60	24 kA	PLL34000S60 [4]	10 kA		
		800 A	PJL36000S80	10 kA	PKL36000S80	24 kA	PLL34000S80 [4]	10 kA		
R	2	1200 A	—	—	RKF26000S12	57 kA	RLF26000S12	48 kA	R-frame circuit breakers can be bus-connected or cable-connected. For cable connections, RLTB kit or equivalent bus structure is required. Kit is included with 3000 A switches. For all others, see page 7-59.	
		1600 A	—	—	RKF26000S16	57 kA	RLF26000S16	48 kA		
		2000 A	—	—	RKF26000S20	57 kA	RLF26000S20	48 kA		
		2500 A	—	—	RKF26000S25	57 kA	RLF26000S25	48 kA		
		1200 A	—	—	RKF36000S12	57 kA	RLF36000S12	48 kA		
		1600 A	—	—	RKF36000S16	57 kA	RLF36000S16	48 kA		
	3	2000 A	—	—	RKF36000S20	57 kA	RLF36000S20	48 kA		
		2500 A	—	—	RKF36000S25	57 kA	RLF36000S25	48 kA		
		3000 A	—	—	RKF36000S30	57 kA	RLF36000S30	48 kA		

**Table 7.93: Q-Frame (240 Vac) PowerPact™ Automatic Molded Case Switches**

Circuit Breaker	Poles	Ampere Rating	J Withstand		Wire Range
			Cat. No.	Trip Point	
Q-Frame [5]	2	225 A	QBL22000S22	4500 A	4 AWG–300 kcmil
	3	225 A	QBL32000S22	4500 A	

**Table 7.94: B-, H-, J-, L- P-, and R-Frame Withstand Ratings [6]**

Voltage	Withstand					
	D	G	J	K	L	R
240 Vac	25 kA	65 kA	100 kA	65 kA	125 kA	200 kA
480 Vac	18 kA	35 kA	65 kA	50 kA [7]	100 kA	200 kA
600 Vac	14 kA	18 kA	25 kA	50 kA [7]	50 kA	100 kA

Accessories see page 7-51 and Supplemental Digest Section 3  
Optional Lugs see page 7-56 and Supplemental Digest Section 3  
Dimensions see page 7-86 and page 7-87  
Enclosures see page 7-88

7

MINIATURE AND MOLDED CASE  
CIRCUIT BREAKERS

[1] Q-frame switches do not have electrical accessories available.  
[2] True 2P device. Others are a 2P in a 3P module.  
[3] UL magnetic trip tolerances are -20% / +30% from the nominal values shown.  
[4] P-frame L-interrupting is available in 480 Vac only.  
[5] Withstand rating of 10 kA at 240 Vac.  
[6] The withstand rating is the fault current at rated voltage that the molded case switch will withstand without damage when protected by a circuit breaker with an equal continuous current rating.  
[7] B- and R-frame withstand is 65 kA.



**Instantaneous Trip Circuit Breakers for Motor Protection Applications**

Adjustable instantaneous-trip circuit breakers are intended for use in combination with motor starters with overload relays for the protection of motor circuits from short circuits.

Other specific applications include rectifiers and resistance welders. These circuit breakers contain a magnetic trip element in each pole with the trip point adjustable from the front. Interrupting ratings are determined by testing the instantaneous-trip circuit breakers in combination with a contactor and overload relay.

Select instantaneous-trip circuit breakers as follows:

This selection table is suitable for motors, other than NEMA Design E, with locked-rotor indicating code letters per NEC® Table 430.7 (b) as follows:

**Table 7.95: Locked-Rotor Indicating Codes**

Horsepower	Motor Code Letter
1/2 or less	A-L
3/4 to 1-1/2	A-K
2 to 3	A-J
5 to 25	A-H
30 to 125	A-G
150 or more	A-F

- For other motors order a special thermal-magnetic circuit breaker with magnetic trip settings for the specific motor— specify motor horsepower, voltage, frequency, full-load current and code letter or locked rotor current.
- Determine motor hp rating from the motor nameplate.
- Refer to the tables and select an instantaneous-trip circuit breaker with an ampere rating recommended for the hp and voltage involved.
- Select an adjustable trip setting of at least 800%, not to exceed 1300%, of the motor full-load amperes (FLA) for other than Design E motors. For Design E motors, select an adjustable trip setting of at least 1100% not to exceed 1700% of FLA.
- The NEC 1300% maximum setting may be inadequate for instantaneous-trip circuit breakers to withstand current surges typical of the magnetization current of autotransformer type reduced voltage starters, or open transition wye-delta starters during transfer from “start” to “run,” constant hp multi-speed motors, and motors labeled “high efficiency.” Select thermal-magnetic circuit breakers for those applications.
- Part-winding motors, per NEC 430.4, should have two circuit breakers selected from the above at not more than one half the allowable trip setting for the horsepower rating. The two circuit breakers should operate simultaneously as a disconnecting means per NEC 430.103.
- Based on NEC 430.52 and NEC Table 430.250.

**Table 7.96: Selection Tables for Conductors, Safety Switches and Thermal-Magnetic Circuit Breakers**  
Based on 2017 NEC® Tables 430.247, 430.248 & 430.250

Horsepower Ratings										Full Load Amperage [1]	Amperage of Thermal-Magnetic [2] Inverse Time Circuit Breaker			QMB and Heavy Duty Switch with Time Delay Fuses [3]	Minimum Size metallic Conduit 75° C, C Wire Field-Installed Sized for 125% FLA [4]		
Squirrel-Cage and Wound-Rotor Motors with Norm. Torque Characteristics Operating at Usual Speeds				1Ø 10 Hz ac			Average Direct Current Motors Operating at Base Speed		For Motor Code Letter B to E		For Motor Code Letter F to V [5]	AWG kcmil	Conduit 3 W				
3Ø 60 Hz				115 Vac	200 Vac [8]	230 Vac	120 Vdc	240 Vdc	Ordinary Service [6]				Heavy Service and Energy Efficient [7]		THHN THWN XHHW	THW	
200 Vac [8]	230 Vac	460 Vac	575 Vac														
						3/4			6.9 A								
				1/3					7.2 A								
		5					3.4		7.6 A		15 A						
2									7.8 A								
					3/4				7.9 A								
						1			8.0 A								
								2	8.5 A								
			7-1/2						9.0 A		20 A						
					1				9.2 A								
							1		9.5 A								
	3								9.6 A								
				1/2					9.8 A								
							1-1/2		10.0 A								
3		7-1/2	10						11.0 A								
					1-1/2				11.5 A								
						2			12.0 A								
								3	12.2 A								
							1-1/2		13.2 A								
				3/4	2				13.8 A								
		10							14.0 A								
	5								15.2 A								
				1					16.0 A								
			15			3	2		17.0 A								
5									17.5 A								
					3				19.6 A								
				1-1/2				5	20.0 A								
		15							21.0 A								
	7-1/2								22.0 A								
				2					24.0 A								
							3		25.0 A								
7-1/2									25.3 A								
		20	25						27.0 A								
	10					5			28.0 A								
								7-1/2	29.0 A								
			30						32.0 A								
10									32.2 A								
		25		3					34.0 A								
							7-1/2	5	38.0 A								
									40.0 A								
									41.0 A								
	15								42.0 A								
					7-1/2				46.0 A								
15									48.3 A								
						10			50.0 A								
		40	50						52.0 A								
									54.0 A								
	20							15	55.0 A								
					5				56.0 A								
						10			57.5 A								
							7-1/2		58.0 A								
			60						62.0 A								
20									62.1 A								
		50							65.0 A								
									68.0 A								
	25							20	72.0 A								
									76.0 A								
		60	75				10		77.0 A								
25									78.2 A								
				7-1/2					80.0 A								
								25	89.0 A								

[1] Motor full load currents thru 200 hp are taken from NEC Tables 430.247, 248 and 250. Above 200 hp from UL 98. Select wire size, circuit breakers, or fuses on basis of hp rather than nameplate full load current per NEC 430.6. Do not use these values to select overload relay thermal units. See Digest pages 16-129—16152 for selection of thermal units when actual full load current is not known. Voltages listed are rated motor voltages. Corresponding nominal system voltages are 110–120 V, 200–208 V, 220–240 V, 440–480 V and 550–600 V

[2] Thermal-magnetic circuit breaker ampere ratings recommended are approximate for average conditions, based on trip characteristics of Square D circuit breakers and NEC Table 430.52. Under some conditions, the next size larger switch or circuit breaker rating may be necessary to accommodate the motor starting current and is permitted by NEC 430.52(C)(1) Exception 2. High starting currents are anticipated with Design E and other energy efficient motors. For explanation of Code letter markings, see NEC 430.7(B). For Busway Plug-in units, see page 9-7.

[3] Switch size only is shown in table. Selected fuses should not exceed maximum percent of full-load current as given in NEC Table 430.52. Above 50 hp dc switches are not hp rated by UL as Motor Circuit Switches, but as General Use Switches only and are not necessarily capable of interrupting the max. operating overload current of a motor. See NEC 100 for definition of General Use Switch. When protecting a 3Ø, Design E energy efficient motor, the switch is required by NEC 430.109 to have a hp rating of not less than 1.4 times that of a motor rated 3–100 hp, or not less than 1.3 times that of a motor rated over 100 hp. Switches shown in this table do not necessarily comply with that requirement.

[4] NEC 430.22 for Single Motor. Smaller conductors may be permitted for light duty-cycle service per 430.22 (B) Exception No. 1. DC motors operating from rectified 1Ø power supply will require larger conductors per 430.22 (A) Exception No. 1. For motor-generator arc welders, see 630.11

[5] Thermal-magnetic breaker ampere ratings recommended are approximate for average conditions and based on trip characteristics of Square D circuit breakers and NEC Tables 430.7 (B) and 430.52.

[6] Ordinary service for normal starting duty only, acceleration time of 10 sec. or less.

[7] Heavy service is jogging or plugging duty or cycling load with over 25 starts per hour or over 5 starts per minute. Energy efficient motors are polyphase motors defined in NEMA Standard MG1 and exhibit high starting current.

[8] 200 V motors are commonly used on 208 V services.

[9] 8 XHHW requires 3/4 in. conduit for 3W.

**Table 7.96 Selection Tables for Conductors, Safety Switches and Thermal-Magnetic Circuit Breakers Based on 2017 NEC® Tables 430.247, 430.248 & 430.250 (cont'd.)**

Horsepower Ratings										Amperage of Thermal-Magnetic [11] Inverse Time Circuit Breaker			QMB and Heavy Duty Switch with Time Delay Fuses [12]	Minimum Size metallic Conduit 75° C, C Wire Field-Installed Sized for 125% FLA [13]			
Squirrel-Cage and Wound-Rotor Motors with Norm. Torque Characteristics Operating at Usual Speeds 3Ø 60 Hz				1Ø 10 Hz ac			Average Direct Current Motors Operating at Base Speed			Full Load Amperage [10]	For Motor Code Letter B to E			For Motor Code Letter F to V [14]	AWG kcmil	Conduit 3 W	
200 Vac [17]	230 Vac	460 Vac	575 Vac	115 Vac	200 Vac [17]	230 Vac	120 Vdc	240 Vdc	Ordinary Service [15]		Heavy Service and Energy Efficient [16]	For Motor Code Letter B to E				THHN THWN XHHW	THW
30									92.0 A								
		75							96.0 A								
			100						99.0 A								
				10					100.0 A	150 A	200 A	250 A	1	1-1/4 in.	1-1/2 in.		
		40							104.0 A		225 A	300 A					
								30	106.0 A	175 A			1/0	1-1/4 in.	1-1/2 in.		
40									120.0 A		250 A						
									124.0 A		250 A	350 A	2/0	1-1/2 in.	1-1/2 in.		
		100							125.0 A								
			125						130.0 A								
									140.0 A	200 A	300 A						
								40	144.0 A								
			150						150.0 A								
									154.0 A				3/0	1-1/2 in.	2 in.		
									156.0 A								
									173.0 A								
								50	177.0 A								
60									180.0 A								
									182.0 A								
			200						192.0 A								
									221.0 A	300 A	450 A	600 A	4/0	2 in.	2 in.		
									240.0 A				300	2 in.	2-1/2 in.		
									242.0 A								
									248.0 A	350 A	500 A	700 A	350	2-1/2 in.	2-1/2 in.		
									285.0 A								
									289.0 A	400 A	600 A		500	3 in.	3 in.		
			300						302.0 A								
									312.0 A								
									336.0 A	450 A	700 A	800 A	(2) 3/0	(2) 2-1/2 in.	(2) 2 in.		
									359.0 A	500 A							
125									360.0 A								
									361.0 A								
									382.0 A								
									414.0 A	600 A	800 A	1000 A	(2) 4/0	(2) 2 in.	(2) 2 in.		
									472.0 A								
									477.0 A								
									480.0 A								
									552.0 A	800 A	1000 A	1200 A	(2) 350	(2) 2-1/2 in.	(2) 2-1/2 in.		
									590.0 A								
									602.0 A	900 A	1200 A	1600 A	(3) 300	(3) 2 in.	(3) 2-1/2 in.		

Contact your local Field Office for circuit breaker selection on constant horsepower multi-speed motors.

[10] Motor full load currents thru 200 hp are taken from NEC Tables 430.247, 248 and 250. Above 200 hp from UL 98. Select wire size, circuit breakers, or fuses on basis of hp rather than nameplate full load current per NEC 430.6. Do not use these values to select overload relay thermal units. See Digest pages 16-129—16152 for selection of thermal units when actual full load current is not known. Voltages listed are rated motor voltages. Corresponding nominal system voltages are 110–120 V, 200–208 V, 220–240 V, 440–480 V and 550–600 V

[11] Thermal-magnetic circuit breaker ampere ratings recommended are approximate for average conditions, based on trip characteristics of Square D circuit breakers and NEC Table 430.52. Under some conditions, the next size larger switch or circuit breaker rating may be necessary to accommodate the motor starting current and is permitted by NEC 430.52(C)(1) Exception 2. High starting currents are anticipated with Design E and other energy efficient motors. For explanation of Code letter markings, see NEC 430.7(B). For Busway Plug-in units, see page 9-7.

[12] Switch size only is shown in table. Selected fuses should not exceed maximum percent of full-load current as given in NEC Table 430.52. Above 50 hp dc switches are not hp rated by UL as Motor Circuit Switches, but as General Use Switches only and are not necessarily capable of interrupting the max. operating overload current of a motor. See NEC 100 for definition of General Use Switch. When protecting a 3Ø, Design E energy efficient motor, the switch is required by NEC 430.109 to have a hp rating of not less than 1.4 times that of a motor rated 3–100 hp, or not less than 1.3 times that of a motor rated over 100 hp. Switches shown in this table do not necessarily comply with that requirement.

[13] NEC 430.22 for Single Motor. Smaller conductors may be permitted for light duty-cycle service per 430.22 (B) Exception No. 1. DC motors operating from rectified 1Ø power supply will require larger conductors per 430.22 (A) Exception No. 1. For motor-generator arc welders, see 630.11

[14] Thermal-magnetic breaker ampere ratings recommended are approximate for average conditions and based on trip characteristics of Square D circuit breakers and NEC Tables 430.7(B) and 430.52.

[15] Ordinary service for normal starting duty only, acceleration time of 10 sec. or less.

[16] Heavy service is jogging or plugging duty or cycling load with over 25 starts per hour or over 5 starts per minute. Energy efficient motors are polyphase motors defined in NEMA Standard MG1 and exhibit high starting current.

[17] 200 V motors are commonly used on 208 V services.

**PowerPact Motor Protector Circuit Breakers—Two Device Solutions**

Accessories see page 7-51 and Supplemental Digest Section 3  
Optional Lugs see page 7-56 and Supplemental Digest Section 3  
Dimensions see page 7-87  
Enclosures see page 7-88

MicroLogic 2.2M and 2.3M trip units provide built-in thermal and magnetic protections. Use PowerPact Motor Protect Circuit Breakers in two-device motor feeder solutions to provide protection against short-circuits, overloads, and phase unbalance.

- Protection settings are made using a rotary switch.
- Accept the same accessories and terminals as equivalent PowerPact circuit breakers.
- UL, CSA, IEC certified and CE marked for global acceptance.

**Table 7.97: H-Frame (150 A), J-Frame (250 A) and L-Frame (600 A) Electronic Motor Protector Circuit Breakers (UL Ratings)—Two Device Solutions [10]**

Electronic Trip Unit Type	Frame	Sensor Rating	Trip Unit	Full Load Amperes Range (FLA)	Isd (x FLA)	Interrupting Rating			
						G	J	L	R
Standard [11]	H-Frame	30	2.2 M	14–25	5-13 x FLA	HGL36030M38X	HJL36030M38X	HLL36030M38X	HRL36030M38X
		50		14–42	5-13 x FLA	HGL36050M38X	HJL36050M38X	HLL36050M38X	HRL36050M38X
		100		30–80	5-13 x FLA	HGL36100M38X	HJL36100M38X	HLL36100M38X	HRL36100M38X
		150		58–130	5-13 x FLA	HGL36150M38X	HJL36150M38X	HLL36150M38X	HRL36150M38X
		250		114–217	5-13 x FLA	JGL36250M38X	JJL36250M38X	JLL36250M38X	JRL36250M38X
	L-Frame	400	2.3 M	190–348	5-13 x FLA	LGL36400M38X	LJL36400M38X	LLL36400M38X	LRL36400M38X
		600		312–520	5-13 x FLA	LGL36600M38X	LJL36600M38X	LLL36600M38X	LRL36600M38X

To select combination starters and motor controllers using MCP's meeting NEC Article 430, refer to Section 16.

**PowerPact H, J, and L-Frame Motor Protectors**

**Table 7.98: Application of PowerPact H- and L-Frame Motor Protector Circuit Breaker**



HJL36100M38X  
Motor Circuit Protector

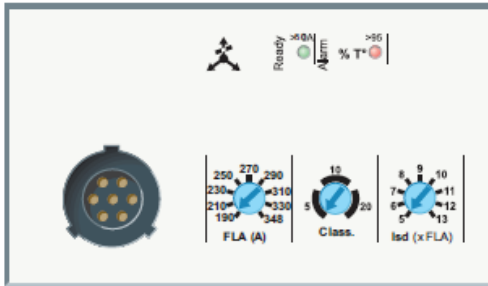

MicroLogic 2.2M and 2.3M Trip Units

**Ii=4800A**

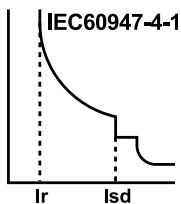

Hp Ratings of Induction Type Squirrel-Cage and Wound Rotor Motors 3Ø 60 Hz	Full Load Amperes [12]	PowerPact Family Motor Protector Circuit Breaker Cat. No. [13]	Magnetic Trip Settings [14]	
			MIN	MAX
200 Vac	230 Vac	460 Vac	575 Vac	
5	5	10	15	14 15.2 17 17.5
7-1/2	7-1/2	15	20	21 22 25.3
		20	25	27
10	10	25	30	28 32 32.2 34
		30	40	40 41 42 48.3
15	15	40	50	52 54 62 65
		50	60	62 65
75	100	200	250	221 240 242 248
		300	300	285 289 302 312
125	150	350	400	336 359 360 361
		400	500	382 414 472 477 480

[10] Two-device solutions (these electronic motor protector circuit breakers include short circuit and overload protection)

- 1 electronic motor circuit protector with a MicroLogic 2.2 M plus
- 1 contactor

[11] The standard trip unit offers Class 5, 10 and 20 and phase unbalance or phase loss protection.







[12] Motor full-load currents are taken from NEC Table 430.250. Select wire and circuit breakers on basis of horsepower rather than nameplate full-load current per NEC 430.6 (A) for general motor applications. Do not use these values to select overload relay thermal units. See Digest Section 14 for selection of thermal units when actual full load current is not known. The voltages listed are rated motor voltages. Corresponding nominal system voltages are 200–208, 220–240, 440–480 and 550–600 V.

[13] To complete catalog number, replace the blank with the appropriate rating (G, J, L or R).

[14] Only MIN and MAX settings are shown, intermediate settings are available on all circuit breakers.

**PowerPact Accessories**

**Table 7.99: Electrical Accessories**

Accessory	Description	Rated Voltage	B-, H-, J-, and L-Frame					M-, P-, and R-Frame					
			Factory Installed Cat. Suffix	B-Frame		H- and J-Frame	L-Frame	Factory Installed Cat. Suffix	Field-Installable Cat. No.				
				Field-Installable Cat. No.	Field-Installable Pre-Wired Cat. No.	Field-Installable Cat. No.	Field-Installable Cat. No.						
 Auxiliary and Alarm Switches (OF, SD, SDE)  B-Frame   H-, J-, L-, M-, P, and R-Frame	Provides circuit breaker contact status. Note: The location of the accessory in the circuit breaker determines its function.	Standard Min Load = 10mA with 24V           Low Level Min Load = 1mA with 24V	1 auxiliary switch (OF) 1a1b	AA	LV426950	LV426951	S29450	S29450	AA	S29450			
			2 auxiliary switch (OF) 2a2b	AB	—	—	2x S29450	2x S29450	AB	2x S29450			
			3 auxiliary switch (OF) 3a3b	AC	—	—	—	3x S29450	3x S29450	AC	3x S29450		
			Alarm Switch (SD) 1a1b	BC	LV426950	LV426952	S29450	S29450	BC	S29450			
			Overcurrent trip switch (SDE) 1a1b	BD	—	—	—	S29450	BD	S29450			
				Consisting of:	OF Switch	—	—	S29450	—	—	—		
			SDE Adapter	—	—	—	S29451	—	—	—			
			Alarm switch and Overcurrent trip switch	BE	—	—	—	2x S29450	BE	2x S29450			
			Consisting of:	OF Switch	—	—	2x S29450	—	—	—			
			SDE Adapter	—	—	—	S29451	—	—	—			
			Auxiliary Switch/Alarm Switch/Adapter (OF/SD/SDE) Kit	—	—	—	—	—	—	S33801 [1]			
			One auxiliary switch (OF) 1a1b	AE	—	—	S29452	S29452	AE	S29452			
			Two auxiliary switches (OF) 2a2b	AF	—	—	2x S29452	2x S29452	AF	2x S29452			
			3 auxiliary switches (OF) 3a3b	AG	—	—	—	3x S29452	AG	3x S29452			
Alarm Switch (SD) 1a1b	BH	—	—	S29452	S29452	BH	S29452						
Overcurrent trip switch (SDE) 1a1b	BJ	—	—	—	S29452	BJ [2]	S29452						
	Consisting of:	OF Switch	—	—	S29452	—	—						
SDE Adapter	—	—	—	S29451	—	—	—						
Alarm switch and Overcurrent trip switch	BK	—	—	—	2x S29452	BK [2]	2x S29452						
Consisting of:	OF Switch	—	—	2x S29452	—	—	—						
SDE Adapter [3]	—	—	—	S29451	—	—	—						
 Shunt Trip (MX)  B-Frame   H-, J-, and L-Frame	Trips the circuit breaker from a remote location by means of a trip coil energized from a separate supply voltage circuit.	AC           DC	24	SK	LV426841	LV426861	S29384	S29384	SK	S33659			
			48	SL	LV426842	LV426862	S29385	S29385	SL	S33660			
			110–130	SA	LV426843	LV426863	S29386	S29386	SA	S33661			
			220–240	SD, SF	—	—	—	—	SC	S33662			
			208–277	SD	LV426844	LV426864	S29387	S29387	SD	S33663			
			380–480	SH	LV426846	LV426866	S29388	S29388	SH	S33664			
			525–600	SJ	—	—	S29389	S29389	—	—			
			12	SN	LV426850	—	S29382	S29382	SN	S33658			
			24	SO	LV426841	LV426861	S29390	S29390	SO	S33659			
			30	SU	—	—	S29391	S29391	—	—			
			48	SP	LV426842	LV426862	S29392	S29392	SP	S33660			
			60	SV	—	—	S29383	S29383	—	—			
			125	SR	LV426843	LV426863	S29393	S29393	SR	S33661			
			250	SS	LV426844	LV426864	S29394	S29394	SS	S33662			
			 Undervoltage Trip (MN) H-, J-, and L-Frame	Instantaneously opens the circuit breaker when the under-voltage trip supply voltage drops to a value between 35% and 70% of its rated voltage. Closing is allowed when the supply voltage of the undervoltage trip reaches 85% of rated voltage.	AC           DC	24	UK	LV426801	LV426821	S29404	S29404	UK	S33668
						48	UL	LV426802	LV426822	S29405	S29405	UL	S33669
						110–130	UA	LV426803	LV426823	S29406	S29406	UA	S33670
						220–240	UC	LV426804	LV426824	—	—	UC	S33671
						208–277	UD	LV426805	LV426825	S29407	S29407	—	—
380–415	UF	LV426806				LV426826	—	—	—	—			
380–480	UH	LV426807				LV426827	S29408	S29408	UH	S33673			
525–600	UJ	—				—	S29409	S29409	—	—			
12	UN	—				—	S29402	S29402	—	—			
24	UO	LV426801				LV426821	S29410	S29410	UO	S33668			
30	UQ	—				—	S29411	S29411	—	—			
48	UP	LV426802				LV426822	S29412	S29412	UP	S33669			
60	UV	—				—	S29403	S29403	—	—			
125	UR	LV426803	LV426823	S29413	S29413	UR	S33670						
250	US	LV426815	LV426835	S29414	S29414	US	S33671						
 Time Delay Unit	Undervoltage trip with externally mounted adjustable time delay unit for UVVR of 0.5, 0.9, 1.5, 3.0 seconds before circuit breaker trips	AC/DC	48	—	S33680 [4]	—	S33680 [4]	S33680 [4]	—	S33680 [4]			
			100–130	—	S33681 [4]	—	S33681 [4]	S33681 [4]	—	S33681 [4]			
			220–250	—	S33682 [4]	—	S33682 [4]	S33682 [4]	—	S33682 [4]			
			380–480	—	—	—	—	—	—	S33683 [4]			
	Undervoltage trip with externally mounted non-adjustable time delay unit of 0.25 sec before circuit breaker trips.	AC/DC	48	—	S29426 [4]	—	S29426 [4]	S29426 [4]	—	—			
			100–130	—	—	—	—	—	—	S33684 [4]			
			200–250	—	—	—	—	—	—	S33685 [4]			
			220–240	—	S29427 [4]	—	S29427 [4]	S29427 [4]	—	—			

[1] P-frame drawout circuit breaker only.  
 [2] Not available on electrically operated P-frame.  
 [3] SDE Adapter used for H- and J-frame only.  
 [4] Field-installable kit includes time delay module only. Order undervoltage trip separately.



**Motor Operators**

**Motor Operators for H-, J-, and L-Frame Circuit Breakers**

- Circuit-breaker indications and information remain visible and accessible, including trip-unit settings and indications
- Suitability for isolation is maintained and padlocking remains possible
- All termination connection (fixed, plug-in/withdrawable) possibilities are maintained
- Double insulation of the front face

Description	Rated Voltage	Factory Installed Cat. No. Suffix	Field-Installable Kit			
			H-Frame [5] Cat. No.	J-Frame Cat. No.	L-Frame 600 A Cat. No.	
 <p>Standard motor for electrically-operated circuit breakers [6]</p> <p>Communicating motor for electrically-operated circuit breakers [7]</p> <p>Locking device</p> <p>Mounting hardware</p> <p>Ronis lock</p> <p>Profalux lock</p> <p>Mounting hardware plus Ronis lock</p> <p>Operations counter</p> <p>Adapter for I-Line circuit breaker</p>	AC	48-60	ML	S29440	S31548	S432639
		110-130	MA	S29433	S31540	S432640
		208-277 220-240	MD	S29434	S31541	S432641
		380-415	MF	—	—	S432642
		440-480	MH	S29435	S31542	S432647
		24-30	MO	S29436	S31543	S432643
		48-60	MV	S29437	S31544	S432644
		110-130	MR	S29438	S31545	S432645
		250	MS	S29439	S31546	S432646
	220-240	NC	S429441	S431549	S432652	
	—	—	—	—	S32649	
	—	—	—	S41940	S41940	S41940
	—	—	—	S42888	S42888	S42888
—	—	—	S429449	S429449	—	
—	—	—	—	—	S32648	
—	—	—	S37420	S37420	—	

**Spring-Charging Motors for Electrically-Operated P-Frame Circuit Breakers**

Automatically charges the spring mechanism for closing the P-frame circuit breaker and also recharges the spring mechanism when the circuit breaker is in the ON position. Instantaneous reclosing of the circuit breaker is thus possible following circuit breaker opening.

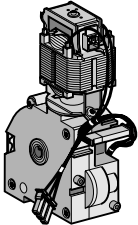
Description	Rated Voltage	Factory Installed Cat. No. Suffix	P-Frame (For Field Replacement Only)	Replacement Coils	
			Spring Charging Motor Cat. No.	Opening/Closing Coil Cat. No.	
 <p>Standard motor for electrically-operated circuit breakers. Factory-installed includes motor and opening/closing coils.</p> <p>Communicating motor mechanism for electrically operated circuit breakers. Factory-installed includes motor and opening/closing coils.</p>	AC	48	ML	S47391	S33660
		100-130	MA	S47395	S33661
		220-240	MC	S47396	S33662
		380-415	MF	S47398	S33664
		24-30	MO	S47390	S33659
		48-60	MV	S47391	S33660
		110-130	MR	S47392	S33661
		200-250	MS	S47393	S33662
		48	NL	S47391	S33034
	100-130	NA	S47395	S33035	
	220-240	NC	S47396	S33036	
	380-415	NF	S47398	S33038	
	24-30	NO	S47390	S33033	
	48-60	NV	S47391	S33034	
	110-130	NR	S47392	S33035	
	200-250	NS	S47393	S33036	

[5] Not available in H-frame 2P modules.

[6] Factory and field-installed standard motor operators for H- and J-frame circuit breakers require the SDE switch and SDE adapter (both included).

[7] Factory and field-installed standard motor operators for L-frame circuit breakers require the SDE switch (included).

[7] Installation requires BSCM with NSX Cord. For ordering information see page 7-64 .

**Rotary Handles**

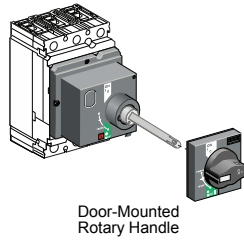
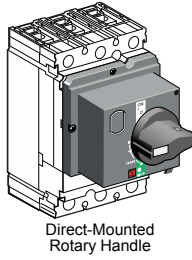

Device	Description	B-Frame		H- and J-Frame [8]		L-Frame		P-Frame	
		Factory Installed Cat. No. Suffix	Field-Installable Cat. No.	Factory Installed Cat. No. Suffix	Field-Installable Cat. No.	Factory Installed Cat. No. Suffix	Field-Installable Cat. No.	Factory Installed Cat. No. Suffix	
Direct Mounted	Standard black handle	Operating mechanism kit	RD10	LV426930	RD10	S29337	RD10	S32597	RD10
	Standard black handle with	Two early-break and two early make switches	—	—	—	—	—	—	RD16
		One early-break switch	—	—	RD12	S29337 + S29345	RD12	S32597 + S32605	—
		Two early-make switches	—	—	RD13	S29337 + S29346	RD13	S32597 + S29346	—
	Red handle on yellow bezel	Operating mechanism kit	RD20	LV426931	RD20	S29339	RD20	S32599	—
		One early-break switch	—	—	RD22	S29339 + S29345	RD22	S32599 + S32605	—
		Two early-make switches	—	—	RD23	S29339 + S29346	RD23	S32599 + S29346	—
	MCC conversion accessory		—	—	—	S429341	—	S32606	—
	CNOMO conversion accessory		—	—	—	29342	—	S32602	—
	Door Mounted	Standard black handle	Operating mechanism kit	—	LV426932	RE10	S29338	RE10	S32598
Standard black handle with:		Two early-break and two early make switches	—	—	—	—	—	—	RE16
		Two early make switches	—	—	RE13	S29338 + S29346	RE13	S32598 + S29346	—
Red handle on yellow bezel		Operating mechanism kit	—	LV426933	RE20	S29340	RE20	S32600	—
Rotary Handle Replacement Kit		—	—	—	—	—	—	S33875	
Telescoping		—	—	RT10	S29343	RT10	S32603	—	
Accessories	Key lock adapter	—	—	—	S429344	—	S32604	—	
	Key locks	Ronis 1351.500	—	—	—	S41940	—	S41940	—
		Profalux KS5 B24 D4Z	—	—	—	S42888	—	S42888	—
		2 Ronis keylocks with 1 key	—	—	—	S41950	—	S41950	—
		2 Profalux keylocks with 1 key	—	—	—	S42878	—	S42878	—
	Indication Auxiliary Switch	One early-break switch	—	—	—	S29445	—	S32605	—
Two early-make switches		—	—	—	S29346	—	S29346	—	

Refer to Digest Section 8—Operating Mechanisms for additional operating mechanism options.

[8] Not available in H-frame 2P modules.

Locks, Installation Accessories, and Rear Connectors

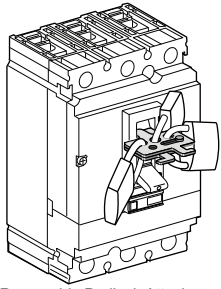

Removable Padlock Attachment

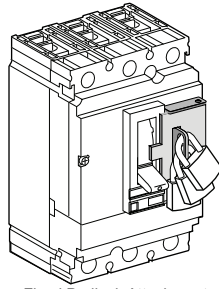

Fixed Padlock Attachment

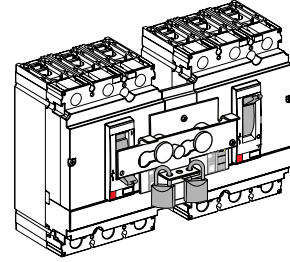

Interlocking with Toggle Control

Table 7.100: Locks, Interlocking

Device	Description	B-Frame		H- and J-Frame		Q-Frame		L-Frame	M- and P-Frame		R-Frame		
		Factory-Installed Cat. No. Suffix	Field-Installable Cat. No.	Factory-Installed Cat. No. Suffix	Field-Installable Cat. No.	Factory-Installed Cat. No. Suffix	Field-Installed Cat. No.	Field-Installable Cat. No.	Factory-Installed Cat. No. Suffix	Field-Installable Cat. No.	Factory-Installed Cat. No. Suffix	Field-Installable Cat. No.	
Handle Padlocking Device	Removable (lock OFF only)	—	S29370	—	S29370	—	—	S29370	—	S44936	—	S33996	
	Fixed (lock OFF or ON)	YP	LV426905 LV426907 (I-Line)	YP	S29371	YP	QBPA	S32631	YP	S32631	YP	S32631	
	Fixed (lock OFF only) <sup>[9]</sup>	YQ	LV426906 LV426908 (I-Line)	YQ	S37422	YQ	QBPAF	NJPAF	YQ	MPRPAF	YQ	MPRPAF	
	Fixed (lock OFF only)—2P	—	—	YQ	H2PHLA	YQ	—	—	—	—	—	—	
Interlocking (Not UL listed)	Mechanical for circuit breakers with rotary handles <sup>[10]</sup>	—	—	—	S29369	—	—	S32621	—	S33890	—	—	
	Mechanical for circuit breakers with toggles <sup>[10]</sup>	—	LV426909	—	S29354	—	QBMK	S32614	—	—	—	—	
Key Locking	Provision only, vertical mount, 1 or 2 locks	Kirk	—	—	—	—	—	—	JA	—	—	—	
	Provisions only, vertical mounting one key interlock including padlock provision, open position only.	Kirk	—	—	—	—	—	—	JE <sup>[11][12]</sup>	—	JE <sup>[12]</sup>	—	
	Provision only, horizontal mount 1 lock, M- and P-frame 1 or 2 locks, R-frame	Kirk	—	—	—	—	—	—	—	JK	—	JK	—
		Ronis	—	—	—	—	—	—	—	JB <sup>[13]</sup>	—	JB	—
	Provision and 1 lock, vertical mount	Profalux	—	—	—	—	—	—	—	JD <sup>[13]</sup>	—	JD	—
		Kirk	—	—	—	—	—	—	—	JG	—	—	—
	Provision and 1 lock, horizontal mount	Kirk	—	—	—	—	—	—	—	JL	—	JL	—
		Ronis	—	—	—	—	—	—	—	JC <sup>[13]</sup>	—	JC	—
	Provision and 2 locks keyed alike	Profalux	—	—	—	—	—	—	—	JF <sup>[13]</sup>	—	JF	—
		Kirk	—	—	—	—	—	—	—	JN	—	JN	—
Provision and 2 locks keyed differently	Kirk	—	—	—	—	—	—	—	JP	—	JP	—	

Table 7.101: Installation Accessories for B-, H-, J-, and L-Frame Circuit Breakers

Description	Field-Installable Cat. No.		
	B-Frame	H- and J-Frame	L-Frame
Front Panel Escutcheon for Toggle Breakers	—	S29315	32556
Front Panel Escutcheon for Rotary Handle, Motor Operator, or extended escutcheon	—	S29317	S32558
Phase Barriers (set of 6)	LV426920	S29329	32570
Handle Rubber Boot <sup>[14]</sup>	—	S29319	S32560
Sealing Accessories (for front cover screws)	S29375	S29375	S29375
DIN rail mounting kit (requires 15 mm depth on a 35 mm DIN rail) <sup>[14]</sup>	Standard	S29305	—
DIN rail adapter	Standard	—	—
Handle Extensions (set of 5)	—	S29313	S432553
Rear Insulation Kit (2P)	LV426921	—	—
Rear Insulation Kit (3P)	LV426922	—	—
Rear Insulation Kit (4P)	LV426923	—	—
Terminal Extensions-Spreaders (3P)	LV426940	—	—
Terminal Extensions-Spreaders (4P)	LV426941	—	—
5 N-m Torque Limiting Bit, Set of 6	LV426992	—	—
5 N-m Torque Limiting Bit, Set of 8	LV426993	—	—
9 N-m Torque Limiting Bit, Set of 6	LV426990	—	—
9 N-m Torque Limiting Bit, Set of 8	LV426991	—	—

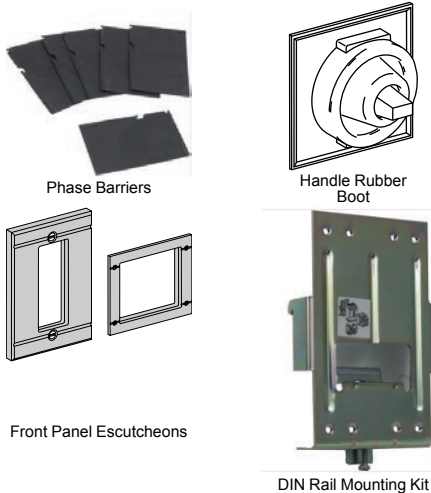

[9] Not available on HD and HG 2P modules.  
 [10] Not available in M frame or HD and HG 2P modules.  
 [11] Not available on M-frame.  
 [12] Not available on I-Line.  
 [13] Not available on M-frame or P-frame.  
 [14] Not available in HD and HG 2P modules.

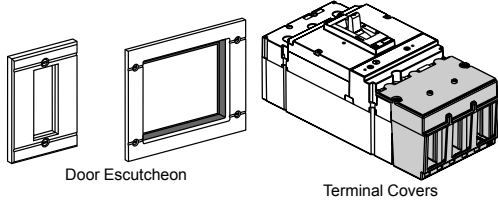

**Table 7.102: Installation Accessories for M-, P-, and R-Frame Circuit Breakers**

Description		Frame	Field-Installable Cat. No.
Door Escutcheon	Accessory Cover	M-, P-Frame	S33718
		R-Frame	S33929
	Toggle Handle	M-, P-Frame	S33717
	Drawout	P-Frame	S33857
Terminal Covers	Short lug cover 3P	P-Frame	S33932
	Short lug cover 4P		S33933
	Long lug cover 3P		S33934
	Long lug cover 4P		S33935
Replacement Handle	Standard	R-Frame	S33997
	Standard Short	M-, P-Frame	S46998
	Long	M-, P-Frame	S46996

**Table 7.103: H-, J-, and L-Frame Rear Connections**

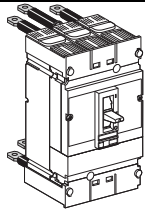
Device	Description	H-Frame			J-Frame			L-Frame			
		Poles	Factory-Installed Termination No.	Field-Installable Cat. No.	Poles	Factory-Installed Termination No.	Field-Installable Cat. No.	Poles	Factory-Installed Termination No.	Field-Installable Cat. No.	
 <p>Rear Connection</p>	Mixed Rear Connection Kit [15]	2	S	—	2	S	—	3	S	S32477	
		3	S	S37432	3	S	S37437	4	S	S32478	
	Consisting of:	Short rear connections (set of 2)	2 or 3	—	2x S37433	2 or 3	—	2x S37438	3	—	2x S432475
		Long rear connections (set of 2)		—	S37434		—	S37439 [16]		—	2x S432476
		Short terminal cover (3P)	3	—	S37436	3	—	S37440	3	—	2x S32562
Short terminal cover (4P)	4	—	—	—	—	—	4	—	2x S32563		

[15] Kit contains 4 short rear connections, 2 long rear connections (4 long rear connections for 4P), hardware, and 2 terminal covers.

[16] For use with 3P circuit breakers only.

Mechanical Lugs

Table 7.104: Mechanical Lug Kits for B-Frame Circuit Breakers [17]

Description	Circuit Breaker Application			Ampere Rating	Number of Wires Per Lug and Wire Range	Factory-Installed Cat. Suffix	Field-Installable Cat. No.	Qty Per Kit
	Standard	Ampere Rating	Optional					
Al Lugs for Use with Al or Cu Wire			BD BG BJ	15-125 A	(1) 14-2/0 AWG Al or Cu	LH	LV426966	2
			BD BG BJ	15-125 A	(1) 14-2/0 AWG Al or Cu	LH	LV426967	3
Cu Lugs for Use with Cu Wire Only			BD BG BJ	15-125 A	(1) 14-1/0 AWG Cu	LC	LV426964	2
			BD BG BJ	15-125 A	(1) 14-1/0 AWG Cu	LC	LV426965	3
EverLink Lug	BD BG BJ (1P)	15 - 125 A			(1) 14-3/0 AWG Cu	—	—	—
	BD BG BJ (2P)	15 - 125 A			(1) 14-3/0 AWG Cu	—	—	—
	BD BG BJ (3P)	15 - 125 A			(1) 14-3/0 AWG Cu	—	—	—
	BD BG BJ (4P)	15 - 125 A			(1) 14-3/0 AWG Cu	—	—	—
EverLink Lug with Control Wire Terminal		15 - 125 A	BD BG BJ (2P)		(1) 14-3/0 AWG Cu	LU, LV, or LW [18]	LV426973	1
		15 - 125 A	BD BG BJ (3P)		(1) 14-3/0 AWG Cu	LU, LV, or LW [18]	LV426974	1
		15 - 125 A	BD BG BJ (4P)		(1) 14-3/0 AWG Cu	LU, LV, or LW [18]	LV426975	1

Table 7.105: Mechanical Lug Kits for H- and J-Frame Circuit Breakers [17]

Description	Circuit Breaker Application			Ampere Rating	Number of Wires Per Lug and Wire Range	Kit Cat. No.	Qty Per Kit
	Standard	Ampere Rating	Optional				
Al Lugs for Use with Al or Cu Wire	HD, HG, HJ, HL	15-150 A			(1) 14-3/0 AWG Al or Cu	AL150HD	3
	JD, JG, JJ, JL	150-175 A			(1) 4-4/0 AWG Al or Cu	AL175JD	3
	JD, JG, JJ, JL	200-250 A	JD, JG, JJ, JL	150-175 A	(1) 3/0-350 kcmil Al or Cu	AL250JD	3
Cu Lugs for Use with Cu Wire Only			HD, HG, HJ, HL	15-150 A	(1) 14-2/0 AWG Cu	CU150HD	3
			JD, JG, JJ, JL	150-250 A	(1) 1/0-300 kcmil Cu	CU250JD	3
Control Wire Terminal for H-frame lug kit						S37423	2
Control Wire Terminal for J-frame lug kit						S37424	2

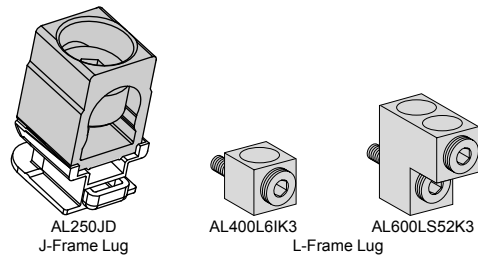
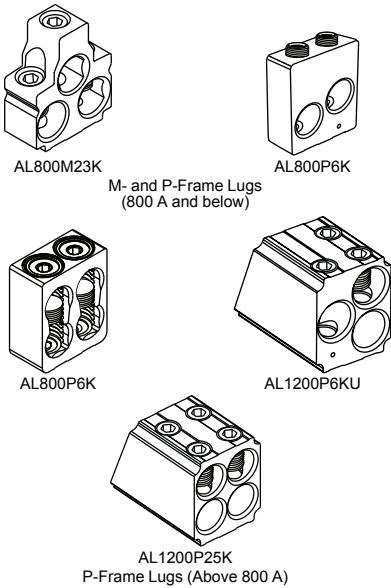

Table 7.106: Mechanical Lug Kits for L-Frame Circuit Breakers [19]

Description	Circuit Breaker Application				Number of Wires Per Lug and Wire Range	Kit Cat. No.	Qty Per Kit
	Ampere Rating	Poles	Unit Mount	I-Line			
Al Lugs for Use with Al or Cu Wire	250	3	X	X	(1) 2 AWG-500 kcmil Al	AL400L61K3	3
		4	X	—	(1) 2 AWG-600 kcmil Cu	AL400L61K4	4
	400/600	3	X	—	(2) 2/0 AWG-500 kcmil Al or Cu	AL600LS52K3	3
		4	X	—		AL600LS52K4	4
	400/600	3	X	X	(2) 3/0 AWG-500 kcmil Al or Cu	AL600LF52K3	3
Cu Lugs for Use with Cu Wire Only	250	3	X	X	(1) 2 AWG-600 kcmil Cu	CU400L61K3	3
		4	X	—		CU400L61K4	4
	400/600	3	X	—	(2) 2/0 AWG-500 kcmil Cu	CU600LS52K3	3
		4	X	—		CU600LS52K4	4
	400/600	3	X	X	(2) 3/0 AWG-500 kcmil Cu	CU600LF52K3	3

Table 7.107: Mechanical Lug Kits for M-, P- and R-Frame Circuit Breakers [20]

Description	Circuit Breaker Application				Wires per Lug and Wire Range	Cat. No.	Lugs Per Kit
	Standard	Rating	Optional	Rating			
Al Lugs for AL or Cu Wire	M-Frame, P-Frame	800 A	—	800 A	(3) 3/0 AWG-500 kcmil	AL800M23K	3
						AL800M23K4	4
		1200 A	MG, MJ, PG, PJ, PK, PL	800 A	(4) 3/0 AWG-500 kcmil	AL1200P24K [21]	1
		—	MG, MJ, PG, PJ, PK, PL	800 A	(2) 3/0 AWG-600 kcmil	AL800P6K [21]	3
						AL800P6K4 [21]	4
						AL800P7K [21]	3
					AL800P7K4 [21]	4	
	P-Frame	1200 A	PG, PJ, PK, PL	800 A	(4) 3/0 AWG-500 kcmil	AL1200P25K [22]	3
						AL1200P25K4 [22]	4
		—	PG, PJ, PK, PL	800-1200 A	(3) 350-600 kcmil	AL1200P6KU [22]	3
					AL1200P6KU4 [22]	4	
PG, PJ, PL	—	PG, PJ, PK, PL	1200 A	(3) 3/0 AWG-750 kcmil 750 kcmil: compact AL only	AL1200P7KU [22]	3	
					AL1200P7KU4 [22]	4	
R-Frame	1200 A	I-Line	—	(4) 3/0 AWG-600 kcmil	AL1200R53K	1	
	2500 A	Unit Mount	—	(1) 3/0 AWG-750 kcmil	AL2500RK [23]	2	
Cu Lugs for Cu Wire Only[24]	M-Frame, P-Frame	—	PJ	100-150 A	(1) 1-1/0 AWG	CU250P1K [25]	3
		800 A	MG, MJ, PG, PJ, PK, PL	—	(3) 3/0 AWG-500 kcmil	CU800M23K	3
					CU800M23K4	4	
	1200 A	MG, MJ, PG, PJ, PK, PL	800-1200 A	(4) 3/0 AWG-500 kcmil	CU1200P24K [21]	1	
	P-Frame	1200 A	PG, PJ, PK, PL	800-1200 A	(4) 3/0 AWG-500 kcmil	CU1200P25K [22]	3
				CU1200P25K4	4		
R-Frame	1200 A	I-Line	—	(4) 3/0 AWG-500 kcmil	CU1200R53K	1	



[17] For terminal nuts/bus bar connections see page 7-59.

[18] LU = ON end only, LV = OFF end only, LW = BOTH ends

[19] Lug kits for Legacy L-frame circuit breakers can be found in Supplemental Digest Section 11 (i.e. LA, LH circuit breakers).

[20] For lug with a tapped hole for control wire, add a "T" before the "K" in the catalog number (for example, AL800P6TK).

[21] Does not fit onto ON end of unit-mount P-frame circuit breakers.

[22] For unit-mount circuit breaker only.

[23] All unit-mount R-frame circuit breakers require terminal pads for mounting lugs of any type. See page 7-59.

[24] Not available with tapped hole for control wire.

[25] This lug can only be used on low amp PJ frame breakers where the Instantaneous setting must not be turned OFF. The cables must be laced with rope per lug instructions.

**Compression Lugs**

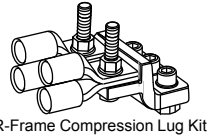
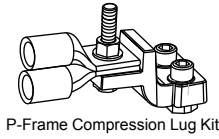
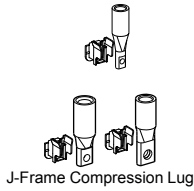

A = Crimp lugs or PDC connectors extension past end of circuit breaker

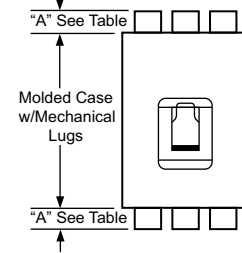

**Table 7.108: Compression Lug Kits for PowerPact™ Circuit Breakers**

Description	Circuit Breaker Type	Ampere Rating	System Range	Mounting Type	Dimension A (in)	Max. Lugs per Terminal	Cat. No.	Qty. Per Kit			
<b>Compression Lug Kits for B-Frame Circuit Breakers</b>											
Aluminum Compression Lug Kits	B-frame	125 A	8-1/0 AWG Al or Cu	Unit/I-line [26]	1.3	1	LV426988	2			
		125 A	8-1/0 AWG Al or Cu		1.3	1	LV426989	3			
Copper Compression Lug Kits	B-frame	125 A	6-1/0 AWG Cu		1.4	1	LV426986	2			
		125 A	6-1/0 AWG Cu		1.4	1	LV426987	3			
<b>Compression Lug Kits for H-Frame and J-Frame Circuit Breakers</b>											
Aluminum Compression Lug Kits	H-frame	60 A	6-2 AWG Al or Cu	Unit/I-line [26]	1.2	1	YA060HD	3			
		150 A	1/0-4/0 AWG Al or Cu		2.5	1	YA150HD	3			
	J-frame	150 A	1-3/0 AWG Al or Cu		1.2	1	YA150JD	3			
		250 A	3/0-350 kcmil Al or Cu		2.5	1	YA250J35	3			
Copper Compression Lug Kits	H-frame	60 A	6-1/0 AWG Cu		1.0	1	CYA060HD	3			
		150 A	4-2/0 AWG Cu		1.2	1	CYA150HD	3			
	J-frame	150 A	6-1/0 AWG Cu		0.7	1	CYA150JD	3			
		250 A	2/0-300 kcmil Cu		1.1	1	CYA250J3	3			
<b>Compression Lug Kits for L-Frame Circuit Breakers</b>											
Aluminum Compression Lug Kits	L-frame	250 A	4-300 kcmil Al/Cu	Unit/I-line [26]	1.2	1	YA400L31K3	3			
		400 A	4-300 kcmil Al/Cu		2.5	2	YA600L32K3	6			
		250 A	2/0-500 kcmil Al/Cu		1.2	1	YA400L51K3	3			
		600 A	2/0-500 kcmil Al/Cu		2.5	2	YA600L52K3	6			
		400 A	500-750 kcmil Al 500 kcmil Cu		1.2	1	YA400L71K3	3			
		250 A	4-300 kcmil Al/Cu		2.5	2	YA400L31K4	4			
		400 A	4-300 kcmil Al/Cu		1.2	1	YA600L32K4	8			
		250 A	2/0-500 kcmil Al/Cu		2.5	2	YA400L51K4	4			
		600 A	2/0-500 kcmil Al/Cu		1.2	2	YA600L52K4	8			
		400 A	500-750 kcmil Al 500 kcmil Cu		2.5	1	YA400L71K4	4			
Copper Compression Lug Kits	L-frame	250 A	2/0-300 kcmil Cu	Unit/I-line [26]	1.2	1	CYA400L31K3	3			
		400 A	2/0-300 kcmil Cu		2.5	2	CYA600L32K3	6			
		250 A	250-500 kcmil Cu		1.2	1	CYA400L51K3	3			
		600 A	250-500 kcmil Cu		2.5	2	CYA600L52K3	6			
		250 A	2/0-300 kcmil Cu		1.2	1	CYA400L31K4	4			
		400 A	2/0-300 kcmil Cu		2.5	2	CYA600L32K4	8			
		250 A	250-500 kcmil Cu		1.2	1	CYA400L51K4	4			
		600 A	250-500 kcmil Cu		2.5	2	CYA600L52K4	8			
		<b>Compression Lug Kits for M-Frame, P-Frame, and R-Frame Circuit Breakers</b>									
		Aluminum Compression Lug Kits	M-, P-frame		250 A	2/0-300 kcmil	Unit/I-line [26]	3.7	2	YA250P3	1
300 A	4/0-500 kcmil			3.9	2	YA300P5		1			
400 A	2/0-300 kcmil			4.3	2	YA400P3		2			
400 A	500-750 kcmil Al, 500 kcmil Cu			3.7	2	YA400P7		1			
600 A	4/0-500 kcmil			3.9	2	YA600P5		2			
800 A	500-750 kcmil Al, 500 kcmil Cu			4.3	2	YA800P7		2			
R-frame [27]	1200 A		2/0-300 kcmil	I-line [26]	3.8	4	YA1200R3	4			
	1200 A		4/0-500 kcmil		4.0	4	YA1200R5	4			
	1200 A		500-750 kcmil Al, 500 kcmil Cu		4.4	4	YA1200R7	4			
	2000 A		2/0-300 kcmil	Unit [26]	— [27]	8	YA2000R3	2			
	2000 A		4/0-500 kcmil		— [27]	8	YA2000R5	2			
	2500 A		500-750 kcmil		— [27]	8 [28]	YA2500R7	2			
Copper Compression Lug Kits	M-, P-frame	400 A	4/0-500 kcmil	Unit [26]	3.3	2	CYA400P5	1			
		600 A	4/0-500 kcmil		3.3	2	CYA600P5	2			
		800 A	500-750 kcmil		3.6	2	CYA800P7	2			
	R-frame	1200 A	4/0-500 kcmil	I-Line [26]	3.5	4	CYA1200R5	4			
		1200 A	500-750 kcmil		3.8	4	CYA1200R7	4			

[26] Not for use on I-Line™ circuit breakers unless wire bending space is adequate.  
 [27] All unit-mount R-frame circuit breakers require terminal pads for mounting lugs of any type. See page 7-59.  
 [28] 9 lugs for 3000 A circuit breakers



PDC6HD6



PDC6JD4



PDC3HD2



PDC3JD20

Crimp lugs or PDC connectors extension "A" past end of circuit breaker

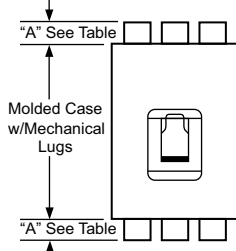

**Power Distribution Connectors**

Power distribution connectors (PDCs) can be used for multiple load wire connections on one circuit breaker in place of standard distribution block to save space and time.

The connectors are attached to circuit breaker terminals equipped with separately provided terminal nut connectors.<sup>[29]</sup>

Applications:

- For use on load end of circuit breaker only
- For use in UL 508 Industrial Control applications
- For use in UL 1995/CSA C22.2 No. 236 heating and cooling equipment
- For copper wire only

**Table 7.109: Power Distribution Connectors for B-Frame, H-Frame, J-Frame and L-Frame Circuit Breakers** <sup>[30]</sup>

Use with Circuit Breaker Type	Ampere Rating	(Wires Per Terminal) Wire Range	Dimension A (in.)	Cat. No.	Qty. Per Kit	Kit Contents
BD, BG, BJ	125 A	(3) 14 - 2 AWG	1.2	PDC3BD2	3	Mounting hardware, lugs
	125 A	(6) 14 - 6 AWG	1	PDC6BD6	3	
HD, HG, HJ, HL <sup>[31]</sup>	15–150 A	(6) 14–6 AWG Cu	1.0	PDC6HD6	3	Mounting hardware, lugs, special purpose label and instructions
	15–150 A	(3) 14–2 AWG Cu	1.2	PDC3HD2	3	
JD, JG, JJ, JL <sup>[31]</sup>	150–250 A	(6) 14–4 AWG Cu	1.0	PDC6JD4	3	
	150–250 A	(2) 14–1 AWG and (1) 3–2/0 AWG Cu	1.5	PDC3JD20	3	
LD, LG, LJ, LL <sup>[32]</sup>	150–600 A	(3) 14–1 AWG and (2) 3–2/0 AWG	1.28	PDC5DG20L3	3	Mounting hardware, lugs, special purpose label, Medium Terminal Shield and instructions
	150–600 A	(12) 14–4 AWG	1.31	PDC12DG4L3	3	Mounting hardware, lugs, special purpose label, Long Terminal Shield and instructions

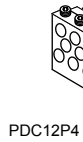

PDC12P4

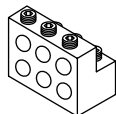

PDC6P20

**Table 7.110: Power Distribution Connectors for M-Frame and P-Frame Circuit Breakers** <sup>[30]</sup>

	Ampere Rating	(Wires Per Terminal) Wire Range	Cat. No.	Qty Per Kit	Kit Contents
Use for multiple load connections on one circuit breaker in place of standard distribution block to save space and time. • Use on load end of circuit breaker only • Use in UL508 Industrial Control applications only. • Use in UL1995/CSA C22.2 No. 236 heating and cooling equipment. • For Cu wire only.	250–1200 A	(6) 12–2/0 AWG Cu	PDC6P20	3	Mounting hardware, lugs, special purpose label and instructions
		(6) 12–2/0 AWG Cu	PDC6P204	4	Mounting hardware, lugs, special purpose label and instructions
	250–1200 A	(12) 10–4 AWG Cu	PDC12P4	3	Mounting hardware, lugs, special purpose label and instructions
			PDC12P44	4	Mounting hardware, lugs, special purpose label and instructions

[29] Refer to Table xxxxxx: Terminal Shields and Phase Barriers

[30] Not for use with I-Line™ circuit breakers.

[31] Special Purpose—Not for General Use. Use on ON end of the circuit breaker only when ON end is used as Load end. Use on OFF end of the circuit breaker only when OFF end is used as Load end.

[32] Kit includes long terminal shield and cover, which adds 1.65 inches to standard lug with short terminal shield.

**Terminal Accessories**

**Table 7.111: Terminal Nuts for Bus Bar Connection of B-, H- and J-Frame Circuit Breakers**

Description	Frame	Tap	Cat. No.	Qty Per Kit
B-Frame Terminal Nut Insert-Metric	BD/BG/BJ (2P)	M6	LV426962	2
B-Frame Terminal Nut Insert-Metric	BD/BG/BJ (3P)	M6	LV426963	3
H-Frame Terminal Nut Insert-English	HD/HG/HJ/HL	1/4-20	S37425	2
H-Frame Terminal Nut Insert-English	HD/HG/HJ/HL	1/4-20	S37444	3
H-Frame Terminal Nut Insert-Metric	HD/HG/HJ/HL	M6	S37426	2
J-Frame Terminal Nut Insert-English	JD/JG/JJ/JL	1/4-20	S37427	2
J-Frame Terminal Nut Insert-English	JD/JG/JJ/JL	1/4-20	S37445	3
J-Frame Terminal Nut Insert-Metric	JD/JG/JJ/JL	M8	S37428	2
Control Wire Terminal for H-Frame Terminal Nut	HD/HG/HJ/HL	—	S37429	2
Control Wire Terminal for J-Frame Terminal Nut	JD/JG/JJ/JL	—	S37430	2



H-Frame Lug with Terminal Nut Insert

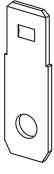

Control Wire Terminal for J-Frame Terminal Nut

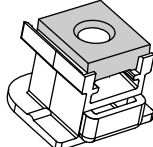

Terminal Nut Insert

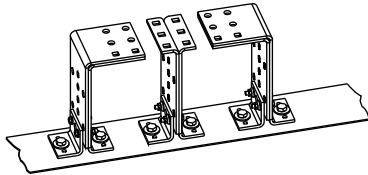

RLTB Terminal Pad Kit

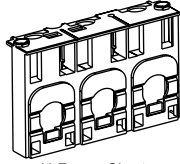

H-Frame Short Lug Shield

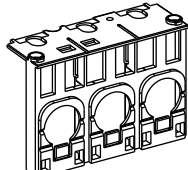

J-Frame Short Lug Shield

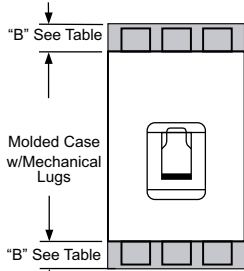

"B" See Table

Molded Case w/Mechanical Lugs

"B" See Table

Phase barrier or terminal shield extension past end of circuit breaker

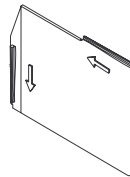

R-Frame Phase Barrier

**Table 7.112: Bus Bar Connections Hardware for L-, M-, and P-Frame Circuit Breakers**

Frame	Description	Term. No.	Poles	Cat. No.
L-Frame	Set of 4 terminal screws and washers for one side	F	4	S36967
M- and P-Frame	Bus Connector Kit for one pole, one end	—	1	S33928

**Table 7.113: Terminal Pad Kits for R-Frame Circuit Breakers**

R-Frame Circuit Breaker	Terminal Pad Kit		Field-Installable Kits	
	Usage	Lugs per Phase	3P Kit (One End Only) Cat. No.	4P Kit (One End Only) Cat. No.
3000 A, 100% Rated [33]	Required for cable or bus	9	RL3TB	RL3TB4
3000 A, Standard (80% Rated) [34]	Required for cable or bus			
2500 A, 100% Rated	Required for cable or bus	8	RLTB	RLTB4
2500 A, Standard (80% Rated)	Required for cable, optional for bus			
All Other R-Frame Circuit Breakers	Required for cable, optional for bus			

For cable connection to RLTB, use AL2500RK lug. See page 7-57.

**Table 7.114: Terminal Shields and Phase Barriers**

Used With	Description			Dimension B (in.)	Cat. No.	Qty Per Kit	
H- and J-Frame Mechanical Lugs	Short Lug Shield [35]	Frame	Max. Wire Size				
		H-Frame 60 A	3 AWG	0.50	S37446	1	
		H-Frame 150 A	3/0 AWG	0.50	S37447	1	
		J-Frame	350 kcmil	0.24	S37448	1	
B-, H- and J-Frame Power Distribution Connectors and Compression Lugs	Compatible with:	PDC	Compression Lugs				
			Aluminum	Copper			
	B-Frame Long Lug Shield	PDC3BD2	L- V426988	LV426986	1.9	LV426911 (2P) LV426912 (3P) LV426913 (4P)	1
		PDC6BD6	V426989	LV426987			
	H-Frame Long Lug Shield	PDC6HD6	YA060HD	CYA060HD	2.24	S37449	1
		PDC3HD2	YA150HD	CYA150HD			
	J-Frame Long Lug Shield	PDC6JD4	YA150JD	CYA150JD	1.68	S37450	1
PDC3JD2		[36]	CYA250J3				
L-Frame	3P Short Terminal Shield				LTSS3P	1	
	3P Medium Terminal Shield				LTSM3P	1	
	3P Long Terminal Shield				LTSL3P	1	
	4P Medium Terminal Shield				LTSM4P	1	
4P Long Terminal Shield				LTSL4P	1		
M-, P-Frame	Phase Barriers				S33646	3	
R-Frame	Phase Barriers				S33998		

**Table 7.115: Miscellaneous H-, J-, and L-Frame Circuit Breaker Accessories**

Accessory	Description	Field-Installable Cat. No.
Spare Parts	Bag of screws for accessory cover, L-frame	S432552
	1 spare toggle extension, L-frame	32595
	Set of 10 identification labels	LV429226

[33] 3000 A 80% and 100% rated RL3TP (3P) and RL3TP4 (4P) ship with 2 kits.  
 [34] 2500 A 80% and 100% rated RLTB (3P) and RLTB4 (4P) ship with 2 kits.  
 [35] Short lug shields provide IP20 protection for mechanical lugs and are compatible with control wire terminals.  
 [36] J-frame terminal shield is not compatible with the YA250J35 compression terminal.



Mountings

Table 7.116: Plug-In and Drawout Mountings for H- and J-Frame Circuit Breakers (3P or 2P in a 3P module)



H- and J-Frame Plug-In Mounting



H- and J-Frame Drawout Mounting

Description		Factory Installed Cat. No.	Field-Installable Cat. No.	
Complete Factory-Assembled Circuit Breakers	Plug-in base shipped with circuit breaker	N	—	
	Drawout cradle shipped with circuit breaker	D	—	
Special Order Options for Plug-In and Drawout Circuit Breakers	Plug-In Base	Circuit breaker Only	HJ00	
		Plug-in base kit	—	S29278
	Drawout Cradle	Circuit breaker only	HJ00	—
		Plug-in base kit	—	S29278
		Cradle side plates (fixed part of chassis)	—	S29282
		Circuit breaker side plates (moving part of chassis)	—	S29283
Accessories for Plug-In and Drawout	H-Frame Shutter Kit (set of two)	—	S37442	
	J-Frame Shutter Kit (set of two)	—	S37443	
	Secondary Disconnect Blocks	Fixed part 9-wire connector (mounted on base)	—	S29273
		Moving part 9-wire connector (mounted on circuit breaker)	—	S29274
		Support for 2-moving connectors	—	S29275
	Extended escutcheon with extended toggle handle	—	S29284	
	Two position indicating switches (connected/disconnected)	—	S29287	
	H-Frame Short Terminal Cover (3P)	—	S37436	
J-Frame Short Terminal Cover (3P)	—	S37440		



L-Frame Plug-In Mounting



L-Frame Drawout Mounting

Table 7.117: Plug-In and Drawout Mountings for L-Frame Circuit Breakers

Description	Poles	Plug-in Mounting		Drawout Mounting		
		Factory-Installed Cat. No.	Field-Installable Cat. No.	Factory-Installed Cat. No.	Field-Installable Cat. No.	
Kit (stationary and moving parts)	3	N	—	D	—	
	4	N	—	D	—	
Stationary Part	Plug-in base	3	—	S32514	—	
		4	—	S32515	—	
Moving Part	Fixed part of chassis	—	—	—	S32532	
		—	—	—	S32533	
	Circuit breaker only	—	HJ00	—	HJ00	—
		—	—	—	—	—
Short terminal covers	3	—	2x S32562	—	2x S32562	
	4	—	2x S32563	—	2x S32563	

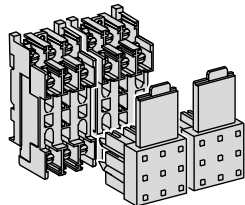

L-Frame Disconnecting Blocks

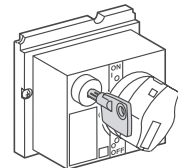

L-Frame Locking Device

Table 7.118: Plug-In and Drawout Accessories for L-Frame Circuit Breakers

Description		Field-Installable Cat. No.
Secondary Disconnecting Blocks	Fixed Part	9-wire connector
	Moving Part	9-wire connector
		Support for 3 moving connectors
Fixed + Moving	9-wire manual auxiliary connector	
Shutters	Two shutters for plug-in base	32521
Chassis Accessories	Extended escutcheon for toggle	S32534
	Locking device (key lock is not included)	S29286
	Two position indicating switches (connected/disconnected)	29287

Table 7.119: Termination Options

Termination Letter	Termination No.
N = Plug-in	L G L 3 6 4 0 0 U 3 1 X
D = Drawout	For factory-installed termination, place termination letter in the third block of the circuit breaker catalog number.

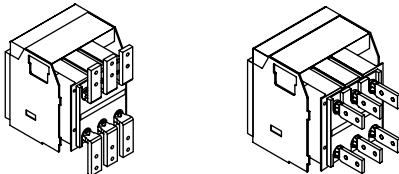

P-Frame Drawout Cradle Connections

Table 7.120: Drawout Cradle and Accessories for P-Frame Circuit Breakers

Description	Cat. No.	
Drawout Cradle	Product Selector	
Cradle Connectors	Front Connected Flat (FCF)	
	Rear Connected T Horizontal/Vertical (RCTH/RCTV)	
Cradle Accessories	SFCF12 [37]	
	SRCTV12 [37]	
	Modbus™ cradle communication module	S33852
	Safety shutters	S48933
	Secondary disconnects terminal shield	S33763
	Cradle position switch 1a/1b Form C—Connected/test/disconnected	S33170
	Low level cradle position switch 1a/1b Form C—Connected/test/disconnected	S33171
	Cell keying kit	S33767
	Disconnected position key locking—provision for Kirk or Federal Pioneer Lock	S33772
	Door interlock kit	S33786
	Racking interior kit	S33788
	Door escutcheon (for replacement only, included with circuit breaker)	S33857
	Transparent cover	S33859
	Push-in terminal kit (3 wires)	S33098
	Push-in terminal kit (6 wires)	S33099
	Finger cluster	S33166
	Cluster grease (12 oz. tube)	S48899

[37] Needs 2 kits per cradle.

PowerPact H-, J-, and L-Frame MicroLogic Trip Units



**MicroLogic Trip Units [1]**  
**MicroLogic Standard 3.2/3.3 Trip Units**

PowerPact<sup>TM</sup> H-, J-, and L-frame molded case circuit breakers may be specified with any of the following MicroLogic Electronic Trip Units.

- True RMS sensing
- LI, LSI trip configurations
- Field-interchangeable trip units
- LED long-time pickup and trip indication
- Test kits available
- Thermal imaging

**MicroLogic Ammeter 5.2A/5.3A/6.2A/6.3A Trip Units**

Includes all features listed for MicroLogic standard trip unit, as well as:

- Advanced user interface
- Neutral protection
- Incremental fine tuning of settings
- Up to 12 alarms
- Digital ammeter—phase and neutral (4-pole only)
- Phase loading bar graph
- Maintenance indicators including contact wear, number of operations, operating hours, and load profiles
- Cause of trip information for troubleshooting assistance
- LCD Display
- Zone-selective interlocking (ZSI) (short-time & ground-fault)
- Optional Modbus<sup>TM</sup> communications—PowerLogic<sup>TM</sup> compatible

**MicroLogic Energy 5.2E/5.3E/6.2E/6.3E Trip Units**

Includes all features listed for MicroLogic ammeter trip unit, as well as:

- Ground-fault trip with programmable ground fault alarm (available on 6.2E/6.3E only)
- Power and energy measurement
- Power quality measurements
- Current demand and power demand measurements

**PowerPact H, J and L-Frame MicroLogic Trip Units**

**Table 7.121: MicroLogic Trip Unit Settings for H-, J-, and L-Frame**

Model	Trip Function	Trip Unit	Ampere Setting
<b>MicroLogic Trip Unit Settings for H- and J-Frame Circuit Breakers</b>			
Standard	LI	3.2	15-20-25-30-35-40-45-50-60
			35-40-45-50-60-70-80-90-100
	LSI	3.2S	50-60-70-80-90-100-110-125-150
			70-80-100-125-150-175-200-225-250
Ammeter	LSI	5.2A	15-20-25-30-35-40-45-50-60
			35-40-45-50-60-70-80-90-100
	LSIG	6.2A	50-60-70-80-90-100-110-125-150
			70-80-100-125-150-175-200-225-250
Energy	LSI	5.2E	15-60
			35-100
	LSIG	6.2E	50-150
			70-250
<b>MicroLogic Trip Unit Settings for L-Frame Circuit Breakers</b>			
Standard	LI	3.3	15-60
			35-100
	LSI	3.3S	50-150
			70-250
Ammeter	LSI	5.3A	125-400
			200-600
	LSIG	6.3A	125-400
			200-600
Energy	LSI	5.3E	125-400
			200-600
	LSIG	6.3E	125-400
			200-600

[1] See Supplemental Digest Section 3 for circuit breakers with field-interchangeable trip units.

## PowerPact P- and R-Frame MicroLogic Trip Units

PowerPact P- and R-Frame MicroLogic Trip Units



Standard Trip Unit

Ammeter Trip Unit

Power Trip Unit

Harmonic Trip Unit

Adjustable Rating Plug

### MicroLogic (Standard) 3.0 and 5.0 Trip Units

PowerPact™ P- and R-frame molded case circuit breakers may be specified with any of the following MicroLogic Electronic Trip Units.

- True RMS sensing
- LI, LSI trip configurations
- Field-interchangeable long-time rating plugs
- LED long-time pickup indication
- Test kits available
- Thermal imaging

### MicroLogic (Ammeter) 3.0A, 5.0A and 6.0A Trip Units

Includes all features listed for MicroLogic standard trip unit, as well as:

- LSIG trip configurations
- Digital ammeter—phase and neutral (4-pole only)
- Phase loading bar graph
- LED trip indication
- Zone-selective interlocking (ZSI) (short-time & ground-fault)
- Optional Modbus™ communications—PowerLogic™ compatible

### MicroLogic (Power) 5.0P and 6.0P Trip Units

Power measurement and advanced protection features includes all features listed for MicroLogic ammeter trip unit, as well as:

- LSI trip configuration with programmable ground fault alarm
- LSIG (Ground-fault trip) with programmable ground fault alarm
- Incremental “fine tuning” of L, S, I, and G pickup and delay settings
- LCD dot matrix display and LED trip indication
- Advanced user interface
- Advanced protection IDMTL—selectable long-time delay bands
- Neutral protection
- Power measurement
- Contact wear indication
- Modbus communications—PowerLogic compatible
- Local and remote settings

### MicroLogic (Harmonic) 5.0H and 6.0H Trip Units

Power quality measurement and advanced protection features. Includes all features listed for the MicroLogic power trip unit, as well as:

- Enhanced power measurements functions
- Power quality measurements

### Adjustable Rating Plugs for PowerPact™ P-Frame and R-Frame and MasterPact™ NT and NW Circuit Breakers—Selection

To provide maximum design flexibility, system protection, and field upgradeability, each MicroLogic™ trip unit is equipped with an interchangeable long-time rating plug. Each trip unit requires an adjustable rating plug to determine the long-time pickup range of the circuit breaker. These plugs are factory installed on new trip units, or can be ordered separately for field-installable upgrades.

Adjustable rating plugs are offered in eight different ranges of long-time pickup adjustments. The following chart show the ranges of adjustments. Each adjustment times the sensor rating ( $I_r \times I_n$ ) of the circuit breaker sets the long-time pickup value of the circuit breaker.

**Table 7.122: PowerPact P- and R-Frame MicroLogic Trip Unit and Options**

Model	Protection	Additional Features	Field-Installable Cat. No. [2]
2.0 (IEC only)	LSO	None	S132R
3.0 (UL/ANSI only)	LI		S131A
5.0	LSI		S133A
2.0A (IEC only)	LSO	Ammeter	S142R [3]
3.0A (UL/ANSI only)	LI		S141A [3]
5.0A	LSI		S143A [3]
6.0A	LSIG		S144A [3]
5.0P	LSI	Metering, Adv. Protection	S163A [3][4]
6.0P	LSIG		S164A [3][4]
5.0H	LSI	Metering, Adv. Protection & Harmonic Analysis	S173A [3][4]
6.0H	LSIG		S174A [3][4]

**Table 7.123: PowerPact P- and R-Frame MicroLogic Trip Units**

**x – Standard Feature    o – Available Option**

Features	Standard		Ammeter			Power		Harmonic	
	3.0	5.0	3.0A	5.0A	6.0A	5.0P	6.0P	5.0H	6.0H
LI	X	—	X	—	—	—	—	—	—
LSI (Instantaneous can be turned off)	—	X	—	X	X	X	X	X	X
LSIG / Ground-Fault Trip [5]	—	—	—	—	X	—	X	—	X
Ground-Fault Alarm (No Trip) [5][6]	—	—	—	—	—	X	—	X	—
Ground-Fault Alarm and Trip [5][6]	—	—	—	—	—	—	X	—	X
Adjustable Rating Plugs	X	X	X	X	X	X	X	X	X
True RMS Sensing	X	X	X	X	X	X	X	X	X
UL Listed	X	X	X	X	X	X	X	X	X
Thermal Imaging	X	X	X	X	X	X	X	X	X
Phase Loading Bar Graph	—	—	X	X	X	X	X	X	X
LED for Long-time Pickup	X	X	X	X	X	X	X	X	X
LED for Trip Indication	—	—	X	X	X	X	X	X	X
Digital Ammeter	—	—	X	X	X	X	X	X	X
Zone-selective Interlocking	—	—	X	X	X	X	X	X	X
Communications	—	—	X	X	X	X	X	X	X
LCD Dot Matrix Display	—	—	—	—	—	X	X	X	X
Advanced User Interface	—	—	—	—	—	X	X	X	X
Protective Relay Functions	—	—	—	—	—	X	X	X	X
Neutral Protection	—	—	—	—	—	X	X	X	X
Contact Wear Indication	—	—	—	—	—	X	X	X	X
Incremental Fine Tuning of Settings	—	—	—	—	—	X	X	X	X
Selectable Long-time Delay Bands	—	—	—	—	—	X	X	X	X
Power Measurement	—	—	—	—	—	X	X	X	X
Power Quality Measurements	—	—	—	—	—	—	—	X	X
Waveform Capture	—	—	—	—	—	—	—	X	X

**Table 7.124: PowerPact P- and R-Frame Long-Time Pickup Settings**

Rating Plug	Long-time Pickup Settings								
A	.40	.45	.50	.60	.63	.70	.80	.90	1.0
B	.40	.44	.50	.56	.63	.75	.88	.95	1.0
C	.42	.50	.53	.58	.67	.75	.83	.95	1.0
D	.40	.48	.64	.70	.80	.90	.93	.95	1.0
E	.60	.70	.75	.80	.85	.90	.93	.95	1.0
F	.84	.86	.88	.90	.92	.94	.96	.98	1.0
G	.66	.68	.70	.72	.74	.76	.78	.80	.82
H	.48	.50	.52	.54	.56	.58	.60	.62	.64

**Table 7.125: Special Options**

Description	Factory-Installed Suffix	Field-Installable Cat. No.
Ship circuit breaker in closed position	YK	N/A
CT Characterization (Calibrated trip system)	Q	N/A
Alternate Maintenance Setting (AMS) kit (use with 5.0/6.0 A, P or H and 5.3/6.3 A or E MicroLogic trip units)	—	84957
Energy Reduction Maintenance Setting (ERMS) kit (use with 5.0/6.0 P or H MicroLogic trip units)	—	84956
Maintenance Mode Setting Switch kit	120 Vac	LV429659
	24 Vdc	LV429658

[2] The standard rating plug supplied with a trip unit will be the "A" rating plug. To specify an alternative adjustable rating plug, please add the letter designation to the end of the catalog number. Please refer to page 7-64 for a complete listing of adjustable settings available with each plug. (Example: S143B would specify a "B" rating plug instead of the standard "A" plug.) Use suffix "N" if no rating plug is required, deduct.

[3] When replacing a standard trip unit with Type A (Ammeter), P (Power metering) or H (Harmonic analysis) trip unit, order the 12-pin connector kit S33101 for the MasterPact NW and NT and the PowerPact P-frame drawout circuit breakers or kit S33100 for PowerPact P-frame and R-frame unit-mount and I-Line circuit breakers. See page 7-64.

[4] Requires Circuit Breaker Communications Module.

[5] Requires neutral current transformer in 3Ø4W systems.

[6] Alarm history is available through the trip unit display and communications. Local indication of an alarm requires an M2C Programmable Contact Module.

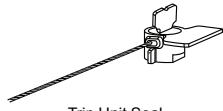

Trip Unit Seal



Sensor Plug

### Trip Unit Accessories

Adjustable rating plug "A" is installed as standard on all MicroLogic trip unit orders. However, an alternative selection may be specified from the "Assembled" table below, and factory installed with your trip unit order at no additional charge. To order, please attach the appropriate catalog suffix to the end of the trip unit Cat. No. (after specifying trip unit options). Adjustable rating plugs may also be purchased as field-installable components from the table below.

For Enerlin'X accessory information, see [Enerlin'X Digital Solutions, page 7-81](#)

Table 7.126: Rating Plugs

Rating Plug [7]	Factory Installed Cat. Suffix	Field-Installable Cat. No.
A	A (standard)	S48818
B	B	S48819
C	C	S48820
D	D	S48836
E	E	S48837
F	F	S48838
G	G	S48839
H	H	S48840

Table 7.127: Neutral Current Transformers

Use With	Cat. No.	Sensor
H-Frame	S429521	60–100
	S430562	150
J-Frame	S430563	250
L-Frame	S432575	400–600
P-Frame	S33575 [8]	250
	S33576 [8]	400–1600
R-Frame	S48916 [8]	250
	S34036 [8]	400–1600
	S48896 [8]	2000
	S48182 [8]	3000
All	NCTWIRING	All

Table 7.128: Zone-Selective Interlocking

Description	Factory-Installed Cat. Suffix	Field-Installable Cat. No.
ZSI Interface Module	—	S434212
24 Vdc Terminal Block	EN	S434210
ZSI Wire Harness, H/J Frame	YH3	S434300
ZSI Wire Harness, L-Frame	YH3	S434301
ENCT & ZSI Wire Harness	YH4	—

Table 7.129: Trip Unit Accessories

Device	Frame	Cat. No.
Pocket Tester	H/J/L	S434206
UTA Tester		STRV00910
Spare UTA Tester		STRV00911
Bluetooth/Modbus for UTA Tester		SVW3A8114
Spare Power Supply for UTA Tester (110–120 Vac)		TRV00915
MicroLogic Cord for UTA Tester		TRV00917
MicroLogic 5/6 Cover, Transparent	H/J	S429478
MicroLogic 2/3 Cover, Transparent		S429481
MicroLogic 5/6 Cover, Transparent	L	S432459
MicroLogic 2/3 Cover, Transparent		S432461
LCD Display for MicroLogic 5	H/J/L	S429483
LCD Display for MicroLogic 6		S429484
Hand-held Test Kit	P/R	S33594
Primary Injection Test Adaptor		S33937
Service Interface Kit [9]		LV485500
Seven-pin Test Cable (for connection between test kit and trip unit) [10]		S48907
Two-pin Test Cable (for connection between test kit and trip unit) [11]		S48908
M2CTEST (for isolated trip unit testing) [12]		M2CTEST
230 Vac Filtered Power Cord [13]		S48856
120 Vac Filtered Power Cord [13]		S48855
Trip Unit Battery for Trip Indicator Lights		S33593
Power supply with:		24–30 Vdc input
	48/60 Vdc input	LV454441
	125 Vdc input	LV454442
	110–130 Vac input	LV454443
	200–240 Vac input	LV454444
MicroLogic A Trip Unit Cover, clear	P/R	S33592
MicroLogic P/H Trip Unit Cover, opaque gray		S47067
Trip Unit Seal (6 pieces) for compliance with NEC 240.6(c)	H/J/L/P/R	MICROTUSEAL
12-pin Trip Unit Connector for NT/NW MasterPact Circuit Breakers	P/R	S33101
12-pin Trip Unit Connector for P- and R-Frame Circuit Breakers		S33100
Battery Back-up (12 Hours)		685831

Table 7.130: Sensor Plugs for P- and R-Frame Circuit Breakers [14]

Description	Sensor Plug Range	Sensor Plug Cat. No.	Circuit Breaker Frames Accepting Sensor Plug									
			250 A	400 A	600 A	630 A [15]	800 A	1000 A	1200 A	1250 A [15]	1600 A	
P-Frame Circuit Breaker												
UL	250 A	S47052	X	—	—	—	—	—	—	—	—	—
	400 A	S47053	—	X	—	—	—	X	—	—	—	—
	600 A	S48823	—	—	X	—	—	X	X	—	—	—
	800 A	S33092	—	—	—	—	X	X	X	—	—	—
	1000 A	S33093	—	—	—	—	—	X	X	X	—	—
	1200 A	S48824	—	—	—	—	—	—	X	X	—	—
IEC	630 A	S33091	—	—	—	X	X	X	—	X	X	X
	800 A	S33092	—	—	—	—	X	X	—	X	X	X
	1000 A	S33093	—	—	—	—	—	X	—	X	X	X
	1250 A	S33094	—	—	—	—	—	—	—	—	X	X
	1600 A	S33095	—	—	—	—	—	—	—	—	—	X
R-Frame Circuit Breaker												
UL	600 A	S48823	X	X	X	X	—	—	—	—	—	—
	800 A	S33092	—	X	X	X	X	—	—	—	—	—
	1000 A	S33093	—	—	X	X	X	—	—	—	—	—
	1200 A	S48824	—	—	—	X	X	X	—	—	—	—
	1600 A	S33095	—	—	—	—	X	X	X	X	—	—
	2000 A	S33982	—	—	—	—	—	X	X	X	X	—
	2500 A	S33983	—	—	—	—	—	—	X	X	X	—
	3000 A	S48825	—	—	—	—	—	—	—	X	X	—
IEC	1600 A	S33095	—	—	—	—	X	X	X	X	X	X
	2000 A	S33982	—	—	—	—	—	X	X	X	X	X
	2500 A	S33983	—	—	—	—	—	—	X	X	X	X
	3200 A	S33984	—	—	—	—	—	—	—	—	—	X

[7] Long-time pickup amperes (Ir) = Sensor Rating (In) X Setting of rating plug. "Fine adjustment tuning" is included on MicroLogic Power and Harmonic trip units, allowing for incremental settings of 1 A between the plug setting and .40 X Sensor Rating.

[8] Includes NCTWIRING kit.

[9] Service Interface Test Kit can be ordered through SE Services only. Service Interface Test kit replaces obsolete Full Function Test Kit.

[10] Used for testing MicroLogic trip units. Included in the price of the Hand-held/Full-function Test Kits. Kit for replacement only.

[11] Used for testing STR trip units. Included in the price of the Hand-held/Full-function Test Kits. Kit for replacement only.

[12] Required for Arc Energy Reduction Performance Testing for Instantaneous setting or Maintenance Mode Switch when using a Full Function Test Kit

[13] Included with the Full-function Test Kit. Kit for replacement only.

[14] For use only with circuit breakers with date codes later than 07011. For long-time pickup range, See rating plug information at page 7-61.

[15] IEC Only.

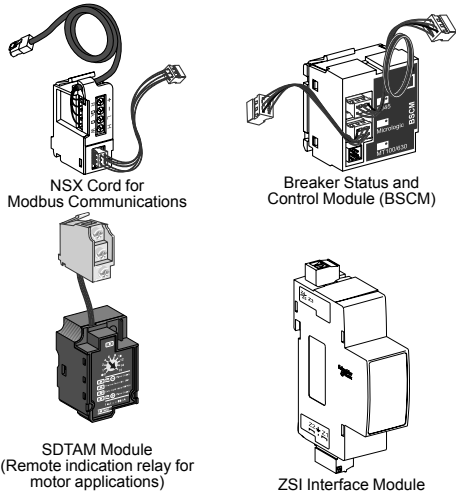

**Table 7.131: Electronic Trip Unit Accessories, Wire Harness [16] and ULP Cords for H-, J-, and L-Frame Circuit Breakers [17]**

Description	Factory-Installed Cat. No. Suffix	Field-Installable Kit Cat. No.	
		Unit Mount	I-Line
NSX Cord [18] (for Modbus Communication)	L = 1.3 m (4.27 ft)	EA	S434201
	L = 3 m (9.84 ft)	EB	S434202
BSCM (Breaker Status and Control Module) with NSX Cord [18]	L = 1.3 m (4.27 ft)	EG [19]	S434201BS
	L = 3 m (9.84 ft)	EH [19]	S434202BS
Replacement BSCM	—	—	S434205
BSCM with NSX Cord for V > 480 Vac [18]	L = 1.3 m (4.27 ft)	EK [19]	S434204BS
	L = 3 m (9.84 ft)	EL [19]	S434303BS
SDTAM 24/415 Vac/dc Module [20]	—	V	S429424
SDX Module 24/415 Vac/dc [21]	—	V	S429532
ZSI Wire Harness, H/J Frame	—	YH3	S434300
ZSI Wire Harness, L-Frame	—	YH3	S434301
ENCT Wire Harness	—	YH2	S434302
OF Wire Harness	—	YH1	S434500
SD/SDE Wire Harness	—	YH1	S434501
SDx/SDTAM Wire Harness	—	YH1	S434502
MN Wire Harness	—	YH1	S434503
MX Wire Harness	—	YH1	S434504
24 Vdc Terminal Block Wire Harness [22]	—	YH1	S434505
Motor Operator Wire Harness	—	YH1	S434506
Communicating Motor Operator Wire Harness	—	YH1	S434507
NSX Wire Harness [22]	—	YH1	S434508

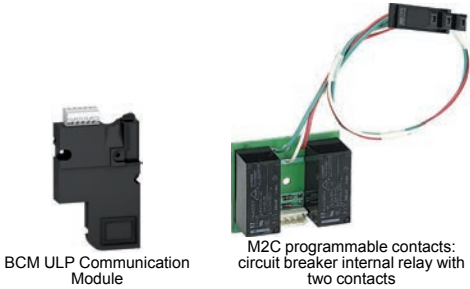

**Table 7.132: Trip Unit Field-Installable Accessories for P- and R-Frame Circuit Breakers**

Description	Factory-Installed Cat. No. Suffix	Field-Installable Kit Cat. No.						
		P-Frame					R-Frame	
		Unit Mount	I-Line	Motor Operated	Drawout	With Rotary Handle	Unit Mount	I-Line
Circuit Breaker Communication Module (BCM ULP)	E1	S64205	S64205	S64207	S64206	S64205	S64205	S64205
Replacement BCM ULP	—	33106	33106	33106	33106	33106	33106	33106
Two Programmable Contacts Module (M2C)[23]	V	S64273	S64273	S64273	S64273	S64273	S64273	S64273
External Voltage Sensing (EVS)	YV	S64203	S64203	S64210	S64209	S64210	S64208	S64208

**Table 7.133: Trip Unit Field-Installable Accessories for MasterPact NT/NW Circuit Breakers**

Description	Factory-Installed Cat. No. Suffix	Field-Installable Kit Cat. No.			
		MasterPact NT		MasterPact NW	
		Fixed	Drawout	Fixed	Drawout
Circuit Breaker Communication Module (BCM ULP)	—	S48188	S47485	S47405	S48384
Replacement BCM ULP	—	33106	33106	33106	33106
Two Programmable Contacts Module (M2C)[23]	—	S47403	S47485	S47403	S48382
External Voltage Sensing (EVS)	—	S47506	S47507	S47506	S48533

[16] Wire harness is required for I-Line applications, optional for unit-mount applications

YH1 = all installed accessories but ZSI and ENCT  
 YH2 = ENCT and all installed accessories  
 YH3 = ZSI and all installed accessories  
 YH4 = ZSI, ENCT and all installed accessories

[17] For proper selection, see catalog 0611CT1001.

[18] Installation requires IFM (LV434000) for Modbus communication and/or FDM (STRV00121) for external display.

[19] If using with motor operator requires communicating motor operator (suffix NC).

[20] Remote indication relay for motor applications

[21] Remote indication relay

[22] I-Line wire harness is included for communication network accessories.

Optional wire harness for unit mount requires YH1 suffix.

[23] Compatible with MicroLogic P and H only.

New!

MasterPact MTZ Circuit Breakers

MasterPact MTZ continues the performance and reliability of the MasterPact line.

MasterPact MTZ circuit breakers bring innovation and upgradability throughout the entire lifecycle, for improved power uptime, business performance, and cost control.

- Customize MicroLogic X control unit anytime
- Purchase optional Digital Modules for additional protection, measurement and maintenance & diagnostic
- Easy installation using established architectures
- Demonstrated compliance with standards
- Smartphone connectivity for wireless alerts and maintenance
- Built in power meter with Class 1 precision for smart energy metering



MasterPact MTZ2  
800–4000 A

Table 7.134: MasterPact MTZ1 Circuit Breaker Ratings

Standard Frame Rating Interrupting Code	ANSI C37 Certified/ UL 1066 Listed	UL 489 Listed														
		800 A						1200 A				1600 A [1]				
		N1	N	H	L1	L	LF [2]	N	H	L1	L	LF [2]	N	H	L1	L
Interrupting Current (kA RMS) 50/60 Hz	240 Vac	42	50	65	100	200	200	50	65	100	200	200	50	65	100	200
	480 Vac	42	50	50	65	100	100	50	50	65	100	100	50	50	65	100
	600 Vac	—	35	50	—	—	—	35	50	—	—	—	35	50	N/A	N/A
Short-time Withstand Current (kA RMS)	42	35	35	10	10	10	35	35	10	10	10	35	35	10	10	
Built-in Instantaneous Override (kA RMS ±10%)	—	40	40	10	10	10	40	40	10	10	10	40	40	10	10	
Close and latch rating (kA RMS)	40	25	25	10	10	10	25	25	10	10	10	25	25	10	10	
Tested to show the arc flash hazard risk category as referenced by NFPA70E	—	—	—	—	—	Yes	—	—	—	—	Yes	—	—	—	—	
Breaking time	25–30 ms with no intentional delay	25–30 ms with no intentional delay (9 ms for L and LF)														
Closing time	—	< 50 ms														
Sensor Rating	—	400–800 A						600–1200 A				800–1600 A				
Endurance Rating (C/O Cycles) With No Maintenance	Mechanical	12,500	12,500						12,500				12,500			
	Electrical	2800	2800						2800				2800			

Table 7.135: MasterPact MTZ2 and MTZ3 Circuit Breaker Ratings

Standard Frame Rating Interrupting Code	ANSI C37 Certified/UL 1066 Listed														UL 489 Listed													
	800–1600 A						2000 A				3200/4000 A [3]				4000/5000 A				800/1200/1600/2000 A		2500/3000 A		4000/5000/6000 A					
	N1	H1	H2	H3	L1 [2]	L1F [2]	H1	H2	H3	L1 [2]	L1F [2]	H1	H2	H3	L1 [2]	H2	H3	L1 [2]	N	H	L [2]	LF [2]	H	L [2]	H	L [2]		
Interrupting Current (kA RMS) 50/60 Hz	240 Vac	42	65	85	10-0	200	200	65	85	100	200	200	65	85	100	200	85	100	200	65	100	200	200	100	200	100	200	
	480 Vac	42	65	85	10-0	200	200	65	85	100	200	200	65	85	100	200	85	100	200	65	100	150	150	100	150	100	150	
	600 Vac	42	65	85	85	130	130	65	85	85	130	130	65	85	85	130	85	85	130	50	85	100	100	85	100	85	100	
Short-time Withstand Current (kA RMS)	42	65	85	85	30	22	65	85	85	30	22	65	85	85	100	85	85	100	42	65	30 [4]	22	65	65	85	100		
Built-in Instantaneous Override (kA RMS ±10%)	35	35	35	85	35	24	—	—	85	35	24	—	—	85	117	—	—	117	40	40	35 [4]	24	65	65	75	75		
Close and latch rating (kA RMS)	42	65	40	40	25	22	65	40	40	25	22	65	40	40	40	85	75	40	40	40	25 [5]	22	40	40	40	40		
Tested to show arc flash hazard risk category as referenced by NFPA70E	—	—	—	—	—	Yes	—	—	—	—	Yes	—	—	—	—	—	—	—	—	—	—	Yes	—	—	—	—		
Breaking time	25–30 ms with no intentional delay (9 ms for L1, L1F, L and LF)																											
Closing time	70 ms																											
Sensor Rating (A)	400–800 800–1600						1000–2000				1600–3200				2000–4000 2500–5000				400–800 600–1200 800–1600 1000–2000		1200–2500 1600–3000		2000–4000 2500–5000 3000–6000					
Endurance Rating (C/O Cycles) With No Maintenance	Mech.	12,500						10,000				10,000				5k				5,000		12,500 [6]		10,000		5,000		
	Elec.	2800						1,000				1,000				1k				1,000		2800 [6]		1,000		1,000		

[1] Fixed mounted only.  
 [2] Drawout mounted only.  
 [3] 4000 A standard width circuit breaker is not available in L1 interrupting rating code or drawout construction (fixed mounting only).  
 [4] 65 kA RMS for 2000 A.  
 [5] 40 kA RMS for 2000 A.  
 [6] For 2000 A N/H/L/LF devices, the endurance rating is 10,000 for mechanical and 1000 for electric.

7 MINIATURE AND MOLDED CASE CIRCUIT BREAKERS

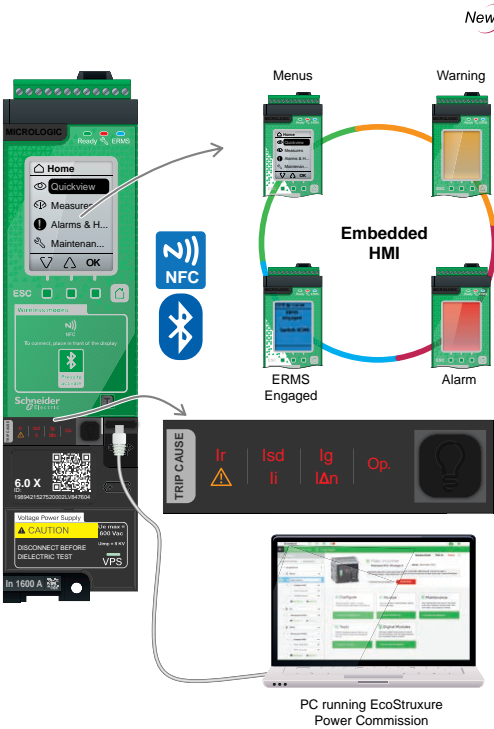

New!

### MicroLogic X Control Unit for MasterPact MTZ Circuit Breakers

The MicroLogic X control unit protection functions include overcurrent, short-circuit, and ground-fault protection. Along with the standard protection functions LI, LSI, and LSIg, new features enhance the overall performance of a system: dual settings, fine settings, fast tripping.

MicroLogic X measures electrical parameters of a power system: currents, voltages, frequency, power, energy, power factor, current and power demand. Min/Max and average values are calculated for most of the parameters.

MicroLogic X capability for maintenance & diagnostics simplifies circuit breaker service and operations. Relevant indicators and messages are powerful tools that can help the user scheduling both preventive and predictive maintenance, and device replacement.

### MasterPact MTZ Digital Modules Options for Advanced Functions

Optional Digital Modules can be purchased and downloaded to enhance the performance of MicroLogic X control units. They are dedicated to advanced protection, measurement, and maintenance & diagnostics, and are available through Go Digital on the Schneider Electric website.

Module (Available on the Schneider Electric GoDigital Website)		Part Number
<b>Protection</b>		
ANSI 27/59—Under/Over Voltage Protection	Monitors the circuit breaker voltages and trips when the voltage exceeds the settings.	LV850012
ANSI 32P—Reverse Active Power Protection	Monitors the active power.	LV850011
ANSI 51N/51G—Ground-Fault Alarm	Provides an integrated ground fault alarm.	LV850007
ERMS—Energy Reducing Maintenance Settings	Used to lower the protection settings in order for the MasterPact MTZ circuit breaker to trip faster, reducing arc energy.	LV850009
<b>Metering</b>		
Energy per Phase Digital Module	Calculates and displays the active, reactive and apparent energy per phase of the power system and provides total active, reactive and apparent energy per phase.	LV850002
Individual Harmonics Analysis	Provide harmonics of voltage and current to the 40th harmonic.	LV850006
<b>Maintenance &amp; Diagnostic</b>		
Power Restoration Assistant,	Displays available circuit breaker information to help determine potential causes of an event and also provides guidance for potential solutions to restore power.	LV850004
MasterPact Operation Assistant	Assists in closing or opening the circuit breaker remotely with Bluetooth by delivering applicable instructions. Requires Comm & Diag accessories.	LV850005
Waveform Capture on Trip Event	Automatically logs five cycles of phase and neutral currents.	LV850003
Modbus Legacy Dataset	Allows easy integration in existing Modbus installations where modification of supervision software for MTZ circuit breakers is not desired.	LV850045

New generation MicroLogic X control units incorporate wireless technology (Bluetooth and NFC) that allows the transfer of a wide selection of critical information (protection, measurements, maintenance & diagnostics) to your mobile device, by means of the EcoStruxure Power Device App.

Alternatively, MasterPact MTZ can be equipped with ETHERNET communication through either the IFE module or the new embedded EIFE that includes webpages. Modbus SL communication is available through the IFM interface module.



MicroLogic X Sensor Plugs

Table 7.136: Sensor Plug

In (A)	Sensor Plug :	MTZ1-08 MTZ2-08	MTZ2-16	MTZ2-16	MTZ2-32	MTZ2-40	MTZ3-32	MTZ3-40	MTZ3-50	MTZ3-60	MTZ3-63
400	LV847053SP	X	—	—	—	—	—	—	—	—	—
600	LV848823SP	X	—	—	—	—	—	—	—	—	—
630	LV833091SP	X	X	—	—	—	—	—	—	—	—
800	LV833092SP	X	X	—	—	—	—	—	—	—	—
1000	LV833093SP	—	X	X	—	—	—	—	—	—	—
1200	LV848824SP	—	X	X	—	—	—	—	—	—	—
1250	LV833094SP	—	X	X	—	—	—	—	—	—	—
1600	LV833095SP	—	X	X	X	—	—	—	—	—	—
2000	LV833982SP	—	—	X	X	X	X	X	X	X	X
2500	LV833983SP	—	—	—	X	X	X	X	X	X	X
3000	LV848825SP	—	—	—	X	X	X	X	X	X	X
3200	LV833984SP	—	—	—	X	X	X	X	X	X	X
3600	LV836390SP	—	—	—	—	X	X	X	X	X	X
4000	LV836391SP	—	—	—	—	X	X	X	X	X	X
2000	LV847821SP	—	—	—	—	—	X	X	—	—	—
2500	LV847822SP	—	—	—	—	—	X	X	X	—	—
3000	LV848826SP	—	—	—	—	—	X	X	X	X	—
3200	LV847823SP	—	—	—	—	—	X	X	X	X	X
3600	LV836391SP	—	—	—	—	—	—	X	X	X	X
4000	LV847824SP	—	—	—	—	—	—	X	X	X	X
5000	LV847825SP	—	—	—	—	—	—	—	X	X	X
6000	LV848827SP	—	—	—	—	—	—	—	—	X	X
6300	LV847826SP	—	—	—	—	—	—	—	—	—	X

Table 7.137: Replacement Parts for MicroLogic X Control Units

Replacement Part	Part Number
MicroLogic X Embedded Display & Wireless Card	LV850054SP
Internal Battery	LV833593SP
Transparent Cover with No Access Holes to MicroLogic X Control Unit	LV839454SP
Transparent Cover with Access Holes to MicroLogic X Control Unit	LV839453SP
USB Cable (miniUSB/USB) for MicroLogic X Control Unit	LV850067SP

*New!*

**MasterPact MTZ Accessories**

**Table 7.138: MasterPact MTZ Circuit Breaker Accessories**

Accessory	Circuit Breaker	Version	
		Fixed	Drawout
<b>Connection</b>			
Horizontal and vertical rear connection	MTZ1/2/3	X	X
Front connection	MTZ1/2/3	X	X
Vertical-connection adapters	MTZ1	X	X
Cable-lug adapters	MTZ1	X	X
Spreaders	MTZ1	X	X
Disconnectable front connection adapter	MTZ2/3	X	—
Lugs for 240 mm <sup>2</sup> or 300 mm <sup>2</sup> cables	MTZ1	X	X
Interphase barriers	MTZ1/2/3	X	X
Arc chute cover (CC)	MTZ1	X	—
Brackets for mounting	MTZ2/3	X	—
<b>Signalling</b>			
ON/OFF indication contacts (OF)	MTZ1/2/3	X	X
Fault-trip indication contact (SDE)	MTZ1/2/3	X	X
Combined connected/closed contacts (EF)	MTZ2/3	—	X
Cradle switches (CE, CD, CT)	MTZ1/2/3	—	X
Ready-to-close contact (PF)	MTZ1/2/3	X	X
ERMS switch module (ESM)	MTZ1/2/3	X	X
Mechanical operation counter (CDM)	MTZ1/2/3	X	X
<b>Controlling</b>			
Diagnostic and communicating shunt close (XF diag&com)	MTZ1/2/3	X	X
Shunt close (XF)	MTZ1/2/3	X	X
Diagnostic and communicating shunt trip (MX diag&com)	MTZ1/2/3	X	X
Shunt trip (MX)	MTZ1/2/3	X	X
Diagnostic undervoltage release (MN diag)	MTZ1/2/3	X	X
Undervoltage release (MN)	MTZ1/2/3	X	X
Non-adjustable delay unit (R)	MTZ1/2/3	X	X
Adjustable delay unit (Rr)	MTZ1/2/3	X	X
Isolation module	MTZ1/2/3	X	X
Spring charging motor (MCH)	MTZ1/2/3	X	X
Electrical reset option (RES)	MTZ1/2/3	X	X
Automatic reset option (RAR)	MTZ1/2/3	X	X
Electrical closing pushbutton (BPFE)	MTZ1/2/3	X	X
<b>Locking and Interlocking</b>			
ON/OFF pushbutton locking (VBP)	MTZ1/2/3	X	X
OFF position locking (VSPO-VCPO)	MTZ1/2/3	X	X
Cradle locking in disconnected position by padlock	MTZ1/2/3	—	X
Cradle locking in disconnected position: by keylock (VSPD)	MTZ1/2/3	—	X
Optional connected/disconnected/test position locking	MTZ1/2/3	—	X
Safety shutters (VO)	MTZ1/2/3	—	X
Shutter position indication and locking (VIVC)	MTZ2/3	—	X
Cable-type door interlock (IPA)	MTZ1/2/3	X	X
Door interlock (VPEC)	MTZ1/2/3	—	X
Racking interlock (VPOC)	MTZ1/2/3	—	X
Racking interlock between crank and OFF pushbutton (IBPO)	MTZ2/3	—	X
Cradle rejection kit	MTZ1/2/3	—	X
<b>Circuit Protection</b>			
External sensor for ground-fault protection (ENCT)	MTZ1/2/3	X	X
External sensor for source ground-return (SGR) protection	MTZ1/2/3	X	X
<b>Operation Protection</b>			
Automatic spring discharge before circuit breaker removal (DAE)	MTZ2/3	—	X
Grounding kit (KMT)	MTZ2/3	X	X
<b>Mechanical Protection</b>			
Terminal cover (CB)	MTZ1/2/3	—	X
Escutcheon (CDP)	MTZ1/2/3	X	X
Blanking plate for escutcheon (OP)	MTZ1/2/3	X	X
Transparent cover for escutcheon (CP)	MTZ1/2/3	—	X
<b>Power Supplies</b>			
Voltage power supply (VPS)	MTZ1/2/3	X	X
External 24 Vdc power supply module (AD)	MTZ1/2/3	X	X
Battery module (BAT)	MTZ1/2/3	X	X
Mobile Power Pack by APC	MTZ1/2/3	X	X
Spare internal battery	MTZ1/2/3	X	X



Microswitch Type ON/OFF Indication Contacts (OF) (MTZ1)



Rotary Type ON/OFF Indication Contacts (OF) (MTZ2 and MTZ3)



Additional Overcurrent Trip Indication Contacts (SDE)



Combined Connected/Closed Contacts



Connected / Disconnected / Test Position Cradle Switches (CE, CD and CT)



M2C programmable contacts: circuit breaker internal relay with two contacts

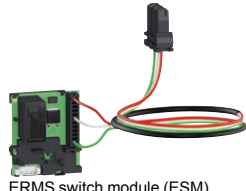

ERMS switch module (ESM)



Ready-to-close contacts (PF)



Pushbutton locking (VBP) with padlock



Grounding Kit (KMT)

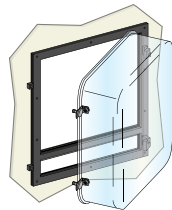

Transparent Cover for Escutcheon (CCP)

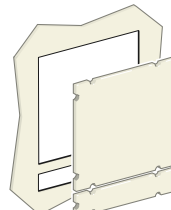

Cover for Escutcheon (CCP)

Communication Accessories

Table 7.139: Monitoring and Control



EIFE Embedded Ethernet Interface



IO Application Module



IFE Interface



IFE Switchboard Server

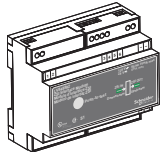

ZSI Interface Module

Description	Catalog Number	
Enerlin'X modules	EIFE Embedded Ethernet module full kit includes EIFE and EIFE cable; for MTZ1-drawout	LV851100SP
	EIFE Embedded Ethernet module full kit includes EIFE actuators and EIFE cable; for MTZ2/3-drawout	LV851200SP
	EIFE Embedded Ethernet stand-alone module; for MTZ1/2/3-drawout	LV851001SP
	Ethernet interface LV breaker	LV434001
	Ethernet interface for LV breakers and gateway	LV434002
	I/O application module	LV434063
	EIFE Cable; for MTZ1-drawout	LV851120SP
ULP port modules	EIFE Cable; for MTZ2/3-drawout	LV851220SP
	ULP port - for MasterPact MTZ1 - fixed	LV850063SP
	ULP port - for MasterPact MTZ1 - drawout	LV850064SP
	ULP port - for MasterPact MTZ2/3 - fixed	LV850061SP
	ULP port - for MasterPact MTZ2/3 - drawout	LV850062SP
Ethernet display module	Front display module FDM128	LV434128
ULP Wiring Accessories	5 RJ45 connectors female/female	TRV00870
	10 ULP line terminators	TRV00880
	10 RJ45/RJ45 male cord L = 0.3 m	TRV00803
	10 RJ45/RJ45 male cord L = 0.6 m	TRV00806
	5 RJ45/RJ45 male cord L = 1 m	TRV00810
	5 RJ45/RJ45 male cord L = 2 m	TRV00820
	5 RJ45/RJ45 male cord L = 3 m	TRV00830
ZSI Interface Module	1 RJ45/RJ45 male cord L = 5 m	TRV00850
	Connects up to 15 PowerPact H/J/L/P/R or MasterPact MTZ/NT/NW Circuit Breakers or for applications requiring compliance with IEC and CENELEC HD 60364-4-41 or those requiring double insulation.	LV848892SP

Shunt Close, Shunt Trip, and Undervoltage Release Catalog Numbers



Shunt Close, Shunt Trip, Undervoltage Trip

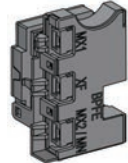

Isolation Module

Description	Catalog Number	
Shunt Close (XF) or Shunt Trip (MX) for all MasterPacT MTZ Devices		
Standard coil	24 Vac, 24–30 Vdc	LV833659SP
	48 Vac, 48–60 Vdc	LV833660SP
	100–130 Vac/dc	LV833661SP
	200–250 Vac/dc	LV833662SP
	277 Vac	LV833663SP
	380–480 Vac	LV833664SP
Diagnostics & Communicating coil [7]	24 Vac, 24–30 Vdc,	LV833033SP
	48 Vac, 48–60 Vdc	LV833034SP
	100–130 Vac/dc	LV833035SP
	200–250 Vac/dc	LV833036SP
	277 Vac	LV833037SP
	380–480 Vac	LV833038SP
Terminal block	Wiring kit for diag & com coil for MTZ1	LV833118SP
	Wiring kit for diag & com coil for MTZ2/3	LV847904SP
	For fixed circuit breaker MTZ1/2/3	LV847074SP
	For drawout circuit breaker MTZ1	LV833098SP
	For drawout circuit breaker MTZ2/3	LV847849SP
Undervoltage Release MN for all MTZ		
Undervoltage release	24–30 Vdc, 24 Vac	LV833668SP
	48–60 Vdc, 48 Vac	LV833668SP
	100–130 Vac/dc	LV833669SP
	200–250 Vac/dc	LV833670SP
	380–480 Vac	LV833671SP
Diagnostics coil [7]	24–30 Vdc, 24 Vac	LV833673SP
	48–60 Vdc, 48 Vac	LV836668SP
	100–130 Vac/dc	LV836670SP
	200–250 Vac/dc	LV836671SP
	380–480 Vac	LV836673SP
	Wiring kit for diag & com coil for MTZ1	LV833118SP
Terminal block	Wiring kit for diag & com coil for MTZ2/3	LV847904SP
	For fixed circuit breaker MTZ1/2/3	LV847074SP
	For drawout circuit breaker MTZ1	LV833098SP
	For drawout circuit breaker MTZ2/3	LV847849SP
Accessories for Diagnostics & Communicating Accessories		
Isolation module for MicroLogic X—for MX1/XF communicating accessories	LV850056SP	
Voltage release tab/bracket for MX/XF/MN	LV847093SP	

[7] Diagnostic and electrical accessories (MX, XF) are required for remote functioning of the MasterPacT Operation Assistant Digital Module.

**Auxiliary, Alarm Contacts and Power Supply Catalog Numbers**

**Table 7.140: Auxiliary and Alarm Contacts, Programmable Contact Module, Electrical Close Pushbutton**

Accessory	Catalog Number	
	MTZ1	MTZ2/MTZ3
1a/1b Form C Auxiliary Switch	LV847076SP	—
Low Level 1a/1b Form C Auxiliary Switch	LV847077SP	—
4a/4b Form C Auxiliary Switch (OF)	—	LV864922SP
1a/1b Form C Connected/Closed Switch (EF)	—	LV848477SP
Low Level 1a/1b Form C Connected/Closed Switch (EF)	—	LV848478SP
1a/1b Form C Second Trip Alarm Switch (SDE2)	LV847915SP	LV847915SP
Low Level 1a/1b Form C Second Trip Alarm Switch	LV847916SP	LV847916SP
1a/1b Form C Ready-to-Close Switch (PF)	LV847080SP	LV847080SP
Low Level 1a/1b Form C Ready-to-Close Switch	LV847081SP	LV847081SP
Electrical Close Pushbutton (BPFE)	LV864917SP	LV848534SP



Combined Contacts



Additional Overcurrent Trip Indication Contacts (SDE)



Microswitch Type ON/OFF Indication Contacts (OF) (MTZ1)



MasterPacT Electrical Closing Pushbutton (BPFE)

**Table 7.141: Cradle Position Switches (Cell Switches)**

Description	Catalog Number
1a/1b Form C Connected/Test/Disconnected Switch	LV833170SP
Low Level 1a/1b Form C Connected/Test/Disconnected Switch	LV833171SP
1a Connected/Test/Disconnected Switch MTZ2-3 (Ring Tongue)	LV839289SP
1b Connected/Test/Disconnected Switch MTZ2-3 (Ring Tongue)	LV839290SP
Set of 3 Cell Switch Actuating Arms	LV848560SP

**NOTE:** Auxiliary, alarm and status switches' terminal blocks need to be ordered separately, see Secondary Terminal Block Kits, below.

**Table 7.142: Secondary Terminal Block Kits**

	Fixed MTZ1/2/3	Drawout MTZ1	Drawout MTZ2/3
Push-in Terminal kit (3 Wires)	LV847074SP	LV833098SP	LV847849SP
Push-in Terminal kit (6 Wires)	LV847075SP	LV833099SP	LV847850SP
Ring Tongue Kit 1a MTZ2-3	—	—	LV839296SP
Ring Tongue Kit 1b MTZ2-3	—	—	LV839297SP
Ring Tongue Kit 1a & 1b MTZ2-3	—	—	LV839298SP

**Table 7.143: Accessories for MicroLogic X Control Units**

	Catalog Number	
External power supply module (AD)	24–30 Vdc	LV454440
	48–60 Vdc	LV454441
	100–125 Vdc	LV454442
	110–130 Vdc	LV454443
	200–240 Vdc	LV454444

**Interlocks Catalog Numbers**

Description	Catalog Number
<b>Door Interlock</b>	
Door interlock MTZ1	Right and left-hand side of cradle (VPECD or VPECG)
Door interlock MTZ2/3	Right and left-hand side of cradle (VPECD or VPECG)
Cable-type door interlock	1 complete assembly for MasterPacT MTZ2/MTZ3 fixed or drawout device
<b>Mechanical Interlocking for Source Changeover for MTZ2/3</b>	
Interlocking of 2 devices using connecting rods Choose 1 set of 2 adaptation fixtures (1 for each device) + 1 set of rods	Rod Interlock kit: 1 set of 2 adaptation fixtures for MasterPacT MTZ2 or MTZ3 fixed or drawout device
	1 set of 2 interlocking rods
Interlocking of 2 devices using cables [1] Choose 2 adaptation sets (1 for each device + 1 set of cables)	Can be used with 1 MTZ2/3 fixed + 1 MTZ2/3 drawout. Note: the installation manual is enclosed. Interlocking of 2 devices using cables [1]
	1 adaptation fixture for MasterPacT MTZ2/3 fixed devices
	Cable mounting plate: 1 adaptation fixture for MasterPacT MTZ2/3 drawout devices
Interlocking of 3 devices using cables Choose 3 adaptation (including 3 adaptation fixtures + cables)	Cable interlock: 1 set of 2 cables
	3 sources, only 1 device closed, fixed or drawout devices
	2 sources + 1 coupling, fixed or drawout devices
	2 normal + 1 replacement source, fixed or drawout devices

Neutral Sensors Catalog Numbers

Table 7.144: Neutral Sensor Parts

		Catalog Number
Neutral Sensor Wiring Harness for MTZ1/2		LV848907SP
Neutral Sensor Wiring Harness for MTZ3		LV848906SP
MDGF/SGR (Source Ground Return) Sensor plug	External sensor (SGR) <sup>[8]</sup>	LV833579SP
	MDGF summing module for MTZ2/3	LV848891SP



External Sensor for Neutral Ground-Fault Protection (TCE)

Table 7.145: MasterPact MTZ1 External Neutral Sensors

Used With	Sensor Plug	External Neutral Sensor For General Use
Circuit breakers with standard neutral protection	400–1600 A	LV833576SP
	400–1000 A	LV833576SP
Circuit breakers with oversized neutral protection <sup>[9]</sup>	1200–1250A	LV834035SP
	1600A	LV834036SP



External Sensor for Source Ground-Return Protection

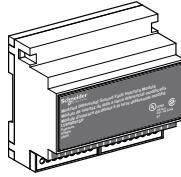

MDGF

Table 7.146: MasterPact MTZ2/MTZ3 External Neutral Sensors

Description	External Neutral Sensor				
	For Residual Ground Fault	For 3P Circuit Breaker with Oversized Neutral Protection <sup>[9]</sup>			
<b>MasterPact MTZ2 Circuit Breakers</b>					
Sensor Plug	400	LV834037SP	LV834037SP		
	600–630				
	800				
	1000				
	1200–1250	LV834035SP	LV834035SP		
	1600				
	2000	LV834036SP	LV834036SP		
	2500				
	3000				
	3200				
4000		—			
<b>MasterPact MTZ3 Circuit Breakers</b>					
Sensor Plug Kit includes qty. (2) neutral sensors	2000	LV848182SP	LV848182SP		
	2500				
	3000				
	3200				
	4000				
	5000				
	6000				
	6300				
					—

<sup>[8]</sup> Four MDGF sensors (phase + 1 neutral) are required for MTZ2; eight MDGF sensors are required for MTZ3. For SGR system only one sensor (neutral) is required for MTZ2; two sensors for MTZ3.

<sup>[9]</sup> Oversized neutral protection = 1.6 I<sub>r</sub> where I<sub>r</sub> = long time pick-up.

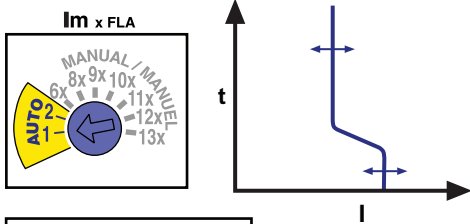
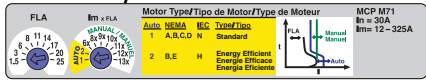
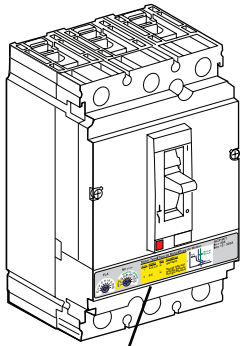

Motor Type / Tipo de Motor / Type de Moteur			
Auto	NEMA	IEC	Type/Typo
1	A, B, C, D	N	Standard
2	B, E	H	Energy Efficient Energie Efficace Energia Efficente

**Motor Circuit Protection Selection**

PowerPact H- and J-frame electronic Motor Circuit Protectors (MCP) are magnetic-only instantaneous-trip circuit breakers. They are designed to offer short circuit protection and are National Electrical Code (NEC) compliant when installed as part of a combination controller having motor overload protection. MCP circuit breakers accept the same accessories and terminals as the equivalent thermal-magnetic circuit breakers.

Determine the hp rating from the nameplate of the motor. Select a MCP with an ampere rating recommended for the hp and voltage involved. When using the automatic settings the MCP microprocessor automatically adjusts the trip settings for both current and time to align with the start-up characteristic for the motor type, whether it is a standard or energy-efficient motor. This includes a dampening means to accommodate a transient motor in-rush current without nuisance tripping of the circuit breaker.

**Table 7.147: H- and J-Frame Electronic Motor Circuit Protectors (MCP)**

Frame	Sensor Rating	Full Load Amperes Range	Adjustable Instantaneous Trip Range	Suffix	J (See SCCR Cat. No. Table Below)	L (See SCCR Cat. No. Table Below)	R (See SCCR Cat. No. Table Below)
H-Frame	30 A	1.5–25 A	9–325 A	M71	HJL36030-M71	HLL36030-M71	HRL36030M71
	50 A	14–42 A	84–546 A	M72	HJL36050-M72	HLL36050-M72	HRL36050M72
	100 A	30–80 A	180–1040 A	M73	HJL36100-M73	HLL36100-M73	HRL36100M73
	150 A	58–130 A	348–1690 A	M74	HJL36150-M74	HLL36150-M74	HRL36150M74
J-Frame	250 A	114–217 A	684–2500 A	M75	JJL36250-M75	JLL36250-M75	JRL36250M75

**Table 7.148: Maximum Rating or Setting of Motor Protective Devices [10]**

Type of Motor	Percentage of Full-load Current		
	Setting	Not to Exceed[11]	
A, B, C, D	Standard	800%	1300%
B, E	Energy Efficient	1100%	1700%

**Table 7.149: MCP Selection by HP Ratings [12] of Induction-type Squirrel-Cage and Wound-Rotor Motors [13]**

3Ø60 Hz Voltages [14]				Full-Load Amperes	Suffix
200 Vac	230 Vac	460 Vac	575 Vac		
.5–5	.5–7.5	.75–15	1–20	1.5–25	M71
5–10	5–15	10–30	15–40	14–42	M72
10–25	15–30	25–60	30–75	30–80	M73
20–40	25–50	50–100	60–125	58–130	M74
40–60	50–75	100–150	125–200	114–217	M75

**Short Circuit Current Rating (SCCR)**

Tested to meet NEC and UL508A requirements for short circuit current ratings as part of an approved combination controller.

**Table 7.150: Short Circuit Current Ratings (SCCR)**

Contactor/Starter	Interrupting Rating					
	J			L		
	200–240 Vac	480 Vac	600 Vac	200–240 Vac	480 Vac	600 Vac
Tesys D-line and F-line	100 kA	65 kA	25 kA	125 kA	100 kA	50 kA
NEMA Type S	100 kA	65 kA	25 kA	125 kA	100 kA	50 kA

See [www.us.schneider-electric.us](http://www.us.schneider-electric.us) for specific ratings and combination ID numbers.

To select combination starters and motor controllers using MCP's Meeting NEC Article 430, refer to Section 16.

- Accessories see page 7-51
- Lugs see page 7-56
- Dimensions see page 7-87
- Enclosures see page 7-88

[10] Based on 2015 NEC Table 430.52.  
 [11] See NEC Exception No. 1 to Table 430.52. The NEC 1300% maximum setting may be inadequate for instantaneous trip circuit breakers to withstand current surges typical of the magnetization current of autotransformer type reduced voltage starters, or open transition wye-delta starters during transfer from "start" to "run," constant hp multi-speed motors, and motors labeled "high efficiency."  
 [12] Based on 2005 NEC Table 430.250.  
 [13] Per NEC 430.3, part-winding motors should select two circuit breakers, each at not more than one-half the allowable trip setting for the horsepower rating. The two circuit breakers should operate simultaneously as a disconnecting means per NEC 430.103.  
 [14] Listed voltages are rated motor voltages. Corresponding system voltages are 200 Vac, 220–240 Vac, 440–480 Vac and 550–600 Vac. Select wire and circuit breakers based on horsepower rather than nameplate full-load current per NEC 430.6 (A) for general motor applications.

H-, J-Frame Motor Circuit Protectors

Table 7.151: Application of PowerPact™ H-Frame and J-Frame Electronic Motor Circuit Protectors (MCP)

Horsepower Rating of Induction-Type Squirrel-Cage and Wound-Rotor Motors 3Ø 60 Hz					NEC Full Load Amperes	PowerPact H-Frame and J-Frame Electronic MCP	
Starter Size	200 Vac	230 Vac	480 Vac	575 Vac			
00			1/2	1/2	0.9 A	HJL36030M71 and HLL36030M71 1/2–10 hp	
					1.1 A		
					1.3 A		
					1.7 A		
					2.1 A		
			1/2		2.2 A		
					2.4 A		
		1/2			2.5 A		
					2.7 A		
				1-1/2	3 A		
			3/4		3.2 A		
					3.4 A		
		3/4			3.7 A		
					3.9 A		
	0						
					4.8 A		
					4.8 A		
			1		6 A		
					6.1 A		
					6.8 A		
					6.9 A		
					7.6 A		
					7.8 A		
					9 A		
1					9.6 A	HJL36100M73 and HLL36100M73 15–50 hp	
					11 A		
					14 A		
					15.2 A		
					17 A		
2					17.5 A	HJL36150M74 and HLL36150M74 30–100 hp	
					21 A		
					22 A		
					25.3 A		
					27 A		
					28 A		
					32 A		
					32.2 A		
					34 A		
					40 A		
3					41 A	JLL36250M75 and JLL36250M75 50–150 hp	
					42 A		
					48.3 A		
					52 A		
					54 A		
					62 A		
					65 A		
					68 A		
					77 A		
					78.2 A		
4					80 A	JLL36250M75 and JLL36250M75 50–150 hp	
					92 A		
					96 A		
					99 A		
					104 A		
5					104 A	JLL36250M75 and JLL36250M75 50–150 hp	
					120 A		
					124 A		
					125 A		
					130 A		
					144 A		
					150 A		
					154 A		
					156 A		
					177.1 A		
				180 A			
				192 A			
				221 A			
				240 A			
				248 A			

\*Shaded area is not covered by J-frame electronic motor circuit protector.

**Vigirex™ Ground-Fault Relay System**

The Vigirex ground-fault relays, with associated sensors (current transformers), measure the residual current in an electrical installation to detect levels which may be damaging. When used for protection, they cause an associated circuit breaker or switch to interrupt the supply of power to the protected system. They may also be used for monitoring only, with output to an alarm. The product line includes fixed sensitivities from 30 mA to 1 A and adjustable sensitivities up to 30 A.

The Vigirex relays may be easily mounted on DIN rail or may be panel mounted in a meter cutout. Sensors for conductors range from a little more than an inch diameter toroids, to large rectangular sensors measuring 6 x 18 inches. The compact size of the relay and its sensor make it ideal for protection of OEM equipment as well as branch circuits.

**Table 7.152: Vigirex Ground-Fault Relays (UL 1053 Listed)**

Model	Delay	Reset	Control Voltage	Sensitivity	Cat. No.	
<b>DIN Rail Mounted</b>						
RH10M	Instantaneous	Manual	12–24 Vac/12–48 Vdc	30 mA	56300	
				100 mA	56302	
				300 mA	56305	
			110–130 Vac	500 mA	56306	
				1 A	56307	
				30 mA	56320	
	220–240 Vac	100 mA	56322			
		300 mA	56325			
		500 mA	56326			
		1 A	56327			
		30 mA	56330			
		100 mA	56332			
RH21M	Instantaneous or 60 msec (2 settings)	Manual	12–24 Vac/12–48 Vdc	30 mA [15] or 300 mA (2 settings)	56360	
			110–130 Vac		56362	
			220–240 Vac		56363	
	Adjustable (9 settings): 0, 0.06, 0.15, 0.23, 0.31, 0.5, 0.8, 1.0, 4.5 sec	Manual	12–24 Vac/12–48 Vdc	Adjustable, (9 settings): 0.03 [15], 0.1, 0.3, 0.5, 1, 3, 5, 10, 30 A	56370TD	
			110–130 Vac		56372TD	
			220–240 Vac		56373TD	
		Automatic	12–24 Vac/12–48 Vdc		56390TD	
			110–130 Vac		56392TD	
			220–240 Vac		56393TD	
	<b>Panel Mounted</b>					
	RH10P	Instantaneous	Manual	12–24 Vac/12–48 Vdc	30 mA	56400
					100 mA	56402
300 mA					56405	
110–130 Vac				500 mA	56406	
				1 Amp	56407	
				30 mA	56420	
220–240 Vac		100 mA	56422			
		300 mA	56425			
		500 mA	56426			
		1 Amp	56427			
		30 mA	56430			
		100 mA	56432			
RH21P	Instantaneous or 60 msec (2 settings)	Manual	12–24 Vac/12–48 Vdc	30 mA [15] or 300 mA (2 settings)	56460	
			110–130 Vac		56462	
			220–240 Vac		56463	
	Adjustable (9 settings): 0, 0.06, 0.15, 0.23, 0.31, 0.5, 0.8, 1.0, 4.5 sec	Manual	12–24 Vac/12–48 Vdc	Adjustable (9 settings): 0.03 [15], 0.1, 0.3, 0.5, 1, 3, 5, 10, 30 A	56470TD	
			110–130 Vac		56472TD	
			220–240 Vac		56473TD	
		Automatic	12–24 Vac/12–48 Vdc		56490TD	
			110–130 Vac		56492TD	
			220–240 Vac		56493TD	



RH99M



RH99P



PA50



SA200

**Table 7.153: Sensors for Vigirex Ground-Fault Relays**

Sensors	Type	Maximum Current [16]	Inside Diameter		Cat. No.
			in.	mm	
Closed Toroids, Type A	TA30	65 A	1.18	30	50437
	PA50	85 A	1.97	50	50438
	IA80	160 A	3.15	80	50439
	MA120	250 A	4.72	120	50440
	SA200	400 A	7.87	200	50441
	GA300	630 A	11.81	300	50442
Vigirex Sensor Iron Rings (Optional)	TA30	65 A	0.79	20	56055
	PA50	85 A	1.58	40	56056
	IA80	160 A	2.76	70	56057
	MA120	250 A	4.33	110	56058
Split toroids, Type TOA	TOA80	160 A	3.15	80	50420
	TOA120	250 A	4.73	120	50421
Rectangular Sensors	280 x 115	1600 A	11.02 x 4.53	280 x 115	56053
	470 x 160	3200 A	18.50 x 6.30	470 x 160	56054

[15] 30 mA is instantaneous only, except for RH99M and RH99P models. Their suffix TD indicates time delay at 30 mA. For models with no time delay (IEC compliant) consult catalog 0972CT0401.

[16] Use as a guideline for sizing wire through sensor.



**Cradle Metering CT Kit Catalog Numbers**

For use with UL and ANSI rated circuit breakers only.  
Not available with ArcBlok Technology.

**Table 7.154: Cradle Metering CT Kit (Set of 3)**

Description	Catalog Number	
MTZ2	400 A	SMCT400
	600 A	SMCT600
	800 A	SMCT800
	1200 A	SMCT1200
	1600 A	SMCT1600
	2000 A	SMCT2000
	2000 A	SMCT2000R <sup>[17]</sup>
	2500 A	SMCT2500R
	3000 A	SMCT3000R
	3200 A	SMCT3200R
	MTZ3	2000 A
2500 A		SMCT2500Y
3000 A		SMCT3000Y
3200 A		SMCT3200Y
4000 A		SMCT4000Y
5000 A		SMCT5000Y
6000 A		SMCT6000Y

**Spring Charging Motor and Remote Accessories Catalog Numbers**

**Table 7.155: Remote Operation**

		Catalog Number	
<b>Spring Charging Motor for MTZ1</b>			
Spring Charging Motor (MCH)	AC 50/60 Hz	48 V	LV833186SP
		100–130 V	LV833176SP
		200–240 V	LV833177SP
		277 V	LV833179SP
		380–415 V	LV833179SP
		440–480 V	LV833179SP
	DC	24–30 V	LV833185SP
		48–60 V	LV833186SP
		100–125 V	LV833187SP
		200–250 V	LV833188SP
	Terminal block	For fixed circuit breaker	LV847074SP
	For drawout circuit breaker	LV833098SP	
<b>Spring Charging Motor for MTZ2/3</b>			
Spring Charging Motor (MCH)	AC 50/60 Hz	48 V	LV847889SP
		100–130 V	LV847893SP
		200–240 V	LV847894SP
		277 V	LV847895SP
		380–415 V	LV847895SP
		440–480 V	LV847897SP
	DC	24–30 V	LV847888SP
		48–60 V	LV847889SP
		100–125 V	LV847890SP
		200–250 V	LV847891SP
	Terminal block	For fixed circuit breaker	LV847074SP
	For drawout circuit breaker	LV847849SP	
Remote reset after fault trip	Electrical reset RES	110–130 V AC	LV848202SP
		220–240 V AC	LV848203SP
	Terminal block	For fixed circuit breaker MTZ1/2/3	LV847074SP
		For drawout circuit breaker MTZ1	LV833098SP
	For drawout circuit breaker MTZ2/3	LV847849SP	
<b>MasterPact MTZ Circuit Breaker Remote Racking</b>			
Description	MasterPact MTZ1/2/3 Remote Racking Device		LV839291SP
	MasterPact MTZ2/3 Remote Racking Device		LV839292SP
	MasterPact MTZ1 Remote Racking Device		LV839293SP
	Mounting Bracket Kit for MTZ2/3 Remote Racking (contains 10 mounting brackets)		LV839294SP
	Mounting Bracket Kit for MTZ1 Remote Racking (contains 10 mounting brackets)		LV839295SP
	Control Unit for MTZ1/2/3 Remote Racking <sup>[18]</sup>		S47101
	30 ft. Control Cable for MTZ1/2/3 Remote Racking <sup>[18]</sup>		S47102
	Drive Shaft for MTZ2/3 Remote Racking <sup>[18]</sup>		S47103
	Drive Shaft for MTZ1 Remote Racking <sup>[18]</sup>		S47105

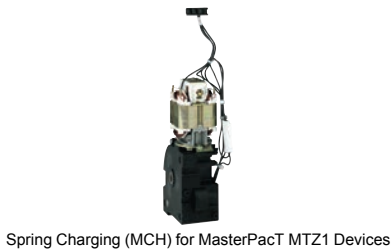

Spring Charging (MCH) for MasterPact MTZ1 Devices



Spring Charging Motor (MCH) for MasterPact MTZ2 and MTZ3 Devices



Remote Racking Device

<sup>[17]</sup> For MTZ2 20L1/L circuit breaker only  
<sup>[18]</sup> For replacement only

**UL/ANSI Connectors Catalog Numbers**

**NOTE:** For a 4-pole connector kit, add the suffix (4) to the kit number (e.g. SFCF124)

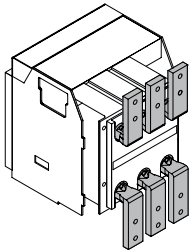

MTZ1 Drawout Front-Connected Flat (FCF)  
800 to 1200 A

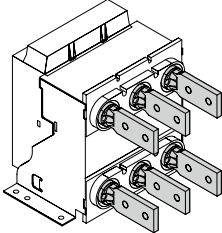

MTZ1 Fixed Rear-Connected "T" Vertical (RCTV)  
800 to 1200 A

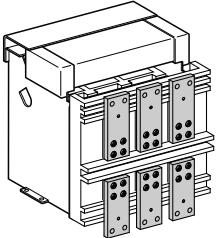

MTZ2 Front-Connected Flat (FCF)

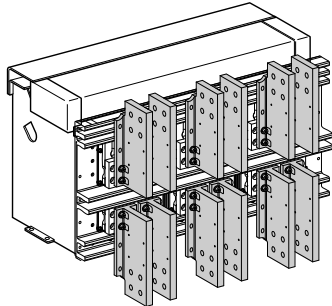

MTZ3 Front-Connected "T" (FCT)

Device	Connector	Frame		Catalog Number
MasterPacT MTZ1	Front Connected Flat (FCF)	800–1200A	Top	SFCF12
			Bottom	SFCF12
MasterPacT MTZ1	Rear Connected T Horizontal/Vertical (RCTH/RCTV)	800–1200A	Top	SRCTV12
			Bottom	SRCTV12
MasterPacT MTZ2/3	Front Connected Flat (FCF)	800–2000A, Drawout circuit breaker only	Top	SFCF20T
			Bottom	SFCF20B
		800–2000A, Fixed circuit breaker only	Top	SFCF20FT
			Bottom	SFCF20FB
		3200 A (L1/L1F only) 4000 A	Top	SFCF40
			Bottom	SFCF40
	Front Connected T (FCT)	800–2000 A Drawout circuit breaker only	Top	SFCT30
			Bottom	SFCT30
		800–2000 A Fixed circuit breaker only	Top	SFCT30
			Bottom	SFCT30B
		3200 A (for L1/L1F only), 4000 A, 5000 A	Top	SFCT50
			Bottom	SFCT50
	Rear Connected Offset Vertical (RCOV)	2000 A (for L1/L1F only) 3200 A	Top	SRCOV32T
			Bottom	SRCOV32B
		4000 A (For MTZ2 4000 A only)	Top	SRCOV40
			Bottom	SRCOV40
		4000 A Fixed MTZ2 only)	Top	SRCOV40BFX
			Bottom	SRCOV40BFX
	Rear Connected T Horizontal/Vertical (RCTH/RCTV)	800-2000 A	Top	SRCTV20
			Bottom	SRCTV20
3200 A ( for L1/L1F only), 4000 A, 5000 A		Top	SRCTV50	
		Bottom	SRCTV50	
6000 A		Top	SRCTV60	
		Bottom	SRCTV60	

Miscellaneous Accessory Catalog Numbers

Table 7.156: Escutcheon

Description	Catalog Number		
	Fixed	Drawout	
Escutcheon			
MasterPact MTZ1	Escutcheon	LV833718SP	LV833857SP
	Transparent cover (IP54)	—	LV833859SP
MasterPact MTZ2/3	Escutcheon	LV848601SP	LV848603SP
	Transparent cover (IP 54)	—	LV848604SP
Grounding Kit KTM			
MasterPact MTZ2/3	Side plate kit	LV848556SP	LV848557SP

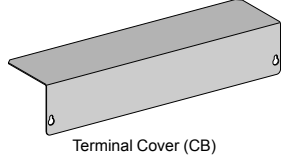
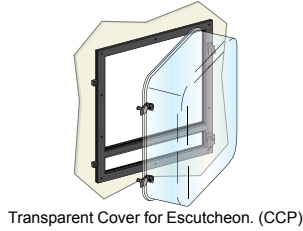

Mechanical Operation Counter (CDM)



Door Interlock Catch (VPEC)

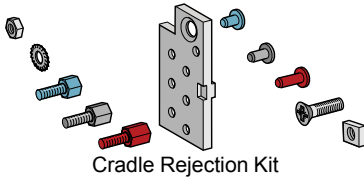
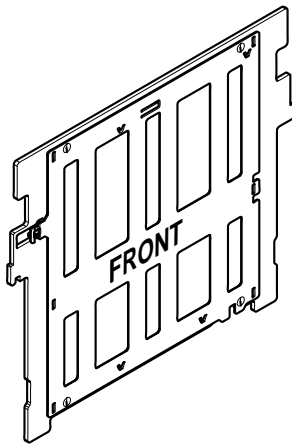

Table 7.157: Mechanical Operation Counter / Door Interlock / Cradle Rejection Kit

	Catalog Number	
	MTZ1	MTZ2/MTZ3
Operation counter CDM	LV833895SP	LV848535SP
Racking handle / 1 part	LV847098SP	LV847944SP
Spring charging handle	LV847092SP	LV847940SP
Door Interlock—Right and left-hand side of cradle (VPECD or VPECG)	LV833172SP	LV847914SP
Cradle rejection kit (VDC)	S33767	NWCELLKEY

Table 7.158: Assorted Accessories

		Catalog Number
ANSI C37/UL 1066/UL 489 Safety Shutters 1 part for MTZ		
MTZ1	3P	S48933
	4P	S48934
MTZ2 800/4000 A	3P	65346
	4P	65347
MTZ3 4000/6000 A	3P	65348
	4P	65349
Cluster Shield for Drawout Circuit Breakers		
ANSI Circuit Breakers		UL Circuit Breakers
MTZ 08N1 / H1 / H2 / H3	MTZ 08N / H	65356
MTZ 08L1 / L1F	MTZ 08L / LF, MTZ 12L / LF	65357
MTZ 16N1 / H1 / H2 / H3	MTZ 16N / H	65356
MTZ L1F	MTZ 16L / LF	65357
MTZ 20H1 / H2 / H3	MTZ 20N / H	65356
MTZ 20L1 / L1F	MTZ 20LF	65357
—	MTZ 20L, MTZ 25H / L	65356
MTZ 32H1 / H2 / H3	MTZ 30H / L MTZ 40BH	65356
MTZ 32L1	—	65356
MTZ 40H2 / H3	MTZ 40H	65356
MTZ 40L1	MTZ 40H / L	65356
MTZ 50H2 / H3	MTZ 50H	65356
MTZ 50L1	MTZ 50L	65356
MTZ 60H2 / H3	MTZ 60H	65356
MTZ 60L1	MTZ 60L	65356
Defeat Tool		
Cradle Interlock Defeat tool		64274
Cluster Tools		
Finger Cluster		S33166
Cluster Grease		S48899
Cluster Positioning Tool		S47542
Cluster Reset Tool		CLUSRETOOL
Cluster Service Kit		CLUSTOOLSK
Lifting Device Kits		
Crossbar for MTZ2 / NW-W frame Circuit Breaker or Cradle		S48900
Crossbar for MTZ3 / NW-Y-Frame Circuit Breaker or Cradle		S48901
Set of Two Lifting Hooks		S48906



Shutter

MasterPact NT and NW Circuit Breakers

The MasterPact NT and NW universal power circuit breakers offer a family of circuit protection products meeting the most common world standards, ANSI, UL and IEC. The basic design platform for each is common. The final result is UL, ANSI and IEC circuit breakers with the same basic external dimensions, features and accessories.

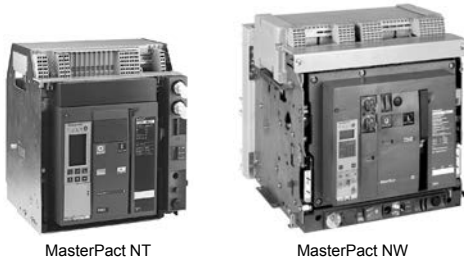

- Complete product offering up to 200 k AIR without fuses
- Circuit breakers tested to show arc flash hazard risk category as referenced by NFPA70E
- 800 A to 6000 A frames, fixed and draw-out
- Rated for AC voltage systems through 600 V (635 V ANSI)
- Short-time withstand ratings up to 100 kA
- Cradle position indicator: connected, test and disconnected
- Simple, visual contact wear indicators
- Full complement of field-installable accessories common to all standards
- Four interchangeable MicroLogic trip units to choose from
- Available PowerLogic™ based power metering and monitoring capabilities
- Available protective relay functions as defined by ANSI C37.2 and C37.90

The following charts show the MasterPact NW and NT ratings for ANSI and UL 489. See Pricing Guide 0613PL0001 and Catalog 0613CT0001.

Table 7.159: MasterPact NW Circuit Breaker Ratings

Standard Frame Rating Interrupting Code	ANSI C37 Certified/UL 1066 Listed																		UL 489 Listed														
	800–1600 A						2000 A						3200/4000 A [19]						4000/5000 A				800/1200/1600/2000 A				2500/3000 A		4000/5000/6000 A				
	N1	H1	H2	H3	L1 [20]	L1F [20]	H1	H2	H3	L1 [20]	L1F [20]	H1	H2	H3	L1 [20]	H2	H3	L1 [20]	N	H	L [20]	LF [20]	H	L [20]	H	L [20]							
Interrupting Current (kA RMS) 50/60 Hz	240 Vac	42	65	85	100	200	200	65	85	100	200	200	65	85	100	200	85	100	200	65	100	200	200	100	200	100	200						
	480 Vac	42	65	85	100	200	200	65	85	100	200	200	65	85	100	200	85	100	200	65	100	150	150	100	150	100	150						
	600 Vac	42	65	85	85	130	130	65	85	85	130	130	65	85	85	130	85	85	130	50	85	100	100	85	100	85	100						
Short-time Withstand Current (kA RMS)	42	65	85	85	30	22	65	85	85	30	22	65	85	85	100	85	85	100	42 [21]	65 [21]	30 [21]	22	65	65	85	100							
Built-in Instantaneous Override (kA RMS ±10%)	35 [23]	35 [23]	35 [23]	85	35 [23]	24	—	—	85	35	24	—	—	85	117	—	—	117	40	40	35 [21]	24	65	65	75	75							
Close and latch rating (kA RMS)	42	65	40	40	25	22	65	40	40	25	22	65	40	40	40	85	75	40	40	40	25 [24]	22	40	40	40	40							
Tested to show arc flash hazard risk category as referenced by NFPA70E	—	—	—	—	—	Yes	—	—	—	—	Yes	—	—	—	—	—	—	—	—	—	—	Yes	—	—	—	—							
Breaking time	25–30 ms with no intentional delay (9 ms for L1, L1F, L and LF)																																
Closing time	70 ms																																
Sensor Rating	100–250 A 400–800 A 800–1600 A						1000–2000 A						1600–3200 A						2000–4000 A 2500–5000 A						100–250 A 400–800 A 600–1200 A 800–1600 A 1000–2000 A				1200–2500 A 1600–3000 A		2000–4000 A 2500–5000 A 3000–6000 A		
Endurance Rating (C/O Cycles) With No Maintenance	Mechanical	12,500						10,000						10,000						5k		5,000				12,500 [25]				10,000		5,000	
	Electrical	2800						1,000						1,000						1k		1,000				2800 [25]				1,000		1,000	

[19] 4000 A standard width circuit breaker is not available in L1 interrupting rating code or drawout construction (fixed mounting only).  
 [20] Drawout mounted only.  
 [21] 24 kA RMS for 800 A circuit breaker frame with 100 A or 250 A sensor.  
 [22] 65 kA RMS for 2000 A.  
 [23] None except 24 kA RMS for 800 A circuit breaker frame with 100 A or 250 A sensor.  
 [24] 40 kA RMS for 2000 A.  
 [25] The endurance rating for 2000 A, N/H/L/LF is 10,000 for mechanical and 1000 for electrical.

**Table 7.160: MasterPact NT Circuit Breaker Ratings**

Standard Frame Rating Interrupting Code		ANSI C37 Certified/ UL 1066 Listed	UL 489 Listed													
			800 A					1200 A					1600 A [26]			
		N1	N	H	L1	L	LF [27]	N	H	L1	L	LF [27]	N	H	L1	L
Interrupting Current (kA RMS) 50/60 Hz	240 Vac	42	50	65	100	200	200	50	65	100	200	200	50	65	100	200
	480 Vac	42	50	50	65	100	100	50	50	65	100	100	50	50	65	100
	600 Vac	—	35	50	—	—	—	35	50	—	—	—	35	50	N/A	N/A
Short-time Withstand Current (kA RMS)		42	35	35	10	10	10	35	35	10	10	10	35	35	10	10
Built-in Instantaneous Override (kA RMS ±10%)		—	40	40	10	10	10	40	40	10	10	10	40	40	10	10
Close and latch rating (kA RMS)		40	25	25	10	10	10	25	25	10	10	10	25	25	10	10
Tested to show the arc flash hazard risk category as referenced by NFPA70E		—	—	—	—	—	Yes	—	—	—	—	Yes	—	—	—	—
Breaking time		25–30 ms with no intentional delay	25–30 ms with no intentional delay (9 ms for L and LF)													
Closing time		< 50 ms														
Sensor Rating		100–250 A	100–250 A					600–1200 A					800–1600 A			
		400–800 A	400–800 A					—					—			
Endurance Rating (C/O Cycles) With No Maintenance	Mechanical	12,500	12,500					12,500					12,500			
	Electrical	2800	2800					2800					2800			



NWMPRR

**Table 7.161: MasterPact NW/NT Circuit Breaker Remote Racking**

Description	Cat. No.
MasterPact NW/NT Remote Racking Devices [28]	NWNTMPRRT
MasterPact NW Remote Racking Device [28]	NWMPRRT
MasterPact NT Remote Racking Device [28]	NTMPRRT
Mounting Bracket Kit for NW Remote Racking (contains 10 mounting brackets) [29]	S47100
Mounting Bracket Kit for NT Remote Racking (contains 10 mounting brackets) [29]	S47104
Control Unit for NW Remote Racking [29]	S47101
30 ft Control Cable for NW Remote Racking [29]	S47102
Drive Shaft for NW Remote Racking [29]	S47103
Drive Shaft for NT Remote Racking [29]	S47105

[26] Fixed mounted only.  
 [27] Drawout mounted only.  
 [28] Unit comes with 10 mounting brackets included.  
 [29] For replacement only.

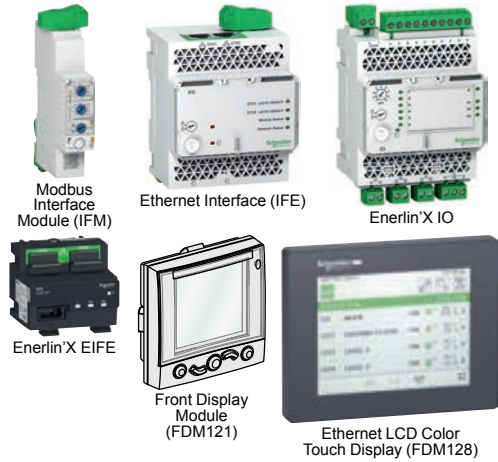

**Enerlin'X System for MicroLogic Trip Units**

Enerlin'X Systems enable network connectivity for MasterPact and PowerPact circuit breakers to provide remote monitoring, control & alarming features which is central to the Smart Systems Architecture with Square D low voltage distribution equipment.

Enerlin'X interface modules support Smart System Applications by facilitating access to circuit breaker data that provides performance information, circuit breaker status, metering measurements and various maintenance alert indicators such as contact wear, operation counters, load profile etc.

**Table 7.162: Communications and IO Interface Modules and Front Display Screens for MasterPact MTZ/NT/NW and PowerPact H/J/L/P/R Circuit Breakers**

Description	Part Number
IFM Modbus-SL Interface for LV Circuit Breaker	LV434000
IFE Interface (Ethernet Module)	LV434001
IFE Interface + Gateway (Ethernet and ModbuGateway)	LV434002
EIFE embedded Ethernet interface for drawout MasterPact MTZ	LV851001SP
EIFE Spare part kit for one MasterPact MTZ1 drawout circuit breaker	LV851100SP
EIFE Spare part kit for one MasterPact MTZ2/MTZ3 drawout circuit breaker	LV851200SP
IO Module (Input/Output Programmable Module)	LV434063
FDM121 (1 Circuit Breaker to 1 Front Display over ULP) <sup>[1]</sup>	STRV00121
FDM128 (8 Circuit Breakers to 1 Front Display over Ethernet)	LV434128

[1] The FDM121 is not compatible with MasterPact MTZ circuit breakers.

### Enerlin'X System Accessories

#### Accessories for Enerlin'X Modules

**Table 7.163: Accessories for Interfacing Enerlin'X Modules with MasterPact MTZ/NT/NW and PowerPact H/J/L/P/R Circuit Breakers**

Description		Part Number
Circuit Breaker ULP Cord—BCM to Enerlin'X Interface Module	L = 0.35 m (1.15 ft.)	LV434195
	L = 1.3 m (4.27 ft.)	LV434196
	L = 3 m (9.24 ft.)	LV434197
	L = 5 m (16.40 ft.)	LV434198
NSX Cord for V ≤ 480 V for PowerPact H/J/L	L = 1.3 m (4.27 ft.)	S434201
	L = 3 m (9.24 ft.)	S434202
NSX Cord for V > 480 V for PowerPact H/J/L	L = 1.3 m (4.27 ft.)	S434204
	L = 3 m (9.24 ft.)	S434203
	L = 4.5 m (14.7 ft.)	S434205
	L = 1.3 m (4.27 ft.)	S434201BS
BSCM (Breaker Status and Control Module) with NSX Cord For PowerPact H/J/L	L = 3 m (9.24 ft.)	S434202BS
	L = 3 m (9.24 ft.)	S434205
Replacement BSCM for PowerPact H/J/L	L = 1.3 m (4.27 ft.)	S434204BS
BSCM with NSX Cord for V > 480 Vac for PowerPact H/J/L	L = 3 m (9.24 ft.)	S434203BS
	L = 0.3 m (0.98 ft.)	TRV00803
ULP Cable, 10 Cables (Male to Male RJ45)	L = 0.6 m (1.97 ft.)	TRV00806
	L = 1 m (3.28 ft.)	TRV00810
ULP Cable, 5 Cables (Male to Male RJ45)	L = 2 m (6.56 ft.)	TRV00820
	L = 3 m (9.84 ft.)	TRV00830
	L = 5 m (16.40 ft.)	TRV00850
ULP Cable, 1 Cable (Male to Male RJ45)		TRV00870
RJ45 Female/Female Connector, 10 Connectors		TRV00880
ULP Line Terminator, 10 Terminators		TRV00880
Insulated ULP Module and Circuit Breaker Cord (for system voltage > 480 Vac) (Cord with female socket)	L = 1 m (3.28 ft.)	S434204
	L = 3 m (9.84 ft.)	S434203
Stacking Accessory (10 stacking accessories for IFM)		TRV00217
Adaptor Cable (for IFM V2 Modbus daisy chaining)		LV434211
Modbus Line Terminator for Screw Terminal, 2 Terminators		VW3A8306DRC
Modbus Line Terminator for RJ45 Terminal, 2 Terminators		VW3A8306RC
Surface-Mounting Accessory for FDM121		TRV00128
ULP Port Modules for:		
MasterPact MTZ1 Fixed Circuit Breaker		LV850063SP
MasterPact MTZ2/MTZ3 Fixed Circuit Breaker		LV850061SP
MasterPact MTZ1 Drawout Circuit Breaker		LV850064SP
MasterPact MTZ2/MTZ3 Drawout Circuit Breaker		LV850062
EIFE Cable for Drawout MasterPact MTZ1 Circuit Breaker		LV851120SP
EIFE Cable for Drawout MasterPact MTZ2/MTZ3 Circuit Breaker		LV851220SP

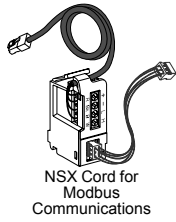

NSX Cord for Modbus Communications

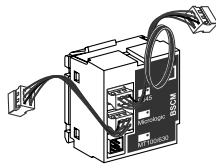

Breaker Status and Control Module (BSCM)

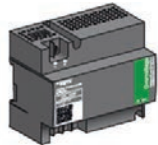

AD External Power Supply Module 24 Vdc



ABL8RPS24030



ABL8RPS24100

#### Recommended 24 Vdc Power Supplies

Available 24 Vdc power supplies include the range of Phaseo ABL8 modules and the AD modules:

- Schneider Electric Phaseo ABL8 power supplies (3 to 10 A, overvoltage category II) are recommended for large installations.
- Schneider Electric AD power supplies (1 A, overvoltage category IV) are recommended in the following cases:
  - For installations limited to a few IMUs.
  - As a power supply of MicroLogic trip units in MasterPact NT/NW or PowerPact P- and R-frame circuit breakers.

**Table 7.164: Power Supply Modules for MicroLogic Trip Units and Enerlin'X Modules**

Power Supply	Rating	Input-Output Voltage	Catalog No.
Schneider Electric AD Power Supply Primary overvoltage category IV Temperature: -25°C tp +70°C (-13°F to +158°F)	1A	24/30 Vac, 24 Vdc	LV454440
		48/60 Vac, 24 Vdc	LV454441
		100/125 Vac, 24 Vdc	LV454442
		110/130 Vac, 24 Vdc	LV454443
		200/240 Vac, 24 Vdc	LV454444
Schneider Electric Phaseo ABL8 Power Supply Primary overvoltage category II Temperature: 0°C tp +60°C (32°F to +140°F) (derated to 80% of the current above 50°C [122°F])	3 A	100/500 Vac, 24 Vdc	ABL8RPS24030
	5 A	100/500 Vac, 24 Vdc	ABL8RPS24050
	10 A	100/500 Vac, 24 Vdc	ABL8RPS24100

**Hybrid Communication—Ethernet and Modbus**

**NOTE:** Refer the Smart System Data Acquisition user guide (<https://www.schneider-electric.us/en/download/document/0614DB1801/>) to aid in component selection for Smart Systems.

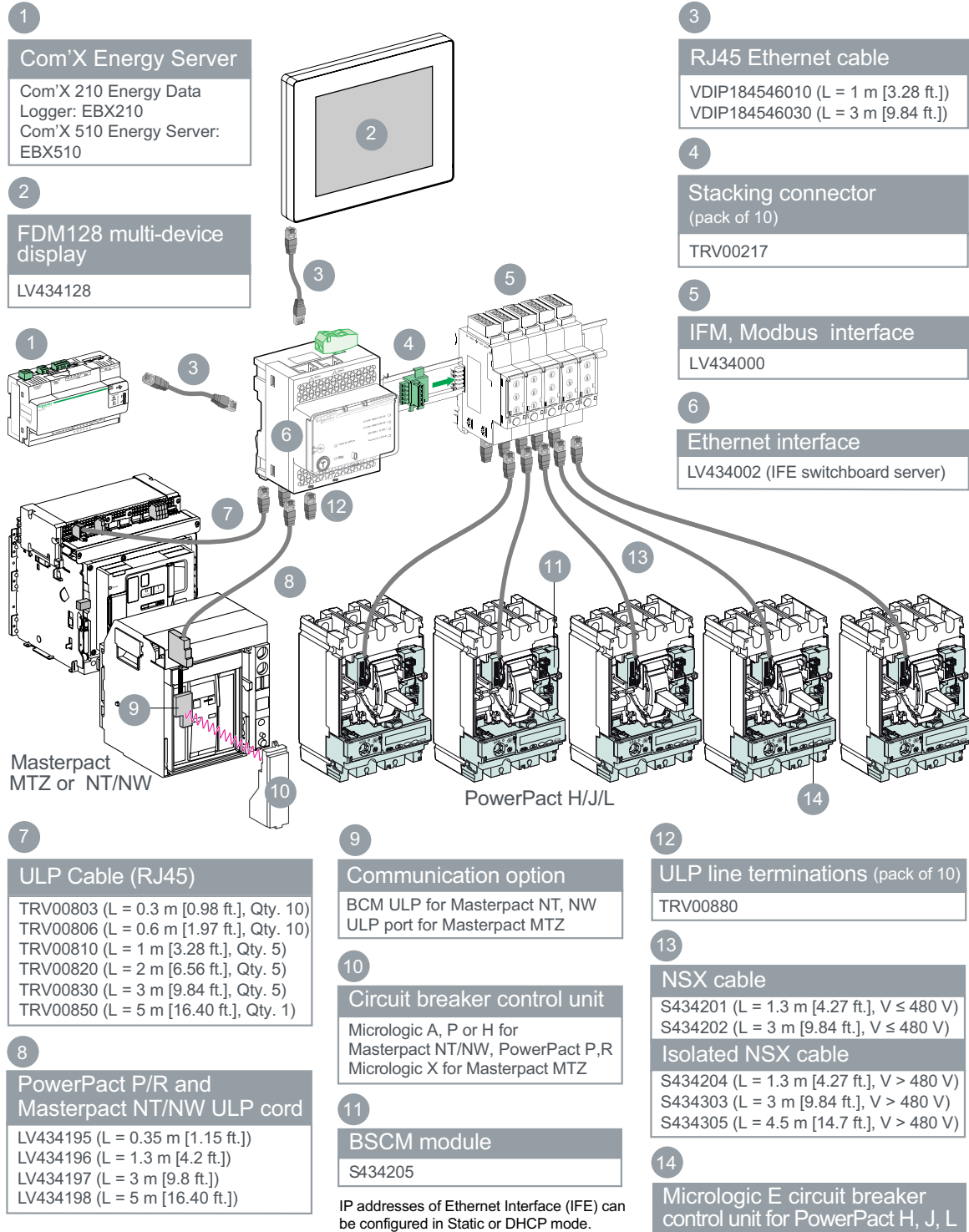



Communications—Direct Ethernet

**NOTE:** Refer the Smart System Data Acquisition user guide (<https://www.schneider-electric.us/en/download/document/0614DB1801/>) to aid in component selection for Smart Systems.

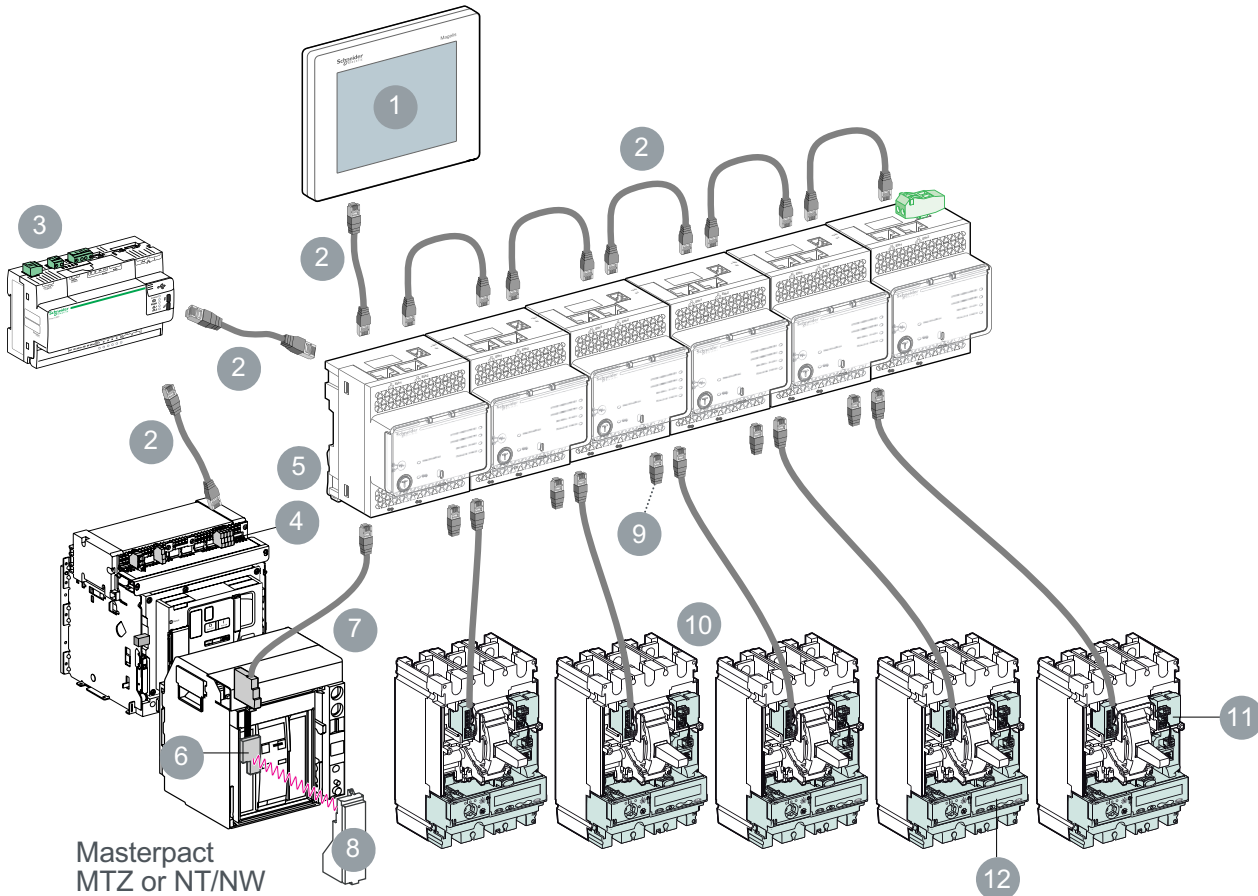

1  
FDM128 Mult-Device Display  
LV434128

2  
RJ45 Ethernet Cable  
VDIP184546010 (L = 1 m [3.28 ft.])  
VDIP184546030 (L = 3 m [9.84 ft.])

3  
Com'X Energy Server  
Com'X 210 Energy Data Logger: EBX210  
Com'X 510 Energy Server: EBX510

4  
EIFE Embedded Ethernet Interface  
LV851120SP

IP addresses of Ethernet Interface (IFE) can be configured in Static or DHCP mode.

5  
IFE Ethernet Interface  
LV434001

6  
Communication Option  
BCM ULP for Masterpact NT, NW  
ULP port for Masterpact MTZ

7  
PowerPact P/R and Masterpact NT/NW ULP Cord  
LV434195 (L = 0.35 m [1.15 ft.])  
LV434196 (L = 1.3 m [4.27 ft.])  
LV434197 (L = 3 m [9.24 ft.])  
LV434198 (L = 5 m [16.40 ft.])

8  
Circuit breaker control unit  
Micrologic A, P or H for Masterpact NT/NW, PowerPact P,R  
Micrologic X for Masterpact MTZ

9  
ULP line terminations (pack of 10)  
TRV00880

10  
NSX cable  
S434201 (L = 1.3 m [4.27 ft.], V ≤ 480 V)  
S434202 (L = 3 m [9.84 ft.], V ≤ 480 V)  
Isolated NSX cable  
S434204 (L = 1.3 m [4.27 ft.], V > 480 V)  
S434303 (L = 3 m [9.84 ft.], V > 480 V)  
S434305 (L = 4.5 m [14.7 ft.], V > 480 V)

11  
BSCM Module  
S434205

12  
Micrologic E circuit breaker control unit for PowerPact H, J, L



GFM250 with Optional GFM25CT

**MicroLogic™ Add-on Ground-Fault Module (GFM)**

The MicroLogic Ground-Fault Module (GFM) is a UL Listed/CSA Certified circuit breaker accessory which protects equipment from damage caused by ground faults. It is an add-on module which, when connected to a PowerPact H- or J-frame thermal-magnetic circuit breaker only, provides ground-fault sensing and ground-fault relay functions.

HD/JD ground-fault modules feature:

- Adjustable ground-fault pickup levels
- Adjustable ground-fault time delays
- Integral ground fault push-to-test feature
- Ground-fault indicator (mechanical for local, contacts for remote)
- All GFMs are supplied for I-Line™ mounting as standard, easily convertible to unit mount by removing the I-Line bracket
- Fault-powered (through the sensing current transformer) for electronics, shunt trip, and integral test feature. Meets NEC 230.95(C)
- A 12 Vdc shunt trip module (Catalog No. S29382) is required in the circuit breaker. This may be field installed or factory installed when the circuit breaker is ordered with an -SN suffix.
- UL 1053 — Ground-fault Sensing and Relaying Equipment

The GFM system requires the following:

- H-frame (15–150 A) or J-frame (150–250 A) molded case circuit breaker
- Shunt trip is required for the function of the GFM (may be factory-installed or field-installed)
- Bus bar connection (terminal nut inserts) for OFF end of circuit breaker
- Optional neutral current transformer, catalog number GFM25CT (must be ordered for 4-wire applications). NOTE: Ground-fault modules cannot be used for alarming only.

**Table 7.165: Module/Enclosure Selection Chart [1]**

Companion Circuit Breaker Prefix	Cat. No. [2]	I-Line Switchboard	Ground-fault Pickup Adjustment Range
HD, HG, HJ, HL	GFM150HD	LA	20–100 A
JD, JG, JJ, JL	GFM250JD	LA	40–200 A
Accessories			
H & J	GFM25CT	Optional Neutral Current Transformer (required for 4-wire loads)	

**Earth Leakage Module (ELM) for PowerPact H- and J-Frame MCCBs**

The Earth Leakage Module (ELM) is an add-on module which, when connected to a PowerPact H- or J-frame MCCB, provides low-level ground-fault sensing and ground-fault relay functions.

Because these ELMs are highly sensitive (30 mA to 3 A), they provide much greater protection than GFMs (20 to 200 A sensitivity). The ELMs provide greater protection of control circuits and other sensitive equipment. The associated circuit breaker must have a 48 Vdc shunt trip, which may be field-installed (kit S29392) or factory-installed (suffix – SP) in the H- or J-Frame circuit breaker.

Add-on Earth Leakage Module (ELM) Features:

- Adjustable ground-fault pickup levels as low as 30 mA
- Adjustable ground-fault time delays from instantaneous to 500 msec (Time delay can be applied to the 30 mA setting)
- Integral ground fault push-to-test feature
- Ground-fault indicator; pop-up button for local status and contacts for remote indication (to be used only with the tripping option)
- All ELMs are supplied for I-Line™ mounting and are easily convertible to unit-mount by removing the I-Line brackets
- Three poles; 240 to 600 Vac maximum: 3-wire applications only (no neutral)
- Line-power obtained through internal bus to provide power for electronics, shunt trip, and integral test feature.
- A shunt trip is required in the circuit breaker; it may be field-installed or factory-installed in the PowerPact H and J circuit breakers.
- UL 1053 – Ground-fault Sensing and Relaying Equipment

**Table 7.166: ELM Selection Chart [3]**

Companion Circuit Breaker [4]		Enclosure Space Required I-Line Switchboard	Pick-Up Adjustment Range	Catalog Number
Prefix	Size			
HD, HG, HJ, HL	15–150 A	LA	30 mA–3 A	ELM150HD
JD, JG, JJ, JL	150–250 A	LA	30 mA–3 A	ELM250JD



I-Line J-Frame with ELM Installed

[1] At 250 A, the GFM250JD can be used with 80% rated circuit breakers only.

[2] See Supplemental Digest Section 3 for additional GFMs.

[3] At 250 A, the ELM250JD can be used with 80% rated circuit breakers only.

[4] For Factory Installation of ELM Module: For termination designation (3rd letter of catalog number) use ONLY "M". Add factory installed 48 Vdc shunt trip (suffix SP) to breaker plus suffix VL or VM.

Miniature and Molded Case Circuit Breaker Dimensions  
Table 7.167: QO™, QOU, Multi 9™ Circuit Breakers

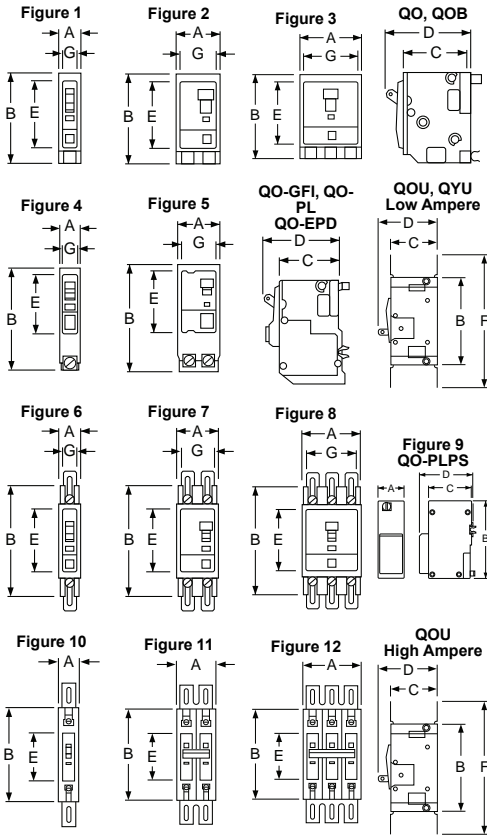

Circuit Breaker Cat. No. Prefix	Poles	Fig. No.	Dimensions—Inches						
			A	B	C	D	E	F	G
QO, QOB	1	1	0.75	3.00 [1]	2.31	2.91	2.25	—	0.59
	2	2	1.50	3.00 [1]	2.31	2.91	2.25	—	1.34
	3	3	2.25	3.00 [1]	2.31	2.91	2.25	—	2.09
QOB-VH 150 A QOB-VH 110–150 A	2	2	3.0	5.72	2.53	4.90	3.78	—	2.85
	3	3	4.50	5.72	2.53	4.90	3.78	—	4.35
	1	4	0.75	4.12 [2]	2.31	2.91	2.25	—	0.59
QO-PL QO-GFI QO-EPD	2	5	1.50	4.12 [2]	2.31	2.91	2.25	—	1.34
	3	5	2.25	4.12 [2]	2.31	2.91	2.25	—	2.09
	QOU QYU Low Ampere	1	6	0.75	4.05 [3]	2.38	2.98	2.25	5.00 [4]
2		7	1.50	4.05 [3]	2.38	2.98	2.25	5.00 [4]	1.37
3		8	2.25	4.05 [3]	2.38	2.98	2.25	5.00 [5]	2.12
QOU High Ampere	1	10	0.75	4.45	2.37	2.96	2.25	6.78	—
	2	11	1.50	4.45	2.37	2.96	2.25	6.78	—
	3	12	2.25	4.45	2.37	2.96	2.25	6.78	—
Multi 9™ C60	1	13	0.71	3.19	1.73	2.76	1.77	—	—
	2	14	1.42	3.19	1.73	2.76	1.77	—	—
	3	15	2.13	3.19	1.73	2.76	1.77	—	—
	4	16	2.84	3.19	1.73	2.76	1.77	—	—
QO-PLPS Power Supply	2	9	1.45	4.35	2.42	3.11	—	—	—

Table 7.168: QB, QD, QG, QJ, Q4, FA, LA, Circuit Breakers

Circuit Breaker Cat. No. Prefix	Poles	Fig. No.	Dimensions—Inches							
			A	B	C	D	E	F	G	H
QB, QD, QG, QJ	2	22	6.47	3.00	3.02	3.93	[6]	4.25	—	—
	3	23	6.47	4.50	3.02	3.93	[6]	4.25	1.50	0.75
FAL, FHL	1	21	6.00	1.50	3.16	4.13	0.44	5.13	1.50	—
	2	22	6.00	3.00	3.16	4.13	0.44	5.13	—	—
	3	23	6.00	4.50	3.16	4.13	0.44	5.13	1.50	0.75
Q4L, LAL, LHL	2 & 3	23	11.00	6.00	4.06	5.84	0.88	9.25	2.00	1.00

Table 7.169: Shipping Weights [7]

Frame Size	Approx. Shipping Weight (Lbs.)	Frame Size	Approx. Shipping Weight (Lbs.)
FAL, FHL 1P	2	QB, QD, QG, QJ	4
FAL, FHL 2P	3	LAL, LHL	15
FAL, FHL 3P	5	Q4L	15

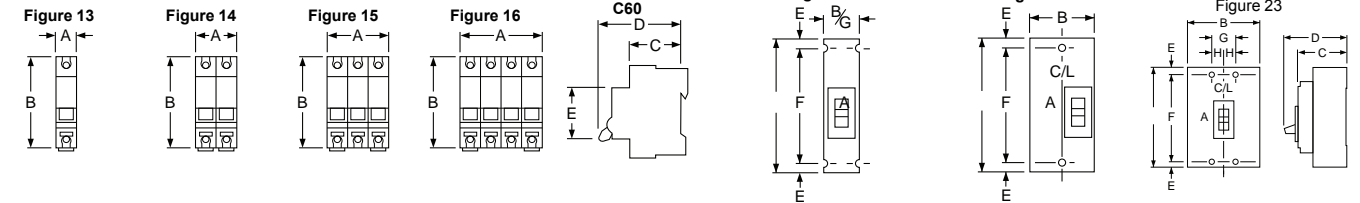

[1] 35–70 A is 3.12 in; 80–100 A 2P and 70–100 A 3P are 3.50 in.  
 [2] QO-PL is 4.55 in.  
 [3] 80–100 A 1P and 80–125 A 2P are 4.45 in.  
 [4] 80–100 A 1P and 80–125 A 2P are 6.78 in.  
 [5] 70–100 A is 6.78 in.  
 [6] Dimensions E are 1.59 in at ON end and 0.63 in at OFF end.  
 [7] All weights are for 3P circuit breakers unless otherwise noted.

**Molded Case Circuit Breaker Dimensions**

**Table 7.170: PowerPact B-, H-, J-, and L-Frame Circuit Breakers**

Circuit Breaker Frame	No. of Poles	Fig. No.	Dimensions — Inches							
			A	B	C	D	E	F	G	H
B-Frame	1	35	6.79	1.06	3.15	4.01	0.20	6.33	—	5.39
	2	36	6.22	2.12	3.15	4.01	0.86	4.48	—	5.39
	3	37	6.22	3.19	3.15	4.01	0.86	4.48	1.06	5.39
	4	38	6.22	4.25	3.15	4.01	0.86	4.48	2.12	5.39
H-Frame	2 [8]	25	6.40	2.74	2.87	4.36	0.74	4.92	—	—
	3	26	6.40	4.12	2.87	4.36	0.74	4.92	1.38	—
J-Frame	3	27	7.52	4.12	2.87	5.00	1.30	4.92	1.38	—
L-Frame	3	28	13.38	5.51	3.75	6.61	2.22	7.87	1.77	—

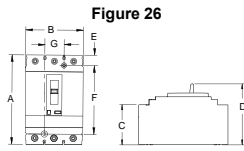
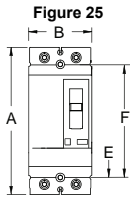

**Figure 27**

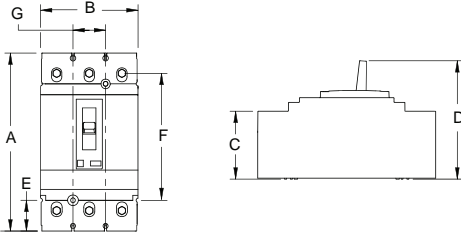

**Figure 28**

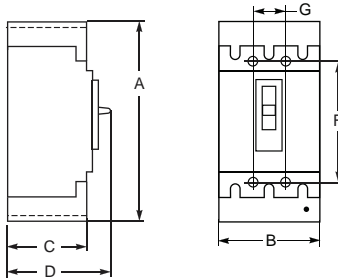

**Figure 29**

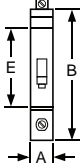

**Figure 30**



**Figure 31**

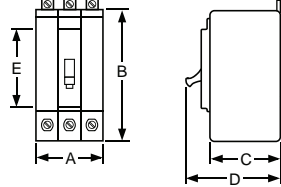

**Figure 32**

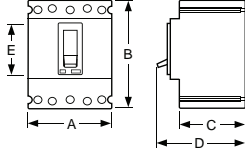

**Figure 33**

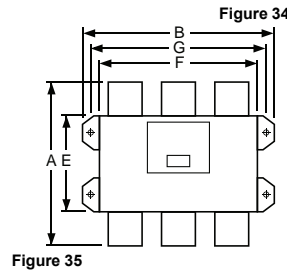
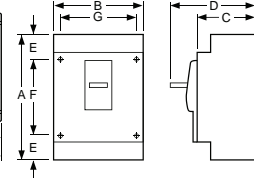

**Figure 35**

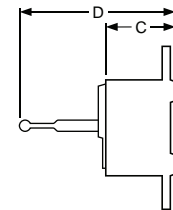

**Figure 36**

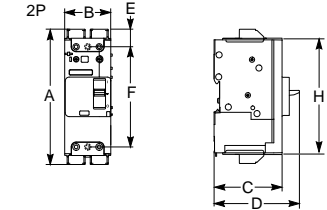

**Figure 37**

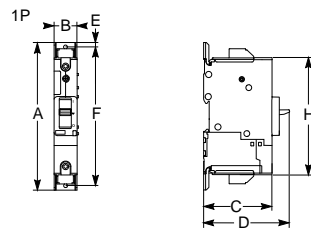

**Figure 38**

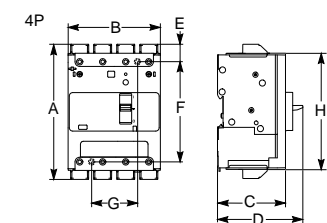

**Table 7.171: ED, EG, EJ, and GJ Circuit Breakers**

Circuit Breaker Cat. No. Prefix	No. of Poles	Fig. No.	Dimensions — Inches				
			A	B	C	D	E
ED, EG, EJ	1	29	0.98	5.66	3.09	4.05	3.32
ED, EG, EJ	2	30	1.96	5.66	3.09	4.05	3.32
ED, EG, EJ	3	31	2.94	5.66	3.09	4.05	3.32
GJ	3	32	3.54	4.72	2.76	3.94	2.20

**Table 7.172: PowerPact M-, P-, and R-Frame Circuit Breakers**

Circuit Breaker Frame	No. of Poles	Fig. No.	Dimensions — Inches						
			A	B	C	D	E	F	G
M-Frame (800 A and below)	2, 3	33	12.86	8.27	5.77	8.05	2.49	7.87	7.83
P-Frame (1000–1200 A)	2, 3	33	16.16	8.27	5.77	8.05	4.19	7.87	7.83
R-Frame	2, 3	34	16.24	16.54	6.63	14.49	8.73	14.25	15.35

**Table 7.173: Shipping Weights [9]**

Frame Size	Approx. Shipping Weight (Lbs.)	Frame Size	Approx. Shipping Weight (Lbs.)
B-Frame 1P	1	H-Frame 2P	4
B-Frame 2P	2	H-Frame 3P	5
B-Frame 3P	3	J-Frame	5
B-Frame 4P	4	L-Frame	14
EDB 1P	2	M-Frame	29
EDB 2P	3	P-Frame	32
EDB 3P	4	R-Frame (Without RLTB)	52

[8] Only HD and HG are in 2P module, HJ, HL and HR 2P are in 3P module.

[9] All weights are for 3P circuit breakers unless otherwise noted.

**PowerPact Circuit Breaker Enclosures**

- The enclosures for the family of PowerPact circuit breakers B- through Q-frame are cULus listed unless otherwise noted.
- The enclosures are suitable for service entrance equipment when neutral assembly is installed.
- The short circuit current rating of the enclosed circuit breakers is equal to the rating of the circuit breaker installed unless otherwise noted.
- All enclosures will accept 100% rated circuit breakers unless otherwise noted.

**PowerPact B-Frame Circuit Breaker Enclosures**

- The enclosures' maximum short circuit ratings are 65 kA at 600Y, 65 kA at 480 Vac, 100 kA at 240 Vac and 50 kA at 250 Vdc unless otherwise noted.
- Enclosures accept 100% rated circuit breakers [8].

**Table 7.174: PowerPact B-Frame Circuit Breaker Enclosures**

Circuit Breaker			Enclosure Catalog Number			Accessory Catalog Number	
Cat. No. Prefix	Rating	Poles				Neutral Assembly Kit	Service Ground Kit
			NEMA 1 Flush	NEMA 1 Surface	NEMA 3R		
BDL, BGL, BJL	15–100 A	2, 3	B125F	B125S	B125RB	SN100FA	PKOGTA2
BDL, BGL, BJL	110–125 A	2, 3				SN225KA	
BKL	15–30 A	2				SN100FA	
			NEMA 4, 4X, 5 Type 304 Stainless Steel	NEMA 12 With Knockouts	NEMA 12 Without Knockouts		
BDL, BGL, BJL	15–100 A	2, 3	B125DS	B125A	B125AWK[1]	SN100FA	PKOGTA2
BDL, BGL, BJL	110–125 A	2, 3				SN225KA	
BKL	15–30 A	2				SN100FA	

**PowerPact H- and J-Frame Circuit Breaker Enclosures**

The enclosures' maximum short circuit ratings are 25 kAIR at 600 Vac, 65 kAIR at 480 Vac, 125 kAIR at 240 Vac and 20 kA at 250 Vdc unless otherwise noted. Enclosures accept 100% rated circuit breakers [2]. The enclosures are not compatible with earth-leakage or ground-fault modules.

H- and J-frame circuit breakers with MicroLogic trip units can be used with these enclosures, but have the following limitations:

- No communication accessories can be mounted in the enclosure (no IFM or Front Display Module, IFE, etc).
- The trip unit will not be accessible or visible without the removal of the cover (except J250F and J250S).
- For LSIG, there is no room for the NCT to mount in the enclosure.

**Table 7.175: PowerPact H- and J-Frame Circuit Breaker Enclosures**

Circuit Breaker			Enclosure Cat. No.			Neutral Assembly Kit Cat. No.	Service Ground Kit Cat. No.
Cat. No. Prefix	Rating	Poles					
			NEMA 1 Flush	NEMA 1 Surface	NEMA 3R		
HDL	15–100 A	3	—	HD100S [3][4][5]	—	SN100FA	PKOGTA2
HDL, JDL	125–225 A	3	—	JD250S [6][4][5]	—	SN225KA	PKOGTA2
	125–250					SN400LA	
HDL, HGL	15–100 A	2	H150F	H150S	H150R [7]	SN100FA	PKOGTH150
	125–150 A	2				SN400LA	
HJL, HLL	15–100 A	2	J250F	J250S [8]	J250R [7][9]	SN100FA	PKOGTH150
HDL, HGL, HJL, HLL	15–100 A	3				SN400LA[10]	
	125–150 A	3					
JDL, JGL, JLL, JLL	150–250 A	2, 3				SN400LA[10]	PKOGTJ250
			NEMA 4, 4X, 5 [11] Type 304 Stainless Steel [12]	NEMA 4, 4X, 5 [11] Type 316 Stainless Steel [12]	NEMA 12/3R Without Knockouts [12]		
HDL, HGL, HJL, HLL	15–100 A	2, 3	J250DS [13]	J250SS [13]	J250AWK [13]	SN100FA	PKOGTH150
	125–150 A	2, 3				SN400LA[10]	
JDL, JGL, JLL, JLL	150–250 A	2, 3					

[1] For NEMA 3R applications, remove drain scerw from bottom end wall.  
 [2] Use only 90°C (minimum) rated wire sized per ampacity of 75°C rated conductors for 100% rated circuit breakers.  
 [3] Rated for 240 Vac maximum. Short circuit current rating is 25 kAIR at 240 Vac.  
 [4] Accepts standard 80% rated circuit breakers only. Not rated for 100% rated circuit breakers.  
 [5] Use copper conductors only.  
 [6] Rated 480 Vac maximum. Short circuit current rating is 18 kAIR at 480 V.  
 [7] For conduit entry through the top end wall use one of the following Square D conduit hubs: A200L for 2.00 in., A250L for 2.50 in., A300L for 3.00 in., A350L for 3.50 in. or A400L for 4.00 in.  
 [8] Add suffix BE if no knockouts are required on the end walls.  
 [9] For access to the circuit breaker's standard, ammeter or energy trip unit panel/LCD, add suffix T.  
 [10] For 200% neutral use copper wire only.  
 [11] Complete rating is NEMA 3, 3R, 4, 4X, 5, and 12.  
 [12] For NEMA 3R applications, remove drain screw from bottom endwall.  
 [13] Add suffix VW for visibility to the standard, ammeter or energy trip unit of the PowerPact circuit breaker.

**PowerPact L-Frame Circuit Breaker and Molded Case Switch Enclosures**

All enclosures accept 80% rated circuit breakers. The enclosures will also accept 100% rated circuit breakers to 400 amps. The enclosures have a blank top end wall and require field-cut openings. For details and hub catalog numbers see page 3–10.

**Table 7.176: PowerPact L-Frame Circuit Breaker Enclosures**

Circuit Breaker			Cat. No.			
Cat. No. Prefix	Rating	Poles	NEMA 12/3R Enclosures Without Knockouts	Neutral Assembly Kit	Copper Only Neutral Assembly Kit	Service Ground Kit
LDL, LGL, LJL, LLL, LRL	250–400 A	3	L600AWK [14][15][16]	SN400LA	SNC400LX	PKOGTA4
	400–600 A			SN1000MA	SNC800LX	
LGL, LLL, LRL	250–400 A	3	L600AWKMC [17][15]	SN400LA	SNC400LX	PKOGTA4
	400–600 A			SN1000MA	SNC800LX	

**PowerPact Q-Frame Circuit Breaker Enclosures**

The enclosures for the PowerPact Q Frame Circuit Breaker are UL listed. The short circuit ratings of these enclosed circuit breakers are equal to the interrupter ratings, at the supply voltage marked on the circuit breaker installed, unless otherwise noted.

**Table 7.177: PowerPact Q-Frame Circuit Breaker Enclosures**

Circuit Breaker			Enclosure Cat. No.			Neutral Assembly Kit Cat. No.	Service Ground Kit Cat. No.
Cat. No. Prefix	Rating	Poles	NEMA 1 Flush	NEMA 1 Surface	NEMA 3R		
QBL, QDL, QGL, QJL [18]	70–225 A	2	—	Q22200NS [19]	Q22200NRB [19]	—	PKOGTA2
		2, 3	Q23225NF	Q23225NS	Q23225NRB		

**PowerPact M- and P-Frame Circuit Breaker Enclosures**

All enclosures will accept 80% rated circuit breakers. The P1200 enclosures will accept 100% rated circuit breakers to 800 A. If a CT neutral is required, the enclosure will no longer accept a 200% neutral. The M800R and the P1200R enclosures have a blank top end wall and require field-cut openings. For details and hub catalog numbers see page 3-10.

**Table 7.178: PowerPact M- and P-Frame Circuit Breaker Enclosures**

Circuit Breaker			Cat. No.						
Cat. No. Prefix	Rating	Poles	Enclosure			Neutral Assembly Kit	200% Neutral Kit	CT Neutral Kit [20][21]	Service Ground Kit
			NEMA 1 Flush	NEMA 1 Surface	NEMA 3R				
MGL, MJL, PGL, PJL, PKL, PLL	300–800 A	2, 3	—	M800S	M800R	AL800SN	SN800SNI and 2 each SN1200	S33576MK	PKOGTA4
			—	P1200S	P1200R	SN1200	—	S33576MK	PKOGTA4
			NEMA 4, 4X, 5 [22] Type 304 Stainless Steel [15]	NEMA 4, 4X, 5 [22] Type 316 Stainless Steel [15]	NEMA 12/3R Without Knockouts [15]				
MGL, MJL, PGL, PJL, PKL, PLL	300–800 A	2, 3	M800DS	M800SS	M800AWK	AL800SN	—	S33576MK	PKOGTA4
			—	—	P1200AWK	SN1200	—	S33576MK	PKOGTA4

**PowerPact L-Frame 500 Vdc Circuit Breaker Enclosures**

The PowerPact L-frame circuit breaker enclosure's maximum short circuit rating is 20 kAIR at 250 Vdc and 50 kAIR at 500 Vdc.

Listed for use ONLY on UPS systems.

**Table 7.179: DC Circuit Breaker Enclosures for LG and LL DC-Rated Circuit Breakers**

Circuit Breaker [23]			Cat. No.		
Cat. No. Prefix	Ampere Rating	Poles	NEMA 1 Surface Enclosure	Replacement Ground Lugs	Service Ground Kit
LGL, LLL	300–600 A	3	L1200S	8010440301	Standard
	700–1200 A	4	L1200S		

[14] Will accept PowerPact L-frame circuit breakers and Motor Protectors with suffixes M38X

[15] For NEMA 3R applications, remove drain screw from bottom endwall.

[16] Add suffix VW for visibility to the standard, ammeter or energy trip unit of the PowerPact circuit breaker.

[17] Will accept PowerPact L-frame Molded Case Switches.

[18] When the QJL circuit breaker is installed in the enclosure, the enclosure is limited to Short Circuit Current ratings of 65 kAIR at 240 V and 100 kAIR at 208 V.

[19] Limited to 200 A.

[20] Order current transformer kit S33576 separately.

[21] Current transformers applicable only on PowerPact P circuit breakers. Current limitations are 400–800 A and 400–1200 A respectively for the M800 and P1200 family of enclosures.

[22] Complete rating is NEMA 3, 3R, 4, 4X, 5, and 12.

[23] Use 500 Vdc or 250 Vdc rated circuit breakers only.

**LA/LH/Q4 Circuit Breaker Enclosures**  
**LA/LH/Q4 Thermal-Magnetic Circuit Breaker Enclosures**

The enclosures for the LA/LH/Q4 thermal-magnetic circuit breakers are UL listed and CSA certified. The enclosures are suitable for service entrance equipment when neutral assembly is installed. The short circuit ratings of these enclosed circuit breakers are equal to the interrupter rating, at the supply voltage marked on the circuit breaker installed.

The LA400R enclosure has a blank top end wall and requires field cut openings. For details and hub catalog numbers see Digest Section 3.



**Table 7.180: LA/LH/Q4 Thermal-Magnetic Circuit Breaker Enclosures**

Circuit Breaker			Enclosure			Neutral Assembly Kit	Service Ground Kit
Cat. No. Prefix	Rating	Poles	Cat. No.	Cat. No.	Cat. No.	Cat. No.	Cat. No.
			NEMA 1 Flush	NEMA 1 Surface	NEMA 3R		
LAL, LHL, Q4L	125–225 A 225–400 A	2, 3	LA400F [24]	LA400S [24]	LA400R	SN225KA 400SN	PKOGTA2
LAL	125–400	3	—	LA400LS [25] [26][27][28]	—	SN400LA	
			NEMA 4, 4X, 5 [29] Type 304 Stainless Steel [30]	NEMA 12K With Knockouts	NEMA 12/3R Without Knockouts [30]		
LAL, LHL, Q4L	125–225 A 225–400 A	2, 3	LA400DS [27]	—	LA400AWK [27]	SN225KA SN400LA	PKOGTA2

**Enclosures for Special Applications**

**Hazardous Locations: NEMA 7 And NEMA 9 Circuit Breaker Enclosures**

The NEMA 7 and 9 enclosures are cULus listed unless otherwise noted. They are rated for use in hazardous locations as defined in NEC Article 500. The short circuit current rating of the enclosed circuit breakers is equal to the rating of the circuit breaker installed unless otherwise noted. They are suitable for use as service entrance equipment when neutral is installed. Enclosures require the use of 75°C copper wire only. The NEMA 7 enclosures are suitable for rainproof applications when the included PKDB1 breather and drain kit is installed.

**Table 7.181: NEMA 7 and NEMA 9 Circuit Breaker Enclosures; Thermal-Magnetic B-Frame and PowerPact J-Frame Circuit Breakers**

Circuit Breaker			Enclosure Catalog Number		Neutral Assembly Kit Cat. No.	Service Ground Kit Cat. No.	Threaded Conduit Provisions, Inches
Cat. No. Prefix	Rating	Poles	NEMA 7/9 Cast Aluminum [31][32]	NEMA 9 Cast Aluminum [32]			
BKL	15–30 A	2	B100X	—	100SNA	Included	1 1/4 in.
BDL, BGL, BJL	15–100 A	2, 3					
JDL, JGL	150–225 A	2, 3	J225X [33][34]	J225Y [33][34]	225SNA	Included	2 1/2 in.

**Enclosed Molded Case Switches**

For information on enclosed molded case switches, see Supplemental Digest Section 3.

[24] Enclosures are provided with the Handle Padlock Attachment (HPALM) for field installation to lock the circuit breaker in the "ON" or "OFF" positions.  
 [25] Use copper conductors only.  
 [26] Maximum short circuit and voltage is 30 kAIR at 480 Vac.  
 [27] LAL or LHL circuit breakers with an MB or MT suffix are not compatible with these enclosures: LA400DS, LA400AWK, and LA400LS.  
 [28] Enclosure cover has an integral padlock provision to provide a means to lock the circuit breaker in the "ON" or "OFF" position.  
 [29] Complete rating is NEMA 3, 3R, 4, 4X, 5, and 12.  
 [30] For NEMA 3R applications, remove drain screw from bottom endwall.  
 [31] NEMA 7 — Indoor Hazardous Locations — Division 1 and 2, Class I, Groups C and D; Class II, Groups E, F and G; Class III  
 [32] NEMA 9 — Indoor Hazardous Locations — Division 1 and 2, Class II, Groups E, F and G; Class III  
 [33] Short circuit current rating: 65 kAIR at 240 Vac, 25 kAIR at 480 Vac, and 18 kAIR at 600 Vac  
 [34] Not cULus listed due to wire bending space.

**Enclosure Accessories**

**Table 7.182: Neutral Kit Terminal Data**

Neutral Kit Catalog Number	Terminal Lug Data -Total Available (Line plus Load) AWG/kcmil AL/CU	All Copper Neutral Terminal Lug Data -Total Available (Line plus Load) AWG/kcmil
100SNA	(2) 14-1/0 Cu or (2) 12-1/0 Al plus (1) 14-4 Cu	—
SN100FA	(4) 14-1/0 Cu or (4) 12-1/0 Al	—
SN225KA	(2) 4-300 Al/Cu plus (2) 14-1/0 Al/Cu	—
225SNA	(4) 6-350 Al/Cu	—
400SN	(2) 1-600 or (4) 1-250 Al/Cu, plus (2) 4-300 Al/Cu	—
SN400LA	(2) 1-600 or (4) 1-250 Al/Cu, plus (2) 4-300 Al/Cu	—
SN1000MA	(6) 3/0-500 Al/Cu, plus (1) 1-4/0 Al/Cu	—
SNC400LX	—	(2) 2-600 Cu, plus (2) 6-250 Cu
SNC800LX	—	(4) 2-600 Cu, plus (1) 2-4/0 Cu
AL800SN	(6) 3/0-500 Al/Cu, plus (2) 6-250 Al/Cu	—
SN1200	(8) 3/0-750 Al/Cu, plus (2) 6-350 Al/Cu	—
S33576MK	(8) 3/0-500 Al/Cu, plus (2) 4-300 Al/Cu	—

**Table 7.183: Service Ground Kit Terminal Data**

Service Ground Kit Catalog Number	Terminal Data AWG/kcmil	Lugs Per Kit
PKOGTA2	10-2/0 Cu or 6-2/0 Al	2
PKOGTH150	14-2 Al/Cu	2
PKOGTJ250	6-300 Al/Cu	2
PKOGTA4	6-250 Al/Cu	4

**Terminal Shields for Service Entrance Applications**

- Can be applied as line side barriers in service entrance applications
- Will fit on top or bottom of the circuit breaker

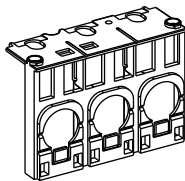

J-Frame Short Lug Shield

**Table 7.184: Terminal Shields**

Frame	2P	3P
PowerPact Q	QSB2	QSB3
PowerPact H (3 AWG Max. Wire Size)	—	S37446
PowerPact H (3/0 Max. Wire Size)	—	S37447
PowerPact J	—	S37448
PowerPact M	—	MGJTC
PowerPact P	—	PA12TC
LA/LH	—	LAHTC

See Supplemental Digest Section 3 for special options for enclosures:

- Stainless steel fronts
- Pilot lights, push buttons
- Lock-on SPL0
- Key interlock systems
- Legend plates



Enclosure Dimensions

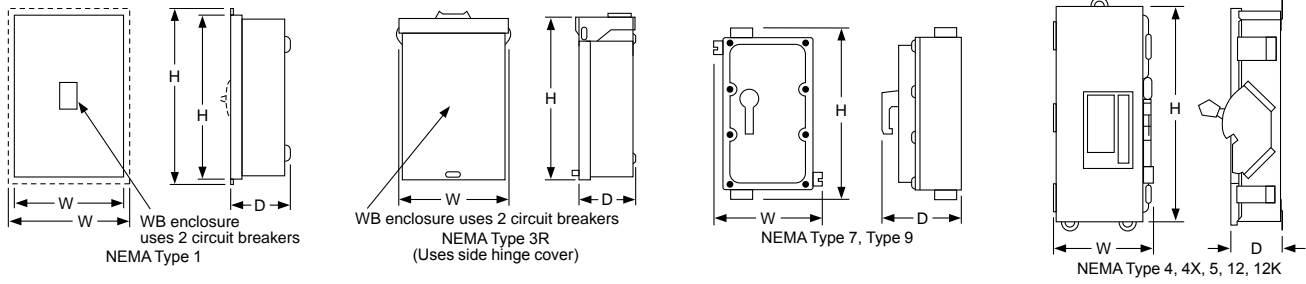

Table 7.185: Dimensions

Cat. No.	Series	Approximate Dimension					
		H		W		D	
		in.	mm	in.	mm	in.	mm
B125F	A01	19.5	495	9.88	251	4.13	105
B125S	A01	18.13	461	8.63	219	4.13	105
B125FSS	A01	19.5	495	9.88	251	4.13	105
B125RB	A01	18.0	457	8.88	226	4.88	124
B125DS	A01	19.5	495	9.13	232	4.88	124
B125SS	A01	19.5	495	9.13	232	4.88	124
B125A	A01	19.5	495	9.13	232	4.88	124
B125AWK	A01	19.5	495	9.13	232	4.88	124
B125AWKMC	A01	19.5	495	9.13	232	4.88	124
HD100S	A01	17.00	431.8	7.90	200.7	4.75	120.7
H150F	A01	32.40	823	15.40	391	6.00	152
H150R	A01	31.05	789	14.47	368	6.28	160
H150S	A01	31.36	797	14.36	365	6.00	152
J250F	A01	32.40	823	15.40	391	6.00	152
J250R	A01	31.05	789	14.47	368	6.28	160
J250S	A01	31.36	797	14.36	365	6.00	152
J250DS	A01	32.26	819	9.72	247	7.94	202
J250SS	A01	32.26	819	9.72	247	7.94	202
J250AWK	A01	32.26	819	9.72	247	7.94	202
JD250S	A01	26.40	670.6	8.90	226.1	5.50	139.7
J225X	A01	22.70	577	10.93	278	7.70	196
J225Y	A01	22.70	577	10.93	278	7.70	196
L600AWK	A01	57.50	1461	20.38	518	8.25	210
L600AWKVW	A01	57.50	1461	20.38	518	8.25	210
L600AWKMC	A01	57.50	1461	20.38	518	8.25	210
L1200S	A01	51.88	1818	20.25	514	7.75	197
LA400AWK	E05	42.25	1073	13.75	349	7.25	184
LA400DS	E05	42.25	1073	13.75	349	7.25	184
LA400F	E03	45.63	1159	16.50	419	6.50	165
LA400R	E03	44.00	1118	15.38	391	7.88	200
LA400S	E03	44.50	1130	15.38	391	6.50	165
LA400LS	A01	27.40	696.0	15.40	391.2	6.625	168.3
M800S	A01	40-3/8	1025.52	21	533.4	9-3/4	247.65
M800R	A01	40-3/8	1025.52	21	533.4	9-3/4	247.65
M800DS	A01	40-7/8	1036.96	20-3/4	527.05	9-1/2	241.3
M800SS	A01	40-7/8	1036.96	20-3/4	527.05	9-1/2	241.3
M800AWK	A01	40-7/8	1036.96	20-3/4	527.05	9-1/2	241.3
P1200S	A01	52-1/8	1323.98	21	533.4	9-3/4	247.65
P1200R	A01	52-1/8	1323.98	21	533.4	9-3/4	247.65
P1200AWK	A01	53	1346.20	20-3/4	527.05	9-1/2	241.3
Q22200NRB	E05	23.38	594	7.63	194	4.75	121
Q22200NS	E05	23.13	588	7.63	194	4.25	108
Q23225NF	E05	26.25	667	9.88	251	4.75	121
Q23225NRB	E05	26.25	667	9.88	251	5.50	140
Q23225NS	E05	26.25	667	9.88	251	4.75	121

# Section 8

## Operating Mechanisms and Disconnect Switches



UL508 Motor Disconnect Switch



UL98 Fusible Switch



UL508 VLS Switch



UL98 VLS Switch

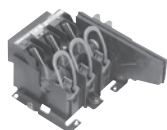

UL98 Style Flange Handle Disconnect Switch



9421 Type L Circuit Breaker Mechanism



9422 Type R Circuit Breaker Mechanism



9422 Type C Circuit Breaker Cable Operator

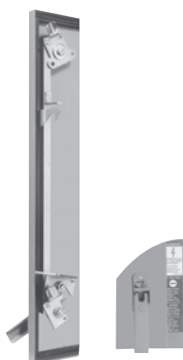

9423 Door Closing Mechanisms

### Operating Mechanisms and Disconnect Switches 8-2

Selection Guide 8-2

### UL 508 Motor Disconnect Switches 8-3

Mini-Vario and Vario™ Assembled and Enclosed Switches 8-3

Mini-Vario and Vario™ Accessories 8-7

MD Motor Disconnect Switches 8-8

### UL 60947-4-1 and UL 98 Disconnect Switches 8-9

TeSys™ VLS Disconnect Switches 8-9

Disconnect Switches, 16–125 A 8-9

TeSys™ VLS Accessories 8-11

Fourth Pole Add-on 8-11

Add-on Blocks 8-12

Sequence and Maximum Combination of Add-on Blocks 8-13

Rotary Handles 8-16

Shaft Extensions, Terminal Covers, Fuse Holders, and Fuse Blocks 8-18

Dimensions: 16–125 A Disconnect Switches 8-19

Wiring Diagrams 8-22

Technical Specifications, VLS Range, 16–125 A 8-23

### UL 98 IEC Style Disconnect Switches 8-24

LK4 Nonfusible and GS2 Fusible Disconnect Switches 8-24

LK4 Nonfusible Disconnect Switches 8-24

GS2 Fusible Disconnect Switches 8-26

Cable Operator Kits for GS2 Switches 8-27

Accessories, LK4 Nonfusible and GS2 Fusible 8-27

Accessories 8-27

Dimensions, LK4 Nonfusible and GS2 Fusible 8-28

LK4JU3N / LK4MU3N / LK4QU3N, 100–400 A Nonfusible Disconnect

Switches—Dimensions 8-28

GS2QU3N, 400 A Fusible Disconnect Switches, Class J Fuses 8-32

### Flange Mounted and Cable Operated 8-32

Disconnect Switches 8-33

Accessories, Disconnect Switches 8-34

Dimensions, Disconnect Switches 8-37

### Operating Mechanisms for Circuit Breakers 8-39

Door Mounted 8-39

Flexible Cable Mechanisms 8-41

Selection Guide



Class	MD	Vario	Enclosed Vario	LK4	VLS	
Type	Motor disconnect switches	Manual motor control switches	Motor disconnect switch	Nonfusible IEC style disconnect switches	Disconnect switches	Disconnect switches
UL Rating	UL 508	UL 508	UL508	UL 98	UL 508	UL 98
Handle Type	Rotary	Rotary	Rotary	Rotary	Rotary	Rotary
Mounting	—	Door or panel	—	—	DIN Rail (Rear Mounting) Door Mounting	DIN Rail (Rear Mounting) Door Mounting
Voltage (max.)	600 Vac	600 Vac	600 Vac	600 Vac	690 Vac	690 Vac
Current Ratings	30–60	10–115	UL-20-115A, IEC 32 - 175	30–1200	16–63 A	63–125 A
Horsepower Ratings (max.)	7.5–40	2–60	2–60	7.5–500	1–30	3–60
Enclosure Type	Non-Metallic NEMA 1, 3, 3R, 4, 4X, and 12	Metallic: NEMA 1, 12, 4, 4X Plastic: IP55, NEMA Type 4X	NEMA 1, 12, 3R 4, 4X	Handle ratings: NEMA 1, 3R, 4, 4X, 12	NEMA 1, 12, 3R, 4, and 4X; IEC IP65, IP66	NEMA 1, 12, 3R, 4, and 4X; IEC IP65, IP66
Accessories	Power poles and auxiliary contacts	Power poles and auxiliary contacts	Power poles and auxiliary contacts	Auxiliary contacts and power lugs	Power poles and auxiliary contacts	Power poles and auxiliary contacts
Approvals	UL File E164864 IEC standard 60947-3	UL File E164864 NLRV CSA File LR 81630 Class 3211 05	UL	UL File E191098 WP2X / WP2X7 CSA 703149 Class 4652 04	UL File E487906 UL60947-4-1 / CSA 22.2 n° 60947-4-1-14	UL File E487907 UL98/CSA 22.2 n° 4
Page	page 8-8	page 8-3	page 8-4	page 8-24	page 8-9	page 8-9



Class	GS2	9422	9421	9422	9423
Type	Fusible IEC style disconnect switches	NEMA style fused or non-fusible disconnect switches	Circuit breaker operating mechanisms	Circuit breaker operating mechanisms	Door closing mechanisms
UL Rating	UL 98	UL98	—	—	—
Handle Type	Rotary	Flange Adjustable rod or cable mechanism	Rotary	Flange Adjustable rod or cable mechanism	Rotary, works in conjunction with 9422 handle mechanisms
Mounting	Flange with cable mechanism panel	Panel or bracket mount	Panel	Panel	—
Load Voltage (max.)	600 Vac	600 Vac	600 Vac	600 Vac	—
Current Ratings	30–800	30–400	Circuit breaker frame sizes 100–1200	Circuit breaker frame sizes 100–1200	—
Horsepower Ratings (max.)	7.5–500	7.5–350	—	—	—
Enclosure Type	Handle ratings: NEMA 1, 3R, 4, 4X, 12	Handle ratings: NEMA 1, 3R, 4, 4X, 12	Handle ratings: NEMA 1, 3R, 4, 4X, 12	Handle ratings: NEMA 1, 3R, 4, 4X, 12	Handle ratings: NEMA 4 and 12 sheet steel or stainless
Accessories	Auxiliary contacts and power lugs	Auxiliary contacts	Auxiliary contacts	Auxiliary contacts	Right or left-hand operation
Approvals	UL File E191098 WP2X / WP2X7 CSA 703149 Class 4652 04	UL File E52639 WHTY2 CSA LR44199 Class 4652-04	UL File E62922 DIHS2 CSA LR44199 Class 3211 07	UL File E62922 DIHS2 CSA LR44199 Class 3211 07	—
Page	page 8-26	page 8-33	page 8-39	page 8-41	Refer to Supplemental Digest Section 15

**Identification System**

Mini-Vario and Vario rotary manual motor-control switches from 12–175 A are suitable for on-load making and breaking of resistive or mixed resistive inductive circuits where frequent operation is required. They can also be used for direct switching of motors in utilization categories AC-3 and DC-3 specific to motors. Vario manual motor-control switches are suitable for isolator applications with fully visible indication (since the handle cannot be in the open position unless all the contacts are actually open and separated by the appropriate isolating distance), and the handles are padlockable.

The Mini-Vario and Vario catalog numbers are described in Table 8.1.

**Table 8.1: Identification System**

		V	CF	N12	GE
<b>Model (V-Vario, K-Operator)</b>					
<b>Operator Type/ Accessory Designation</b>					
<b>CD</b>	Single hole Red & Yellow				
<b>CF</b>	Four hole Red & Yellow				
<b>CCD</b>	Single hole Red & Yellow w/ extension shaft				
<b>CCF</b>	Four hole Red & Yellow w/ extension shaft				
<b>Blank</b>	No operator or accessory				
<b>BD</b>	Single hole Black and Gray				
<b>BF</b>	Four hole Black and Gray				
<b>VE</b>	Switch with Red handle installed on unit (one padlock only)				
<b>VD</b>	Switch with Black handle installed on unit (no padlock provision)				
<b>Z</b>	Accessory, power pole, neutral or ground				
<b>Switch Type (Switches and contacts are dual rated, UL/IEC).</b>					
<b>Blank</b>		<b>1</b>	Vario 20/32 A		
<b>N12</b>	Mini-Vario 10/12 A	<b>2</b>	Vario 25/40 A		
<b>N20</b>	Mini-Vario 16/20 A	<b>3</b>	Vario 45/63 A		
<b>02</b>	Vario 10/12 A	<b>4</b>	Vario 63/80 A		
<b>01</b>	Vario 16/20 A	<b>5</b>	Vario 100/125 A		
<b>0</b>	Vario 20/25 A	<b>6</b>	Vario 115/175 A		
<b>Enclosure Type (if applicable)</b>					
<b>Blank</b>	No Enclosure	<b>G30, A30, W30</b> Type 1/12/4/4X			
<b>GE</b>	Mini-Vario IP55 Non-Metallic	Metallic (Class 9421)			
		<b>GU</b> Vario IP55 Non-Metallic			



VCFN12GE

**Mini-Vario**

**Table 8.2: Assembled Switches—Degree of Protection IP65, Type 1 and 12**

Rating (A)		Complete Switches for Door Mounting (3-Padlock)		Complete Switches for Rear Mounting, Includes Extension Shaft (3-Padlock)
		Red/Yellow (Single Hole)	Black/Gray (Single Hole)	Red/Yellow (Single Hole)
UL	IEC	Catalog No.	Catalog No.	Catalog No.
10	12	VCDN12	VBDN12	VCCDN12
16	20	VCDN20	VBDN20	VCCDN20



VN12



VN12/KCC1YZ



VBDN12



VCDN12



VCCDN20

**Table 8.3: Mini-Vario Enclosed Switches**

Catalog No.	Complete Switches Mounted in IP55 Non-Metallic Enclosure
	Description
VCFN12GE	Red/Yellow Mounted In Sealable Enclosure, Non-UL Listed, Non-NEMA Rated
VCFN20GE	

**Table 8.4: Component Parts**

Catalog No.	Description
VN12 [1]	10/12 A switch only
VN20 [1]	16/20 A switch only
VZN12 [1]	Add on power pole for 10/12 A switch
VZN20 [1]	Add on power pole for 16/20 A switch
VZN11	Neutral Pole with early make, late break for VN12 or VN20 switch
VZN14	Grounding module for VN12 or VN20
VZN05	N.O. late make auxiliary contact [2]
VZN06	N.C. early break auxiliary contact [2]
VZN26	Single-pole shroud for auxiliary contacts
VZN08	Three-pole shroud for VN12 or VN20

**Table 8.5: Operators and Accessories**

Catalog No.	Description
KCC1YZ	45 x 45 mm Red & Yellow operator
KCD1PZ	60 x 60 mm Red & Yellow operator
KAD1PZ	60 x 60 mm Black & Gray operator
VZN17	300–340 mm shaft extension
VZN30	400–430 mm shaft extension
KZ32	Door interlocking plate for 45 or 60 mm operator
KZ83	Door mounting plate for 45 or 60 mm operator

[1] Switches/contacts are dual rated (UL/IEC).  
[2] Auxiliary contacts are dual rated (UL/IEC 10/12 A).



**Vario**

**Table 8.6: NEMA Type 1 and 12 Assembled Switches for Door Mounting**

Rating (A)		Complete Switches (Switch and Handle) for Door Mounting (3-padlock)			
		Red/Yellow (Four Hole)	Black/Gray (Four Hole)	Red/Yellow (Single Hole)	Black/Gray (Single Hole)
UL	IEC	Catalog No.	Catalog No.	Catalog No.	Catalog No.
10	12	VCF02	VBF02	VCD02	VBD02
16	20	VCF01	VBF01	VCD01	VBD01
20	25	VCF0	VBF0	VCD0	VBD0
20	32	VCF1	VBF1	VCD1	VBD1
25	40	VCF2	VBF2	VCD2	VBD2
45	63	VCF3	VBF3	—	—
63	80	VCF4	VBF4	—	—
100	125	VCF5	VBF5	—	—
115	175	VCF6	VBF6	—	—



**Table 8.7: NEMA Type 1 and 12 Assembled Switches for Rear Mounting**

Rating (A)		Complete Switches for Rear Mounting with Extension Shaft (3-Padlock) <sup>[3]</sup>		Switches with Handles Installed on Unit, DIN Rail Mount Only	
		Red/Yellow (Four Hole)	Red/Yellow (Single Hole)	Red/Yellow (1-Padlock)	Black/Gray (No-Padlock)
UL	IEC	Catalog No.	Catalog No.	Catalog No.	Catalog No.
10	12	VCCF02	VCCD02	—	—
16	20	VCCF01	VCCD01	—	—
20	25	VCCF0	VCCD0	VVE0	VVD0
20	32	VCCF1	VCCD1	VVE1	VVD1
25	40	VCCF2	VCCD2	VVE2	VVD2
45	63	VCCF3	—	VVE3	VVD3
63	80	VCCF4	—	VVE4	VVD4
100	125	VCCF5	—	—	—
115	175	VCCF6	—	—	—



**Vario Non-Metallic Enclosed Switches**

The Vario Motor Disconnect Switch is also offered as an enclosed switch. The three-pole version makes the Vario switch ideal for manual motor control applications. They are compact, easy to wire and connect, and come undrilled to allow cable entry positions.

**NOTE:** VC-GUN enclosures are UL approved.

**Table 8.8: Non-Metallic Enclosed Switch <sup>[4] [5]</sup>**

Ampere Size UL/IEC	IP55-PVC 3-Pole, NEMA Type 1 & 12	NEMA 4X Indoor	Hp Ratings			Catalog No.
			240 V	480 V	600 V	
20/32	X	—	5	10	10–15	VC1GUN
25/40	X	—	5–10	10–20	15–30	VC2GUN
45/63	X	—	10–15	20–30	30–40	VC3GUN
63/80	X	—	15	30	40	VC4GUN
100/125	X	X	25	50	50	VC5GUN
115/175	X	X	30	50	60	VC6GUN

**Table 8.9: Dimensions**

Type	No. of Poles	a	b	c	d	e	f
VC1GUN	3	6.5 (164)	4.8 (121)	3.4 (87)	5.6 (141)	3.9 (98)	5.2 (132)
VC2GUN							
VC3GUN							
VC4GUN	3	7.6 (193)	6.5 (164)	3.4 (87)	6.7 (170)	5.6 (141)	5.2 (132)
VC5GUN							
VC6GUN	3	11.5 (291)	9.5 (241)	5.0 (128)	10.6 (269)	8.6 (219)	7.5 (191)

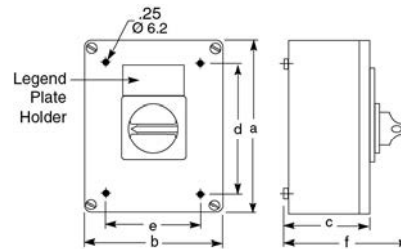

**VC-GUN**

[3] Complete switch includes handle operator, shaft, door interlock plate, and line terminal shroud.

[4] Assembled, includes switches mounted in enclosure with handle.

[5] Refer to Table 8.11 and Table 8.12 for horsepower ratings.



**Vario Metallic Enclosed Switches**

Vario switches meet UL508 requirements as both enclosed and open manual motor controllers. They are also marked "Suitable as Motor Disconnect" allowing installation on the load side of the motor branch circuit short-circuit and ground-fault protection. If motor branch circuit short-circuit and ground-fault protection is needed, use a GS1 or 9422 fusible switch or circuit breaker meeting NEC 430.52 requirements.

**Table 8.10: Metallic Enclosed Switches [6] [7]**

Rating (A)		Horsepower Ratings			NEMA Type 1	NEMA Type 12	NEMA Type 4/4X [7]
UL	IEC	240 V	480 V	600 V	Catalog No.	Catalog No.	Catalog No.
20	32	5	10	10	9421V1G30	9421V1A30	9421V1W30
25	40	5	10	15	9421V2G30	9421V2A30	9421V2W30

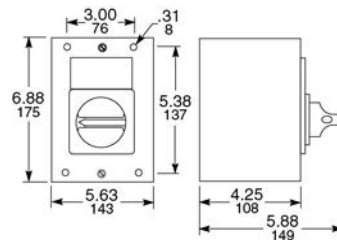

Class 9421 NEMA Type 1 V1G30, V2G30

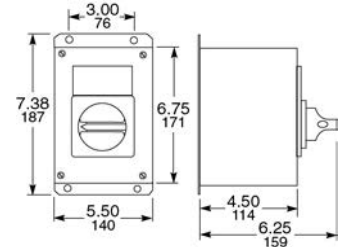

Class 9421 NEMA Type 4, 4X, 12 V1W30, V2W30, V1A30, V2A30

**Vario Manual Motor Control Switches**

The V1 and V2 come in metallic enclosures (NEMA Type 1, 4, 4X, and 12). The NEMA 1 enclosure comes with conduit knockouts top and bottom. To factory install a VZ7 auxiliary contact in these metallic enclosures, add Form X11 to the end of the catalog number (for example, 9421V1G30X11). To factory install a VZ20 auxiliary contact in these enclosures, add Form X20 to the end of the catalog number (for example, 9421V1W30X20).



Manual Motor Control Switch

**Table 8.11: Vario Manual Motor Control Switches, IEC**

Rating (A) IEC	kW Rating—3-Pole Switch Body					
	230 V	240 V	400 V	415 V	500 V	690 V
12	3	3	4	4	5.5	7.5
20	4	4	5.5	5.5	7.5	11
25	5.5	5.5	7.5	7.5	11	15
32	5.5	5.5	11	11	11	15
40	7.5	7.5	15	15	18.5	15
63	15	15	22	22	30	22
80	18.5	18.5	30	30	37	30
125	22	22	37	37	45	37
175	30	30	45	45	55	45

**Table 8.12: Vario Manual Motor Control Switches**

Rating (A)	Horsepower Rating			Shaft Size mm	3-Pole Switch Body Type
	240 V	480 V	600 V		
10	2	5	5	6	V02
16	3	7.5	7.5	6	V01
20	5	10	10	6	V0
20	5	10	10	6	V1
25	5	10	15	6	V2
45	10	20	30	8	V3
63	15	30	40	8	V4
100	25	50	50	8	V5
115	30	50	60	8	V6

**Table 8.13: Switch Body**

Rating (A)		Shaft Size mm	3-Pole Switch Body Type
UL	IEC		
10	12	6	V02
16	20	6	V01
20	25	6	V0
20	32	6	V1
25	40	6	V2
45	63	8	V3
63	80	8	V4
100	125	8	V5
115	175	8	V6

**NOTE:** Refer to Table 8.10 and Table 8.12 for horsepower ratings.

[6] Assembled, includes switches mounted in enclosure with handle.

[7] For indoor use only. The NEMA Type 4/4X enclosure is made of #304 stainless steel with 3/4 in. T&B stainless steel hubs on the top and bottom.



Single-Hole Operator



Four-Hole Operator (All except KDF3PZ and KBF3PZ)



Four-Hole Operator KDF3PZ and KBF3PZ



Low-Profile Handle KCD1YZ



KZ67

Table 8.14: NEMA Type 1 and 12 Handle Operators: V02–V2 (6 mm Shaft), V3–V6 (8 mm Shaft) [8]

Operator Type		Red/Yellow Single Hole 45 x 45 mm	Red/Yellow Four Hole 45 x 45 mm	Black/Gray Single Hole 45 x 45 mm	Black/Gray Four Hole 45 x 45 mm
Switches	No. of Padlocks	Catalog No.	Catalog No.	Catalog No.	Catalog No.
V02–V2	0	KCC1LZ	KCE1LZ	KAC1BZ	KAE1BZ
V02–V2	1	KCC1YZ	KCE1YZ	—	—
Operator Type		Red/Yellow Single Hole 60 x 60 mm	Red/Yellow Four Hole 60 x 60 mm	Black/Gray Single Hole 60 x 60 mm	Black/Gray Four Hole 60 x 60 mm
V02–V2	0	KDD1PZ	KDF1PZ	KBD1PZ	KBF1PZ
V3–V4	0	—	KDF2PZ	—	KBF2PZ
V02–V2	3	KCD1PZ	KCF1PZ	KAD1PZ	KAF1PZ
V3–V4	3	—	KCF2PZ	—	KAF2PZ
Operator Type		Red/Yellow Four Hole 90 x 90 mm	Black/Gray Four Hole 90 x 90 mm		
V5–V6	0	KDF3PZ	KBF3PZ		
V5–V6	3	KCF3PZ	KAF3PZ		

Table 8.15: Low Profile Handle Operators [8]

Operator Type		Red/Yellow Single Hole 60 x 60 mm	Red/Yellow Four Hole 60 x 60 mm	Black/Gray Single Hole 60 x 60	Black/Gray Four Hole 60 x 60 mm
Switches	No. of Padlocks	Catalog No.	Catalog No.	Catalog No.	Catalog No.
V02–V2	3	KCD1YZ	KCF1YZ	KADIXZ	KAF1XZ
V3–V4	3	—	KCF2YZ	—	KAF2XZ
Operator Type		Red/Yellow Four Hole 90 x 90 mm	Black/Gray Four Hole 90 x 90 mm		
V5–V6	3	KCG2YZ	KAG2XZ		

Table 8.16: Gasket Kits

Catalog No.	Description
KZ65	45 x 45 mm gasket for V02-V2 for 4-hole type handles (order in quantities of 5)—IP65
KZ66	60 x 60 mm gasket for V02-V2 for 4-hole type handles (order in quantities of 5)—IP65
KZ62	60 x 60 mm gasket for V3-V4 for 4-hole type handles (order in quantities of 5)—IP65
KZ67	90 x 90 mm gasket for V5-V6 for 4-hole type handles (order in quantities of 5)—IP65

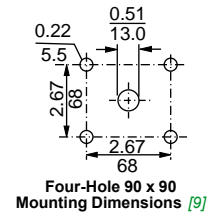
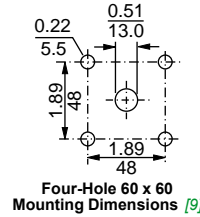
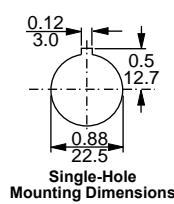
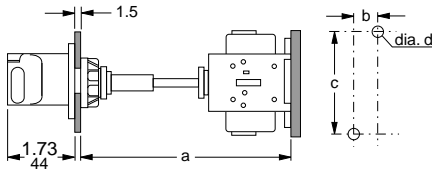

Table 8.17: Rear/Panel Mounting Switch Body Dimensions

Type	Shaft Extension	Dimensions							
		a		b		c		d	
		in.	mm	in.	mm	in.	mm	in.	mm
V02 to V2	VZ17	5.5–13.0	140–330	0.60	15	2.4	60	0.17	4.2
	VZ30	5.5–16.9	140–430						
V3 to V4	VZ18	5.5–12.6	140–320	0.79	20	2.4	60	0.20	5.2
	VZ31	5.5–16.5	140–420						
V5 to V6	VZ18	6.5–13.8	165–350	1.20	30	3.9	100	0.28	7.0
	VZ31	6.5–17.7	165–450						



[8] When using these handles for replacements on the non-metallic enclosed switches, the handle shaft that comes with the enclosure must be reused. See Section 15 of the Supplemental Digest.

[9] The door interlock plate included with VCC Kits has the same drilling as the handle operators.

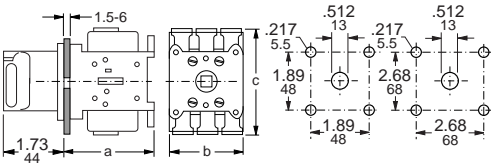

**Mini-Vario and Vario™ Accessories**

**Table 8.18: Door Mounting Switch Body Dimensions**

Switch Type	Dimensions						Weight Approx. lbs.
	a		b		c		
	in.	mm	in.	mm	in.	mm	
V02 to V2 [10]	2.83	72	2.17	55	2.91	74	0.44
V02 to V2	2.36	60	2.17	55	2.91	74	0.44
V3 to V4	2.56	65	2.36	60	3.27	83	1.10
V5 to V6	3.54	90	3.54	90	4.92	125	2.00

**Table 8.19: Shaft Extension and Door Interlock**

Switch Type	Maximum Panel Depth		Shaft Extension Kit	Door Interlock Plate	Door Mounting Plate
	in.	mm			
V02 to V2	13.0	330	VZ17	KZ32	KZ83
V3, V4	12.6	320	VZ18	KZ74	KZ81
V5, V6	13.8	351	VZ18	KZ74	KZ81
V02 to V2	16.9	429	VZ30	KZ32	KZ83
V3, V4	16.5	419	VZ31	KZ74	KZ81
V5, V6	17.7	450	VZ31	KZ74	KZ81

**Table 8.20: Accessories**

Switch Type	Line Side Terminal Shroud For Main Switch	Terminal Shroud for Add-on Power Pole	Terminal Shroud for Auxiliary Contact
V02 to V2	VZ8	VZ26	VZ29
V3, V4	VZ9	VZ27	VZ29
V5, V6	VZ10	VZ28	VZ29

**Table 8.21: Add-On Contact Modules**

Switch Type	Main Pole Module	Main Pole	Ampere Rating UL/IEC	Auxiliary Contacts Rated UL/IEC 10/12 A	
				1 N.O., 1 N.C.	2 N.O.
V02	VZ02	VZ02	10/12	VZ7 Early Break, Late Make	VZ20
V01	VZ01	VZ01	16/20		
V0	VZ0	VZ0	20/25		
V1	VZ1	VZ1	20/32		
V2	VZ2	VZ2	25/40		
V3	VZ3	VZ3	45/63		
V4	VZ4	VZ4	63/80		
V5	—	—	—		
V6	—	—	—		

**Table 8.22: Add-On Contact Modules**

Switch Type	Neutral Modules Early Make/Late Break	Grounding Module	Auxiliary Contacts	
	Catalog No.	Catalog No.	Catalog No.	Description
V02-V2	VZ11	VZ14	VZ7	1 Late Make, N.O. & 1 Early Break, N.C.
V3-V4	VZ12	VZ15	VZ20	2 N.O. Contacts
V5-V6	VZ13	VZ16	—	—

**Table 8.23: Labeling Accessories**

Nameplate Holder with Nameplate		Nameplate Holder Only	Nameplate Only	
Size	Catalog No.	Catalog No.	Use With	Catalog No.
45 x 45 mm	KZ13	KZ14	KZ14	KZ76
60 x 60 mm	KZ15	KZ16	KZ16	KZ77
90 x 90 mm	KZ103	KZ101	KZ1010	KZ100

**Table 8.24: Shrouds**

Switch Type	3-Pole Shroud	Single-Pole Shroud	
	Catalog No.	For Add-On Power Pole	Catalog No.
V02-V2	VZ8	VZ02-VZ2, VZ11, & VZ14	VZ26
V3-V4	VZ9	VZ23, VZ4, VZ12, & VZ15	VZ27
V5-V6	VZ10	VZ13 & VZ16	VZ28
—	—	For 2-Pole Aux. Contact	VZ29

**Table 8.25: Main Pole Module Dimensions**

Switch Type	Dimensions						Weight Approx. lbs.
	a		b		c		
	in.	mm	in.	mm	in.	mm	
V02 to VZ2	0.63	16	2.9	74	1.38	35	0.10
VZ3 to VZ4	0.79	20	3.3	83	1.80	46	0.22

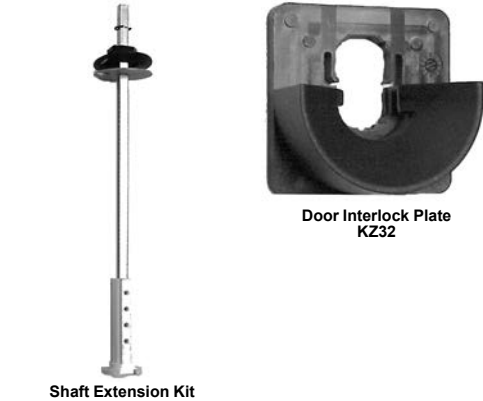

Door Interlock Plate KZ32

Shaft Extension Kit



Add-On Contact Module



Terminal Shroud for Main Switch VZ8



Terminal Shroud for Auxiliary Contact VZ29

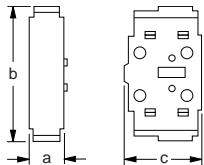

Main Pole Module

[10] Dimensions for single-hole mounting.



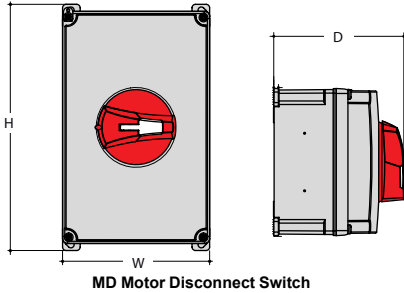

MD Motor Disconnect Switch

### MD Motor Disconnect Switches

The MD motor disconnect switch is listed UL 508 Suitable for Motor Control (UL File E164864) and conforms to IEC standard 60947-3. It is in a compact NEMA 4X enclosure suitable for use in NEMA 1, 3, 3R, 4, 4X, and 12 applications. The MD's key benefits are an extremely small footprint, a more economically efficient NEMA 4X solution, and a handle interlock preventing cover removal when the switch is in the ON position.

Switch features:

- Suitable for NEMA 1, 3R, 4, 4X, and 12 enclosure applications.
- Complies with OSHA lockout/tagout requirements—accepts up to three 8 mm padlocks.
- For accessories, see [Table 8.20](#).

**Table 8.26: MD Motor Disconnect Switch—Non-Metallic NEMA 1, 3, 3R, 4, 4X, and 12 Enclosure**

Amperes	Cat. No.	Maximum Horsepower Ratings			Height (in.)	Width (in.)	Depth (in.)
		Three-Phase Vac					
		220–240	440–480	600			
30	MD3304X	7.5	20	25	6.38	3.9	4.37
60	MD3604X	20	40	40	8.27	4.94	4.37

**Table 8.27: MD Motor Disconnect Accessories**

Cat. No.	Description
MDSAN20	2 N.O. auxiliary contact module
MDSAN11	1 N.O. and 1 N.C. auxiliary contact module
MDS30P	30 A add on power pole

*New!* **Disconnect Switches, 16–125 A**

Style	DIN Rail, Rear Mounting								Door Mounting								
	36 mm (1.42 in.)				70 mm (2.75 in.)				36 mm (1.42 in.)				70 mm (2.75 in.)				
<ul style="list-style-type: none"> <li>• Versions: DIN rail mounting, door mounting, and rear mounting</li> <li>• Wide range of accessories</li> <li>• Changeover switches</li> <li>• Conforming to UL 60947-4-1 (16–63 A) or UL 98 (63–125 A) specifications</li> </ul>																	
Ampere rating	16	25	32	40	63	63	80	100	125	16	25	32	40	63	80	100	125
Three pole	•	•	•	•	•	•	•	•	•	•	•	•	•	•	•	•	•
4th pole—simultaneous closing	•	•	•	•	•	•	•	•	•	•	•	•	•	•	•	•	•
4th pole—early-make closing	•	•	•	•	•	•	•	•	•	•	•	•	•	•	•	•	•
Fuse holder	•	•	•														
Mechanical 6-8 pole coupling system	•	•	•	•	•	•	•	•	•								
Mechanical interlock for line switching	•	•	•	•	•	•	•	•	•								

**Interpreting the Catalog Number**

Some combinations are not available. Use this table only for interpreting the catalog number.

**Table 8.28: Interpreting the Catalog Number**

<b>Example</b>	<b>VLS</b>	<b>3P</b>	<b>016</b>	<b>R</b>	<b>1</b>	
Description	Disconnect switch	1P = 1 pole 3P = 3 poles	016 = 16 A 025 = 25 A 032 = 32 A 040 = 40 A	063 = 63 A 080 = 80 A 100 = 100 A 125 = 125 A	D = Door mounting R = DIN rail mounting	1 = Small size (16–63 A), UL 508 2 = Large size (63–125 A), UL 98
<b>Example</b>	<b>VLSH</b>	<b>2</b>	<b>S</b>	<b>5</b>	<b>R</b>	
Description	Rotary handle	1 = Recessed, 65 x 65 mm 2 = Protruding, 65 x 65 mm 3 = Pistol grip, 75 mm dia. 4 = Protruding, 48 x 48 mm	H = Hole fixing S = Screw mounting	5 = 5 mm shaft opening 7 = 7 mm shaft opening	B = Black BC = Black, changeover BD = Black, defeatable R = Red RD = Red, defeatable	
<b>Example</b>	<b>VLSS</b>	<b>150</b>	<b>5</b>			
Description	Shafts	Length: 150–500 mm	Cross-section: 5 = 5 mm 7 = 7 mm			
<b>Example</b>	<b>VLS</b>	<b>1P</b>	<b>040</b>	<b>R</b>	<b>1</b>	<b>S</b>
Description	Additional Poles	Number of Poles: 1P = 1 Pole	Current: 016 = 16 A to 125 = 125 A	Mounting: R = DIN rail mounted D = Door mounted	Body Size: 1 = Small size (16–63 A) 2 = Large size (63–125 A)	Closing: S = Simultaneous closing E = Early Make closing
<b>Example</b>	<b>VLS</b>	<b>1N</b>	<b>R</b>			<b>1</b>
Description	Ground and Neutral Terminals	1G = 1 Pole Ground terminal 1N = 1 Pole Neutral terminal	R = DIN rail mounted D = Door mounted			1 = Small size (16–63 A), UL 508 2 = Large size (63–125 A), UL 98
<b>Example</b>	<b>VLS</b>	<b>A</b>	<b>11</b>	<b>R</b>	<b>1</b>	<b>S</b>
Description	Auxiliary contacts	A = Auxiliary contact	10 = 1 N.O. 11 = 1 N.O. + 1 N.C.	R = DIN rail mounted D = Door mounted	Blank = Size 1 and 2 1 = Size 1 2 = Size 2	S = Simultaneous closing E = Early make closing



VLS3P016R1–  
VLS3P063R1



**Product Overview**

**Compact Size**

The three-pole 16–63 A disconnect switches are made up of a single unit body, a mere 36 mm (1.4 in.) wide, while those rated 63–125 A are only 70 mm (2.8 in.) wide.

**Accessory Flexibility**

Mounting and removal of the fourth pole and add-on blocks are simple and quick operations with no need for tools.

**Certifications**

All VLS disconnect switches are certified by cCSAus and are UL Listed for Canada and USA:

- 16–63 A types: certified according to UL 60947-4-1 / CSA 22.2 n° 60947-4-1-14 standards
- 63–125 A types: certified according to UL 98 / CSA 22.2 n° 4 standards

**Three-Pole Disconnect Switches**

**Table 8.29: Certifications and Compliance (● = certification obtained)**

Catalog number	cULus per UL 60947-4-1 / CSA C22.2 n° 60947-4-1-14 UL Listed (File E487906)	cULus per UL 98 / CSA C22.2 n° 4 UL Listed (File E487907)	IEC/EN 60947-1, IEC/EN 60947-3
VLS3P016R1– VLS3P040R1	●	—	Compliant
VLS3P063R1	●	—	
VLS3P016D1– VLS3P040D1	●	—	
VLS3P063R2– VLS3P125R2	—	●	
VLS3P063D2– VLS3P125D2	—	●	



VLS3P063R2–  
VLS3P125R2



VLS3P016D1–  
VLS3P040D1



VLS3P063D2–  
VLS3P125D2

**Table 8.30: Selection—Three-Pole Disconnect Switches**

Catalog number	IEC conventional free air thermal current (I <sub>th</sub> ), AC21A (≤690 V) (A)	IEC rated operational current (I <sub>e</sub> ) AC22A (≤690 V), AC23A (≤415 V) (A)	UL general use at 600 Vac (A)
DIN rail mounting version, complete with black handle. For rear-mounting version, separately purchase the handle and shaft extension. Refer to page 8-16 and page 8-18.			
VLS3P016R1	16	16	16
VLS3P025R1	25	25	25
VLS3P032R1	32	32	32
VLS3P040R1	40	40	40
VLS3P063R1	63	45	60
VLS3P063R2	63	63	60
VLS3P080R2	80	80	100
VLS3P100R2	100	100	100
VLS3P125R2	125	125	100
Door-mounting version (no shaft required). Separately purchase the handle. Refer to page 8-16.			
VLS3P016D1	16	16	16
VLS3P025D1	25	25	25
VLS3P032D1	32	32	32
VLS3P040D1	40	40	40
VLS3P063D2	63	63	60
VLS3P080D2	80	80	100
VLS3P100D2	100	100	100
VLS3P125D2	125	125	100

Strokes of VLS switch poles

	Travel 0 → 1	0°	30°	60°	90°
VLS3P016R1–VLS3P063R1				60°	
VLS3P016D1–VLS3P040D1				60°	
VLS3P063R2–VLS3P125R2			55°		
VLS3P063D2–VLS3P125D2			55°		
	Off				On

**Table 8.31: UL / CSA Ratings**

Catalog number	Horsepower						General use at 600 Vac (A)	Short-circuit rating at 600 Vac (kA)	Max. fuse rating at 600 V (A)
	1 phase		3 phase						
	120 V	240 V	200–208 V	240 V	480 V	600 V			
UL 60947-4-1 and CSA 22.2 n° 60947-4-1-14 [1]									
VLS3P016**	1	2	5	5	10	10	16	5	30 (Type RK5)
VLS3P025**	1.5	3	7.5	7.5	15	20	25	5	30 (Type RK5)
VLS3P032**	2	5	10	10	20	20	32	5	45 (Type RK5)
VLS3P040**	2	5	10	15	20	25	40	5	45 (Type RK5)
VLS3P063R1	2	7.5	10	15	30	30	60	5	45 (Type RK5)
UL 98 and CSA C22.2 n° 4 [2]									
VLS3P063**	3	7.5	20 [3]	20	40	40	60	50	60
VLS3P080**	3	10	25 [3]	25	40	40	100	50	100
VLS3P100**	5	10	30 [3]	30	50	50	100	50	100
VLS3P125**	7.5	10	30 [3]	30	60	60	100	50	100

[1] Ratings are valid for VLS3P\*\*\*R\* and VLS3P\*\*\*D\* types, according to UL 60947-4-1 and CSA 22.2 n° 60947-4-1-14. UL Listed for USA and Canada (cULus - File E487907) as Manual Motor Controllers, while the UL designation is "General Purpose Switch. Interrupteur Usage General" and "Suitable As Motor Disconnect."

[2] Ratings are valid for VLS3P\*\*\*R\* and VLS3P\*\*\*D\* types, according to UL 98 and CSA C22.2 n° 4. UL Listed for USA and Canada (cULus - File E487907) as Open Type Switches – Open type unfused switch, while UL designation is "General Purpose Switch. Interrupteur Usage General."

[3] Voltage value is not considered in UL98 / CSA 22.2 n° 4 standards, and so is not indicated in the UL product marking.



VLS1P\*\*\*R•S  
VLS1P\*\*\*R•E



VLS1P040D1S  
VLS1P040D1E

Strokes of VLS poles (switch and add-on pole)

	Travel 0→1			
	0°	30°	60°	90°
VLS3P016R1/D1–VLS3P040R1/D1, VLS3P063R1 Main poles			60°	
VLS1P040R1S–VLS1P063R1S Simultaneous fourth-pole add on			60°	
VLS1P040R1E/D1E, VLS1P063R1E Early-make fourth-pole add on			55°	
VLS3P063R2/D2–VLS3P125R2/D2 Main poles			55°	
VLS1P063R2S/D2S–VLS1P125R2S/D2S Simultaneous fourth-pole add on			55°	
VLS1P125R2E/D2E Early-make fourth-pole add on			48°	

Off On

### Fourth Pole Add-on

Table 8.32: General Specifications—Fourth Pole Add-on

IEC ampere ratings	16–125 A
Available versions	DIN rail mounting Door mounting Simultaneous closing with switch poles Early-make closing with respect to switch poles
Size	Compact and modular

Table 8.33: Selection—Fourth Pole Add-on

Catalog number	IEC conventional free air thermal current Ith AC21A (≤690V) (A)	IEC rated operational current Ie AC22A (≤690V), AC23A (≤415V) (A)
Simultaneous closing operation with respect to switch poles		
DIN Rail Mounting (VLS3P***R•)		
VLS1P040R1S [4]	40	40
VLS1P063R1S [5]	63	45
VLS1P063R2S	63	63
VLS1P080R2S	80	80
VLS1P100R2S	100	100
VLS1P125R2S	125	125
Door Mounting (VLS3P***D•)		
VLS1P040D1S [6]	40	40
VLS1P063D2S	63	63
VLS1P080D2S	80	80
VLS1P100D2S	100	100
VLS1P125D2S	125	125
Early-make closing operation with respect to switch poles		
DIN Rail Mounting (VLS3P***R•)		
VLS1P040R1E [4]	40	40
VLS1P063R1E [6]	63	45
VLS1P125R2E [7]	125	125
Door Mounting (VLS3P***D•)		
VLS1P040D1E [6]	40	40
VLS1P125D2E [8]	125	125

**NOTE:** For Fourth Pole UL / CSA ratings, see page 8-10—they are the same as the ratings for the corresponding single-phase contact switch.

Table 8.34: Certifications and Compliance for Fourth Pole Add-on Blocks (• = certification obtained)

Catalog number	Certification Standard		IEC/EN 60947-1, IEC/EN 60947-3
	cULus per UL 60947-4-1 / CSA C22.2 n° 60947-4-1-14 / UL Listed (File E487906)	cULus per UL 98 / CSA C22.2 n° 4 / UL Listed (File E487907)	
VLS1P040R1E, VLS1P040R1S	•	—	Compliant
VLS1P063R1E, VLS1P063R1S	•	—	
VLS1P040D1E, VLS1P040D1S	•	—	
VLS1P125R2E, VLS1P125D2E	—	•	
VLS1P063R2S–VLS1P125R2S	—	•	
VLS1P063D2S–VLS1P125D2S	—	•	

[4] For VLS3P016R1–040R1 only.  
 [5] For VLS3P063R1 only.  
 [6] For VLS3P016D1–040D1 only.  
 [7] For VLS3P063R2–125R2 only.  
 [8] For VLS3P063D2–125D2 only.

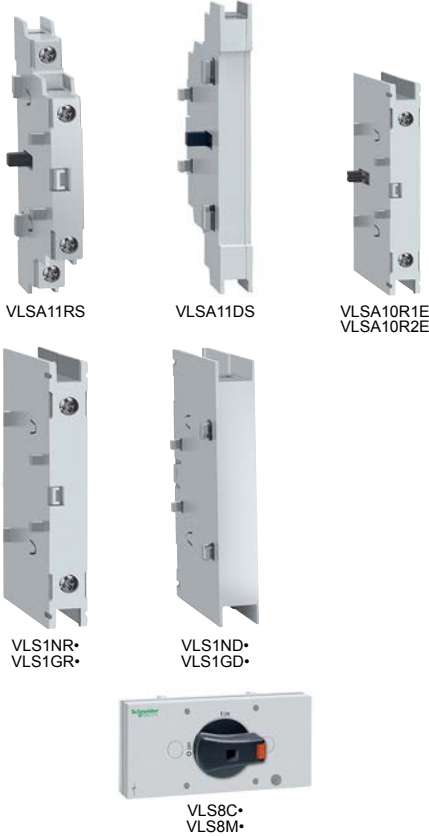

**Add-on Blocks**

**Table 8.35: Operational Specifications**

Auxiliary contacts		
IEC conventional free air thermal current (Ith)	10 A	
UL/CSA and IEC/EN 60947-5-1 designation	A600-Q600	
Tightening torque	0.8 N•m (7.1 lb-in.)	
Other devices		
Tightening torque	VLS1NR1/D1, VLS1GR1/D1 terminals	1.8–2 N•m (16–18 lb-in)
	VLS1NR2/D2, VLS1GR2/D2 terminals	5–6 N•m (45–54 lb-in)
	VLS8C1/C2, VLS8M1/M2	mounting: 0.5 N•m (4.4 lb-in) extension with handle: 0.8 N•m (7.1 lb-in)

**Table 8.36: Selection—Add-on Blocks**

Catalog number	Specifications
Auxiliary contacts, simultaneous operation with respect to switch poles	
VLSA11RS	1NO+1NC for VLS3P***R* and VLS3P063R1
VLSA11DS	1NO+1NC for VLS3P***D*
Auxiliary contacts, early-break operation with respect to switch poles	
VLSA10R1E	1EB (NO) for VLS3P016R1–VLS3P040R1, VLS3P063R1
VLSA10R2E	1EB (NO) for VLS3P063R2–VLS3P125R2
Neutral terminal	
VLS1NR1	For VLS3P016R1–VLS3P040R1, VLS3P063R1
VLS1NR2	For VLS3P063R2–VLS3P125R2
VLS1ND1	For VLS3P016D1–VLS3P040D1
VLS1ND2	For VLS3P063D2–VLS3P125D2
Earth/Ground terminal	
VLS1GR1	For VLS3P016R1–VLS3P040R1, VLS3P063R1
VLS1GR2	For VLS3P063R2–VLS3P125R2
VLS1GD1	For VLS3P016D1–VLS3P040D1
VLS1GD2	For VLS3P063D2–VLS3P125D2
Mechanical interlock for line changeover (I-0-II)	
VLS8C1	For VLS3P016R1–VLS3P040R1, VLS3P063R1, and VLSH2S5BC: □ 5 mm (0.2 in.) [9]
VLS8C2	For VLS3P063R2–VLS3P125R2 and VLSH2S5BC: □ 5 mm (0.2 in.) [9]
Mechanical coupling system for 6-8 pole disconnect switches	
VLS8M1	For VLS3P016R1–VLS3P040R1 and VLS3P063R1: □ 5 mm (0.2 in.) [9]
VLS8M2	For VLS3P063R2–VLS3P125R2: □ 7 mm (0.3 in.) [10]

Strokes of VLS poles (switch with auxiliary contact blocks)

	Travel 0 → 1	0°	30°	60°	90°
VLS3P016R1/D1, VLS3P040R1/D1, VLS3P063R1				60°	
Main poles					
VLSA11RS/DS				60°	
Auxiliary contacts (1 NO + 1 NC)	NO				
	NC				
		40°			
VLSA10R1E		Travel 0 → 1	60°		
Auxiliary contact					
(1EB – NO early break)		Travel 1 → 0	70°		
VLS3P063R2/D2...VLS3P125R2/D2				55°	
Main poles					
VLSA11RS/DS				45°	
Auxiliary contacts (1 NO + 1 NC)	NO				
	NC				
		25°			
VLSA10R2E		Travel 0 → 1	55°		
Auxiliary contact					
(1EB – NO early break)		Travel 1 → 0	65°		
	Off				On

[9] Use VLSS shaft extensions.

[10] Use VLSH3S7RD handles and VLSS\*\*\*7 extensions for a rear-mounting version.

**Sequence and Maximum Combination of Add-on Blocks  
DIN Rail Mounting Disconnect Switches**

**Table 8.37: VLS3P016R1–VLS3P040R1 (DIN Rail Mounting)**

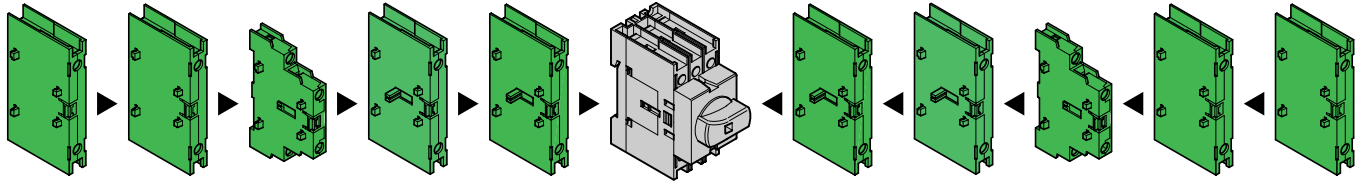

VLS1NR1	VLS1GR1	VLSA11RS	VLSA10R1E	VLS1P040R1E VLS1P040R1S	VLS3P016R1 VLS3P025R1 VLS3P032R1 VLS3P040R1	VLS1P040R1E VLS1P040R1S	VLSA10R1E	VLSA11RS	VLS1GR1	VLS1NR1	
1	1	1	—	1		—	—	2	1	1	
1	1	2	—	—		—	—	1	1	1	1
1	1	1	—	1		—	1	1	1	1	1
1	1	1	1	—		—	1	—	1	1	1
1	1	1	1	—		—	—	—	2	1	1
1	1	2	—	—		—	—	1	1	1	1
1	1	2	—	—		—	—	—	2	1	1
1	1	—	—	—		—	—	—	—	1	1
1	1	—	—	1		—	—	—	—	1	1
1	1	—	—	—		—	—	—	—	1	1
1	1	—	—	—		—	—	—	—	1	1
1	1	—	—	—		—	—	—	—	1	1

**Table 8.38: VLS3P063R1 (DIN Rail Mounting)**

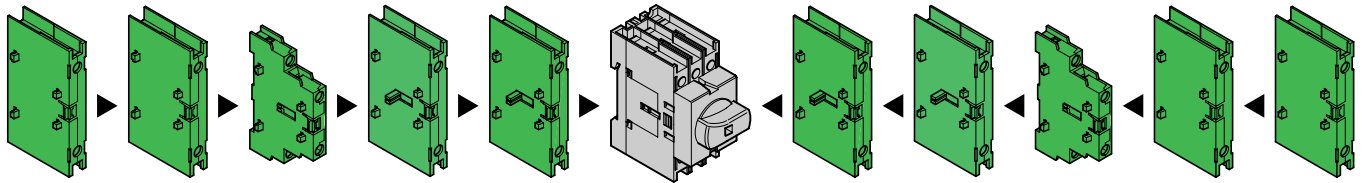

VLS1NR1	VLS1GR1	VLSA11RS	VLSA10R1E	VLS1P063R1E VLS1P063R1S	VLS3P063R1	VLS1P063R1E VLS1P063R1S	VLSA10R1E	VLSA11RS	VLS1GR1	VLS1NR1	
1	1	1	—	1		—	—	2	1	1	
1	1	2	—	—		—	1	—	1	1	1
1	1	1	—	1		—	—	1	1	1	1
1	1	1	1	—		—	1	—	1	1	1
1	1	1	1	—		—	—	—	2	1	1
1	1	2	—	—		—	—	1	1	1	1
1	1	2	—	—		—	—	—	2	1	1
1	1	—	—	—		—	—	—	—	1	1
1	1	—	—	1		—	—	—	—	1	1
1	1	—	—	—		—	—	—	—	1	1
1	1	—	—	—		—	—	—	—	1	1
1	1	—	—	—		—	—	—	—	1	1

**Table 8.39: VLS3P063R2–VLS3P125R2 (DIN Rail Mounting)**

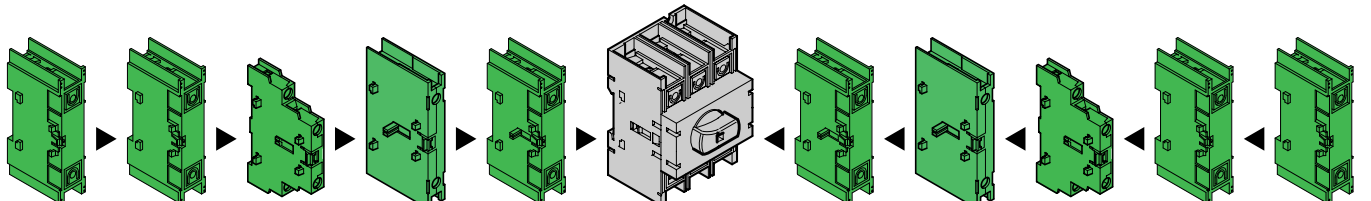

VLS1NR2	VLS1GR2	VLSA11RS	VLSA10R2E	VLS1P125R2E VLS1P***R•S	VLS3P063R2 VLS3P080R2 VLS3P100R2 VLS3P125R2	VLS1P125R2E VLS1P***R•S	VLSA10R2E	VLSA11RS	VLS1GR2	VLS1NR2	
—	—	1	—	1		—	—	2	—	—	
—	—	2	—	—		—	1	—	1	—	—
—	—	1	—	1		—	—	1	1	—	—
—	—	1	1	—		—	1	—	1	—	—
—	—	1	1	—		—	—	—	2	—	—
—	—	2	—	—		—	—	1	1	—	—
—	—	2	—	—		—	—	—	2	—	—
1	1	—	—	—		—	—	—	—	1	1
1	1	—	—	1		—	—	—	—	1	1
1	1	—	—	—		—	—	—	—	1	1
1	1	—	—	—		—	—	—	—	1	1
1	1	—	—	—		—	—	—	—	1	1

Door Mounting Disconnect Switches

Table 8.40: VLS3P016D1–VLS3P040D1 (Door Mounting)

VLS1ND1	VLS1GD1	VLSA11DS	VLS1P040D1E VLS1P040D1S	VLS3P016D1 VLS3P025D1 VLS3P032D1 VLS3P040D1	VLS1P040D1E VLS1P040D1S	VLSA11DS	VLS1GD1	VLS1ND1
1	1	1	1					1
1	1	1	—		1	1	1	1
1	1	—	1		—	1	1	1
1	1	1	—		1	—	1	1
1	1	1	—		—	1	1	1
1	1	—	—		—	1	1	1
1	1	—	—		—	—	1	1

Table 8.41: VLS3P063D2–VLS3P125D2 (Door Mounting)

VLS1ND2	VLS1GD2	VLSA11DS	VLS1P125D2E VLS1P125D2S	VLS3P063D2 VLS3P080D2 VLS3P100D2 VLS3P125D2	VLS1P125D2E VLS1P125D2S	VLSA11DS	VLS1GD2	VLS1ND2
—	—	1	1		—	1	—	—
—	—	1	—		1	—	—	—
1	1	—	1		—	1	—	—
—	—	1	—		1	—	1	1
—	—	1	—		—	1	—	—
1	1	—	—		—	—	1	1

**Mechanical Coupling and Mechanical Interlock for Line Changeover**

**Table 8.42: VLS3P016R1–VLS3P040R1, VLS8C1–VLS8M1 (Rear Mounting)**

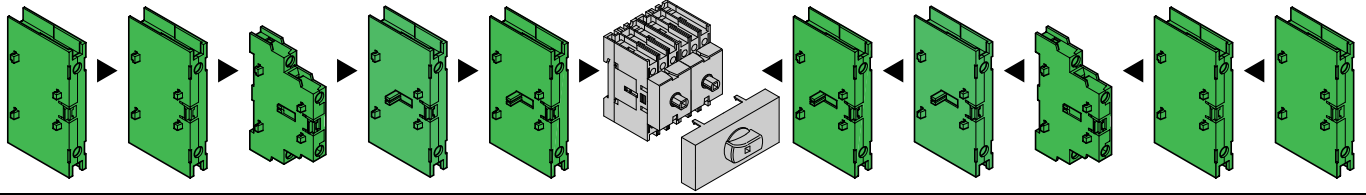

VLS1NR1	VLS1GR1	VLSA11RS	VLSA10R1E	VLS1P040R1E VLS1P040R1S	VLS8C1–VLS8M1	VLS1P040R1E VLS1P040R1S	VLSA10R1E	VLSA11RS	VLS1GR1	VLS1NR1
1	1	1	—	1	VLS3P016R1 +	1	—	1	1	1
1	1	1	—	1	VLS3P016R1	—	—	2	1	1
1	1	2	—	—	VLS3P025R1 +	1	—	1	1	1
1	1	1	—	1	VLS3P025R1	—	1	1	1	1
1	1	1	1	—	VLS3P032R1 +	1	—	1	1	1
1	1	1	1	—	VLS3P032R1	—	1	1	1	1
1	1	1	—	—	VLS3P040R1 +	—	—	2	1	1
1	1	2	—	—	VLS3P040R1	—	1	1	1	1
1	1	2	—	—	—	—	—	2	1	1
1	1	—	—	1	—	1	—	—	1	1
1	1	—	—	—	—	—	—	—	1	1
1	1	—	—	—	—	—	—	—	1	1

**Table 8.43: VLS3P063R1 + VLS8C1–VLS8M1 (Rear Mounting)**

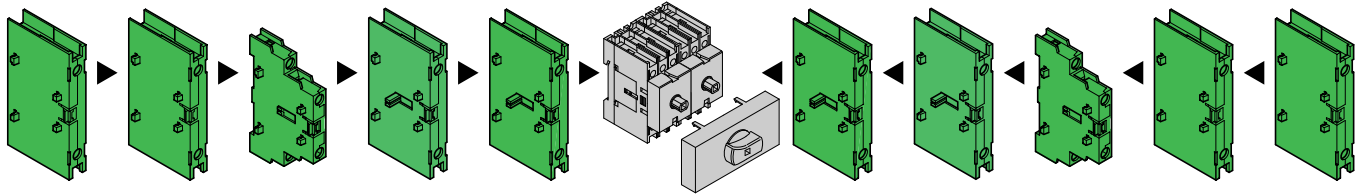

VLS1NR1	VLS1GR1	VLSA11RS	VLSA10R1E	VLS1P063R1E VLS1P063R1S	VLS8C1– VLS8M1	VLS1P063R1E VLS1P063R1S	VLSA10R1E	VLSA11RS	VLS1GR1	VLS1NR1
1	1	1	—	1	VLS3P063R1 +	1	—	1	1	1
1	1	1	—	1	VLS3P063R1	—	—	2	1	1
1	1	2	—	—	—	1	—	1	1	1
1	1	1	—	1	—	—	1	1	1	1
1	1	1	1	—	—	1	—	1	1	1
1	1	1	1	—	—	—	—	2	1	1
1	1	2	—	—	—	—	1	1	1	1
1	1	2	—	—	—	—	—	2	1	1
1	1	—	—	1	—	1	—	—	1	1
1	1	—	—	—	—	—	—	—	1	1

**Table 8.44: VLS3P063R2–VLS3P125R2 + VLS8C2–VLS8M2 (Rear Mounting)**

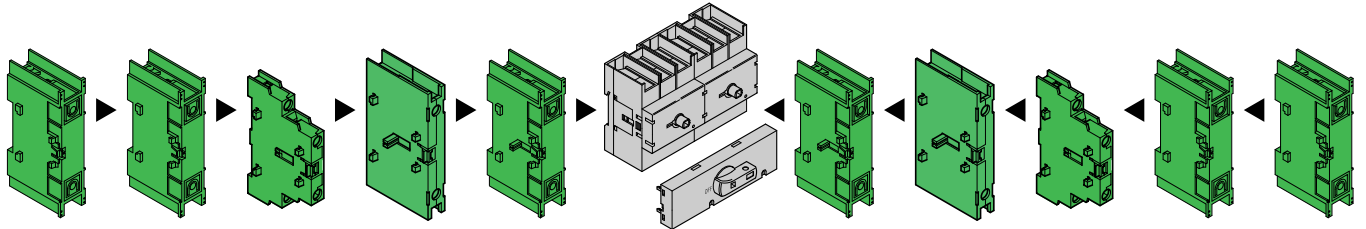

VLS1NR2	VLS1GR2	VLSA11RS	VLSA10R2E	VLS1P125R2E VLS1P***R-S	VLS8C2 - VLS8M2	VLS1P125R2E VLS1P***R-S	VLSA10R2E	VLSA11RS	VLS1GR2	VLS1NR2
—	—	1	—	1	VLS3P063R2 +	1	—	1	—	—
—	—	1	—	1	VLS3P063R2	—	—	2	—	—
—	—	2	—	—	VLS3P080R2 +	1	—	1	—	—
—	—	1	—	1	VLS3P080R2	—	1	1	—	—
—	—	1	1	—	VLS3P100R2 +	1	—	1	—	—
—	—	1	1	—	VLS3P100R2	—	—	2	—	—
—	—	2	—	—	VLS3P125R2 +	—	1	1	—	—
—	—	2	—	—	VLS3P125R2	—	—	2	—	—
1	1	—	—	1	—	1	—	—	1	1
1	1	—	—	—	—	—	—	—	1	1



Refer to Catalog 9400CT1601



Rotary Handles

Table 8.45: Selection—Rotary Handles (NEMA 1, 12, 3R, 4, and 4X. IEC IP65 unless otherwise specified)

Catalog number	Specifications
<b>Door Mounting and Rear Mounting Handles, Padlock-ready<sup>[11]</sup></b>	
<b>Red/yellow, rotating</b>	
VLSH1S5R	For VLS3P***R and VLS3P***D. Screw mounting. Recessed selector. □ 5 mm (0.2 in.). <sup>[12]</sup>
VLSH2S5R	For VLS3P***R and VLS3P***D. Screw mounting. Protruding selector. □ 5 mm (0.2 in.). <sup>[12]</sup>
VLSH2H5R	For VLS3P***R and VLS3P016D1–VLS3P040D1. Ring mounting. Protruding selector. □ 5 mm (0.2 in.). <sup>[12] [13]</sup>
VLSH2H5RD	For VLS3P***R. Ring mounting. Protruding selector with release, defeatable per UL60947-4-1; □ 5 mm (0.2 in.). <sup>[12]</sup>
VLSH2H5RL	For VLS3P***R, VLS3P063R1, VLS3P016D1–VLS3P040D1. Ring mounting. Low-profile protruding selector, □ 5 mm (0.2 in.).
VLSH3S7RD	For VLS3P063R2–VLS3P125R2, and VLS8M2. Screw mounting. Pistol grip with release, defeatable per 60947-4-1; □ 7 mm (0.3 in.). IEC IP66. <sup>[14]</sup>
VLSH4S5R	For For VLS3P***R and VLS3P***D. Screw mounting. Protruding selector. 48 mm square. □ 5 mm (0.2 in.). <sup>[12]</sup>
<b>Black, rotating</b>	
VLSH1S5B	For VLS3P***R and VLS3P***D. Screw mounting. Recessed selector. □ 5 mm (0.2 in.). <sup>[12]</sup>
VLSH2S5B	For VLS3P***R and VLS3P***D. Screw mounting. Protruding selector. □ 5 mm (0.2 in.). <sup>[12]</sup>
VLSH2H5B	For VLS3P***R, VLS3P063R1, VLS3P016D1–VLS3P040D1. Ring mounting. Protruding selector. □ 5 mm (0.2 in.). <sup>[12] [13]</sup>
VLSH2H5BD	For VLS3P***R. Ring mounting. Protruding selector with release, defeatable per 60947-4-1. □ 5 mm (0.2 in.). <sup>[12]</sup>
VLSH2H5BL	For VLS3P***R, VLS3P063R1, VLS3P016D1–VLS3P040D1. Ring mounting. Low profile protruding selector, □ 5 mm (0.2 in.).
VLSH2H5BPO	For VLS3P***R, VLS3P063R1, VLS3P016D1–VLS3P040D1. Ring mounting. Lock On protruding selector, □ 5 mm (0.2 in.).
VLSH3S7BD	For VLS3P063R2–VLS3P125R2, and VLS8M2. Screw mounting. Pistol grip with release, defeatable per UL60947-4-1; □ 7 mm (0.3 in.). <sup>[14]</sup>
VLSH2S5BC	For VLS8C mechanical interlock mechanism (I-O-II). □ 5 mm (0.2 in.). <sup>[12]</sup>
VLSH4S5B	For For VLS3P***R and VLS3P***D. Screw mounting. Protruding selector. □ 5 mm (0.2 in.). <sup>[12]</sup>
<b>Accessories for Rear Mounting Control For VLSH3S7RD and VLSH3S7BD handles.</b>	
VLSHA7	Adapter, □ 7 mm (0.3 in.) for VLS3P063R2–VLS3P125R2.



Table 8.46: Certifications and Compliance (● = certification obtained)

Catalog number	cULus per UL 60947-4-1 / CSA C22.2 n° 60947-4-1-14 UL Listed (File E487906)	cULus per UL98 / CSA C22.2 n° 4 UL Listed (File E487907)
VLSA11RS/DS	—	—
VLSA10R1E	UL Listed, cULus File E478582	—
VLSA10R2E	CSA C22.2 n° 14-10	—
VLS1NR1/D1	●	—
VLS1NR2/D2	—	●
VLS1GR1/D1	●	—
VLS1GR2/D2	—	●
VLS8C1/M1	●	—
VLS8C2/M2	—	●
VLSH1S5R/B	●	●
VLSH2S5R/B	●	●
VLSH2H5R/B	●	●
VLSH2H5RL	●	●
VLSH2H5BL	●	●
VLSH2H5BPO	●	—
VLSH4S5R/B	●	●
VLSH2H5RD/BD	●	●
VLSH3S7RD/BD	—	●
VLSH2H5BC	—	●
VLSHA7	—	●

Compliant with standards: IEC/EN 60947-1, IEC/EN 60947-3, IEC/EN 60947-5-1, UL 60947-4-1, UL 98, CSA C22.2.

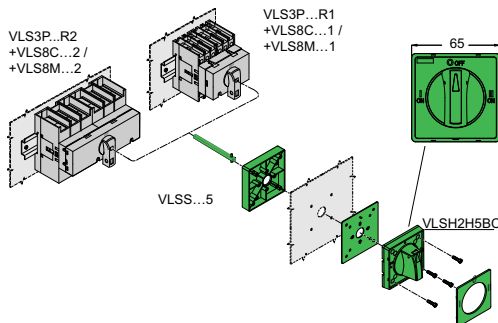

Figure 8.1: Transformation of the DIN rail mounting version into the rear mounting version

[11] Catalog numbers ending in BD or RD are for rear mounting units only.  
 [12] For VLS3P\*\*\*R disconnect switches, separately purchase VLSS shaft extensions.  
 [13] Snap-on mounting of VLS3P016–VLS3P040D1 disconnect switches with the handle.  
 [14] Separately purchase the VLSS...7 shaft extension and a VLSHA7 handle having a 7 mm (0.3 in.) square section—not required for VLS8M2.

Table 8.47: Operating Specifications

<b>Handle mounting</b>		ring or screw
<b>Mounting handle interaxis</b> (compatible with the pre-existing drillings of the most common types in the marketplace)	VLSH1S5R/B VLSH2S5R/B VLSH2S5BC	36 x 36 mm (1.4 x 1.4 in.) or 48 x 48 mm (1.9 x 1.9 in.)
	VLSH3S7RD/BD	36 x 36 mm (1.4 x 1.4 in.)
		1–3 for all handles Ø4–8 mm (Ø0.2–0.3 in.)
<b>Padlocks</b>		1–3 for all handles Ø4–8 mm (Ø0.2–0.3 in.)
<b>Tightening torque</b>	Mounting ring types	2.3 N•m (20.4 lb-in)
	VLS8M1	0.8 N•m (7 lb-in)
	VLSH3S7RD/BD	1.5 N•m (13.3 lb-in)
	All others	1 N•m (9 lb-in)
<b>Degree of protection</b>	IEC / EN: IP65 for all except VLSH3S7RD/BD, which are IP66. UL / CSA: VLSH1S5R/B and VLSH3S7RD/BD are Type 1, 12, 3R, 4, and 4X outdoor use with all VLS switch models. VLSH2S5R/B, VLSH2H5R/B, VLSH2H5RD/BD and VLSH2S5BC are Types 1, 12, 3R, 4, and 4X outdoor use with VLS3P016R1/D1–VLS3P040R1/D1 and VLS3P063R1 models, otherwise Type 1 only.	

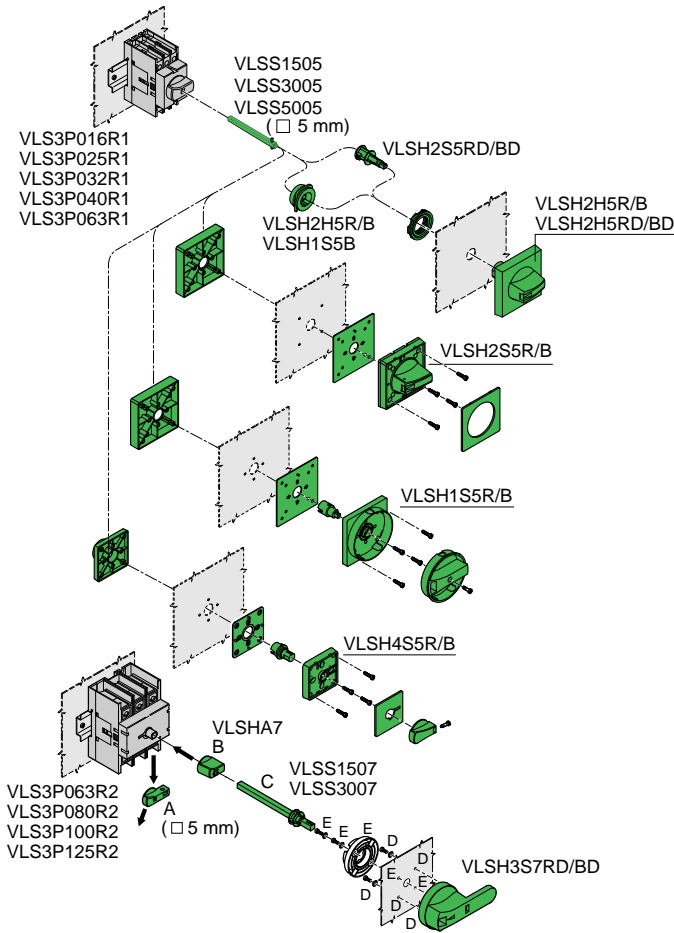

Figure 8.2: Changing the DIN rail mounting version for rear mounting

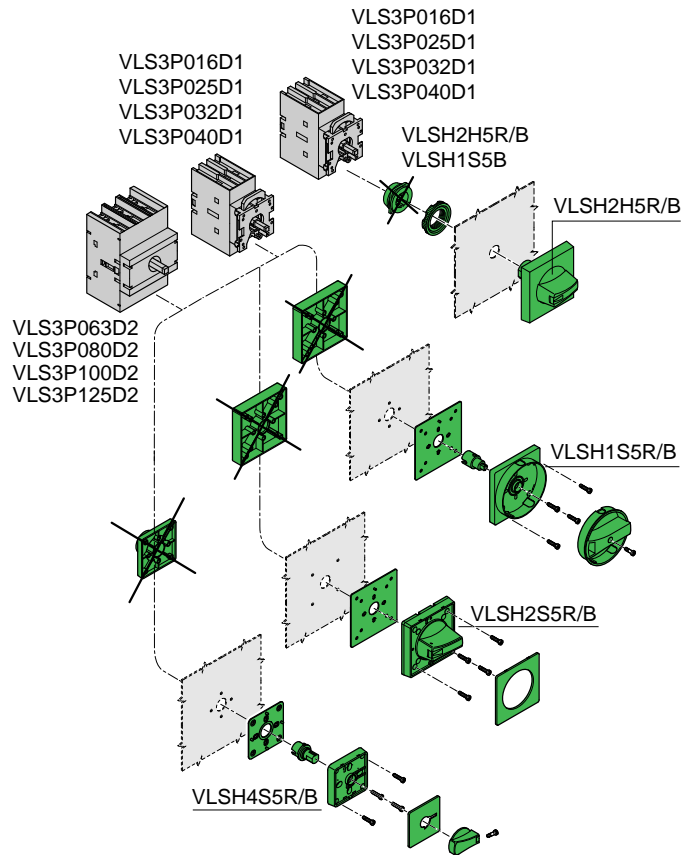

Figure 8.3: Door mounting version  
 Certifications and Compliance:  
 See Table 8.46 for details.



**Shaft Extensions, Terminal Covers, Fuse Holders, and Fuse Blocks**

**Table 8.48: Selection—Shaft Extensions, Terminal Covers, Fuse Holders, and Fuse Blocks**

Catalog number	Specifications	Qty per package	Weight, kg (lb)
Shaft extension for rear-mounting handles VLSH1S5R–VLSH2H5RD, VLSH1S5B–VLSH2H5BD, VLSH2S5BC; interlocking changeover type VLS8C1, VLS8C2; and mechanical disconnect switch system VLS8M1			
VLSS1505	150 mm long; □ 5 mm (0.2 in.)	1	0.032 (0.07)
VLSS3005	300 mm long; □ 5 mm (0.2 in.)	1	0.068 (0.15)
VLSS5005	500 mm long; □ 5 mm (0.2 in.)	1	0.090 (0.20)
Shaft extension for rear-mounting handles VLSH3S7RD/BD, and mechanical coupling system VLS8M2			
VLSS1507	150 mm long; □ 7 mm (0.3 in.)	1	0.090 (0.20)
VLSS3007	300 mm long; □ 7 mm (0.3 in.)	1	0.160 (0.35)
VLSS5007	500 mm long; □ 7 mm (0.3 in.)	1	0.250 (0.55)
VLSS57	Support for □ 7 mm shaft	1	0.160 (0.35)
Set of 2 one-pole terminal covers for fourth pole			
VLSC1P1	For VLS1P040R1S, VLS1P040D1S, VLS1P040R1E, VLS1P040D1E, VLS1P063R1E, VLS1P063R1S	1	0.009 (0.02)
VLSC1P2	For VLS1P063R2S–VLS1P125R2S, VLS1P063D2S–VLS1P125D2S, VLS1P125R2E, VLS1P125D2E	1	0.012 (0.03)
Set of 2 three-pole terminal covers			
VLSC3P1	For VLS3P016R1–VLS3P040R1, VLS3P063R1, VLS3P016D1–VLS3P040D1	1	0.018 (0.04)
VLSC3P2	For VLS3P063R2–VLS3P125R2, VLS3P063D2–VLS3P125D2	1	0.030 (0.07)
Fuse holder/block for disconnect switches			
VLSFH1UL	For VLS3P016R1–VLS3P032R1 (suitable for Class CC fuses)	1	0.135 (0.30)

**Table 8.49: Operational Specifications of Fuse Holder**

IEC rated insulation voltage, U <sub>i</sub>	1000 V
IEC rated impulse withstand voltage, U <sub>imp</sub>	8 kV
<ul style="list-style-type: none"> <li>The fuse holder/block connects directly to the disconnect switches.</li> <li>Access to fuses only when the disconnect switches are in Off position.</li> </ul>	

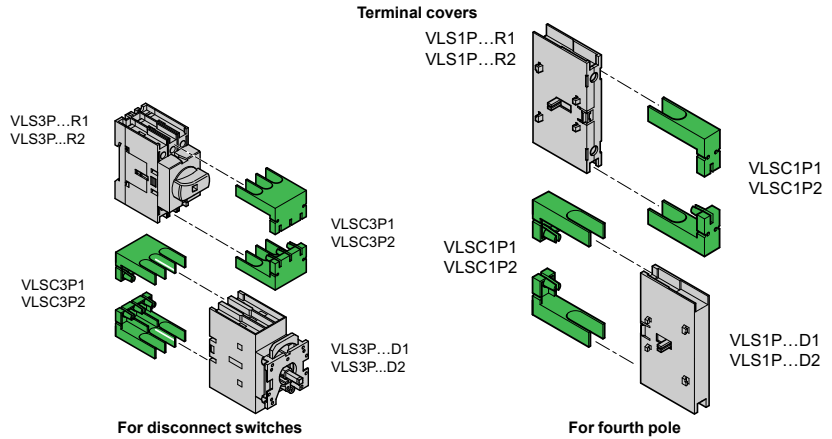

**Table 8.50: Certifications and Compliance (● = certification obtained)**

Catalog number	cULus per UL60947-4-1 / CSA C22.2 n° 60947-4-1-14 UL Listed (File E487906)	cULus per UL98 / CSA C22.2 n° 4 UL Listed (File E487907)
VLSS1505, VLSS3005, VLSS5005	●	—
VLSS1507, VLSS3007	●	—
VLSC1P1, VLSC3P1	—	—
VLSC1P2, VLSC3P2	—	—
VLSFH1UL	●	—
Compliant with standards: IEC/EN 60947-1, IEC/EN 60947-3, UL60947-4-1, UL98, CSA C22.2.		

**Table 8.51: DIN Rail Mounting Disconnect Switches**  
VLS3P016R1–VLS3P040R1, VLS3P063R1

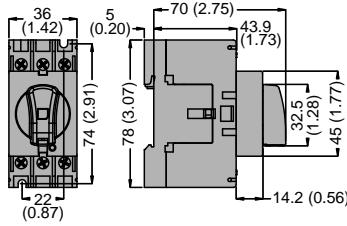

VLS3P063R2–VLS3P125R2

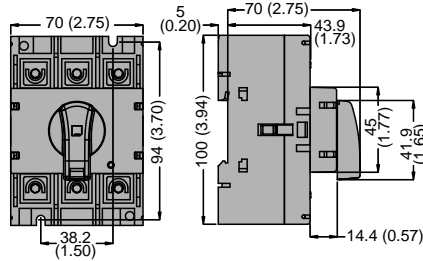

Dim. = mm (in.)

**Table 8.52: Door Mounting Disconnect Switches**  
VLS3P016D1–VLS3P040D1

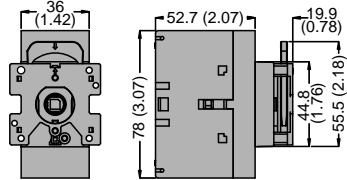

VLS3P063D2–VLS3P125D2

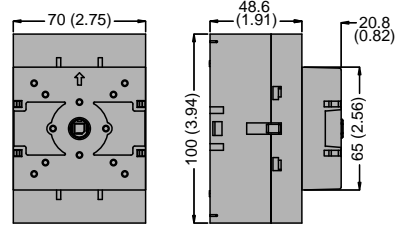

Dim. = mm (in.)

**Table 8.53: Add-on Blocks and Accessories**  
For VLS3P016R1–VLS3P040R1, VLS3P063R1

**Auxiliary contacts**  
VLSA11RS, VLSA10R1E

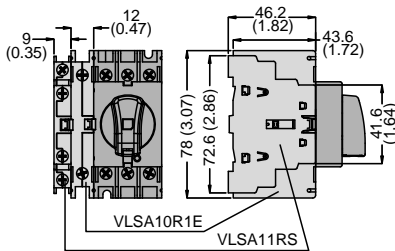

**Fourth pole**  
VLS1P040R1E/R1S, VLS1P063R1E/R1S  
VLS1NR1 neutral, VLS1GR1 ground terminals

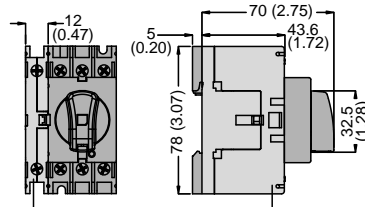

Dim. = mm (in.)

VLS3P016R1, VLS3P025R1, VLS3P032R1,  
VLS3P040R1, VLS3P063R1, VLSA11RS

**For VLS3P063R2–VLS3P125R2**

**Auxiliary contacts**  
VLSA11RS  
VLSA10R2E

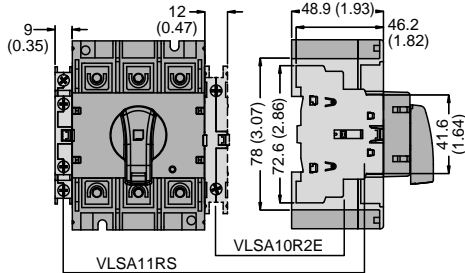

**Fourth pole**  
VLS1P125R2E, VLS1P063R2S–VLS1P125R2S  
VLS1NR2 neutral, VLS1GR2 ground terminals

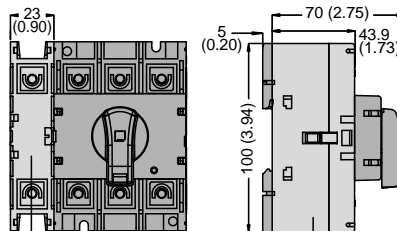

Dim. = mm (in.)

VLS3P063R2, VLS3P080R2, VLS3P100R2, VLS3P125R2,  
VLSA10R1E, VLSA10R2E, VLS1P063R2S, VLS1P080R2S,  
VLS1P100R2S, VLS1P125R2S, VLS1P125R2

**Mechanical interlock VLS8C1 and mechanical coupling system VLS8M1**

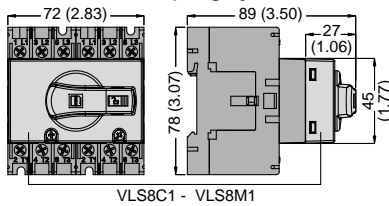

**Mechanical interlock VLS8C2 and mechanical coupling system VLS8M2**

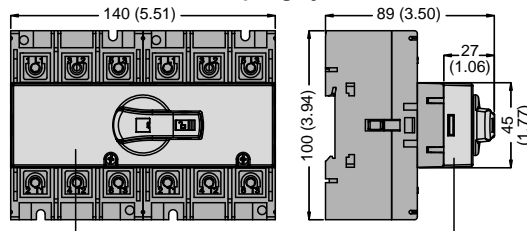

Dim. = mm (in.)

VLS8C2 - VLS8M2

For VLS3P016D1–VLS3P040D1

Auxiliary contacts  
VLSA11DS

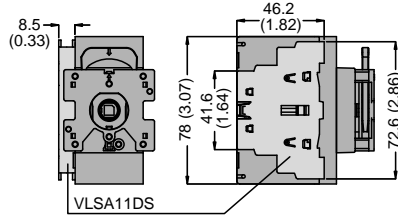

Fourth pole  
VLS1P040D1E–VLS1P040D1S  
VLS1ND1 neutral, VLS1GD1 ground terminals

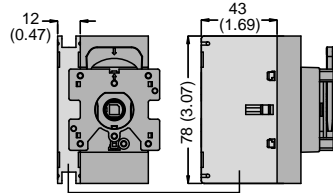

VLS3P016D1, VLS3P025D1, VLS3P032D1,  
VLS3P040D1, VLS1P040D1S, VLS1P040D1E

Dim. =  
mm (in.)

For VLS3P063D2–VLS3P125D2

Auxiliary contacts  
VLSA11DS

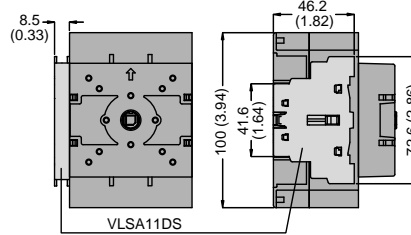

Fourth pole  
VLS1P125D2E, VLS1P063D2S–125D2S  
VLS1ND2 neutral, VLS1GD2 ground terminals

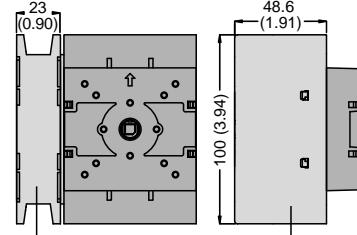

VLS1P063D2S, VLS1P080D2S, VLS1P100D2S,  
VLS1P125D2S, VLS1P125D2E, VLS1ND1,  
VLS1ND2, VLS1GD1, VLS1GD2

Dim. =  
mm (in.)

Table 8.54: Rotary handles

VLSH1S5R/B

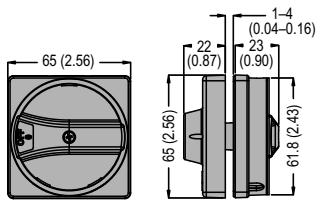

VLSH2S5R/B

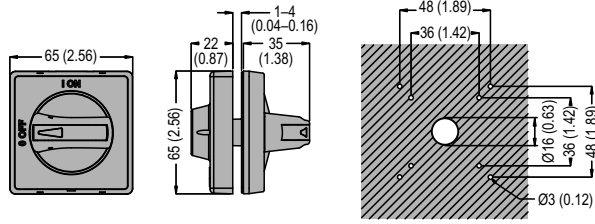

Dim. =  
mm (in.)

VLSH2H5R/B

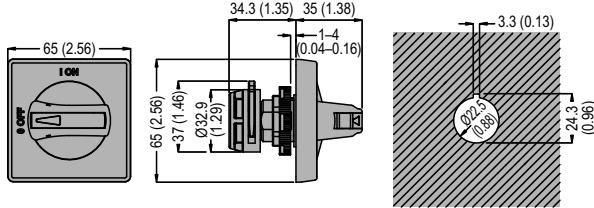

VLSH2H5RD/BD

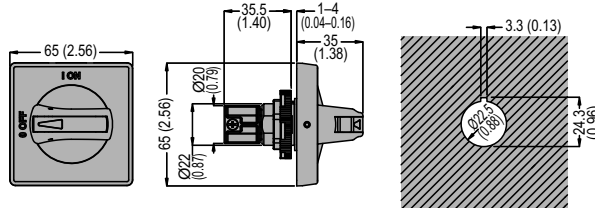

Dim. =  
mm (in.)

VLSH3S7RD/BD

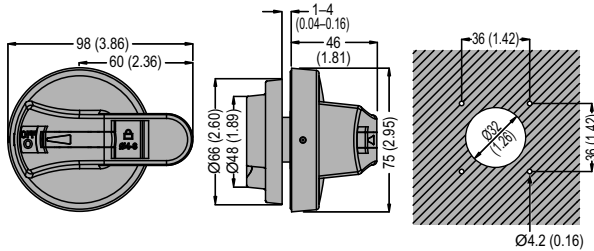

VLSH2S5BC

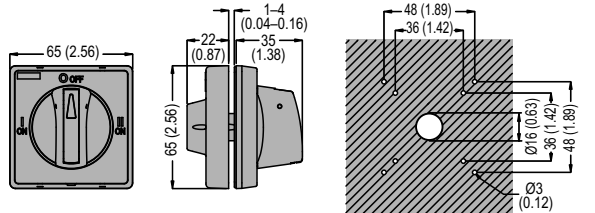

Dim. =  
mm (in.)

VLSH4S5R/B

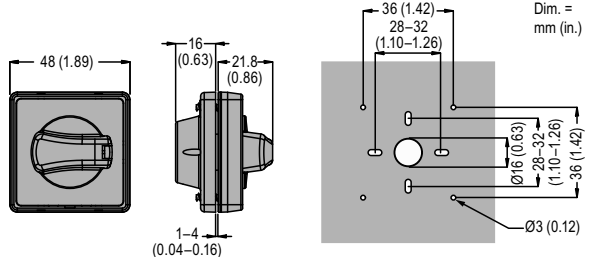

Dim. =  
mm (in.)

**Shaft extensions for rear-mounting handles (for Dimension A, see Table 8.55)**

VLSS

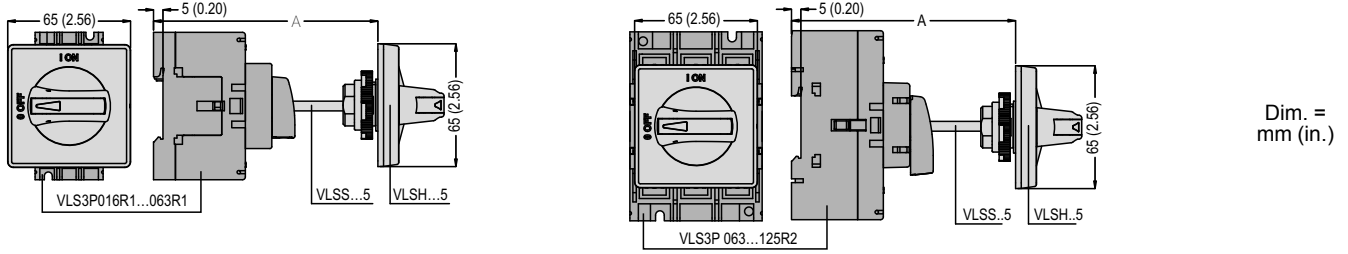

Dim. = mm (in.)

**Table 8.55: Dimension A for VLSS Shaft Extensions**

Dimension A for VLSS Shaft Extensions (see below)						
Extension	Length mm (in.)	Maximum Dimension A, mm (in.)				
		Type of handle				
		VLSH1S5*	VLSH2S5*	VLSH2H5R	VLSH2H5RD	VLSH2S5BC
VLSS1505	150 (5.90)	194 (7.64)	192 (7.56)	197 (7.75)	211 (8.31)	192 (7.56)
VLSS3005	300 (11.81)	344 (13.54)	342 (13.46)	347 (13.66)	361 (14.21)	342 (13.46)
VLSS5005	500 (19.68)	544 (21.42)	542 (21.34)	547 (21.53)	561 (22.09)	542 (21.34)

VLSS used with VLS8C1, VLS8C2, and VLS8M1

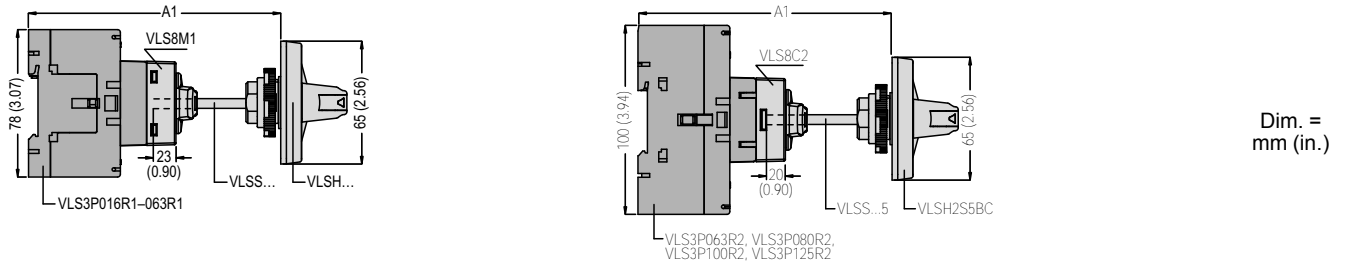

Dim. = mm (in.)

**Table 8.56: Dimension A1 for VLSS used with VLS8C1, VLS8C2, and VLS8M1**

Extension (5 mm)	Length mm (in.)	A1 maximum, mm (in.)				
		Used with VLS8M1		Used with VLS8C1/VLS8C2		
		Type of handle				
		VLSH1S5*	VLSH2S5*	VLSH2H5R	VLSH2H5RD	VLSH2S5BC
VLSS1505	150 (5.90)	211 (8.31)	209 (8.23)	214 (8.42)	228 (8.98)	209 (8.23)
VLSS3005	300 (11.81)	361 (14.21)	359 (14.13)	364 (14.33)	378 (14.88)	359 (14.13)
VLSS5005	500 (19.68)	561 (22.09)	559 (22.01)	564 (22.20)	578 (22.75)	559 (22.01)

VLSS...7 used with VLSHA7 and VLSH3S7RD/BD

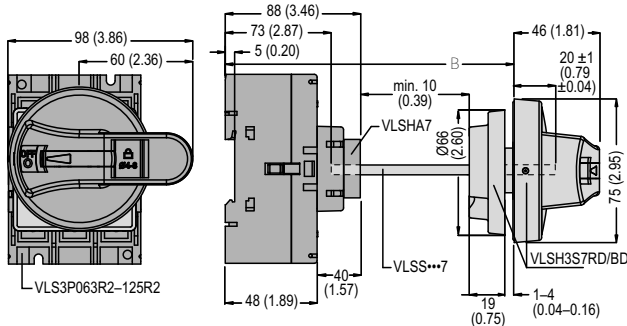

VLSS...7 used with VLS8M2 and VLSH3S7RD/BD handle

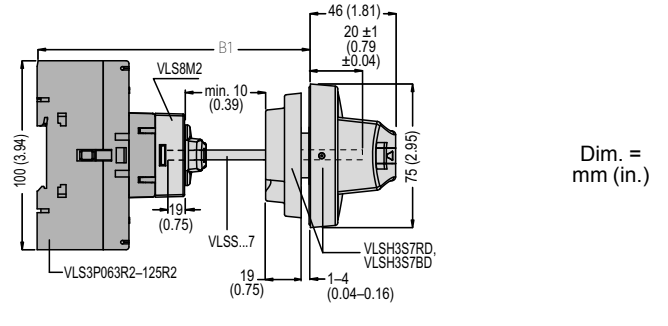

Dim. = mm (in.)

Extension (7 mm)	Length mm (in.)	B with VLSH3S7RD/BD handle	
		B mm (in.)	B1 mm (in.)
VLSS1507	176 (6.93)	118–229 (4.64–9.01)	119–205 (4.68–8.07)
VLSS2007	226 (8.90)	118–279 (4.64–10.99)	119–255 (4.68–10.03)
VLSS3007	326 (12.83)	118–379 (4.64–14.92)	119–355 (4.68–13.98)

**Table 8.57: Terminal Cover and Fuse Holder Dimensions**

**Terminal Cover Dimensions**  
VLSC1P1, VLSC3P1

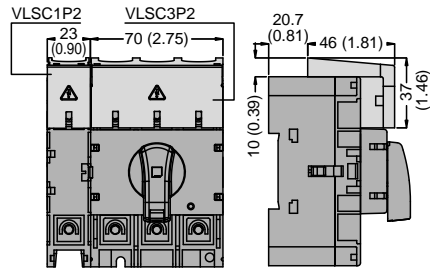
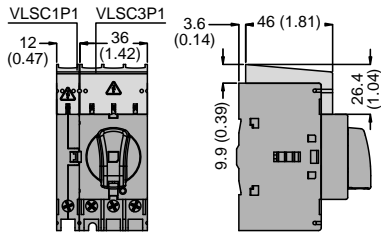

**Fuse Holder Dimensions**  
VLSFH1UL

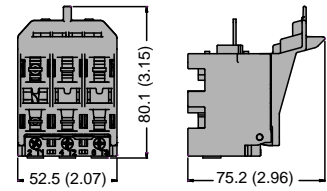

**VLSC1P2, VLSC3P2**

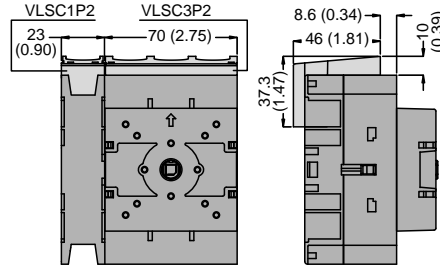
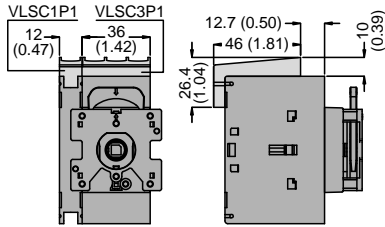

Dim. =  
mm (in.)

**Table 8.58: Wiring Diagrams—VLS Disconnect Switches (16–125 A)**

**Three-pole disconnectors**

VLS3P016... –  
VLS3P125R2/D2

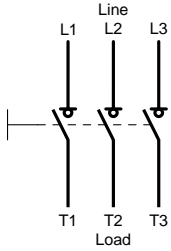

**Fourth pole add-on**  
VLS1P.....S



VLS1P.....E

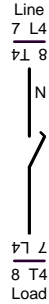

**Add-on Blocks and Accessories**

**Auxiliary contacts**

VLSA11-S

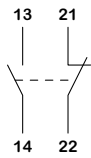

VLSA10R1E–VLSA10R2E



**Neutral terminal**

VLS1NR1/D1–VLS1NR2/D2



**Earth/Ground terminal**

VLS1GR1/D1–VLS1GR2/D2



**Fuse holder**

VLSFH1

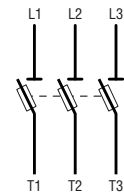

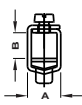
Model	3-pole: VLS3P...	016...	025...	032...	040...	063R1	063R2	080...	100...	125...	
	4th pole: VLS1P...	040...	040...	040...	040...	063R1S	063R2S	080...	100...	125...	
<b>Contact Specifications</b>											
IEC conventional free air thermal current, I <sub>th</sub> (≤40 °C)		A	16	25	32	40	63	63	80	100	125
IEC rated insulation voltage, U <sub>i</sub>		V	1000								
IEC rated impulse withstand voltage, U <sub>imp</sub>		kV	8								
<b>IEC rated operational current, I<sub>e</sub></b>											
AC21A	400 V	A	16	25	32	40	63	63	80	100	125
	500 V	A	16	25	32	40	63	63	80	100	125
	690 V	A	16	25	32	40	63	63	80	100	125
AC22A	400 V	A	16	25	32	40	45	63	80	100	125
	500 V	A	16	25	32	40	45	63	80	100	125
	690 V	A	16	25	32	40	45	63	80	100	125
AC23A	400 V	A	16	25	32	40	45	63	80	100	125
	500 V	A	16	25	25	25	25	63	63	80	100
	690 V	A	16	25	25	25	25	47	47	47	47
<b>IEC rated operational power</b>											
AC23A	400 V	kW	7.5	11	15	18.5	22	30	45	55	55
	690 V	kW	11	22	22	22	22	45	45	45	45
IEC reactive power for capacitor control 400 V		kvar	7.5	10	12.5	15	15	25	30	40	50
<b>IEC protection against short-circuit</b>											
Rated short-time withstand current (1 s), I <sub>cw</sub>		A rms	800								2500
Rated conditional short-circuit current		kA rms	50								
With fuse class gG		A	16	25	32	40	63	63	80	100	125
IEC making capacity (AC23A 400 V)		A	400				450	1250			
IEC breaking capacity (AC23A 400 V)		A	320				360	1000			
Mechanical life (depending on the application)		cycles	100,000				100,000	30,000			
Electrical life (IEC AC21A)		cycles	100,000				15,000	30,000			
UL/CSA general use at 600 V		A	16	25	32	40	50	60	100	100	100
UL/CSA short-circuit rating at 600 V		kA	5	5	5	5	5	50	50	50	50
UL/CSA fuse class/max rating at 600 V		Type/A	RK5/20	RK5/30	RK5/35	RK5/45	RK5/45	–/100	–/100	–/100	–/100
<b>UL/CSA Hp ratings</b>											
Single phase	120 V	hp	1	1.5	2	2	2	3	3	5	7.5
	240 V	hp	2	3	5	5	7.5	7.5	10	10	10
Three phase	200–208 V	hp	5	7.5	10	10	10	20	25	30	25
	240 V	hp	5	7.5	10	15	15	20	30	30	30
	480 V	hp	10	15	20	20	30	40	40	50	50
	600 V	hp	10	20	20	25	30	40	40	60	40
<b>Terminals</b>											
	Type	Lug clamp IEC/EN 60947-1 designation: Pillar terminal.									
	A	5.6 mm (0.22 in.)						12.4 mm (0.49 in.)			
	B	6.5 mm (0.26 in.)						10.4 mm (0.41 in.)			
	Screw	M4						M8			
	Tool	Phillips 2						Metric Allen key 4			
Tightening torque		N•m	1.8–2				5–6				
		lb-in	16–18				45–54				
Conductor section (solid/stranded)		mm <sup>2</sup>	0.75–16				4–50				
		AWG	18–6				12–1				
<b>Ambient Conditions</b>											
Temperature	Operating	°C	–25 to +55								
	Storage	°C	–40 to +70								
Maximum altitude		m	3000								
Mounting position	Normal	Vertical									
	Admissible	Any									
Mounting	Screw or 35 mm DIN rail (IEC/EN 60715)										



LK4 and GS2 Disconnect Switches

Table 8.59: Building a Complete GS or LK Switch

To build a complete GS or LK switch, order the following parts:

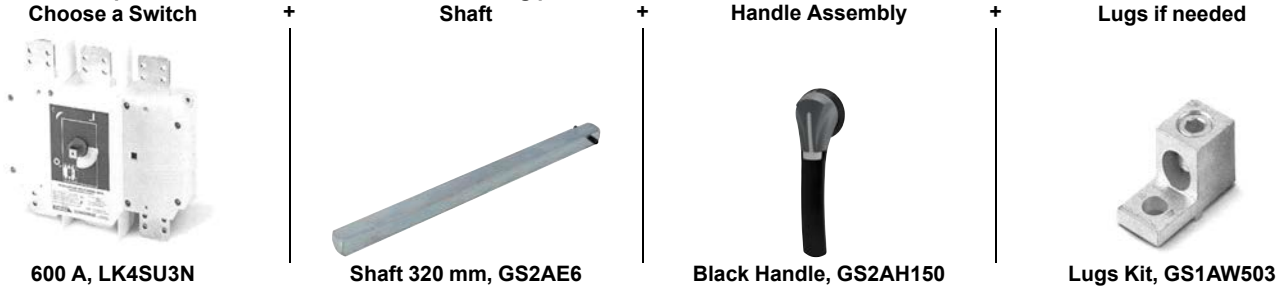

**Example:**  
LK4SU3N (600 A non-fusible switch) + GS2AE6 (320 mm Style D shaft) + GS2AH150 (black/black, locking)  
**To add auxiliary contacts:**  
For front-mounted contacts order LK4AD30N (front-mounted auxiliary contact holder) + GS2AM110.

LK4 Nonfusible Disconnect Switches

NOTE: Switches in the shaded area are now available as kits. See Table 8.61.

Table 8.60: LK Nonfusible IEC Style Disconnect Switches

Pole	Rating (A)	Catalog No.	Maximum Horsepower Rating				Short Circuit Current Rating, 600 Vac		Shaft Style
			240 V	480 V	600 V	250 Vdc	Fuse	SCCR kA	
NOTE: Switches in the shaded area are now available as kits.									
3	30	LK4DU3CN [1]	10	20	30	—	J	100	AL
3	60	LK4GU3CN [1]	20	40	50	—	J	100	AL
3	100	LK4JU3CN [1]	20	50	50	N/A	J	100	AL
3	100	LK4JU3N	30	75	100	15	J	200	B
3	200	LK4MU3N	75	150	200	15	J	200	B
3	400	LK4QU3N	125	250	350	50	J	200	B
3	600	LK4SU3N	200	400	350	50	J	200	D
3	800	LK4TU3N	200	500	500	—	L	100	D
3	1000	LK4UU3N	200	500	500	—	L	100	D
3	1200	LK4WU3N	200	500	500	—	L	100	D



100-400 A



30-100 A Compact

NOTE: The kit also includes rod LK4AE41CN.



Table 8.61: <sup>New!</sup> Kits for Compact Switches LK4: 30, 60 and 100 A

Rating (A)	Kit Catalog Number	Pieces Included [2]				
		Compact Switch	400 mm Shaft	Handle Color / NEMA Rating	Handle	Guide Cone
30 A	LK4DUKB1	LK4DU3CN	LK4AE41CN	Black / NEMA 1, 12, 3R	LK4AH0110CN	GS2AEH12
	LK4DUKB4	LK4DU3CN	LK4AE41CN	Black / NEMA 4, 4X	LK4AH0410CN	GS2AEH12
	LK4DUKR1	LK4DU3CN	LK4AE41CN	Red / NEMA 1, 12, 3R	LK4AH0120CN	GS2AEH12
	LK4DUKR4	LK4DU3CN	LK4AE41CN	Red / NEMA 4, 4X	LK4AH0420CN	GS2AEH12
60 A	LK4GUKB1	LK4GU3CN	LK4AE41CN	Black / NEMA 1, 12, 3R	LK4AH0110CN	GS2AEH12
	LK4GUKB4	LK4GU3CN	LK4AE41CN	Black / NEMA 4, 4X	LK4AH0410CN	GS2AEH12
	LK4GUKR1	LK4GU3CN	LK4AE41CN	Red / NEMA 1, 12, 3R	LK4AH0120CN	GS2AEH12
	LK4GUKR4	LK4GU3CN	LK4AE41CN	Red / NEMA 4, 4X	LK4AH0420CN	GS2AEH12
100 A	LK4JUKB1	LK4JU3CN	LK4AE41CN	Black / NEMA 1, 12, 3R	LK4AH0110CN	GS2AEH12
	LK4JUKB4	LK4JU3CN	LK4AE41CN	Black / NEMA 4, 4X	LK4AH0410CN	GS2AEH12
	LK4JUKR1	LK4JU3CN	LK4AE41CN	Red / NEMA 1, 12, 3R	LK4AH0120CN	GS2AEH12
	LK4JUKR4	LK4JU3CN	LK4AE41CN	Red / NEMA 4, 4X	LK4AH0420CN	GS2AEH12

[1] No longer sold as components. Purchase Kits containing Switch, Handle, Shaft, and Guide Cone as listed in Table 8.61.

[2] Components are NOT sold separately. Only 400 mm shaft can be purchase separately.



GS2AH130



GS2AH150



GS2AH170

**NOTE:** Switches in the shaded area are now available as kits. See Table 8.61.

**Table 8.62: Handles and Shafts for LK Switches**

Rating (A)	Handle			Shaft		Shaft		Guide Cone <sup>[3]</sup>	Shaft Style	Support Bracket
	Catalog No.	Type	Color	12.6 in. / 320 mm	15.7 in. / 400 mm	19.6 in. / 500 mm	Catalog No.			
<b>NOTE:</b> Switches in the shaded area are now available as kits.										
30–100	LK4AH110CN <sup>[4]</sup>	1, 3R, 12	Black	LK4AE12CN	—	—	GS2AEH12	AL	—	
30–100	LK4AH1120CN <sup>[4]</sup>	1, 3R, 12	Red/Yellow							
30–100	LK4AH410CN <sup>[4]</sup>	4, 4X	Black							
30–100	LK4AH420CN <sup>[4]</sup>	4, 4X	Red/Yellow							
100–400	GS2AH130	1, 3R, 12	Black	GS2AE2	GS2AE21	GS2AE23	GS2AEH12	B	GS2AESB	
100–400	GS2AH140	1, 3R, 12	Red							
100–400	GS2AH430	4, 4X	Black							
100–400	GS2AH440	4, 4X	Red/Yellow							
600	GS2AH150	1, 3R, 4, 4X, 12	Black	GS2AE6	GS2AE61	—	GS2AEH12	D	—	
600	GS2AH160	1, 3R, 4, 4X, 12	Red/Yellow							
800–1200	GS2AH170	1, 3R, 4, 4X, 12	Black							
800–1200	GS2AH180	1, 3R, 4, 4X, 12	Red/Yellow							

**Table 8.63: Auxiliary Contacts for LK Switches**

Switch Amperes	Catalog No.	Description
30–60	MDSAN11	Auxiliary Contact 1 N.O. and 1 N.C.
30–60	MDSAN20	Auxiliary Contact 2 N.O.
100–400	LK4AD10N	Auxiliary Contact 1 N.O. and 1 N.C.
100–400	LK4AD20N	Auxiliary Contact 2 N.O.
600–1200	LK4AD30N	Auxiliary Contact Holder
600–1200	GS2AM110	Auxiliary Contact 1 N.O.
600–1200	GS2AM101	Auxiliary Contact 1 N.C.

**Table 8.64: Terminal Shrouds for LK Switches**

Switch Amperes	Catalog No.	Description
30–60	LK4AP3CN	Shroud Top and Bottom, 3-Pole
100–200	LK4AP33TN	Shroud Top LK4, 3-Pole, 100/200 A
100–200	LK4AP33BN	Shroud Bottom LK4, 3-Pole, 100/200 A
400	LK4AP53TN	Shroud Top LK4, 3-Pole, 400 A
400	LK4AP53BN	Shroud Bottom LK4, 3-Pole, 400 A
600 <sup>[5]</sup>	LK4AP63N	Shroud Bottom LK4, 3-Pole, 600 A
800–1200 <sup>[5]</sup>	LK4AP83N	Shroud Bottom LK4, 3-Pole, 800–1200 A

<sup>[3]</sup> Optional on shafts for LK4DU3CN, LK4GU3CN and LK4JU3CN.  
<sup>[4]</sup> No longer sold as components. Purchase Kits containing Switch, Handle, Shaft, and Guide Cone as listed in Table 8.61.  
<sup>[5]</sup> 600–1200 A standard with top shroud.



GS2GU3N



Auxiliary Contacts  
GS1AD10 + GS2AM110



Shorting Links

**GS2 Fusible Disconnect Switches**

**Table 8.65: GS Fusible IEC Style Disconnect Switches**

Pole	Rating (A)	Catalog No.	Maximum Horsepower Rating				Short Circuit Current Rating, 600 Vac		Shaft Style
			240 V	480 V	600 V	250 Vdc	Fuse	SCCR kA	
3	30	GS1DDU3	7.5	15	20	5	CC	100	AG
3	30	GS1DU3	7.5	15	20	5	J	100	AG
3	30	GS2EEU3	7.5	15	20	5	CC	100	B
3	30	GS2EU3N	7.5	15	20	5	J	100	B
3	60	GS2GU3N	15	30	50	10	J	100	B
3	100	GS2JU3N	30	60	75	20	J	200	B
3	200	GS2MU3N	60	125	150	40	J	200	B
3	400	GS2QU3N	125	250	350	50	J	200	B
3	600	GS2SU3	200	500	500	—	J	200	C
3	800	GS2TU3	200	500	500	—	J	200	C

**Table 8.66: Handles and Shafts for GS Switches [6]**

Rating (A)	Handle			Shaft: 12.6 in. (320 mm)	Shaft: 15.7 in. (400 mm)	Shaft: 19.7 in. (500 mm)	Shaft Guide Catalog No.	Shaft Style	Support Bracket [7]
	Catalog No.	Type	Color	Catalog No.	Catalog No.	Catalog No.			
30-60	GS2AH110	1, 3R, 12	Black	GS2AE8	GS2AE81	—	GS2AEH12	AG	—
30-60	GS2AH120	1, 3R, 12	Red/Yellow						
30-60	GS2AH410	4, 4X	Black						
30-60	GS2AH420	4, 4X	Red/Yellow	GS2AE2	GS2AE21	GS2AE23	GS2AEH12	B	GS2AESB
30-400	GS2AH130	1, 3R, 12	Black						
30-400	GS2AH140	1, 3R, 12	Red/Yellow						
30-400	GS2AH430	4, 4X	Black	GS2AE5	GS2AE51	GS2AE53	GS2AEH12	C	—
30-400	GS2AH440	4, 4X	Red/Yellow						
600-800	GS2AH150	1, 3R, 4, 4X, 12	Black						
600-800	GS2AH160	1, 3R, 4, 4X, 12	Red/Yellow						

**NOTE:** Hole adapter kit for GS1 to GS2 Handles: GS2AH100TO200.

**Table 8.67: Auxiliary Contacts for GS Switches [8]**

Switch Amperes	Catalog No.	Description
30-800	GS1AM110	Auxiliary Contact, 1 N.O.
30-800	GS1AM101	Auxiliary Contact, 1 N.C.
30	GS1AD10	Auxiliary Contact Holder

**Table 8.68: Shorting Links**

For use on:	Shorting Links per Kit	Catalog No.
GS2, 60 A	3	GS1AU203
GS2, 100 A	3	GS1AU303
GS2, 200 A	3	GS1AU403
GS2, 400 A	3	GS1AU503
GS2, 600-800 A	3	GS1AU803

**Table 8.69: NFPA79 Kit**

For Use With:	Description	Kit Part Number
GS2Q3N	NFPA 79 Internal Handle Kit 400 A Switch Shaft	GS2AD040N
GS2GU3N, GS2GLU3N, GS2JU3N, GS2JLU3N	NFPA 79 Internal Handle Kit 60-200 A Switch Shaft	GS2AD030N
GS1DDU3, GS1DU3	NFPA 79 Internal Handle Kit for 5 mm Shafts	GS1AD010

**Table 8.70: Terminal Shrouds for GS Switches, Line or Load [9]**

Switch Amperes	Catalog No.	Description
30-100	—	Standard on product
200	GS2AP43	GS2, 3-Pole, 200 A
400	GS2AP53	GS2, 3-Pole, 400 A
600-800	GS2AP73	GS2, 3-Pole, 600-800 A

[6] GS2AH100TO200—GS1 to GS2 Handle Adapter if using GS1 holes.

[7] Not for use with flange disconnects.

[8] GS1DU3 and GS1DDU3 switches allow up to 4 auxiliary contacts without adding contact holder GS1AD10. For more than 4 contacts, GS1AD10 is required.

[9] Order one terminal shroud per side. For example, order one terminal shroud for either the line side or load side; order two terminal shrouds for both the line side and load side.

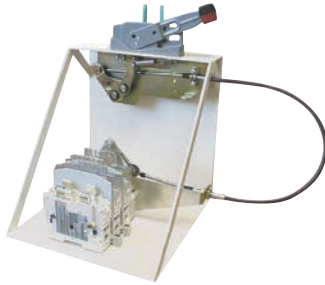

Flange Handle Cable Operator Kit

**Cable Operator Kits for GS2 Switches**

**Table 8.71: Cable Operator Kits for GS2 Switches** [10] [11] [12]

Catalog No.	Description
<b>200 A and Below</b>	
GS2AH36F	36 in. Cable Operator Kits for GS2 Switches, 200 A and Below
GS2AH60F	60 in. Cable Operator Kits for GS2 Switches, 200 A and Below
GS2AH120F	120 in. Cable Operator Kits for GS2 Switches, 200 A and Below
GS2AH144F	144 in. Cable Operator Kits for GS2 Switches, 200 A and Below
GS2AH180F	180 in. Cable Operator Kits for GS2 Switches, 200 A and Below
<b>400 A</b>	
GS2AH460F	60 in. Cable Operator Kits for GS2 Switches, 400 A
GS2AH4120F	120 in. Cable Operator Kits for GS2 Switches, 400 A
GS2AH4144F	144 in. Cable Operator Kits for GS2 Switches, 400 A
GS2AH4180F	180 in. Cable Operator Kits for GS2 Switches, 400 A

**Table 8.72: Handles for use with Cable Operator Kits** [12]

Catalog No.	NEMA Type Enclosure	Type of Handle
9422A1	1, 3, 3R, 4, (Sheet Steel)	6 in.
9422A2	4, 4X (Stainless)	6 in.
9422A3	1, 3, 3R, 4, (Sheet Steel)	4 in.
9422A4	4, 4X (Stainless)	4 in.

**Accessories**

**Table 8.73: Terminal Lugs**



Terminal Lugs

For Use On:	Rating	No. of Wires per Lug	No. of Lugs per Terminal	Lug Size (AWG)	Wire Type	Lugs per Kit	Lug Kit Catalog Number
LK4DU3CN	30	1	1	#12-2/0	Cu	—	Standard
LK4GU3CN	60	1	1	#12-2/0	Cu	—	Standard
LK4JU3N	100	1	1	6-300 kcmil	Cu/Al	6	GS1AW403
LK4MU3N	200	1	1	6-300 kcmil	Cu/Al	6	GS1AW403
LK4QU3N	400	2	1	350 MCM-6	Cu/Al	6	GS1AW603
		1	—	600 MCM-4	—	—	—
		2	1	250 MCM-1/0	Cu/Al	6	GS1AW606
LK4SU3N	600	2	1	2 x 2-600 kcmil	Cu/Al	6	GS1AW503
LK4TU3N	800	2	2	2 x 2-600 kcmil	Cu/Al	12	GS1AW903
LK4UU3N	1000	2	2	2 x 2-600 kcmil	Cu/Al	12	GS1AW903
LK4WU3N	1200	2	2	2 x 2-600 kcmil	Cu/Al	12	GS1AW903
GS1DDU3	30	1	1	#14-#10	Cu	—	Standard
GS1DU3	30	1	1	#14-#10	Cu	—	Standard
GS2EEU3	30	1	1	#14-#10	Cu	—	Standard
GS2EU3N	30	1	1	#14-#6	Cu	—	Standard
GS2GU3N	60	1	1	#10-#6	Cu	—	Standard
GS2JU3N	100	1	1	#12-#1	Cu	—	Standard
GS2MU3N	200	1	1	6-300 kcmil	Cu/Al	6	GS1AW403
GS2QU3N	400	2	1	350 MCM-6	Cu/Al	6	GS1AW603
		1	—	600 MCM-4	—	—	—
		2	1	250 MCM-1/0	Cu/Al	6	GS1AW606
GS2SU3	600	2	1	2 x 2-600 kcmil	Cu/Al	6	GS1AW503
GS2TU3	800	2	1	2 x 2-600 kcmil	Cu/Al	6	GS1AW503

**Table 8.74: Power Distribution Lugs GS1 or GS2 Only**

For Use On:	Rating	No. of Wires per Lug	Lug Size (AWG)	Wire Type	Lugs per Kit	Lug Kit Catalog No.
GS1JU3	100	6	#14-#6	Cu	3	GS1AW306 [13]
GS2MU3N	200	12	#14-#4	Cu	3	GS1AW406
GS2QU3N	400	12	#14-#4	Cu	3	GS1AW406
GS2MU3N	200	6	#12-2/0	Cu	3	GS1AW506
GS2QU3N	400	6	#12-2/0	Cu	3	GS1AW506

[10] Does not include handle. For handle, see Table 8.72.

[11] Not compatible with GS2EEU3.

[12] A 400 A cable operator kit uses either 9422AP1 or AP2 handle.

[13] Cannot be used on GS2JU3N.

**LK4DU3CN and LK4GU3CN, 30–100 A Compact Nonfusible Disconnect Switches**

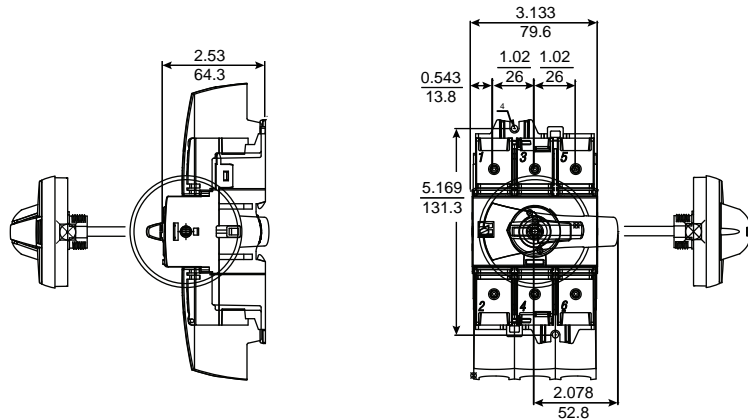

**Handle for 30–100 A Compact Nonfusible Disconnect Switches**

Handle Part No.  
LK4AH110CN  
LK4AH120CN  
LK4AH410CN  
LK4AH420CN

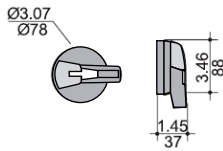

Right-side or front operation

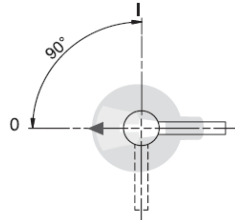

Door drilling with 4 fixing screws

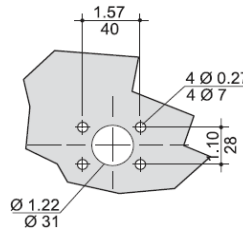

Door drilling with fixing nut

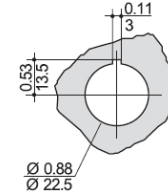

**LK4JU3N / LK4MU3N / LK4QU3N, 100–400 A Nonfusible Disconnect Switches—Dimensions**

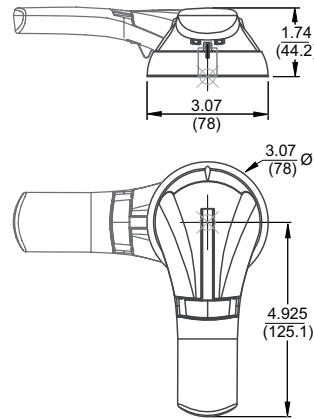
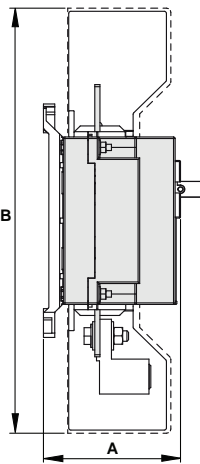
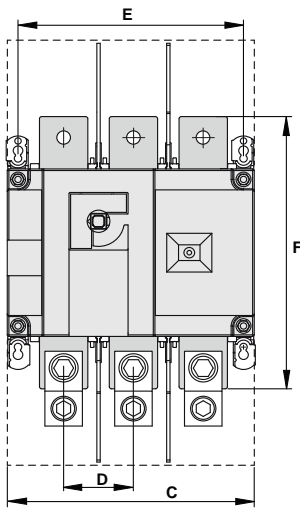

Handle Part No.

- GS2AH130
- GS2AH140
- GS2AH430
- GS2AH440

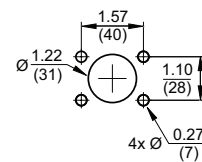

Dimensions:  $\frac{\text{in.}}{\text{mm}}$

Rating (A)	Dimensions = in. (mm)					
	A	B	C	D	E	F
100–200	3.72 (94.6)	10.1 (256)	7.09 (1.80)	1.97 (50)	6.3 (160)	6.3 (160)
400	4.92 (128)	16 (406)	9.05 (230)	2.56 (65)	8.26 (210)	10.2 (260)

**LK4SU3N, 600 A Nonfusible Disconnect Switches—Dimensions**

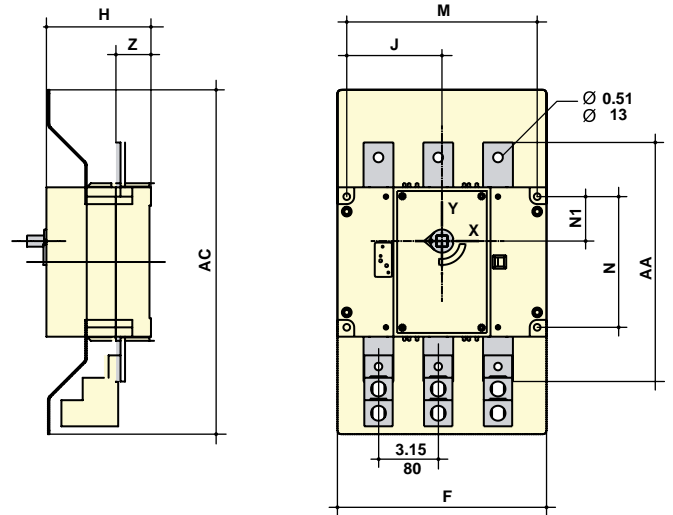

Rating (A)	Dimensions = in. (mm)								
	AC	F	H	J	M	N	N1	AA	Z
600	18.12 (460)	11 (280)	5.5 (140)	5.0 (127.5)	10.03 (255)	6.88 (175)	2.34 (59.5)	12.6 (320)	1.85 (47)

**Handle for 600 and 800 A Fusible Disconnect Switches**

Handle Part No.  
GS2AH150  
GS2AH160

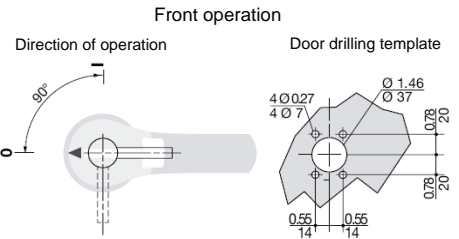
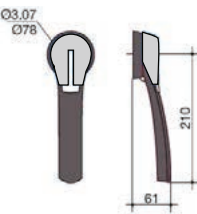

**LK4TU3N / LK4UU3N / LK4WU3N, 800–1200 A Nonfusible Disconnect Switches—Dimensions**

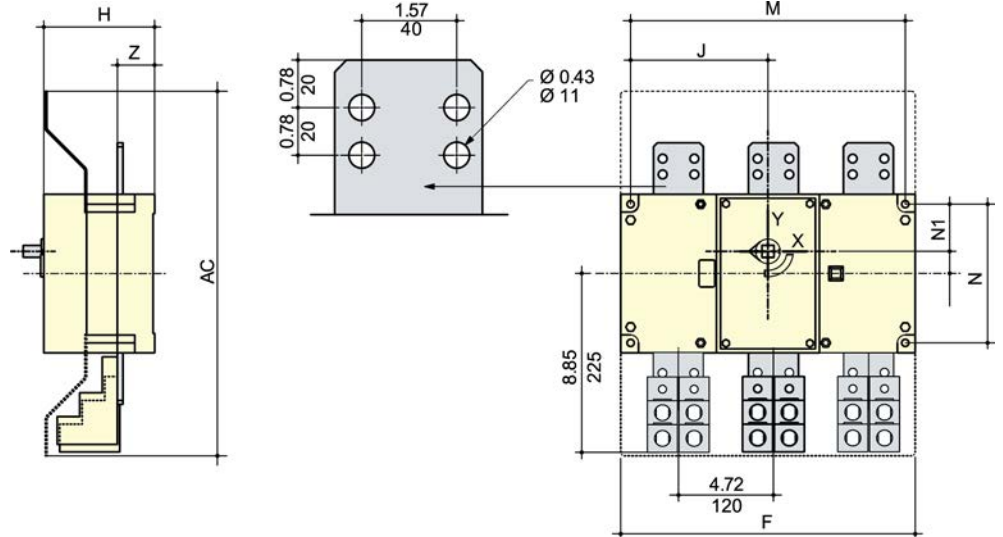

Rating (A)	Dimensions = in. (mm)							
	AC	F	H	J	M	N	N1	Z
800–1200	18.12 (460)	14.64 (372)	5.5 (140)	6.83 (173.5)	13.66 (347)	6.88 (175)	2.34 (59.5)	1.85 (47)

Refer to Catalog 9421CT0301

**Handle for 800–1200 A Fusible Disconnect Switches**

Handle Part No.  
GS2AH170  
GS2AH180

Dimensions:  $\frac{\text{in.}}{\text{mm}}$

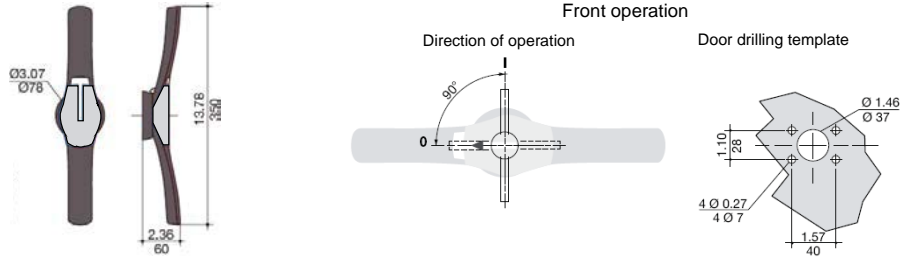

**GS1DDU3, 30 A Fusible Disconnect Switches, Class CC Fuses and GS1DU3, 30 A Fusible Disconnect Switches, Class J Fuses—Dimensions**

**Handle for 30 A and 60 A Fusible Disconnect Switches**

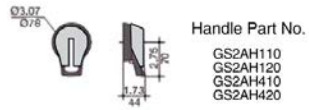

Handle Part No.  
GS2AH110  
GS2AH120  
GS2AH410  
GS2AH420

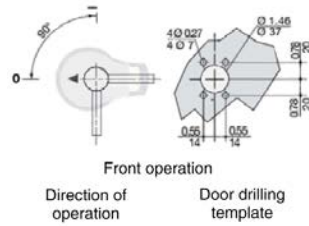

Front operation

Direction of operation

Door drilling template

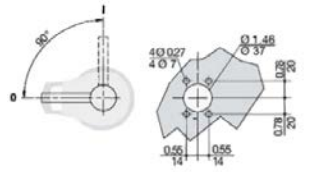

Side operation

Direction of operation

Door drilling template

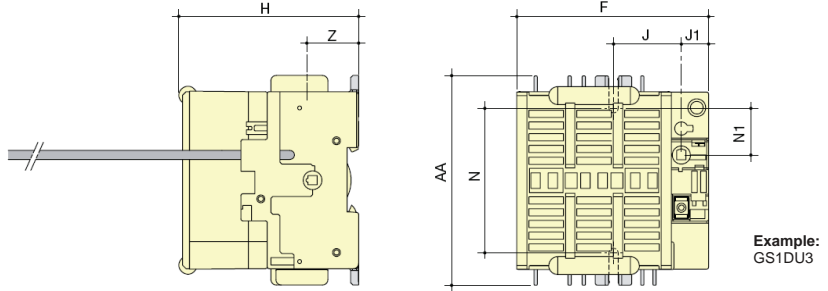

Rating (A)	Dimensions = in. (mm)							
	F	H	J	J1	N	N1	AA	Z
30 / CC	3.78 (96)	3.28 (83.5)	1.47 (37.5)	0.59 (15)	3.13 (79.5)	1 (25.5)	4.56 (116)	1.12 (28.5)
30 / J	4.13 (105)	3.89 (99)	1.47 (37.5)	0.59 (15)	3.13 (79.5)	1 (25.5)	4.56 (116)	1.12 (28.5)

**GS2GU3N, 60 A Fusible Disconnect Switches, Class J Fuses**

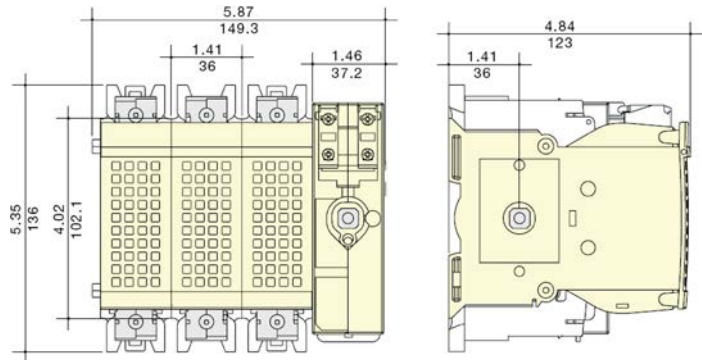

**GS2JU3N, 100 A Fusible Disconnect Switches, Class J Fuses**

Handle for 100 A, 200 A, and 400 A Fusible Disconnect Switches

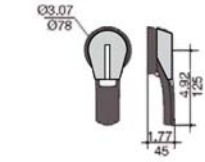

Handle Part No.

- GS2AH130
- GS2AH140
- GS2AH430
- GS2AH440

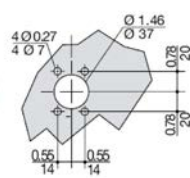
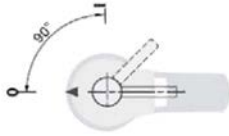

Front operation

Direction of operation

Door drilling template

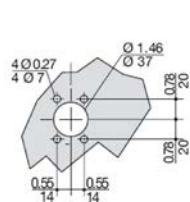
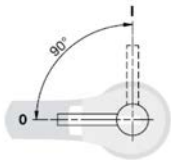

Side operation

Direction of operation

Door drilling template

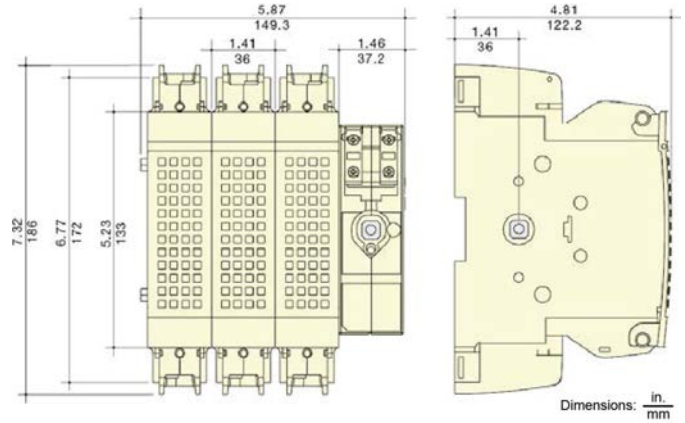

**GS2MU3N, 200 A Fusible Disconnect Switches, Class J Fuses**

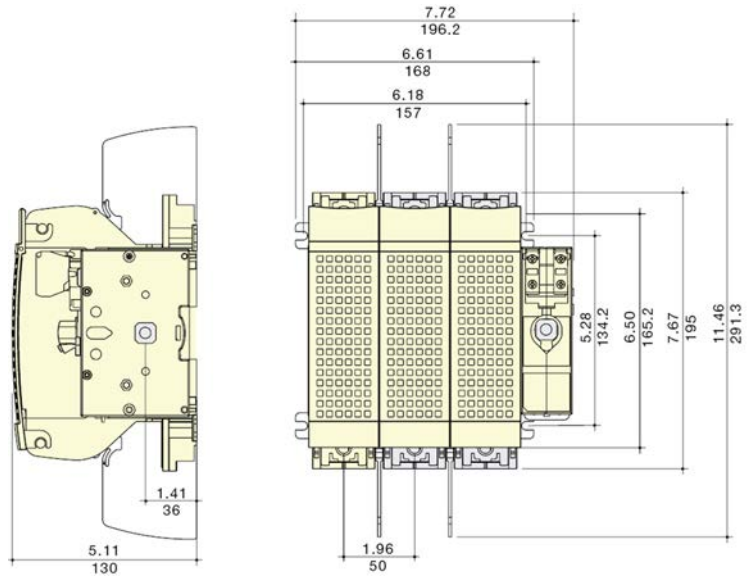



Refer to Catalog 9421CT0301

GS2QU3N, 400 A Fusible Disconnect Switches, Class J Fuses

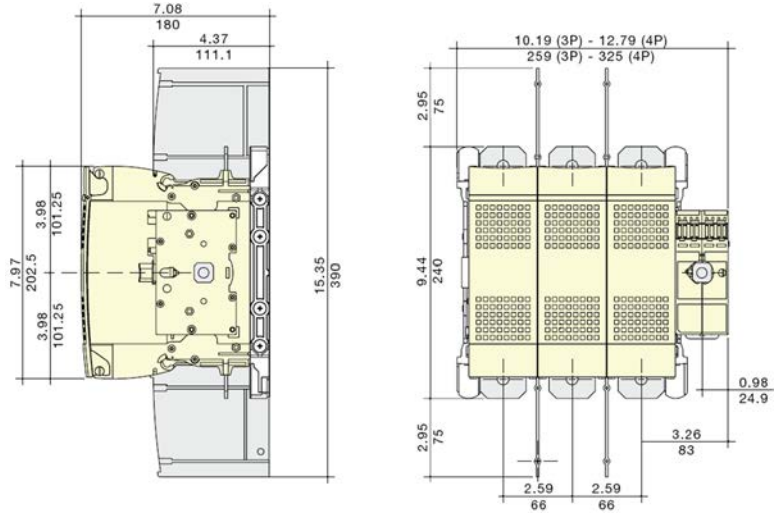

GS2SU3, 600 A Fusible Disconnect Switches, Class J Fuses  
GS2TU3, 800 A Fusible Disconnect Switches, Class J Fuses

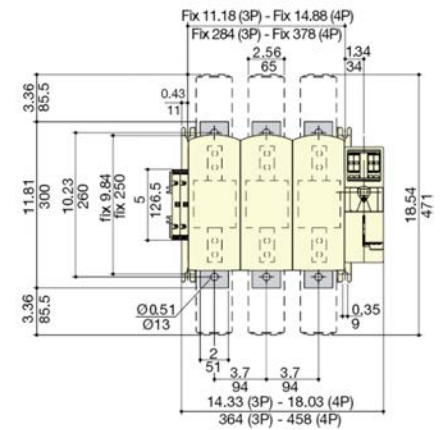
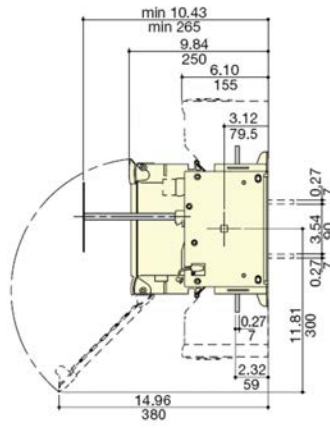
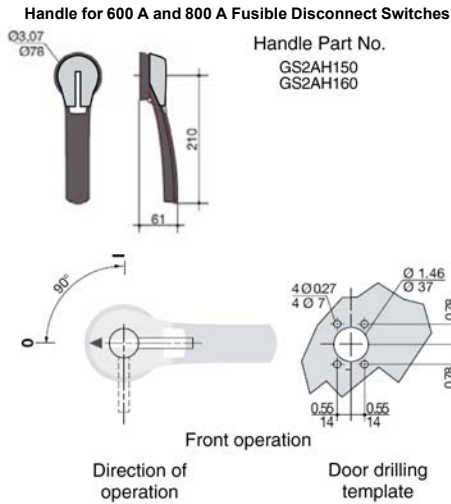

**Disconnect Switches**

The 9422 disconnect switches are the ideal selections for the PV String Combiner Box internal disconnect switch and control panel applications. These switches are designed for variable depth, flange mounting, traditional side mounting and bracket mounting applications providing complete flexibility in the PV string combiner box designs. The switches are compatible with 9422A handle operators and 9423 door mechanisms and are UL 98 recognized (E52369 Vol. 1, Sec. 18) and CSA certified. See page 8-34, page 8-37, and page 8-38 for dimensional information.

**Table 8.75: 9422 Disconnect Switches, Flange Mounted and Variable Depth**

Disconnect Switch Size	Variable Depth (in.)	Maximum Horsepower Ratings						Fuse Type	Fuse Clip Rating (A), Non-Interchangeable Type, For Class H, J, K or R Fuses		Switch and Operating Mechanism ONLY (No Handle Mechanism)	Switch Used with Cable Operators ONLY (No Handle Mechanism or Cable Operator) [1]	Switch and Operating Mechanism with Handle Mechanism, Overpacked[2]			
		AC Systems Volts (Motor Volts)				Vdc			250 V	600 V			Cat. No.	Cat. No.	Type A1 Handle	Type A2 Handle
		208 (200)	240 (230)	480 (460)	600 (575)	250	600								Cat. No.	Cat. No.
30 A	6.625–18	7.5	7.5	15	20	5	15	None	—	—	9422TCN30	9422TCN30C	9422ATCN301	9422ATCN302		
								H, J, K, R	30	—	9422TCF30	9422TCF30C	9422ATCF301	9422ATCF302		
								H, J, K, R	60	30	9422TCF33	9422TCF33C	9422ATCF331	9422ATCF332		
60 A	6.625–18	—	15	30	50	10	30	None	—	—	9422TDN60	9422TDN60C	9422ATDN601	9422ATDN602		
								H, J, K, R	60	30	9422TDF60	9422TDF60C	9422ATDF601	9422ATDF602		
								H, J, K, R	—	60	9422TDF63	9422TDF63C	9422ATDF631	9422ATDF632		
100 A	6.625–18	25	30	60	75	20	50	None	—	—	9422TEN10	9422TEN10C	9422ATEN101	9422ATEN102		
								H, J, K, R	100	100	9422TEF10	9422TEF10C	9422ATEF101	9422ATEF102		
								H, J, K, R	—	—	9422TF1	—	9422ATF11	9422ATF21		
200 A	9.12–19.25 [3]	40	60	125	150	40	50	None	—	—	9422TF2	—	9422ATF12	9422ATF22		
								H, J, K, R	200	200	9422TF2	—	9422ATF12	9422ATF22		
								H, J, K, R	—	400	9422TF3 [4]	—	9422ATF13 [4]	9422ATF23 [4]		
400 A Fixed Depth [5]	11.38 (A5 or A6 Handle)	75	125	250	350	50	50	None	—	—	9422TG1 [6] [7]	—	For handle selection, see page 8-34.			
400 A Variable Depth [5]	15.87–19 (A7 or A8 Handle) [8]							H, J, K, R	400	400	9422TG2 [6] [7]	—				



9422TCN30



Bracket Mounted Disconnect Switch

The 9422 Bracket Mount Disconnect Switch is designed for combiner boxes and control panel applications. The Bracket Mount Disconnect Switch is shipped with the switch and external handle assembled to a bracket, ready for quick installation. A protective trim plate is provided to prevent any mounting screws from being accessible from the front. The trim plate also provides an attractive installation feature. The switches are fully compatible with the 9423 closing mechanisms.

**Table 8.76: 9422 Bracket Mounted Disconnect Switches**

Disconnect Switch Size	Maximum Horsepower Rating						Fuse Type	Fuse Clip Rating (A), Non-Interchangeable Type for Class H, J, K, or R Fuses		Switch and Operating Mechanism Only	
	AC Systems (Motor Volts)				Vdc			250 V	600 V		Cat. No.
	208 (200)	240 (230)	480 (460)	600 (575)	250	600					
30 A	7.5	7.5	15	20	5	15	None	—	—	9422BTCN30	
							H, J, K, R	30	—	9422BTCF30	
							H, J, K, R	60	30	9422BTCF33	
60 A	15	15	30	50	10	30	J [9]	60	30	9422BTCF32	
							None	—	—	9422BTDN60	
							H, J, K, R	60	30	9422BTDN60	
100 A	25	30	60	75	20	50	H, J, K, R	—	60	9422BTDN60	
							H, J, K, R	—	60	9422BTDN60	
							H, J, K, R	—	60	9422BTDN60	
200 A	40	60	125	150	40	50	None	—	—	9422BTEN10	
							H, J, K, R	100	100	9422BTEF10	
							H, J, K, R	100	100	9422BTEF11	
200 A	40	60	125	150	40	50	None	—	—	9422TFB1	
							H, J, K, R	200	200	9422TFB2	
							H, J, K, R	—	400	9422TFB3	

[1] See for ordering information for the cable operator.  
 [2] Variable depth only — no cable operator.  
 [3] 9422 R2 will extend maximum mounting depth 7 inches, see Table 8.86 for information.  
 [4] Accommodates Class J fuses only.  
 [5] Switches are fixed-depth or adjustable depending on handle selection.  
 [6] Commercially available enclosures may not accept 9422TG1 and 2 operating mechanisms. Contact enclosure manufacturer for availability of enclosures for use with these switches.  
 [7] Right hand flange mounting only and requires a special enclosure.  
 [8] Variable in increments of 0.63 inches.  
 [9] Space saving design—Type J fuses mounted on the non-fused bracket.

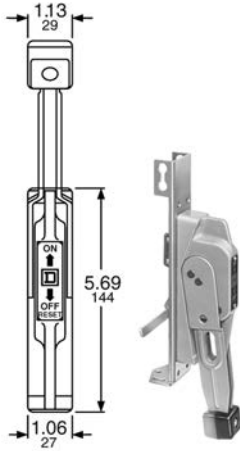

Type A1

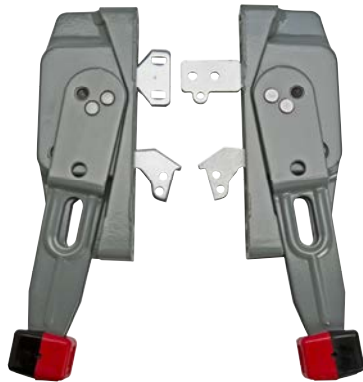

Handle Mechanisms

NOTE: Type 9422A1Y is a 6-in. yellow base with gray handle and red knob.



Handle Mechanisms

Handle Information for 9422 Disconnect Switches

The Handle Mechanism Kit contains all parts needed to mount the handle to the flange of the enclosure. Two flange mounting methods are offered. For right or left hand flange mounting use Types A1–A4 and Types A9–A10 kits. For right-hand mounting only, use Type A5–A8 handles. The type AP1 and AP2 handles are used on the PowerPact™ M and P operating mechanisms, 9422 RM1 and 9422 CMP. The dimensions are identical to 9422 A1.

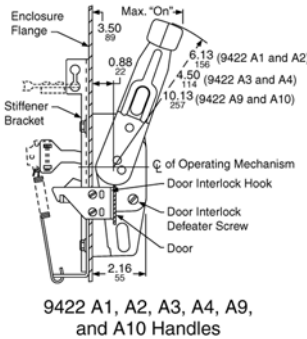

9422 A1, A2, A3, A4, A9, and A10 Handles

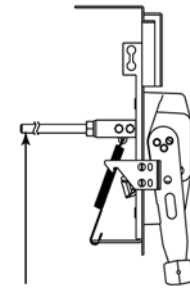

Rod used only on the variable-depth mechanism

Handle Mechanisms

These handle mechanism kits are used with the circuit breaker variable depth and cable operating mechanisms. The kits contain all parts necessary for mounting the handle to the flange of the enclosure. Types A1–A4, A1Y, and AP1 are suitable for right or left-hand flange mounting.

Table 8.77: 9422 Disconnect Switch and Circuit Breaker Handle Mechanisms

Handle Depth (in.)	NEMA Type 1, 3, 3R, 4, 12 Enclosures	NEMA Type 4, 4X Stainless Steel Enclosures
	Cat. No.	Cat. No.
4 [10]	9422A3	9422A4
6 [10]	9422A1	9422A2
	9422A1Y [11]	
6 [12]	9422AP1	9422AP2
10 [13]	9422A9	9422A10
10	9422AP9	9422AP10
12 [14] [15]	9422A7	9422A8

NOTE: See Handle Information, page 8-34 for dimensional information.

Accessories

Class R Fuse Kits

When installed, this kit rejects all fuses except Class R. The kits are available for field installation. With rejection kit and Class R fuses installed, the switch is UL component recognized for use on systems with fault current up to 200,000 RMS symmetrical amperes.

Table 8.78: Class R Fuse Kits

Disconnect Switch Type	Switch Type	Fuse Clip Rating		Class R Kit Cat No.
		250 V	600 V	
30 A	TCF30	30	—	RFK03
	TCF33	60	30	RFK06
60 A	TDF60	60	30	RFK06
	TDF63	—	60	RFK06H
100 A	TEF10	100	100	RFK10
200 A	TF2	200	200	9999SR4
	TF3	200	200	9999SR4
400 A	TG2	400	400	9999SR5

[10] Use with 30–200 A, 9422 switches and all circuit breaker mechanisms.  
 [11] Yellow base with gray handle and red knob.  
 [12] Use only with 9422RM1, 9422CMP, and PowerPact M and P operating mechanisms.  
 [13] Use with Type D2 remote or dual adapter kit.  
 [14] Use only with 400 A, 9422TG1 and 9422TG2 disconnect switch.  
 [15] Adjustable depth.

**Electrical Interlocks for Disconnect Switches**

**Table 8.79: Electrical Interlocks**

Disconnect Switch Size	Switch Type	Electrical Interlocks
		Cat No.
30 A 60 A 100 A	TCF, TCN, TDF, TDN, TEF, TEN	9999TC10 [16]
		9999TC20 [17]
	BTCF, BTCN, BTDF, BTDN, BTEF, BTEN	9999TC11 [16]
		9999TC21 [17]
200 A	TF, ATF	9999R8 [16]
	TF, ATF	9999R9 [17]
400 A	TG	9999R35 [16]
	TG	9999R36 [17]

**Internal Barrier Kits**

Provides an additional barrier that helps prevent accidental contact with live parts. Field-installed transparent barriers do not restrict visual inspection of the switch. Barriers provide IEC529 IP2X “finger safe” protection when door of enclosed disconnect switch is open. A convenient door allows use of test probes without accessing fuses and replacement of fuses without removing barrier. Barrier must be used with the skirt kit to enclose a panel mounted 9422 disconnect.



**Table 8.80: Internal Barrier Kits**

Disconnect Switch Size	Barrier	Skirt
	Cat. No.	Cat No.
30 A	SS06	SS0306SK
60 A	SS06	SS0306SK
100 A	SS10	SS10SK

**Cable Operators for 9422 Disconnect Switches**

**Table 8.81: Cable Operators for 9422 Disconnect Switches**

Switch Type	Cable Mechanisms [18]		Cable Mechanisms with A1 Handle for NEMA Type 1, 3, 3R, 4, and 12 Enclosures
	Cable Length (in.)	Cat. No.	Cat. No.
TCN30C, TCF30C, TCF33C, TDN60C, TDF60C, TDF63C, TEN10C, TEF10C	36	9422CFT30	9422CFT31
	48	9422CFT40	—
	60	9422CFT50	9422CFT51
	120	9422CFT10	9422CFT11

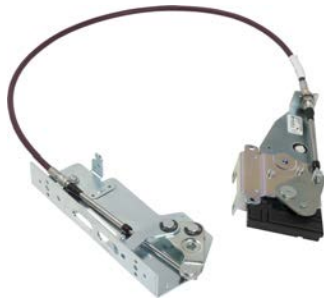

9422CFT40

**Table 8.82: Class 9422 Replacement / Retrofit Fuse Clip Kits**

Disconnect Switch Size	Switch Type	Fuse Type	Fuse Clip Rating (A)		Line and Load Fuse Clip Kit (includes load base and fuse pullers)
			250 V	600 V	Cat. No.
30 A	TCF30 TCN30 TCF33	H, K, J, R	30	—	9422TC30
			60	30	9422TC33
60 A	TDN60	H, K, J, R	60	30	9422TC33
			—	60	9422TD63

**Table 8.83: Lug Data**

Disconnect Switch Size	Wire Size (Min.–Max.)		Lug Kits, Cu	Lug Kits, Al
	Cu	Al	Cat No.	Cat No.
30–60 A	14–2 AWG	10–2 AWG	CL0306F	AL0306F
100 A	10–0 AWG	6–0 AWG	CL10F	AL10F
200 A	6 AWG – 600 kcmil	6 AWG – 600 kcmil	—	—
400 A	4 AWG – 500 kcmil	—	—	—

[16] 1 N.C. or N.O. Contact depending on wiring.

[17] 2 N.C. or N.O. or 1 N.O. or 1 N.C. Contact depending on wiring.

[18] Purchase handle mechanism separately (9422A1, A2, A3, or A4).

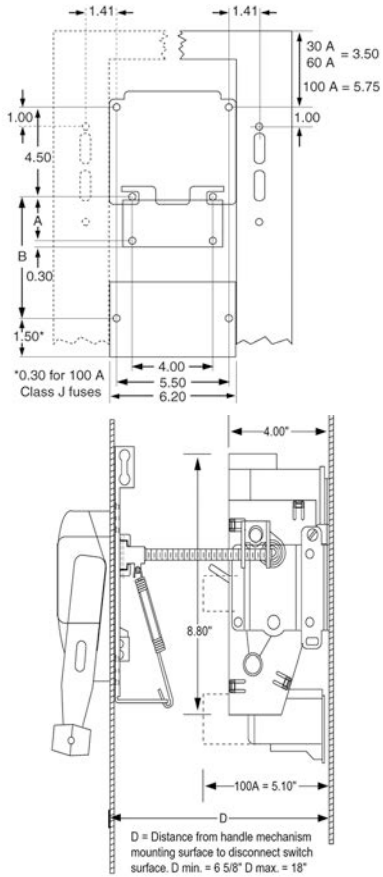

Table 8.84: Dimensions 30, 60, and 100 A Class 9422 Disconnect Switches

Switch Type	Maximum Voltage	Fuse Type	Dimension A	Dimension B
30 A	30 A, 250 V	H, K, R	1.625	—
	30 A, 600 V	H, K, R	4.25	
	30 A, 600 V	J	1.625	
60 A	60 A, 250 V	H, K, R	2.25	
	60 A, 600 V	H, K, R	4.75	
	60 A, 600 V	J	1.625	
100 A	100 A, 250 V	H, K, R	—	3.25
	100 A, 600 V	H, K, R	—	5.25
	100 A, 600 V	J	—	3.25

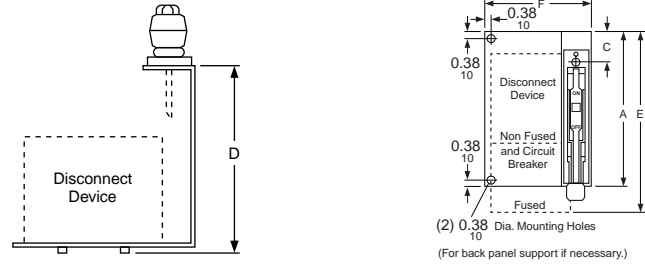

Table 8.85: Dimensions

Type	A in. (mm)	C in. (mm)	D in. (mm)	Min. Enclosure Depth [19] in. (mm)	E in. (mm)	
					Fusible Device	F in. (mm)
BTCN, BTDN, BTEN	—	—	6.56 (167)	8.00 (203)	—	—
BTCF, BTDF, BTEF	9.50 (241)	1.88 (48)	8.56 (217)	10.00 (254)	11.88 (302)	6.38 (162)
TFB1	11.50 (292)	3.88 (99)	9.50 (241)	12.00 (305)	—	13.19 (335)

**NOTE:** Back panel support is recommended for Types TFB1, 2, & 3. Other devices may also require support if the flange is not sufficiently rigid.

[19] The minimum enclosure depth is greater than Dimension D since additional space is needed when mounting the mechanism.

**Dimensions**

**Table 8.86: Dimensions (in. / mm) for 200 A Type TF Disconnect Switches**

Type	Switch Size		A	B	C	D [20]	E	F	G	H	J	K	L	M	N	P	Q	R	S	T
	(A)	Fuse Clips																		
TF1	200	None	13.33 339	9.38 238	1.64 42	9.12-19.25 232-489	2.33 59	8.00 203	—	—	—	9.44 240	6.50 165	9.53 242	—	—	—	3.14 80	1.03 26	0.75 19
TF2	200	Class J 200 A 600 V	13.33 339	9.38 238	1.64 42	9.12-19.25 232-489	2.33 59	8.00 203	0.09 3	—	2.77 70	9.44 240	6.50 165	—	14.11 358	—	9.63 245	3.14 80	1.03 26	0.75 19
TF2	200	Class H, K, R 200 A 250 V	13.33 339	9.38 238	1.64 42	9.12-19.25 232-489	2.33 59	8.00 203	0.09 3	—	4.14 105	9.44 240	6.50 165	—	15.48 393	—	9.63 245	3.14 80	1.03 26	0.75 19
TF2	200	Class H, K, R 200 A 600 V	13.33 339	9.38 238	1.64 42	9.12-19.25 232-489	2.33 59	8.00 203	0.09 3	—	6.64 169	9.44 240	6.50 165	—	17.98 457	—	9.63 245	3.14 80	1.03 26	0.75 19
TF3	200	Class J 400 A 600 V	13.33 339	9.38 238	1.64 42	9.12-19.25 232-489	2.33 59	8.00 203	0.09 3	—	2.77 70	9.44 240	6.50 165	9.53 242	18.53 471	—	9.63 245	3.14 80	1.03 26	0.75 19

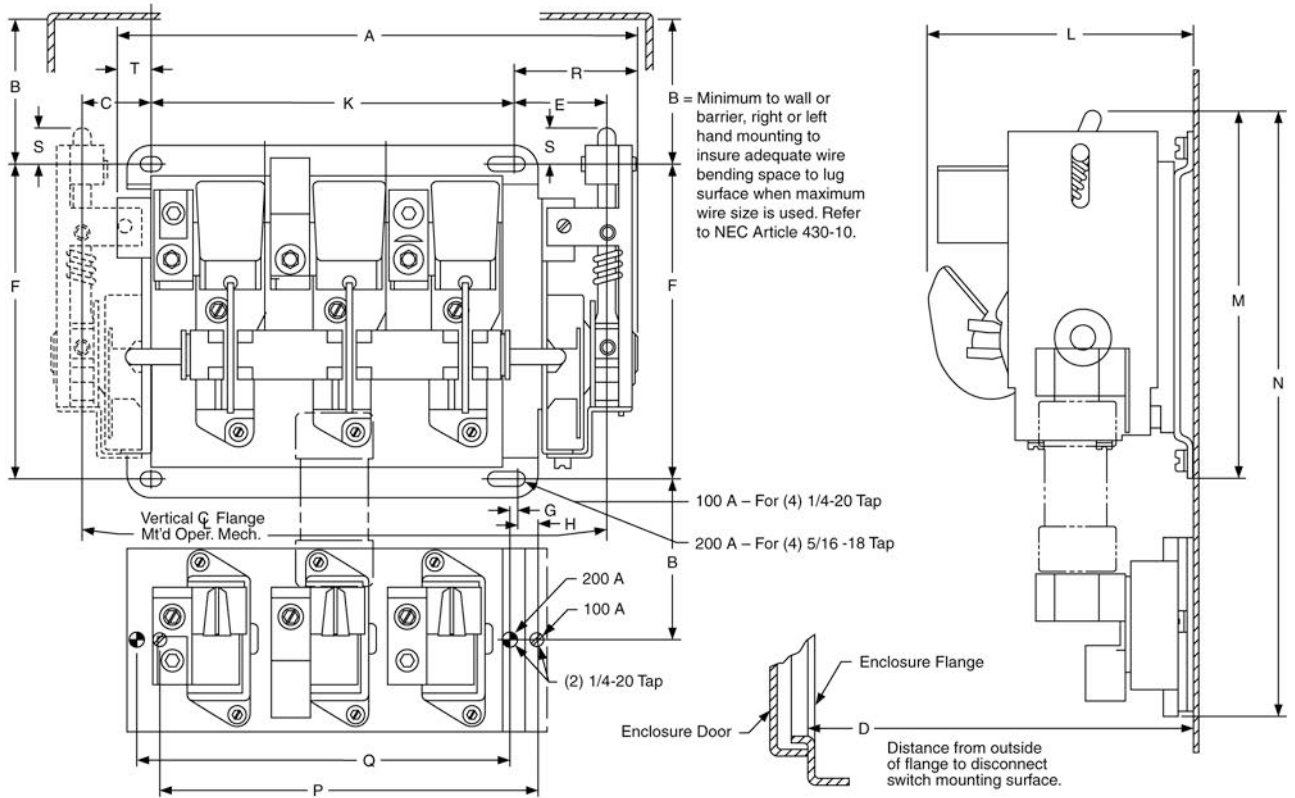

[20] The dimensions shown may be extended 7 in. by using 9422R2 (two required per switch).

Disconnect Switches—400 A Type TG

Outline Dimensions and General Location

400 A Disconnect Switches Nonfusible and Non-Interchangeable Fuse Clip Type Fusible Switches

Table 8.87: Handle Mechanism—Types A7 and A8

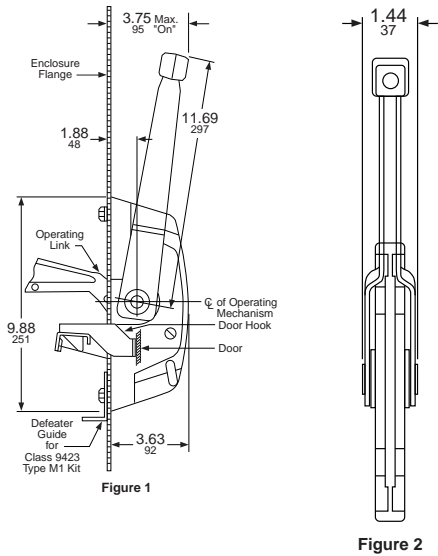

**NOTE:** Commercially available enclosures may not accept type TG operating mechanisms. Contact the enclosure manufacturer for availability of enclosures for use with these switches.

Switch Type	B	X
TG1, 2	11.28 286	16.06 408

**NOTE:** B and X = Minimum to wall or barrier to ensure adequate wire bending space to lug surface when maximum wire size is used. Refer to NEC Article 430.10.

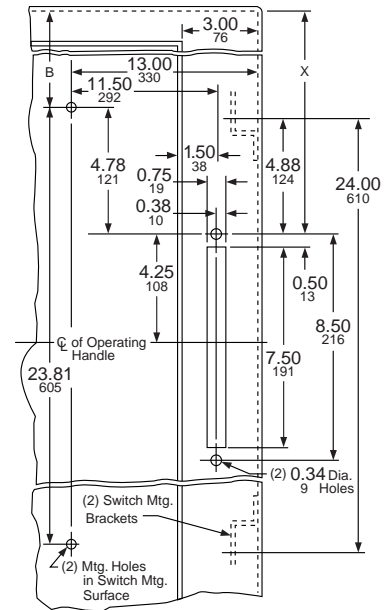

Figure 3

Table 8.88: Nonfusible and Fusible Switches

Dimension D = Distance from outside of flange to disconnect switch mounting surface.

For Type TG1 or TG2 with:

Type A7 or A8 adjustable depth handle mechanism	D =	15.87 403	to	19 483
In steps of		0.63 16		

**NOTE:** Copper lugs are standard on all Type TG disconnect switches.

\* D = Mounting depth measured from the switch mounting surface to the surface of flange.

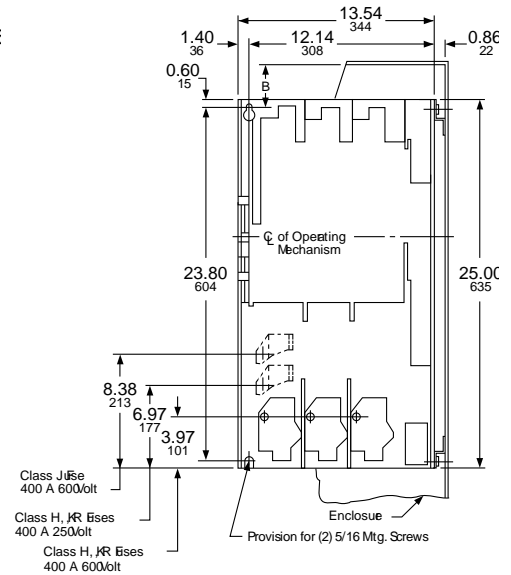
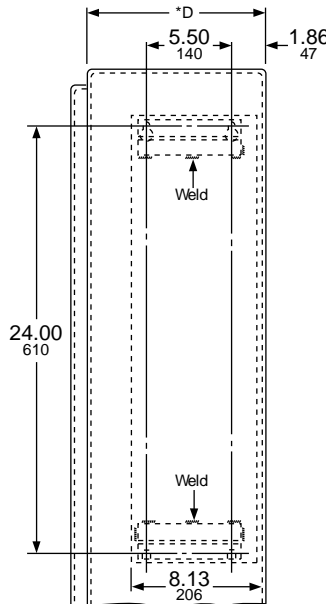

Dim. =  $\frac{\text{in.}}{\text{mm}}$

**Type L Circuit Breaker Mechanisms**

Type L door-mounted, variable depth operating mechanisms feature heavy duty, all metal construction with trip indication. All mechanisms can be padlocked in the Off position when the enclosure door is open. Further, the handle assemblies can be locked Off with up to three padlocks, which also locks the enclosure when the door is closed. (The 3 in. handle accepts one padlock.) Complete kits are rated for NEMA 1, 3R, and 12 enclosures. They include a handle assembly, operating mechanism, and shaft assembly.



**9421 Type L  
Circuit Breaker Operating Mechanism**

**Table 8.89: Complete Kits**

Complete Kit Does Not Include Circuit Breaker			Includes Operating Mechanism and Handle					
Use With			Standard 6 in. Handle			Short 3 in. Handle		
			Standard Shaft Kit		Long Shaft Kit	Long Shaft Kit		
Circuit Breaker or Interrupter Type	No. of Poles	Frame Size (A)	Cat. No.	Mounting Depth [1]	Cat. No.	Mounting Depth [1]	Cat. No.	Mounting Depth [1]
PowerPact™ B	2-3	125	9421LB1	5.50-10.75	9421LB4	5.50-21.38	9421LB3	5.50-21.38
PowerPact H and J	2-3	250	9421LJ1	5.50-10.75	9421LJ4	5.50-21.38	9421LJ3	5.50-21.38
PowerPact L	2-3	600	9421LD1	7.25-12.06	9421LD4	7.25-22.63	3 in. handles are not recommended for use with these circuit breakers.	
PowerPact M and P [2]	3	1200	9421LW1 [3]	9.00-12.50	9421LW4 [3]	9.00-23.50		

**Table 8.90: Component Parts**

Use With			3 in. Handle Assemblies NEMA 1, 3R, 12	Standard Handle Assemblies NEMA 1, 3R, 12	Operating Mechanism Includes Lockout	Standard Shaft (Support Bracket Not Required)		Long Shaft (Support Bracket Required)	
Circuit Breaker or Interrupter Type	No. of Poles	Frame Size (A)	Cat. No.	Cat. No.	Cat. No.	Mounting Depth [1]	Cat. No.	Mounting Depth [1]	Cat. No.
PowerPact B	2-3	125	9421LH3 [4]	9421LH6 [4]	9421LB7	5.50-10.75	9421LS8	5.50-21.38	9421LS13
PowerPact H & J	2-3	250	9421LH3 [4]	9421LH6 [4]	9421LJ7	5.50-10.25	9421LS8	5.50-21.38	9421LS13
PowerPact D & L	2-3	600	[5]	9421LH6 [4]	9421LD7	7.25-12.06	9421LS8	7.25-22.63	9421LS13
	4	1200 (300 V)	—	9421LH6 [4]	9421LD14	7.25-12.06	9421LS8	—	—
				—	9421LD44	—	—	7.25-22.63	9421LS13
PowerPact M & P [2]	3	1200	[5]	9421LHP8 [4]	9421LW7	7.19-11.63	9421LS8	7.19-22.25	9421LS10

**Table 8.91: NEMA 4 and 4X Handle Assemblies**

Use With			Standard Handle Assemblies		Special 3 in. Version	
Circuit Breaker or Interrupter Type	No. of Poles	Frame Size (A)	NEMA 1, 3R, 4, 12 (Painted)	NEMA 1, 3R, 4, 4X, 12 (Chrome Plated)	NEMA 1, 3R, 4, 12 (Painted)	NEMA 1, 3R, 4, 4X, 12 (Chrome Plated)
			Cat. No.	Cat. No.	Cat. No.	Cat. No.
PowerPact B	2-3	125	9421LH46	9421LC46	9421LH43	9421LC43
PowerPact H and J; NSF	2-3	250	9421LH46	9421LC46	9421LH43	9421LC43
PowerPact D and L	2-3	600	9421LH46	9421LC46	3 in. handles are not recommended for use with these circuit breakers.	
PowerPact M and P	3	1200	9421LHP48	9421LCP48		

**Table 8.92: Auxiliary and Alarm Switches for PowerPact™ Circuit Breakers**

Description	B-Frame	H- and J-Frame	D- and L-Frame	D- and L-Frame
1 Auxiliary Switch 1a 1b	LV26950	S29450	S29450	S29450
2 Auxiliary Switch 2a 2b	—	2 x S29450	2 x S29450	2 x S29450
3 Auxiliary Switch 3a 3b	—	—	3 x S29450	3 x S29450

**NOTE:** The location of the accessory in the circuit breaker determines its function.



[1] Mounting depth measured in inches from circuit breaker mounting surface (control panel) to outside of enclosure door.  
 [2] These circuit breaker operating mechanisms must use the 9421LHP\*\* or LCP\*\* handles only.  
 [3] Type LW1 and LW4 include an 8 in. handle (9421LHP8) rather than a 6 in. handle.  
 [4] For a red handle and yellow bezel, add suffix RY to catalog number, e.g., 9421LH6RY.  
 [5] 3 in. handles are not recommended for use with these circuit breakers.



Dimensions for Type L Operating Mechanisms

Panel Drilling for PowerPact™ H and J Circuit Breaker Operating Mechanisms: 9421LJ1, 9421LJ4, and 9421LJ7

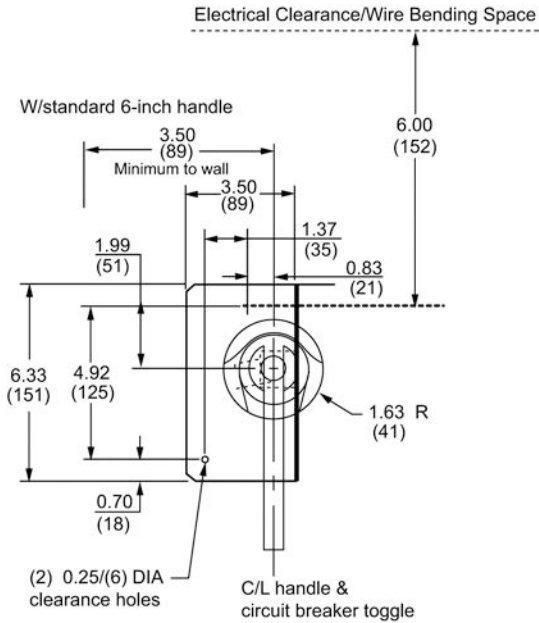

Panel Drilling for PowerPact™ D and L Circuit Breaker Operating Mechanisms: 9421LD1, 9421LD4, and 9421LD7

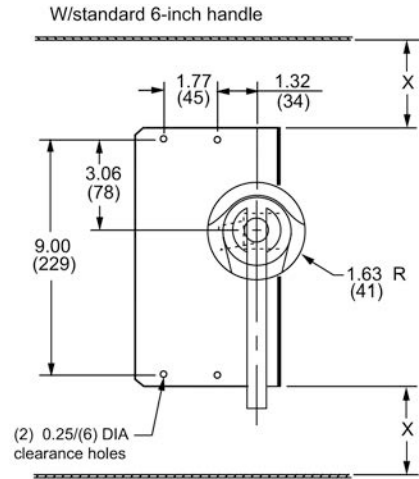

X: Minimum to wall or barrier to insure adequate wire bending space to lug surface when the maximum wire size is used. Refer to NEC 430-10.

Panel Drilling for PowerPact™ M and P Circuit Breaker Operating Mechanisms: 9421LW1, 9421LW4, and 9421LW7

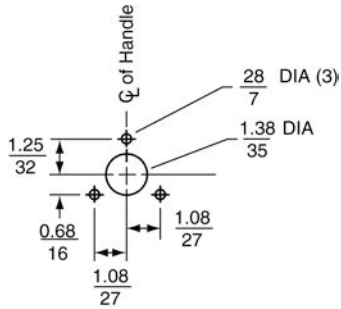

Door Drilling Dimensions

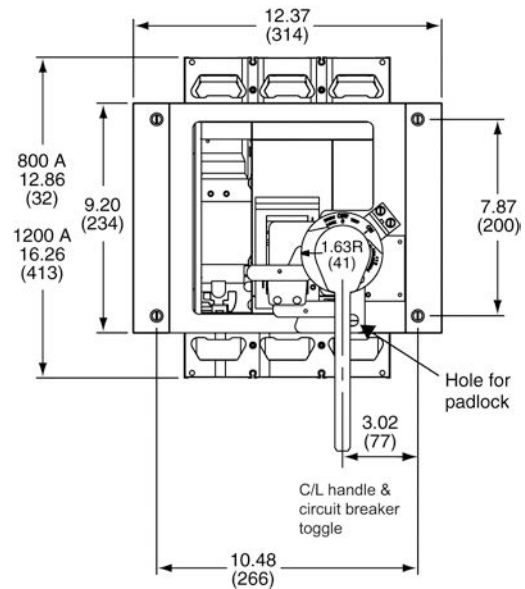
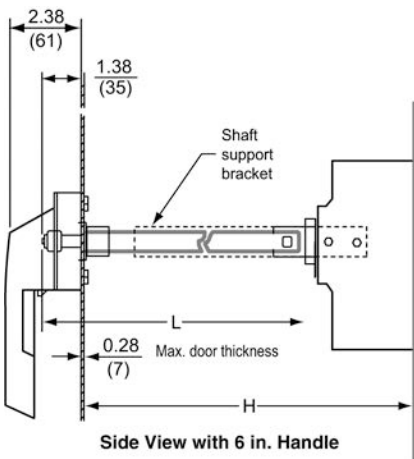
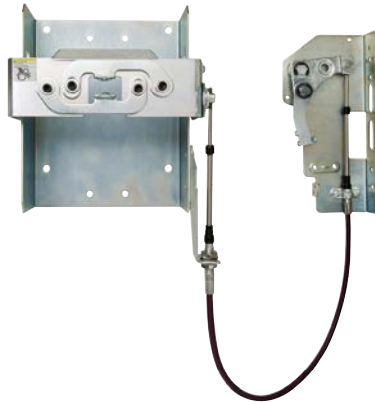

Table 8.93: Shaft Cutting Dimensions

Class	Type	Shaft Length Formula	H = Standard Shaft		H = Long Shaft	
			Min.	Max.	Min.	Max.
9421	LJ1, LJ4, LJ7	L = H - 3.00 (76)	5.5 (138)	10.75 (273)	5.5 (138)	21.63 (543)
9421	LD1, LD4, LD7	L = H - 4.25 (108)	7.25 (184)	12.06 (306)	7.25 (184)	22.63 (575)
9421	LW1, LW4, LW7	L = H - 4.89 (124)	7.19 (183)	11.63 (295)	7.19 (183)	22.25 (565)





**Flexible Cable Mechanism  
9422CSJ30**

**Flexible Cable Mechanisms**

- For use with Class 9422 handle operators (you must select a 9422A• handle to complete the operating mechanism)
- Specially designed for tall, deep enclosures where placement flexibility is required

**Table 8.94: Flexible Cable Mechanisms for use with Schneider Electric™ (formerly Merlin Gerin™) Circuit Breakers and PowerPact™ 3-Pole Circuit Breakers**

Circuit Breaker Type	No. of Poles	Frame Size (A)	Cable Mechanism	
			Length	Catalog No.
PowerPact B-Frame	2-3	125	36 in.	9422CSB30
			60 in.	9422CSB50
			84 in.	9422CSB70
			120 in.	9422CSB10
MG-NSF PowerPact H- and J-Frame	2-3	250	36 in.	9422CSF30
			60 in.	9422CSF50
			84 in.	9422CSF70
			120 in.	9422CSF10
MG-NSF	4	250	36 in.	9422CSF304
			60 in.	9422CSF504
			120 in.	9422CSF104
MG-NSJ PowerPact D- and L-Frame	3	600	36 in.	9422CSJ30
			60 in.	9422CSJ50
			120 in.	9422CSJ10
MG-NSJ PowerPact D- and L-Frame	4	600	36 in.	9422CSJ304
			60 in.	9422CSJ504
			120 in.	9422CSJ104
PowerPact M- and P-Frame [6]	3	1200	48 in.	9422CMP40
			50 in.	9422CMP50
			120 in.	9422CMP10

**NOTE:** Refer to NEC Article 430-10 for minimum dimension X from circuit breaker top mounting hole to wall or barrier to ensure adequate wire bending space.  
**NOTE:** Bend radius in cable must never be less than 6 inches. Electrical clearances must be maintained between cable and live electrical parts.

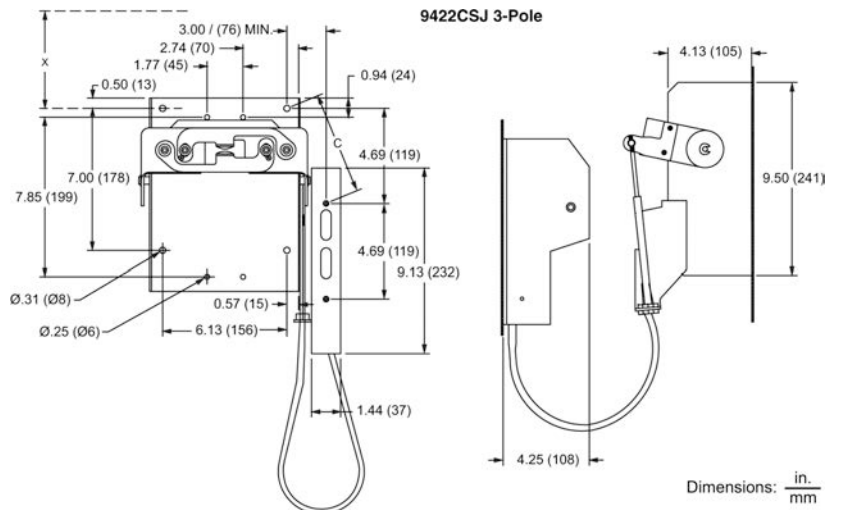
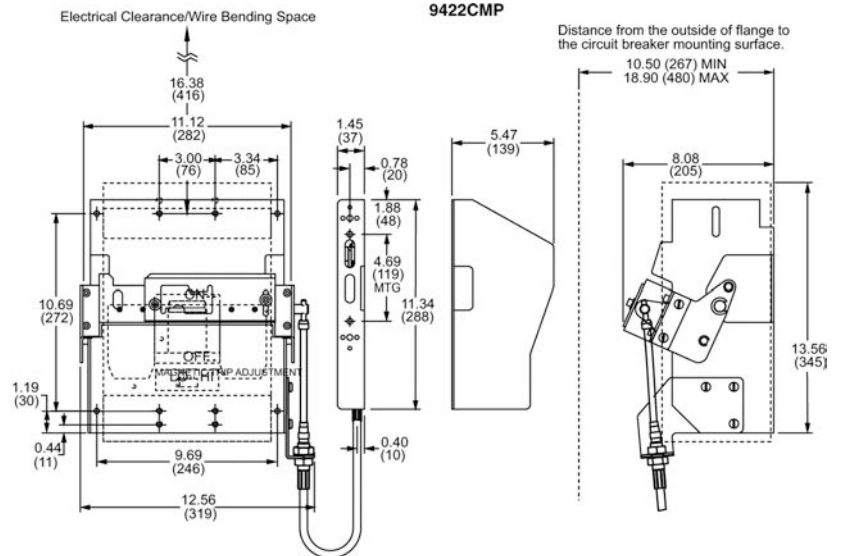
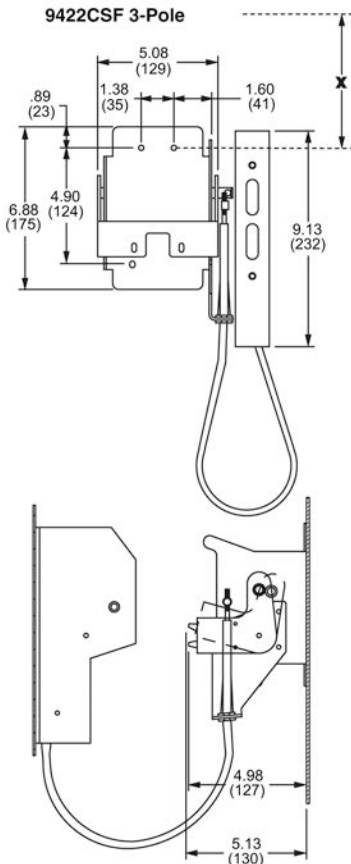

Dimensions: in./mm

[6] Must use 9422AP1 or 9422AP2 Handle with this operating mechanism.



**Dual Cable Operating Mechanisms for Square D™ Circuit Breakers**

Dual Cable Operating Mechanisms are designed for use with Square D brand PowerPact™ B, D, H, J, and L circuit breakers through 600 A frame sizes. The cable mechanisms allow for a single handle operator, Class 9422A, to operate both circuit breakers. The cable mechanism is designed especially for tall, deep enclosures where placement flexibility is required. There are numerous cable arrangements to choose from to accommodate many applications.

**Features**

- Separate cables for each circuit breaker
- Rugged metal flange handle operator
- Maximized flexibility of circuit breaker placement for existing and new applications
- Control panel can be fed from two separate supply voltages (if required)
- Dual mechanism allows both separate supply voltages to be controlled by a single handle to improve security features

**Table 8.95: Dual Cable Operating Mechanisms Selection**

Circuit Breaker Type	Cable Length in. / mm (quantity)	Catalog Number	Frame Size (max.)
PowerPact B	120 in. / 3048 mm (2)	9422CSBD1	125 A
	36 in. / 914 mm (1) 60 in. / 1524 mm (1)	9422CSBD35	
	60 in. / 1524 mm (1-CSF 3 pole) 60 in. / 1524 mm (1-CSF 4 pole)	9422CSBD55	
	36 in. / 914 mm (1) 120 in. / 3048 mm (1)	9422CSBD31	
	36 in. / 914 mm (2)	9422CSBD33	
	60 in. / 1524 mm (1) 120 in. / 3048 mm (1)	9422CSBD51	
PowerPact H & J MG NSF	120 in. / 3048 mm (2)	9422CSFD1	250 A
	36 in. / 914 mm (1) 60 in. / 1524 mm (1)	9422CSFD35	
	60 in. / 1524 mm (1-CSF 3 pole) 60 in. / 1524 mm (1-CSF 4 pole)	9422CSFD345	
	36 in. / 914 mm (1) 120 in. / 3048 mm (1)	9422CSFD31	
	36 in. / 914 mm (2)	9422CSFD33	
	60 in. / 1524 mm (1) 120 in. / 3048 mm (1)	9422CSFD51	
	60 in. / 1524 mm (2)	9422CSFD55	
	60 in. / 1524 mm (2-CSJ) 120 in. / 3048 mm (2-CSJ)	9422CSJD50 [7]	
120 in. / 3048 mm (2-CSJ)	9422CSJD10 [8]		
60 in. / 1524 mm and 120 in. / 3048 mm (2-CSJ)	9422CSJD51[8]		
120 in. / 3048 mm (1-CSF) and 120 in. / 3048 mm (1-CSJ)	9422CSFJD10	250 A and 600 A	
60 in. / 1524 mm (1-CSF) 60 in. / 1524 mm (1-CSJ)	9422CSFJD50		

**Handle Mechanisms**

These handle mechanism kits are used with the circuit breaker variable depth and cable operating mechanisms. The kits contain all parts necessary for mounting the handle to the flange of the enclosure. Types A1–A4, A1Y, and AP1 are suitable for right or left-hand flange mounting.

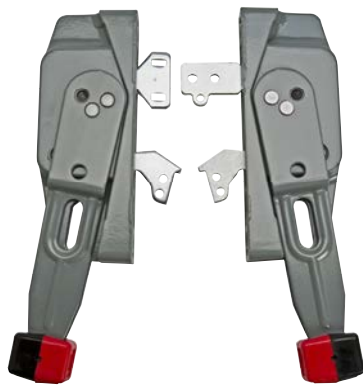

Handle Mechanisms

NOTE: Type 9422A1Y is a 6-in. yellow base with gray handle and red knob.

**Table 8.96: 9422 Disconnect Switch and Circuit Breaker Handle Mechanisms**

Handle Depth (in.)	NEMA Type 1, 3, 3R, 4, 12 Enclosures	NEMA Type 4, 4X Stainless Steel Enclosures
	Cat. No.	Cat. No.
4 [9]	9422A3	9422A4
6 [9]	9422A1	9422A2
	9422A1Y [10]	
6 [11]	9422AP1	9422AP2
10 [12]	9422A9	9422A10
10	9422AP9	9422AP10
12 [13] [14]	9422A7	9422A8

NOTE: See Handle Information, page 8-34 for dimensional information.

[7] Must use the 9422AP1 or 9422AP2 operating handle with this operating mechanism.  
 [8] Must use the 9422AP1 or 9422AP2 operating handle with this operating mechanism.  
 [9] Use with 30–200 A, 9422 switches and all circuit breaker mechanisms.  
 [10] Yellow base with gray handle and red knob.  
 [11] Use only with 9422RM1, 9422CMP, and PowerPact M and P operating mechanisms.  
 [12] Use with Type D2 remote or dual adapter kit.  
 [13] Use only with 400 A, 9422TG1 and 9422TG2 disconnect switch.  
 [14] Adjustable depth.



**9422 Type R  
Circuit Breaker Mechanism**

**Flange-Mounted, Variable-Depth Operating Mechanisms**

Designed for installation in custom built control enclosures where main or branch circuit protective devices are required. All circuit breaker operating mechanisms are suitable for either right- or left-hand flange mounting, convertible on the job.

**NOTE:** The operating mechanisms do not include handle mechanisms. You must select a 9422A• handle to complete the installation.

**Table 8.97: Variable-Depth Operating Mechanisms for Use with Schneider Electric™ Brand Circuit Breakers (Formerly Merlin Gerin™ Brand)**

Use with				Operating Mechanism (Does Not Include Handle Mechanism)
Circuit Breaker Frame Size	No. of Poles	Frame Size A	Variable Depth Mtg. Range (in.) [15]	Cat. No.
Schneider Electric (formerly Merlin Gerin) Circuit Breakers and PowerPact™ Frame 3-Pole Circuit Breakers				
PowerPact B-Frame	2-3	125	5.88-17.75	9422RB1
MG-NSF PowerPact H- and J-Frame	2-3	250	5.88-17.75	9422RQ1
MG-NSJ PowerPact D- and L-Frame	3	600	9.00-17.75	9422RS1
PowerPact M- and P-Frame [16]	3	1200	10.50-18.38	9422RM1

**Table 8.98: Electrical Interlocks—Class 9999**

Description	Cat. No.
Single Pole, Double Throw	9999R26
Double Pole, Double Throw	9999R27

[15] Class 9422 Type R2 will extend mounting depth 7 inches—not recommended for use with the 9422RM1 operating mechanism (see Table 8.96).

[16] These circuit breaker operating mechanisms must use the 9422APx handles.

### Dimensions

Minimum wall or barrier to insure adequate wire bending space to lug surface when the maximum wire size is used with standard lugs. Refer to NEC 430-10.

Dimensions: in.  
mm

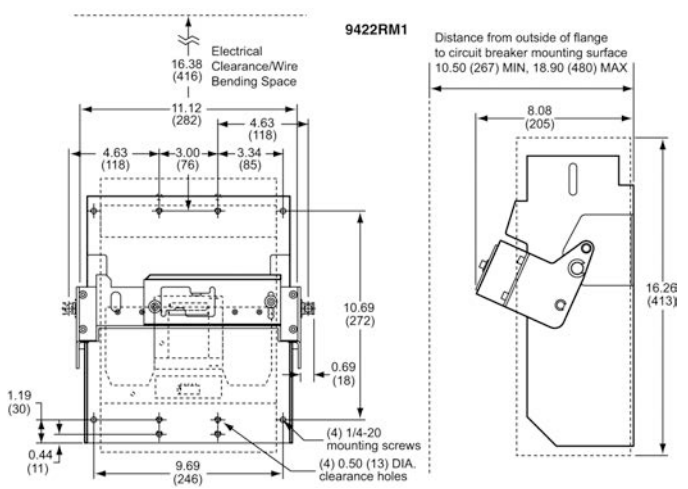
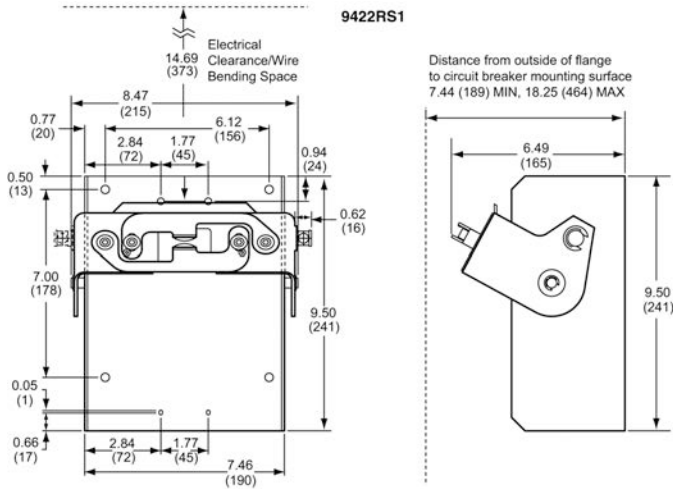
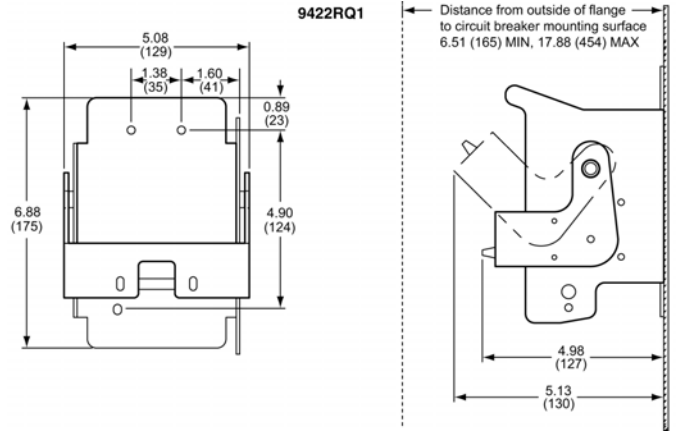

# Section 9

## Panelboards



NQ Panelboards



NF Panelboards



I-Line Panelboards



QMB Panelboards

<b>Panelboard Series Ratings</b>	<b>9-2</b>
<hr/>	
<b>NQ Panelboards—240 Vac, 48 Vdc</b>	<b>9-10</b>
<hr/>	
Selection Procedure for NQ Merchandised Panelboards	9-10
NQ Merchandised Main Lug Interiors	9-11
NQ Merchandised Main Circuit Breaker Interiors	9-12
QOB Circuit Breakers for NQ Panelboards	9-15
NQ Factory Assembled Panelboards	9-18
NQ Surge Protective	9-22
NQ Panelboard Accessories	9-23
Fingersafe IP2X per IEC 60529 Barriers for NQ Panelboards	9-26
<b>NF Panelboards—600Y/347 Vac Max.</b>	<b>9-28</b>
<hr/>	
Selection Procedure for NF Merchandised Panelboards	9-28
NF Merchandised Main Lug Three Phase Interiors	9-29
NF Merchandised Main Circuit Breaker Interiors	9-30
E-Frame Circuit Breakers for NF Panelboards	9-31
NF Factory Assembled Main Circuit Breakers	9-33
NF Factory Assembled Panelboard Common Features	9-34
NF Panelboard Accessories	9-36
<b>Separated Distribution and Split Bus Panelboards</b>	<b>9-38</b>
<hr/>	
Separated Distribution and Split Bus NF and NQ Panelboards	9-38
<b>Single Row (Column Width) NF and NQ Panelboards</b>	<b>9-40</b>
<hr/>	
NQ Single-Row Panelboards—240 Vac Bolt-on	9-40
NF Single-Row Panelboards—480Y/277 Vac Bolt-on	9-41
<b>Powerlink™ Lighting Control Systems</b>	<b>9-42</b>
<hr/>	
Powerlink Lighting Control Products	9-42
<b>I-Line™ Panelboards—600 Vac, 250 Vdc</b>	<b>9-47</b>
<hr/>	
I-Line Merchandised Panelboards	9-47
I-Line Merchandised Panelboard Accessories	9-51
Molded Case Circuit Breakes for I-Line™ Panelboards	9-55
I-Line Factory Assembled Panelboards	9-65
<b>QMB/QMJ Fusible Panelboards Switch Units—600 Vac, 250 Vdc</b>	<b>9-66</b>
<hr/>	
QMB/QMJ Fusible Panelboards Switch Units	9-66
<b>Special Features, Modifications, and Terminal Data</b>	<b>9-68</b>
<hr/>	
Special Features	9-68
Terminal Data for NQ and NF Terminal Data	9-69
Terminal Data for I-Line and QMB / QMJ Panelboards	9-69

**NQ Panelboards**

This page contains UL Tested and Certified series combination ratings for panelboards. These ratings apply to either an integral main located in the same enclosure or a remote main located in a separate enclosure.

**Table 9.1: NQ Series Connected Circuit Breaker Ratings (RMS Symmetrical)**

Maximum System Voltage AC [1]	Maximum Short Circuit Current Rating [2]	Square D™ Brand Integral or Remote Main Circuit Breakers and Remote Main Fuses [3][4][5]	Square D™ Brand Branch Circuit Breaker Catalog Designation and Allowable Ampere Ranges			
			Type [6][7][8]	1 Pole	2 Pole	3 Pole
120/240 1P/3W 208Y/120 3P/4W 240/120 3P/4W	18,000	LA / LH	QO (B)	15–30 A	15–30 A	—
			QO (B)	15–70 A	15–125 A	—
	22,000	QO (B) VH, QOB-VH	QO (B) GFI	15–30 A	15–60 A	—
			QO (B) EPD	15–30 A	15–60 A	—
			QO (B) PL	15–30 A	15–60 A	—
			QO (B) AFI	15–20 A	—	—
			QO (B) CAFI	15–20 A	15–20 A	—
			QO (B) DF	15–20 A	—	—
			QO (B)	15–70 A	15–125 A	—
			QOB-VH	—	150 A	—
	25,000	QD	QO (B) PL	15–30 A	15–60 A	—
			QO (B) GFI	15–30 A	15–60 A	—
			QO (B) EPD	15–30 A	15–60 A	—
			QO (B) AFI	15–20 A	—	—
			QO (B) CAFI	15–20 A	15–20 A	—
			QO (B) DF	15–20 A	—	—
			QO (B)	15–70 A	15–125 A	—
			QO (B) GFI	15–30 A	15–60 A	—
			QO (B) EPD	15–30 A	15–60 A	—
		ED	QO (B) AFI	15–20 A	—	—
			QO (B) CAFI	15–20 A	15–20 A	—
			QO (B) DF	15–20 A	—	—
			QO (B)	15–70 A	15–125 A	—
			QOB-VH	—	150 A	—
			QO (B) PL	15–30 A	15–60 A	—
			QO (B) GFI	15–30 A	15–60 A	—
			QO (B) EPD	15–30 A	15–60 A	—
			QO (B) AFI	15–20 A	—	—
	BD, HD, JD, LD	QO (B) CAFI	15–20 A	15–20 A	—	
		QO (B) DF	15–20 A	—	—	
		QO (B)	15–70 A	15–125 A	—	
		QOB-VH	—	150 A	—	
		QO (B) PL	15–30 A	15–60 A	—	
		QO (B) GFI	15–30 A	15–60 A	—	
		QO (B) EPD	15–30 A	15–60 A	—	
		QO (B) AFI	15–20 A	—	—	
		QO (B) CAFI	15–20 A	15–20 A	—	
		QO (B) DF	15–20 A	—	—	
		QO (B)	15–70 A	15–125 A	—	
		QOB-VH	—	150 A	—	
	42,000	LA	QO (B)	15–30 A	15–30 A	—
			QO (B)	15–70 A	15–125 A	—
	65,000	QG	QO (B) VH	15–70 A	15–125 A	—
			QOB-VH	—	150 A	—
			QO (B) GFI	15–30 A	15–60 A	—
			QO (B) PL	15–30 A	15–60 A	—
			QO (B) AFI	15–20 A	—	—
			QO (B) CAFI	15–20 A	15–20 A	—
			QO (B) DF	15–20 A	—	—
			QO (B)	15–70 A	15–125 A	—
			QO (B) GFI	15–30 A	15–60 A	—
		EG	QO (B) EPD	15–30 A	15–60 A	—
			QO (B) EPE	—	—	—
			QO (B) AFI	15–20 A	—	—
			QO (B) CAFI	15–20 A	15–20 A	—
			QO (B) DF	15–20 A	—	—
			QO (B)	15–70 A	15–125 A	—
			QOB-VH	—	150 A	—
			QO (B) PL	15–30 A	15–60 A	—
			QO (B) GFI	15–30 A	15–60 A	—
	BG, HG, JG, LG	QO (B) EPD	15–30 A	15–60 A	—	
		QO (B) AFI	15–20 A	—	—	
		QO (B) CAFI	15–20 A	15–20 A	—	
		QO (B) DF	15–20 A	—	—	
		QO (B)	15–70 A	15–125 A	—	
		QOB-VH	—	150 A	—	
		QO (B) PL	15–30 A	15–60 A	—	
		QO (B) GFI	15–30 A	15–60 A	—	
		QO (B) EPD	15–30 A	15–60 A	—	
	100,000	QJ	QO (B) AFI	15–20 A	—	—
			QO (B) CAFI	15–20 A	15–20 A	—
			QO (B) DF	15–20 A	—	—
			QO (B)	15–70 A	15–125 A	—
			QOB-VH	—	150 A	—
			QO (B) PL	15–30 A	15–60 A	—
			QO (B) GFI	15–30 A	15–60 A	—
			QO (B) EPD	15–30 A	15–60 A	—
	QO (B) AFI	15–20 A	—	—		
	QO (B) CAFI	15–20 A	15–20 A	—		
	QO (B) DF	15–20 A	—	—		

[1] Series Ratings listed at higher system voltages apply to lower system voltages (Example: 240 3P/3W covers 208Y/120 3P/4W).

[2] Short Circuit tests are conducted at 100–105% of the maximum rated voltage of the panelboard.

[3] Please consult the NQ/NQM Panelboards Information Manual (80043-712-06) for additional information, including series ratings with obsolete circuit breakers.

[4] Where LG is shown, LJ and LL can be used.

[5] Unless otherwise noted, main breakers can be applied at the maximum available amperage rating.

[6] Suffixes HID, SWD, and SWN may also be applied to the applicable branch circuit breakers shown above.

[7] Where QO(B) circuit breakers are shown above, QO(B)H, QO(B)VH, and QH(B) circuit breakers may also be used.

[8] Two-pole CAFI circuit breakers cannot be used on 208Y/120V systems.

**Table 9.1 NQ Series Connected Circuit Breaker Ratings (RMS Symmetrical) (cont'd.)**

Maximum System Voltage AC [9]	Maximum Short Circuit Current Rating [10]	Square D™ Brand Integral or Remote Main Circuit Breakers and Remote Main Fuses [11][12][13]	Square D™ Brand Branch Circuit Breaker Catalog Designation and Allowable Ampere Ranges					
			Type [14][15][16]	1 Pole	2 Pole	3 Pole		
		EJ	QO (B)	15–70 A	15–125 A	—		
			QO (B) GFI	15–30 A	15–60 A	—		
			QO (B) EPD	15–30 A	15–60 A	—		
			QO (B) AFI	15–20 A	—	—		
			QO (B) CAFI	15–20 A	15–20 A	—		
			QO (B) DF	15–20 A	—	—		
		BJ, HJ, JJ	QO (B)	15–70 A	15–125 A	—		
			QOB-VH	—	150 A	—		
			QO (B) PL	15–30 A	15–60 A	—		
			QO (B) GFI	15–30 A	15–60 A	—		
			QO (B) EPD	15–30 A	15–60 A	—		
			QO (B) AFI	15–20 A	—	—		
		LJ	QO (B) CAFI	15–20 A	15–20 A	—		
			QO (B) DF	15–20 A	—	—		
			QO (B)	15–70 A	15–125 A	—		
			QOB-VH	—	150 A	—		
			QO (B) GFI	—	15–60 A	—		
			QO (B) EPD	—	15–60 A	—		
	125,000		HL, JL	QO (B) AFI	15–20 A	—	—	
				QO (B) CAFI	15–20 A	15–20 A	—	
				QO (B) DF	15–20 A	—	—	
				QO (B)	15–70 A	15–125 A	—	
				QOB-VH	—	150 A	—	
				QO (B) PL	15–30 A	15–60 A	—	
				HR, JR	QO (B) GFI	15–30 A	15–60 A	—
					QO (B) EPD	15–30 A	15–60 A	—
					QO (B) AFI	15–20 A	—	—
					QO (B) CAFI	15–20 A	15–20 A	—
					QO (B) DF	15–20 A	—	—
					QO (B)	15–70 A	15–125 A	—
		200,000		HR, JR	QOB-VH	—	150 A	—
					QO (B) GFI	15–30 A	15–60 A	—
					QO (B) EPD	15–30 A	15–60 A	—
					QO (B) AFI	15–20 A	—	—
					QO (B) CAFI	15–20 A	15–20 A	—
					QO (B) DF	15–20 A	—	—
	240 1P/2W		25,000	QD, BD, HD, JD, LD	QO (B) H	—	15–100 A	—
					QDL	—	70–225 A	—
					QO (B) H	—	15–100 A	—
					QO (B) H	—	15–100 A	—
					QO (B) H	—	15–100 A	—
					QO (B) H	—	15–100 A	—
			42,000	LA	QO (B)	—	—	15–30 A
					QO (B) GFI	—	—	15–50 A
					QO (B) GFI	—	—	15–50 A
					QO (B) GFI	—	—	15–30 A
					QO (B) GFI	—	—	15–30 A
					QO (B) GFI	—	—	15–30 A
208Y/120 3P/4W	18,000	QO (B) VH, QOB-VH	QO (B)	—	—	15–30 A		
			QO (B) GFI	—	—	15–50 A		
			QO (B) GFI	—	—	15–50 A		
			QO (B) GFI	—	—	15–30 A		
			QO (B) GFI	—	—	15–30 A		
			QO (B) GFI	—	—	15–30 A		
	22,000	QD, ED, BD, HD, JD	QO (B) GFI	—	—	15–50 A		
			QO (B) GFI	—	—	15–30 A		
			QO (B) GFI	—	—	15–30 A		
			QO (B) GFI	—	—	15–30 A		
			QO (B) GFI	—	—	15–30 A		
			QO (B) GFI	—	—	15–30 A		
65,000	QG, EG, BG, HG, JG	QO (B) GFI	—	—	15–50 A			
		QO (B) GFI	—	—	15–30 A			
		QO (B) GFI	—	—	15–30 A			
		QO (B) GFI	—	—	15–30 A			
		QO (B) GFI	—	—	15–30 A			
		QO (B) GFI	—	—	15–30 A			
240/120 3P/4W 240 3P/3W	22,000	QO (B) VH	QO (B)	—	—	15–100 A		
			QO (B) EPD	—	—	15–50 A		
			QO (B) EPE	—	—	15–50 A		
			QO (B)	—	—	15–30 A		
			QO (B) VH	—	—	15–100 A		
			QOB-VH	—	—	110–150 A		
	25,000	QD	QO (B) PL	—	—	15–30 A		
			QO (B) EPD	—	—	15–50 A		
			QO (B) EPD	—	—	15–50 A		
			QO (B) EPE	—	—	15–50 A		
			QO (B)	—	—	15–100 A		
			QO (B) EPD	—	—	15–50 A		
	ED	QO (B) EPE	—	—	15–50 A			
		QO (B)	—	—	15–100 A			
		QO (B) EPD	—	—	15–50 A			
		QO (B) EPE	—	—	15–50 A			
		QO (B) EPE	—	—	15–50 A			
		QO (B) EPE	—	—	15–50 A			
	BD, HD, JD	QO (B)	—	—	15–100 A			
		QO (B) VH	—	—	110–150 A			
		QO (B) PL	—	—	15–30 A			
		QO (B) PL	—	—	15–30 A			
		QO (B) PL	—	—	15–30 A			
		QO (B) PL	—	—	15–30 A			

[9] Series Ratings listed at higher system voltages apply to lower system voltages (Example: 240 3P/3W covers 208Y/120 3P/4W).

[10] Short Circuit tests are conducted at 100–105% of the maximum rated voltage of the panelboard.

[11] Please consult the NQ/NQM Panelboards Information Manual (80043-712-06) for additional information, including series ratings with obsolete circuit breakers.

[12] Where LG is shown, LJ and LL can be used.

[13] Unless otherwise noted, main breakers can be applied at the maximum available amperage rating.

[14] Suffixes HID, SWD, and SWN may also be applied to the applicable branch circuit breakers shown above.

[15] Where QO(B) circuit breakers are shown above, QO(B)H, QO(B)VH, and QH(B) circuit breakers may also be used.

[16] Two-pole CAFI circuit breakers cannot be used on 208Y/120V systems.



**Table 9.1 NQ Series Connected Circuit Breaker Ratings (RMS Symmetrical) (cont'd.)**

Maximum System Voltage AC [9]	Maximum Short Circuit Current Rating[10]	Square D™ Brand Integral or Remote Main Circuit Breakers and Remote Main Fuses[11][12][13]	Square D™ Brand Branch Circuit Breaker Catalog Designation and Allowable Ampere Ranges					
			Type[14][15][16]	1 Pole	2 Pole	3 Pole		
9 PANELBOARDS	42,000	LD	QO (B) EPD	—	—	15–50 A		
			QO (B) EPE	—	—	15–50 A		
			QO (B) VH	—	—	15–100 A		
			QOB-VH	—	—	110–150 A		
			QO (B) EPD	—	—	15–30 A		
		LA	QO (B) EPE	—	—	15–30 A		
			QDL	—	—	70–225 A		
			QO (B) VH	—	—	15–30 A		
			QOB-VH	—	—	110–150A		
			QO (B)	—	—	15–30 A		
	65,000	QG	QO (B) VH	—	—	15–100 A		
			QOB-VH	—	—	110–150 A		
			QO (B) PL	—	—	15–30 A		
			QO (B)	—	—	15–100 A		
			QOB-VH	—	—	110–125 A		
			QO (B) EPD	—	—	15–50 A		
			QO (B) EPE	—	—	15–50 A		
			EG, FG	QO (B)	—	—	15–100 A	
				QOB-VH	—	—	110–150 A	
				QO (B) PL	—	—	15–30 A	
		QO (B) EPD		—	—	15–50 A		
		QO (B) EPE		—	—	15–50 A		
		BG, HG, JG		QO (B)	—	—	15–100 A	
				QOB-VH	—	—	110–150 A	
				QO (B) PL	—	—	15–30 A	
				QO (B) EPD	—	—	15–50 A	
				QO (B) EPE	—	—	15–50 A	
			LG	QO (B) VH	—	—	15–100 A	
				QOB-VH	—	—	110–150 A	
				QO (B) EPD	—	—	15–30 A	
				QO (B) EPE	—	—	15–30 A	
				EJ	QO (B)	—	—	15–100 A
		QOB-VH			—	—	110–125 A	
		QO (B) EPD			—	—	15–50 A	
		QO (B) EPE			—	—	15–50 A	
		BJ, HJ, JJ			QO (B)	—	—	15–100 A
					QOB-VH	—	—	110–150 A
			QO (B) PL		—	—	15–30 A	
			QO (B) EPD		—	—	15–50 A	
			QO (B) EPE		—	—	15–50 A	
			LJ		QO (B) VH	—	—	15–100 A
				QOB-VH	—	—	110–150A	
				QO (B)	—	—	15–100 A	
				QOB-VH	—	—	110–150A	
				QO (B) PL	—	—	15–30 A	
		QO (B) EPD		—	—	15–50 A		
		QO (B) EPE		—	—	15–50 A		
		125,000		HL, JL	QO (B)	—	—	15–100 A
					QOB-VH	—	—	110–150A
					QO (B) PL	—	—	15–30 A
	QO (B) EPD		—		—	15–50 A		
	QO (B) EPE		—		—	15–50 A		
	HR, JR		QO (B)	—	—	15–100 A		
			QOB-VH	—	—	110–150A		
			QO (B) VH	15–70 A	15–125 A	—		
			QO (B) VH	15–70 A	15–125 A	—		
			QO (B) AFI	15–20 A	—	—		
	120/240 1P/3W 208Y/120 3P/4W 240/120 3P/4W	65,000	400 A Max. Class J Fuses	QO (B) CAFI	15–20 A	15–20 A	—	
				QO (B) DF	15–20 A	—	—	
				QO (B) VH	15–70 A	15–125 A	—	
				QOB-VH	—	150 A	—	
				QO (B) AFI	15–20 A	—	—	
			400 A Max. Class T6 Fuses	QO (B) CAFI	15–20 A	15–20 A	—	
				QO (B) DF	15–20 A	—	—	
				QO (B)	15–70 A	15–125 A	—	
				QO (B) GFI	15–30 A	15–60 A	—	
				QO (B) EPD	15–30 A	15–60 A	—	
		100,000	200 A Max. Class T3 Fuses	QO (B) AFI	15–20 A	—	—	
				QO (B) CAFI	15–20 A	15–20 A	—	
				QO (B) DF	15–20 A	—	—	
				QO (B)	15–70 A	15–125 A	—	
				QO (B) GFI	15–30 A	15–60 A	—	
			200 A Max. Class T6 or J Fuses	QO (B) EPD	15–30 A	15–60 A	—	
				QO (B)	15–70 A	15–125 A	—	
				QO (B) GFI	15–30 A	15–60 A	—	
				QO (B) EPD	15–30 A	15–60 A	—	
				QO (B)	15–70 A	15–125 A	—	
	200,000	400 A Max. Class T3 Fuses	QO (B) GFI	15–30 A	15–60 A	—		
			QO (B) EPD	15–30 A	15–60 A	—		
			QO (B) GFI	15–30 A	15–60 A	—		
			QO (B) EPD	15–30 A	15–60 A	—		
			QO (B) GFI	15–30 A	15–60 A	—		
		208Y/120 3P/4W	65,000	400A Max Class J	QO (B) GFI	—	—	15–50 A
			100,000	200A Max Class T3	QO (B) GFI	—	—	15–50 A
			200,000	200 A Max. Class T6 or J Fuses	QO (B) GFI	—	—	15–50 A
					QO (B) GFI	—	—	15–50 A
				400 A Max. Class T3 Fuses	QO (B) GFI	—	—	15–50 A

[9] Series Ratings listed at higher system voltages apply to lower system voltages (Example: 240 3P/3W covers 208Y/120 3P/4W).

[10] Short Circuit tests are conducted at 100–105% of the maximum rated voltage of the panelboard.

[11] Please consult the NQ/NQM Panelboards Information Manual (80043-712-06) for additional information, including series ratings with obsolete circuit breakers.

[12] Where LG is shown, LJ and LL can be used.

[13] Unless otherwise noted, main breakers can be applied at the maximum available amperage rating.

[14] Suffixes HID, SWD, and SWN may also be applied to the applicable branch circuit breakers shown above.

[15] Where QO(B) circuit breakers are shown above, QO(B)H, QO(B)VH, and QH(B) circuit breakers may also be used.

[16] Two-pole CAFI circuit breakers cannot be used on 208Y/120V systems.

**Table 9.1 NQ Series Connected Circuit Breaker Ratings (RMS Symmetrical) (cont'd.)**

Maximum System Voltage AC [9]	Maximum Short Circuit Current Rating [10]	Square D™ Brand Integral or Remote Main Circuit Breakers and Remote Main Fuses [11][12][13]	Square D™ Brand Branch Circuit Breaker Catalog Designation and Allowable Ampere Ranges			
			Type [14][15][16]	1 Pole	2 Pole	3 Pole
240/120 3P/4W 240 3P/3W	50,000	600 A Max. Class T3 Fuses	QO (B) VH	—	—	15–30 A
		400 A Max. Class J Fuses	QO (B) VH	—	—	15–100 A
	65,000	400 A Max. Class T6 Fuses	QO (B) VH	—	—	15–100 A
			QOB-VH	—	—	110–150 A
	100,000	200 A Max. Class T3 Fuses	QO (B)	—	—	15–100 A
			QO (B) EPD	—	—	15–50 A
			QO (B) EPE	—	—	15–50 A
			QO (B)	—	—	15–100 A
	200,000	200 A Max. Class T6 or J Fuses	QO (B) EPD	—	—	15–50 A
			QO (B) EPE	—	—	15–50 A
			QO (B)	—	—	15–100 A
		400 A Max. Class T3 Fuses	QO (B) EPD	—	—	15–50 A
QO (B) EPE			—	—	15–50 A	
QO (B) EPE			—	—	15–50 A	

**NF Panelboards**

This page contains UL Tested and Certified series combination ratings for panelboards. These ratings apply to either an integral main located in the same enclosure or a remote main located in a separate enclosure.

**Table 9.2: NF Series Connected Circuit Breaker Ratings (RMS Symmetrical)**

Maximum System Voltage, AC [17]	Max. Short Circuit Current Rating	Square D™ Brand Integral or Remote Main Circuit Breakers and Remote Main Fuses [18]	Square D™ Brand Branch Circuit Breaker Catalog Designation and Allowable Ampere Ranges				
			Circuit Breaker Abbreviation [19]	1 Pole	2 Pole	3 Pole	
120 120/240 240	65,000	EG, BG, HG, JG, LG, LH	EDB	15–70	15–125	15–125	
		EG	ECB-G3	15–30	15–30	15–30	
	100,000	EJ, BJ, HJ, JJ, LJ	EDB, EGB	15–70	15–125	15–125	
		EJ, BJ, HJ, JJ	ECB-G3	15–30	15–30	15–30	
	125,000	HL, JL	EDB, EGB, EJB	15–70	15–125	15–125	
		HL, JL	ECB-G3	15–30	15–30	15–30	
	200,000	HR, JR, LR	EDB, EGB, EJB	15–70	15–125	15–125	
			ECB-G3	15–30	15–30	15–30	
		Class J or T (600 V) 200 A Max Fuses	ECB-G3	15–30	15–30	15–30	
			ECB-G3	15–30	15–30	15–30	
	277 480Y/277	35,000	EG, BG, HG, JG, LG, LH	EDB	15–70	15–125	15–125
			EG, BG, HG, JG, LG, LH	EDB-EPD	15–50	—	—
EG, BG, HG, JG			ECB-G3	15–30	15–30	15–20	
65,000		EJ, BJ, HJ, JJ, LJ	EDB, EPD	15–70	15–125	15–125	
			EJ, BJ, HJ, JJ, LJ, LL	EDB-EPD, EGB-EPD	15–50	—	—
		EJ, BJ, HJ, JJ	ECB-G3	15–30	15–30	15–20	
100,000		HL, JL, LL	EDB, EGB, EJB	15–70	15–125	15–125	
			EDB-EPD, EGB-EPD, EJB-EPD	15–50	—	—	
		Class J or T (600 V) 400 A Max Fuses	EDB, EGB, EJB	15–70	15–125	15–125	
			EDB-EPD, EGB-EPD, EJB-EPD	15–50	—	—	
		200,000	HR, JR, LR	EDB, EGB, EJB	15–70	15–125	15–125
				EDB-EPD, EGB-EPD, EJB-EPD	15–50	—	—
HR, JR			ECB-G3	15–30	15–30	15–20	
			EDB, EGB, EJB	15–70	15–125	15–125	
Class J or T (600 V) 200 A Max Fuses			EDB-EPD, EGB-EPD, EJB-EPD	15–50	—	—	
			ECB-G3	15–30	15–30	15–20	
347 600Y/347		18,000	HG, BG, JG, LG	EDB	15–70	15–100	15–100
		25,000	EJ, BJ, HJ, JJ, LJ, LH	EDB, EGB	15–70	15–100	15–100
	50,000	HL, JL, LL	EDB, EGB, EJB	15–70	15–100	15–100	
		HR, JR	EDB, EGB, EJB	15–70	15–100	15–100	
	65,000	LR	EJB	15–70	15–100	15–100	
			EDB, EGB, EJB	15–70	15–100	15–100	
	200,000	Class J or T (600 V) 200 A Max Fuses	EDB, EGB, EJB	15–70	15–100	15–100	
			EDB, EGB, EJB	15–70	15–100	15–100	

[9] Series Ratings listed at higher system voltages apply to lower system voltages (Example: 240 3P/3W covers 208Y/120 3P/4W).  
 [10] Short Circuit tests are conducted at 100–105% of the maximum rated voltage of the panelboard.  
 [11] Please consult the NQ/NQM Panelboards Information Manual (80043-712-06) for additional information, including series ratings with obsolete circuit breakers.  
 [12] Where LG is shown, LJ and LL can be used.  
 [13] Unless otherwise noted, main breakers can be applied at the maximum available amperage rating.  
 [14] Suffixes HID, SWD, and SWN may also be applied to the applicable branch circuit breakers shown above.  
 [15] Where QO(B) circuit breakers are shown above, QO(B)H, QO(B)VH, and QH(B) circuit breakers may also be used.  
 [16] Two-pole CAFI circuit breakers cannot be used on 208Y/120V systems.  
 [17] Short circuit tests are conducted at 100–105% of the maximum rated voltage of the panelboard.  
 [18] Please consult the NF/NFOM Panelboards Information Manual (80043-741-03) for additional information, including series ratings with obsolete circuit breakers.  
 [19] EDB-EPD, EGB-EPD & EJB-EPD suitable for 480Y/277Vac or 277Vac ONLY.

**I-Line Panelboards**

**Table 9.3: I-Line Series Connected Circuit Breaker Ratings (RMS Symmetrical)**

Maximum System Voltage AC [20]	Maximum Short Circuit Current Rating	Square D Brand Integral or Remote 2- or 3-Pole Main Circuit Breaker [21]	Square D Brand Branch Circuit Breaker		
			Catalog Designation	Poles	
120	42,000	MG	FY	1	
	65,000	QG, LH	FA, FD		
		QG, BG6, HG, JG, LG, MG, PG	BD6 (60 A Max.)		
	100,000	FJ, QJ	FD		
		QJ, LC	FA		
		LJ	FH		
	125,000	QJ, BJ, HJ, JJ, LJ, MJ, PJ	BD6, BG6 (60 A Max.)		
200,000	HL, JL, LL	BD6, BG6, BJ (60 A Max.)			
200,000	LR	FH, FY			
208Y/120	65,000	HR, JR	BD6, BG6, BJ (60 A Max.)	2, 3	
	100,000	QG, BG6, HG, JG, LG, MG, PG	BD6		
		QJ	FA, FD		
QJ, BJ, HJ, JJ, LJ, MJ, PJ		BD6, BG6			
100,000	QJ, PH, PJ, RJ	QD, QG	2, 3		
	35,000	MG		FA	
		KA		FD	
42,000	LA, MA	HD, JD, QD	2, 3		
50,000	MG	FA	1		
	MG	FA (25 A Max.)			
65,000	65,000	HG, JG	FA, HD	2, 3	
		JG	JD, QD		
		QG	FA, FD, QD		
		QG, BG6, HG, JG, LG, MG, PG	BD6		
		LH, MH, PA, PG, RG	HD, JD, QD		
		FG, FH, MH, MX, PJ	FD		
	FC, KC, KH, LC, LH	FD, FG	1, 2, 3		
	65,000	LH	FA	2, 3	
		LH	LA		
		MG	HD, JD, KA		
		DG	FH, HD, JD, KA, LA, MA		
		LG	HD, JD, KA, LA, MA		
		LG	LD		
	85,000	RL	FH, KH	2, 3	
		FC, KC, LC, LX	FD, FG, FJ	1	
	100,000	100,000	PH, PJ, RJ	QD, QG	2, 3
QJ			FD	2	
FJ		FD	2, 3		
LJ		HD, HG, JD, JG, FH, KA, LA, MA, MG			
LJ		LD, LG	3		
FC, KC		FA, FH, FD, FG, FJ	2, 3		
LC, LX		FH, FD, FG, FJ			
QJ, BJ, HJ, JJ, LJ, MJ, PJ		BD6, BG6			
KC, LC, LX		KA			
KC, LC		KH			
LC		LA, LH, MG			
125,000		125,000	LC	FA	1, 2, 3
			HJ, JJ	FA, FH, HD, HG	
			JJ	JD, JG	
			LC, LX, MJ, PJ, RJ	HD, HG, JD, JG	
			MJ	LA, LH	
	DJ		FH, HD, HG, JD, JG, KA, LA, MA, MG		
	RL		RG		
	HL, JL		HD, HG, HJ, FA, FH		
200,000	200,000	JL	JD, JG, JJ	2, 3	
		HL, JL, LL	BD6, BG6, BJ		
		PC, PH, PL, RL	HD, HG, JD, JG		
		PC, PL, RL	HJ, JJ		
		FI, KI, LI, LXI	HD, HG, HJ		
		KI, LI, LXI	JD, JG, JJ		
		FI, KI, LI, LXI	FD, FG, FJ		
		FI, KI	FA, FH, FC, FD, FG, FJ		
		LI, LXI	FH, FD, FG, FJ		
		LI	FC		
35,000	35,000	HR, JR, LR	BD6, BG6, BJ	2, 3	
		KI, LI, LXI	KA, QD, QG, QJ		
		LI	KC		
		JR	QD		
		LR	HJ, HL, JJ, JL, FH, LA, LH, QD, QG, QJ		
		FC, KC	FH		
277	35,000	BG6, HG, JG, LG, MG, PG	BD6 (60 A Max.)	1	
		LD	FY		
		FH, KA	FD		
		FG, KH, LH	FD		
		DG, LG	FH, FY		

[20] For indicated circuit breakers rated less than this maximum voltage. The indicated short circuit current rating also applies, but at the voltage rating of the circuit breaker.

[21] LG, LJ, and LL are only available in 3-pole configurations.

**Table 9.3 I-Line Series Connected Circuit Breaker Ratings (RMS Symmetrical) (cont'd.)**

Maximum System Voltage AC [22]	Maximum Short Circuit Current Rating	Square D Brand Integral or Remote 2- or 3-Pole Main Circuit Breaker [23]	Square D Brand Branch Circuit Breaker		
			Catalog Designation	Poles	
	65,000	FJ	FD		
		FC, KC	FA, FY, FD, FG		
		LC, LX (400 A Max.)	FH		
		LC, LX (600 A Max.)	FY, FD, FG		
		DJ	FH, FY		
		LL	FY		
	100,000	LJ	FH, FY		
		BJ, HJ, JJ, LJ, MJ, PJ	BD6, BG6 (60 A Max.)		
		FI, KI	FH		
	200,000	DL, LL	FH, FJ		
		HL, JL, LL	BD6, BG6, BJ (60 A Max.)		
		FI, KI	FA, FY, FD, FG, FJ		
		LI, LXI (400 A Max.)	FH		
	480	22,000	LI, LXI (600 A Max.)		FY, FD, FG, FJ
			LI, LXI (600 A Max.)		FY, FD, FG, FJ
HR, JR			BD6, BG6, BJ (60 A Max.)		
30,000		MG	FA		
		MX, PA, PC, PX	FH		
		KH, LA, MA, PJ	FH		
		LA, MA, PA, PC, PX	KA		
		LA, MA, PA	HD, JD		
		MG	FA (25 A Max.), FH, KA		
35,000		MX, PA	HD, JD		
		MH	HD, JD		
		HG, JG	FA, HD		
		JG	JD		
		LH, MG, PG, RG	HD, JD		
		BG6, HG, JG, LG, MG, PG	BD6		
	LH	HG, JG			
	DG	FH, HD, JD, KA, LA, MA			
	LG	LD			
42,000	LG	HD, JD, FH, KA, LA, MA			
	MJ	FH (25 A Max.)			
	RL	RG			
65,000	50,000	MJ	KA, KH		
		FC, KC	FA, FH		
		HJ, JJ	FA, FH, HD, HG		
	65,000	BJ, HJ, JJ, LJ, MJ, PJ	BD6, BG6		
		JJ	JD, JG		
		LC, LI, LX, LXI	HD, HG, JD, JG		
		LC, LX, (400 A Max.)	FH		
		KC, LC, LX	KA		
		LC, LX	LA		
		DJ	FH, HD, HG, JD, JG, KA, LA, MA		
		LJ	LD, LG		
		LJ	HD, HG, JD, JG, FH, KA, LA, MA		
	100,000	HL, JL	FA, FH, HD, HG, HJ		
		HL, JL, LL	BD6, BG6, BJ		
		JL	JD, JG, JJ		
LI, LXI (600 A Max.)		KA			
PC, PH, PL, RL		HJ, JJ			
RL		RG			
DL		FH, HD, HG, HJ, JD, JG, JJ, KA, LA, MA			
LL		LD, LG, LJ			
LL		HD, HG, HJ, JD, JG, JJ, FH, KA, LA, MA			
200,000	JR	FA			
	FI, KI	FA, FH, FC, HD, HG, HJ			
	HR, JR	BD6, BG6, BJ			
	KI	JD, JG, JJ, KA			
	LI	FC, KA, KC, LA, HJ, HL, JJ, JL			
	LXI	KA, HJ, HL, JJ, JL			
	HR	FA, HD, HG, HJ, HL			
	JR	HD, HG, HJ, HL, JD, JG, JJ, JL			
	LR	HJ, HL, JJ, JL, FH, LA, LH			
480Y/277	25,000	FH, KA	FD		
		FG, KH, LH	FD		
	35,000	BG6, HG, JG, LG, MG, PG	BD6		
		FJ	FD		
	65,000	BJ, HJ, JJ, LJ, MJ, PJ	BD6, BG6		
		FC, KC	FD, FG		
	100,000	LC, LX (600 A Max.)	FD, FG		
		HL, JL, LL	BD6, BG6, BJ		
	200,000	FI, KI	FD, FG, FJ		
		HR, JR	BD6, BG6, BJ		
LI, LXI (600 A MAX.)		FD, FG, FJ			
HG, JG		FA, HD			
600	18,000	JG	JD		
		MG, PG, RG	HD, JD		

[22] For indicated circuit breakers rated less than this maximum voltage. The indicated short circuit current rating also applies, but at the voltage rating of the circuit breaker.

[23] LG, LJ, and LL are only available in 3-pole configurations.

Table 9.3 I-Line Series Connected Circuit Breaker Ratings (RMS Symmetrical) (cont'd.)

Maximum System Voltage AC [22]	Maximum Short Circuit Current Rating	Square D Brand Integral or Remote 2- or 3-Pole Main Circuit Breaker [23]	Square D Brand Branch Circuit Breaker			
			Catalog Designation	Poles		
	25,000	MG	FA	3		
		LG	LD			
		HJ, JJ	HD, JD			
		PJ, RJ	FA, HD, HG	2, 3		
		LJ	JD			
		35,000	LJ	MG	3	
	LJ		LD, LG			
	50,000		LC	JD, JG, HD, HG, MA	2, 3	
			HL, JL	FH, HD, HG, HJ, JD, JG, JJ, LA		
		JL	FA, HD, HG, HJ			
		100,000	PK	JD, JG, JJ	2, 3	
			LL	HJ, JJ, MJ		
			LL	LD, LG, LJ	3	
	LI		HD, HG, HJ, JD, JG, JJ, MA			
	347		18,000	FI, KI	HD, HG, HJ	1
				KI	JD, JG, JJ	
		HR		FA, HD, HG, HJ, HL		
		JR		FA, HD, HG, HJ, HL, JD, JG, JJ, JL		
		KI, LI		FH		
		LI		LA		
600Y/347	18,000	BG6, HG, JG, LG, MG, PG	BD6 (60 A Max.)	3		
		BJ, HJ, JJ, LJ, MJ, PJ	BD6, BG6 (60 A Max.)			
		HR, JR	BD6, BG6, BJ (60 A Max.)			
	25,000	BG6, HG, JG, LG, MG, PG	BD6	3		
		MG	FA (25 A Max.)			
		BJ, HJ, JJ, LJ, MJ, PJ	BD6, BG6			
	50,000	MJ	FA (25 A Max.)	1		
		HL, JL, LL	BD6, BG6, BJ			
		HL, JL	FJ			
	100,000	HR, JR	BD6, BG6, BJ	3		

9  
PANELBOARDS

[22] For indicated circuit breakers rated less than this maximum voltage. The indicated short circuit current rating also applies, but at the voltage rating of the circuit breaker.

[23] LG, LJ, and LL are only available in 3-pole configurations.

**Table 9.4: Fuse/I-Line Circuit Breaker Series Connected Ratings**

Maximum System Voltage AC [22]	Maximum Short Circuit Current Rating	Remote Main Fuse		Square D Brand Branch Circuit Breaker Catalog Designation (2- or 3-Pole) Unless Otherwise Stated		
		Max A	Class			
120/240 1Ø 208Y/120	100,000	1200 A	L, T (300 V)	QD, QG		
		800 A	T (600 V)			
		600 A	J, RK5			
240	65,000	1200 A	L, T (300 V)	QD		
		800 A	T (600 V)			
		600 A	J, RK5			
	100,000	1200 A	1200 A	L, T (300 V)	QD, QG (2-Pole)	
			800 A	T (600 V)		
			600 A	J, RK5		
		800 A	600 A	J, T (600 V)	FA, FH, KA, KH, KC, LA, LH, MA, MH, MX, PG	
				RK5	FH, KA, KH, LA, LH, MA, MH, MX, PG, HD, HG, HJ, HL, JD, JG, JJ, JL	
				J	HD, HG, HJ, HL, JD, JG, JJ, JL	
		800 A	800 A	T (600 V)	FH, KA, KH, LA, LH, MA, MH, MX, PG	
				T (300 V)	PG	
				L	FH, KA, KH, LA, LH, MA, MH, MX, PG	
		1200 A	1200 A	L	FH, KH, LA, LH, MA, MH, MX, PG	
				T (600 V)	HD, HG, HJ, HL, JD, JG, JJ, JL	
				J, T (600 V)	FA (3-pole only) FH, FC, KH, KC, LA, LH, LC, MA, MH, MX, NA, NC, NX, PG, PJ, PL	
		200,000	600 A	600 A	RK5	FH, FC, HD, HG, HJ, HL, JD, JG, JJ, JL, KH, KC, LA, LH, LC, MA, MH, MX, NC, NX, PG, PJ, PL
					J	HD, HG, HJ, HL, JD, JG, JJ, JL
					T (600 V)	FH, FC, KA, KH, KC, LA, LH, LC, MA, MH, MX, NA, NC, NX, PG, PJ, PL
	800 A		800 A	T (300 V)	PG, PJ, PL	
				L	FH, FC, KH, KC, LA, LH, LC, MA, MH, MX, NA, NC, NX, PG, PJ, PL	
				L	FC, KH, KC, LA, LH, LC, MA, MH, MX, NA, NC, NX, PG, PJ, PL	
1200 A	1200 A		T (600 V)	HD, HG, HJ, HL, JD, JG, JJ, JL		
			J, T (600 V)	HD, HG, HJ, HL, JD, JG, JJ, JL		
			J, RK5	HJ, HL, JJ, JL		
480	100,000	400 A	J, T(600 V)	HD, HG, HJ, HL, JD, JG, JJ, JL		
		600 A	J, RK5	HJ, HL, JJ, JL		
		600 A	J, T (600 V)	FC, KA, KH, KC, LA, LH, LC, MA, MH, MX, NA, PG, PJ		
			RK5	FC, KA, KH, KC, LA, LH, LC, MA, MH, MX, NA, PG, PJ		
		800 A	L, T(600V)	FC, KA, KH, KC, LA, LH, LC, MA, MH, MX, NA, PG, PJ		
			L	FC, KH, KC, LA, LH, LC, MA, MH, MX, NA, PG, PJ		
	200,000	200 A	200 A	RK5	HJ, HL	
			400 A	J	FA, FH, FC, HJ, HL, JJ, JL, KA, KH, KC, LA, LH, LC, MA, MH, MX, NA, NC, NX, PG, PJ, PL	
				T (600 V)	FA, FH, FC, HJ, HL, JJ, JL, KA, KH, KC, LA, LH, MA, MH, MX, NA, NC, NX	
		600 A	600 A	J	FC, KA, KH, KC, LA, LH, LC, MA, MH, MX, MG, MJ, NA, NC, NX, PG, PJ, PL	
				T(600 V)	KA, KH, KC, LA, LH, MA, MH, MX, NA, NC, NX	
				RK5	KC, LA, LH, LC, MA, MH, MX, MG, MJ, NC, NX, PG, PJ	
		800 A	800 A	T(300 V)	PG, PJ, PL	
				T(600 V)	KA, KH, KC, LA, LH, MA, MH, MX, MG, MJ, NA, NC, NX, PG, PJ, PL	
				L	KC, LA, LH, LC, MA, MH, MX, NA, NC, NX, PG, PJ, PL	
		1200 A	1200 A	L	KC, LC, MA, MH, MX, MG, MJ, NA, NC, NX, PG, PJ, PL	
				30 A	CC	HG, JG (Molded Case Switches)
				200 A	J	HD, HG, HJ, HL, JD, JG, JJ, JL
600	100,000	400 A	J, T (600 V)	HJ, HL, JJ, JL		

- The fuse used in this UL test is an envelope (umbrella) fuse. This fuse is designed as a "worst case" fuse. Thus, no matter what manufacturer's fuse is used, the Square D™ brand circuit breaker is protected.
- The line side fused switch may be in a separate enclosure or in the same enclosure as the loadside breaker. A line side fused switch may be a submain, integral main, or remote main. A load side breaker may be a branch, submain, or an integral main used on the load side of a remote main. This series combination short circuit current rating shall not exceed that of the line side fused switch. The charts apply to Square D™ brand load side breakers only. However, the line side fuse ratings are independent of the fuse manufacturer.
- Not applicable to Corner Grounded Systems.
- Limiters used in Square D™ brand DSL and DSL II fused power circuit breakers are not class L fuses and do not have series ratings.

[22] For indicated circuit breakers rated less than this maximum voltage. The indicated short circuit current rating also applies, but at the voltage rating of the circuit breaker.

### Selection Procedure for NQ Merchandised Panelboards

1. Review maximum electrical system voltage, ampacity, and available fault current, and determine the type of panelboard that is desired (see tables [Table 9.1–Table 9.4](#)).
2. Identify type (plug-on or bolt-on) and total quantity of branch circuit breaker poles and panel spaces required (see Digest sections 7 and 9 for catalog numbers).
3. Select proper main lug interior (from [Table 9.5](#) or [Table 9.7](#)) or:
  - Select main circuit breaker interior and main circuit breaker adapter kit (from [NQ Main Circuit Breaker Interiors](#), page 9-12 or [Table 9.8 NQ 14-inch-wide Main Circuit Breaker Interiors](#), page 9-14), based upon the equivalent number of poles and ampere rating.  
**NOTE:** Interiors include solid neutral and are field convertible to top-feed.
  - If a main circuit breaker interior was selected, select a main circuit breaker (or fuse) from the QO, PowerPact H-, J-, L- Q-, or LA/LH frame pages in Section 7 of the Digest.
4. Select ground bars from tables [Table 9.9](#) or any non-standard neutral bars (i.e., 200% neutral for non-linear loads) from [Table 9.38](#).
  - Please note that an aluminum ground bar kit is included with NQ Panelboard Interiors.
5. Select any required sub-feed circuit breakers, sub-feed lugs (SFL), or feed-through lugs (FTL) kits:
  - Sub-feed lugs (SFL) or feed-through lugs (FTL) kits: [Table 9.39](#) in the NQ Accessories sections.
  - Any subfeed circuit breakers from the PowerPact H-, J-, L-, Q- or LA/LH-frame pages of Section 7 of the Digest.
6. Determine the total mounting inches required by adding requirements from interior, main circuit breaker, neutrals and ground bars, SFL, FTL, or sub-feed circuit breaker.
7. Select enclosure from the tables [Table 9.5–Table 9.9](#), [Table 9.38–Table 9.42](#), [Table 9.24](#), and [Table 9.26](#).  
NEMA Type 1—select box and front (cover) catalog number corresponding to interior catalog number.  
NEMA Type 3R, 5, 12—select enclosure. Cover for Type 3R, 5, 12 is included with the enclosure.
8. Select the branch circuit breakers to be installed in the panel.  
For NQ panelboards use QO (VH) circuit breakers from Section 7 of the Digest, or QOB(VH) circuit breakers from Section 9 of the Digest.
9. Select options and accessories from tables [Table 9.7–Table 9.44](#).  
**NOTE:** Additional NF and NQ options may be found in the [Supplemental and Obsolescence Digest](#), Section 4.

#### NQ Merchandised Selection Example

208Y/120 Vac, 3Ø4W, 10 kA SCCR, 225 A, MLO, NEMA Type-1, surface-mount, bolt-on, branch circuit breakers, main sub-feed lugs

Branches	Table No.	Catalog Number	Spaces
(20) 20/1	<a href="#">Table 9.11</a>	(20) QOB120	20
two 40/2	<a href="#">Table 9.11</a>	two QOB240	4
two 30/3	<a href="#">Table 9.11</a>	two QOB330	6
			Total 30 spaces
			<b>Min. Box Height</b>
225 A MLO Interior	<a href="#">Table 9.5</a>	NQ430L2	32 inches
Enclosure (Box)	<a href="#">Table 9.5</a>	MH38	—
Front (Cover)	<a href="#">Table 9.5</a>	NC382S	—
Sub-feed Lugs	<a href="#">Table 9.39</a> and <a href="#">Table 9.40</a>	NQSFL2	6 inches
			Total 38 inches

**NQ Main Lug Interiors—240 Vac, 48 Vdc**

**Table 9.5: Main Lug Interiors—Accepts plug-on and bolt-on circuit breakers**

Circuit Breaker Pole Spaces [1]	Mains Rating (Amps)	Interior Only (Order Branch Circuit Breakers Separately) [2][3]	NEMA Type 1 Enclosure					Water, Dirt, & Dust Resistant Enclosure Catalog Numbers[4]		
			Box 20 in. W x 5.75 in. D[5] or 8.75 in. D[6]	Mono-Flat™ Trim Front [7]	Hinged Trim Front[7]	Mono-Flat™ 3 Point Latch Trim Front [7][8]	Hinged 3 Point Latch Trim Front [7][8]	Type 3R/5/12 20 in. W x 5.75 in. D[9]	Type 3R 26 in. W x 8.75 in. D[8][10]	Height (In.)
20-inch-wide Cabinet[11]—Single Phase 3-Wire.										
18	100	NQ18L1	MH26	NC26 ( )	NC26( )HR	–	–	MH26WP	–	26
		NQ18L1C								
30		NQ30L1	MH32	NC32 ( )	NC32( )HR	–	–	MH32WP	–	32
		NQ30L1C								
30	225	NQ30L2	MH32	NC32 ( )	NC32( )HR	–	–	MH32WP	–	32
		NQ30L2C								
42		NQ42L2	MH38	NC38 ( )	NC38( )HR	–	–	MH38WP	–	38
		NQ42L2C								
72		NQ72L2	MH44	NC44 ( )	NC44( )HR	–	–	MH44WP	–	44
		NQ72L2C								
84		NQ84L2	MH50	NC50 ( )	NC50( )HR	–	–	MH50WP	–	50
		NQ84L2C								
30	400	NQ30L4	MH50	NC50V ( )	NC50V( )HR	NC50V( )3P	–	MH50WP	MH62D9VWP	50/62
		NQ30L4C								
42		NQ42L4								
		NQ42L4C								
54		NQ54L4	MH56	NC56V( )	NC56V( )HR	NC56V( )3P	–	MH56WP	MH68D9VWP	56/68
		NQ54L4C								
84[12]		NQ84L4C	MH68	NC68V( )	NC68V( )HR	NC68V( )3P	NC68V( )3PHR	MH68WP	MH80D9VWP	68/80
30	600	NQ30L6C	MH50	NC50V ( )	NC50V( )HR	NC50V( )3P	NC50V( )3PHR	MH62WP[13]	MH62D9VWP	50/62
42		NQ42L6C								
54		NQ54L6C	MH56	NC56V( )	NC56V( )HR	NC56V( )3P	NC56V( )3PHR	MH68WP[13]	MH68D9VWP	56/68
84[12]		NQ84L6C	MH68	NC68V( )	NC68V( )HR	NC68V( )3P	NC68V( )3PHR	MH80WP[13]	MH80D9VWP	68/80
20-inch-wide Cabinet[11]—Three Phase 4-Wire										
18	100	NQ418L1	MH26	NC26 ( )	NC26( )HR	–	–	MH26WP	–	26
		NQ418L1C								
30		NQ430L1	MH32	NC32 ( )	NC32( )HR	–	–	MH32WP	–	32
		NQ430L1C								
30	225	NQ430L2	MH32	NC32 ( )	NC32( )HR	–	–	MH32WP	–	32
		NQ430L2C								
42		NQ442L2	MH38	NC38 ( )	NC38( )HR	–	–	MH38WP	–	38
		NQ442L2C								
54		NQ454L2								
		NQ454L2C								
72[12]		NQ472L2	MH44	NC44 ( )	NC44( )HR	–	–	MH44WP	–	44
		NQ472L2C								
84[12]	NQ484L2	MH50	NC50 ( )	NC50( )HR	–	–	MH50WP	–	50	
	NQ484L2C									
30	400	NQ430L4	MH50	NC50V ( )	NC50V( )HR	NC50V( )3P	–	MH50WP	MH62D9VWP	50/62
		NQ430L4C								
42		NQ442L4								
		NQ442L4C								
54		NQ454L4	MH56	NC56V( )	NC56V( )HR	NC56V( )3P	–	MH56WP	MH68D9VWP	56/68
		NQ454L4C								
72[12]	NQ472L4	MH62	NC62V ( )	NC62V( )HR	NC62V( )3P	NC62V( )3PHR	MH62WP	MH74D9VWP	62/74	
	NQ472L4C									
84[12]	NQ484L4C	MH68	NC68V( )	NC68V( )HR	NC68V( )3P	NC68V( )3PHR	MH68WP	MH80D9VWP	68/80	
30	600	NQ430L6C	MH50	NC50V ( )	NC50V( )HR	NC50V( )3P	NC50V( )3PHR	MH62WP[13]	MH62D9VWP	50/62
42		NQ442L6C								
54		NQ454L6C	MH56	NC56V( )	NC56V( )HR	NC56V( )3P	NC56V( )3PHR	MH68WP[13]	MH68D9VWP	56/68
84[12]		NQ484L6C	MH68	NC68V( )	NC68V( )HR	NC68V( )3P	NC68V( )3PHR	MH80WP[13]	MH80D9VWP	68/80

**Note:** All NQ Merchandised Panelboard interiors include the following: a NQFP15 bag of blank filler plates; a neutral bonding strap; an NQ information manual; a NEMA instruction booklet; and a sheet of circuit numbers.

- [1] Please note that some local building codes limit panelboards to 42 circuits, including those that reference 2005 or earlier version of NFPA 70.
- [2] Accepts all QO(B) shown in Tables in Sections 7 and 9. Branch circuit breaker trip ampacity cannot exceed panelboard mains rating. 175 A and 200 A circuit breakers may only be installed in single phase 400 A and 600 A NQ Panelboards. Tandem circuit breakers may not be installed.
- [3] "C" suffix indicates copper bussing.
- [4] Wall mounting brackets add 0.4 inches to back of MHxxWP enclosures.
- [5] Nominal interior dimensions, see PBA600 for details.
- [6] D9 suffix indicates the 8.75 in. Deep Enclosure required for panelboards with PowerPact L Main Breaker, Switch, or Sub-Feed Breaker. See PBA604 for dimensional details.
- [7] Add "F" for flush mount, "S" for surface mount.
- [8] Three point latch trim fronts are required for enclosures on panelboards with QO2175, QO2200, QO2175VH, or QO2200VH branch circuit breakers. These breakers take four pole spaces in single phase NQ interior.
- [9] Enclosure includes trim kit. Nominal interior dimensions, see PBA711 for details.
- [10] Vented Type 3R enclosure with three point latch door. Required for outdoor applications with two sub-feed breakers, or sub-feed breaker with trip current >150A. NEMA 3R enclosures must be bottom fed, and a NQ12RDE kit should also be selected. Interior nominal dimensions, see PBA603WP for details.
- [11] For the NQ14-inch-wide panelboard offer, See NQ 14-inch-wide—240 Vac, 48 Vdc.
- [12] Use only if the Local Jurisdiction where this panelboard interior is being applied has adopted the 2008 NFPA 70—National Electrical Code® (NEC®), which allows single panelboard interiors greater than 42 circuits.
- [13] NEMA 3R, 5, or 12 enclosures must be bottom fed, when selected, an NQ12RDE kit should also be selected. See [NQ Merchandised Accessories, page 9-23](#).



NQ Main Circuit Breaker Interiors—240 Vac, 48 Vdc

Table 9.6: Main Circuit Breaker Interiors—Will accept plug-on and bolt-on circuit breakers

Circuit Breaker Pole Spaces [14]	Mains Rating (Amps)	Interior Only Catalog Number (Order Branch Circuit Breakers Separately) [15][16]	Main Circuit Breaker Adapter Kits (Less Circuit Breaker)			NEMA Type 1 Enclosure, Catalog Numbers					Water, Dirt, and Dust Resistant Enclosure Catalog Numbers [17]						
			Main Circuit Breaker Kit	UL SE Barrier Kit [18]	Circuit Breaker Frame Size [19]	Box 20 in. W x 5.75 in. D [20] or 8.75 in. D [21]	Mono-Flat™ Trim Front [22]	Hinged Trim Front [22]	Mono-Flat™ 3 Point Latch Trim Front [22][23]	Hinged 3 Point Latch Trim Front [22][23]	Type 3R/5/12 20 in. Wide x 5.75 in. Deep [24]	Type 3R 26 in. Wide x 8.75 in. Deep [25]	Height (In.)				
20-inch-wide Cabinet [26]—Single Phase 3-Wire																	
16 [27]	100 back-fed	NQ18L1			Select 2-pole QOB or QOB-VH [28]	MH26	NC26 ( )	NC26( )HR	—	—	MH26WP	—	26				
28 [27]		NQ30L1C				MH32	NC32 ( )	NC32( )HR	—	—	MH32WP	—	32				
26 [27]		NQ30L2				—	—	Select 2-pole QOB-VH [28]	MH44	NC44 ( )	NC44( )HR	—	—	MH44WP	—	44	
38 [27]	NQ42L2	MH50	NC50 ( )	NC50( )HR	—				—	MH50WP	—	50					
50 [27]	NQ54L2	MH56	NC56 ( )	NC56( )HR	—				—	MH56WP	—	56					
68 [27]	NQ72L2	MH62	NC62 ( )	NC62( )HR	—				—	MH62WP	—	62					
80 [27]	NQ84L2	18	100	NQMB2HJ	HJQLLC				HD [30], HG [30], HJ, HL, HR [30] (100 A maximum)	MH38	NC38 ( )	NC38( )HR	—	—	MH38WP	—	38
30	NQ30L1C									MH44	NC44 ( )	NC44( )HR	—	—	MH44WP	—	44
42	225	NQ42L2	NQMB2HJ	HJQLLC	HD [30], HG [30], HJ, HL, HR [30], JD, JG, JJ, JL, JR [30], or QB, QD, QG, QJ	MH50	NC50 ( )	NC50( )HR	—	—	MH50WP	—	50				
72	NQ72L2	MH56				NC56 ( )	NC56( )HR	—	—	MH56WP	—	56					
84	NQ84L2	30	NQMB4LA	LALLC	LALVH [31]	MH62	NC62 ( )	NC62( )HR	—	—	MH62WP	—	62				
42	NQ42L4					MH68	NC68V ( )	NC68V( )HR	NC68V( )3P	NC68V( )3PHR	MH68WP	MH68D9VWP	68				
54	NQ54L4	84	NQMB6PPL	PPLLC	LG, LJ, LL	MH80	NC80V ( )	NC80V( )HR	NC80V( )3P	NC80V( )3PHR	MH80WP	MH80D9VWP	80				
30	NQ30L4					MH62D9 [21]	NC62V( )	NC62V( )HR	NC62V( )3P	NC62V( )3PHR	—	Factory Assembled Only	62				
42	NQ42L4	MH68D9 [21]	NC68V( )	NC68V( )HR	NC68V( )3P	NC68V( )3PHR	—	68									
54	NQ54L4	MH74D9 [21]	NC74V( )	NC74V( )HR	NC74V( )3P	NC74V( )3PHR	—	74									
84	NQ84L4	MH86D9 [21]	NC86V( )	NC86V( )HR	NC86V( )3P	NC86V( )3PHR	—	86									
30	600	NQ30L6C	NQMB6PPL	PPLLC	LG, LJ, LL	MH62D9 [21]	NC62V( )	NC62V( )HR	NC62V( )3P	NC62V( )3PHR	—	Factory Assembled Only	62 / 68				
42		NQ42L6C				MH68D9 [21]	NC68V( )	NC68V( )HR	NC68V( )3P	NC68V( )3PHR	—		68 / 74				
54		NQ54L6C				MH74D9 [21]	NC74V( )	NC74V( )HR	NC74V( )3P	NC74V( )3PHR	—		74 / 80				
84		NQ84L6C				MH86D9 [21]	NC86V( )	NC86V( )HR	NC86V( )3P	NC86V( )3PHR	—		86				

[14] Please note that some local building codes limit panelboards to 42 circuits, including those that reference 2005 or earlier version of NFPA 70.  
 [15] Accepts all QO(B) shown in Tables in Sections 7 and 9. Branch circuit breaker trip ampacity cannot exceed panelboard mains rating. 175 A and 200 A circuit breakers may only be installed in single phase 400 A and 600 A NQ Panelboards. Tandem circuit breakers may not be installed.  
 [16] "C" suffix indicates copper bussing.  
 [17] Wall mounting brackets add 0.4 inches to back of MHxxWP enclosures.  
 [18] Please select the appropriate Main Breaker Barrier for UL Service Entrance applications (see US Service Entrance Barriers (required by NFPA 70—National Electrical Code® (NEC®) 2017), page 9-25).  
 [19] Circuit breaker interrupt ratings, see the table for each circuit breaker range in Section 7.  
 [20] Nominal interior dimensions, see PBA600 for details.  
 [21] D9 suffix indicates the 8.75 in. Deep Enclosure required for panelboards wit PowerPact L Main Breaker, Switch, or Sub-Feed Breaker. See PBA604 for dimensional details.  
 [22] Replace ( ) with "F" for flush mount, or "S" for surface mount.  
 [23] Three point latch trim fronts are required for enclosures on panelboards with QO2175, QO2200, QO2175VH, or QO2200VH branch circuit breakers. These breakers take four pole spaces in single phase NQ interiors.  
 [24] Enclosure includes trim kit. Nominal enclosure dimensions, see PBA711 for details.  
 [25] Vented Type 3R enclosure with three point latch door. Required for outdoor applications with PowerPact L main breaker, two sub-feed breakers, or sub-feed breaker with trip current >150 A. NEMA 3R enclosures must be bottom fed. Interior nominal dimensions, see PBA603WP for details.  
 [26] For the NQ14-inch-wide panelboard offer, See NQ 14-inch-wide—240 Vac, 48 Vdc, page 9-14.  
 [27] Pole spaces shown are available for branch circuits, with spaces deducted for the back-fed main breaker.  
 [28] Do not select a back-fed main for panels to be "Suitable for use as UL service equipment." Select a H frame circuit breaker (and associated main circuit breaker kit) from the list for 225 interiors, for panels to be "Suitable for use as UL service equipment."  
 [29] QOB2110VH, QOB2125VH, or QOB2150VH take four pole spaces in NQ single phase interior.  
 [30] For single phase applications, order a 3-pole breaker. Example: HDL36100.  
 [31] Available for 125–400 A applications. Please order short handle circuit breaker (i.e., LAL36400MB).

**Table 9.6 Main Circuit Breaker Interiors—Will accept plug-on and bolt-on circuit breakers (cont'd.)**

20-inch-wide Cabinet[32]—Three Phase 4-Wire																
15[33]	100 back-fed	NQ418L1	—	—	Select 3-pole QOB or QOB-VH[34]	MH26	NC26 ( )	NC26( )HR	—	—	MH26WP	—	26			
27[33]		NQ418L1C				MH32	NC32 ( )	NC32( )HR	—	—	MH32WP	—	32			
24[33]		NQ430L1				Select 3-pole QOB-VH[34] [35]	MH44	NC44 ( )	NC44( )HR	—	—	MH44WP	—	44		
36[33]	NQ430L2C	MH50			NC50 ( )		NC50( )HR	—	—	MH50WP	—	50				
48[33]	NQ442L2	MH56			NC56 ( )		NC56( )HR	—	—	MH56WP	—	56				
	NQ454L2C	MH62			NC62 ( )		NC62( )HR	—	—	MH62WP	—	62				
66[33]	NQ472L2	HD, HG, HJ, HL, HR (100 A maximum)			MH38		NC38 ( )	NC38( )HR	—	—	MH38WP	—	38			
78[33]	NQ472L2C				MH44		NC44 ( )	NC44( )HR	—	—	MH44WP	—	44			
	NQ484L2				MH50	NC50 ( )	NC50( )HR	—	—	MH50WP	—	50				
18	100				NQ418L1	NQMB2HJ	HJQLLC	HD, HG, HJ, HL, HR, JG, JJ, JL, JR; or QB, QD, QG, QJ	MH56	NC56 ( )	NC56( )HR	—	—	MH56WP	—	56
					NQ418L1C				MH62	NC62 ( )	NC62( )HR	NC62V( )3P	NC62V( )3PHR	MH62WP	MH62D9VWP	62
					NQ430L1				MH68	NC68V ( )	NC68V( )HR	NC68V( )3P	NC68V( )3PHR	MH68WP	MH68D9VWP	68
			NQ430L1C	MH74	NC74V ( )				NC74V( )HR	NC74V( )3P	NC74V( )3PHR	MH74WP	MH74D9VWP	74		
			NQ430L2	MH80	NC80V ( )				NC80V( )HR	NC80V( )3P	NC80V( )3PHR	MH80WP	MH80D9VWP	80		
			NQ442L2	MH86D9 [37]	NC86V ( )				NC86V( )HR	NC86V( )3P	NC86V( )3PHR	—	—	86		
30	225		NQ454L2	NQMB2HJ	NQMB2Q	HJQLLC	HD, HG, HJ, HL, HR, JG, JJ, JL, JR; or QB, QD, QG, QJ	MH62	NC62 ( )	NC62( )HR	NC62V( )3P	NC62V( )3PHR	—	62		
			NQ454L2C					MH68	NC68V ( )	NC68V( )HR	NC68V( )3P	NC68V( )3PHR	—	68		
			NQ442L2					MH74	NC74V ( )	NC74V( )HR	NC74V( )3P	NC74V( )3PHR	—	74		
		NQ442L2C	MH80					NC80V ( )	NC80V( )HR	NC80V( )3P	NC80V( )3PHR	—	80			
		NQ454L4	MH86D9 [37]					NC86V ( )	NC86V( )HR	NC86V( )3P	NC86V( )3PHR	—	86			
		NQ454L4C	MH86D9 [37]					NC86V ( )	NC86V( )HR	NC86V( )3P	NC86V( )3PHR	—	86			
30	400	NQ472L2	NQMB4LA	LALLC	LALLC	LA/LH[36]	MH62	NC62 ( )	NC62( )HR	NC62V( )3P	NC62V( )3PHR	—	62			
		NQ472L2C					MH68	NC68V ( )	NC68V( )HR	NC68V( )3P	NC68V( )3PHR	—	68			
		NQ484L2					MH74	NC74V ( )	NC74V( )HR	NC74V( )3P	NC74V( )3PHR	—	74			
		NQ484L2C					MH80	NC80V ( )	NC80V( )HR	NC80V( )3P	NC80V( )3PHR	—	80			
		NQ484L4					MH86D9 [37]	NC86V ( )	NC86V( )HR	NC86V( )3P	NC86V( )3PHR	—	86			
		NQ484L4C					MH86D9 [37]	NC86V ( )	NC86V( )HR	NC86V( )3P	NC86V( )3PHR	—	86			
30	600	NQ430L4	NQMB6PP-L	PPLLC	PPLLC	LG, LJ, LL	MH62D9 [37]	NC62V( )	NC62V( )HR	NC62V( )3P	NC62V( )3PHR	—	62 / 68			
		NQ430L4C					MH68D9 [37]	NC68V( )	NC68V( )HR	NC68V( )3P	NC68V( )3PHR	—	68 / 74			
		NQ442L4					MH74D9 [37]	NC74V( )	NC74V( )HR	NC74V( )3P	NC74V( )3PHR	—	74 / 80			
		NQ442L4C					MH80D9 [37]	NC80V( )	NC80V( )HR	NC80V( )3P	NC80V( )3PHR	—	80			
		NQ454L4					MH86D9 [37]	NC86V( )	NC86V( )HR	NC86V( )3P	NC86V( )3PHR	—	86			
		NQ454L4C					MH86D9 [37]	NC86V( )	NC86V( )HR	NC86V( )3P	NC86V( )3PHR	—	86			
42	600	NQ472L4	NQMB6PP-L	PPLLC	PPLLC	LG, LJ, LL	MH62D9 [37]	NC62V( )	NC62V( )HR	NC62V( )3P	NC62V( )3PHR	—	62 / 68			
		NQ472L4C					MH68D9 [37]	NC68V( )	NC68V( )HR	NC68V( )3P	NC68V( )3PHR	—	68 / 74			
		NQ484L4					MH74D9 [37]	NC74V( )	NC74V( )HR	NC74V( )3P	NC74V( )3PHR	—	74 / 80			
		NQ484L4C					MH80D9 [37]	NC80V( )	NC80V( )HR	NC80V( )3P	NC80V( )3PHR	—	80			
84	600	NQ430L6C	NQMB6PP-L	PPLLC	PPLLC	LG, LJ, LL	MH86D9 [37]	NC86V( )	NC86V( )HR	NC86V( )3P	NC86V( )3PHR	—	86			
		NQ442L6C					MH86D9 [37]	NC86V( )	NC86V( )HR	NC86V( )3P	NC86V( )3PHR	—	86			
		NQ454L6C					MH86D9 [37]	NC86V( )	NC86V( )HR	NC86V( )3P	NC86V( )3PHR	—	86			
		NQ472L6C					MH86D9 [37]	NC86V( )	NC86V( )HR	NC86V( )3P	NC86V( )3PHR	—	86			
84	600	NQ484L6C	NQMB6PP-L	PPLLC	PPLLC	LG, LJ, LL	MH86D9 [37]	NC86V( )	NC86V( )HR	NC86V( )3P	NC86V( )3PHR	—	86			

PANELBOARDS 9

[32] For the NQ14-inch-wide panelboard offer, See NQ 14-inch-wide—240 Vac, 48 Vdc.

[33] Pole spaces shown are available for branch circuits, with spaces deducted for the back-fed main breaker.

[34] Do not select a back-fed main for panels to be "Suitable for use as UL service equipment." Select a H frame circuit breaker (and associated main circuit breaker kit) from the list for 225 interiors, for panels to be "Suitable for use as UL service equipment."

[35] QOB2110VH, QOB2125VH, or QOB2150VH take four pole spaces in NQ single phase interior.

[36] Available for 125–400 A applications. Please order short handle circuit breaker (i.e., LAL36400MB).

[37] D9 suffix indicates the 8.75 in. Deep Enclosure required for panelboards wit PowerPact L Main Breaker, Switch, or Sub-Feed Breaker. See PBA604 for dimensional details.

NQ 14-inch-wide—240 Vac, 48 Vdc

Features

14-inch-wide NQ panelboards are available for those customers whose equipment space is limited. Developed with customer input, Square D™ brand NQ panelboards are built to last, featuring innovations for ease of installation and durability.

- 240 Vac, 48 Vdc maximum
- 225 A maximum main circuit breaker or main lugs
- 100 A maximum branch circuit breakers
- Visi-Trip™ indication on branch circuit breakers
- 10,000–65,000 A Short Circuit Current Rating (SCCR)
- Interiors supplied with silver flashed copper bus as standard
- Interiors accept bolt-on and plug-on branch circuit breakers
- Three-phase, four-wire, and single-phase, three-wire interiors available
- Panelboards available with Mono-Flat™ front
- May be suitable for use as service entrance equipment with neutral bonding kit and main circuit breaker barrier installed
- Branch circuit filler plates provide fast and easy installation
- Both fully and series-rated systems are available



14-inch wide NQ Panelboard Main Lug



Main Circuit Breaker Panelboard



Main Lug Panelboard

Table 9.7: Main Lug Interiors—Accepts Plug-On and Bolt-On Branch Breakers

Max. Number of Breakers	Main Ratings	Interior Only (Order Branch Circuit Breakers Separately)	NEMA Type 1 Enclosure		
			Box 14"W x 5.75" Db	Mono Flat Front	Hinged Front
		Cat. No.	Cat. No.	Cat. No. [38]	Cat. No.
<b>14-inch-wide Cabinet—Single Phase 3-Wire</b>					
18	100 A	NQ18L1C14	NQB532	NQC32 ( )	N/A
30		NQ30L1C14	NQB532	NQC32 ( )	N/A
30	225 A	NQ30L2C14	NQB532	NQC32 ( )	N/A
42		NQ42L2C14	NQB538	NQC38 ( )	N/A
<b>14-inch-wide Cabinet—Three Phase 4-Wire</b>					
18	100 A	NQ418L1C14	NQB532	NQC32 ( )	N/A
30		NQ430L1C14	NQB532	NQC32 ( )	N/A
30	225 A	NQ430L2C14	NQB532	NQC32 ( )	N/A
42		NQ442L2C14	NQB538	NQC38 ( )	N/A

Table 9.8: Main Circuit Breaker Interiors—Accepts Plug-On and Bolt-On Branch Breakers

Max. Number of Breakers	Main Ratings	Interior Only (Order Branch Circuit Breakers Separately)	Main Circuit Breaker Kit [39]	UL SE Barrier Kit	Main Circuit Breaker Frame	NEMA Type 1 Enclosure		
						Box 14"W x 5.75" Db	Mono Flat Front	Hinged Front
		Cat. No.			Cat. No. [40]	Cat. No. [38]	Cat. No.	
<b>14-inch-wide Cabinet—Single Phase 3-Wire</b>								
16 [41]	100	NQ18L1C14	—	—	Select QOB 2-pole or QOB-VH [39]	NQB532	NQC32 ( )	N/A
28 [41]		NQ30L1C14	—	—	NQB532	NQC32 ( )	N/A	
30	225	NQ30L2C14	NQMB2H-J14 or NQMB2Q14	HJQL-LC	HD, HG, HJ, HL, HR JD, JG, JJ, JL, QB, QD, QG, QJ	NQB544	NQC44 ( )	N/A
42		NQ42L2C14	NQB550	NQC50 ( )	N/A			
<b>14-inch-wide Cabinet—Three Phase 4-Wire</b>								
15 [41]	100	NQ418L1-C14	—	—	Select QOB 3-pole or QOB-VH [39]	NQB532	NQC32 ( )	N/A
27 [41]		NQ430L1-C14	—	—	NQB532	NQC32 ( )	N/A	
30	225	NQ430L2-C14	NQMB2H-J14 or NQMB2Q14	HJQL-LC	HD, HG, HJ, HL, HR JD, JG, JJ, JL, QB, QD, QG, QJ	NQB544	NQC44 ( )	N/A
42		NQ442L2-C14	NQB550	NQC50 ( )	N/A			

Table 9.9: NQ Accessories

Description	Catalog No.
<b>Equipment Ground Bars</b>	
Aluminum (twenty seven terminations #14 to #4 AWG)	PK27GTA
PK23GTA+ #1 to #4/0 AWG Al or Cu lug	PK23GTAL
Copper (twenty seven terminations #14 to #4 AWG)	PK27GTACU
Ground Bar Insulator Kit	PKGTAB
<b>Handle Attachments—Branch Circuit Breakers</b>	
Handle lock-off	HLO1
Handle tie - (QO and QOB only)	QO1HT
Handle padlock attachment—1-pole	QO1PA
2- and 3-pole	QO1PL
Handle tie and lock-off for three 1-pole (QO, QOB)	QO3HT
<b>Other Accessories</b>	
Filler plates (15 per package)	NQFP15

[38] Add "F" for flush mount, "S" for surface mount.

[39] Select a Q or H frame circuit breaker, HJQLLC barrier (and associated main circuit breaker kit) from the list for 225 interiors, for panels to be "Suitable for use as UL service equipment."

[40] All 14" W boxes come with blank endwalls.

[41] Pole spaces shown are available for branch circuits, with spaces deducted for the back-fed main circuit breaker.

**QOB Bolt-On Circuit Breakers with Visi-Trip™ Indicator for NQ Panelboards**

**NOTE:** NQ panelboards also accept QO plug-on circuit breakers, see tables in Section 7 of the Digest. NQ panelboards with 175 A or 200 A QO breakers require three point latch trim fronts.<sup>[42]</sup>

**Table 9.10: QOB-GFI, QOB-EPD, and QOB-EPE Circuit Breakers**

Am- pere Rating <sup>[43]</sup>	One-pole	Two-pole—Common Trip	Three-pole—Common Trip	
	Catalog No.	Catalog No.	Catalog No.	Catalog No.
<b>QOB-GFI—QOB Qwik-Gard™ Circuit Breaker With Ground Fault Circuit Interrupter—UL Class A 4–6 mA People Protection.</b> <sup>[44]</sup>				
	120 Vac—10 k AIR <sup>[45]</sup>	120/240 Vac— 10 k AIR <sup>[45]</sup>	208Y/120 Vac— 10 k AIR	
15 A	QOB115GFI	QOB215GFI	QOB315GFI	
20 A	QOB120GFI	QOB220GFI	QOB320GFI	
25 A	QOB125GFI	QOB225GFI	—	
30 A	QOB130GFI	QOB230GFI	QOB330GFI	
40 A	—	QOB240GFI	QOB340GFI	
50 A	—	QOB250GFI	QOB350GFI	
60 A	—	QOB260GFI <sup>[46]</sup>	—	
<b>QOB-VHGF</b> <sup>[47]</sup>				
	120 Vac—22 k AIR <sup>[45]</sup>			
15 A	QOB115VHGF			
20 A	QOB120VHGF			
25 A	QOB125VHGF			
30 A	QOB130VHGF			
<b>QOB-EPD—QOB Equipment protection circuit breakers with UL Listed 30 mA (EPD) or 100 mA (EPE) equipment protection.</b>				
	120 Vac—10 k AIR <sup>[45]</sup>	120/240 Vac— 10 k AIR <sup>[45]</sup>	240 Vac—10 k AIR <sup>[45]</sup>	
15 A	QOB115EPD	QOB215EPD	QOB315EPD	QOB315EPE
20 A	QOB120EPD	QOB220EPD	QOB320EPD	QOB320EPE
25 A	QOB125EPD	QOB225EPD	—	—
30 A	QOB130EPD	QOB230EPD	QOB330EPD	QOB330EPE
40 A	—	QOB240EPD	QOB340EPD	QOB340EPE
50 A	—	QOB250EPD	QOB350EPD	QOB350EPE
60 A	—	QOB260EPD	—	—
<b>QOB-VHEPD</b>				
	120 Vac—22 k AIR <sup>[45]</sup>			
15 A	QOB115VHEPD			
20 A	QOB120VHEPD			
25 A	QOB125VHEPD			
30 A	QOB130VHEPD			
<b>QOB-HM—High magnetic trip circuit breakers</b>				
15 A	QOB115HM <sup>[48]</sup>			
20 A	QOB120HM <sup>[48]</sup>			
<b>QOB-K—Key operated QOB circuit breakers</b> <sup>[49]</sup>				
	120 Vac—10 k AIR <sup>[45]</sup>			
10 A	QOB110K			
15 A	QOB115K			
20 A	QOB120K			
25 A	QOB125K			
30 A	QOB130K			

PANELBOARDS 9

<sup>[42]</sup> For QO plug-on circuit breakers, see the tables starting on Section 7 of the Digest.

<sup>[43]</sup> 10–30 A circuit breakers are suitable for use with 60 °C or 75 °C conductors. 35–60 A circuit breakers are suitable for use with 75 °C conductors.

<sup>[44]</sup> Do not connect to more than 250 feet of load conductor for the total one-way run to prevent nuisance tripping.

<sup>[45]</sup> May be applied in 208Y/120 Vac systems.

<sup>[46]</sup> Suitable only for feeding 240 Vac and 208 Vac two-wire loads. Does not contain load neutral connection.

<sup>[47]</sup> Recommended for applications where high initial inrush may occur and for individual dimmer applications.

<sup>[48]</sup> UL Listed as SWD (switching duty) rated suitable for switching 120 Vac fluorescent lighting loads.

<sup>[49]</sup> Available in single pole construction and can be mounted in any single pole space which will accept a standard QOB. These circuit breakers can be turned ON or OFF or RESET with a special key (Catalog No. QOK10) included with the circuit breaker. These circuit breakers are UL Listed and available as shown in the table.

Table 9.11: Standard Interrupting QOB 10,000 AIR Circuit Breakers

Ampere Rating [50]	One-pole	Two-pole—Common Trip	Two-pole—Common Trip [51]	Three-pole—Common Trip
	Catalog No.	Catalog No.	Catalog No.	Catalog No.
QOB Bolt-On				
	120 Vac—10 k AIR 48 Vdc—5 k AIR[52]	120/240 Vac—10 k AIR 48 Vdc—5 k AIR [53] [52]	240 Vac—10 k AIR[52]	240 Vac—10 k AIR 48 Vdc—5 k AIR [53] [52]
10 A	QOB110	QOB210	—	QOB310
15 A	QOB115[54][55]	QOB215[55]	QOB215H	QOB315[55]
20 A	QOB120[54][55]	QOB220[55]	QOB220H	QOB320[55]
25 A	QOB125[55]	QOB225[55]	QOB225H	QOB325[55]
30 A	QOB130[55]	QOB230[55]	QOB230H	QOB330[55]
35 A	QOB135[55]	QOB235[55]	—	QOB335[55]
40 A	QOB140[55]	QOB240[55]	QOB240H	QOB340[55]
45 A	QOB145[55]	QOB245[55]	—	QOB345[55]
50 A	QOB150[55]	QOB250[55]	QOB250H	QOB350[55]
60 A	QOB160[55]	QOB260[55]	QOB260H	QOB360[55]
70 A	QOB170[55]	QOB270[55]	QOB270H	QOB370[55][53]
80 A	—	QOB280[55] [53]	QOB280H	QOB380[55][53]
90 A	—	QOB290[55] [53]	QOB290H	QOB390[55] [53]
100 A	—	QOB2100[55] [53]	QOB2100H	QOB3100[55] [53]
110 A	—	QOB2110[55] [53]	—	—
125 A	—	QOB2125[55] [53]	—	—
Molded Case Switch 60 A max—240 Vac	—	QOB200	—	QOB300
Molded Case Switch 100 A max—240 Vac	—	QOB2000	—	QOB3000

Table 9.12: High Interrupting QOB and Specialty Circuit Breakers[50]

Ampere Rating [50]	One-pole	Two-pole—Common Trip	Three-pole—Common Trip
	Catalog No.	Catalog No.	Catalog No.
QOB-VH			
	120 Vac—22 k AIR[52]	120/240 Vac—22 k AIR[52]	240 Vac—22 k AIR[52]
15 A	QOB115VH[54][55]	QOB215VH[55]	QOB315VH[55]
20 A	QOB120VH [54][55]	QOB220VH[55]	QOB320VH[55]
25 A	QOB125VH[55]	QOB225VH[55]	QOB325VH[55]
30 A	QOB130VH[55]	QOB230VH[55]	QOB330VH[55]
40 A	QOB140VH	QOB240VH[55]	QOB340VH[55]
50 A	QOB150VH	QOB250VH[55]	QOB350VH[55]
60 A	QOB160VH	QOB260VH[55]	QOB360VH[55]
70 A	QOB170VH	QOB270VH[55]	QOB370VH[55]
80 A	—	QOB280VH[55]	QOB380VH[55]
90 A	—	QOB290VH[55]	QOB390VH[55]
100 A	—	QOB2100VH[55]	QOB3100VH[55]
110 A	—	QOB2110VH[55]	QOB3110VH [56]
125 A	—	QOB2125VH[55]	QOB3125VH [56]
150 A	—	QOB2150VH [56]	QOB3150VH [56]
QHB			
	120 Vac—65 k AIR[52]	120 Vac/240 Vac—65 k AIR [52]	240 Vac—65 k AIR[52]
15 A	QHB115 [54]	QHB215[55]	QHB315[55]
20 A	QHB120 [54]	QHB220[55]	QHB320[55]
25 A	QHB125[55]	QHB225[55]	QHB325[55]
30 A	QHB130[55]	QHB230[55]	QHB330[55]
QOB-HID—HID circuit breakers [57]			
	120 Vac—10 k AIR[52]	120/240 Vac—10 k AIR[52]	240 Vac—10 k AIR[52]
15 A	QOB115HID [54]	QOB215HID	QOB315HID
20 A	QOB120HID [54]	QOB220HID	QOB320HID
25 A	QOB125HID	QOB225HID	QOB325HID
30 A	QOB130HID	QOB230HID	QOB330HID
40 A	QOB140HID	QOB240HID	—
50 A	QOB150HID	QOB250HID	—
QOB-SWN—Switch Neutral—Common Trip—NEC 514.11			
		1-pole—2-Wire 2 Spaces—120 Vac[52]	2-pole—3-Wire 3 Spaces—120/240 Vac[52]
10 A	—	QOB210SWN	QOB310SWN
15 A	—	QOB215SWN	QOB315SWN
20 A	—	QOB220SWN	QOB320SWN
25 A	—	QOB225SWN	QOB325SWN
30 A	—	QOB230SWN	QOB330SWN
40 A	—	QOB240SWN	QOB340SWN
50 A	—	QOB250SWN	QOB350SWN

[50] 10–30 A circuit breakers are suitable for use with 60°C or 75°C conductors. 35–60 A circuit breakers are suitable for use with 75°C conductors.

[51] UL Listed 5,000 AIR on 3Ø corner grounded delta systems.

[52] May be applied in 208Y/120 Vac systems.

[53] DC Rating is not available on indicated products.

[54] UL Listed as SWD (switching duty) rated suitable for switching 120 Vac fluorescent lighting loads.

[55] UL Listed as HACR type for use with air conditioning, heating, and refrigeration equipment having motor group combinations and marked for use with HACR type circuit breakers.

[56] QOB2150VH uses 4 pole spaces. QOB3110VH, QOB3125VH, and QOB3150VH each use 6 pole spaces. 40A maximum circuit breaker mounted opposite. Use with 75 °C wire only.

[57] UL Listed for use on circuit feeding fluorescent and High Intensity Discharge (HID) lighting systems such as mercury vapor, metal halide, or high pressure sodium. These circuit breakers are physically interchangeable with QOB circuit breakers.

**Table 9.13: QO/QOB Circuit Breaker Wire Sizes**

Breaker Type	Ampere Rating	Wire Size (AWG or kcmil)	
		Al	Cu
QOB 1-pole	10–30 A	#14–8	#14–8
	10–30 A	—	two #14–10
	35–70 A	#8–2	#8–2
QOB 2-pole	10–30 A	#14–8	#14–8
	10–30 A	—	two #14–10
	35–70 A	#8–2	#8–2
	80–125 A	#4–2/0	#4–2/0
	150–200 A	#4–300	#4–300
QOB 3-pole	10–30 A	#14–8	#14–8
	35–70 A	#8–2	#8–2
	80–125 A	#4–2/0	#4–2/0
QOB-VH	110–150 A	#4–300	#4–300
QOB-GFI and QOB-EPD	15–30 A	#12–8	#14–8
	40, 50, or 60 A	#12–4	#14–6

**Table 9.14: QO™ Arc-Fault and Dual Function Circuit Breakers [58][59][60]**

Circuit Breaker Type	Ampere Rating [60]	1P 120 Vac 10 kAIR 1 Space Required	1P 120 Vac 22 kAIR 1 Space Required	2P 240 Vac 10 kAIR 2 Space Required	2P 240 Vac 22 kAIR 2 Space Required
		Catalog Number	Catalog Number	Catalog Number	Catalog Number
Combination Arc-Fault Interrupter	15 A	QOB115CAFI	QOB115VHCAFI	QOB215CAFI	QOB215VHCAFI
	20 A	QOB120CAFI	QOB120VHCAFI	QOB220CAFI	QOB220VHCAFI
Dual Function: Arc-Fault and Ground Fault	15 A	QOB115DF	QOB115VHDF	Use plug-on QO 2-pole dual function MCBs	
	20 A	QOB120DF	QOB120VHDF		

**NOTE:** For accessories, see Accessories for QO/QOB Circuit Breakers, in Section 7.

Single Phase 400 or 600 A NQ Panelboards now accept 150 A, 175 A, and 200 A Two Pole QO Plug-on Branch Circuit Breakers.

Each breaker takes four pole spaces. Installation into three phase interiors is not allowed as it may create a phase to phase short circuit.

One NQ200AN neutral lug kit should be installed for each pair of 175 or 200 A QO breakers if a neutral termination is required.

- One Q1150AN lug kit should be installed for each 110 A to 150 A QO(B) circuit breaker, if a neutral termination is required.

**Table 9.15: High Ampacity Plug-on Two Pole QO Branch Circuit Breakers**

Catalog Number	Ampere Rating	AIC Rating
QO2150	150	10 kA
QO2150VH	150	22 kA
QO2175	175	10 kA
QO2200	200	
QO2175VH	175	22 kA
QO2200VH	200	

**NOTE:** May only be installed on Single Phase 400 A or 600 A NQ Panelboards with three point latch trim fronts.

A maximum of four 150 A, 175 A, or 200 A QO (VH) plug-on branch circuit breakers may be installed in NEMA 1 enclosures. These enclosures require NCxxV( )3P three point latch trim fronts, as listed in Table 9.5 Main Lug Interiors, page 9-11 or Table 9.6 Main Circuit Breaker Interiors, page 9-12.

One 150 A, 175 A, or 200 A QO (VH) plug-on branch circuit breaker may be installed in 8.75" deep MHxxD9VWP NEMA 3R enclosures, as listed in Table 9.5 Main Lug Interiors, page 9-11 or Table 9.6 Main Circuit Breaker Interiors, page 9-12.

[58] UL Listed as HACR type for use with air conditioning, heating, and refrigeration equipment having motor group combinations and marked for use with HACR type circuit breakers.

[59] QO arc-fault circuit breakers provide branch feeder protection (for example, QO115AFI) or combination protection (for example, QO115CAFI) as required by the NEC and local code adoption, and comply with UL 1699.

[60] 10–30 A circuit breakers are suitable for use with 60°C or 75°C conductors. 35–60 A circuit breakers are suitable for use with 75°C conductors.

**Factory Assembled Main Circuit Breakers**

400 A and 600 A panelboards, 1Ø or 3Ø

**Table 9.16: NQ Panelboard Factory Assembled Interiors - 240 Vac / 48 Vdc Max**

Single Phase or Three Phase						
Mains Rating (Amps)			Max. Number of One-Pole Circuit Breakers	Bus Material	Min. Box Depth	
Main Lugs Only	Main Circuit Breaker <sup>[61]</sup>	Main Switch <sup>[61]</sup>			Main Lugs Only	Main Circuit Breaker / Switch
100 Max	15–100	70–100	18, 30	Al, Cu	5.75 in.	5.75 in.
225 Max	15–250	110–250	30, 42, 54, 72, 84	Al, Cu	5.75 in.	5.75 in.
400 Max	125–400	300–400	30, 42, 54, 72 <sup>[62]</sup> , 84 <sup>[63]</sup>	Al, Cu	5.75 in.	5.75 in. / 8.75 in. <sup>[64]</sup>
600 Max	125–600	450–600	30, 42, 54, 72 <sup>[62]</sup> , 84	Cu	5.75 in.	8.75 in. <sup>[64]</sup>

**Table 9.17: Main Circuit Breaker (PowerPact L-frame - see PowerPact Interrupting Ratings, and Common Catalog Numbering System, in Section 7)**

Number of Poles	Trip Unit Options	Frame Sizes	Ampacity
3	LI, LSI, Switch	LG, LJ, LL	125–600 A

LA/LH PowerPact H, J, and Q-frame circuit breakers are also available - see Tables PowerPact Interrupting Ratings, page and Common Catalog Numbering System, page and Supplemental Digest Section 3.

**Table 9.18: PowerPact L Main Circuit Breaker Cabinet Height (inches)**

Max. No. of Branch Spaces (Does not include sub-feed circuit breaker spaces)	NEMA 1 Enclosure (20 in. W x 8.75 in. D) <sup>[65]</sup>	Vented NEMA 3R Enclosure (26 in. W x 8.75 in. D) <sup>[66]</sup>	
	400 or 600 A	400 A	600 A
30	62	62	68
42	68	68	74
54	74	74	80
72	80	–	–
84	86	–	–

**Sub-feed Circuit Breakers**

Main lugs or main circuit breaker interior—1Ø or 3Ø.

Maximum 1 circuit breaker per 225 A main lug or 250 A main circuit breaker panelboard, 2 PowerPact H-, J-, or Q-frame sub-feed circuit breakers may be installed on a 400–600 A panelboard.

Panelboards in MHxxWP NEMA Type 3R/5/12 enclosures are limited to one 150 A maximum sub-feed breaker.

- Panelboards in vented MHxxD9VWP NEMA 3R enclosures may have two 225 A maximum sub-feed circuit breakers. A single 600 A maximum sub-feed circuit breaker may be factory installed in these new enclosures.

**Table 9.19: Sub-feed Circuit Breakers for NQ Panelboards<sup>[67]</sup>**

Interior Rating	Sub Feed Circuit Breakers <sup>[67]</sup>			Space Factor
	Ampacity	Poles	MCCB Frame	
225 A	70–225	2 or 3	QB, QD, QG, QJ	18 in.
	110–150	2 or 3	HD, HG, HJ, HL, HR <sup>[68]</sup>	
	150–225	2 or 3	JD, JG, JJ, JL, JR <sup>[69]</sup>	
400 A / 600 A	70–225	2 or 3	QB, QD, QG, QJ <sup>[70]</sup>	24 in.
	110–150	2 or 3	HD, HG, HJ, HL, HR <sup>[68]</sup> , <sup>[70]</sup>	
	150–225	2 or 3	JD, JG, JJ, JL, JR <sup>[69]</sup> , <sup>[70]</sup>	
	125–400	2 or 3	LA / LH	18 in. <sup>[71]</sup>
	125–600	3	LG, LJ, LL	12 in. <sup>[72]</sup>

PowerPact H, J, & L frame circuit breakers are also available - see Tables PowerPact Interrupting Ratings, and Common Catalog Numbering System, Section 7.

<sup>[61]</sup> Factory Assembled Interiors are rated for trip current of Main Breaker / Switch.

<sup>[62]</sup> Three Phase only.

<sup>[63]</sup> Copper only.

<sup>[64]</sup> Deep Box required for PowerPact L Main Circuit Breaker or Switch.

<sup>[65]</sup> D9 8.75" deep enclosures are required for PowerPact L Main Circuit Breaker, Switch, or Sub-Feed Circuit Breaker. Reference PBA713x drawing for more dimensional information, where x may be A, HR, HRT, or T depending upon the choice of options and enclosure.

<sup>[66]</sup> Feed-thru lugs and compression lugs available factory assembled only. These add 6 - 12 inches to enclosure length. Please reference PBA755 or PBA755T for more complete dimensional information, where x may be A, HR, HRT, or T depending upon the choice of options and enclosure.

<sup>[67]</sup> See Digest Section 7 for Interrupting Ratings and Catalog Numbers of PowerPact H-, J-, L-, Q- and LA/LH frame MCCBs.

<sup>[68]</sup> Three pole HD, HG, HR MCCBs are installed for single phase sub-feed circuit breaker applications.

<sup>[69]</sup> Three pole JR MCCBs are installed for single phase sub-feed circuit breaker applications.

<sup>[70]</sup> One or two sub-feed circuit breakers may be selected.

<sup>[71]</sup> NQ Panelboards with LA or LH sub-feed circuit breaker and LG, LJ, or LL main circuit breaker are supplied with 26" wide, 8.75" deep enclosures and have Condo Riser neutral assemblies.

<sup>[72]</sup> Space Factor for LG, LJ, or LL is 24" when it is installed onto a main circuit breaker panelboard. These panelboards are supplied with 26" wide, 8.75" deep enclosures and have Condo Riser neutral assemblies.

**Table 9.20: PowerPact H, J, or Q-frame Sub-feed Circuit Breaker Cabinet Height (inches)<sup>[73]</sup>**

Max. No. of Branch Circuit Spaces (not including sub-feed circuit breaker)	Mains Type and Maximum Current Rating				
	225 A Main Lugs <sup>[74]</sup>	250 A Main Circuit Breaker <sup>[75]</sup>	400 / 600 A Main Lugs <sup>[76]</sup>	400 A LA/LH Main Circuit Breaker <sup>[77]</sup>	400 / 600 A LG/LJ/LL Main Circuit Breaker <sup>[78]</sup>
30	50	62	74	86	86
42	56	68	74	86	86
54	62	74	80	92	—
72	68	80	86	—	—
84	74	86	92	—	—

**Table 9.21: PowerPact LG, LJ, or LL Sub-feed Circuit Breaker Cabinet Height (inches)<sup>[79]</sup>**

Max. No. of Branch Spaces (Does not include sub-feed circuit breaker spaces)	NEMA 1 D9 Enclosure (20" W x 8.75" D) <sup>[80]</sup>			Vented NEMA 3R Enclosure Height (26 in. W x 8.75 in. D)			
	20-in. Wide		26-in. Wide	Main Lugs	Main Circuit Breaker		
	LA / LH Main		LG / LJ / LL <sup>[80]</sup>		LA / LH	400A PP-L	600A PP-L
	Main Lugs	Circuit Breaker	Main Breaker	LA / LH	400A PP-L	600A PP-L	
30	68	80	80	74	80	80	86
42	68	80	86	74	80	86	92
54	74	86	92	80	86	92	—
72	80	92	—	86	92	—	—
84	86	—	—	92	—	—	—

**Table 9.22: Optional Factory Assembled Lugs for Main Lugs Only and Main Circuit Breaker Interiors**

Incoming Lug Type:
Aluminum Compression Lugs
Copper Mechanical Lugs
Copper Compression Lugs

**NOTE:** Optional lugs are not available for Q frame main or QOB circuit breakers.

**Sub-feed Lugs**

**NOTE:** Available on main lug interiors only, 1Ø or 3Ø.

**Table 9.23: Sub-feed Lug Wire Range Per Phase (AWG or kcmil)**

Mains Rating	Incoming	Outgoing
100	one #6-2/0 Al or Cu	one #6-2/0 Al or Cu
225	one 1/0-350 kcmil Al or Cu	one 1/0-350 kcmil Al or Cu
400	one 1/0-750 kcmil Cu only	one 1/0-750 kcmil Cu only

**Table 9.24: Sub-feed Lug Cabinet Data**

Max. No. of Branch Spaces	Box Height (20 in. W x 5.75 in. D)		
	100 A	225 A	400 A
18	MH26	—	—
30	MH32	MH38	MH50
42	—	MH44	MH50
54	—	MH44	MH50
72	—	MH50	MH62
84	—	MH56	MH68

<sup>[73]</sup> Bottom feed only in NEMA Type 3R enclosures. NEMA 3R applications with sub-feed circuit breakers greater than 150A require 8.75" deep, 26" wide enclosure - reference PBA603WP.

<sup>[74]</sup> Reference PBA701x drawing for more dimensional information. PBA701x - x may be A, E, HR, HRT, or T, depending upon choice of options and trim front.

<sup>[75]</sup> Reference PBA707x drawing for more dimensional information. PBA707x - x may be A, E, HR, HRT, or T, depending upon choice of options and trim front.

<sup>[76]</sup> Reference PBA709x drawing for more dimensional information. Bottom feed only in NEMA Type 3R enclosures. NEMA 3R applications with sub-feed circuit breakers greater than 150A require 8.75" deep, 26" wide enclosure - reference PBA603WP. PBA709x - x may be A, E, HR, HRT, or T, depending upon choice of options and trim front.

<sup>[77]</sup> Reference PBA710x drawing for more dimensional information. Bottom feed only in NEMA Type 3R enclosures. NEMA 3R applications with sub-feed circuit breakers greater than 150 A require 8.75" deep, 26" wide enclosure - reference PBA603WP. PBA710x - x may be A, E, HR, HRT, or T depending upon choices of options and trim front.

<sup>[78]</sup> LG, LJ, or LL Main Circuit Breaker requires D9 8.75" enclosure. Reference PBA713x or PBA755x drawing for more dimensional information. PBA###x - x may be A, E, HR, HRT, or T, depending upon choice of options and enclosure.

<sup>[79]</sup> Feed-thru lugs and compression lugs available factory assembled only. These add 6 - 12 inches to enclosure length.

<sup>[80]</sup> NQ Panelboards with PowerPact L Main Circuit Breaker and PowerPact L Sub-Feed Circuit Breaker are supplied with Condo Riser Neutral Assemblies, and require 26" wide, 8.75" deep enclosures.



Feed-through Lugs

Table 9.25: Feed-through Lugs

Mains Rating	Feed-Through Wire Range Per Phase (AWG or kcmil)
100 A	one #6-2/0 Al or Cu
225 A	one #6-350 Al or Cu
400 A	one 1/0-750 or two 1/0-350 Al or Cu
600 A	two 1/0-750 Al or Cu

Table 9.26: Feed-through Lugs Cabinet Data

Max. No. of Branch Spaces	Box Height (20 in. W x 5.75 in. D)					
	225 A		250 A		400 A	
	Main Lugs	Main Circuit Breaker	Main Lugs	Main Circuit Breaker	Main Lugs	Main Circuit Breaker [81]
30	38	50	50	62	62	68
42	38	50	56	68	62	80
72	50	62	68	80	74	—
84	56	68	68	80	80	—

Table 9.27: Name Plates

Name Plates
Standard white face/black letter laminated bakelite, 1 in. x 3.5 in., adhesive backed or screw mountable with screws in a bag assembly

Table 9.28: Copper Bus Bars

Copper Bus Bars
100 A, 225 A, 250 A
400 A
600 A

Table 9.29: NQ Panelboard Neutral Assembly Options

Interior Rating	Without Sub-Feed or Thru-Feed Lugs				With Sub-Feed or Thru-Feed Lugs			
	100% Neutrals		200% Neutrals		100% Neutrals		200% Neutrals	
	Aluminum	Copper	Aluminum	Copper	Aluminum	Copper	Aluminum	Copper
100 A	Standard	NQN1CU	NQNL1	Factory Assembled Only	Standard	NQN1CU	NQNL1	Factory Assembled Only
225 A		NQN2CU	NQNL2			NQNL2ACCY		
400 A		NQN6CU	NQNL4			FA Only [82]		
600 A [83]			Not Available			Not Available	Not Available	

Table 9.30: NQ Main 100% and 200% Rated Neutral Conductors—(Quantity) and Wire Size (Mechanical Lugs & Compression Lugs) [84]

Interior Rating	Lug Material	Mechanical Neutral Line Lugs						Compression Neutral Line Lugs	
		100% Rated			200% Rated [85] [86]			100% Rated	200% Rated [85] [86]
		Standard Neutral Assemblies	Oversized Neutral Assemblies	Space Factor	Standard Neutral Assemblies	Oversized Neutral Assemblies	Space Factor	Lug Wire Range	Lug Wire Range
100 A	Al Cu	(1) #6-2/0	select 225 A neutral assembly	N/A	(2) #6-2/0	select 225 A neutral assembly	N/A	(1) #6-2/0	(1) #6-2/0
225 A	Al Cu	(1) #6-300 kcmil [87] (1) #6-250 kcmil	select 400 A neutral assembly	N/A	(2) #6-350 kcmil (2) #6-250 kcmil	select 400 A neutral assembly	N/A	(1) #4-300 kcmil (1) #2/0-300 kcmil	(2) #1/0-300 (2) #2/0-300 kcmil
400 A	Al Cu	(2) 1/0-300 kcmil or (1) 1/0-700 kcmil [88]	(2) 1/0-750 kcmil or (4) 1/0-300 kcmil	6	(4) 1/0-300 kcmil or (2) 1/0-700 kcmil [88]	(4) 1/0-750 kcmil or (8) 1/0-300 kcmil	6	(2) 2/0-500 kcmil (2) 400-750 kcmil	(4) 2/0-500 kcmil (2) 400-750 kcmil
600 A	Al Cu	(4) 1/0-300 kcmil or (2) 1/0-700 kcmil [88]	(4) 1/0-700 kcmil [88] or (8) 1/0-300 kcmil	6	N/A	N/A	N/A	(2) 2/0-500 kcmil	N/A
600 A (with NQALMN6 or NQCUMN6)	Al Cu	N/A	(6) 1/0-750 kcmil or (4) 1/0-300 kcmil and (4) 1/0-750 kcmil	12	N/A	N/A	N/A	N/A	N/A

NOTE: Implicit AWG (American Wire Gauge) abbreviation on conductors wire range (kcmil is shown). Gutter extensions may be required to provide NEC wire bending space for cable(s) of maximum lug size.

Table 9.31: NQ Panelboard Condo Riser Neutral Panelboards (Requires 26" Wide Enclosure) [89]

Interior Rating	Maximum Branch Circuits	Neutral Rating	Neutral Assembly	Mains Options			Load End Options		Minimum Enclosure Depth
				Main Lugs	Main Circuit Breaker	Sub-Feed Lugs	Feed-Thru Lugs	Sub-Feed Breaker	
400 / 600 A	42	100%	NQN6CRUS	Y	LA / LH	N/A	Y	H, J, Q, LA / LH	5.75 inches
		200%	NQNL6CRUS						8.75 inches
	72 [90]	100%	NFN6CR	Y	LA, LG, LH, LJ, LL	Y	Y	Y	8.75 inches
		200%	NFNL6CR						8.75 inches



600 A NQ Main Breaker Panelboard with Condo Riser Neutral Assembly

[81] 8.75 in. deep box, ship fully assembled only.

[82] FA - Factory Assembled Panelboards

[83] 600 A main circuit breaker panelboards with PowerPact L sub-feed circuit breakers are supplied with Condo Riser Neutral Assemblies and require 26" wide, 8.75" deep enclosures.

[84] Lug Wire Ranges shown meet NEC wire bending space. Lugs may accept larger cables if enclosure size is increased.

[85] 200% Neutrals not available on Column Width interiors.

[86] Panelboards with 200% rated neutrals are not available with 250 A J-frame main circuit breakers or integral lighting contactors.

[87] Installation of 350 kcmil neutral conductors possible if enclosure is extended to increase wire bending space.

[88] Installation of 750 kcmil neutral conductors possible if enclosure is extended to increase wire bending space.

[89] Select 26" Wide Condo Riser Panel under Structure Options in the SE Advantage Panelboard Product Selector.

[90] May be used with a 84 circuit interior when a SurgeLoc SPD is installed. No more than 72 branch circuit breaker poles may be installed.

**Table 9.32: Metal Directory Frames**

Metal Directory Frame
Replaces standard plastic stick-on directory pouch, add "WMD" suffix to NC Trim catalog number.

**Table 9.33: NQ Equipment Ground Bar Kits<sup>[91]</sup>**

Interior Rating	Aluminum	Copper	Ground Bar Insulator Kit
100 A / 225 A	PK12GTA, PK18GTA, PK23GTA, or PK27GTA	PK27GTACU	PKGTAB
400 A / 600 A	PK12GTA, PK27GTA	PK27GTACU	PKGTAB

**Table 9.34: Hinged Door-in-Door Trim Fronts**

Hinged Door-in-Door Trim Front
Hinged Door-in-Door Trim Front has piano hinge down one side. Inner door has a lock, outer door is retained with screws
Hinged Door-in-Door Trim Fronts with Outer Door Lock in place of screws are available as a factory assembled option.

<sup>[91]</sup> One PK kit supplied when ground bar is specified. Two PK kits supplied when "extra" ground bar is ordered.

**Table 9.35: Weather and Dust Resistant Enclosures—Type 3R, 4, 4X, 5, 12**

**Weatherproof or Dusttight Cabinets**

**NOTE:** NQ panelboards with PowerPact L circuit breakers are not available with a NEMA Type 4, 4X, 5, or 12 enclosure. (Use I-Line).

NQ panelboards with PowerPact L circuit breakers are available with vented 26" wide NEMA 3R enclosures.

400 A NQ panelboards in NEMA 4, 4X, 5, or 12 enclosures are available with a subfeed breaker up to 150 A. See .

**Table 9.36: Surgelogic™ SurgeLoc Plug-On SPD**<sup>[92]</sup>

Surge Current Rating kA
80 kA
100 kA
120 kA
160 kA
200 kA
240 kA

**Table 9.37: Surgelogic SPD Features**

Description
Surge Counter
Dry Contacts
Remote Monitor

**NOTE:** Additional factory modifications, see [Modifications For Factory Assembled Panelboards](#), page 9-68.

[92] SurgeLogic units occupy 12 circuit positions (6 adjacent mounting spaces per side.)

**NQ Merchandised Accessories**

**Table 9.38: NQ Merchandised Neutral Assemblies**

Mains Rating (Amps)	200% Neutral Kit		Copper 100% Neutral Kit	
	Catalog No.	Space Factor	Catalog No.	Space Factor
100	NQNL1	0	NQN1CU	0
225	NQNL2	0	NQN2CU	0
225	NQNL2ACCY <sup>[93]</sup>	6		
400	NQNL4 <sup>[94]</sup>	0	NQN6CU	0
600	—	0		

**Table 9.39: NQ Merchandised Sub-feed Lugs, Feed-through Lugs, and Sub-feed Breaker Kits**

Mains Rating	Sub-feed Lugs Catalog Number	Feed-through Lugs Catalog Number	Sub-feed Circuit Breaker Kits (breaker not incl.)	
			Single SFB	Two SFBs
100 A	NQSFL1	100 A not available; use 225 A interior	—	—
225 A	NQSFL2	NQFTL2L <sup>[95]</sup>	NQSFB2Q or NQSFB2HJ <sup>[96]</sup>	—
		NQFTL2H <sup>[97]</sup>		
400 A	NQSFL4	NQFTL4L <sup>[95]</sup>	NQSFB4Q or NQSFB4HJ or NQMB6PPL <sup>[98]</sup> <sup>[96]</sup>	NQSFB4Q or NQSFB4HJ
		NQFTL4H <sup>[97]</sup>		
600 A	Not Available	Factory Assembled Only	NQSFB6PPL <sup>[98]</sup>	Factory Assembled Only

**NOTE:** See Table 9.40 and Table 9.41.

**Table 9.40: Box Selection Table: Merchandised NQ Main Lug Panelboards with Accessories**

Feature Circuits	Sub-feed Lugs				Feed-through Lugs				Sub-feed Circuit Breakers					
	100 A	225 A	400 A	600 A	100 A	225 A	400 A	600 A	100 A	225 A (one)	400 A (two)	400 A / 600 A (one)	600 A (two)	
18	MH26	—	—	Factory Assembled Only	Use 225 A Interior	—	—	Factory Assembled Only	—	—	—	—	Factory Assembled Only	
30	MH32	MH38	MH50			MH38	MH50		—	—	MH50	MH74		MH62D9
42	—	MH44	MH50			MH38	MH56		—	—	MH56	MH74		MH62D9
54	—	MH44	MH56			MH44	MH62		—	—	MH56	MH80		MH68D9
72	—	MH50	MH62			MH50	MH68		—	—	MH62	MH86		—
84	—	MH56	MH68			MH56	MH68		—	—	MH68	MH92		—

**Table 9.41: Box Selection Table: Merchandised NQ Vertically Mounted Main Breaker Panelboards w/ Accessories (by Mains Rating)**

Feature Circuits	Feed-through Lugs				PowerPact H, J, or Q Sub-feed Circuit Breakers (Max Amp and Qty)					
	100 A	225 A	400 A		600 A	100 A	225 A (one)	400 A (two SFB)		600 A (two SFB)
			LA / LH MB	PowerPact L MB				LA / LH MB	PowerPact L MB	
18	—	—	—	—	—	—	—	—	—	—
30	—	—	—	—	—	—	MH62	—	—	—
42	—	MH50	MH62	—	Factory Assembled Only	—	MH62	MH86	MH86D9	Factory Assembled Only
54	—	MH56	MH74	—		—	MH68	MH92	—	
72	—	MH62	MH80	—		—	MH74	<sup>[99]</sup>	—	
84	—	MH68	MH80	—		—	MH80	<sup>[99]</sup>	—	

**Table 9.42: NQ Optional Lugs**

Ampacity	Al Compression Lug Kit		Cu Mechanical Lug Kit		Cu Compression Kit	
	Catalog No.	Lug Wire Range (AWG-kcmil)	Catalog No.	Lug Wire Range (AWG-kcmil)	Catalog No.	Lug Wire Range (AWG-kcmil)
100	NQALV1	one #8-1/0	NQCUM1	one #6-2/0	NQCUV1	one #6-1/0
225	NQALV2	one #4-300	NQCUM2	one #6-250	NQCUV2	one 2/0-300
400	NQALV4	two 2/0-500	NQCUM4	one 1/0-750 or two 1/0-350	NQCUV4	one 400-700
600	NQALV6	two 2/0-500	NQCUM6		NQCUV6	two 250-500

**Table 9.43: Add-on Lugs for Neutral Bars or Ground Bars**

Catalog Number	Lug Wire Range (AWG - kcmil)	Wire Ampere
QO70AN <sup>[100]</sup>	#12 to #2 Al or #14 to #4 Cu	70 A
NQ100AN <sup>[100]</sup>	#14 to #2/0 Al or Cu	80 - 100 A
Q1150AN <sup>[101]</sup>	#1 to #4/0 Al or Cu	110 - 150 A
NQ200AN <sup>[100]</sup>	(2) #4 to 300 kcmil Al or Cu	175 - 200 A

**NOTE:** A maximum of 4 lugs may be added to 18 circuit neutral assemblies. A NQ200AN is required to provide a neutral terminal for every two 175 - 200A QO (VH) circuit breakers.

<sup>[93]</sup> For 225 A panel with SFL, FTL, or SFB.  
<sup>[94]</sup> Not to be used with SFL, FTL, or SFB. These combinations are factory assembled only.  
<sup>[95]</sup> The final character L indicates the kit is used for Low circuit count interiors 30 and 42.  
<sup>[96]</sup> 3-pole HD, HG or HR sub-feed circuit breaker should be selected for single phase 110 - 150 A applications.  
<sup>[97]</sup> The final character H indicates the kit is used for High circuit count interiors 54, 72, and 84.  
<sup>[98]</sup> PowerPact L Circuit Breakers require 8.75" deep enclosures.  
<sup>[99]</sup> Requires box longer than available box offer.  
<sup>[100]</sup> Requires two standard termination spaces on Neutral or Ground bar.  
<sup>[101]</sup> Requires three standard termination spaces on Neutral or Ground bar.

**Table 9.44: NQ Accessories**

Description	Catalog No.
<b>Sub-feed Lug (Bolt-on)</b>	
2-pole QOB Branch Mounted Sub-feed Lug Kit	QOB2125SL
3-pole QOB Branch Mounted Sub-feed Lug Kit	QOB3125SL
<b>Equipment Ground Bars (Lug and terminal sizes shown are AWG)</b>	
Aluminum (#6 to 2/0 Cu or Al lug, #14–#4 Cu or #12–#4 Al terminals)	PK27GTA
PK23GTA+ #1 to #4/0 Al or Cu lug	PK23GTAL
Copper (#14 to #1 Cu lug, #14–#4 Cu terminals)	PK27GTACU
Ground Bar Insulator Kit	PKGTAB
Aluminum (twenty seven terminations #14 to #4 AWG)	PK27GTA
PK23GTA+ #1 to #4/0 AWG Al or Cu lug	PK23GTAL
Copper (twenty seven terminations #14 to #4 AWG)	PK27GTACU
Ground Bar Insulator Kit	PKGTAB
<b>Circuit I.D. Number Strips</b>	
1–102 odd/even (left side numbered 1,3,5 ... 101)	NQ102OE
103–204 odd/even (left side numbered 103,105,107 ... 203)	NQ204OE
1–102 sequential (left side numbered 1,2,3 ... 102)	NQ102S
103–204 sequential (left side numbered 103,104,105 ... 204)	NQ204S
<b>Rail and Deadfront Extensions</b>	
6 in. Extension	NQ6RDE
12 in. Extension	NQ12RDE
18 in. Extension	NQ18RDE
24 in. Extension	NQ24RDE
<b>Handle Attachments—Branch Circuit Breakers</b>	
Handle lock-off	HLO1
Handle tie - (QO and QOB only)	QO1HT
Handle padlock attachment—1-pole	QO1PA
2- and 3-pole	QO1PL
Handle tie and lock-off for three 1-pole (QO, QOB)	QO3HT
Handle tie for two 10–30 A single pole QO(B) circuit breaker	QOHT2
Handle tie for three 10–30 A single pole QO(B) circuit breaker	QOHT3
<b>Handle Padlock Attachment for Padlocking in OFF position</b>	
For padlocking 1P QO circuit breaker in OFF position only, fixed attachment	QO1PAF
For padlocking 2P and 3P QO circuit breaker in OFF position only, fixed attachment	QO2PAF
For padlocking 1P QO-GFI, QO-AFI, QO-CAFI, and QO-EPD circuit breakers in OFF position only, fixed attachment	QOGFI1PAF
For padlocking 2P QO-GFI and QO-EPD circuit breakers in OFF position only, fixed attachment	QOGFI2PAF
<b>Neutral or Ground Lugs (Lug sizes shown are AWG)</b>	
#10 to #2 Al or #14 to #4 Cu	QO70AN
#14 to 2/0 Al or Cu	NQ100AN
#1 to #4/0 Al or Cu	Q1150AN
(2) #4 AWG to 300 kcmil Al or Cu	NQ200AN
<b>Endwalls for MH Enclosures</b>	
Blank (one per package)	MHBE20
With Knockouts (one per package)	MHKE20
NF NQ RECT. Cutout Endwall Kit for 20" Wide NEMA 1 Encl.	MHCO20
Blank 26" wide (one per package)	MHBE26
<b>Replacement Part Kits</b>	
Filler plates (15 per package)	NQFP15
NF & NQ Panelboard Screw	PKDFSCREW
NQ Bonding Strap 100 / 225 AMP	NQBOND12
NQ Bonding Strap 400 / 600 AMP	NQBOND46
NQ 400 A & 600 A Condo Riser Neutral Bonding Kit	NFNQCRBOND46
NQ & NF Tackle Box Spare Parts Kit	TBPANEL
<b>Other Accessories</b>	
Filler plates (15 per package)	NQFP15

**Table 9.45: NQ SurgeLogic SurgeLoc Plug-on SPD [102][103]**

Voltage	Surge Current Rating	Part Number
120 / 240 V	80 kA	SSP01SBA08D
	100 kA	SSP01SBA10D
	120 kA	SSP01SBA12D
	160 kA	SSP01SBA16D
	200 kA	SSP01SBA20D
	240 kA	SSP01SBA24D
208 Y / 120 V	80 kA	SSP02SBA08D
	100 kA	SSP02SBA10D
	120 kA	SSP02SBA12D
	160 kA	SSP02SBA16D
	200 kA	SSP02SBA20D
	240 kA	SSP02SBA24D
240 / 120 Vac High Leg Delta (coming 2H21)	80 kA	SSP03SBA08D
	100 kA	SSP03SBA10D
	120 kA	SSP03SBA12D
	160 kA	SSP03SBA16D
	200 kA	SSP03SBA20D
	240 kA	SSP03SBA24D

**Lug Cover Kits for U.S. Service Entrance**

Panelboards intended for use as service equipment, require a barrier over live field connected load terminals. Please select the appropriate barrier from the table below, based upon the main circuit breaker.

**Table 9.46: US Service Entrance Barriers (required by NFPA 70—National Electrical Code® (NEC®) 2017)**

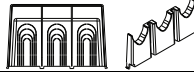
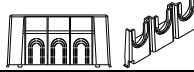
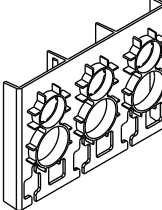
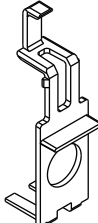
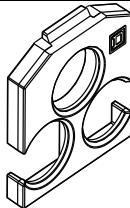
Catalog Number	Contents	Description	Applicable Panelboards
LALLC		LA/LH Line Lug Cover	NQ, NF, I-Line [104]
HJQLLC		H/J/Q Line Lug Cover	NQ, NF
PPLLC		PowerPact L Line Lug Cover	NQ, NF, I-Line [104][105]
EDBS		E Frame Line Lug Cover	NF [106]
PPPLLC		PowerPact P Line Lug Cover	NF

[102] When selecting a panelboard with SurgeLoc SPD, an additional 12 circuit positions (6 adjacent mounting spaces per side) are occupied. For example, if the desired number of circuits is 30, refer to page 9-11 and page to select the NQ442L2/NQ442L2C interior and corresponding Box and Trim.

[103] 96 space interiors are available factory assembled when SurgeLoc SPDs are to be installed in 84 circuit NQ panelboards.

[104] For I-Line applications, only to be used on vertical main circuit breakers. Not to be used on backfeed main circuit breakers.

[105] For I-Line applications, requires the use of the Medium Terminal Shield LTSM3P Installed on circuit breaker, not included in these kits.

[106] Order 1 kit for each 3 pole breaker required (each kit contains three one pole covers).

Factory-installed IP2X barriers for NQ Panelboards reduce the risk of accidental contact with energized components if a cover is removed.

**Features**

- Plastic barriers cover Mains (lugs or circuit breaker), copper bus, and branch circuit breakers
  - IP2X per IEC 60529 on all ungrounded parts
- 240 Vac maximum
- Three phase (Wye and Delta)
  - NEMA 1, 2, 3R, 4/4X, 5, or 12 (up to 225 A)
  - NEMA 1 panelboards up to 400 A
- Branch circuits up to 100 A: 1-, 2-, and 3-pole
- Selectively coordinated up to 30k AIC
- Available with main lugs, or PowerPact Q-, H-, J-frame, and LA/LH main circuit breakers
- Series rated up to 200 kAIC with integral main circuit breaker—fully rated up to 65 kAIC
- Sub feed lugs up to 225 A
- cULus Listed to UL 67 and CSA C22.2, No. 29

New Enhanced IP2X design meets IEC 60529<sup>[107]</sup> with or without a branch circuit breaker installed.

- Unique jaw kit allows QOB branch circuit breakers to plug onto NQ interior with IP2X barriers

**Two factory-assembled constructions (refer to Data Bulletin 1640BR1701 for additional information):**

**Standard IP2X per IEC 60529**  
(Bus Finger Covers Empty Spaces)

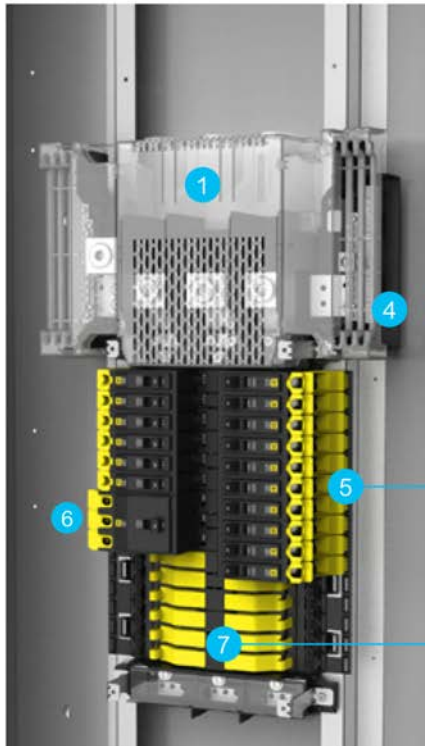

- 1 Main Lug Cover
- 2 Main Breaker Line Side Cover
- 3 Main Breaker Load Side Cover
- 4 Neutral Cover
- 5 Low Amp QO(B) Cover
- 6 High Amp QO(B) Cover
- 7 Bus Finger Cover



**Enhanced IP2X per IEC 6052**  
(Bus Covered Without Branch Circuit Breaker)



[107] International Electrotechnical Commission (IEC)  
a. IEC 60529: 1989+AMD1:1999+AMD2:2013 CSV Consolidated version.- Degrees of Protection Provided by Enclosures (IP Code)

**Specifications**

NQ Fingersafe Bus Ratings, Enclosures, and Circuit Counts								
IP2X Design	Mains rating	Enclosures: NEMA types	Circuit Count					
			18	30	42	54	72	84
Standard	100	1, 2, 3R	X	X	—	—	—	—
	225	4/4X, 5, 12	—	X	X	X	X	X
	400	1	—	X	X	—	X	X
Enhanced	225	1, 2, 3R, 4/4X, 5, 12	—	—	X	—	—	—
	400	1	—	—	X	—	—	—

QO(B) Branch Circuit Breaker Ratings <sup>[108]</sup>				
Branch Circuit Breaker	Amperes	1-Pole	2-Pole	3-Pole
QO / QOB	10–60	L	L	L
	70	L	L	H
	80–100	—	H	H
QO-H / QOB-H	15–30	—	L	—
	40–100	—	H	—
QO-HID / QOB-HID	15–30	L	L	L
	40–50	L	L	—
QO-HM / QOB-HM	15–20	L	—	—
	15–30	—	L	L
QO-VH / QOB-VH	15–70	L	—	—
	40–100	—	H	H
	40–100	—	H	—
QOH <sup>[109]</sup>	40–100	—	H	—
QHB <sup>[109]</sup>	15–30	L	L	—
<b>IP2X QO(B) Lug Covers:</b>	L (Low Amp) - QOFSLALB H (High Amp) - QOFSHALB			

**Replacement Parts**

Replacement Parts		
Catalog Number	Quantity Per Package	Description
QOFSBF12	12	NQ IP2X Bus Finger Filler <sup>[110]</sup>
QOFSLALB12	12	NQ IP2X QO(B) Lug Cover Low Amp
QOFSHALB12	12	NQ IP2X QO(B) Lug Cover High Amp
HJQLLC	1	HJQ Main Breaker IP2X Line Lug Cover
LALLC	1	LA/LH Main Breaker IP2X Line Lug Cover
NQHJLSC	1	HJ Main Breaker IP2X Load Side Cover
NQQLSC	1	Q Main Breaker IP2X Load Side Cover
NQLALHLSC	1	LA/LH Main Breaker IP2X Load Side Cover
NQMLLSC	1	Main Lugs IP2X Cover
NQNCC	1	NQ IP2X Neutral Cover
QO1PJ15	15	QOB Jaw Kit <sup>[111]</sup>

[108] QOB circuit breakers and jaw kits required for Enhanced IP2X design.

[109] Available only in standard IP2X design

[110] Used only with Standard IP2X design.

[111] Used only with Enhanced IP2X design.



**Selection Procedure for NF Merchandised Panelboards**

1. Review maximum electrical system voltage, ampacity, and available fault current, and determine the type of panelboard is desired (see [NF and I-Line™ Panelboards, page 9-5](#)).
2. Identify total quantity of branch circuit breaker poles and panel spaces required (see Digest sections 7 and 9 for catalog numbers).
3. Select proper main lug interior from [NF Main Lug Interiors, page 9-29](#) or:
  - Select main circuit breaker interior and main circuit breaker adapter kit from [NF Main Circuit Breaker Interiors - 600Y/347 Vac Max. , page 9-30](#) based upon the equivalent number of poles and ampere rating.  
**NOTE:** Interiors include solid neutral and are field convertible to top-feed.
  - If a main circuit breaker interior was selected, select a main circuit breaker (or fuse) from PowerPact H-, J-, L-, or LA/LH frame circuit breakers pages in Section 7 or E-frame circuit breakers pages in Section 9 of the Digest.
4. Select ground bars from tables [Table 9.82](#) and any non-standard neutral bars (i.e., 200% neutral for non-linear loads) from [Table 9.77](#).
  - Please note that an aluminum ground bar kit is included with NF Panelboard Interiors.
5. Select any required sub-feed circuit breakers, sub-feed lugs (SFL), or feed-through lugs (FTL) kits:
  - Sub-feed lugs (SFL) or feed-through lugs (FTL) kits: [Table 9.78](#) in the NF Accessories sections.
  - Any subfeed circuit breakers: –[Table 9.63](#).
6. Determine the total enclosure height required by adding requirements from interior, main circuit breaker, neutrals, SFL, FTL, or sub-feed circuit breaker.
7. Select enclosure from the tables [Table 9.76](#), [Table 9.79](#), and [Table 9.80](#).  
NEMA Type 1—select box and front (cover) catalog number corresponding to interior catalog number.  
NEMA Type 3R, 5, 12—select enclosure. Cover for Type 3R, 5, 12 is included with the enclosure.
8. Select the branch circuit breakers to be installed in the panel.  
For NF panelboards, use E-frame circuit breakers from .
9. Select options and accessories from tables [Table 9.77–Table 9.82](#).  
**NOTE:** Additional NF and NQ options may be found in the [Supplemental Digest, Section 4](#).

**NF Merchandised Selection Example**

**480Y/277 Vac, 3Ø4W, 25 kA SCCR, fully rated, copper bus, 100 A, main circuit breaker, Type 1, flush-mount, bolt-on, branch circuit breakers**

Branches	Table No.	Catalog Number	Spaces
(13) 20/1		EGB14020	13
one 40/2		EGB24040	2
one 50/3		EGB34050	3

Total 18 spaces

			Min. Box Height
125 A MLO Cu Bus Interior	<a href="#">page 9-29</a>	NF418L1C	—
With Main Circuit Breaker Adapter Kit	<a href="#">page 9-30</a>	N150MH	38 inches
Main Circuit Breaker	Section 7	HGL36100	—

Enclosure (Box)	<a href="#">page 9-30</a>	MH38	—
Front (Cover)	<a href="#">page 9-30</a>	NC38F	—

Total 38 inches

**NF Main Lug Interiors - 600Y/347 Vac Max**

**Table 9.47: NF Main Lug Interiors - Use I-Line Panelboard for 3Ø3W Delta applications above 240 Vac**

Circuit Breaker Pole Spaces [1] [2]	Mains Rating (Amps)	Interior Only Catalog Number (Order Branch Circuit Breakers Separately)[1][3]	NEMA 1 Enclosure			Water, Dirt, and Dust Resistant Enclosure Catalog Numbers[4]		
			Box 20 in. W x 5.75 in. D [5]	Mono-Flat Trim™ Front [6]	Hinged Front[5]	Type 3R/5/12 20 in. W x 5.75 in. D [7]	Type 3R 26 in. W x 8.75 in. D [8]	Height (In.)
(Single Phase 3-Wire: Factory Assembled Only) Three Phase 4-Wire [9]								
18	125	NF418L1	MH26	NC26( )	NC26( )HR	MH26WP	–	26
		NF418L1C						
30		NF430L1	MH32	NC32( )	NC32( )HR	MH32WP	–	32
		NF430L1C						
42	250	NF442L1C	MH38	NC38( )	NC38( )HR	MH38WP	–	38
54		NF454L1C	MH44	NC44( )	NC44( )HR	MH44WP	–	44
		NF430L2	MH38	NC38( )	NC38( )HR	MH38WP	–	38
		NF430L2C						
42	400	NF442L2	MH44	NC44( )	NC44( )HR	MH44WP	–	44
		NF442L2C						
54		NF454L2	MH50	NC50( )	NC50( )HR	MH50WP	–	50
		NF454L2C						
66	600	NF466L2	MH62	NC62( )	NC62( )HR	MH62WP	–	62
		NF466L2C						
30		NF430L4	MH50	NC50( )	NC50( )HR	MH50WP	–	50
		NF430L4C						
42	800	NF442L4	MH56	NC56( )	NC56( )HR	MH56WP	–	56
		NF442L4C						
54		NF454L4C	MH62	NC62( )	NC62( )HR	MH62WP	MH74D9VWP	62/74
		NF454L4C						
66	Factory Assembled Only[11]	NF466L4	MH74	NC74( )	NC74( )HR	MH74WP	MH86D9VWP	74/86
		NF466L4C						
84		NF484L4	MH86	NC86( )	NC86( )HR	MH86WP	–	86
		NF484L4C						
30		NF430L6C	MH50	NC50V( )	NC50V( )HR	MH62WP[10]	MH62D9VWP	50/62
42		NF442L6C	MH56	NC56V( )	NC56V( )HR	MH68WP[10]	MH68D9VWP	56/68
54		NF454L6C	MH62	NC62V( )	NC62V( )HR	MH74WP[10]	MH74D9VWP	62/74
66		NF466L6C	MH74	NC74V( )	NC74V( )HR	MH86WP[10]	MH86D9VWP	74/86
84		NF484L6C	MH86	NC86V( )	NC86V( )HR	–	–	86

**Note:** All NF Merchandised Panelboard interiors include the following: a NFFP15 bag of blank filler plates; a neutral bonding strap; an NF information manual; a NEMA instruction booklet; and a sheet of circuit numbers.

PANELBOARDS 9

[1] Order EDB, EGB, or EJB branch circuit breakers separately. Maximum allowable branch circuit breaker pair combination is 170 A.  
 [2] Please note that some local building codes limit panelboards to 42 circuits, including those that reference 2005 or earlier version of the US NEC.  
 [3] "C" suffix indicates copper bussing.  
 [4] Wall mounting brackets add 0.4 inches to back of MHxxWP enclosures.  
 [5] Nominal interior dimensions, see PBA600 for details.  
 [6] Add "F" for flush mount, "S" for surface mount.  
 [7] Enclosure includes trim kit. NEMA 3R, 5, 12 enclosures must be bottom fed. Nominal enclosure dimensions, see PBA555 for details.  
 [8] Vented Type 3R enclosure with three point latch door required for outdoor applications with two sub-feed breakers, or sub-feed breaker with trip current >150A. NEMA 3R enclosures must be bottom fed, when selected a NF12RDE kit should also be selected. Enclosure nominal dimensions, see PBA603WP for details.  
 [9] NF panelboards without neutral connections may be applied to 3 phase, 4 wire grounded Wye systems, except at the Service Entrance.  
 [10] NEMA 3R, 5, 12 enclosures must be bottom fed, when selected a NF12RDE kit should also be selected.  
 [11] 800 A interiors with main circuit breaker require 8.75 inch deep, 26 inch wide enclosures.

NF Main Circuit Breaker Interiors - 600Y/347 Vac Max.

Table 9.48: NF Main Circuit Breaker Interiors - Use I-Line Panelboard for 3Ø3W Delta applications above 240 Vac

Circuit Breaker Pole Spaces <sup>[12]</sup>	Mains Rating (Amps)	Main Circuit Breaker Adapter Kits (Less Circuit Breaker)			Interior Only Catalog Number (Order Branch Circuit Breakers Separately) <sup>[12][13]</sup>	NEMA 1 Enclosure			Water, Dirt, and Dust Resistant Enclosure Catalog Numbers <sup>[14]</sup>							
		Main Breaker Kit	ULSE Barrier Kit <sup>[15]</sup>	Main Circuit Breaker Frame Size <sup>[16]</sup>		Box 20 in. W x 5.75 in. D <sup>[17]</sup> or 8.75 in. D <sup>[18]</sup>	Mono-Flat™ Front <sup>[19]</sup>	Hinged Front <sup>[19]</sup>	Type 3R/5/12 20 in. W x 5.75 in. D <sup>[20]</sup>	Type 3R 26 in. W x 8.75 in. D <sup>[21]</sup>	Height (In.)					
<b>(Single Phase 3-Wire: Factory Assembled Only) Three Phase 4-Wire<sup>[22]</sup></b>																
15 <sup>[23]</sup>	125	Back-fed Main Breaker <sup>[24]</sup>	EDBS	EDB, EGB or EJB	NF418L1	MH26	NC26( )	NC26( )HR	MH26WP	—	26					
27 <sup>[23]</sup>					NF418L1C											
					NF430L1											
18	125	N150MH <sup>[16]</sup>	HD/HG/HJ/HL/HR	HD/HG/HJ/HL/HR	NF430L1C	MH38	NC38( )	NC38( )HR	MH38WP	—	38					
30					NF430L1											
42					NF430L1C											
54 <sup>[25]</sup>					NF442L1C											
					NF442L1C											
					NF442L1C											
30	250	N250MJ <sup>[16]</sup>	HJQLL	JD/JG/JJ/JL/JR	NF430L2	MH50	NC50( )	NC50( )HR	MH50WP	—	50					
42					NF430L2C											
54					NF442L2											
					NF442L2C											
					NF454L2											
					NF454L2C											
30	400	N400M <sup>[16]</sup>	LALLC	LA/LH <sup>[26]</sup>	NF466L2	MH74	NC74( )	NC74( )HR	MH74WP	—	74					
42					NF466L2C											
54					NF430L4											
					NF430L4C											
					NF442L4											
					NF442L4C											
30	400 / 600	N600MPPL <sup>[16]</sup>	PPLLC	LG/LJ/LL/LR	NF454L4	MH86	NC86V( )	NC86V( )HR	MH86WP	MH86D9VWP	68 / 74					
42					NF454L4C											
54					NF466L4											
					NF466L4C											
					NF688D9 <sup>[27]</sup>							NC68V( )3PNF <sup>[28]</sup>	NC68V( )3PNFHR <sup>[28]</sup>	—	Factory Assembled Only	74 / 80
					NF442L6C							NF74D9 <sup>[27]</sup>	NC74V( )3PNF <sup>[28]</sup>	NC74V( )3PNFHR <sup>[28]</sup>		
	NF454L6C	NF80D9 <sup>[27]</sup>	NC80V( )3PNF <sup>[28]</sup>	NC80V( )3PNFHR <sup>[28]</sup>	—	80 / 86										
800	Factory Assembled Only <sup>[29]</sup>															

PANELBOARDS

[12] Order EDB, EGB, or EJB branch circuit breakers separately. Maximum allowable branch circuit breaker pair combination is 170 A.  
 [13] "C" suffix indicates copper bussing.  
 [14] Wall mounting brackets add 0.4 inches to back of MHxWP enclosures.  
 [15] Please select the appropriate Main Circuit Breaker Barrier for UL Service Entrance applications (see [US Service Entrance Barriers \(required by NFPA 70—National Electrical Code® \(NEC®\) 2017, page 9-25\)](#)).  
 [16] Select the appropriate PowerPact main circuit breaker from Section 7.  
 [17] Nominal interior dimensions, see PBA600 for details.  
 [18] D9 suffix indicates the 8.75 in. Deep Enclosure required for panelboards with PowerPact L main circuit breaker or sub-feed circuit breaker. See PBA604 for dimensional details.  
 [19] Add "F" for flush mount, "S" for surface mount.  
 [20] Enclosure includes trim kit. NEMA 3R, 5, 12 enclosures must be bottom fed. Nominal interior dimensions, see PBA555 for details.  
 [21] Vented Type 3R enclosure with three point door. Must be bottom fed. Required for outdoor applications with PowerPact L main circuit breaker, two sub-feed circuit breakers, or sub-feed circuit breaker with trip current >150A. Interior nominal dimensions, see PBA603WP for details.  
 [22] NF panelboards without neutral connections may be applied to 3 phase, 4 wire grounded Wye systems, except at the Service Entrance.  
 [23] Pole spaces shown are available for branch circuits, with spaces deducted for the back fed main circuit breaker.  
 [24] Back-fed EDB 125 A 3 pole main circuit breaker must be ordered separately and field installed. Maximum breaker rating opposite is 20 A.  
 [25] Please note that some local building codes limit panelboards to 42 circuits, including those that reference 2005 or earlier version of NFPA 70.  
 [26] Available for 125 A–400 A applications. Please order short handle circuit breaker (i.e., LAL36400MB).  
 [27] D9 suffix indicates the 8.75 in. Deep Enclosure required for panelboards with PowerPact L main circuit breaker or sub-feed circuit breaker. See PBA604 for dimensional details.  
 [28] Three point latch trim front; required for enclosures on panelboards with PowerPact L Main Circuit Breaker, Switch, or Sub-Feed Circuit Breaker  
 [29] 800 A interiors with main circuit breaker require 8.75 inch deep, 26 inch wide enclosures.

**E-frame Circuit Breakers for NF Merchandised Panelboards**

**Table 9.49: E-frame Thermal-magnetic (480Y/277 Vac Max) [30][31]**



Ampere Rating	ED, EG, EJ (480Y/277 Vac)		"D" Interrupting Level 18 kA @ 480Y/277 Vac	"G" Interrupting Level 35 kA @ 480Y/277 Vac	"J" Interrupting Level 65 kA @ 480Y/277 Vac	Terminal Wire Range (AWG)
	Hold	Trip	Catalog Number	Catalog Number	Catalog Number	
<b>1-pole, 277 Vac</b>						
15 A	270	875	EDB14015[32][33]	EGB14015[32][33]	EJB14015[32][33]	AL30FD #14–#6 Al or Cu
20 A			EDB14020[32][33]	EGB14020[32][33]	EJB14020[32][33]	
25 A			EDB14025[33]	EGB14025[33]	EJB14025[33]	
30 A	630	1800	EDB14030[33]	EGB14030[33]	EJB14030[33]	AL100FD #14–2/0 Al or Cu
35 A			EDB14035[33]	EGB14035[33]	EJB14035[33]	
40 A			EDB14040[33]	EGB14040[33]	EJB14040[33]	
45 A			EDB14045[33]	EGB14045[33]	EJB14045[33]	
50 A			EDB14050[33]	EGB14050[33]	EJB14050[33]	
60 A			EDB14060	EGB14060	EJB14060	
70 A			EDB14070	EGB14070	EJB14070	
<b>2-pole, 480Y/277 Vac [34]</b>						
15 A	270	875	EDB24015[33]	EGB24015[33]	EJB24015[33]	AL30FD #14–#6 Al or Cu
20 A			EDB24020[33]	EGB24020[33]	EJB24020[33]	
25 A			EDB24025[33]	EGB24025[33]	EJB24025[33]	
30 A	630	1800	EDB24030[33]	EGB24030[33]	EJB24030[33]	AL100FD #14–2/0 Al or Cu
35 A			EDB24035[33]	EGB24035[33]	EJB24035[33]	
40 A			EDB24040[33]	EGB24040[33]	EJB24040[33]	
45 A			EDB24045[33]	EGB24045[33]	EJB24045[33]	
50 A			EDB24050[33]	EGB24050[33]	EJB24050[33]	
60 A			EDB24060	EGB24060	EJB24060	
70 A			EDB24070	EGB24070	EJB24070	
80 A	1000	2300	EDB24080	EGB24080	EJB24080	AL100FD #14–2/0 Al or Cu
90 A			EDB24090	EGB24090	EJB24090	
100 A			EDB24100	EGB24100	EJB24100	
110 A			EDB24110	EGB24110	EJB24110	
125 A			EDB24125	EGB24125	EJB24125	
<b>3-pole, 480Y/277 Vac</b>						
15 A	270	875	EDB34015[33]	EGB34015[33]	EJB34015[33]	AL30FD #14–#6 Al or Cu
20 A			EDB34020[33]	EGB34020[33]	EJB34020[33]	
25 A			EDB34025[33]	EGB34025[33]	EJB34025[33]	
30 A	630	1800	EDB34030[33]	EGB34030[33]	EJB34030[33]	AL100FD #14–2/0 Al or Cu
35 A			EDB34035[33]	EGB34035[33]	EJB34035[33]	
40 A			EDB34040[33]	EGB34040[33]	EJB34040[33]	
45 A			EDB34045[33]	EGB34045[33]	EJB34045[33]	
50 A			EDB34050[33]	EGB34050[33]	EJB34050[33]	
60 A			EDB34060	EGB34060	EJB34060	
70 A			EDB34070	EGB34070	EJB34070	
80 A	1000	2300	EDB34080	EGB34080	EJB34080	AL100FD #14–2/0 Al or Cu
90 A			EDB34090	EGB34090	EJB34090	
100 A			EDB34100	EGB34100	EJB34100	
110 A			EDB34110	EGB34110	EJB34110	
125 A			EDB34125	EGB34125	EJB34125	
<b>EPDs (Equipment Protection Devices), 1-pole, 277 Vac, Thermal-magnetic with 30 mA ground-fault protection[35]</b>						
15 A	270	875	EDB14015EPD[32][33]	EGB14015EPD[32][33]	EJB14015EPD[32][33]	#14–#6 Cu or #12–#4 Al
20 A			EDB14020EPD[32][33]	EGB14020EPD[32][33]	EJB14020EPD[32][33]	
30 A			EDB14030EPD[33]	EGB14030EPD[33]	EJB14030EPD[33]	
40 A	630	1800	EDB14040EPD[33]	EGB14040EPD[33]	EJB14040EPD[33]	
50 A			EDB14050EPD[33]	EGB14050EPD[33]	EJB14050EPD[33]	

**NOTE:** All EDB, EGB, and EJB circuit breakers are UL Listed as HACR Type. For 50°C calibration, use a CA suffix. NF branch circuit breakers are fungus proof as standard.

[30] Maximum allowable branch breaker pair combination = 170 A.

[31] 100 A Maximum at 600Y/347 Vac

[32] UL Listed as SWD (Switching duty rated).

[33] UL Listed as HID (High Intensity Discharge rated).

[34] UL Listed for use on 240 V Corner-grounded Delta Systems (Grounded B Phase). See data bulletin 2700DB0202.

[35] All EPDs occupy two spaces, with or without Alarm Switch option. For alarm switch, add the suffix BA. EPD circuit breakers may not be used in systems with phase to ground voltages other than 277 Vac.

**Table 9.50: Factory installed Electrical Accessories**

Auxiliary Switch (1A/1B)	Alarm Switch (NO)	Coil Burden Max. (VA)	Minimum Recommended Supply Transformer (VA)
Monitors circuit breaker contact status and provides a remote signal indicating the circuit breaker contacts are OPEN or CLOSED. <b>Application</b> Max Load = 10 A @ 120 Vac 50/60 Hz Terminals for #14 AWG Cu wire	Used with control circuits and is actuated only when the circuit breaker has tripped. <b>Application</b> Max Load = 7 A @ 120 Vac 50/60 Hz Terminals for #14 AWG Cu wire.	288	50
		Shunt Trip—Trips the circuit breaker from a remote location by means of a coil energized from a separate circuit. A 120 V shunt trip will operate at 55% or more of rated voltage. <b>Application</b> For use with momentary or maintained push button. 120 Vac 50/60 Hz Terminals for #14 AWG Cu wire.	

**Table 9.51: Factory Installed Electrical Accessory Packages for ED, EG, EJ Circuit Breakers**

Accessory Package	Suffix
Auxiliary Switch and Alarm Switch <sup>[36]</sup> / <sup>[37]</sup>	AABA
Shunt Trip Package <sup>[36]</sup> / <sup>[37]</sup>	SA
Auxiliary Switch/Alarm Switch/Shunt Trip Package <sup>[36]</sup> / <sup>[37]</sup>	AABASA
Alarm Switch (N.O.) Package for EPDs only	BA

**Table 9.52: Terminal Nut Insert Kit**

Circuit Breaker Type	Qty. per Kit	Catalog No.
ED, EG, EJ	3	TIKFD

**Table 9.53: Handle Accessories**

Circuit Breaker Type	No. of Poles	Catalog No.
E-frame Fixed Padlock Attachment, Lock ON/OFF		
ED, EG, EJ	1, 2, or 3	EDPA
E-frame Fixed padlock attachment, Lock OFF only		
ED, EG, EJ	1, 2, or 3	EDPAF
E-frame Removable padlock attachment, Lock OFF only		
ED, EG, EJ	1, 2, or 3	HPAFD
E-frame Handle Ties		
ED, EG, EJ	Ties 2 – 1P	ECB2HT
	Ties 3 – 1P	ECB3HT

**Table 9.54: Interrupt Ratings (kA)**

	EDB	EGB	EJB
120 V	25	65	100
240 V	18 (1P), 25	35 (1P), 65	65 (1P), 100
480Y/277 V	18	35	65
600Y/347 V <sup>[38]</sup>	14	18	25

**Table 9.55: Mechanical Lug Kit Information (Al lugs for use with Al or Cu wire)<sup>[37]</sup>**

Standard	Circuit Breaker Application			Number of Wires Per Lug and Wire Range	Catalog Number	Lugs Per Kit
	Ampere Rating	Optional	Ampere Rating			
EDB, EGB, EJB	15–30 A	—	—	one #12—#6 AWG Al or one #14—#6 AWG Cu	AL30FD	3
	35–125 A	EDB, EGB, EJB	15–30 A <sup>[39]</sup>	one #12—2/0 AWG Al or one #14—2/0 AWG Cu	AL100FD	3
—	—	EDB, EGB, EJB	15–125 A	one #14—1/0 AWG Cu	CU100FD	3

<sup>[36]</sup> Accessory package takes an additional pole space.

<sup>[37]</sup> Not available for EPD.

<sup>[38]</sup> Requires use of ExBx6xxx circuit breakers, i.e. EDB16015 for a 1P, 15A circuit.

<sup>[39]</sup> Factory installed only. Use suffix "LH"

**Factory Assembled Main Circuit Breakers (600Y/347 Vac maximum)**

**Table 9.56: NF Panelboard Factory Assembled Interiors—600Y/347 Vac Max**

Single Phase 3-Wire (1P/3W), or Three Phase 4-Wire (3P/4W) <sup>[40]</sup>							
Mains Rating (Amps)				Max. Number of One-Pole Circuit Breakers	Bus Material	Min. Box Depth (inches)	
Main Lugs Only	Circuit Breaker Frame	Main Breaker <sup>[41]</sup>	Main Switch <sup>[41]</sup>			Main Lugs Only	Main Breaker / Switch
125 Max	ED, EG, EJ <sup>[42]</sup>	15–125	—	18, 30	Al, Cu	5.75 in.	5.75 in.
125 Max	HD/HG/HJ/HL/HR	15–125	110–125	18, 30, 42, 54 <sup>[43]</sup>	Al, Cu	5.75 in.	5.75 in.
250 Max	JD/JG/JJ/JL/JR	150–250	150–250	30, 42, 54, 66	Al, Cu	5.75 in.	5.75 in.
400 Max	LG/LJ/LL/LR & LA/LH	125–400	300–400	30, 42, 54, 66 <sup>[44]</sup> , 84	Al, Cu	5.75 in.	8.75 in. or 5.75 in. <sup>[45]</sup>
600 Max	LG/LJ/LL/LR	400–600	450–600	30, 42, 54, 66 <sup>[44]</sup> , 84	Cu	5.75 in.	8.75 in. <sup>[45]</sup>
800 Max	MG	600–800	—	30, 42, 54	Cu	8.75 in. <sup>[46]</sup>	8.75 in. <sup>[47]</sup>
	PG, PJ, PL	600–800	600–800				

**NOTE:** Factory Assembled Main Circuit Breakers (600Y/347 Vac maximum). 600Y/347 Vac applications require use of ExBx6xxx branch circuit breakers, i.e. EDB16015 for a 1P, 15A circuit.<sup>[48]</sup>

400 A and 600 A panelboards, 1Ø or 3Ø

PowerPact L-frame - see Tables in Section 7.

**Table 9.57: Main Circuit Breaker**

No. of Poles	Trip Unit Options	Frame Sizes	Ampacity
3	LI, LSI, Switch	LG, LJ, LL, LR	125–600 A

LA/LH, PowerPact H and J-frame circuit breakers are also available—see Tables in Section 7 and Supplemental Digest Section 3.

**Table 9.58: PowerPact L Main Circuit Breaker Cabinet Height (inches)**

Max. No. of Branch Spaces (Does not include sub-feed circuit breaker spaces)	NEMA 1 Enclosure (20 in. W x 8.75 in. D) <sup>[49]</sup>	Vented NEMA 3R Enclosure (26 in. W x 8.75 in. D) <sup>[50]</sup>	
	400 / 600 A Interior	400 A	600 A
30	68	68	74
42	74	74	80
54	80	80	86

**Table 9.59: Sub-feed Circuit Breakers for NF Panelboards<sup>[51]</sup>**

Interior Mains Rating	Mains Type	Sub-Feed Circuit Breaker(s)			Space Factor <sup>[52]</sup>
		Ampacity	Poles	MCCB Frame	
250 - 800 A	Main Lugs	110 - 150	2, 3	HD, HG, HJ, HL, HR <sup>[53]</sup> , <sup>[54]</sup>	18 inches
		150 - 250	2, 3	JD, JG, JJ, JL, JR <sup>[54]</sup> , <sup>[55]</sup>	
250 - 400 A	PowerPact J or LA/ LH Main Circuit Breaker	110 - 150	2, 3	HD, HG, HJ, HL, HR <sup>[53]</sup> , <sup>[54]</sup>	
		150 - 250	2, 3	JD, JG, JJ, JL, JR <sup>[54]</sup> , <sup>[55]</sup>	
		125 - 400	2, 3	LA or LH <sup>[56]</sup>	
		3	LG, LJ, LL, LR <sup>[57]</sup>		
400 - 600 A <sup>[57]</sup> , <sup>[58]</sup>	PowerPact L Main Circuit Breaker <sup>[59]</sup>	110 - 150	2, 3	HD, HG, HJ, HL, HR <sup>[53]</sup> , <sup>[54]</sup>	18 inches
		150 - 250	2, 3	JD, JG, JJ, JL, JR <sup>[54]</sup> , <sup>[55]</sup>	12 inches
		125 - 400	2, 3	LA / LH <sup>[56]</sup>	18 inches
		125 - 400	3	LG, LJ, LL, LR <sup>[57]</sup>	12 inches
800 A <sup>[60]</sup>	Main Circuit Breaker	110 - 150	2, 3	HD, HG, HJ, HL, HR <sup>[53]</sup> , <sup>[54]</sup>	12 inches
		150 - 250	2, 3	JD, JG, JJ, JL, JR <sup>[54]</sup> , <sup>[55]</sup>	18 inches
		125 - 400	2, 3	LA / LH	12 inches
		125 - 600	2	LG, LJ, LL, LR	18 inches
400 - 800 A <sup>[56]</sup>	Main Circuit Breaker <sup>[59]</sup>	110 - 400	2, 3	One LA / LH with one H-, or J- frame	36 inches

[40] NF panelboards without neutral connections may be applied in 3-phase, 4-wire grounded Wye systems, except at the Service Entrance.  
 [41] Factory Assembled Interiors are rated for trip current of Main Breaker / Switch.  
 [42] Back-Fed Main Breaker applications only.  
 [43] Three Phase Copper only.  
 [44] NF Panelboards with PowerPact L Main Circuit Breaker or Switch are limited to a maximum of 54 branch circuits.  
 [45] NF Panelboards with PowerPact L Main Circuit Breaker or Switch require 8.75" deep enclosures and three point latch trim fronts.  
 [46] Enclosures limited to NEMA Type 1 only.  
 [47] 8.75" Enclosures limited to 26" Wide NEMA Type 1.  
 [48] Requires use of ExBx6xxx branch circuit breakers, i.e. EDB16015 for a 1P, 15A circuit.  
 [49] D9 8.75" deep enclosure and three point latch door is required for PowerPact L Main Circuit Breaker, Switch, or Sub-Feed Circuit Breaker. See Table 9.48 NF Main Circuit Breaker Interiors - Use I-Line Panelboard for 3Ø3W Delta applications above 240 Vac, page 9-30.  
 [50] PowerPact L not available in non-vented (NEMA Type 3R/5/12, or 4/4X) enclosures.  
 [51] See Digest Section 7 for Interrupting Ratings and Catalog Numbers of PowerPact H-, J-, L-, and LA/LH frame MCCBs. NEMA 3R applications with sub-feed breakers greater than 150 A require 8.75" deep, 26" wide enclosure - reference PBA603WP for dimensions.  
 [52] Space Factor is the length required for sub-feed circuit breaker. Please reference Product Selector output for panelboard enclosure dimensions.  
 [53] Three pole HD, HG, HR MCCBs are installed for single phase sub-feed circuit breaker applications.  
 [54] One or two sub-feed circuit breakers may be selected.  
 [55] Three pole JR MCCBs are installed for single phase sub-feed circuit breaker applications.  
 [56] NF Panelboards with LA / LH sub-feed circuit breakers are shipped fully assembled.  
 [57] NF Panelboards with PowerPact L circuit breakers require 8.75" a deep enclosure with 3-point latch trim front. Reference PBA559x drawings for dimensions, where x may be blank, HR, HRT, or T.  
 [58] Add 6" to space factor for NF Panelboards with 600 A PowerPact L circuit breakers in NEMA 3R enclosures. Reference PBA754 drawing for dimensions. Maximum sub-feed breaker is 400A when installed with a 600 A rated main circuit breaker in a NEMA 3R enclosure.  
 [59] NF Panelboards with PowerPact L main circuit breaker and any sub-feed circuit breaker(s) are shipped completely assembled in 26" wide, 8.75" deep enclosures, with gutter mounted neutral assemblies.  
 [60] NF Panelboards with 800 A rated main circuit breaker are shipped completely assembled in 26" wide, 8.75" NEMA 1 enclosures. Reference PBA756 or PBA756HR drawing for dimensions.

**Common Features**

**Table 9.60: Sub-feed (Double) Lugs (Standard Copper Mechanical Lugs)**

Mains Rating	Sub-feed Lug Wire Range
125 A	(2) #6–2/0 AWG Al or Cu
250 A	two 1/0 AWG–350 kcmil or one 1/0 AWG–750 kcmil Al or Cu
400 A	(2) 1/0 AWG–750 kcmil Cu
600 A	(4) 4/0 AWG–500 kcmil Al or Cu
800 A	(6) 3/0 AWG–500 kcmil Al or Cu

Sub-feed (Double) Lugs (Standard Aluminum Mechanical Lugs): An additional mains and termination point that can be used to feed out to another panelboard or device from the incoming service lines. Available on main lug interiors only.

**Table 9.61: Sub-feed Lug Cabinet Data (Standard Aluminum Mechanical Lugs)**

Max. No. of Branch Spaces	Main Lugs Enclosure Height in Inches				
	125 A	250 A	400 A	600 A	800 A [61]
18	26	—	—	—	—
30	32	38	50	74	80
42	—	44	56	80	86
54	—	50	62	86	92

**Table 9.62: Feed-through Lugs (Standard Aluminum Mechanical Lugs)**

Mains Rating	Feed-through Wire Range Wire
125 A	one #6 AWG–2/0 kcmil Al or Cu
250 A	one #6 AWG–350 kcmil Al or Cu
400 A	one 1/0 AWG–750 kcmil or two 1/0 AWG–350 kcmil Al or Cu
600 A	two 1/0 AWG–750 kcmil Al or Cu

Feed-through Lugs (Standard Aluminum Mechanical Lugs): A second set of lugs assembled at the opposite end from the mains of the panelboard. Often used to connect another panelboard or device to the incoming lines. Available on main lugs and main circuit breaker panelboards.

**Table 9.63: Feed-through Lugs Cabinet Data (Standard Aluminum Mechanical Lugs)**

Max. No. of Branch Spaces	Enclosure Height in Inches									
	125 A	100/125 A		250 A		400 A LA/LH		600 A		800 A
	Main Breaker (back-fed only)	Main Lugs	Main Breaker	Main Lugs	Main Breaker	Main Lugs	Main Breaker	Main Lugs	Main Breaker [62]	Main Lugs [61]
18	38	32	44	—	—	—	—	—	—	—
30	44	38	50	50	62	56	68	56	74	56
42	—	—	—	56	68	62	74	62	80	62
54	—	—	—	62	74	68	80	68	86	68

**Table 9.64: NF Equipment Ground Bar Kits [63]**

Interior Rating	Circuit Count	Aluminum	Copper	Ground Bar Insulator Kit
125 A / 250 A	18	PK12GTA	PK27GTACU	PKGTAB
	30	PK18GTA		
	42, 54	PK23GTA		
250 A	66 and Split Bus	PK27GTA		
400 A / 600 A	All	PK27GTA		

**Table 9.65: Name Plates**

Name Plates
Standard white face/black letter laminated bakelite, 1 in. x 3.5 in., adhesive-backed or screw mountable with screws in a bag assembly

**Table 9.66: NF Panelboard Neutral Assembly Options (Standard Width Enclosures)**

Interior Mains Rating	Mains Type			Load End Options		100% Neutrals		200% Neutrals		Factory Assembled Only
	MLO	MB	SFL	FTL	SFB	Aluminum	Copper	Aluminum	Copper	
125 A	Y	Y	Y	Y	N/A	Standard	NFN1CU	NFNL1	Factory Assembled Only	
250 A	Y	Y	-	-	-		NFN2CU	NFNL2		
400 A	Y	Y	-	-	-		NFN6CU	NFNL4		
600 A	Y	-	-	-	-	Factory Assembled Only		Factory Assembled Only		
800 A	Y	Y	-	-	-	Factory Assembled Only	Factory Assembled Only	Factory Assembled Only		

[61] 800 A main lug panelboards require an 8.75 in. deep and 26 in. wide box.

[62] 600 A main circuit breaker panelboards require an 8.75 in. deep, 26 in. wide box.

[63] One (1) PK kit supplied when ground bar is specified. Two (2) PK kits supplied when "extra" ground bar is ordered.

**Table 9.67: NF Main Neutral Conductors—(Quantity) and Wire Size<sup>[64]</sup>**

Interior Rating	Mechanical Neutral Line Lugs		Compression Neutral Line Lugs
	Standard Lug Wire Range	Oversized Lug Wire Range	Standard Lug Wire Range
125 A	(1) #6-2/0 AWG Cu or Al	Select 250 A neutral assembly	(1) #6-2/0 AWG Cu or (1) #4-300 kcmil Al
250 A	(1) #6 AWG-250 kcmil Cu or (1) #6 AWG - 350 kcmil	Select 400 A neutral assembly	(1) 2/0 AWG-250 kcmil Cu or (1) 250-350 kcmil Al
400 A	(2) 1/0 AWG-300 kcmil or (1) 1/0 AWG-700 <sup>[65]</sup> kcmil Cu or Al	(2) 1/0 AWG-700 <sup>[65]</sup> kcmil or (4) 1/0 AWG-300 kcmil	(1) 400-600 <sup>[65]</sup> kcmil Cu or (1) 2/0 AWG-500 kcmil Al
600 A		(4) 1/0 AWG-600 <sup>[65]</sup> kcmil Cu or Al <sup>[66]</sup>	(1) 2/0 AWG-500 kcmil Cu or Al
800 A		(6) 4/0 AWG-500 kcmil Cu or Al <sup>[67]</sup>	

**NOTE:** 200% applications require gutter mounted neutral in special (W x 26 in.) enclosure factory assembled only. One exception, without subfeed lugs, feed-thru lugs and subfeed breakers 400 A (30-84 circuit interiors) and 600 A (30-54 circuit interiors) does not require a special enclosure. Gutter extensions may be required to provide NEC wire bending space for cable(s) of maximum lug size.



600 A NF Main Lug Only Panelboard with Condo Riser Neutral Assembly

**Table 9.68: NF Panelboard Condo Riser Neutral Panelboards (Requires 26" Wide, 8.75" Deep Enclosure)<sup>[68]</sup>**

Main-s Rating	Available Branch Circuits	Neutral Rating	Neutral Assembly	Mains Options			Load End Options		Line Lug Wire Range	Load Lug Wire Range
				Main Lugs	Main Breaker	Sub-Feed Lugs	Feed-Thru Lugs	Sub-Feed Breaker		
400 / 600 A	30, 42, 54	100%	NFN6CR	Y <sup>[69]</sup>	LA, LG, LH, LJ, LL, LR <sup>[70]</sup>	Y	Y	Y	(4) AWG 1/0 - 750 kcmil	(8) AWG 3/0 - 750 kcmil
		200%	NFNL6CR							
800 A		100%	Factory Assembled Only	N / A	MG, PG, PJ, PL <sup>[71]</sup>	Y	Y	Y	(8) AWG 3/0 - 750 kcmil	(8) AWG 3/0 - 750 kcmil
		200%								

**Table 9.69: Metal Directory Frame**

Metal Directory Frame
Metal Directory Frames are available as a premium factory assembled alternative to standard plastic directory card holders on the back of panelboard trim fronts.

**Table 9.70: Hinged Door-in-Door Trim**

Hinged Door-in-Door Trim
Hinged Door-in-Door Trim has piano hinge down one side.
Inner door has a lock, outer door is retained with screws
Hinged Door-in-Door with Outer Door Lock in place of screws

**Table 9.71: Weatherproof or Dusttight Cabinets NEMA Type 3R, 4, 4X, 5, 12**

Weather resistant and Dust resistant Cabinets —Type 3R, 4, 4X, 5, 12
NEMA Type 4, 4X, 4, 12 enclosures not available with panelboards having PowerPact L circuit breakers

**Table 9.72: Optional Factory Assembled Lugs for Main Lug Only and Main Circuit Breaker Interiors**

Incoming Lugs Type
Aluminum Compression Lugs
Copper Mechanical Lugs
Copper Compression Lugs

**Table 9.73: Surgeloc™ Hard Bus SPD—Model<sup>[72]</sup>**

Surge Current Rating kA
100
120
160
200
240

**Table 9.74: Surgeloc SPD Options**

Surgeloc SPD Options
Surge Counter
Dry Contacts
Remote Monitor

**NOTE:** For additional factory modifications, see [Modifications For Factory Assembled Panelboards](#), page 9-68.

[64] Lug Wire Ranges shown meet NEC wire bending space. Lugs may accept larger cables if enclosure size is increased.  
 [65] Installation of 750 kcmil neutral lugs possible if enclosure size is increased to provide wire bending space.  
 [66] Factory Assembled only; increases enclosure length 6"-12".  
 [67] Factory Assembled only; enclosure length increases 6-12"; requires 8.75" deep D9 enclosure.  
 [68] Select 26" Wide Condo Riser Panel under Structure Options in the SE Advantage Panelboard Product Selector.  
 [69] Reference PBA757 drawing for additional dimensional information.  
 [70] Reference PBA758 drawing for additional dimensional information.  
 [71] Reference PBA756 or PBA756HR drawing for additional dimensional information.  
 [72] Panelboard box height with SPD unit—Contact your local Schneider Electric representative or distributor.



Table 9.75: NQ and NF Lighting Contactors—Mechanically Held

(Furnish a one-line power and control voltage connection diagram.)		
ASCO 920 Series		
Ampacity	2-Pole	3-Pole
30	Y	Y
60	Y	Y
75	Y	Y
100	Y	Y
150	Y	Y
225	Y	Y

NOTE: Lighting Contactors increase box & trim length by 18 in. (457 mm)

NF Merchandised and Factory Assembled Accessories

Table 9.76: NF Merchandised Interiors with Surge Protection Devices (SPD)

Available Pole Spaces	Main Rating	Main Circuit Breaker Adapter Kit	Main Circuit Breaker Frame	Interior Only Catalog No. [73]	Surge Current Rating	NEMA 1 Enclosure			NEMA 3R, 5, 12 Enclosure
						Box	Mono-Flat Front	Hinged Front	
42	250 A	Main Lug Only		NF442L2TVS416C	160 kA	MH56	NC56( )	NC56( )HR	MHWP56
		N250MJ [74]	JD/JG/JJ/JL			MH68	NC68( )	NC68( )HR	MHWP68
	Main Lug Only		NF442L4TVS416C			MH68	NC68V( )	NC68V( )HR	MHWP68
	N400M [75]	LALH				MH80	NC80V( )	NC80V( )HR	MHWP80

Accessories

Table 9.77: NF Merchandised Neutrals

Mains Ampacity	200% Neutral Kit		Copper 100% Neutral Kit	
	Catalog No.		Catalog No.	
125	NFNL1		NFN1CU	
250	NFNL2		NFN2CU	
400	NFNL4 [76]		NFN6CU	
600	Factory Assembled Only		NFN6CU [76]	

Table 9.78: NF Merchandised Interior Modification Kits

Mains Ampacity	Sub-feed Lugs [77]	Feed-through Lugs [77]	Mains Ampacity	Sub-feed Circuit Breaker Kits [77] (circuit breaker not included)	
	Catalog No.	Catalog No.		Single Sub-feed Circuit Breaker	Twin Sub-feed Circuit Breakers
125	NF125SFL	NF125FTL	250	NF250SFBH/NF250SFBJ	—
250	NF250SFL	NF250FTL	400	N600MPPL (400 A Max.) / NF600SFBPPL (600A)	NF600SFBH
400	NF400SFL [78]	NF400FTL	600		NF600SFBJ
600	Factory Assembled Only		800	Factory Assembled Only	

NOTE: NF250SFBH and NF600SFBH are for use with HDL, HGL, HJL, HLL, and HRL circuit breakers. NF250SFBJ and NF600SFBJ are for use with JDL, JGL, JLL, and JRL circuit breakers.

Table 9.79: NF Special Features Standard NEMA Type 1 Enclosure Selection Table—Enclosure Catalog Number for Standard Main Mechanical Lugs Only

Feature	Main Lugs Only																
	Sub-feed Lugs				Feed-through Lugs					Sub-feed Circuit Breaker							
Interior Rating	125 A	250 A	400 A	600 A	800 A	125 A	250 A	400 A	600 A	800 A	250 A	400 A	400 A [79]	600 A	600 A [79]	800 A	
No. of Circuits	NEMA 1 Enclosure Catalog Number					NEMA 1 Enclosure Catalog Number					NEMA 1 Enclosure Catalog Number						
18	MH26	—	—	—	—	MH32	—	—	—	—	—	—	—	—	—	—	Factory Assembled Only
30	MH32	MH38	MH50	—	—	MH38	MH50	MH56	—	—	MH56	MH68	MH62D9	MH68	MH62D9	—	
42	—	MH44	MH56	—	—	—	MH56	MH62	—	—	MH62	MH74	MH68D9	MH74	MH68D9	—	
54	—	MH50	MH62	—	—	—	MH62	MH68	—	—	MH68	MH80	MH74D9	MH86	MH74D9	—	
66	—	MH62	MH74	—	—	—	MH74	MH80	—	—	MH80	MH92	—	MH92	—	—	
84	—	—	MH86	—	—	—	—	—	—	—	—	—	—	—	—	—	

Table 9.80: Special Features Enclosures Selection Table—Merchandised NF Vertically Mounted Main Breaker Panelboards with Accessories (by Mains Rating)

No. of Circuits	Vertical Main Circuit Breaker (MB) [80]										Back-fed MB	
	Sub-feed Circuit Breaker (PowerPact H or J)					Feed-through Lugs (FTL)					FTL	
	125 A	250 A	400 A	600 A	800 A	125 A	250 A	400 A [80]	600 A	125 A		
18	—	—	—	—	—	—	—	—	—	—	—	MH32
30	—	—	—	—	—	—	—	—	—	—	—	MH38
42	—	MH68	MH80	—	—	—	—	—	—	—	—	—
54	—	MH74	MH86	—	—	—	—	—	—	—	—	—
66	—	MH80	MH92	—	—	—	—	—	—	—	—	—

[73] Order branch circuit breakers separately.  
 [74] Select the appropriate PowerPact main circuit breaker from Section 7.  
 [75] Select an appropriate LA or LH Thermal-Magnetic Circuit Breaker from Section 7.  
 [76] Not to be used with SFL, FTL, or SFB. These combinations are factory assembled only.  
 [77] Available factory assembled only on non-linear panelboards.  
 [78] Use copper wire only.  
 [79] PowerPact LG, LJ, LL, or LR Sub-Feed Circuit Breaker.  
 [80] 400 A dimension for LALH main circuit breakers only.

**Table 9.81: Optional Main Lug Kits for Main Lug Panelboards**

Ampacity	Al Compression Lug Kit		Cu Mechanical Lug Kit		Cu Compression Lug Kit [81]	
	Catalog No.	Lug Wire Range	Catalog No.	Lug Wire Range	Catalog No.	Lug Wire Range
125	NFALV1 [82]	one #4 AWG–300 kcmil	NFCUM1	#6–2/0 AWG	NFCUV1 [83]	one #6–1/0 AWG
250	NFALV2	one 250–350 kcmil	NFCUM2	#6 AWG–250 kcmil	NFCUV2 [83]	one 2/0 AWG–300 kcmil
400	NFALV4	two 2/0 AWG–500 kcmil	NFCUM4	one 1/0 AWG–750 kcmil, or two 1/0 AWG–350 kcmil	NFCUV4	one 400–750 kcmil
600	NFALV6	two 2/0 AWG–500 kcmil	NFCUM6	two 1/0 AWG–750 kcmil	NFCUV6	two 250–500 kcmil
800	Contact your local Schneider Electric representative or distributor.					

[81] Use copper wire only.

[82] Use of this kit requires an additional 6 in. added to box height.

[83] Use of this kit to terminate larger than standard wire size requires an additional 6 in. added to box height.

Table 9.82: NF Accessories

Description	Catalog No.	Description	Catalog No.
Aluminum Equipment Ground Bar	PK27GTA	Replacement Part Kits	
Copper Equipment Ground Bar	PK27GTACU	Filler plate (15 per package)	NFFP15
AWG #1-4/0 Aluminum Lug on Aluminum Equipment Ground Bar	PK23GTAL	E-frame Fixed padlock attachment, Lock ON/OFF for ED, EG, and EJ Circuit Breakers 1, 2, or 3 poles	EDPA
Equipment Ground Bar Insulator Kit	PKGTAB	E-frame Fixed padlock attachment, Lock OFF only for ED, EG, and EJ Circuit Breakers 1, 2, or 3 poles	EDPAF
<b>Circuit I.D. number strips</b>		Drip Hood for 20 in. wide enclosures	MHT2DH20
102 odd/even (left side numbered 1, 3, 5...101)	NF102OE		
103-204 odd/even (left side numbered 103, 105, 107...203)	NF204OE		
1-102 sequential (left side numbered 1, 2, 3 ...102)	NF102S		
103-204 sequential (left side numbered 103, 104, 105... 204)	NF204S		
<b>Rail and Deadfront Extensions</b>			
6 in. Extension	NF6RDE		
12 in. Extension	NF12RDE		
18 in. Extension	NF18RDE		

Table 9.83: Add-On Lugs for Neutral Bars or Ground Bars<sup>[84]</sup>

Catalog Number	Lug Wire Range (AWG)	Wire Ampere
QO70AN	#12 to #2 Al or #14 to #4 Cu	70 A
Q1100AN	#14 to #1/0 Al or Cu	80 - 100 A

### Separated Distribution and Split Bus NF and NQ Panelboards



Square D Separated Distribution and Split Bus Panelboards provide compact, affordable options to protect lighting, HVAC, renewable energy, and appliance circuits in buildings.

Separated Distribution Panelboards facilitate Separation of Electrical Circuits for Electrical Energy Monitoring to simplify compliance with Section 130.5-B of California's 2016 Building Energy Efficiency Standards.

**NOTE:** Refer to Data Bulletin 1600HO1701 for more information.



Special lug pad adaptors allow field removal of cables, for easy field installation of solid core or split CTs for electrical energy measurement, by load type.

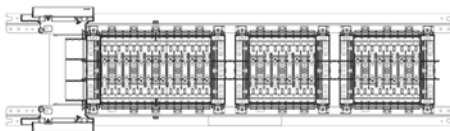

Split Bus panelboards enable configurations of two or three back fed main circuit breakers, with independent branch distribution sections, in a single enclosure.

[84] Requires two standard termination spaces on Neutral or Ground bar.

**Table 9.84: Separated Distribution Interiors (Cabled Between Sections)**

Separated Distribution Interiors (cabled between sections)			Max. No. of Available Pole Spaces			Box Height (in.)	
Product Family	Main Ampacity MLO	Voltage Phases	Main	Split	Split 2	Main Lug Only	Main Circuit Breaker
NQ	225 A	3 Ph	30	18	18	62	74
	400 A		18	18	18	62	74
NF	250 A	3 Ph	30	18	18	80	92
			18	18	18	80	92

**Table 9.85: Bus Bar Interiors (125 A Max. Split Amps)**

Split Bus Bar Interiors (125 A Max. Split Amps)			Max. No. of Available Pole Spaces			Box Height (in.)	
Product Family	Main Ampacity MLO	Voltage Phases	Main	Split	Split 2	Main Lug Only	Main Circuit Breaker
NQ	225 A	1, 3 Ph	18	30	—	44	56
		1, 3 Ph	30	18	—	44	56
		1, 3 Ph	30	30	—	44	56
		3 Ph	30	18	18	50	62
NF	250 A	3 Ph	18	30	—	56	68
		1, 3 Ph	30	18	—	56	68
		1, 3 Ph	30	30	—	62	74
		3 Ph	30	18	18	74	86

Square D NF and NQ Separated Distribution and Split Bus Panelboards come Factory Assembled with copper bus, with or without an integral Main Circuit Breaker. A wide variety of configurations may be submitted for quotation via Square D QuoteFAST, and may be quoted or ordered by Authorized Distributors using SE Advantage or E-Way Quote Management.

**Features:**

- Multiple branch section configurations (pole spaces per section):
  - Split Bus: 18-30; 30-18; 30-30; 30-18-18
  - Separated Distribution: 30-18-18; 18-18-18
- Up to 400 A Mains rating for NQ; up to 250 A Mains in NF panelboards

**Notes:**

Enclosure width / depth: 20" / 5.75" minimum.

Subfeed breaker or lugs, feed through lugs not available at top or bottom ends of panel.

- Split Bus - feeder breaker (125 A max.) in downstream split section back-fed from feeder breaker in upstream main or split section.
- Segregated Distribution - cables may be removed in the field. Downstream Split section may have same rating as Main.

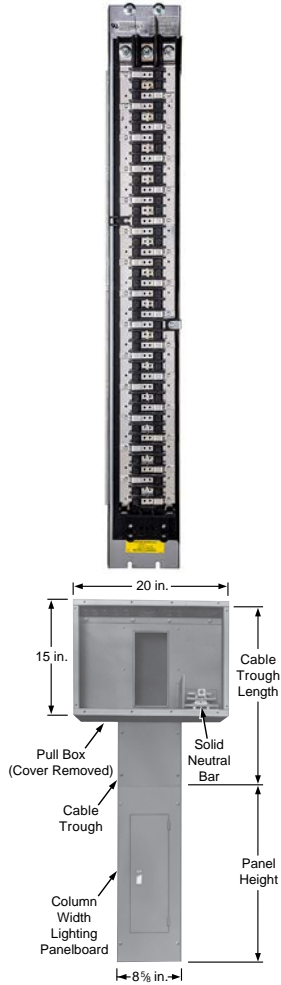

**(60 A Max. Branch Circuit Breaker)  
NQ Application Data**

**Application:** For use on ac only. Meet Federal Specification W-P-115c, Type 1, Class 1. UL Listed.

**Service:** 1Ø3W, 3Ø3W, 3Ø4W,  
3 Grd. "B" Ø—240 Vac max.

**AIR:** See the QOB(VH) circuit breaker tables in Section 9.

**Mains:** Type NQ—Bolt-on main lugs: 100 A, 225 A

- Main circuit breaker: 100 A—QOU, 225 A—QB
- See the tables in Section 7 for main circuit breaker interrupt ratings. See catalog for terminal lug data.
- Main circuit breakers with higher interrupt ratings are available as factory assembled panelboards.

**Branches:** Bolt-on QOB, 60 A maximum. QOB 10-60 A 1-, 2- and 3-pole. See [QOB Circuit Breakers for NQ Panelboards, page 9-15](#) and [NQ Factory Assembled Panelboards, page 9-18](#) for branch circuit breaker terminal data. QOB-VH and QHB branch circuit breakers are also available as factory assembled.

**Cabinet:** Front—Screw cover. Box—galvanized steel with removable endwalls.

**Gutters:**

- 100 A—4 in. min. mains end, 3 in. min. opposite mains
- 225 A—10 in. min. mains end, 5 in. min. opposite mains

**Table 9.86: NQ Single-Row (Column-width)—240 Vac Bolt-on [1]**

Max. No. of Poles	Mains Rating	Box and Interior with Solid Neutral (8.625 in. W. x 5 in. D.) (Order branch circuit breakers separately)		Front (Surface Mount)
		Catalog Number	Box Height (In.)	Catalog Number
<b>1 Phase 3-Wire Main Lugs Only</b>				
30	225	NQ830L2C	45	LX45TS
<b>Main Circuit Breaker—2-pole</b>				
20	100	NQ820B1C	40	LX40TS
<b>3 Phase 4-Wire Main Lugs Only</b>				
30	100	NQ8430L1C	40	LX40TS
42	225	NQ8442L2C	58	LX58TS
<b>Main Circuit Breaker—3-pole</b>				
30	100	NQ8430B1C	45	LX45TS
42	225	NQ8442B2C	62	LX62TS

**Table 9.87: Cable Troughs and Pull Boxes**

Cable Troughs (L=Length) [2]		Pull Boxes with Solid Neutral	
L (In.)	8.625 in. x 5 in. Catalog Number	S/N Terminals	Catalog Number
36	MTX836	42	MPX81542
48	MTX848		
56	MTX856		
66	MTX866		

[1] 60 A Maximum Branch—Copper Bus Standard.  
[2] Cable troughs are standard with a trough barrier.



**(60 A Max. Branch Circuit Breaker)  
NF Application Data**

**Application:** For use on ac only. Meet Federal Specification W-P-115c, Type 1, Class 1. UL Listed.

**Service:** 480Y/277 Vac, 3Ø4W

**AIR:** See the E-frame circuit breaker tables in Section 9.

**Mains:** Type NF—Bolt-on main lugs: 125 A, 225 A

- Main circuit breaker: 100 A—HD, 225 A—JD. See the tables in Section 7 for main circuit breaker interrupt rating. See the catalog section for terminal lug data.
- Main circuit breakers with higher interrupt ratings are available as factory assembled panelboards.

**Branches:** EDB, EDG, or EDJ, 60 A maximum. See [E-frame Thermal-magnetic \(480Y/277 Vac Max\)](#), page 9-31 for branch circuit breaker catalog numbers and terminal data.

**Cabinet:** Front—Screw cover. Box—galvanized steel with removable endwalls.

**Gutters:**

- 100 A—4 in. min. mains end, 3 in. min. opposite mains
- 225 A—10 in. min. mains end, 5 in. min. opposite mains

**Table 9.88: NF Single-Row (Column-width)—480Y/277 Vac Bolt-on**

Max. No. of Poles	Mains Rating	Box and Interior with S/N (9.69 in. W. x 5.625 in. D.)		Front (Surface Mount)
		Catalog Number	Box Height (In.)	Catalog Number
<b>Main Lugs Only—3 Phase 4-Wire</b>				
30	125	NF8430L1C	59	NC59TS
42	225	NF8442L2C	71	NC71TS
<b>Main Circuit Breaker—3-pole</b>				
30	100	NF8430M1C	65	NC65TS
		NF8430M1HDC		
42	225	NF8442M2JDC	85	NC85TS

**Table 9.89: Cable Troughs and Pull Boxes**

Cable Troughs (L=Length) [3]		Pull Boxes with Solid Neutral	
L (In.)	9.69 in. x 5.625 in. Catalog Number [4]	S/N Terminals	Catalog Number
36	NTX836	42	MPX81542
48	NTX848		
56	NTX856		
66	NTX866		

[3] Cable troughs are standard with a trough barrier.

[4] Box width = 8.625 in.; width at front, including flange, is 9.69 in.



Powerlink available in column width design

## Powerlink™ Intelligent Lighting Control Systems

Powerlink intelligent lighting control systems are ideally suited for controlling lighting and other loads in commercial, institutional, and industrial facilities. Such systems are typically used to lower utility cost by switching branch circuits OFF during non-occupied periods when lighting is unnecessary or during peak demand periods when a partial reduction in load can save significant money.

These systems utilize remotely operated circuit breakers to switch branch circuits ON and OFF via a time schedule or by an externally generated signal (typically a low voltage wall switch, photocell, access system, fire alarm or building management system). All Powerlink components mount inside a standard lighting panelboard to provide a compact, space saving installation.

Powerlink intelligent lighting control systems feature a powerful microprocessor based controller that provides system intelligence for 168 remotely operated branch circuits. Master panelboards contain the control electronics, power supply, and control bus strips for up to 42 branch circuit breakers. Sub-panels extend the capability of the system by allowing remotely operated branch circuit breakers to be operated from the master controller via a simple, 4-wire, sub-net connection.

Powerlink panels systems have the capability of being networked together and operated from a central workstation or via a remote modem connection. Powerlink software allows users to remotely configure the system, change time schedules, monitor circuit breaker or input status, and override zones and breakers.

### BACnet Capability

The Building Automation and Control network (BACnet) communication protocol is incorporated into the Powerlink™ controller design. The addition of the BACnet protocol allows Powerlink panels to be easily integrated into a Building Automation System (BAS) employing this open communication standard without the need for communication bridges or gateways.

### Controller

Powerlink NF3500G4 controllers support 'native' BACnet and Ethernet communications.

**Factory Assembled System**

SE advantage may be used to select 120 Vac, 240 Vac or 480Y/277 Vac Powerlink intelligent lighting control systems:

- Select system type and interior size from [Table 9.90](#), page 9-43. All Powerlink panels are furnished with either 1 or 2 control bus strips.
- All Powerlink panels use NF type panelboard interiors, boxes, and trims and are suitable for 120 Vac, 240 Vac or 480Y/277 Vac systems.
- Select branch circuit breaker requirements. Powerlink panels can accommodate both ECB-G3 remotely operated circuit breakers and EDB, EGB and EJB standard branch circuit breakers.
- Refer to panelboard section for additional panelboard accessories.
- For complete price, order by description.
- Apply appropriate discount schedule.

**240 Vac Factory Assembled System Example:**

3500 level system with 225 A MLO panelboard rated for 208Y/120 Vac, 3Ø4W, 10kAIR, Type 1, surface mount with ground bar and (12) 20 A 1-pole bolt-on remote operated circuit breakers.

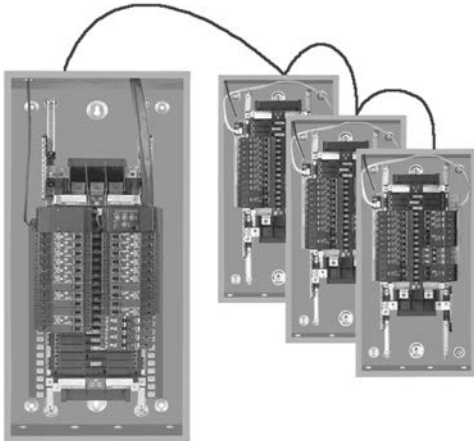

Up to eight panels can be controlled from a single controller.

**Table 9.90:**

Item	Page No.
System Type: 3500 controller with 12 ckt bus	<a href="#">page 9-44</a>
Panel type: 250 A MLO	<a href="#">page 9-29</a>
Branch circuit breakers: (12) 20 A 1-pole	<a href="#">page 9-43</a>
Ground bar	<a href="#">page 9-34</a>

**Table 9.91:**

NF3500G4 Controller Feature	Quantity Available <sup>[1]</sup>
<b>Inputs</b>	
2 - wire	16
2 - wire with status feedback <sup>[2]</sup>	8
3 - wire	8
Analog Inputs available	4
<b>Time Scheduler</b>	
Independent schedules	64
ON-OFF periods/schedule	999
Special events/holiday periods	64
Automatic daylight savings	X
Sunrise/sunset tracking	X
<b>Network Variables</b>	
Communications inputs accessible	256
Remote sources (per controller)	128
Maximum subscriptions	256
<b>Zones</b>	
Maximum number	256
Maximum number of sources per zone	4
Maximum number of remotely operated circuit breakers (per subnet)	168
<b>Networking</b>	
RS-232 port/RS-485 port	X
Ethernet (100BaseT port)	X
<b>Protocols</b>	
Modbus™ ASCII/RTU	X
Modbus TCP	X
BACnet/IP, BACnet MS/TP	X
DMX512	X

**Powerlink™ ECB-G3 Circuit Breakers**

**Table 9.92: ECB-G3 Circuit Breakers Bolt-On Remotely Operated**

Ampere Rating	One-Pole 27 7 Vac – 14,000 AIR 120 Vac – 65,000 AIR	Two-Pole 480Y/277 Vac – 14,000 AIR 120/240 Vac – 65,000 AIR 240 Vac – 14,000 AIR Ground B Phase	Three-Pole 480Y/277 Vac – 14,000 AIR 240 Vac – 42,000 AIR
15	<a href="#">ECB14015G3<sup>[3]</sup></a>	<a href="#">ECB24015G3<sup>[3]</sup></a>	<a href="#">ECB34015G3<sup>[3]</sup></a>
20	<a href="#">ECB14020G3<sup>[3]</sup></a>	<a href="#">ECB24020G3<sup>[3]</sup></a>	<a href="#">ECB34020G3<sup>[3]</sup></a>
30	<a href="#">ECB14030G3</a>	<a href="#">ECB24030G3</a>	<a href="#">ECB32030G3<sup>[4]</sup></a>

**Table 9.93: ECB-G3 Circuit Breakers for Emergency Lighting (requires 2-pole spaces)**

Ampere Rating	One-Pole 480 Y/277 – 14,000 AIR 240 V – 65,000 AIR
20	<a href="#">ECB142020G3EL</a>

**NOTE:** All are listed as HACR type for use with air conditioning, heating and refrigeration equipment having motor group combinations and marked for use with HACR type circuit breakers. UL listed as HID rated for use with high intensity discharge lighting systems. (1) #12–8 Al or (1) #10–8 Cu. Suitable for use with 75°C conductors.



ECB-G3 Circuit Breakers

[1] X = Supported feature.  
 [2] 7.5 mA maximum load per input terminal.  
 [3] UL listed as SWD (switching duty) rated.  
 [4] Rated for 240 Vac only – 42,000 AIR



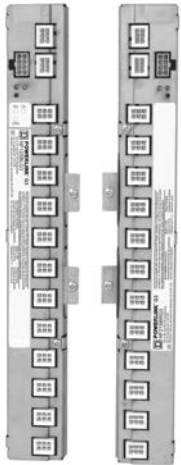

Control Bus



Power Supply



NF3500G4 Controller



Powerlink Software

**Powerlink™ Accessories**

**Table 9.94: Control Bus**

Max. No. of Control Circuits	Required Interior Size	Panel Orientation	Catalog No.
12	30	Left	NF12SBLG3
12	30	Right	NF12SBRG3
18	42	Left	NF18SBLG3
18	42	Right	NF18SBRG3
21	54	Left	NF21SBLG3
21	54	Right	NF21SBRG3

**Table 9.95: Power Supply**

Voltage	Primary Source	Catalog No.
120 V	Panel Bus	NF120PSG3
240 V	Panel Bus	NF240PSG3
277 V	Panel Bus	NF277PSG3
120 V	External	NF120PSG3L
240 V	External	NF240PSG3L
277 V	External	NF277PSG3L

**Table 9.96: Cables & Accessories**

Description	Catalog No.
<b>Control bus cables</b>	
Harness standard panel	NF2HG3
<b>Sub-net accessories &amp; cables</b>	
Sub-panel address selector <sup>[5]</sup>	NFSELG3
6' sub-net cable	NFSN06

**Table 9.97: Miscellaneous Hardware**

Description	Catalog No.
Circuit Breaker Handle Padlock (Lock On or Off)	HPAFD
Fixed Barrier	NFASBKG3

**Table 9.98: Software**

Description	Catalog No.
LCSV2 Software <sup>[6]</sup>	LCSV2

[5] One address selector required for each sub-panel.

[6] Required for G4 controllers (NF3500G4). Will also support G3 controllers.

**Remote Mount Controller**

**Table 9.99: Remote Mount Controller (for externally mounted electronics) Includes NEMA 1 enclosure, NF3500G4 controller, and power supply**



Remote Mount Controller

Voltage	Catalog No.	Controller Type
120 V	RMC3500G4120	NF3500G4
240 V	RMC3500G4240	
277 V	RMC3500G4277	

**NF Panelboards 240 V and 480Y/277 V Factory Assembled Systems—Max. Voltage 480Y/277 Vac**

**Table 9.100: Branch Circuit Breaker**

Powerlink G3—ECB Bolt-On 65 kA AIR@240 Vac, 14 kA AIR@480 Y/277		Standard Breakers—EDB Bolt-On 18 kA AIR 1-pole, 25 kA AIR 2 & 3-pole @ 240 V, 18 kA AIR@480 Y/277		Standard Breakers HIC —EGB Bolt-On 65 kA AIR@240 Vac, 35 kA AIR@480 Y/277		Standard Breakers Extra HIC—EJB Bolt-On 100 kA AIR@240 Vac, 65 kA AIR@480 Y/277		
Voltage	Ampere Rating	Voltage	Ampere Rating	Voltage	Ampere Rating	Voltage	Ampere Rating	
240 Vac	15–20 A	480Y/277 Vac	15–60 A	480Y/277 Vac	15–60 A	480Y/277 Vac	15–60 A	
	30 A		70 A		70 A		70 A	
480Y/277 Vac	15–20 A		80–100 A		80–100 A		80–100 A	80–100 A
	30 A		110–125 A		110–125 A		110–125 A	110–125 A
Space Only		Space Only		Space Only		Space Only		

**NOTE:** All EC, ED, EG and EJ branch circuit breakers are UL Listed as HACR type.

**Table 9.101: Sub-Feed Breaker Cabinet Data**

Max. No. of Branch Spaces (Does not include sub-feed breaker spaces)	Box Height (20" W x 5.75" D)						
	250 A		400 A LA/LH		600 A		800 A
	Main Lugs	Main Circuit Breaker	Main Lugs	Main Circuit Breaker	Main Lugs <sup>[7]</sup>	Main Circuit Breaker <sup>[8],[9]</sup>	Main Lugs <sup>[10]</sup>
30	56	68	68	80	68	80	68
42	62	74	74	86	74	86	74
54	68	80	80	92	80	92	80

- Available on 1Ø or 3Ø, 125–800 A main lugs or 125–600 A main circuit breaker interiors
- One sub-feed JD, JG, JJ or JL circuit breaker per 250 A panelboard
- Two sub-feed JD, JG, JJ or JL circuit breakers per 400 A panelboard

- PowerLogic™ metering
- Customer equipment space
- Increased box depth
- Box extensions top, bottom and side
- Drip hoods
- Non-standard paint
- NEMA 1 gasketed
- NEMA 4 Stainless steel enclosure
- NEMA 4X Fiberglass enclosure (NQ and NF)
- Stainless steel trim front (NQ, NF and I-LINE)
- Padlockable hasp
- Special locks (Corbin, Yale, Best)
- Equal height boxes
- Common trip to cover two equal height boxes
- Panelboard skirtheads conduits feeding a panelboard
- Panelboard wireway for terminating conduit in wireway endwall
- Panelboard interiors and special fronts to fit existing boxes

[7] 600 A main lug panelboards require an 8.75" deep box.  
 [8] Dimensions also for 400 A PowerPact L main circuit breaker panels.  
 [9] 600 A main lug panelboards require an 8" deep, 26" wide box.  
 [10] 800 A main lug panelboards require an 8.75" deep, 26" wide box.

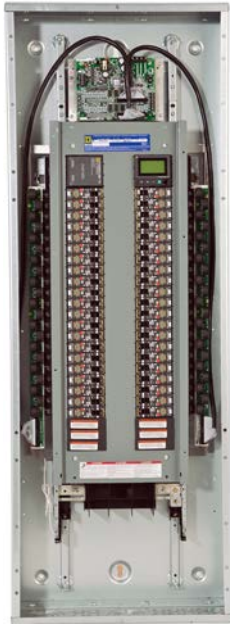

Powerlink Energy Management (EM) Lighting Control System

### Lighting Control System, Relay Panels, and Switches

#### Energy Management (EM) Lighting Control System

The Powerlink Energy Management (EM) Lighting Control System incorporates the same features found in the Powerlink 3500 level system, in addition to integral branch circuit and optional main metering for energy monitoring and verification of the lighting system. Integral metering is accomplished using the PowerLogic™ Branch Circuit Power Meter (BCPM), which is a highly accurate, full-featured multi-branch circuit power meter that provides unrivalled low-current monitoring.

The Powerlink system reduces electrical energy consumption associated with lighting and other loads by automatically switching loads off during non-occupied periods. The Powerlink system is often ideal for reducing the peak demand by switching unnecessary lights off in response to an automated response signal or when high time-of-day energy tariffs occur.

- Integral individual and optional mains metering to provide utmost flexibility in assuring a sustainable metering and verification program
- Monitors current, voltage, energy consumption, demand, and power factor for complete energy profiling
- Accumulated metering information transmitted via Modbus communications interface
- Data updates occurring within seconds to provide timely preventative maintenance information
- Optional EGX150 web interface for storing and reporting data via standard web browser (suggested for applications without Energy Management System [EMS] software)
- Alarm indication when parameters approach user-configured thresholds
- 16 hard-wired inputs available for connection to devices with physical dry-contacts
- 64 communication inputs available for network connection
- 16 independent time schedules, each can be configured into 24 distinct periods
- 7-day repeating clock with changeable automatic daylight savings time
- Automatic sunrise/sunset tracking with offsets
- 32 special event periods
- 32 remote sources for sharing input status, time schedules, or zone status between controllers
- Full custom logic capabilities, including full Boolean functions and synchronization services
- RS232 and RS485
- Serial communications using Modbus ASCII/RTU, BACnet MS/TP and DMX512 protocols (metering Modbus only)
- Ethernet 100BaseT communications using Modbus TCP and BACnet/IP protocols

Table 9.102: Characteristics, Standards Compliance, and BCPM Specifications

Characteristics	
Operating Temperature	-5° to 40°C (23° to 104°F) (95%RH, non-condensing)
Storage Temperature	-20° to 85°C (-4° to 185°F) (<95%RH, non-condensing)
Regulatory/Standards Compliance	
<ul style="list-style-type: none"> <li>• UL Listed 916, Energy Management Equip</li> <li>• FCC Part 15, Class A</li> <li>• NEC Class 1 and Class 2 Control Circuits</li> <li>• ESD Immunity: IEC 1000, level 4</li> <li>• RF Susceptibility: IEC 1000, level 3</li> <li>• Electrical Fast Transient Susceptibility: IEC 1000, level 3</li> <li>• Electrical Surge Susceptibility: IEC 1000, level 4 (power line)</li> <li>• Electrical Fast Transient Susceptibility: IEC 1000, level 3 (interconnection lines)</li> </ul>	
BCPM Specifications	
General	
Control Power	90–277 Vac
Frequency	50/60 Hz
Sampling Frequency	2560 Hz
Update Rate	1.6 seconds per panelboard
Overload Capability	10 kAIC
Ribbon Cable Support	Up to 20 ft.
Operating Temperature	0° to 60°C (32°C to 122°F) (<95%RH, non-condensing)
Storage Temperature	-40° to 70°C (-40° to 158°F)
Accuracy	
Current Monitoring	0.25 A to 100A; 3% of reading from 0.25 A to 2 A; 2% of reading from 2 A to 100 A
Auxiliary Inputs	2% of reading from 1% to 10% of rated current; 1% of reading from 10% to 100% of rated current (0 to 0.333 Vac)
Voltage Input	90–277 Vac; 1% of reading from 90–277 L-N (models BCPMA and BCPMB only)
Power	4% of reading from 0.25 A to 2 A; 3% of reading 2 A to 100 A <sup>[11]</sup> (models BCPMA and BCPM only)
Network Communications	
Serial	Modbus™ RTU
Ethernet	TCP/IP

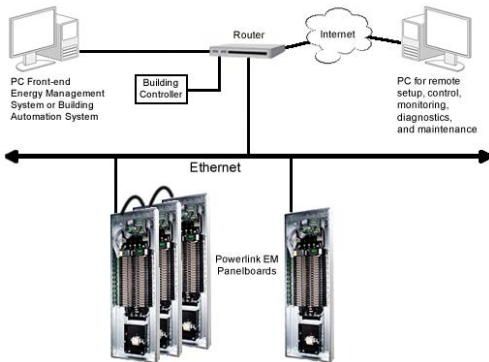

[11] Recommended for application where EMS software monitoring is not provided.

*New!* **I-Line Combo Panelboard**

**Table 9.103: Interior Boxes and Fronts — Includes Solid Neutral**

I-Line Mounting Space	Part Number	Panel-board Ampacity	Single/Duplex	Lighting Section Type	Lighting Section Amperage	Lighting Section Circuits	Bus-ing	Phase	Ground Bar	Box	4 Piece Trim Without Door	Trim with Door	NEMA 3R/5/12 (Includes Front)
18	CP18864N3Q2C	400	S	NQ	225	30	Cu	3	PK32DGTACU	HC2686DB	HC2686T( ) 4P	HC2686T( ) HR	HC2686WP
18	CP18864N3Q2	400	S	NQ	225	30	Al	3	PK32DGTAL	HC2686DB	HC2686T( ) 4P	HC2686T( ) HR	HC2686WP
18	CP18864N4Q2C	400	S	NQ	225	42	Cu	3	PK32DGTACU	HC2686DB	HC2686T( ) 4P	HC2686T( ) HR	HC2686WP
18	CP18864N4Q2	400	S	NQ	225	42	Al	3	PK32DGTAL	HC2686DB	HC2686T( ) 4P	HC2686T( ) HR	HC2686WP
18	CP18864N3F2C	400	S	NF	250	30	Cu	3	PK32DGTACU	HC2686DB	HC2686T( ) 4P	HC2686T( ) HR	HC2686WP
18	CP18864N3F2	400	S	NF	250	30	Al	3	PK32DGTAL	HC2686DB	HC2686T( ) 4P	HC2686T( ) HR	HC2686WP
18	CP18864N4F2C	400	S	NF	250	42	Cu	3	PK32DGTACU	HC2686DB	HC2686T( ) 4P	HC2686T( ) HR	HC2686WP
18	CP18864N4F2	400	S	NF	250	42	Al	3	PK32DGTAL	HC2686DB	HC2686T( ) 4P	HC2686T( ) HR	HC2686WP
18	CP118864N4Q4C	400	S	NQ	400	42	Cu	1	PK32DGTACU	HC2686DB	HC2686T( ) 4P	HC2686T( ) HR	HC2686WP
18	CP18866N3Q4C	600	S	NQ	400	30	Cu	3	PK32DGTACU	HC2686DB	HC2686T( ) 4P	HC2686T( ) HR	HC2686WP
18	CP18866N4Q4C	600	S	NQ	400	42	Cu	3	PK32DGTACU	HC2686DB	HC2686T( ) 4P	HC2686T( ) HR	HC2686WP
18	CP118866N4Q6C	600	S	NQ	600	42	Cu	1	PK32DGTACU	HC2686DB	HC2686T( ) 4P	HC2686T( ) HR	HC2686WP
18	CP18866N3F4C	600	S	NF	400	30	Cu	3	PK32DGTACU	HC2686DB	HC2686T( ) 4P	HC2686T( ) HR	HC2686WP
18	CP18866N4F4C	600	S	NF	400	42	Cu	3	PK32DGTACU	HC2686DB	HC2686T( ) 4P	HC2686T( ) HR	HC2686WP
22.5	CP23734N3Q2C	400	S	NQ	225	30	Cu	3	PK32DGTACU	HC3273DB9	HCM73T( ) JV	HCM73T( ) JVD	N/A
22.5	CP23734N3Q2	400	S	NQ	225	30	Al	3	PK32DGTAL	HC3273DB9	HCM73T( ) JV	HCM73T( ) JVD	N/A
22.5	CP123734N3Q4C	400	S	NQ	400	30	Cu	1	PK32DGTACU	HC3273DB9	HCM73T( ) JV	HCM73T( ) JVD	N/A
22.5	CP23734N3F2C	400	S	NF	250	30	Cu	3	PK32DGTACU	HC3273DB9	HCM73T( ) JV	HCM73T( ) JVD	N/A
22.5	CP23734N3F2	400	S	NF	250	30	Al	3	PK32DGTAL	HC3273DB9	HCM73T( ) JV	HCM73T( ) JVD	N/A
22.5	CP23736N3Q4C	600	S	NQ	400	30	Cu	3	PK32DGTACU	HC3273DB9	HCM73T( ) JV	HCM73T( ) JVD	N/A
22.5	CP23736N3F4C	600	S	NF	400	30	Cu	3	PK32DGTAL	HC3273DB9	HCM73T( ) JV	HCM73T( ) JVD	N/A
22.5	CP23914N4Q2C	400	S	NQ	225	42	Cu	3	PK32DGTACU	HC3291DB9	HCM91T( ) JV	HCM91T( ) JVD	N/A
22.5	CP23914N4Q2	400	S	NQ	225	42	Al	3	PK32DGTAL	HC3291DB9	HCM91T( ) JV	HCM91T( ) JVD	N/A
22.5	CP23914N5Q2C	400	S	NQ	225	54	Cu	3	PK32DGTACU	HC3291DB9	HCM91T( ) JV	HCM91T( ) JVD	N/A
22.5	CP23914N5Q2	400	S	NQ	225	54	Al	3	PK32DGTAL	HC3291DB9	HCM91T( ) JV	HCM91T( ) JVD	N/A
22.5	CP23914N4F2C	400	S	NF	250	42	Cu	3	PK32DGTACU	HC3291DB9	HCM91T( ) JV	HCM91T( ) JVD	N/A
22.5	CP23914N4F2	400	S	NF	250	42	Al	3	PK32DGTAL	HC3291DB9	HCM91T( ) JV	HCM91T( ) JVD	N/A
22.5	CP23914N5F2C	400	S	NF	250	54	Cu	3	PK32DGTACU	HC3291DB9	HCM91T( ) JV	HCM91T( ) JVD	N/A
22.5	CP23914N5F2	400	S	NF	250	54	Al	3	PK32DGTAL	HC3291DB9	HCM91T( ) JV	HCM91T( ) JVD	N/A
22.5	CP23916N4Q4C	600	S	NQ	400	42	Cu	3	PK32DGTACU	HC3291DB9	HCM91T( ) JV	HCM91T( ) JVD	N/A
22.5	CP23916N5Q4C	600	S	NQ	400	54	Cu	3	PK32DGTACU	HC3291DB9	HCM91T( ) JV	HCM91T( ) JVD	N/A
22.5	CP123916N5Q4C	600	S	NQ	400	54	Cu	1	PK32DGTACU	HC3291DB9	HCM91T( ) JV	HCM91T( ) JVD	N/A
22.5	CP23916N4F4C	600	S	NF	400	42	Cu	3	PK32DGTACU	HC3291DB9	HCM91T( ) JV	HCM91T( ) JVD	N/A
22.5	CP23916N5F4C	600	S	NF	400	54	Cu	3	PK32DGTACU	HC3291DB9	HCM91T( ) JV	HCM91T( ) JVD	N/A
22.5	CP123916N5Q6C	600	S	NQ	600	54	Cu	1	PK32DGTACU	HC3291DB9	HCM91T( ) JV	HCM91T( ) JVD	N/A
22.5	CP23916N44Q4C	600	D	NQ	400	42/42	Cu	3	PK32DGTACU	HC3291DB9	HCM91T( ) JV	HCM91T( ) JVD	N/A
22.5	CP123916N44Q4C	600	D	NQ	400	42/42	Cu	1	PK32DGTACU	HC3291DB9	HCM91T( ) JV	HCM91T( ) JVD	N/A
22.5	CP23916N53Q4C	600	D	NQ	400	54/30	Cu	3	PK32DGTACU	HC3291DB9	HCM91T( ) JV	HCM91T( ) JVD	N/A
31.5	CP32866N44Q4C	600	D	NQ	400	42/42	Cu	3	PK32DGTACU	HC4486DB	HCR86T( ) JD	HCR86T( ) JD	HC4486WP
31.5	CP32866N53Q4C	600	D	NQ	400	54/30	Cu	3	PK32DGTACU	HC4486DB	HCR86T( ) JD	HCR86T( ) JD	HC4486WP
31.5	CP32866N4BQ4C	600	D	NQ	400	42/B*	Cu	3	PK32DGTACU	HC4486DB	HCR86T( ) JD	HCR86T( ) JD	HC4486WP
31.5	CP132866N44Q6C	600	D	NQ	600	42/42	Cu	1	PK32DGTACU	HC4486DB	HCR86T( ) JD	HCR86T( ) JD	HC4486WP
31.5	CP32866N44F4C	600	D	NF	400	42/42	Cu	3	PK32DGTACU	HC4486DB	HCR86T( ) JD	HCR86T( ) JD	HC4486WP
31.5	CP32866N53F4C	600	D	NF	400	54/30	Cu	3	PK32DGTACU	HC4486DB	HCR86T( ) JD	HCR86T( ) JD	HC4486WP
31.5	CP32866N4BF4C	600	D	NF	400	42/B*	Cu	3	PK32DGTACU	HC4486DB	HCR86T( ) JD	HCR86T( ) JD	HC4486WP
31.5	CP32866N44Q6C	800	D	NQ	600	42/42	Cu	3	PK32DGTACU	HC4486DB	HCR86T( ) JD	HCR86T( ) JD	HC4486WP
31.5	CP132866N44Q6C	800	D	NQ	600	42/42	Cu	1	PK32DGTACU	HC4486DB	HCR86T( ) JD	HCR86T( ) JD	HC4486WP
31.5	CP32866N53Q6C	800	D	NQ	600	54/30	Cu	3	PK32DGTACU	HC4486DB	HCR86T( ) JD	HCR86T( ) JD	HC4486WP
31.5	CP32866N3BQ6C	800	D	NQ	600	30/B[1]	Cu	3	PK32DGTACU	HC4486DB	HCR86T( ) JD	HCR86T( ) JD	HC4486WP
31.5	CP32866N4BQ6C	800	D	NQ	600	42/B[1]	Cu	3	PK32DGTACU	HC4486DB	HCR86T( ) JD	HCR86T( ) JD	HC4486WP
31.5	CP132866N4BQ6C	800	D	NQ	600	42/B[1]	Cu	1	PK32DGTACU	HC4486DB	HCR86T( ) JD	HCR86T( ) JD	HC4486WP
31.5	CP32866N5BQ6C	800	D	NQ	600	54/B[1]	Cu	3	PK32DGTACU	HC4486DB	HCR86T( ) JD	HCR86T( ) JD	HC4486WP
31.5	CP32866N44F6C	800	D	NF	600	42/42	Cu	3	PK32DGTACU	HC4486DB	HCR86T( ) JD	HCR86T( ) JD	HC4486WP
31.5	CP32866N53F6C	800	D	NF	600	54/30	Cu	3	PK32DGTACU	HC4486DB	HCR86T( ) JD	HCR86T( ) JD	HC4486WP
31.5	CP32866N3BF6C	800	D	NF	600	30/B[1]	Cu	3	PK32DGTACU	HC4486DB	HCR86T( ) JD	HCR86T( ) JD	HC4486WP
31.5	CP32866N4BF6C	800	D	NF	600	42/B[1]	Cu	3	PK32DGTACU	HC4486DB	HCR86T( ) JD	HCR86T( ) JD	HC4486WP
31.5	CP32866N5BF6C	800	D	NF	600	54/B[1]	Cu	3	PK32DGTACU	HC4486DB	HCR86T( ) JD	HCR86T( ) JD	HC4486WP

[1] B denotes a blank space on the right hand side of a duplex panel for future expansion



9

PANELBOARDS

**Table 9.104: RTI Cabled Lighting Section Kit for I-Line Combo Panelboard**

Part Number	Description	MLO Panelboard Ampacity	Lighting Section Type	Lighting Section Circuits
NFICRT418L1C	NF Lighting Section Kit	125	NF	18 dual
NFICRT442L2C	NF Lighting Section Kit	250	NF	42
NFICRT442L4C	NF Lighting Section Kit	400	NF	42
NFICRT442L6C	NF Lighting Section Kit	600	NF	42
NQICRT418L1C	NQ Lighting Section Kit	100	NQ	18 dual
NQICRT442L2C	NQ Lighting Section Kit	225	NQ	42
NQICRT442L4C	NQ Lighting Section Kit	400	NQ	42
NQICRT442L6C	NQ Lighting Section Kit	600	NQ	42
NQICRT418C1C	Contactors with 18 Circuit NQ Lighting Section Kit	100	NQ	18
NFICRT418C1C	Contactors with 18 Circuit NF Lighting Section Kit	125	NF	18

**I-Line Panelboard**

**TYPE HCJ**

250 A max. branch circuit breaker  
BD, BG, BJ, QB, QD, QG, QJ, HD, HG, HJ, HL, HR, JD, JG, JJ, JL, JR

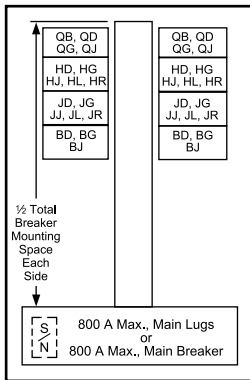

Box Size:  
32 in. Wide, 9.5 in. Deep, NEMA Type 1

**TYPE HCP-SU**

800 A max. main circuit breaker  
600 A max. branch circuit breaker  
BD, BG, BJ, LA, LG, LJ, LL, LH, LR, MG, MJ, PG, PJ, PL, PGC, PJC, PLC<sup>[2]</sup>, QB, QD, QG, QJ, HD, HG, HJ, HL, JD, JG, JJ, JL

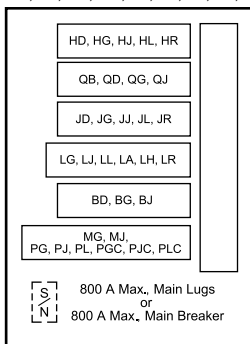

Box Size:  
26 in. Wide, 9.5 in. Deep, NEMA Type 1

**Table 9.105: Interiors, Boxes and Fronts**

Total Circuit Breaker Mounting Space (In.)	Mains Am-pere Rating	Interior Assembly (Less Branch Circuit Breakers)	Front <sup>[3]</sup>		Box <sup>[4]</sup>		Box Height (In.)	
			4 Piece Trim Without Door	Trim With Door <sup>[4]</sup>	Type 1	NEMA 3R/5/12 <sup>[5]</sup> (Includes Front)		
		Catalog Number	Catalog Number	Catalog Number	Catalog Number	Catalog Number		
<b>HCJ Main Lugs Only</b> 3-pole—Suitable for use as service equipment when provided with a main circuit breaker and service barrier kit. <sup>[6]</sup>								
27	400 A	HCJ14484	HCM48T()	HCM48T(D)	HC3248DB9	HCJ3248WP	48	
		HCJ14484CU						
	600 A	HCJ14486						
45	800 A	HCJ14488	HCM73T()	HCM73T(D)	HC3273DB9	HCJ3273WP	73	
	400 A	HCJ23734						
	600 A	HCJ23736						
63	800 A	HCJ23738	HCM91T()	HCM91T(D)	HC3291DB9	HCJ3291WP	91	
	400 A	HCJ32734						
	600 A	HCJ32736						
99	800 A	HCJ32738	HCM91T()	HCM91T(D)	HC3291DB9	HCJ3291WP	91	
	400 A	HCJ50914						
	600 A	HCJ50916						
27	400 A	HCJ14734M	HCM73T()	HCM73T(D)	HC3273DB9	HCJ3273WP	73	
	600 A	HCJ18736MP						
	800 A	HCJ18738MP						
45	400 A	HCJ23734M	HCM91T()	HCM91T(D)	HC3291DB9	HCJ3291WP	91	
	72	600 A						HCJ36916MP
	81	400 A						HCJ41914MCU
		HCJ41914M						
800 A		HCJ36918MP						
<b>HCP-SU <sup>[9]</sup> Universal Single Row Main Lugs or Main Circuit Breaker <sup>[8]</sup></b> 3-pole—Suitable for use as service equipment when provided with a main circuit breaker and service barrier kit. <sup>[6]</sup> For main circuit breaker panel, order plug-on I-Line type PG, PJ, PL, MG, or MJ circuit breakers from page 9-61 through page 9-63 and backfeed as the main breaker (order solid neutral from page 9-51).								
54	800	HCP54868SU	HC2686T(J)4P	HC2686T() HR <sup>[10]</sup>	HC2686DB	HC2886WP	86	

[2] PG, PJ, PL circuit breakers are available with both thermal-magnetic equivalent and MicroLogic trip. The MicroLogic circuit breakers are available 80% and 100% rated. "C" suffix denotes a 100% rating.  
 [3] Add "F" for flush mount, "S" for surface mount.  
 [4] For Type 1 applications, order interior, front, and box. For Type 3R/5/12 applications, order interior and box only. The front is included with the box.  
 [5] Remove drain screws for Type 3R rating.  
 [6] Suitable for use as service equipment if equipped with an integral main circuit breaker or when not more than six main disconnecting means are provided and the panelboard is not used as a lighting and appliance branch circuit panelboard. (Not applicable in Canada)  
 [7] Bottom feed standard.  
 [8] Circuit breaker interrupt ratings, see *Interrupting Ratings Codes (kA)*, page 9-58.  
 [9] For main lugs panel, order sub-feed lug kit and back-feed as main lugs.  
 [10] Hinged trim with door.

**TYPE HCP**

800 A max. branch circuit breaker  
BD, BG, BJ, QB, QD, QG, QJ, HD, HG, HJ, HL, HR, JD<sup>[11]</sup>, JG, JJ, JL, JR, LA, LH, LJ, LL, LR, MG, MJ, PG, PJ, PL, PGC, PJC, PLC<sup>[12]</sup>

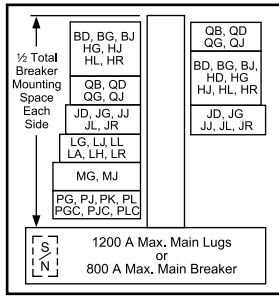

Box Size:  
42 in. Wide, 9.5 in. Deep, NEMA Type 1

**TYPE HCR-U Universal Mains**

1200 A max. branch circuit breaker  
BD, BG, BJ, QB, QD, QG, QJ, HD, HG, HJ, HL, HR, JD<sup>[13]</sup>, JG, JJ, JL, JR, LA, LH, LJ, LL, LR, MG, MJ, PG, PJ, PK, PL, RG, RJ, RK, RL, RGC, RJC, RLC<sup>[14][12]</sup>

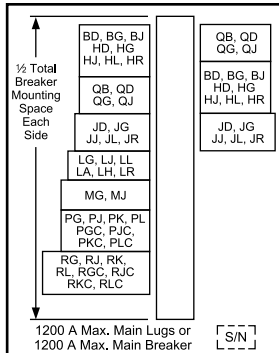

Box Size:  
44 in. Wide, 9.5 in. Deep, NEMA Type 1

**Table 9.106: (1200 A Interiors Include solid neutral, all others without solid neutral)**

Total Circuit Breaker Mtg. Space (In.)	Mains Amp. Rating	Max. No. of MJ, PL, RL Circuit Breakers	Interior Assembly (Less Branch Circuit Breakers) Catalog Number	Front [16]		Box [17] Catalog Number	Box Height (In.)
				4 Piece Trim Without Door [18] Catalog Number	Trim With Door Catalog Number		
<b>HCP Main Lugs Only—3-pole</b> Suitable for use as service equipment when provided with a main circuit breaker and service barrier kit. [19]							
27	400	1PL	HCP14504	HCW50T()	HCW50T(JD)	HC4250-DB	50
	600		HCP14506				
	800		HCP14508				
	1200		HCP145012N				
45	400	2PL	HCP23594	HCW59T()	HCW59T(JD)	HC4259-DB	59
	600		HCP23596				
	800		HCP23598				
	1200		HCP235912N				
63	400	3PL	HCP32684	HCW68T()	HCW68T(JD)	HC4268-DB	68
	600		HCP32686				
	800		HCP32688				
	1200		HCP326812N				
99	400	5PL	HCP50864	HCW86T()	HCW86T(JD)	HC4286-DB	86
	600		HCP50866				
	800		HCP50868				
	1200		HCP508612N				
<b>HCP Main Circuit Breaker [20]—Includes 3-pole</b> Vertically mounted main circuit breaker—Suitable for use as service equipment with service barrier kit. [19]							
36	600	2LC	HCP18686M	HCW68T()	HCW68T(JD)	HC4268-DB	68
	800		HCP18688M				
72	600	4LC	HCP36866M	HCW86T()	HCW86T(JD)	HC4286-DB	86
	800		HCP36868M				
<b>HCR-U Universal Main Lugs or Main Circuit Breaker [21]—3-pole</b> Suitable for use as service equipment when provided with a main circuit breaker and service barrier kit. [19] For Main Lugs panel, order sub-feed lug kit catalog number S33930 and back feed as main lugs. For Main Circuit Breaker panel, order plug-on I-Line type PG, PJ, PL, RGC, RJC, or RLC [21] circuit breakers from page 9-63 and page 9-64, and back feed as the main circuit breaker. (Order solid neutral separately)							
108 [22]	1200	6PL or 3RLC	HCR548612U	HCR86T() [23]	HCR86T(JD)	HC4486-DB	86

**Table 9.107: Main Circuit Breaker Interiors —Standard Frame Types [20]**

Main Circuit Breaker Ampacity	Panelboard Type	Factory Supplied Main Circuit Breaker
400	HCJ	LAP36400MB
600 or 800	HCJ, HCP	MGP36600 or MGP36800

**Table 9.108: Standard Copper Bus Interiors**

Type	Main Ampacity
HCJ, HCP-SU	800
HCP, HCR-U	800 and Above

**NOTE:** Merchandised copper interiors are not available in all ampacities.

**Table 9.109: Circuit Breaker / Sub-feed Lug Kit Mounting Space Requirement**

Type of Circuit Breaker	Maximum Ampacity	No. of Poles	Inch Mounting Requirements	Type of Circuit Breaker	Maximum Ampacity	No. of Poles	Inch Mounting Requirements
BD, BG, BJ	125	1	1.5	JD, JG, JJ, JL, JR, SL250	250	2, 3	4.5
BD, BG, BJ		2	3	LA, LH, SL400	400		6
BD, BG, BJ		3	4.5	LG, LJ, LL, LR	600		6
HD, HG	2	3	Smart Cell	NA	6		
HD, HG	150	3	4.5	MG, MJ, SL800, PGC, PJC, PLC	800		9
HJ, HL, HR		2, 3	4.5	PG, PJ, PL, S33931	1200		9
QB, QD, QG, QJ	225	2	3	RG, RJ, RL, RGC, RJC, RLC, S33930	1200	15	
QB, QD, QG, QJ	225	3	4.5				

[11] JDA circuit breakers with field installable ground fault kits may be mounted in type HCP, HCP-SU, and HCR-U panelboards as shown, and require L-frame mounting space.  
 [12] PG, PJ, and PL circuit breakers are available with both thermal-magnetic equivalent and MicroLogic trip. The MicroLogic circuit breakers are available 80% and 100% rated. "C" suffix denotes a 100% rating.  
 [13] JD circuit breakers with field installable ground fault kits may be mounted in type HCP, HCP-SU, and HCR-U panelboards as shown, and require L-frame mounting space.  
 [14] When RL main circuit breakers with equipment ground fault are applied on a 3Ø4W system, order solid neutral catalog number HCR12SNCT. The HCR12SNCT includes a neutral current transformer.  
 [15] Order solid neutral from page 9-51.  
 [16] Add "F" for flush mount, "S" for surface mount.  
 [17] For 42 in. wide weatherproof enclosures, see Table 9.116 Type 3R/5/12 Enclosures, page 9-52  
 [18] Add-on door kit available. Example: For HCW50TS trim kit, order HCW50D door kit.  
 [19] Suitable for use as service equipment if equipped with an integral main circuit breaker or when not more than six main disconnecting means are provided and the panelboard is not used as a lighting and appliance branch circuit panelboard. (Not applicable in Canada)  
 [20] Circuit breaker interrupt ratings, see Interrupting Ratings Codes (kA), page 9-58.  
 [21] When RL main circuit breakers with equipment ground fault are applied on a 3Ø4W system, order solid neutral catalog number HCR12SNCT. The HCR12SNCT includes a neutral current transformer.  
 [22] 15 in. of mounting space is taken up by the back fed main lug kit or RG, RJ, RL main circuit breaker, leaving 93 in. of branch circuit breaker mounting space.  
 [23] Add-on door kit available. Example: For HCR86TS trim kit, order HCW86D door kit.

**Accessories**



Blank Fillers      Equipment Ground Bar      Solid Neutral

**Table 9.110: I-Line Merchandised Panelboard Accessories**

		Description	Catalog No.
Blank Filler Kit—1.5 in. [24] (One kit contains quantity of 3 blank fillers.)			HNM1BL
Blank Filler Kit—4.5 in. [24] (One kit contains quantity of 5 blank fillers.)			HNM4BL
<b>Solid Neutral Assemblies</b>			
	225 A		HC2SN
	400 A		HC4SN [25], HCW4SN [26]
	600 A		HC6SN [25], HCW6SN [26]
	800 A		HC8SN [25], HCW8SN [26]
			HCPSU8SN [27]
			HCPSU8SNCW [27]
	1200 A		HCW12SN [26]
	1200 A, for use with HCR-U universal panel only		HCWM12SN [28]
	1200 A, including neutral Current Transformer (CT) for 3Ø4W systems		HCR12SNCTW [28]
Equipment Ground Bar Kits—HCJ, HCP, HCP-SU (single row), HCR-U			PK32DGTA
<b>Blank Extensions (For replacement purposes)</b>			
<p>Blank Extensions</p>	1.5 in. for mounting on wide side of I-Line panelboard used with HNM1BL and HNM4BL as a filler plate on the wide side of the panel (HCP, HCP-SU and HCRU). Do not use with MicroLogic trip unit as this filler will cover the trip unit. [24]	HLW1BL (Kit contains quantity of 3.)	
	4.5 in. for mounting on wide side of I-Line panelboard used with HNM1BL and HNM4BL as a filler plate on the wide side of the panel (HCP, HCP-SU and HCRU). Do not use with MicroLogic trip unit as this filler will cover the trip unit. [24]	HLW4BL (Kit contains quantity of 5.)	
	1.5 in. for mounting on narrow side of I-Line panelboard used with HNM1BL and HNM4BL as a filler plate on the narrow side of the panel. Do not use with MicroLogic trip unit as this filler will cover the trip unit. [24]	HLN1BL (Kit contains quantity of 3.)	
	4.5 in. for mounting on narrow side of I-Line panelboard used with HNM1BL and HNM4BL as a filler plate on the narrow side of the panel. Do not use with MicroLogic trip unit as this filler will cover the trip unit. [24]	HLN4BL (Kit contains quantity of 5.)	
	4.5 in. for mounting on wide side of I-Line panelboard. For use with PowerPact H and J circuit breakers mounted on the wide side of the panel so that electronic trip unit can be accessed. [24]	HLW4EBL (Kit contains quantity of 5.)	
	4.5 in. for mounting on narrow side of I-Line panelboard. For use with PowerPact H and J circuit breakers mounted on the narrow side of the panel so that electronic trip unit can be accessed. [24]	HLN4EBL (Kit contains quantity of 5.)	

**Table 9.111: Blank Extensions**

Application	Circuit Breaker Mounting Ht.	Branch Circuit Side	Catalog Number
All applications, except PowerPact H/J with MicroLogic trip unit 3, 5 and 6	1.5 in.	Wide Side	HLW1BL
	4.5 in.		HLW4BL
All applications, except PowerPact H/J with MicroLogic trip unit 3, 5 and 6	1.5 in.	Narrow Side	HLN1BL
	4.5 in.		HLN4BL
Only PowerPact H/J circuit breakers with MicroLogic trip unit 3, 5 and 6	4.5 in.	Narrow Side	HLN4EBL
Only PowerPact H/J circuit breakers with MicroLogic trip unit 3, 5 and 6	4.5 in.	Wide Side	HLW4EBL

[24] Blank extension and blank filler pricing is per kit. See note on kit number for number included in each kit.

[25] Used on Type HCJ.

[26] Used on 400 A, 600 A, 800 A, and 1200 A HCP (main lugs), and 600 A and 800 A (main circuit breaker).

[27] Used on Type HCP-SU (single row).

[28] Used on Type HCR-U.



**Table 9.112: UL Service Entrance Barriers for I-Line Panelboards with Backfeed Main Circuit Breaker<sup>[29]</sup>**

I-Line Panelboard Type	Backfeed Main Circuit Breaker	Catalog Number <sup>[30]</sup>
HCJ	H, J	ILBFMHCHJULC
HCP	H, J	ILBFMHCPHJULC
	LA, LH, PowerPact L	ILBFMHCPPLULC
HCR	M, P	ILBFMHCPMPULC
	LA, LH, PowerPact L	ILBFMHCRPLULC
	M	ILBFMHCRMULC
	P	ILBFMHCRPULC
	R	ILBFMHCRRLUC

(NOTE: Barriers are required by 2017 version of NFPA70—National Electric Code. Both the 2017 UL67 and 2017 NFPA70 allow an exception for service entrance panelboards with more than one disconnect.)

**Table 9.113: UL Service Entrance Barrier Kits for I-Line Vertical Mounted Mains<sup>[29]</sup>**

Main Circuit Breaker	Determining Factors	Catalog Number <sup>[30]</sup>
MG, MJ	4 wires per phase (for breakers with AL1200P24K or CU1200P24K lug kit)	ILMLC4W
	3 wires per phase (for breakers with AL80023K or CU80023K lug kit)	ILMLC3W
	2 wires per phase (for breakers with AL800P6K or AL800P7K lug kit)	ILMLC2W
PowerPact L	All instances	PPLLC
LA/LH	All instances	LALLC

(NOTE: Barriers are required by 2017 version of NFPA70—National Electric Code)

**Table 9.114: Solid Neutral Lug Quantities and Sizes**

Solid Neutral Assembly	Terminal Wire Range
HC2SN	(1) 6 - 300, (9) #1/0 - 14, (45) #4 - 14
HC4SN	(7) 6 - 350, (45) #4 - 14
HC6SN	(7) 6 - 350, (9) #1/0 - 14, (28) #4 - 14
HC8SN	(7) 6 - 350, (9) #1/0 - 14, (34) #4 - 14
HCPSU8SN	(4) 3/0 - 600, (7) 6 - 350, (9) #1/0 - 14, (34) #4 - 14,
HCW4SN	(2) 4 - 600, (7) 6 - 350, (45) #4 - 14
HCW6SN	(4) 3/0 - 750, (7) 6 - 350, (9) #1/0 - 14, (34) #4 - 14
HCW8SN	(4) 3/0 - 750, (7) 6 - 350, (9) #1/0 - 14, (34) #4 - 14
HCW12SN	(4) 3/0 - 750, (7) 6 - 350, (9) #1/0 - 14, (34) #4 - 14
HCWM12SN	(4) 3/0 - 750, (7) 6 - 350, (9) #1/0 - 14, (34) #4 - 14
HC6SNALCU	(7) 6 - 350, (9) #1/0 - 14, (28) #4 - 14
HC8SNALCU	(7) 6 - 350, (9) #1/0 - 14, (34) #4 - 14
HCPSU8SNALCU	(4) 3/0 - 600, (7) 6 - 350, (9) #1/0 - 14, (34) #4 - 14
HCP4SNALCU	(2) 4 - 600, (7) 6 - 350, (45) #4 - 14
HCP6SNALCU	(4) 3/0 - 750, (7) 6 - 350, (9) #1/0 - 14, (34) #4 - 14
HCP8SNALCU	(4) 3/0 - 750, (7) 6 - 350, (9) #1/0 - 14, (34) #4 - 14
HCP12SNALCU	(4) 3/0 - 750, (7) 6 - 350, (9) #1/0 - 14, (34) #4 - 14
HCR12SNALCU	(4) 3/0 - 750, (7) 6 - 350, (9) #1/0 - 14, (34) #4 - 14
HC6SNCU	(7) 6 - 350, (9) #1/0 - 14, (28) #4 - 14
HC8SNCU	(7) 6 - 350, (9) #1/0 - 14, (28) #4 - 14
HCPSU8SNCU	(4) 3/0 - 600, (7) 6 - 350, (9) #1/0 - 14, (28) #4 - 14,
HCW4SNCU	(2) 2 - 600, (7) 6 - 350, (9) #1/0 - 14, (28) #4 - 14
HCW6SNCU	(2) 2 - 600, (7) 6 - 350, (9) #1/0 - 14, (28) #4 - 14
HCW8SNCU	(4) 3/0 - 750, (7) 6 - 350, (9) #1/0 - 14, (28) #4 - 14
HCP12SNCU	(4) 3/0 - 750, (7) 6 - 350, (9) #1/0 - 14, (28) #4 - 14
HCW12SNCU	(7) 6 - 350, (9) #1/0 - 14, (28) #4 - 14
HCR12SNCU	(4) 3/0 - 750, (7) 6 - 350, (9) #1/0 - 14, (28) #4 - 14
HCR2SNCTW	(7) 6 - 350, (9) #1/0 - 14, (34) #4 - 14
HCR2SNCTWALCU	(7) 6 - 350, (9) #1/0 - 14, (34) #4 - 14
HCR2SNCTWCU	(7) 6 - 350, (9) #1/0 - 14, (28) #4 - 14
HCR12SNCTW	(7) 6 - 350, (9) #1/0 - 14, (34) #4 - 14
HCR12SNCTWALCU	(7) 6 - 350, (9) #1/0 - 14, (34) #4 - 14
HCR12SNCTWCU	(7) 6 - 350, (9) #1/0 - 14, (28) #4 - 14
HCPSU2SNCTW	(7) 6 - 350, (9) #1/0 - 14, (34) #4 - 14
HCPSU2SNCTWALCU	(7) 6 - 350, (9) #1/0 - 14, (34) #4 - 14
HCPSU2SNCTWCU	(7) 6 - 350, (9) #1/0 - 14, (28) #4 - 14
HCPSU8SNCW	(7) 6 - 350, (9) #1/0 - 14, (28) #4 - 14
HCPSU12SNCTWALCU	(7) 6 - 350, (9) #1/0 - 14, (28) #4 - 14
HCPSU12SNCTWCU	(7) 6 - 350, (9) #1/0 - 14, (28) #4 - 14
HCP16NALCU	(35) 350, (9) #1/0 - 14, (17) #4 - 14
HCR24NALCU	(8) 750, (21) 350, (9) #1/0 - 14, (17) #4 - 14
HCPSU16NALCU	(8) 750, (21) 350, (9) #1/0 - 14, (17) #4 - 14

**Table 9.115: Panelboard Adapter Kits**

Crimp Lug Adapter Kits <sup>[31]</sup>	I-Line Panelboard Type	
	HCJ	HCP, HCR-U <sup>[32]</sup>
400 A	HCM400VCA	HCW400VCA
600 A	HCM600VCA	HCW600VCA
800 A	HCM800VCA	HCW800VCA
1200 A	—	HCW1200VCA

**Table 9.116: Type 3R/5/12 Enclosures**

Catalog Number	Interior Type	Dimensions (in.)		
		H	W	D
HC4250WP	HCP	50	42	12.95
HC4259WP	HCP	59	42	12.95
HC4268WP	HCP	68	42	12.95
HC4286WP	HCP	86	42	12.95
HC4486WP	HCR-U	86	44	14.50

<sup>[29]</sup> For US only.

<sup>[30]</sup> For panelboards manufactured after 1 January 2017.

<sup>[31]</sup> For use with MLO panel, order VCEL lugs separately.

<sup>[32]</sup> Not for use with P- or R-frame circuit breakers or sub-feed kits S33930 or S33931.

**Table 9.117: Box Extensions**

	Catalog Number	Interior Type	Extension
	HC2609DEX (F or S)	HCP-SU	9 in.
	HC3209EX (F or S)	HCJ	9 in.
	HC4212DEX (F or S)	HCP	12 in.
	HC4406DEX (F or S)	HCR-U	6 in.
	HC4412DEX (F or S)	HCR-U	12 in.

**Table 9.118: I-Line/QMB PanelBoard Drip Hood Kits**

The Drip Hoods listed below are intended for use on surface mounted HC and QMB boxes only. Select the appropriate Drip Hood based on Interior Type, Width, and Depth from the following table. The Drip Hoods are designed to fit on the outside of the boxes. The Drip Hood will increase the enclosure rating of the box from Type 1 to Type 2. Reference Instruction Bulletin 80043-401-03.

Catalog Number	Interior Type	Dimensions (In.)	
		Width	Depth
HCT2DH32D9	HCJ	32	9.5
HCT2DH42	HCP	42	9.5
HCT2DH26D9	HCP-SU	26	9.5
HCT2DH47	HCP (L5)	47	9.5
HCT2DH56	HCP (PL)	56	9.5
HCT2DH42D12	HCP (DB)	42	12.5
HCT2DH44	HCR-U	44	9.5
HCT2DH49	HCR-U (L5)	49	9.5
HCT2DH58	HCR-U (PL)	58	9.5
HCT2DH44D12	HCR-U (DB)	44	12.5
QMT2DH38	QMB	38	11.5

1. Box Types noted with (PL) are standard width boxes with an additional 14" Powerlogic extension.
2. Box Types noted with (L5) are standard width boxes with an additional 5" side extension.
3. Box Types noted with (DB) have additional box depth.

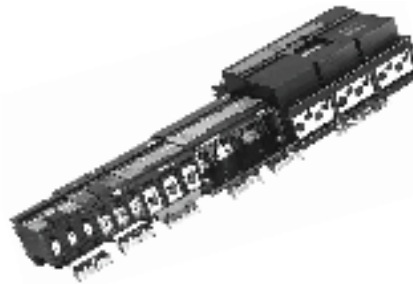

Sub-feed Lug Kits

9  
PANELBOARDS

**Table 9.119: Sub-feed Lug Kits** [33][34][35]

Ampere Rating	Height		Catalog Number	Max. Short Circuit System Ratings RMS Symmetrical Amperes			Protected by Circuit Breaker	For Use in I-Line Panelboard Types
	In.	(mm)		240 Vac	480 Vac	600 Vac		
250 A	4.5	114	SL250	200,000	200,000	100,000	FA, FD, FG, FH, FJ, HD, HG, HJ, HL, HR, JD, JG, JJ, JL, JR, KI	HCJ, HCP, HCP-SU, HCR-U
400 A	6	152	SL400 [35]	200,000	200,000	100,000	HD, HG, HJ, HL, HR, JD, JG, JJ, JL, JR, LA, LH, LG, LJ, LL, LR ("L" & "D" FRAME 400 A MAX.)	HCP, HCP-SU, HCR-U (wide side only)
800 A	9	229	SL800M5	125,000	100,000	25,000	FA, FD, FG, FH, FJ, KA, KH, KC, KI, HD, HG, HJ, HL, HR, JD, JG, JJ, JL, JR, MA, MH, MX, MG, PG, MJ, PJ, PK, PL, DG, DJ, DL, LG, LJ, LL, LR	HCJ, HCP, HCP-SU, HCR-U
1200 A	15	381	S33930	125,000	100,000	50,000	FA, FD, FG, FH, FJ, KA, KH, KC, KI, HD, HG, HJ, HL, HR, JD, JG, JJ, JL, JR, LA, LH, LC, LI, MA, MH, MX, NA, NC, NX, MG, PG, MJ, PJ, PK, PL, RG, RJ, RL, RK, DG, DJ, DL, LG, LJ, LL, LR	HCR-U
1200 A	9	229	SL1200P5, SL1200P6, SL1200P7	125,000	100,000	50,000	FA, FD, FG, FH, FJ, KA, KH, KC, KI, HD, HG, HJ, HL, HR, JD, JG, JJ, JL, JR, MG, PG, MJ, PJ, PK, PL, RG, RJ, RL, RK, DG, DJ, DL, LG, LJ, LL, LR	HCP, HCP-SU, HCR-U

**NOTE:** S33930, S33931, SL1200P5, SL1200P6, SL1200P7, SL Kits are rated 1200 A and may be applied to 1200 ampere loads when installed into HCRU panelboards. However, when installed into HCP and HCPSU panelboards they are only rated 800 amperes maximum due to restricted wire bending space.

**Table 9.120: Sub-feed Lug kit terminal data**

Catalog No. (Prefix)	No. Poles	Ampere Rating	Standard Lug Wire Size [36]
SL100	3	100	#14–1/0 AWG Cu or #12–1/0 AWG Al
SL250	3	250	(1) #4 AWG–300 kcmil
SL400	3	400	(1) #1 AWG–600 kcmil or 2–#1 AWG–250 kcmil
SL800M5	3	800	(3) #3/0 AWG–500 kcmil
S33930	3	1200	(4) #3/0 AWG–600 kcmil
SL1200P5	3	1200	(4) #3/0 AWG–500 kcmil
SL1200P6	3	1200	(3) 350–600 kcmil
SL1200P7	3	1200	(3) #3/0 AWG–750 kcmil

[33] Plug-on in same manner as a branch circuit breaker  
 [34] For other ratings, see the latest edition of I-Line Information Manual, #80043-309-xx.  
 [35] SL400 cannot be used in HCJ panelboards due to inadequate wire bending space.  
 [36] Unless otherwise specified, wire sizes apply to both aluminum and copper conductors.

**PowerPact™ B-frame, Thermal Magnetic**

Accessories are located in Section 7 **PowerPact Accessories**, page .

**Table 9.121: B-frame Interrupting Rating**

	Interrupting Rating			
	D	G	J	K
240 Vac	25 kA	65 kA	100 kA	100 kA
480/277 Vac	18 kA	35 kA	65 kA	65 kA
480 Vac	18 kA	35 kA	65 kA	65 kA
600Y/347 Vac	14 kA	18 kA	25 kA	65 kA
1P 125 Vdc	10 kA	20 kA	50 kA	—
2-3P 250 Vdc	10 kA	20 kA	50 kA	—

**Table 9.122: PowerPact B-frame, 125 A max, Thermal Magnetic UL Circuit Breaker (PowerPact B-frame 1-pole branch circuit breakers utilize 1.5" of I-Line mounting space, 2-pole branch circuit breakers utilize 3" of I-Line mounting space and 3-pole B-frame circuit breakers utilize 4.5" of I-Line mounting space.) Refer to Table 9.124 Phase Options Suffix Numbers for B/Q-frame Circuit Breakers, page 9-56 Example for phase options and suffix information.**

D - SCCR					
	1-pole	2-pole	3-pole	Fixed AC Magnetic Trip	
Amps	277 Vac	480/277 Vac	480/277 Vac	Hold	Trip
15	BDA14015	BDA24015Y	BDA34015Y	400 A	600 A
20	BDA14020	BDA24020Y	BDA34020Y	400 A	600 A
25	BDA14025	BDA24025Y	BDA34025Y	400 A	600 A
30	BDA14030	BDA24030Y	BDA34030Y	400 A	600 A
35	BDA14035	BDA24035Y	BDA34035Y	400 A	600 A
40	BDA14040	BDA24040Y	BDA34040Y	400 A	600 A
45	BDA14045	BDA24045Y	BDA34045Y	400 A	600 A
50	BDA14050	BDA24050Y	BDA34050Y	480 A	720 A
60	BDA14060	BDA24060Y	BDA34060Y	640 A	960 A
70	BDA14070	BDA24070Y	BDA34070Y	640 A	960 A
80	BDA14080	BDA24080Y	BDA34080Y	800 A	1200 A
90	BDA14090	BDA24090Y	BDA34090Y	1000 A	1500 A
100	BDA14100	BDA24100Y	BDA34100Y	1000 A	1500 A
110	BDA14110	BDA24110Y	BDA34110Y	1000 A	1500 A
125	BDA14125	BDA24125Y	BDA34125Y	1000 A	1500 A
G - SCCR					
	1-pole	2-pole	3-pole	Fixed AC Magnetic Trip	
Amps	277 Vac	480/277 Vac	480/277 Vac	Hold	Trip
15	BGA14015	BGA24015Y	BGA34015Y	400 A	600 A
20	BGA14020	BGA24020Y	BGA34020Y	400 A	600 A
25	BGA14025	BGA24025Y	BGA34025Y	400 A	600 A
30	BGA14030	BGA24030Y	BGA34030Y	400 A	600 A
35	BGA14035	BGA24035Y	BGA34035Y	400 A	600 A
40	BGA14040	BGA24040Y	BGA34040Y	400 A	600 A
45	BGA14045	BGA24045Y	BGA34045Y	400 A	600 A
50	BGA14050	BGA24050Y	BGA34050Y	480 A	720 A
60	BGA14060	BGA24060Y	BGA34060Y	640 A	960 A
70	BGA14070	BGA24070Y	BGA34070Y	640 A	960 A
80	BGA14080	BGA24080Y	BGA34080Y	800 A	1200 A
90	BGA14090	BGA24090Y	BGA34090Y	1000 A	1500 A
100	BGA14100	BGA24100Y	BGA34100Y	1000 A	1500 A
110	BGA14110	BGA24110Y	BGA34110Y	1000 A	1500 A
125	BGA14125	BGA24125Y	BGA34125Y	1000 A	1500 A
J - SCCR					
	1-pole	2-pole	3-pole	Fixed AC Magnetic Trip	
Amps	347 Vac	600Y/347 Vac	600Y/347 Vac	Hold	Trip
15	BJA16015	BJA26015	BJA36015	400 A	600 A
20	BJA16020	BJA26020	BJA36020	400 A	600 A
25	BJA16025	BJA26025	BJA36025	400 A	600 A
30	BJA16030	BJA26030	BJA36030	400 A	600 A
35	BJA16035	BJA26035	BJA36035	400 A	600 A
40	BJA16040	BJA26040	BJA36040	400 A	600 A
45	BJA16045	BJA26045	BJA36045	400 A	600 A
50	BJA16050	BJA26050	BJA36050	480 A	720 A
60	BJA16060	BJA26060	BJA36060	640 A	960 A
70	BJA16070	BJA26070	BJA36070	640 A	960 A
80	BJA16080	BJA26080	BJA36080	800 A	1200 A
90	BJA16090	BJA26090	BJA36090	1000 A	1500 A
100	BJA16100	BJA26100	BJA36100	1000 A	1500 A
110	BJA16110	BJA26110	BJA36110	1000 A	1500 A
125	BJA16125	BJA26125	BJA36125	1000 A	1500 A



2-pole, 3 in. (6 mm) Mounting Height



3-pole, 4.5 in. (114 mm) Mounting Height

## I-Line HQO Accessory

For phase option information see [Table 9.124](#).

**Table 9.123: QO™ Distribution Panel—240 Vac Max. Only Mounts in Type HCJ, HCP, HCP-SU, or HCR-U I-Line panelboards, 30 A max. branch circuit breaker.**

Maximum No. 1-pole QO Circuit Breakers	Phase Connection	Mounting Height		2-pole Catalog Number	3-pole Catalog Number
		In.	mm		
6	AB	4.5	114	HQO206AB	—
6	BC	4.5	114	HQO206BC	—
6	AC	4.5	114	HQO206AC	—
6	ABC	4.5	114	—	HQO306
6	CBA	4.5	114	—	HQO306CBA

**Table 9.124: Phase Options Suffix Numbers for B/Q-frame Circuit Breakers**

Phase Option Number	Phase Connection	1-pole	2-pole	3-pole
1	A	BDA140151	—	—
3	B	BDA140153	—	—
5	C	BDA140155	—	—
1	AB	—	QBA220701	—
2	AC	—	QBA220702	—
3	BA	—	QBA220703	—
4	BC	—	QBA220704	—
5	CA	—	QBA220705	—
6	CB	—	QBA220706	—
Standard [37]	ABC	—	—	QBA32070
6	CBA	—	—	QBA320706

[37] The absence of a phase option number after a 3-pole catalog number will result in an ABC phase connection.

**PowerPact Q-frame for I-Line™ Panelboards and Switchboards**

**Table 9.125: PowerPact™ Q-frame— 225 A, Thermal-magnetic (240 Vac)**  
 (PowerPact Q-frame 2-pole branch circuit breakers utilize 3" of I-Line mounting space and 3-pole Q-frame circuit breakers utilize 4.5" of I-Line mounting space.)



QB/QD/QG/QJ  
 Mounting Height  
 2-pole 3 in. [76 mm]  
 3-pole 4.5 in [114 mm]

Ampere Rating	AC Magnetic Trip Settings		"B" Interrupting	"D" Interrupting	"G" Interrupting	"J" Interrupting [38]
	Hold	Trip	Catalog Number	Catalog Number	Catalog Number	Catalog Number
<b>2-pole, 240 Vac [39].</b>						
70 A	1000	1800	QBA22070( )	QDA22070( )	QGA22070( )	QJA22070( )
80 A			QBA22080( )	QDA22080( )	QGA22080( )	QJA22080( )
90 A			QBA22090( )	QDA22090( )	QGA22090( )	QJA22090( )
100 A	1200	2400	QBA22100( )	QDA22100( )	QGA22100( )	QJA22100( )
110 A			QBA22110( )	QDA22110( )	QGA22110( )	QJA22110( )
125 A			QBA22125( )	QDA22125( )	QGA22125( )	QJA22125( )
150 A			QBA22150( )	QDA22150( )	QGA22150( )	QJA22150( )
175 A			QBA22175( )	QDA22175( )	QGA22175( )	QJA22175( )
200 A			QBA22200( )	QDA22200( )	QGA22200( )	QJA22200( )
225 A			QBA22225( )	QDA22225( )	QGA22225( )	QJA22225( )
<b>3-pole, 240 Vac [40]</b>						
70 A	1000	1800	QBA32070( )	QDA32070( )	QGA32070( )	QJA32070( )
80 A			QBA32080( )	QDA32080( )	QGA32080( )	QJA32080( )
90 A			QBA32090( )	QDA32090( )	QGA32090( )	QJA32090( )
100 A	1200	2400	QBA32100( )	QDA32100( )	QGA32100( )	QJA32100( )
110 A			QBA32110( )	QDA32110( )	QGA32110( )	QJA32110( )
125 A			QBA32125( )	QDA32125( )	QGA32125( )	QJA32125( )
150 A			QBA32150( )	QDA32150( )	QGA32150( )	QJA32150( )
175 A			QBA32175( )	QDA32175( )	QGA32175( )	QJA32175( )
200 A			QBA32200( )	QDA32200( )	QGA32200( )	QJA32200( )
225 A			QBA32225( )	QDA32225( )	QGA32225( )	QJA32225( )

See [41] below.

**Table 9.126: Interrupt Ratings (kA)**

	QB	QD	QG	QJ [42]
240 V	10	25	65	100
480 V	—	—	—	—
600 V	—	—	—	—

Padlock attachments for Q-frame are available.

[38] 3P circuit breakers are rated 65 kA at 240/120 Vac, 3Ø, 4-wire delta or 100 kA at 208Y/120 Vac, 3Ø, 4-wire.

[39] 2-pole QB, QD, QG, and QJ circuit breakers are completed by adding the required phasing numbers as indicated in the parentheses, see Table 9.124 on page 9-56

[40] 3-pole QB, QD, QG, and QJ circuit breakers for ABC phasing are complete without additional phasing number. For CBA phasing, complete the catalog number by inserting the number "6" in the parentheses.

[41] Replacement lugs are not available on QB, QD, QG, or QJ circuit breakers. Lugs for QB, QD, QG, or QJ circuit breakers accept one #4 AWG–300 kcmil. No accessories are available for PowerPact Q Frame breakers.

[42] 3P circuit breakers are rated 65 kA at 240/120 Vac, 3Ø, 4-wire delta or 100 kA at 208Y/120 Vac, 3Ø, 4-wire



HD/HG/HJ/HL/HR  
2- and 3-pole Circuit Breaker



JD/JG/JL/JL/JR  
2- and 3-pole  
Thermal-Magnetic Trip Unit

H- and J-frame for I-Line™ Panelboards and Switchboards

Table 9.127: H-frame 150 A Thermal-Magnetic UL Current-Limiting<sup>[43]</sup> Circuit Breakers (600 Vac, 250 Vdc) With Factory Sealed Trip Unit<sup>[44]</sup> Suitable for Reverse Connection<sup>[44]</sup>

(PowerPact HD and HG 2-pole circuit breakers utilize 3" of I-Line mounting space, HJ and HL 2-pole circuit breakers utilize 4.5" of I-Line mounting space, all 3-pole H and J-frame circuit breakers utilize 4.5" of I-Line mounting space.)

Current Rating @ 40° C	Fixed AC Magnetic Trip		Cat. No. <sup>[45]</sup>	Terminal Wire Range
	Hold	Trip		
<b>H-frame, 150A 2P, 600 Vac 50/60 Hz, 250 Vdc<sup>[46]</sup></b>				
15 A	350 A	750 A	H( )A26015( )	AL150HD 14–3/0 AWG Al or Cu
20 A	350 A	750 A	H( )A26020( )	
25 A	350 A	750 A	H( )A26025( )	
30 A	350 A	750 A	H( )A26030( )	
35 A	400 A	850 A	H( )A26035( )	
40 A	400 A	850 A	H( )A26040( )	
45 A	400 A	850 A	H( )A26045( )	
50 A	400 A	850 A	H( )A26050( )	
60 A	800 A	1450 A	H( )A26060( )	
70 A	800 A	1450 A	H( )A26070( )	
80 A	800 A	1450 A	H( )A26080( )	
90 A	800 A	1450 A	H( )A26090( )	
100 A	800 A	1700 A	H( )A26100( )	
110 A	900 A	1700 A	H( )A26110( )	
125 A	900 A	1700 A	H( )A26125( )	
150 A	900 A	1700 A	H( )A26150( )	
<b>H-frame 150A 3P, 600 Vac 50/60 Hz, 250 Vdc</b>				
15 A	350 A	750 A	H( )A36015	AL150HD 14–3/0 AWG Al or Cu
20 A	350 A	750 A	H( )A36020	
25 A	350 A	750 A	H( )A36025	
30 A	350 A	750 A	H( )A36030	
35 A	400 A	850 A	H( )A36035	
40 A	400 A	850 A	H( )A36040	
45 A	400 A	850 A	H( )A36045	
50 A	400 A	850 A	H( )A36050	
60 A	800 A	1450 A	H( )A36060	
70 A	800 A	1450 A	H( )A36070	
80 A	800 A	1450 A	H( )A36080	
90 A	800 A	1450 A	H( )A36090	
100 A	800 A	1700 A	H( )A36100	
110 A	900 A	1700 A	H( )A36110	
125 A	900 A	1700 A	H( )A36125	
150 A	900 A	1700 A	H( )A36150	

Table 9.129: J-frame 250 A Thermal-Magnetic UL Current-Limiting<sup>[47]</sup> Circuit Breakers (600 Vac, 250 Vdc) With Factory Sealed Trip Unit<sup>[44]</sup> Suitable for Reverse Connection<sup>[44]</sup>

(All PowerPact J-frame circuit breakers, both 2- and 3-pole, utilize 4.5" of I-Line mounting space.)

Current Rating @ 40°C	Adjustable AC Magnetic Trip		Cat. No. <sup>[45]</sup>	Terminal Wire Range
	Low	High		
<b>J-frame 250A 2P, 600 Vac 50/60 Hz, 250 Vdc<sup>[48]</sup></b>				
150 A	750 A	1500 A	J( )A26150( )	AL175JD 4–4/0 AWG Al or Cu
175 A	875 A	1750 A	J( )A26175( )	
200 A	1000 A	2000 A	J( )A26200( )	AL250JD 3/0 AWG–350 kcmil Al or Cu
225 A	1125 A	2250 A	J( )A26225( )	
250 A	1250 A	2500 A	J( )A26250( )	
<b>J-frame 250A 3P, 600 Vac 50/60 Hz, 250 Vdc</b>				
150 A	750 A	1500 A	J( )A36150	AL175JD 4–4/0 AWG Al or Cu
175 A	875 A	1750 A	J( )A36175	
200 A	1000 A	2000 A	J( )A36200	AL250JD 3/0 AWG–350 kcmil Al or Cu
225 A	1125 A	2250 A	J( )A36225	
250 A	1250 A	2500 A	J( )A36250	

Table 9.128: Interrupting Ratings Codes (kA)

Voltage	D	G	J	L	R
240 V	25	65	100	125	200
480Y/277	18	35	65	100	200
480 V	18	35	65	100	200
600Y/347	14	18	25	50	100
600 V	14	18	25	50	100

[43] Circuit breakers with J and L interrupting ratings are UL certified as current limiting.

[44] See Supplemental Digest Section 3 for circuit breakers with field-interchangeable trip units.

[45] To complete catalog number, replace the blank with the appropriate interrupting rating (D, G, J, L).

[46] 2 pole circuit breaker catalog numbers are completed by adding the required phase connection number as a suffix see Table 9.136 H/J/L-Frame Circuit Breaker/Switch Phase Options—Example HDA26150( ), page 9-60.

[47] Circuit breakers with J, L, and R interrupting ratings are UL certified as current limiting.

[48] 2 pole circuit breaker catalog numbers are completed by adding the required phase connection number as a suffix see Table 9.136 H/J/L-Frame Circuit Breaker/Switch Phase Options—Example HDA26150( ), page 9-60



HDA36250U33X  
2- and 3-pole  
MicroLogic Electronic Trip Unit



JDA36250U44X  
2- and 3-pole  
MicroLogic Electronic Trip Unit

**Table 9.130: H-frame 150 A and J-frame 250 A MicroLogic Electronic Trip UL Current-Limiting<sup>[49]</sup> Circuit Breakers (600 Vac) With Factory Sealed Trip Unit<sup>[50]</sup> Suitable for Reverse Connection <sup>[51]</sup> (PowerPact Electronic Trip H- and J-frame circuit breakers utilize 4.5" of I-Line mounting space.)**

Electronic Trip Unit			Sensor Rating	Cat. No. <sup>[52]</sup>	Terminal
Type	Function	Trip Unit			
600 Vac, 50/60 Hz, 3P					
MicroLogic Standard	LI	3.2 <sup>[53]</sup>	60 A	H( )A36060U31X	AL150HD <sup>[54]</sup>
			100 A	H( )A36100U31X	
			150 A	H( )A36150U31X	
			250 A	J( )A36250U31X	AL250JD <sup>[55]</sup>
MicroLogic Standard	LSI	3.2S <sup>[53]</sup>	60 A	H( )A36060U33X	AL150HD <sup>[54]</sup>
			100 A	H( )A36100U33X	
			150 A	H( )A36150U33X	
			250 A	J( )A36250U33X	AL250JD <sup>[55]</sup>
MicroLogic Ammeter	LSI	5.2A	60 A	H( )A36060U43X	AL150HD <sup>[54]</sup>
			100 A	H( )A36100U43X	
			150 A	H( )A36150U43X	
			250 A	J( )A36250U43X	AL250JD <sup>[55]</sup>
MicroLogic Energy	LSI	5.2E	60 A	H( )A36060U53X	AL150HD <sup>[54]</sup>
			100 A	H( )A36100U53X	
			150 A	H( )A36150U53X	
			250 A	J( )A36250U53X	AL250JD <sup>[55]</sup>
MicroLogic Ammeter	LSIG	6.2A	60 A	H( )A36060U44X	AL150HD <sup>[54]</sup>
			100 A	H( )A36100U44X	
			150 A	H( )A36150U44X	
			250 A	J( )A36250U44X	AL250JD <sup>[55]</sup>
MicroLogic Energy	LSIG	6.2E	60 A	H( )A36060U54X	AL150HD <sup>[54]</sup>
			100 A	H( )A36100U54X	
			150 A	H( )A36150U54X	
			250 A	J( )A36250U54X	AL250JD <sup>[55]</sup>

**Table 9.131: Interrupting Ratings Codes (kA)**

Voltage	D	G	J	L	R
240 V	25	65	100	125	200
480 V	18	35	65	100	200
600 V	14	18	25	50	100

[49] Circuit breakers with J, L, and R interrupting ratings are UL certified as current limiting.  
 [50] See Supplemental Digest Section 3 for circuit breakers with field-interchangeable trip units.  
 [51] For applications requiring communications, see page 9-68.  
 [52] To complete catalog number, replace the blank with the appropriate interrupting rating (D, G, J, L).  
 [53] 3P circuit breakers with this trip unit can be used for 2P applications.  
 [54] AL150HD wire range is 14–3/0 AWG Al or Cu.  
 [55] AL250JD wire range is 3/0 AWG–350 kcmil Al or Cu. For smaller wire range (4–4/0 AWG Al or Cu), replace the lug's wire binding screws with the larger binding screws provided.



J-frame Mission Critical Circuit Breaker

Table 9.132: J-frame 250 A MicroLogic Electronic Trip Mission Critical Circuit Breakers (480/277 Vac) With Factory Sealed Trip Units Suitable for Reverse Connection<sup>[56]</sup>

Electronic Trip Unit Type	Trip Function	Trip Unit	Continuous Current	D Interrupting	G Interrupting	J Interrupting	L Interrupting	Terminal
				Cat. No.	Cat. No.	Cat. No.	Cat. No.	
Standard	LI	3.2 W	250	JDA34250WU31X	JGA34250WU31X	JJA34250WU31X	JLA34250WU31X	AL250JD <sup>[57]</sup>
Standard	LSI	3.2S-W	250	JDA34250WU33X	JGA34250WU33X	JJA34250WU33X	JLA34250WU33X	AL250JD <sup>[57]</sup>
High Perf. Ammeter	LSI	5.2A-W	250	JDA34250WU43X	JGA34250WU43X	JJA34250WU43X	JLA34250WU43X	AL250JD <sup>[57]</sup>
High Perf. Energy	LSI	5.2E-W	250	JDA34250WU53X	JGA34250WU53X	JJA34250WU53X	JLA34250WU53X	AL250JD <sup>[57]</sup>
High perf. Ammeter	LSIG	6.2A-W	250	JDA34250WU44X	JGA34250WU44X	JJA34250WU44X	JLA34250WU44X	AL250JD <sup>[57]</sup>
High Perf. Energy	LSIG	6.2E-W	250	JDA34250WU54X	JGA34250WU54X	JJA34250WU54X	JLA34250WU54X	AL250JD <sup>[57]</sup>

L-frame Mission Critical Circuit Breaker

Table 9.133: L-frame 600 A MicroLogic Electronic Trip Mission Critical Circuit Breakers (480/277 Vac) With Factory Sealed Trip Units Suitable for Reverse Connection<sup>[56]</sup>

Electronic Trip Unit Type	Trip Function	Trip Unit	Continuous Current	G Interrupting	J Interrupting	L Interrupting	Terminal
				Cat. No.	Cat. No.	Cat. No.	
Standard	LI	3.3 W	250	LGA34250WU31X	LJA34250WU31X	LLA34250WU31X	AL400L61K3 <sup>[58]</sup>
			400	LGA34400WU31X	LJA34400WU31X	LLA34400WU31X	AL600LF52K3 <sup>[59]</sup>
			600	LGA34600WU31X	LJA34600WU31X	LLA34600WU31X	AL600LF52K3 <sup>[59]</sup>
Standard	LSI	3.3S-W	250	LGA34250WU33X	LJA34250WU33X	LLA34250WU33X	AL400L61K3 <sup>[58]</sup>
			400	LGA34400WU33X	LJA34400WU33X	LLA34400WU33X	AL600LF52K3 <sup>[59]</sup>
			600	LGA34600WU33X	LJA34600WU33X	LLA34600WU33X	AL600LF52K3 <sup>[59]</sup>
High Perf. Ammeter	LSI	5.3A-W	400	LGA34400WU43X	LJA34400WU43X	LLA34400WU43X	AL600LF52K3 <sup>[59]</sup>
			600	LGA34600WU43X	LJA34600WU43X	LLA34600WU43X	AL600LF52K3 <sup>[59]</sup>
			400	LGA34400WU53X	LJA34400WU53X	LLA34400WU53X	AL600LF52K3 <sup>[59]</sup>
High Perf. Energy	LSI	5.3E-W	600	LGA34600WU53X	LJA34600WU53X	LLA34600WU53X	AL600LF52K3 <sup>[59]</sup>
			400	LGA34400WU44X	LJA34400WU44X	LLA34400WU44X	AL600LF52K3 <sup>[59]</sup>
High Perf. Ammeter	LSIG	6.3A-W	600	LGA34600WU44X	LJA34600WU44X	LLA34600WU44X	AL600LF52K3 <sup>[59]</sup>
			400	LGA34400WU54X	LJA34400WU54X	LLA34400WU54X	AL600LF52K3 <sup>[59]</sup>
High Perf. Energy	LSIG	6.3E-W	600	LGA34600WU54X	LJA34600WU54X	LLA34600WU54X	AL600LF52K3 <sup>[59]</sup>
			400	LGA34400WU54X	LJA34400WU54X	LLA34400WU54X	AL600LF52K3 <sup>[59]</sup>

Table 9.134: PowerPact™ H-, J-, and L-frame Automatic Molded Case Switches, 600 Vac

Circuit Breaker	Poles	Ampere Rating	G Withstand		L Withstand		R Withstand		Terminal	Wire Range
			Cat. No.	Trip Point	Cat. No.	Trip Point	Cat. No.	Trip Point		
H-frame J-frame	2 <sup>[60]</sup>	150 A	HGA26000S15( )	2250 A	HLA26000S15	2250 A	—	—	—	—
		175 A	JGA26000S17( )	3125 A	JLA26000S17	3125 A	—	—	—	—
		250 A	JGA26000S25( )	3125 A	JLA26000S25	3125 A	—	—	—	—
	3	150 A	HGA36000S15	2250 A	HLA36000S15	2250 A	HRA36000S15	2250 A	AL150HD	14 AWG–3/0 AWG Al/Cu
		175 A	JGA36000S17	3125 A	JLA36000S17	3125 A	JRA36000S17	3125 A	AL175JD	4–4/0 AWG Al/Cu
		250 A	JGA36000S25	3125 A	JLA36000S25	3125 A	JRA36000S25	3125 A	AL250JD	3/0 AWG–350 kcmil Al/Cu
L-frame	3	400 A	LGA36000S40X	4800 A	LLA36000S40X	4800 A	LRA36000S40X	4800 A	AL150HD	AL600L52K3
		600 A	LGA36000S60X	6600 A	LLA36000S60X	6600 A	LRA36000S60X	6600 A	AL250JD	(2) 2/0 AWG–500 kcmil Al/Cu

H-, J-, and L-frame accessories starting on PowerPact Accessories, page  
H-, J-, and L-frame dimensions starting on Molded Case Circuit Breaker Dimensions, page  
H-, J-, and L-frame optional lugs Mechanical Lugs, page

Table 9.135: Interrupting Ratings Codes (kA)

Voltage	D	G	J	L	R
240 V	25	65	100	125	200
480Y/277	18	35	65	100	200
480 V	18	35	65	100	200
600Y/347	14	18	25	50	100
600 V	14	18	25	50	100

Table 9.136: H/J/L-Frame Circuit Breaker/Switch Phase Options—Example HDA26150( )

Phase Option Number	Phase Connection	2-pole	3-pole
1	AB	HDA261501	—
2	AC	HDA261502	—
3	BA	HDA261503	—
4	BC	HDA261504	—
5	CA	HDA261505	—
6	CB	HDA261506	—
Standard	ABC	—	JDA34250WU31X
6	CBA	—	JDA34250WU31X6

[56] Standard rated (80%). Not available in 100% rated.

[57] AL250JD terminal wire range is (1) 3/0 AWG–350 kcmil Al or Cu.

[58] AL400L61K3 terminal wire range is (1) #2 AWG–500 kcmil Al or #2 AWG–600 kcmil Cu..

[59] AL600LF52K3 terminal wire range is (2) #3/0 AWG–500 kcmil Al or Cu.

[60] 2-pole circuit breaker catalog numbers are completed by adding the required phase connection number as a suffix, see Table 9.136 H/J/L-Frame Circuit Breaker/Switch Phase Options—Example HDA26150( ), page 9-60.

**LA/LH-frame Thermal Magnetic Circuit Breakers  
(L-frame circuit breaker utilizes 6" of available I-Line bus)**

**Table 9.137: L-frame—400 A, Thermal-magnetic (600 Vac)**



LA36400 2- and 3-pole Circuit Breaker

Ampere Rating	AC Magnetic Trip Settings		Standard Interrupting	High Interrupting	Terminal Wire Range
	Low	High	Catalog Number	Catalog Number	
<b>2-pole, 600 Vac, 250 Vdc [61]</b>					
125 A	625	1250	LA26125( )	LH26125( )	AL400LA (1) #1 AWG–600 kcmil or (2) #1 AWG–250 kcmil AL or Cu
150 A	750	1500	LA26150( )	LH26150( )	
175 A	875	1750	LA26175( )	LH26175( )	
200 A	1000	2000	LA26200( )	LH26200( )	
225 A	1125	2250	LA26225( )	LH26225( )	
250 A	1250	2500	LA26250( )	LH26250( )	
300 A	1500	3000	LA26300( )	LH26300( )	
350 A	1750	3500	LA26350( )	LH26350( )	
400 A	2000	4000	LA26400( )	LH26400( )	
<b>3-pole, 600 Vac, 250 Vdc</b>					
125 A	625	1250	LA36125	LH36125	AL400LA (1) #1 AWG–600 kcmil or (2) #1 AWG–250 kcmil AL or Cu
150 A	750	1500	LA36150	LH36150	
175 A	875	1750	LA36175	LH36175	
200 A	1000	2000	LA36200	LH36200	
225 A	1125	2250	LA36225	LH36225	
250 A	1250	2500	LA36250	LH36250	
300 A	1500	3000	LA36300	LH36300	
350 A	1750	3500	LA36350	LH36350	
400 A	2000	4000	LA36400	LH36400	

LA accessories starting on Supplemental Digest Section 3, page .

LA dimensions [Molded Case Circuit Breaker Dimensions](#), page

LA optional lugs [page](#) .

**Table 9.138: Interrupt Ratings (kA)**

	LA	LH
240 V	42	65
480 V	30	35
600 V	22	25

**PowerPact L- and M-frame for I-Line™ Panelboards and Switchboards**

**Table 9.139: L-frame 600 A Circuit Breakers with Lugs and Factory-Sealed Electronic Trip Units Suitable for Reverse Connection[62]  
(L-frame circuit breaker utilizes 6" of available I-Line bus)**



PowerPact L-Frame  
LG/LJ/LR  
2- and 3-pole  
4.5 in. (114 mm)

Electronic Trip Unit			Sensor Rating	Catalog Number[63]	Terminal
Type	Function	Trip Unit			
<b>600 Vac, 53/60 Hz, 3P</b>					
MicroLogic Standard	LI	3.3[64]	250 A	L( )A36250U31X	AL400L61K3[65]
			400 A 600 A	L( )A36400U31X L( )A36600U31X	AL600LF52K3[66] (2) 3/0–500 kcmil Al or Cu.
MicroLogic Standard	LSI	3.3S[64]	250 A	L( )A36250U33X	AL400L61K3[65]
			400 A 600 A	L( )A36400U33X L( )A36600U33X	AL600LF52K3 (2) 3/0–500 kcmil Al or Cu.
MicroLogic Ammeter	LSI	5.3A	400 A 600 A	L( )A36400U43X L( )A36600U43X	
MicroLogic Energy	LSI	5.3E	400 A 600 A	L( )A36400U53X L( )A36600U53X	
MicroLogic Ammeter	LSIG	6.3A	400 A 600 A	L( )A36400U44X L( )A36600U44X	
MicroLogic Energy	LSIG	6.3E	400 A 600 A	L( )A36400U54X L( )A36600U54X	

**Table 9.140: Interrupt Ratings Codes (kA) for PowerPact L and M Frames**

	G	J	L [67]	R
240 V	65	100	125	200
480 V	35	65	100	200
600 V	18	25	50	100

[61] 2-pole circuit breaker catalog numbers are completed by adding required phase connection letters as suffix to catalog number. See Table 9.136 H/J/L-Frame Circuit Breaker/Switch Phase Options—Example HDA26150( ), page 9-60.

[62] See Supplemental Digest page 3-4 for circuit breakers with field-interchangeable trip units.

[63] For 100% rated circuit breakers (250 A and 400 A only), add a "C" in the 9th character place (for example, LRA36400CU31X). To complete catalog number, replace the blank with the appropriate interrupting rating (G, J, L or R).

[64] 3P circuit breakers with this trip unit can be used for 2P applications.

[65] AL400L61K3 terminal wire ranges are (1) 2 AWG–600 kcmil Cu or (1) 2 AWG–500 kcmil Al.

[66] AL600LF52K3 terminal wire range is (2) 3/0 –500 kcmil.

[67] L interrupting rating is not available in M-frame.

**Table 9.141: M-Frame 800 A, Basic Electronic Trip System Type ET 1.0<sup>[68]</sup> Factory-Sealed Trip Unit (PowerPact M-frame circuit breakers utilize 9" of the available I-Line bussing.)**

Electronic Trip Unit		Ampere Rating	Adjustable Instantaneous Trip Range		Interrupting Rating		Terminal Wire Range
Type	Function		Low	High	G	J	
<b>2P, 600 Vac 50/60 Hz<sup>[69]</sup></b>							
Basic	Fixed Long-time, Adjustable Instantaneous Trip	400 A	800	4000	MGA26400()	MJA26400()	(3) 3/0 through 500 kcmil Al or Cu
		600 A	1200	6000	MGA26600()	MJA26600()	(3) 3/0 through 500 kcmil Al or Cu
<b>3P, 600 Vac 50/60 Hz</b>							
Basic	Fixed Long-time, Adjustable Instantaneous Trip	400 A	800	4000	MGA36400	MJA36400	(3) 3/0 through 500 kcmil Al or Cu
		600 A	1200	6000	MGA36600	MJA36600	(3) 3/0 through 500 kcmil Al or Cu

**Table 9.142: M-Frame 800 A, Adjustable Amperage Electronic Trip Unit**

Electronic Trip Unit		Adjustable Long-Time Settings	Adjustable Instantaneous		Interrupting Rating		Terminal Wire Range
Type	Function		Low	High	G	J	
<b>2P, 600 Vac 50/60 Hz<sup>[69]</sup></b>							
Basic	Adjustable Long-time, Adjustable Instantaneous Trip	300–800	2x	10x	MGA26800()E10	MJA26800()E10	(3) 3/0 through 500 kcmil Al or Cu
<b>3P, 600 Vac 50/60 Hz</b>							
Basic	Adjustable Long-time, Adjustable Instantaneous Trip	300–800	2x	10x	MGA36800E10	MJA36800E10	(3) 3/0 through 500 kcmil Al or Cu

L-frame accessories, page .  
L-frame dimensions, page .  
L-frame optional lugs, page .

M-frame accessories, page .  
M-frame dimensions, page .  
M-frame optional lugs, page .

**Table 9.143: Automatic Molded Case Switches—600 Vac, 50/60 Hz**

Ampere Rating	2-pole	3-pole	Withstand Rating <sup>[70]</sup>			Trip Point Amperes	Terminal Wire Range
	Catalog Number <sup>[69]</sup>	Catalog Number	240 Vac	480 Vac	600 Vac	AC	
600 A	PJA26000S60( )	PJA36000S60	100	65	25	10000	(3) 3/0 through 500 kcmil Al or Cu
800 A	PJA26000S80( )	PJA36000S80	100	65	25	10000	
1000 A	PJA26000S10( )	PJA36000S10	100	65	25	10000	(4) 3/0 through 500 kcmil Al or Cu
1200 A	PJA26000S12( )	PJA36000S12	100	65	25	10000	

<sup>[68]</sup> The ET 1.0 trip unit cannot be field replaced. The Basic Electronic ET1.0 trip unit (offered in 400 A and 600 A only) does not allow adjustment of the long time trip point setting. It is considered an electronic equivalent of a thermal-magnet circuit breaker.

<sup>[69]</sup> Fill in parentheses with the following phase connection options: (2) for AC or (5) for CA.

<sup>[70]</sup> The withstand rating is the fault current, at rated voltage, that the molded case switch will withstand without damage when protected by a circuit breaker with an equal ampere rating.



PG/PJ/PK/PL  
2- and 3-pole



RG/RJ/RK/RL  
2- and 3-pole

**Table 9.144: PowerPact P- and R-frame Interrupt Ratings Codes**

Voltage	P-frame Interrupt Rating				R-frame Interrupt Rating			
	G	J	K	L	G	J	K	L
240 Vac	65 kA	100 kA	65 kA	125 kA	65 kA	100 kA	65 kA	125 kA
480 Vac	35 kA	65 kA	50 kA	100 kA	35 kA	65 kA	65 kA	100 kA
600 Vac	18 kA	25 kA	50 kA	25 kA	18 kA	25 kA	65 kA	50 kA

**PowerPact P- and R-frame for I-Line™ Panelboards and Switchboards**

**Table 9.145: PowerPact P-frame 1200 A (600 Vac, 50/60 Hz) 3P Circuit Breaker with Electronic Trip Unit (PowerPact P-frame circuit breakers utilize 9" of the available I-Line bussing.)**

Electronic Trip Unit			Sensor Rating	Cat. No. [71][72][73][74]	Terminal Wire Range
Type	Function	Code			
Basic Electronic Trip Unit (Not Interchangeable)	Fixed long-time, Adjustable Instantaneous	ET1.0I	600 A	P( )A36060	(3) 3/0 AWG—500 kcmil Al or Cu AL800M23K
			800 A	P( )A36080	
			1000 A	P( )A36100	(4) 3/0 AWG—500 kcmil Al or Cu AL1200P24K
			1200 A	P( )A36120	
MicroLogic Interchangeable Standard Trip Unit	LI	3.0	250 A	P( )A36025(C)U31A	(3) 3/0 AWG—500 kcmil Al or Cu AL800M23K
			400 A	P( )A36040(C)U31A	
			600 A	P( )A36060(C)U31A	
			800 A	P( )A36080(C)U31A	(4) 3/0 AWG—500 kcmil Al or Cu AL1200P24K
			1000 A	P( )A36100U31A	
			1200 A	P( )A36120U31A	
	LSI	5.0	250 A	P( )A36025(C)U33A	(3) 3/0 AWG—500 kcmil Al or Cu AL800M23K
			400 A	P( )A36040(C)U33A	
			600 A	P( )A36060(C)U33A	
			800 A	P( )A36080(C)U33A	(4) 3/0 AWG—500 kcmil Al or Cu AL1200P24K
			1000 A	P( )A36100U33A	
			1200 A	P( )A36120U33A	
MicroLogic Interchangeable Ammeter Trip Unit	LI	3.0A	250 A	P( )A36025(C)U41A	(3) 3/0 AWG—500 kcmil Al or Cu AL800M23K
			400 A	P( )A36040(C)U41A	
			600 A	P( )A36060(C)U41A	
			800 A	P( )A36080(C)U41A	(4) 3/0 AWG—500 kcmil Al or Cu AL1200P24K
			1000 A	P( )A36100U41A	
			1200 A	P( )A36120U41A	
	LSI	5.0A	250 A	P( )A36025(C)U43A	(3) 3/0 AWG—500 kcmil Al or Cu AL800M23K
			400 A	P( )A36040(C)U43A	
			600 A	P( )A36060(C)U43A	
			800 A	P( )A36080(C)U43A	(4) 3/0 AWG—500 kcmil Al or Cu AL1200P24K
			1000 A	P( )A36100U43A	
			1200 A	P( )A36120U43A	
	LSIG	6.0A	250 A	P( )A36025(C)U44A	(3) 3/0 AWG—500 kcmil Al or Cu AL800M23K
			400 A	P( )A36040(C)U44A	
			600 A	P( )A36060(C)U44A	
			800 A	P( )A36080(C)U44A	(4) 3/0 AWG—500 kcmil Al or Cu AL1200P24K
			1000 A	P( )A36100U44A	
			1200 A	P( )A36120U44A	
MicroLogic Interchangeable Power Trip Unit	LSI	5.0P	250 A	P( )A36025(C)U63AE1	(3) 3/0 AWG—500 kcmil Al or Cu AL800M23K
			400 A	P( )A36040(C)U63AE1	
			600 A	P( )A36060(C)U63AE1	
			800 A	P( )A36080(C)U63AE1	(4) 3/0 AWG—500 kcmil Al or Cu AL1200P24K
			1000 A	P( )A36100U63AE1	
			1200 A	P( )A36120U63AE1	
	LSIG	6.0P	250 A	P( )A36025(C)U64AE1	(3) 3/0 AWG—500 kcmil Al or Cu AL800M23K
			400 A	P( )A36040(C)U64AE1	
			600 A	P( )A36060(C)U64AE1	
			800 A	P( )A36080(C)U64AE1	(4) 3/0 AWG—500 kcmil Al or Cu AL1200P24K
			1000 A	P( )A36100U64AE1	
			1200 A	P( )A36120U64AE1	
MicroLogic Interchangeable Harmonic Trip Unit	LSI	5.0H	250 A	P( )A36025(C)U73AE1	(3) 3/0 AWG—500 kcmil Al or Cu AL800M23K
			400 A	P( )A36040(C)U73AE1	
			600 A	P( )A36060(C)U73AE1	
			800 A	P( )A36080(C)U73AE1	(4) 3/0 AWG—500 kcmil Al or Cu AL1200P24K
			1000 A	P( )A36100U73AE1	
			1200 A	P( )A36120U73AE1	

[71] To complete the catalog number, replace the blank ( ) with the appropriate interrupt rating (G, J, K, or L).

[72] For 100% rated circuit breakers add a "C" in the 9th character place. For example, the catalog number for a 100% standard-type trip unit with LI trip functions at 250 A would be PGA36025CU31A.

[73] The L interrupt rating is supplied in 480 V only. Change the 5th character (voltage rating) from a 6 (600 V) to a 4 (480 V); for example, PLA34025U31A.

[74] See Table 9.144 PowerPact P- and R-frame Interrupt Ratings, page 9-63 for interrupt ratings.

**Table 9.145 PowerPact P-frame 1200 A (600 Vac, 50/60 Hz) 3P Circuit Breaker with Electronic Trip Unit(PowerPact P-frame circuit breakers utilize 9" of the available I-Line bussing.) (cont'd.)**

Electronic Trip Unit			Sensor Rating	Cat. No. [75][76][77][78]	Terminal Wire Range
Type	Function	Code			
	LSIG	6.0H	250 A	P( )A36025(C)U74AE1	(3) 3/0 AWG–500 kcmil Al or Cu AL800M23K
			400 A	P( )A36040(C)U74AE1	
			600 A	P( )A36060(C)U74AE1	
			800 A	P( )A36080(C)U74AE1	(4) 3/0 AWG–500 kcmil Al or Cu AL1200P24K
			1000 A	P( )A36100U74AE1	
			1200 A	P( )A36120U74AE1	

**Table 9.146: PowerPact R-frame 1200 A (600 Vac, 50/60 Hz) 3P Circuit Breaker with Electronic Trip Unit**

Electronic Trip Unit			Sensor Rating	Cat. No. [75][76][77][78]	Terminal Wire Range
Type	Function	Code			
Basic Electronic Trip Unit (Not Interchangeable)	Fixed Long-Time, Adjustable Instantaneous	ET1.01	1200 A	R( )A36120	AL1200R53K (4) 3/0-600 kcmil Al or Cu
MicroLogic Interchangeable Standard Trip Unit	LI	3.0	1000 A	R( )A36100CU31A	
			1200 A	R( )A36120CU31A	
	LSI	5.0	1000 A	R( )A36100CU33A	
			1200 A	R( )A36120CU33A	
MicroLogic Interchangeable Ammeter Trip Unit	LI	3.0A	1000 A	R( )A36100CU41A	
			1200 A	R( )A36120CU41A	
	LSI	5.0A	1000 A	R( )A36100CU43A	
			1200 A	R( )A36120CU43A	
	LSI	6.0A	1000 A	R( )A36100CU44A	
			1200 A	R( )A36120CU44A	
MicroLogic Interchangeable Power Trip Unit	LSI	5.0P	1000 A	R( )A36100CU63AE1	
			1200 A	R( )A36120CU63AE1	
	LSIG	6.0P	1000 A	R( )A36100CU64AE1	
			1200 A	R( )A36120CU64AE1	
MicroLogic Interchangeable Harmonic Trip Unit	LSI	5.0H	1000 A	R( )A36100CU73AE1	
			1200 A	R( )A36120CU73AE1	
	LSIG	6.0H	1000 A	R( )A36100CU74AE1	
			1200 A	R( )A36120CU74AE1	

- P- and R-frame accessories, [page 9-64](#)
- P- and R-frame dimensions, [Molded Case Circuit Breaker Dimensions, page 9-64](#)
- P- and R-frame trip unit options, [MicroLogic™ Electronic Trip Units, page 9-64](#)
- P- and R-frame optional lugs, [Mechanical Lugs, page 9-64](#)
- P- and R-frame alternate rating plugs, [MicroLogic™ Electronic Trip Units, page 9-64](#)

[75] To complete the catalog number, replace the blank ( ) with the appropriate interrupt rating (G, J, K, or L).  
 [76] For 100% rated circuit breakers add a "C" in the 9th character place. For example, the catalog number for a 100% standard-type trip unit with LI trip functions at 250 A would be PGA36025CU31A.  
 [77] The L interrupt rating is supplied in 480 V only. Change the 5th character (voltage rating) from a 6 (600 V) to a 4 (480 V); for example, PLA34025U31A.  
 [78] See [Table 9.144 PowerPact P- and R-frame Interrupt Ratings, page 9-63](#) for interrupt ratings.

**I-Line™ Factory Assembled Panelboards**

**Table 9.147: I-Line 200% Rated Neutral—Standard Terminal Configuration**

Panel Type	Ampacity	Type	Branch Space		Neutral Terminals Quantity and Size		Type 1 Enclosure					
			In.	mm	Main	Branch	H		W		D	
							In.	mm	In.	mm	In.	mm
HCJ	600 A	MLO	72	1829	(8) 750 kcmil	(35) 350 kcmil, (9)#14-1/0, (17)#14-#4	91	2311	32	813	9.50	210
	600 A (MG, MJ)	M/B	72	1829	(8) 750 kcmil		91	2311	32	813	9.50	241
	800 A	MLO	72	1829	(8) 750 kcmil		91	2311	32	813	9.50	210
	800 A (MG, MJ)	M/B	72	1829	(8) 750 kcmil		91	2311	32	813	9.50	241
HCR-U [75]	1200A	M/B, MLO	108	2743	(8) 750 kcmil	(8) 600 kcmil, (15) 350 kcmil (9) #14-1/0, (17)#14-#4	86	2184	44	1118	9.50	241
HCP	600A	M/B, MLO	63	1600	(8) 750 kcmil	(35) 350 kcmil, (9)#14-1/0, (17)#14-#4	68	1727	42	1067	9.50	241
	800A	M/B, MLO	99	2515	(8) 750 kcmil	(35) 350 kcmil, (9)#14-1/0, (17)#14-#4	86	2184	42	1067	9.50	241
HCP-SU [76]	800A	M/B, MLO	54	1371	(8) 750 kcmil	(8) 750 kcmil, (21) 350 kcmil, (9) #14-1/0, (17) #14-#4	86	2184	26	660	9.5	241

[75] 6 in. enclosure extension is required for HCRU I-Line panelboard.  
 [76] 9 in. enclosure extension is required for HCP-SU I-Line panelboard.

Refer to Catalog **4620CT9601**

**For QMB/QMJ Panelboards and Switchboards**

**Table 9.148: QMB Branch Switch Units**

Unit Ampere Rating	Unit Height (In.)	Catalog Number	Class R Fuse Kits		Electrical Interlock Kit Catalog Number [2]	Horsepower Ratings [1]												250 Vdc	
			No. Kits Req'd.	Catalog Number		240 Vac				480 Vac				600 Vac					
					Std.	Max.	1Ø	3Ø	1Ø	3Ø	1Ø	3Ø	1Ø	3Ø	1Ø	3Ø	1Ø		3Ø
<b>2-pole, 240 Vac, 250 Vdc</b>																			
30 A-30 A	4.5	QMB221TW	2	HRK30	QMB300EK (1 or 2)	1.5	3	3	7.5	—	—	—	—	—	—	—	5		
30 A-Blank		QMB221HW [3]				—	—	—	—	—	—	—	—	—	—	—	—	—	5
60 A-60 A		QMB222TW	1	QMB36R	QMB300EK (1 or 2)	3	7.5	10	15	—	—	—	—	—	—	—	10		
60 A-Blank		QMB222HW [3]				—	—	—	—	—	—	—	—	—	—	—	—	—	10
100 A-100 A	6	QMB223TW	1	QMB100R	QMB610EK (1 or 2)	7.5	15	15	30	—	—	—	—	—	—	—	20		
100 A-Blank	QMB223HW [3]	—				—	—	—	—	—	—	—	—	—	—	—	—	20	
200 A	9	QMB224W				HRK1020	QMB200EK (1 or 2)	—	25	15	60	—	—	—	—	—	—	—	40
400 A	15	QMB225W				QMB4060R	—	—	—	—	—	—	—	—	—	—	—	—	—
600 A	9	QMB225WT3 [4]	—	—	—	—	—	—	—	—	—	—	—	—	—	—	—		
Use 3-pole devices for 2-pole application.																			
<b>3-pole, 240 Vac</b>																			
30 A-30 A	4.5	QMB321TW	2	HRK30	QMB300EK (1 or 2)	—	3	—	7.5	—	—	—	—	—	—	—	—		
30 A-Blank		QMB321HW [3]				—	—	—	—	—	—	—	—	—	—	—	—	—	—
60 A-60 A		6	QMB322TW	1	QMB36R	QMB300EK (1 or 2)	—	7.5	—	15	—	—	—	—	—	—	—		
60 A-Blank		QMB322HW [3]	—				—	—	—	—	—	—	—	—	—	—	—	—	—
100 A-100 A	6	QMB323TW	1	QMB100R	QMB610EK (1 or 2)	—	15	—	30	—	—	—	—	—	—	—			
100 A-Blank	QMB323HW [3]	—				—	—	—	—	—	—	—	—	—	—	—	—	—	
200 A	9	QMB324W				HRK1020	QMB200EK (1 or 2)	—	25	—	60	—	—	—	—	—	—	—	
400 A	15	QMB325W				QMB4060R	—	—	—	50	—	125	—	—	—	—	—	—	
600 A	9	QMB325WT3 [4]	—	—	—	—	—	—	—	—	—	—	—	—	—	—			
600 A	15	QMB326W	1	QMB4060R	—	—	—	—	150	—	—	—	—	—	—	—			
800 A		QMB326WT3 [4]	—	—	—	—	—	—	—	—	—	—	—	—	—	—			
800 A		QMB327WT3 [4]	—	—	—	—	—	—	—	—	—	—	—	—	—	—			
<b>2-pole, 600 Vac, 250 Vdc [5]</b>																			
30 A-30 A	4.5	QMB261TW	1	QMB36R	QMB300EK (1 or 2)	1.5	—	3	—	3	5	7.5	15	3	—	10	—		
30 A-Blank		QMB261HW [3]				—	—	—	—	—	—	—	—	—	—	—	—	—	—
60 A-60 A		6	QMB262TW	1	QMB60R	QMB610EK (1 or 2)	3	—	10	—	5	15	20	30	10	—	25		
60 A-Blank		QMB262HW [3]	—				—	—	—	—	—	—	—	—	—	—	—	—	—
100 A-100 A	6	QMB263TW	2	HRK1020	QMB610EK (1 or 2)	7.5	—	15	—	10	25	30	60	15	—	40			
100 A-Blank	QMB263HW [3]	—				—	—	—	—	—	—	—	—	—	—	—	—	—	
200 A	9	QMB264W	1	HRK1020	QMB200EK (1 or 2)	15	—	—	25	50	50	125	30	—	50	—			
400 A	—	—	—	—	—	—	—	—	—	—	—	—	—	—	—	—			
600 A	—	—	—	—	—	—	—	—	—	—	—	—	—	—	—	—			
Use 3-pole devices for 2-pole application.																			
<b>3-pole, 600 Vac, 250 Vdc [5]</b>																			
30 A-30 A	4.5	QMB361TW	1	QMB36R	QMB300EK (1 or 2)	—	3	—	7.5	—	5	—	15	—	7.5	—	20		
30 A-Blank		QMJ361T	—	—		—	—	—	—	—	—	—	—	—	—	—	—	20	
60 A-60 A		6	QMB362TW	1		QMB60R	—	7.5	—	15	—	15	—	30	—	15	—	50	
60 A-Blank		QMJ362T	—				—	—	—	—	—	—	—	—	—	—	—	—	—
100 A-100 A	7.5	QMB363TW	2	HRK1020	QMB610EK (1 or 2)	—	15	—	30	—	25	—	60	—	30	—	75		
100 A-Blank	QMJ363T	—				—	—	—	—	—	—	—	—	—	—	—	—	—	
200 A	9	QMB364W	1	HRK1020		QMB200EK (1 or 2)	—	25	—	60	—	50	—	125	—	60	—		
200 A-200 A	7.5	QMJ364T	—	—		QMB610EK (1 or 2)	—	25	—	60	—	50	—	125	—	60	—		
200 A-Blank	6	QMJ364H [3]	—	—	—	—	—	—	—	—	—	—	—	—	—	—			
400 A [6]	15	QMB365W	1	QMB4060R	—	—	—	—	—	100	—	250	—	125	—	350			
400 A	9	QMJ365	—	—	QMB200EK (1 or 2)	—	50	—	125	—	100	—	250	—	125	—			
400 A [6]		QMB365WT6 [7]	—	—	—	—	—	—	—	—	—	—	—	—	—	—			
600 A [6]	15	QMB366W	1	QMB4060R	—	—	—	—	—	150	—	400	—	250	—	500			
600 A		QMJ366	—	—	—	—	75	—	150	—	—	—	—	—	—	—			
800 A		QMB367W	—	—	—	—	—	—	—	150	—	400	—	250	—	500			

**NOTE:** See the Supplemental Digest for merchandised motor starter units, QMB RTI panelboards, and replacement switches for Series 1–4 and D2 QMB panelboards.

**NOTE:** For series E1 and E2, QMJ switches may be used in 400 A–1200 A interiors in a NEMA 1 without door only. QMJ switches cannot be used in series E1 and E2, 225 A panelboards. QMJ switches cannot be used in NEMA 1 with door or any NEMA 3R/12 enclosure.

[1] Horsepower rating applicable to 480Y/277 V system only.

[2] “1” indicates one normally open and one normally closed contact. “2” indicates two normally open and two normally closed contacts.

[3] Blank units cannot be modified to accept a switch interior.

[4] Use 300 Vac Class T fuses only.

[5] Class J fuse provisions—to field modify switch, move load side fuse base to position indicated in switch. Not available on 100-30, 100-60, or 800 A switch units.

[6] 250 Vdc rating.

[7] Use 600 Vac Class T fuses only.

**Fusible—600 Vac, 250 Vdc**

**Table 9.149: Available QMB Accessories**

Electrical Interlocks		
1 NO and 1NC Electrical Interlocks on Main Switches		
2NO and 2NC Electrical Interlocks on Main Switches		
Equipment Ground Bars		
Standard Ground Bar		
Copper Ground Bar		
Insulated/Isolated Ground Bar		
Name Plates		
Copper Neutral		
Copper Neutral		
125-400A		
600A		
800A		
Enclosure Modifications		
Hinged Trim		
Weatherproof - NEMA 3R		
Lugs		
Mechanical Lugs - Standard		
Copper Mechanical Lugs		
Copper Compression Lugs		
Aluminum Compression Lugs		
VCEL Lugs		
UL Listed Short Circuit Ratings for QMB Starters		
Starter Size	Fusible switch-600V Max. (with Class R or J Fuses) RMS Sym. Amps	Thermal-Magnetic Bircuit Breaker 600V Max. Rms Sym. Amps
0	100,000	5,000
1	100,000	5,000
2	100,000	5,000
3	100,000	5,000

**Common Features**

**QMB Layout Information**

To maximize the quantity of branch switches, use QMJ switches from [page 9-66](#). Class J fuses are available in time delay construction suitable for motor and transformer loads.

**Table 9.150: I-Line™ Panelboard Split Bus Bars**

Ampacity MLO	Additional Mounting Height Required On Split Bus Section [8]	
	Split Bus	
225 A	7.5 in.	
400 A	9 in.	
600 A	12 in.	
800 A	12 in.	
1200 A	18 in.	

**NOTE:** For applications with main circuit breaker panelboards, contact your local Schneider Electric representative or distributor.

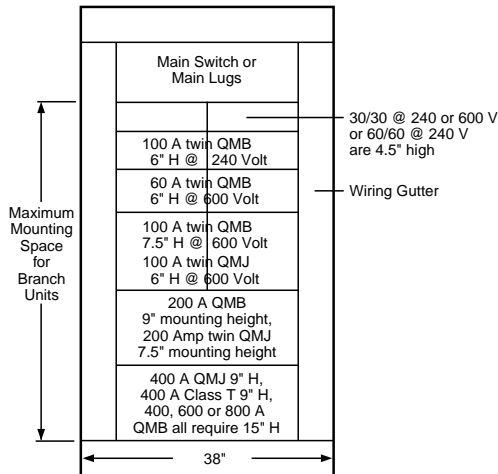

[8] For I-Line panelboards, dimension includes height of "SL" sub-feed lug kit from Digest, plus 3 in. from available branch mounting space.



## Main Circuit Breaker Without Overload Trip (Automatic Molded Case Switch)

- (Not UL Listed)

## Shunt Trip Circuit Breakers

### Special Features

For information on the following special features, please see the Supplemental and Obsolescence Digest.

- Powerlogic™ metering [1]
- Customer equipment space (NQ and NF) [1]
- Increased box depth [1]
- Increased gutters—top, bottom, and sides [1]
- Non-standard paint [1]
- Welded base channel [1]
- Type 1 gasketed [1]
- Type 2 drip hood [1]
- Type 3R/4/4X/5/12 stainless steel enclosure [1]
- Type 4X fiberglass enclosure [1]
- Stainless steel trim front [1]
- Padlockable hasp [1]
- Special locks (Corbin, Yale, Best) [1]
- Equal height boxes [1]
- Common trim to cover two equal height boxes [1]
- Panelboard skirt—hides conduits feeding a panelboard [1]
- Panelboard wireway—for terminating conduit in wireway endwall [1]
- Keyed mechanical interlocking of two or more circuit breakers (I-Line and QMB) [1]
- Motor operators (I-Line only)
- Panelboard interiors and special fronts to fit existing boxes
- A standard panelboard box has one blank endwall and one with knockouts. Blank endwalls or knockouts in both endwalls are also available [1]

### Space-saving I-Line Smart Cell

Space-saving module for value-added digital solutions. The modular Square D I-Line Smart Cell enables value-added solutions in I-Line panelboards in a variety of combinations. The space-saving, self-contained unit fits onto the I-Line bus in place of a breaker, and allows the I-Line panelboard to be transformed into a digital communication or metered electrical distribution solution.

Smart Cells are available for:

- IFE Ethernet Modbus TCP interface with basic Web pages
- IFM Modbus serial interface
- Energy Reduction Maintenance Setting (ERMS)
- Maintenance Mode Switch (MMS)
- EM3560, PM5563 or PM8244 meter with or without communications
- Gateway & Data Logger

The I-Line Smart Cell assemblies are intended for use in HCP, HCP-SU, and HCR-U I-Line panelboards. The I-Line Smart Cell can be included in your Square D I-Line factory-assembled equipment or ordered individually for field installations such as Retrofit or RTI.

For more information refer to Handout ([2700HO1501](#)) or User Guide ([NHA999570](#)).

For SurgeLogic™ I-Line plug-on SPD information, starting on Digest [page](#) .For field-installable I-Line door kits, see the Supplemental and Obsolescence Digest, Section 4.



[1] Supported by the Panelboard Product Selector.

**NQ and NF Terminal Data**

**Table 9.151: NQ Standard Aluminum Mechanical Lugs—Main Lugs**

Panel Type	Ampere Rating	Part Number	Lug Wire Range <sup>[2]</sup>
NQ	100 A	NQALM1	(1) #6-2/0 Al or Cu
	225 A	NQALM2	(1) #6-350 kcmil Al or Cu
	400 A	NQALM4	(1) 1/0-750 kcmil Al or Cu or (2) 1/0-350 kcmil Al or Cu
	600 A	NQALM6	(2) 1/0-750 kcmil Al or Cu
		NQALM6A	(1) 1/0-750 kcmil Al or Cu or (3) 250 kcmil Al-Cu

**Table 9.152: NQ Standard Aluminum Mechanical Lugs—Main Circuit Breaker**

Panel Type	Ampere Rating	Circuit Breaker Type	Lug Wire Range <sup>[3][2]</sup>
NQ	100 A	QOB	(1) #4-#2/0 Al or Cu
	150 A	HD, HG, HJ, HL	(1) #14-#3/0 Al or Cu
	225 A	QB, QD, QG, QJ	(1) #4-300 kcmil Al or Cu
	250 A	JD, JG, JJ, JL	(1) #3/0-350 kcmil Al or Cu <sup>[3]</sup>
	400 A	LA, LH	(1) #1-600 kcmil Al or Cu or (2) #1-250 kcmil Al or Cu
	600 A	LD, LG, LJ, LL	(2) #4/0-500 kcmil Al or Cu

**Table 9.153: NF Standard Mechanical Lugs—Main Lugs**

Panel Type	Ampere Rating	Part Number	Lug Wire Range <sup>[2]</sup>
NF	125 A	NFALM1	(1) #6-2/0 Al or Cu
	250 A	NFALM2	(1) #6-350 kcmil Al or Cu
	400 A	NFALM4	(1) #1/0-750 kcmil or (2) #1/0-350 kcmil Al or Cu
	600 A	NFALM6	(2) 1/0-750 kcmil Al or Cu
	800 A	NFALM8	(3) 1/0-750 kcmil Al or Cu

**Table 9.154: NF Standard Mechanical Lugs—Main Circuit Breaker**

Panel Type	Ampere Rating	Circuit Breaker Type	Lug Wire Range <sup>[3][2]</sup>
NF	125 A	ED, EG, EJ	(1) #14-#2/0 Al or Cu
	150 A	HD, HG, HJ, HL	(1) #14-#3/0 Al or Cu
	250 A	JD, JG, JJ, JL	(1) #3/0-350 kcmil Al or Cu <sup>[3]</sup>
		DJ	(1) #2-600 Cu or #2-500 Al
	400 A	LA, LH	(1) #1-600 kcmil or (2) #1-250 kcmil Al or Cu
	600 A	LD, LG, LJ, LL, LR	(2) #4/0-500 kcmil Al or Cu

**I-Line and QMB/QMJ Terminal Data**

**Table 9.155: Standard Mechanical Lugs—Main Lugs**

Panel Type	Ampere Rating	Wire Range Wire Bending Space per NEC Table 312-6 <sup>[2]</sup>
I-Line	100 A	—
	225 A	(1) #6-300 kcmil Al or Cu
	400 A	(1) #2-600 kcmil Al or Cu
		(2) #2-500 kcmil Al or Cu
	600 A	(2) #2-500 kcmil Al or Cu
	800 A	(3) 3/0-500 kcmil Al or Cu
1200 A	(4) 3/0-500 kcmil Al or Cu	

**Table 9.156: Standard Mechanical Lugs—Main Circuit Breaker**

Panel Type	Ampere Rating	Circuit Breaker Type	Wire Range Wire Bending Space per NEC Table 312-6 <sup>[2]</sup>
I-Line	125 A	BD, BG, BJ	(1) #14-#2/0 AWG Al or Cu
	150 A	HD, HG, HJ, HL	(1) #14-3/0 Al or Cu
	250 A	JD, JG, JJ, JL	(1) #1/0-300 kcmil Al or Cu
	400 A	LA, LH	(1) #1-600 kcmil Al or Cu
	800 A	MG, MJ, PG, PJ, PL	(3) 3/0-500 kcmil Al or Cu
	1200 A	PG, PJ, PL, RGC, RJC, RLC	(4) 3/0-500 kcmil Al or Cu

**Table 9.157: Standard Mechanical Lugs—Main Lugs**

Panel Type	Mains Ampere Rating	Wire Range Wire Bending Space per NEC Table 312-6 <sup>[2]</sup>
QMB	225 A	(1) #6-300 kcmil Al or Cu
	400 A	(1) 3/0-500 kcmil Al or CU and, (1) 3/0-750 kcmil Al or Cu
		(2) 3/0-500 kcmil Al or Cu
	600 A	(2) 3/0-500 kcmil Al or Cu
	800 A	(3) 3/0-500 kcmil Al or Cu or (2) 3/0-750 kcmil Al or Cu
		(4) 3/0-500 kcmil Al or Cu or (4) 3/0-750 kcmil Al or Cu
1600 A	VCEL compression lugs Standard.	

**Table 9.158: Standard Mechanical Lugs—Main Switch**

Panel Type	Mains Ampere Rating	Wire Range Wire Bending Space per NEC Table 312-6 <sup>[2]</sup>
QMB	200 A	(1) #4-300 kcmil Al or Cu
	400 A	(1) 3/0-600 kcmil Al or Cu
	600 A	(2) 3/0-600 kcmil Al or Cu
	800 A	(3) 3/0-500 kcmil Al or Cu

**Table 9.159: Standard Mechanical Lugs—QMB Branch Switch Units**

Panel Type	Switch Ampere Rating	Wire Range Wire Bending Space per NEC Table 312-6 <sup>[2]</sup>
QMB	30 A	(1) #14-#2 Al or Cu
	60 A	(1) #14-#2 Al or Cu
	100 A	(1) #14-1/0 Al or Cu
	200 A	(1) #4-300 kcmil Al or Cu
	400 A	(2) 3/0-500 kcmil Al or Cu
	600 A	(2) 3/0-500 kcmil Al or Cu
	800 A	(3) 3/0-500 kcmil Al or Cu

**Table 9.160: Standard Mechanical Lugs—QMJ Branch Switch Units <sup>[4]</sup>**

Panel Type	Switch Ampere Rating	Wire Range Wire Bending Space per NEC Table 312-6 <sup>[2]</sup>
QMJ	30 A	(1) #14-#2 Al or Cu
	60 A	(1) #14-#2 Al or Cu
	100 A	(1) #14-1/0 Al or Cu
	200 A	(1) #6-300 kcmil Al or Cu
	400 A	(1) 1/0-750 kcmil Al or Cu
	600 A	(2) 3/0-600 kcmil Al or Cu

[2] (#) = Number of conductors per phase.

[3] The lug range shown is for the highest amperage of the circuit breaker frame shown in the table.

[4] Use only 90 °C insulated conductors based on an ampacity of 75 °C conductors.

# Section 10

## Power Solutions Integrated Equipment

<b>Power Solutions Integrated Equipment</b>	<b>10-2</b>
Power Solutions Integrated Equipment Overview	10-2
<b>Energy Control Center</b>	<b>10-4</b>
<b>Modular Panelboard System and Integrated Power Center</b>	<b>10-6</b>
Modular Panelboard System	10-6
Integrated Power Center	10-6
<b>Integrated Power Center 2 (IPC2™)</b>	<b>10-7</b>
Standby Power Connection Solutions	10-7
Submetering Integrated Power Center	10-7
Integrated Power Center 2	10-8
Integrated Power Center 2 Transformer Combo	10-8



MPS



IPC



IPC2

## Power Solutions Integrated Equipment Overview

For over 30 years, the Schneider Electric Power Solutions business has been providing integrated equipment solutions for retail construction, commercial, and industrial projects. The Square D™ brand family of integrated equipment combines electrical distribution, building controls, and automation into a single, factory-assembled and pre-wired enclosure/lineup. Our innovative, cost-effective, integrated solutions save valuable floor space, shorten construction cycle times, and reduce installation and material handling costs.

### Modular Panelboard System—Pre-Engineered Solution

The Modular Panelboard System (MPS) is tailored to customer specifications and may include panels and lighting control equipment. Special Powerlink™ lighting control and column-width panel interiors are available. Additional options include power and control cable wiring, contactors, terminal blocks, surge protective devices (SPDs), equipment spaces, and power metering/monitoring solutions. Seismically qualified MPS sections are also available.

Tailored to customer specifications, MPS sections are:

- 86 in. (2184 mm) high,
- 9.5 in. (241 mm) deep, and
- vary in width depending on customer specifications

### Integrated Power Center—Custom-Designed Solution

For more complex applications, the Integrated Power Center (IPC) allows for the integration of a variety of components, including electrical distribution equipment, HVAC controls, lighting controls, power quality and power conditioning products, SPDs, building management systems and power metering/monitoring solutions. As with all Power Solutions Integrated Equipment products, the IPC is designed to meet applicable codes and standards and is available as seismically qualified. Factory-assembled, pre-wired (based on shipping splits), and tested in a controlled environment, IPC sections are:

- 84 in. (2134 mm) high,
- 10.5 in. (267 mm) deep, and
- vary in width depending on customer specifications

### Standby Power Connection Solutions—UL Listed

The new family of Standby Power Connection Solutions are designed, tested, manufactured and listed to the UL standards providing you with a reliable solution to quickly and safely connect to a portable generator for standby power. The SPQ cam-lock (SPQCL) tap box design incorporates cam-lock receptacles for generator connection and the capabilities to be wired back to the standby power disconnect in the electrical distribution equipment. The SPQ lug-lug (SPQTB) tap box provides the capabilities to connect to a portable generator and the generator breaker cables using mechanical lugs in lieu of the cam-lock connectors.

The SPQ Cam-Lock Box is:

- 36 in. (915 mm) high
- 30 in. (762 mm) wide
- 16 in. (407 mm) deep

The SPQ Lug-Lug Box is:

- 36 in. (915 mm) high
- 30 in. (762 mm) wide
- 13 in. (330 mm) deep

### Submetering Integrated Power Center

The Submetering Integrated Power Center (IPC) is an ideal solution for multi-tenant or departmental metering applications within office towers, condominiums, apartment buildings, shopping centers, and other multi-user environments. The Submetering IPC combines the panel with breakers, the PowerLogic EM4800 multi-circuit energy meter and the associated CTs in a factory-assembled and pre-wired solution saving significant space and on-site installation time. Submetering IPC sections are:

- 10.5 in. (267 mm) deep, and
- vary in width and height depending on the application

### Integrated Power Center 2

The newest addition to the family of Integrated Equipment products, the Integrated Power Center 2 (IPC2™) provides maximum flexibility to meet customers' specifications. Features include those found in the IPC and are provided in a free-standing enclosure that can be front and rear aligned when transformers are included. The IPC2 family is available as seismically-qualified. Enclosure options include NEMA 1, NEMA 1 with driphood and NEMA 3R. IPC2 sections are:

- 91.5 in. (2324 mm) high, and
- vary in width and depth depending on customer specifications

**Integrated Power Center 2 Transformer Combo**

Ideally suited for projects having both 480Y/277V and 208Y/120V requirements. Available as a stand-alone solution or can be incorporated into an MPS, IPC or IPC2 lineup. The standard 42" wide x 24" deep footprint will decrease space requirements by 40% or more. A typical IPC2 Transformer Combo includes two panels in the upper cells and a transformer in the bottom cell. Other upper cell options include contactors, individually mounted circuit breakers, ATS's, equipment spaces and power metering/monitoring solutions. The IPC2 Transformer Combo is available as seismically qualified. Enclosure options include NEMA 1, NEMA 1 with driphood and NEMA 3R. IPC2 Transformer Combo sections are:

- 91.5 in. (2324 mm) high, and
- vary in width and depth depending on the transformer kVA

Additional savings are realized on installation, material costs and material handling, as shown in the table below.

**Table 10.1: IPC2 Transformer Combo—Estimated Savings [1]**

	Stick-Built	Transformer Combo	Savings Realized
Estimated Installation Hours	26–32	3–6	23–26
Materials	Associated pipe, wire and fittings	—	Associated pipe, wire and fittings
No. of Pieces Handled	20–30	1	19–29

The IPC2 Transformer Combo has been recognized by the electrical industry by winning the following awards:

- 2006 INNOVATION Award given by the *Electrical Contracting Products* magazine
- 2006 Product of the Year Gold Medal Award given by the *Consulting/Specifying Engineer* magazine

[1] Based on an NF 480 V panel, 75 kVA transformer, NQ 240 V panel installation.

New!

## Energy Control Center

### Prepare your building for the Future of Energy

Energy Control Centers provide a flexible, resilient and scalable way to distribute and control electric power flow between a utility grid, Distributed Energy Resources (DER) and the electric loads at a site.

The Energy Control Center Implements all Three Layers of EcoStruxure



An Energy Control Center with edge control enables Photo Voltaic to operate during an outage by using an alternate anchor resource such as a genset or lithium ion battery storage system.

During an outage, if there is too much Photo Voltaic power, the edge controller will reduce the Photo Voltaic power in order to prevent backfeeding a genset or a storage battery that is already full.

Conversely, if there is not enough power available from a site's DER's, the edge controller will shed load(s) intelligently.

The final layer maximizes the ROI of the DER's deployed at the site.

#### Flexible:

- Works with numerous types and brands of DERs for easier adaptation into an existing building.
- Future ready design – adaptability allows for future facility expansion and integration of additional DERs at a later date.

#### Scalable:

Schneider Electric has Energy Control Center configurations that meet your needs ranging from 800 A through 2500 A.



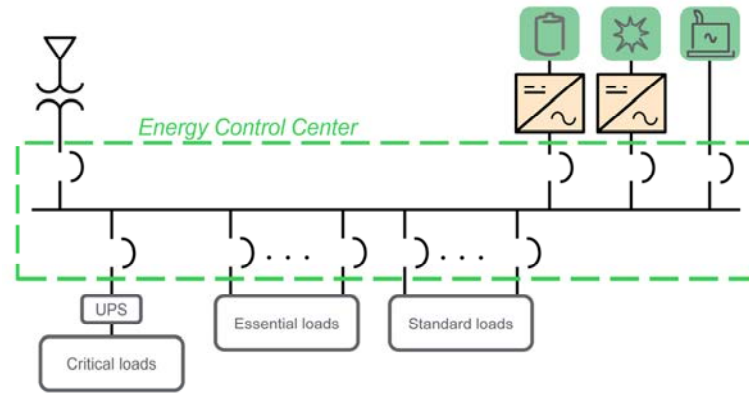

**Technical Features**

- Compatible with any type of distributed energy resource
- Sections rated to 5000 A horizontal bus, 3000 A vertical bus
- Single mains to 5000 A
- Six subdivision mains to 4000 A
- Individually mounted feeders to 4000 A
- Suitable for service entrance or distribution
- NEMA Type 1, NEMA 3R
- Front accessible or front and rear accessible
- 98 in. (2489 mm) high with base channels
- Section widths available: 12 in. (305 mm), 24 in. (610 mm), 30 in. (762 mm), 36 in. (914 mm), 42 in. (1067 mm), 48 in. (1219 mm), or 54 in. (1372 mm) wide
- Frame depths available: 24 in. (610 mm), 36 in. (914 mm), 48 in. (1219 mm), 54 in. (1372 mm), or 60 in. (1524 mm)
- Voltage to 600 Vac or 250 Vdc
- Factory assembled
- Hot or cold sequence utility metering
- Customer metering
- Surge protective devices (SPD)

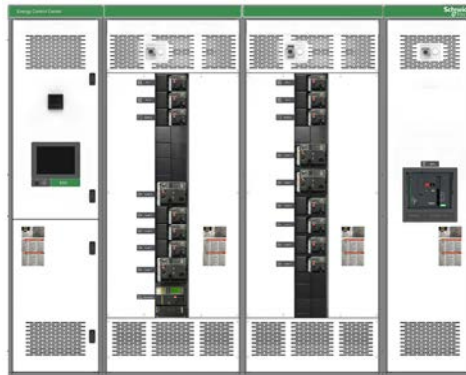



Modular Panelboard System

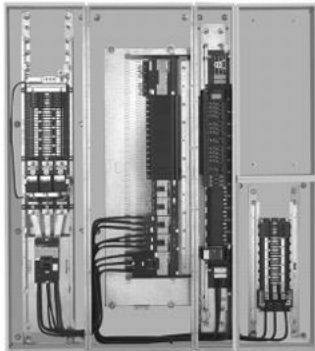

MPS Interior



Integrated Power Center



IPC Interior

### Modular Panelboard System

The pre-engineered Modular Panelboard System (MPS) bundles electrical distribution equipment into a single factory-assembled and wired integrated system. This approach replaces the traditional method of independently mounting each panelboard and lighting control system. MPS allows for the integration of a variety of components including:

- Panelboards: I-Line, NF, NQ, and Column-width
- Surge Suppression: SPD integral to panel and/or separately mounted
- Lighting Controls: Powerlink™ or lighting contactors
- Monitoring/Metering: Powerlogic™ power meters, circuit monitors, branch circuit monitoring, and system display meters

Equipment spaces including factory-installed lighting contactors are available in three configurations:

1. Unwired: Mounted in cell only
2. Line side wired: Line side of each pole is wired to a branch circuit breaker
3. Fully wired: Line side of each pole is wired to a branch circuit breaker, load side of each pole is wired to a terminal block

Built on a panelboard platform, Modular Panelboard System sections are NEMA 1-rated and meet the requirements of UL 67. Individual MPS configurations include panel sections in full-height, stacked or side-by-side arrangements. Individual sections measure:

- 86 in. (2184 mm) high
- 10–44 in. (254–1118 mm) wide
- 9.5 in. (241 mm) deep

Typical applications for MPS equipment include:

- Restaurants / Food service
- Office buildings / Public buildings
- Warehouses
- Schools / Universities

### Integrated Power Center

The custom-designed Integrated Power Center (IPC) combines electrical distribution equipment and building management controls into a single factory-assembled and wired integrated system. IPC has much greater design flexibility for producing a fully customized solution integrating a variety of distribution and control components, including:

- Panelboards: I-Line, NF, NQ, and Column-width
- Surge Suppression: SPD integral to panel and/or separately mounted
- Lighting Controls: Powerlink™ or lighting contactors
- Monitoring/Metering: Powerlogic™ power meters, circuit monitors, branch circuit monitoring, and system display meters
- Power quality and power conditioning
- Building automation
- HVAC controls

Equipment spaces including factory-installed lighting contactors are available in three configurations:

1. Unwired: Mounted in cell only
2. Line side wired: Line side of each pole is wired to a branch circuit breaker
3. Fully wired: Line side of each pole is wired to a branch circuit breaker, load side of each pole is wired to a terminal block

Integrated Power Centers are NEMA 1 rated and meet the requirements of UL 891. As with all integrated solutions, IPCs are shipped to the site fully assembled, completely pre-tested and ready-to-install. Individual IPC configurations include panel sections in full height, stacked, or side-by-side arrangements. IPC sections measure:

- 84 in. (2134 mm) High
- 10.25 (260 mm) Deep
- Widths vary, depending upon customer specifications

Typical applications for IPC equipment include:

- Retail stores / Grocery stores
- Office buildings / Public buildings
- Shopping malls / Strip malls



- Schools/Universities
- Restaurants / Food service
- Hotels/Motels
- Warehouses
- Equipment rooms

**MPS and IPC Layout, Lead Time, and Pricing**

Contact your local Schneider Electric representative or distributor.

**MPS and IPC Shipping**

MPS and IPC lineups are shipped factory-assembled and pre-wired. Customers may specify single- or multiple-section shipping splits (some limitations apply). In addition, lineups may be ordered with or without factory-installed power cables.

**Standby Power Connection Solutions**

The Standby Power Quick-Connect (SPQ) Tap Box provides a reliable solution to quickly and safely connect to a portable standby power generator. Two versions of the SPQ Tap Box have been designed and tested to the required UL standard and offer a wider range of solutions for our customers. All SPQ Tap Boxes are NEMA 3R-rated.

**SPQ Cam-Lock Tap Box**

- UL listed - UL 1008 SB
- NEMA Type 3R enclosure (can be used for NEMA Type 1 installations)
- Lockable door for safety and control access
- Mechanical lugs to standby power disconnect
- Color-coded cam-lock connectors for generator connection
- Hinged bottom access door for cam-lock connection
- Barriers over mechanical lugs for safety
- Application:
  - 400 A and 600 A available
  - 240 V and 480 V versions available
  - Three-phase + neutral + ground

- **SPQCL204RS** – 400 A, 208Y/120 V 3-phase, 4-wire + ground wire
- **SPQCL404RS** – 400 A, 480Y/277 V 3-phase, 4-wire + ground wire
- **SPQCL206RS** – 600 A, 208Y/120 V 3-phase, 4-wire + ground wire
- **SPQCL406RS** – 600 A, 480Y/277 V 3-phase, 4-wire + ground wire



SPQ Cam-Lock Tap Box

**SPQ Lug-Lug Tap Box**

- UL listed—UL 1773 (cUL listed also)
- NEMA Type 3R enclosure (can be used for NEMA Type 1 installations)
- Lockable door for safety and control access
- Mechanical lugs to standby power disconnect
- Generator connection lugs rated for Type W cable
- Application:
  - 400 A and 800 A available
  - 600 V maximum
  - Three-phase + neutral + ground

- **SPQTB604RS** – 400 A, 600 V max. 3-phase, 4-wire + ground wire
- **SPQTB608RS** – 800 A, 600 V max. 3-phase, 4-wire + ground wire



SPQ Lug-Lug Tap Box

**Submetering Integrated Power Center**

The Submetering Integrated Power Center (IPC) is an ideal solution for multi-tenant or departmental metering applications. It combines the ability to meter multiple feeder breakers inside a pre-wired enclosure. The Submetering IPC offers significant space and labor savings by replacing individually enclosed, mounted, and wired panels and metering components and providing an integrated solution in one enclosure/lineup including:

- Panelboards
- PowerLogic™ EM4800 Multi-Circuit Energy Meters and associated CTs
- Surge Suppression
- Factory-installed wiring between components

Submetering IPC width and height dimensions vary depending on the application. All sections are 10.5 in. (266.7 mm) deep.

Typical applications for Submetering IPC equipment include:

- Office towers
- Condominiums
- Apartment buildings
- Shopping centers
- Other multi-user environments
- Configurations with 2-PowerLogic EM4800 meters plus Ethernet switch when required based on the number of metered points



Submetering Integrated Power Center



Integrated Power Center 2

## Integrated Power Center 2

The Integrated Power Center 2 (IPC2™) provides maximum design flexibility. In addition to the features found in the Integrated Power Center (IPC), IPC2 lineups are free-standing enclosures that can be front and rear-aligned. IPC2 has the ability to incorporate:

- Panelboards: I-Line, NF, and NQ
- Transformers: 300 kVA(max)
  - K-rated also available; may limit max kVA size of transformer
- Individually mounted circuit breakers
- Surge Suppression: SPD integral to panel and/or separately mounted
- Automatic Transfer Switch: Open type 400 A 3-pole maximum including a variety of options
- Lighting Controls: Powerlink™ or lighting contactors
- PowerLogic™ Monitoring / Metering: power meters, circuit monitors, branch circuit monitoring, and system display meters
- Building Management Systems

As a stand-alone solution, the IPC2 family provides the flexibility to enter and/or exit the section from either the top or bottom. IPC2 is offered in a variety of widths and depths:

- 24–48 in. (610–1219 mm) Wide
- 24–36 in. (610–915 mm) Deep

Typical applications for IPC2 equipment include:

- |                         |  |
|-------------------------|--|
| • Schools/Universities  | • Casinos                                  |
| • Office buildings      | • Hotels                                   |
| • Data centers          | • Any project with panels and transformers |
| • Industrial facilities |  |

## IPC2 Layout, Lead Time, and Pricing

Contact your local Schneider Electric representative or distributor.

## IPC2 Shipping

IPC2 lineups are shipped fully assembled and ready-to-install. Customers may specify single- or multiple-section shipping splits (some limitations apply). In addition, lineups may be ordered with or without factory-installed power cables.

## Integrated Power Center 2 Transformer Combo

For projects having both 480Y/277 V and 208Y/120 V requirements, the Integrated Power Center 2 (IPC2) Transformer Combo is the perfect solution. One of the most popular members of the IPC2 product family, the IPC2 Transformer Combo has been recognized by the industry multiple times for its innovative design.

As a stand-alone solution, the IPC2 Transformer Combo is appropriate when panelboards and transformers are installed in close proximity to each other. It provides the flexibility to enter and/or exit the section from either the top or the bottom. Catalog numbers have been created for some of the more typical configurations.

All IPC2 sections can be close-coupled to QED switchboard, MPS, and IPC products. Enclosure options for IPC2 include NEMA 1, NEMA 1 with driphood, and NEMA 3R-rated, and all meet the requirements of UL 891. These sections are also seismically qualified to meet IBC and ASCE7 requirements.



IPC2 Transformer Combo

# Section 11

## Switchboards and Switchgear



FlexSet Switchboard



Metalclad and HVL/cc Switchgear



Unit Substation



Model III Package Unit Substation

<b>Low Voltage Switchboards</b>	<b>11-2</b>
FlexSet Switchboards (cULus Listed)	11-2
Power-Style QED-2 Switchboards (UL Listed)	11-7
Power-Style QED-6 Switchboards (UL Listed)	11-8
Power-Style Commercial Multi-Metering Switchboards (UL Listed)	11-10
<b>Speed-D™ Switchboards</b>	<b>11-11</b>
Speed-D SB/SF Switchboards (UL Listed)	11-11
<b>Low Voltage Switchgear</b>	<b>11-15</b>
Power-Zone™ 4 Low Voltage Switchgear with MasterPact™ MTZ or NW/NT Circuit Breakers	11-15
Power-Zone™ 4 Arc Resistant Switchgear with ArcBlok Technology	11-16
Built on the Legendary Performance and Reliability of the MasterPact Line	11-16
<b>Medium Voltage Metal-Enclosed Switchgear</b>	<b>11-17</b>
MiniBreak™ Compact Height Switches— 5.5 kV, 200 A	11-17
Premset Compact Vacuum Circuit Breaker Switchgear with Shielded Solid Insulation System (2SIS)	11-19
HVL/cc Metal-Enclosed Load Interrupter Switchgear—Full Range	11-20
HVL/cc Switchgear Quick Ship Program—5–15 kV, 600 A	11-22
HVL Metal-Enclosed Load Interrupter Switchgear—Full Range	11-27
HVL Switchgear Quick Ship Program—5 kV–15 kV, 600 A	11-28
HVL Switches for Power-Dry II™, Power-Cast II™, and Uni-Cast II™ Transformer Connections	11-29
Square D™ Brand DIN/E Fuse Selection Tables—HVL	11-31
Boric Acid Fuse Selection Tables—HVL	11-32
<b>Medium Voltage Gas-Insulated Switchgear</b>	<b>11-33</b>
GHA Gas-Insulated Switchgear (UL Listed)	11-33
CBGS-0 Gas-Insulated Switchgear (UL Listed)	11-34
DVCAS Switchgear for Wind Farm Applications	11-35
<b>Medium Voltage Metal-Clad Switchgear</b>	<b>11-37</b>
Masterclad™ Medium Voltage Metalclad Switchgear (UL Listed)	11-37
Active, Arc-Resistant Arc Terminator™ Arc Extinguishing System	11-38
Passive, Arc-Resistant Masterclad™ Medium Voltage Switchgear	11-38
<b>Unit Substations</b>	<b>11-39</b>
Power-Zone Load Center Unit Substations	11-39
Power-Zone Model III Package Unit Substations	11-39
<b>MV Controllers</b>	<b>11-42</b>
Motorpact™ Medium Voltage Motor Controllers (UL Listed)	11-42

11 SWITCHBOARDS AND SWITCHGEAR

### FlexSeT Switchboards (cULus Listed)

FlexSeT is a complete low voltage Switchboard offer and service model that enables new methods of assembly, installation, and maintenance, while delivering unprecedented availability, reliability, and modularity. FlexSeT customers will benefit from dramatically reduced lead times with design flexibility through a modern and innovative switchboard system, offering an end-to-end digital experience.

Designed with the entire product lifecycle experience in mind, FlexSeT is a product developed with a fully customer centric approach, making everything simpler and faster from ordering to maintenance without compromising quality or safety, all while ensuring compliance to UL Standards.

FlexSeT is delivered on-time with the shortest lead time in the market! The complete offer can shorten delivery to days instead of weeks. Even with configuration changes at virtually any part of the ordering process. The product modularity allows for adaptations without risks to your project timelines as features are added or removed in the lineup.



### Product Design and Key Features Highlights

Years of leadership in the switchboard market have provided Schneider Electric with the expertise to drive innovation. FlexSeT switchboards are designed to take solutions to a whole new level, making the best switchboards in the market even better.

Designed to be assembled anywhere without the need of heavy machinery or complex tools, FlexSeT is structured to be simple and intuitive, not only for assembly but also for operation and maintenance.

FlexSeT modularity comes in the form of kits and design features that allow for quick and easy installation, removal, or replacement. This makes installation and operation more intuitive and faster with the benefit of improved efficiency.

11 SWITCHBOARDS AND SWITCHGEAR



#### Swingable Main

The main breaker assembly is mounted on a robust hinge system. This feature enables the use of cable pulling machines in the equipment space and exposes the wire terminals for easier and faster connection.

#### Bussing System

The bussing designs deliver reliable connections with quick and easy installation! Visi-tite™ bolts ensure proper torquing while the bus bridge connects all phases simultaneously in one simple operation. The bussing has an enclosed design which greatly reduces the points of exposed bus bars.

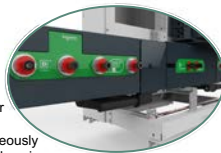

**Backfed Main at 1600 A**  
Main breaker and the I-Line™ stack in one single section to provide unmatched footprint performance.



#### I-Line Bus Stack with Neutral Bar

The I-Line bus stack, which has been benefiting our customers for years, has now gotten even better by having the Neutral within the stack.

#### Captive Hardware

No lost time in removing and replacing covers as the hardware is always in place.

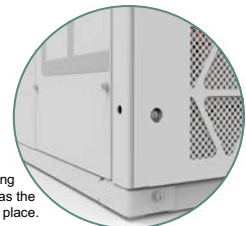

#### Plug-on Neutral

From Panelboards to Switchboards! Land the neutral closer to the load, reducing complexity and making wiring cleaner and more efficient.

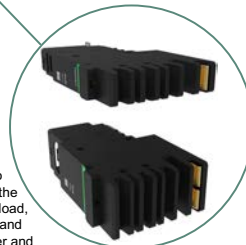

**Digital Journey and Tools**

FlexSeT has taken advantage of the latest digital and end-to-end cyber-secured technology to drive customer satisfaction for the best possible experience throughout the lifecycle.

Digital tools are used in every aspect of the product starting at the quoting and ordering process with **FlexSeT Design™**. The new product selector is intuitive by nature and provides logic and pricing live at each selection, surfacing the right information to make informed decisions

Schneider Electric's **Asset Lifecycle Management™** (ALM) system tracks and stores all documentation for each feature and component of a FlexSeT Switchboard. The documentation specific to each order and configuration is stored digitally, cyber-secured, and is accessible at anytime with a simple QR scan. This information is linked and stored directly from FlexSeTDesign and updated with any change.

The assembly process is executed with **FlexSeT Build™**, an interactive step by step guide for the assembler that help ensure the quality and integrity of the product. The app ensures each assembly step is properly executed from start to finish and inspected for compliance subsequently. Furthermore, FlexSeT Build™ is directly linked and paired with physical assembly tools that ensure proper technical aspects are adhered to, with live verification throughout the assembly. The testing of every section is also completed with FlexSeT Build™ as the last step. A successful result is required in order to generate and apply the UL label of certification. Each FlexSeT section assembled will have a final report with Digital Artifacts and Photos for quality assurance and compliance.

The UL Mark and Certification Labels are issued digitally at the conclusion of each successful assembly. The auditing of an assembled FlexSeT switchboard is done via digital artifacts and critical quality data collected during assembly and quality control process.

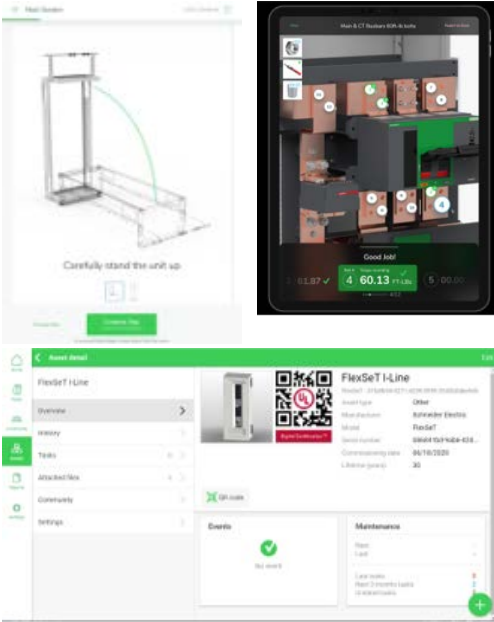

**Features and Specifications Summary**

Just like all Schneider Electric products, FlexSeT is always evolving to bring the best features to market with the latest technology, and will continue to develop and enhance customer solutions, constantly improving the offer!

Here are the latest features for FlexSeT Switchboards:

- Designed, listed, and assembled in accordance with UL 891 Standards
- NEMA 1 enclosure
- All front and side covers use captive hardware
- Front and rear accessible
- Swingable main breaker mounting assembly
- Main breaker ampacities—100% rated up to 65 kA
  - Backfed: 400 A, 600 A, 800 A, 1000 A, 1200 A, 1600 A
  - Individually mounted: 400 A to 2000 A
- All copper system bussing rated for 2000 A, including neutrals
- Plug-on neutral for group mounted devices
- 2000 A I-Line™ feeder section with neutral bar within the stack—feeders from 15 A up to 1200 A
- Splice bridge with extending bussing
- Visi-Tite™ bolts on all torque-required bussing connections
- Swingable instrument compartment—separated and modularized
- Available devices:
  - PowerLogic™ power meter PM5563
  - Surge protective device—rated up to 240 kA
  - Maintenance mode setting (MMS) switch—compliant with NEC 240.87 Arc Energy Reduction requirements
  - SmartCell™ compatible!
- Digital Asset Lifecycle Management—all drawings, test reports, and instruction/ installation manuals are cyber-secured and available online

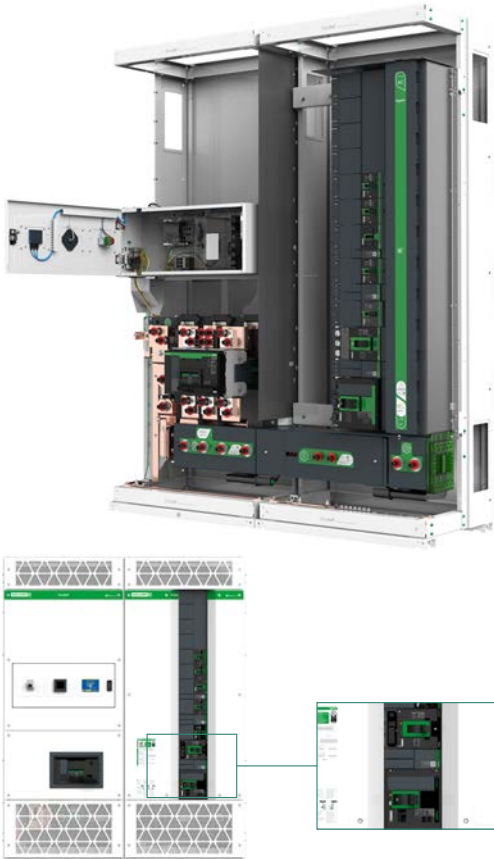

**Partner Support Program**

The Partner Support Program is in place to support and grow our partner business through fast and reliable service using a best-in-class process that is simple and smooth, utilizing a self-help guide. A dedicated Partner Support Program specialist is assigned to each partner with the mission to support, train, and certify partners to build FlexSeT switchboards with the high level of quality and safety standards expected of Schneider Electric products, as well as provide an ongoing, dedicated, direct line of support.



**Customer Care Center and Technical Support**

For any inquiries on FlexSeT and other Schneider Electric products, please contact our customer service and technical support personnel at 1-888-778-2733 anytime. Our support teams can assist with any questions you might have and help you with the solutions you need.

**Catalog of Kits and Parts**

Use the commercial reference numbers listed in the following tables to order new/ replacement kits and parts as needed. The modularity of the FlexSeT Switchboard design makes it easy for the equipment to expand according to our customer needs. Many applications are retrofittable. New functionality can be added by purchasing the kits below and installing on existing installed equipment. Certain spare parts are provided for replacement as needed by the customer.

Please consult Schneider Electric instruction bulletins JYT1078000, FlexSeT Switchboards, or NNZ9919501, FLEXPON 570/1200/1200S Plug-on Neutrals, for references on certain selections, based on application and technical specifications.

**Table 11.1: Field Installable—Individually Mounted Devices (Installed in the Instrument Compartment)**

Kit Description	Application	Maximum Voltage	Catalog No.	Installation Site
Instrument compartment box [1]	Enclosure for MMS/Trip unit, PM 5563, and SPD	600	FLEXINSTRCOMP	Partner/Field
MMS/Trip unit	Incident energy reduction switch; Low/no power circuit breaker trip		FLEXIMAMMS	
Power meter 5563	Power metering and monitoring		FLEXIMAMETER	
208 V SPD	Surge protection	208	FLEXIMA208SPD	Field
480 V SPD		480	FLEXIMA480SPD	
ENCT	Radial ground fault protection 400–2000 A	600	FLEXNCT2000	Field
120 Vac shunt trip [2]	Powerpact M/P/R remote tripping		S33661	
24 Vdc shunt trip [2]			S33659	

**Table 11.2: Field Installable—Group Mounted Devices (Installed on the I-Line Stack)**

Kit Description	Application	Maximum Voltage	Catalog No.	Plug-on Neutral Required	Installation Site
240 V MMS/Trip unit	Incident energy reduction switch; Low/no power circuit breaker trip	240	ICWL22X2BFMMMS	No	Partner/Field
480 V MMS/Trip unit		480	ICWL24X2BFMMMS		
600 V MMS/Trip unit		600	ICWL26X2BFMMMS		
208 V SPD	Surge protection	220	FLEXGRP208SPD	Yes	Field
480 V SPD			FLEXGRP480SPD		
Power meter 5563	Power metering and monitoring	480	FLEXGRPPM5563	No	Field
120 Vac shunt trip [2]	Powerpact M/P/R remote tripping	S33661			
24 Vdc shunt trip [2]		S33659			
1200 A plug-on neutral with sensor [3]	Neutral termination device with LSIG circuit breakers	600	FLEXPON1200S	—	Partner/Field
1200 A plug-on neutral [3]	Neutral termination device		FLEXPON1200		
570 A plug-on neutral [3]			FLEXPON570		

[1] Required for MMS/Trip unit, PM5563, or SPD installation only. An instrument compartment for field installation needs to be ordered with an instrument compartment cover (catalog number 80210-181-50) in the Table 11.4 FlexSeT Spare Parts, page 11-6 table. Not required for ENCT or shunt trip kits.

[2] Shunt trip kits to be shipped from partner to field job site for contractor installation only.

[3] Plug-on neutrals have limited amounts of devices that can be provided. Please consult the FlexSeT PON instruction bulletin (NNZ9919501) to determine the right allocation per circuit breakers and other devices.

### FlexSeT Circuit Breakers—Prewired for MMS and Ground Fault Applications

Please use the following table as a reference-specific circuit breakers. These circuit breakers are PowerPact™ Series with a wire harness pre-installed according to application needs. If MMS, or ground fault protection are needed in main or feeder applications, these circuit breakers must be used. These circuit breakers should not be installed in QED-2 Switchboards.

The I-Line™ feeder section in FlexSeT switchboards is fully compatible with any plug-on circuit breaker used in QED-2 Switchboards. The circuit breakers listed in the table are specific only to applications mentioned above, where a harness is provided for ease of installation.

**Table 11.3: FlexSeT Circuit Breakers**

Description	Application	Mounting Type	Trip Unit	Pre-Wired Harness	Catalog No.
600 V, 1200 A circuit breaker	Main or feeder; MMS and ground fault capable	I-Line Group Mounted	6.0 A (LSIG)	MMS, Trip Unit Power, and ENCT	<a href="#">PJA36100U44AFLEX</a>
600 V, 800 A circuit breaker	Main or feeder; MMS capable	I-Line Group Mounted	5.0 A (LSI)	MMS and Trip Unit Power	<a href="#">PJA36120U43AFLEX</a>
600 V, 1200 A circuit breaker	Main or feeder; MMS and ground fault capable	I-Line Group Mounted	6.0 A (LSIG)	MMS, Trip Unit Power, and ENCT	<a href="#">PJA36120U44AFLEX</a>
600 V, 400 A circuit breaker	Main or feeder; MMS capable	Unit Mount	5.0 A (LSI)	MMS and Trip Unit Power	<a href="#">PJF36040U43AFLEX</a>
600 V, 400 A circuit breaker	Main or feeder; MMS and ground fault capable	Unit Mount	6.0 A (LSIG)	MMS, Trip Unit Power, and ENCT	<a href="#">PJF36040U44AFLEX</a>
600 V, 400 A circuit breaker	Main or feeder; MMS capable	Unit Mount	5.0 A (LSI)	MMS and Trip Unit Power	<a href="#">PJF36040U43AFLEX</a>
600 V, 400 A circuit breaker	Main or feeder; MMS and ground fault capable	Unit Mount	6.0 A (LSIG)	MMS, Trip Unit Power, and ENCT	<a href="#">PJF36040U44AFLEX</a>
600 V, 600 A circuit breaker	Main or feeder; MMS capable	Unit Mount	5.0 A (LSI)	MMS and Trip Unit Power	<a href="#">PJF36060U43AFLEX</a>
600 V, 600 A circuit breaker	Main or feeder; MMS and ground fault capable	Unit Mount	6.0 A (LSIG)	MMS, Trip Unit Power, and ENCT	<a href="#">PJF36060U44AFLEX</a>
600 V, 600 A circuit breaker	Main or feeder; MMS capable	Unit Mount	5.0 A (LSI)	MMS and Trip Unit Power	<a href="#">PJF36060U43AFLEX</a>
600 V, 600 A circuit breaker	Main or feeder; MMS and ground fault capable	Unit Mount	6.0 A (LSIG)	MMS, Trip Unit Power, and ENCT	<a href="#">PJF36060U44AFLEX</a>
600 V, 800 A circuit breaker	Main or feeder; MMS capable	Unit Mount	5.0 A (LSI)	MMS and Trip Unit Power	<a href="#">PJF36080U43AFLEX</a>
600 V, 800 A circuit breaker	Main or feeder; MMS and ground fault capable	Unit Mount	6.0 A (LSIG)	MMS, Trip Unit Power, and ENCT	<a href="#">PJF36080U44AFLEX</a>
600 V, 800 A circuit breaker	Main or feeder; MMS capable	Unit Mount	5.0 A (LSI)	MMS and Trip Unit Power	<a href="#">PJF36080U43AFLEX</a>
600 V, 800 A circuit breaker	Main or Feeder - MMS and Ground Fault Capable	Unit Mount	6.0 A (LSIG)	MMS, Trip Unit Power, and ENCT	<a href="#">PJF36080U44AFLEX</a>
600 V, 1000 A circuit breaker	Main or Feeder - MMS Capable	Unit Mount	5.0 A (LSI)	MMS and Trip Unit Power	<a href="#">PJF36100U43AFLEX</a>
600 V, 1000 A circuit breaker	Main or feeder; MMS and ground fault capable	Unit Mount	6.0 A (LSIG)	MMS, Trip Unit Power, and ENCT	<a href="#">PJF36100U44AFLEX</a>
600 V, 1000 A circuit breaker	Main or feeder; MMS capable	Unit Mount	5.0 A (LSI)	MMS and Trip Unit Power	<a href="#">PJF36100U43AFLEX</a>
600 V, 1000 A circuit breaker	Main or feeder; MMS and ground fault capable	Unit Mount	6.0 A (LSIG)	MMS, Trip Unit Power, and ENCT	<a href="#">PJF36100U44AFLEX</a>
600 V, 1200 A circuit breaker	Main or feeder; MMS capable	Unit Mount	5.0 A (LSI)	MMS and Trip Unit Power	<a href="#">PJF36120U43AFLEX</a>
600 V, 1200 A circuit breaker	Main or feeder; MMS and ground fault capable	Unit Mount	6.0 A (LSIG)	MMS, Trip Unit Power, and ENCT	<a href="#">PJF36120U44AFLEX</a>
600 V, 1200 A circuit breaker	Main or feeder; MMS capable	Unit Mount	5.0 A (LSI)	MMS and Trip Unit Power	<a href="#">PJF36120U43AFLEX</a>
600 V, 1200 A circuit breaker	Main or feeder; MMS and ground fault capable	Unit Mount	6.0 A (LSIG)	MMS, Trip Unit Power, and ENCT	<a href="#">PJF36120U44AFLEX</a>
600 V, 1000 A circuit breaker	Main or feeder; MMS and ground fault capable	I-Line Group Mounted	6.0 A (LISG)	MMS, Trip Unit Power, and ENCT	<a href="#">RKA36100CU44AFLEX</a>
600 V, 1200 A circuit breaker	Main or feeder; MMS capable	I-Line Group Mounted	5.0 A (LSI)	MMS and Trip Unit Power	<a href="#">RKA36120CU43AFLEX</a>
600 V, 1200 A circuit breaker	Main or feeder; MMS and ground fault capable	I-Line Group Mounted	6.0 A (LISG)	MMS, Trip Unit Power, and ENCT	<a href="#">RKA36120CU44AFLEX</a>
600 V, 1000 A circuit breaker	Main or feeder; MMS capable	Unit Mount	5.0 A (LSI)	MMS and Trip Unit Power	<a href="#">RKF36100CU43AFLEX</a>
600 V, 1000 A circuit breaker	Main or feeder; MMS and ground fault capable	Unit Mount	6.0 A (LISG)	MMS, Trip Unit Power, and ENCT	<a href="#">RKF36100CU44AFLEX</a>
600 V, 1200 A circuit breaker	Main or feeder; MMS capable	Unit Mount	5.0 A (LSI)	MMS and Trip Unit Power	<a href="#">RKF36120CU43AFLEX</a>
600 V, 1200 A circuit breaker	Main or feeder; MMS and ground fault capable	Unit Mount	6.0 A (LISG)	MMS, Trip Unit Power, and ENCT	<a href="#">RKF36120CU44AFLEX</a>
600 V, 1200 A circuit breaker	Main or feeder; MMS capable	Unit Mount	5.0 A (LSI)	MMS and Trip Unit Power	<a href="#">RKF36120U43AFLEX</a>
600 V, 1200 A circuit breaker	Main or feeder; MMS and ground fault capable	Unit Mount	6.0 A (LISG)	MMS, Trip Unit Power, and ENCT	<a href="#">RKF36120U44AFLEX</a>
600 V, 1600 A circuit breaker	Main or feeder; MMS capable	Unit Mount	5.0 A (LSI)	MMS and Trip Unit Power	<a href="#">RKF36160CU43AFLEX</a>
600 V, 1600 A circuit breaker	Main or feeder; MMS and ground fault capable	Unit Mount	6.0 A (LISG)	MMS, Trip Unit Power, and ENCT	<a href="#">RKF36160CU44AFLEX</a>
600 V, 1600 A circuit breaker	Main or feeder; MMS capable	Unit Mount	5.0 A (LSI)	MMS and Trip Unit Power	<a href="#">RKF36160U43AFLEX</a>
600 V, 1600 A circuit breaker	Main or feeder; MMS and ground fault capable	Unit Mount	6.0 A (LISG)	MMS, Trip Unit Power, and ENCT	<a href="#">RKF36160U44AFLEX</a>
600 V, 2000 A circuit breaker	Main or feeder; MMS capable	Unit Mount	5.0 A (LSI)	MMS and Trip Unit Power	<a href="#">RKF36200CU43AFLEX</a>
600 V, 2000 A circuit breaker	Main or feeder; MMS and ground fault capable	Unit Mount	6.0 A (LISG)	MMS, Trip Unit Power, and ENCT	<a href="#">RKF36200CU44AFLEX</a>
600 V, 2000 A circuit breaker	Main or feeder; MMS capable	Unit Mount	5.0 A (LSI)	MMS and Trip Unit Power	<a href="#">RKF36200U43AFLEX</a>
600 V, 2000 A circuit breaker	Main or feeder; MMS and ground fault capable	Unit Mount	6.0 A (LISG)	MMS, Trip Unit Power, and ENCT	<a href="#">RKF36200U44AFLEX</a>
600 V, 2500 A circuit breaker	Main or feeder; MMS capable	Unit Mount	5.0 A (LSI)	MMS and Trip Unit Power	<a href="#">RKF36250U43AFLEX</a>
600 V, 2500 A circuit breaker	Main or feeder; MMS and ground fault capable	Unit Mount	6.0 A (LISG)	MMS, Trip Unit Power, and ENCT	<a href="#">RKF36250U44AFLEX</a>

**Spare Parts**

These kits can be ordered for replacing parts, as necessary. The following table lists commercial kits for parts sold in individual or paired quantities. These kits can be ordered for replacing parts, as necessary. If a needed part or hardware is not listed, please contact Customer Service or the Partner Support Program Team.

**Table 11.4: FlexSeT Spare Parts**

Description	Catalog No.	Parts List
Instrument compartment front cover assembly	80210-181-50	—
Deadfront covers	80210-219-50	80210-070-50
		80210-071-50
Barriers	80210-219-51	80211-011-01
		80211-015-01
Vented covers	80210-219-52	80210-072-50
		80210-073-50
Bracing	80210-219-53	2 x 80210-080-50
		2 x 80210-020-50
Rear corner channel	80210-219-54	2 x 80210-013-01
Front corner channel	80210-219-55	2 x 80210-095-50
Escutcheon package	80210-219-57	2 x 80210-020-51
RCC main package	80210-219-58	2 x 80210-010-01
Rodent Barrier	80210-219-59	2 x 80210-003-01
Access cover	80210-219-60	80210-074-50
Base assembly with rivets	80210-074-50	80210-087-50
Frame with ground bus	80210-087-50	80210-087-51
Frame with ground bus and lugs	80210-087-51	—
1600 A MCCB backed bus bar assembly	80210-090-50	—





Shown is 2000 A, QED-2 Switchboard with 63 in. of Branch Circuit Breaker Mounting Height Available

**NOTE:** A single-row, I-Line distribution section is shown on the right side of the switchboard photo above, while a double-row, I-Line distribution section is shown in the drawing below.

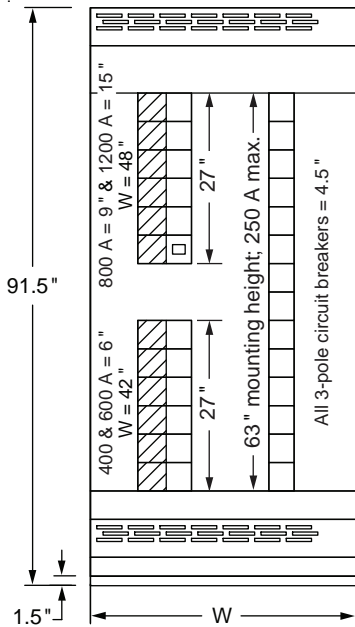

W	Max. Circuit Breaker Size
36"	250 A
42"	600 A
48"	1200 A

**Power-Style QED-2 Switchboards (UL Listed)**

For solutions that bring people, products, and information together, Square D™ brand Power-Style QED-2 low voltage switchboards from Schneider Electric are built to last and feature design innovations that make these products easier to install and maintain. Supported by one of the largest distributor, sales, and service organizations in the industry, QED-2 switchboards are readily available to meet the needs of contractors, consultants, and end-users.

**Q = Quality—Built to Last**

As one of the most trusted names in electrical distribution, Square D™ brand QED-2 switchboards are designed with the highest standards of quality. From sturdy frames, securely fastened thread-forming screws, and standard bolted, base channels, users will see the difference during installation, operation, maintenance, and expansion projects.

**E = Efficient and Innovative Designs**

In 2010, Schneider Electric launched QED-2, Series 2 switchboard designs. Series 2 designs represent the next generation of our QED-2 switchboard offering, with new features based on extensive customer feedback. From improved branch neutral and ground bar access, to enhanced instrument compartments, Series 2 designs provide easier access for performing equipment installation and maintenance procedures.

QED-2 switchboards feature Schneider Electric's unique I-Line™ plug-on connections in group-mounted construction. With the I-Line design, a screwdriver is the only tool required to firmly ratchet the line end of a molded-case circuit breaker directly onto the I-Line bus assembly. This plug-on design allows quick installation and mounting flexibility of circuit breakers up to 1200 A.

**D = Delivery—Ready When You Are**

To meet tight project schedules and budgets, our Square D™ brand QED-2 switchboard offering brings together standard designs for the most frequently requested ratings and options, providing immediate pricing for quick shipments from 11 to 30 business days.

**Features**

- QED-2 Switchboards are designed, listed, and built to UL 891
- Several tiered EcoStruxure communication offers available
- Switchboard ratings through 6000 A, 200 kA; higher amperages available
- Front accessible load connections
- Front and rear alignment standard
- Cable, busway, transformer, or remote QED switchboard incoming fed
- Hot or cold sequence utility metering
- **New!** MasterPact MTZ advanced communication stored energy circuit breaker—available in fixed or drawout for individually mounted mains or feeders
- Thermal-magnetic, PowerPact™ electronic, or MasterPact™ NW stored energy fixed or drawout circuit breakers used as mains and feeders
- Group-mounted circuit breaker and fusible switch mains and feeders
- Fixed-mounted fusible switch mains and feeders
- Powerlogic customer metering, including option for custom communications capability and interwiring
- Networked communications capabilities provide direct access to energy management at main and feeder level
- Internally-mounted SurgeLogic™ surge protective devices
- Quick Connect Generator option available
- **New!** **Available in mid-2019:** Expanded stacked breaker designs to optimize overall layout
- Main devices in six sub-division or single main configurations
- Main and branch devices in single section configuration
- Multiple individual devices in single section configurations
- Custom engineering, including main-tie-mains, multiple sets of thru-bus, reduced heights, and engineered houses

**Additional Information:**

See Table 9.109 Circuit Breaker / Sub-feed Lug Kit Mounting Space Requirement, page 9-48 for circuit breaker mounting height requirements.

Where Utility compartments are required, contact your local Schneider Electric representative.

**Power-Style QED-6 Switchboards (UL Listed)**

**MasterPact™ MTZ, NW, NT, and PowerPact™ H and J Circuit Breakers**

The QED-6 switchboard is designed to provide excellent distribution, protection, and power quality management in commercial electrical equipment. The circuit protection components of the switchboard are the MasterPact MTZ2, MTZ3 or NW circuit breakers in 800–6000 A frame sizes, MasterPact MTZ1 or NT circuit breakers in 800–1200 A frame sizes, and PowerPact H and J circuit breakers in 150–250 A frame sizes. These circuit breakers deliver maximum system uptime, system selectivity, ease of maintenance, and reliable circuit protection.

QED-6 switchboard features include: MasterPact MTZ2, MTZ3 or NW UL 489 Listed circuit breakers for main and feeder devices, MasterPact MTZ1 or NT UL 489 Listed circuit breakers for feeder devices, PowerPact H and J UL 489 Listed circuit breakers for feeder devices, and a wide range of designs and options. Highly flexible drawout circuit breakers can meet a wide variety of power distribution requirements. Choices include drawout construction in PowerPact H and J circuit breakers, and optional prepared drawout spaces that are equipped with all specified control functions. This capability allows quick additions for load upgrades.

- QED-6 switchboards are designed, listed, and built to UL 891; MasterPact and PowerPact circuit breakers are designed, listed, and built to UL 489
- Circuit breakers are individually mounted, rear connected; MasterPact MTZ, NW and NT circuit breakers are drawout; PowerPact H and J breakers are drawout
- Family of field installable and upgradeable MicroLogic™ trip units with optional EcoStruxure Power™ data communications features
- Switchboard ratings up to 150 kA short-circuit current rating for services 1600–6000 A at 480 V and 100 kA at 600 V
- Up to (12) 250 A PowerPact H and J circuit breakers in a single 30-inch wide section
- Up to (8) 1200 A frame MasterPact MTZ1/NT circuit breakers in a single 30-inch wide section
- Flexible branch circuit breaker locations: MasterPact and PowerPact circuit breakers can be mixed in a single 30-inch wide section (15–2000 A)
- Compartmentalization: separate compartments for circuit breakers, bussing, and load cabling
- Available in 54-, 60-, 72-, and 80-inch deep construction
- Available in NEMA 3R outdoor walk-in enclosures
- Mixing of MTZ and NW/NT circuit breakers are not offered in factory configured sections but can be field retrofitted as such
- MasterPact and PowerPact circuit breakers are field maintainable

QED-6 switchboards are reliable power protection equipment when working with telecommunication facilities, e-business servers, or mainframes that perform critical business transactions. These types of facilities cannot afford downtime.

QED-6 rear-connected switchboards are designed as standalone switchboards or as an integral part of the low voltage equipment lineup in a user's power unit substation.



QED-6 Switchboard with MasterPact MTZ Circuit Breakers (Class 2746)



QED-6 Switchboard with MasterPact NW/NT and Powerpact H/J Circuit Breakers (Class 2746)

11 SWITCHBOARDS AND SWITCHGEAR

**Table 11.5: Circuit Breaker Selection**

Rating (A) (Frame)	Circuit Breakers
150–250	PowerPact H, J
800–1200	MasterPact MTZ1/NT
800–6000	MasterPact MTZ2, 3/NW

**Specify QED-6 Switchboards**

When drawout construction is required for quick circuit breaker changeout; system requirements call for circuit breakers to close within five cycles; stored energy circuit breakers are required; front access to control wires is desired; ease of installation, maintenance, and upgrade of circuit breaker compartmentalization is required; system integrity and segregation of circuit breaker compartments from bus and cable compartments is required; equipment isolation is required.

**Benefits/Values of Circuit Breaker Performance**

MasterPact MTZ, NW and NT circuit breakers are designed to provide maximum protection and reliable operation with a long service life. They exceed all UL 489 endurance testing requirements and are certified to a minimum of 10,000 operations through the 3000 A frame.

### System Coordination

Short-time ratings are high, giving users excellent system coordination and selectivity with downstream breakers.

### High Short-Circuit Current Ratings (SCCR)

Up to 200 k AIR at 240 V, 150 k AIR at 480 V, and 100 k AIR at 600 V, which allows customers to design systems with high fault current and paralleling schemes.

### Arc Flash Limiting (LF) Feeder Breakers

High speed operation of MasterPact MTZ, NW and NT circuit breakers (150 k AIR at 480 V) helps reduce arc flash incident energy (cal/cm<sup>2</sup>) on downstream equipment.

### Ease of Installation and Maintenance

Thru-the-door construction, an easy to operate drawout mechanism, and front access to all control wiring make this equipment easy to install, maintain, and upgrade. Load connections in the cable compartment are easily accessible in the rear of the switchboard. Remote racking of the MasterPact circuit breaker is also available with the optional remote racking tool, which, if required, is field installable.

### Ability to Upgrade

UL Listed, field-installable accessories include: motor operators, shunt trips, under voltage devices, trip units, and communication modules for trip units. Manually operated circuit breakers are field convertible to electrical operation.

### Open Communication System

The MicroLogic trip units in MasterPact circuit breakers use the Ethernet TCP/IP or Modbus™ serial protocol. These are widely accepted protocols which allow QED-6 to be integrated into new or many existing communication systems.

### Adaptable

Drawout circuit breakers, front access control wiring, and expandable lineups are quickly adaptable to changing load and control requirements.

### Expandable

MasterPact circuit breakers have many control termination points, giving the equipment extensive flexibility and expandability for sophisticated control schemes.

**Power-Style Commercial Multi-Metering Switchboards (UL Listed)**

- Designed, built, and listed to UL 891
- Lever bypass and EUSERC non-lever bypass
- Hot or cold sequence metering—EUSERC, NEMA, LOCAL
- Front and rear alignment standard
- Switchboard ratings through 4000 A, 100 kA
- Meter sections in either three- or six-socket section configuration
- Tenant mains either circuit breaker or fusible
- 60–200 A without lever bypass with self-contained meter sockets, 5- or 7-jaw, ring type and test block where required
- 60–200 A lever bypass with self-contained meter sockets, 7-jaw, ringless
- Factory-installed devices with completely wired from meter socket to disconnect
- Provisions for adding future tenants available, as well as future sections
- Sections in either NEMA 1 or NEMA 3R construction
- For use on 120/240 V, 120/208 V, and 277/480 V systems
- Integrated, front-accessible wireway for top exiting load cables
- Customer access area for top exiting load cables



Lever Bypass  
Class 2755



EUSERC  
Class 2756



EUSERC UCT  
Single Main Circuit Breaker with  
I-Line Distribution Panel



EUSERC UCT  
Fusible Multiple Mains

## Speed-D SB/SF Switchboards (UL Listed)

- UL Listed
- California Energy Commission (CEC) Title 24 compliant configurations available for California installations
- Hot sequence utility compartment per EUSERC requirements
- Two types:
  - Utility–Service disconnect–distribution
  - Utility–Up to six service disconnects
- Single service disconnect, either circuit breaker or fusible rated 400, 600, or 800 A with either type of distribution interiors, NQ up to 240 Vac, I-Line™ through 480 Vac
- Six service disconnects, group-mounted fusible, QMB/QMJ, 30–400 A; utility compartment—400, 600, and 800 A
- Meter doors can be 15 inches high with one meter socket and test block, or 30 inches high with two meter sockets and test block
- Meter sockets can be 6-, 8-, 13-, or 15-jaw meter sockets with test block, based on application
- Solar ready configurations are now available, using a back-fed circuit breaker on the I-Line stack
- Accessories include:
  - Underground pull sections with and without lug landing
  - Loadside wireway
  - Bus links for donut-type current transformers
  - Double padlock hasp attachments
  - Plug-on distribution panel
  - Subfeed circuit breakers
- Full height add-on I-Line distribution section
- Stand-alone I-Line distribution section

### Application

Suitable for use as service entrance equipment on ac systems. Sections contain metering compartment, barriers, main disconnects, distribution panel, neutral bus, and grounding provisions.

### Metering

C/T compartment with two 15-inch blank meter doors. (Order doors with meter socket from [Table 11.11 Meter Door Selection, page 11-13.](#)) Incoming cable lugs are for top feed with one twin conductor 2 AWG–600 kcmil lug per phase and neutral, suitable for aluminum or copper cables. Optional single conductor lug is available. Refer to [Table 11.12 Accessories, page 11-13.](#)

### Mains

Main breaker can be LH, MJ, PowerPact L, or PowerPact P. Standard and advanced electronic trip units available for PowerPact breakers. Multiple main devices use plug-on fusible switches. Main breakers with Energy or Power trip units comply with CEC Title 24 metering requirements.

### Branches

NQ distribution bus is rated 400 A and provides mounting space for QO™/QOB Type (150 A maximum) circuit breakers. Panel provides space for mounting 42 single pole circuit breakers. One or two individually mounted 225 A maximum circuit breakers can be added with bus connectors. (Order subfeed circuit breakers from [Table 11.13 Subfeed Circuit Breakers \(Series E4\), page 11-14.](#))

I-Line™ distribution bus is rated 400, 600, or 800 A and will accept 27 inches of I-Line circuit breakers on the left side with a maximum frame size of “J”. The right side will accept either a QO plug-on distribution panel (240 V only) or LA or LH I-Line circuit breaker, which allows for a back-fed solar power source.

### Enclosure

Totally enclosed front accessible with ANSI 49 gray baked enamel finish. Dimensions are 90 in. (H) x 36 in. (W) x 14 in. (D) for indoor and 90 in. (H) x 36 in. (W) x 24.5 in. (D) for outdoor enclosures.

**EUSERC Utility Metering, Main Disconnects and Distribution Panel  
(UL Listed)**

**Table 11.6: Single Main Circuit Breaker with Distribution (Series E4)**

System	Service Voltage	Mains Ratings (A)	Main Breaker Trip Unit	SCCR 240 V Max.	SCCR 480 V Max.	Distribution Interior	Circuit Breaker Catalog No.								
							Indoor	Outdoor							
1Ø3W	120/240	400	Thermal Magnetic	65	—	None	NQ	SB124QS	SB124QR						
							I-Line	SB124IS	SB124IR						
							None	SB124WS	SB124WR						
			LSI Standard Electronic	100			NQ	SB124QSJS	SB124QRJS						
							I-Line	SB124ISJS	SB124IRJS						
							None	SB124WSJS	SB124WRJS						
		LSI Energy Electronic	100	NQ	SB124QSJE	SB124QRJE									
				I-Line	SB124ISJE	SB124IRJE									
				None	SB124WSJE	SB124WRJE									
		600	LI Basic Electronic	65	—	—	None	I-Line	SB126IS	SB126IR					
								None	SB126WS	SB126WR					
								3Ø4W [1]	208Y/120 240/120	400	Thermal Magnetic	65	—	None	NQ
I-Line	SB324IS														SB324IR
None	SB324WS														SB324WR
LSI Standard Electronic	100									NQ	SB324QSJS	SB324QRJS			
		I-Line	SB324ISJS	SB324IRJS											
		None	SB324WSJS	SB324WRJS											
LSI Energy Electronic	100	NQ	SB324QSJE	SB324QRJE											
		I-Line	SB324ISJE	SB324IRJE											
		None	SB324WSJE	SB324WRJE											
208Y/120 240/120 480Y/277	400	Thermal Magnetic	65	35	—	None	I-Line		SB344IS	SB344IR					
							None		SB344WS	SB344WR					
							I-Line		SB344ISJS	SB344IRJS					
		LSI Standard Electronic	100				65	NQ	SB344QSJS	SB344QRJS					
								I-Line	SB344ISJE	SB344IRJE					
								None	SB344WSJE	SB344WRJE					
	LSI Energy Electronic	100	65	NQ	SB344QSJS	SB344QRJS									
				I-Line	SB344ISJE	SB344IRJE									
				None	SB344WSJE	SB344WRJE									
	600	LI Basic Electronic		65	50	—	None	I-Line	SB346IS	SB346IR					
								None	SB346WS	SB346WR					
								I-Line	SB346ISJS	SB346IRJS					
800		LI Basic Electronic	65	50				—	None	I-Line	SB348IS	SB348IR			
										None	SB348WS	SB348WR			
										I-Line	SB348ISJS	SB348IRJS			
LSI Standard Electronic	100	65	NQ		SB348QSJS	SB348QRJS									
			I-Line		SB348ISJE	SB348IRJE									
			None		SB348WSJS	SB348WRJS									
LSI Power Electronic	100		65	NQ	SB348QSJS	SB348QRJS									
				I-Line	SB348ISJP	SB348IRJP									
				None	SB348WSJP	SB348WRJP									

**Table 11.7: Single Main Circuit Breaker with Solar Feed**

System	Service Voltage	I-Line Bus Rating (A)	Mains Ratings (A)	Main Breaker Trip Unit	Solar Feed Maximum (A)	SCCR 240 V Max.	SCCR 480 V Max.	Circuit Breaker Catalog No.								
								Indoor	Outdoor							
1Ø3W	120/240	1200	400	Thermal Magnetic	800	65	—	SB124IS8S	SB124IR8S							
								LSI Standard Electronic	100	SB124ISJS8S	SB124IRJS8S					
									100	SB124ISJE8S	SB124IRJE8S					
			600	LI Basic Electronic		600		65	SB126IS6S	SB126IR6S						
3Ø4W [1]	208Y/120 240/120 480Y/277	1200	400	Thermal Magnetic	800	65	35	SB344IS8S	SB344IR8S							
								LSI Standard Electronic	100	65	SB344ISJS8S	SB344IRJS8S				
									100	65	SB344ISJE8S	SB344IRJE8S				
			600	LI Basic Electronic		600		50	SB346IS6S	SB346IR6S						
			800	LI Basic Electronic		400		65	50	—	None	SB348IS4S	SB348IR4S			
												LSI Standard Electronic	100	65	SB348ISJS4S	SB348IRJS4S
													100	65	SB348ISJP4S	SB348IRJP4S

[1] Can be used on 3Ø3W Delta voltage systems (for example, 240 V Delta or 480 V Delta).

Table 11.8: Single Main Fusible Disconnect with Distribution (Series E4)

System	Service Voltage	Mains Ratings (A)	Distribution Interior	SCCR 240 V Max.	SCCR 480 V Max.	Fusible Disconnect Catalog No.	
						Indoor	Outdoor
1Ø3W	120/240	400	NQ	65	—	SF124QS	SF124QR
			I-Line	100	—	SF124IS	SF124IR
			None	200	—	SF124WS	SF124WR
			I-Line	100	—	SF126IS	SF126IR
3Ø4W [2]	208Y/120 240/120	400	NQ	65	—	SF324QS	SF324QR
			None	200	—	SF324WS	SF324WR
3Ø4W [2]	208Y/120 240/120	400	I-Line	100	65	SF344IS	SF344IR
			None	200	200	SF344WS	SF344WR
3Ø4W [2]	208Y/120 240/120	600	I-Line	100	65	SF346IS	SF346IR
			None	200	200	SF346WS	SF346WR
3Ø4W [2]	208Y/120 240/120	800	I-Line	100	65	SF348IS	SF348IR
			None	200	200	SF348WS	SF348WR

Table 11.9: Multiple Mains—Fusible (Series E4)

System	Service Voltage	Mains Rating (A)	240 V or 480 V Max. [3]	Multiple Mains (6) Fusible Catalog No. [4]	
				Indoor	Outdoor
1Ø3W	120/240	400	200	SF124FS	SF124FR
1Ø3W	120/240	600	200	SF126FS	SF126FR
3Ø4W [2]	208Y/120	400	200	SF344FS	SF344FR
	240/120				
	480Y/277				
3Ø4W [2]	208Y/120	600	200	SF346FS	SF346FR
	240/120				
	480Y/277				
3Ø4W [2]	208Y/120	800	200	SF348FS	SF348FR
	240/120				
	480Y/277				

Table 11.10: I-Line™ Distribution Section (Series E4)

System	Service Voltage	Mains Ratings (A)	Distribution Interior	SCCR 240 V Max.	SCCR 480 V Max.	Distribution Type	Catalog No.	
							Indoor	Outdoor
3Ø4W	208Y/120 240/120 480Y/277	800	I-Line	65 k	65 k	Add-on distribution section, must be connected to an SB UCT and main section without distribution panel, such as SB348WS. An I-Line plug-on subfeed lug kit must be ordered to terminate the distribution section.	SBAD800	SBAD800R
3Ø4W	208Y/120 240/120 480Y/277	800	I-Line	125 k	100 k	Stand-alone distribution section not connected to an SB section. A back-fed main circuit breaker or I-Line plug-on subfeed lug kit must be ordered to terminate the distribution section. (Non-ULSE)	SBSAD800	SBSAD800R

Table 11.11: Meter Door Selection

Meter Socket Jaws	15-inch High Door With One Meter Socket and Test Block	30-inch High Door With Two Meter Sockets and Test Blocks
	Catalog No.	Catalog No.
6 [5]	SBA15D6MS	—
8	SBA15D8MS	—
13	SBA15D13MS	SBA30D13MS
15	SBA15D15MS	SBA30D15MS
Blank	SBA15DBC	—
[6]	SBA15DMS	—

NOTE: To order structure with meter door factory-installed, add door catalog number as suffix to structure (for example, SF344IS-15D13MS).

Table 11.12: Accessories

Description	Catalog No.
Indoor underground pull section (w/o lug landing)—26-in. (W) Order separate SA8LL lug kit below if required.	SA26PS
Outdoor (3R) underground pull section (w/o lug landing)—26 in. (W) x 24.5 in. (D) Order separate SA8LL lug landing kit below when required.	SA26PSR
Lug landing kit—800 A max. For terminating utility service cables in indoor or outdoor underground pull sections.	SA8LL [7]
Single barrel lug kit—Kit provides single barrel lugs and pad in lieu of twin barrel lug provided with service section.	SA7PL

[2] Can be used on 3Ø3W Delta voltage systems (for example, 240 V Delta or 480 V Delta).

[3] QMB/QMJ fusible switches, maximum 400 A, SCCR based on Class J, R, or T fuses. QMB plug-in circuit breaker rating is equal to the lowest rating of the circuit breaker.

[4] Multiple mains—provisions for mounting 30 inches of fusible devices. No more than six main devices permitted per NEC.

[5] 6-jaw meter socket can also be used on 4- and 5-jaw applications.

[6] Door with provisions for mounting meter socket.

[7] All EUSERC Utilities (except Arizona Public Service and Salt River Project) require a lug landing kit SA8LL.

**Table 11.12 Accessories (cont'd.)**

Description	System	Phase	Pole Spaces	Catalog No.
Mechanical lugs provided are sized to fit 1-3/0–750 kcmil cable. Two lugs per phase are supplied.				
<b>Loadside wireway</b> —11.5 in. (W) x 14 in. (D)—indoor only				SA10LW
<b>Bus link kit</b> —800 A max.—Order one kit per phase for 400, 600, and 800 A.				SA10BL
<b>Double padlock hasp attachment</b> —For mounting two padlocks on door handle of rainproof enclosure. Padlocks not included.				SS2PL
<b>Plug-On Distribution Panel</b> —mounts on right side of I-Line interior. Cannot be used with LA/LH branch circuit breaker. Panel rated 225 A for 240 V applications. For QO™ type plug-on circuit breakers only.	1Ø	AC	12	SS212AC
	3Ø	ABC		SS312
	3Ø	AB		SS212AB [8]

**Table 11.13: Subfeed Circuit Breakers (Series E4)**

Description	Rating (A)	2-Pole Catalog No. [9]		3-Pole Catalog No.	
		Left	Right	Left	Right
<b>Subfeed Circuit Breaker Kit [10]</b> Includes circuit breaker, connectors and mounting hardware. The complete kit, mounting hardware, circuit breaker and connectors will be shipped direct from plant. Delivery is stock to three days.	100	SASFBH100L()	SASFBH100R()	SASFBH100L	SASFBH100R
	110	SASFBH110L()	SASFBH110R()	SASFBH110L	SASFBH110R
	125	SASFBH125L()	SASFBH125R()	SASFBH125L	SASFBH125R
	150	SASFBH150L()	SASFBH150R()	SASFBH150L	SASFBH150R
	175	SASFBJ175L()	SASFBJ175R()	SASFBJ175L	SASFBJ175R
	200	SASFBJ200L()	SASFBJ200R()	SASFBJ200L	SASFBJ200R
	225	SASFBJ225L()	SASFBJ225R()	SASFBJ225L	SASFBJ225R

**Ordering Information**

- Service section:** Order service section from Table 11.6 Single Main Circuit Breaker with Distribution (Series E4), page 11-12, Table 11.8 Single Main Fusible Disconnect with Distribution (Series E4), page 11-13, or Table 11.9 Multiple Mains—Fusible (Series E4), page 11-13, as determined by mains rating, voltage, and system.
- Meter doors:** Order meter door from Table 11.11 Meter Door Selection, page 11-13 as determined by the height and utility metering requirements.
- Accessories and subfeeds:** Order as required from Table 11.12 Accessories, page 11-13 and/or Table 11.13 Subfeed Circuit Breakers (Series E4), page 11-14.
- Circuit breakers and switches:** Order devices from pages listed below as determined by voltage, trip rating, AIR, and mounting space.

Multiple Mains and Branch Devices

- QO, QOB, QO-VH, QOB-VH: page 1-3 and page
- I-Line: page 9-55 to page 9-61
- QMB Switches: page 9-64

[8] To be used on 120/240 V, 3Ø4W delta applications.

[9] Two pole circuit breaker catalog numbers are completed by adding required phase connection letters as suffix (for example, SASFBH100LAC).

[10] Cannot use subfeed circuit breaker kit with multiple mains service section switchboards.



### Power-Zone™ 4 Low Voltage Switchgear with MasterPact™ MTZ or NW/NT Circuit Breakers

Square D™ brand Power-Zone™ 4 low voltage, metal-enclosed, drawout switchgear is designed to provide superior electrical distribution, protection, and power quality management. The prime components of the switchgear are the MasterPact™ ANSI rated circuit breaker. Power-Zone 4 switchgear is designed to maximize the functionality of the MasterPact circuit breakers, which, in turn, deliver maximum uptime, system selectivity, ease of maintenance, and reliable circuit protection. All of these features are packed into the smallest footprint available for low voltage drawout switchgear.

- Power-Zone 4 is designed and built to ANSI® C37.20.1 and is Listed to UL 1558
- MasterPact MTZ, NW and NT drawout low voltage power circuit breakers are designed and built to ANSI C37.13 and C37.16. Listed to UL 1066
- Short-circuit current rating up to 200 kA at 240 V and 480 V without fuses
- High short-time withstand ratings up to 100 kA for 1 second, minimum
- Arc flash limiting (L1F) MasterPact MTZ2 or NW feeder breakers available in 800, 1600, and 2000 A ratings
- Family of field installable and upgradeable MicroLogic™ trip units with optional EcoStruxure Power™ data communications features
- Power-Zone 4 switchgear can offer optional factory integrated data communications capability with Ethernet (Modbus TCP/IP) connectivity to EcoStruxure Power Edge Control or Asset Management software
- Smallest equipment footprint available in this product class
- Front access to all control and communications wire connections
- Bolted copper bus provided as standard (up to 6000 A maximum)
- Large rear cable compartment pull area allowing maximum room for power cables
- Horizontal bus provision for future equipment expansion
- System designed for maximum uptime with low maintenance
- Modular circuit breaker designed for easy addition of control accessories
- Available in NEMA 3R outdoor walk-in enclosures
- Available in 42" deep, front accessible only version for greater layout flexibility and optimized electrical house footprint
- Available Arc Resistant construction certified to ANSI C37.20.7. See [Power-Zone™ 4 Arc Resistant Switchgear with ArcBlok Technology](#), page 11-16.



Power-Zone 4 Low Voltage Switchgear with MasterPact MTZ Circuit Breakers (Class 6037)



Power-Zone 4 Low Voltage Switchgear with MasterPact NW Circuit Breakers (Class 6037)



Power-Zone 4 Front Accessible Low Voltage Switchgear (Class 6037)

**NOTE:** Shown with MasterPact MTZ circuit breakers. MasterPact NW circuit breakers are also available.

MasterPact MTZ2, 3 or NW circuit breakers are available in various levels of interrupting ratings from 42–200 kA at 480 V and 130 kA at 600 V.

The MasterPact MTZ1 or NT circuit breaker is available in an 800 A frame size and 42 kA at 480 V interrupting rating. Up to 8 MasterPact MTZ1 or NT circuit breakers can be mounted in a 30-inch wide section. (Not available for 600 V.)

Circuit breakers of like frame sizes and interrupting ratings are interchangeable.

**Table 11.14: Equipment Ratings**

Application Voltage Systems			Ampacities
600 Vac Maximum			1600 A–6000 A (Main circuit breaker or main lugs only)
1Ø3W, 3Ø3W, 3Ø4W			
50/60 Hz			
Short-Circuit Current Ratings			Short-Time Withstand Ratings
240 V	480 V	600 V	
42 kA	42 kA	42 kA	42 kA
65 kA	65 kA	65 kA	65 kA
85 kA	85 kA	85 kA	85 kA
200 kA	200 kA	130 kA	100 kA (maximum)

## Power-Zone™ 4 Arc Resistant Switchgear with ArcBlok Technology

### Protecting Your Personnel and Equipment from an Arc Flash

Power-Zone 4 arc resistant switchgear with MasterPact ArcBlok technology offers patented, superior arc flash protection for operators and maintenance personnel. The arc flash containment features are unique to the industry in both the circuit breaker compartment and the structure.

Power-Zone 4 Arc Resistant Switchgear with ArcBlok Technology is certified to comply with *ANSI C37.20.7 IEEE Guide for Testing Metal-Enclosed Switchgear Rated Up to 38 kV for Internal Arcing Faults*, and third-party (UL) witnessed as arc resistant switchgear. Refer to Data Bulletin 6037DB1302 for the complete UL Witness Certification Summary.

#### Features

- MasterPact MTZ2, 3/NW circuit breakers with patented ArcBlok technology (up to 5000 A)
- Rated for systems with up to 100kA, 635V fault current
- 60 in. deep x 22 in. wide (smallest arc resistant footprint in the industry)
- 22 in., 36 in. section widths
- 60 in., 72 in., 80 in. section depths
- Internal arc gas management system for optimized cooling
- ANSI Type 2B Rating
- NEMA 1 enclosure

#### Available Options

- Insulated copper bus
- Zone selective interlocking
- High-resistance grounding
- Energy reduction maintenance switch
- Section barriers (rear, cable, and side)
- Circuit breaker remote racking
- ANSI Type 2B rated arc plenum exhaust



Arc Resistant Power-Zone 4 Low Voltage Switchgear (Class 6037)

**NOTE:** Shown with MasterPact NW ArcBlok circuit breakers. MasterPact MTZ2,3 ArcBlok circuit breakers are also available.

## Built on the Legendary Performance and Reliability of the MasterPact Line

MasterPact MTZ circuit breakers prepare you for the future of power distribution. Smart connectivity. Remote monitoring. Easy customization via digital modules. MasterPact MTZ circuit breakers bring the future-ready EcoStruxure Power capabilities you need to build smart, dependable, and sustainable power distribution systems:

- Smartphone connectivity for wireless alerts and maintenance
- Precision Class 1 power meter built in for energy-saving capabilities
- Easy customization via digital modules
- Intuitive MicroLogic™ X control unit
- Robust performance, even in harsh environments
- Seamless integration with building and energy management systems via EcoStruxure Power architecture
- Designed and tested to applicable standards for ANSI, UL and IEC



With Masterpact MTZ breakers, enhanced connectivity equips you for the future of power distribution. Available from 800 A to 6000 A.





MiniBreak Switch Enclosure with Door (Class 6042)



MiniBreak Switch Interior Showing Fuses (Class 6042)

### MiniBreak™ Compact Height Switches— 5.5 kV, 200 A

The Square D™ brand MiniBreak compact height switch enclosure is only 66-inches high and contains a single 3-pole load interrupter switch, rated 5.5 kV and 200 A. Enclosures are free-standing and suitable for both indoor (NEMA 1) and outdoor (NEMA 3R) applications. These switches are available unfused or with provisions for ANSI-style, 3-inch-barrel fuses rated from 10E A to 200E A. Factory-installed accessories include an auxiliary switch, strip heaters, and provisions for a “lock open” only key interlock. The door is mechanically interlocked with the switch operating handle. Set screw cable lugs for #14 solid—2/0 stranded aluminum or copper cable are provided for two line and one load connections. **Fuses are not furnished with this equipment.** For fuse information, see Table 11.17 Current-Limiting Fuses, Non-Disconnect Type. The Fused switches and many of the fuses listed in this table are available from stock.

Table 11.15: Ratings

Max. design voltage (kV)	5.5
BIL (kV)	60
Frequency (Hz)	60
Continuous amperes	200
Interrupting amperes	200
Momentary (amperes asymmetrical)	20,000
Fault close (amperes asymmetrical)	20,000
Capacitor switching (kVAR)	None
Short time, 2 seconds (amperes symmetrical)	12,500
Low frequency withstand (kV)	19
Fuse integrated (symmetrical)	63,000

NOTE: 1200 hp maximum.

### Ordering Information

Table 11.16: 5 kV—200 A Switch

Type	Switch Catalog No.
Unfused	HVMB305200U
Fused	HVMB305200

1. Select switch catalog number based on fused or unfused.
2. Select catalog numbers for modifications from Factory Modifications table.
3. If fused, select 5 kV, 200 A maximum current-limiting fuse from table below.
4. Price switch and fuses separately. Switches are furnished with provisions only for fuses.
5. Weight 450 lbs (204 kg).

Table 11.17: Current-Limiting Fuses, Non-Disconnect Type

Continuous Current	Fuse Mounting Clip		Catalog Number [1] [2]
	Size	Centers	
5 kV Fuse			
10E	D	12"	5GS010
15E			5GS015
20E			5GS020
25E			5GS025
30E			5GS030
40E	D	12"	5GS040
50E			5GS050
65E			5GS065
80E			5GS080
100E			5GS100
125E	D	12"	5GS125
150E			5GS150
175E			5GS175
200E			5GS200

Table 11.18: Factory Modifications

Catalog No.	Description
HVMX1	Auxiliary switch, 1-N.O. and 1-N.C. contacts
HVMK1	Provisions for lock open only key interlock—Type KFL Kirk key lock with a 0-inch bolt projection (Kirk item master number KFL000010SH)
HVMH1	Strip heater 100 W @ 120 V
HVMH2	Strip heater with thermostat 100 W @ 120 V
HVMSA3	Distribution class surge arrester (set of three arresters) 3 kV, 2.55 MCOV [3]
HVMSA6	Distribution class surge arrester (set of three arresters) 6 kV, 5.10 MCOV [3]



Listed Metal-Enclosed Interrupter Switchgear

[1] Contact your Schneider Electric representative for current stock quantities.  
 [2] Includes one set of three fuses, packed in a single box.  
 [3] Arresters are line side connected.

Class 6042 / Refer to Brochure 6042BR9401

**Ordering Example**

Order one (1), 5 kV, 200 A switch with 65E current-limiting fuses. Provide one auxiliary switch with 1-N.O. and 1-N.C. contact and with provision for installing a "lock open" key interlock on the switch operating mechanism.

Order:	Catalog No.
Switch with enclosure	HVMB305200
Auxiliary switch	HVMX1
Key interlock adapter	HVMK1
Fuses (set of three, from Table 11.17 Current-Limiting Fuses, Non-Disconnect Type, page 11-17. [4] [5])	5GS065

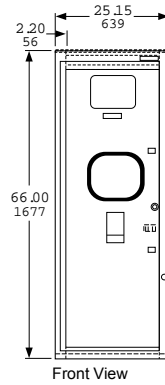

Front View

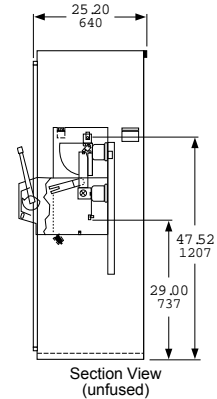

Section View (unfused)

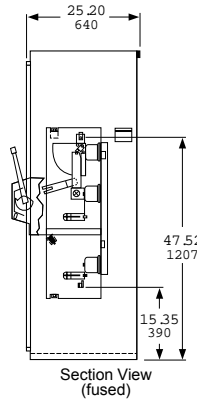

Section View (fused)

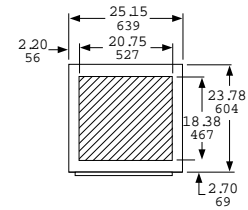

Bottom View  
Selected Area Recommended  
(bottom conduit entrance)

[4] For fuses produced by other manufacturers, contact your nearest Schneider Electric sales office or your local Schneider Electric distributor.

[5] Current-limiting fuses will increase the integrated short-circuit ratings beyond the non-fusible units. Contact your nearest Schneider Electric sales office or your local Schneider Electric distributor.

**Premset Compact Vacuum Circuit Breaker Switchgear with Shielded Solid Insulation System (2SIS)**

Premset represents the new generation of medium voltage switchgear. It is 15 kV vacuum circuit breaker switchgear technology that takes advantage of the innovative shielded solid insulated system (2SIS). 2SIS creates a three-layered system (medium voltage conductive layer, epoxy insulating layer, and grounded shield layer) throughout the entire switchgear that optimizes performance and increases life expectancy. Premset reduces the opportunity of arc flash or contact with live parts by insulating and screening all live parts in an epoxy dielectric molding. In addition, a grounded shield layer helps reduce the likelihood of exposure to electrical hazards while at the same time better protecting the insulating material from harsh environmental conditions such as moisture, dust, chemicals, and vermin.

Premset delivers a compact architecture that is both modular and flexible. It allows for front-only accessibility (bottom incoming cables) and the smallest 15 kV vacuum circuit breaker footprint on the market. Plug-and-play design of accessories and auxiliaries makes even last minute or field modifications possible. Modular design improves cost savings and optimizes delivery times. Premset's modular architecture makes it easy to use in design and intuitive to learn for operators.



**Table 11.19: Premset Ratings**

Voltage Class	5 and 15 kV		
Bus Current Rating	600 and 1200 A		1200 A
Circuit Breaker Current Rating	100 A	200 A	600 A
Maximum Short-Time Interrupting Current	25 kA (2 seconds)		
Rated BIL Withstand Voltage	95 kV		
Base Dimensions (inches)	14.75 W x 36 D x 65 H		29.5 W x 36 D x 65 H



Listed Metal-Enclosed Interrupter Switchgear



### HVL/cc Metal-Enclosed Load Interrupter Switchgear—Full Range

Square D™ brand HVL/cc metal-enclosed load interrupter switchgear provides switching, metering, and interrupting capabilities for medium voltage electrical power distribution systems and is designed and tested per applicable ANSI/IEEE and NEMA standards.

Made up of modular units, the HVL/cc is easy to expand. Two main bus positions allow future extensions and connections to existing equipment.

HVL/cc switchgear is available in either single or multiple bay units. The design is compact, with front access only options available at system voltages below 17.5 kV.

The HVL/cc switch can be equipped with either an over-toggle mechanism (OTM), which is standard, or an optional stored energy mechanism (SEM). An option with both mechanisms is the Fuselogic™ system. The Fuselogic system offers fuse tripping (with SEM) to provide protection against single phasing loads when a fuse has blown.

Where available, the HVL/cc front access only enclosures can be positioned against walls, in small rooms, or in pre-fabricated buildings. The small footprint can result in considerable cost savings from the reduction of building or room sizes.

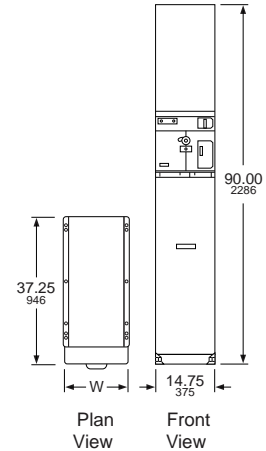
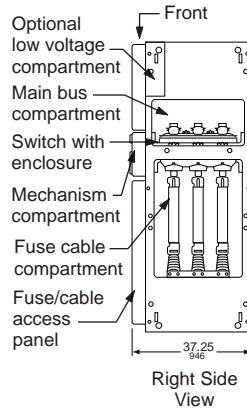

**Table 11.20: HVL/cc Load Interrupter Switches— Full Range 600/1200 A Ratings**

Switch (kV)—maximum design	5.5	17.5	17.5	25.8	38
BIL (kV)	60	95	110	125	150
Frequency (Hz)	50/60	50/60	50/60	50/60	50/60
Withstand (kV)	19	36	36	50	80
Continuous current (A)	600/1200	600/1200	600/1200	600	600
Interrupting current (A)	600/1200	600/1200	600/1200	600	600
Fault close (kA asymmetrical)	40	40	40	32	32
Momentary current (kA asymmetrical)	40	40	40	32	32
Short time current (kA symmetrical)	25	25	25	25	25
Electrical endurance (number of operations at 80% P.F.)	100/600 A 26/1200 A	100/600 A 26/1200 A	100/600 A 26/1200 A	100	100
Mechanical endurance (number of operations)	1000	1000	1000	1000	1000

Class **6045** / Refer to Catalog **6045CT9801** or Product Data **6040PD9601**

**Switch Standard Features**

- Switch Positions: Closed, open, and internally grounded (optional) (connects switch contacts to ground)
- Enclosure: Epoxy
- Medium: Sulphur hexafluoride
- Maintenance: Maintenance free sealed for life
- Pressure:
  - 5.8 PSI (≤ 17.5 kV)
  - 22 PSI (25.8–38 kV)
- View ports to show switch blade position

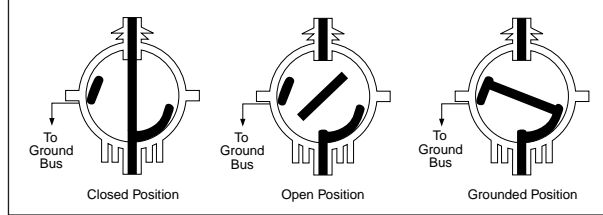

**Options**

- Internal ground switch: Has full fault making capability
- Fuselogic™ system
- Infrared viewing windows
- Class I, Division 2
- Fast auto transfers
- Duplex configurations
- Powerlogic™ metering
- 20-inch or 29.5-inch wide enclosures

**Fuselogic™**

Fuselogic is a protection system that provides the ultimate in medium voltage fuse protection. This patented system utilizes Square D™ brand current-limiting fuses with mechanical sensors that function without any auxiliary power requirements. Several combinations of Fuselogic functions can be combined to provide simple blown fuse indication contacts with mechanical lockout to anti-single phasing protection. Anti-single phasing requires the optional stored energy mechanism. Fuselogic is available on both HVL/cc and HVL switches.

**Switchgear Standard Features**

- Compartments: Switch, bus, fuse/cable, mechanism, and optional low voltage/control
- 11 gauge steel enclosure
- Epoxy insulators
- Fuse/cable access panel interlocked with switch
- Front access only options available at system voltages below 17.5 kV
- Animated mechanism mimic bus
- Padlocking provision—open or closed (OTM); open-only (SEM)
- Top or bottom cable entry
- UL/CUL Listed, IEEE C37.20.3
- Live line indicators on all incoming switch bays and outgoing feeder circuits
- Cable lugs included for one cable per phase
- Tin plated copper bus for lineups



**Table 11.21: Surge Arresters**

System L-L Voltage kV		Arrester MCOV-kV	
Nominal	Maximum	Effectively Grounded Neutral Circuits	Impedance Grounded and Ungrounded Circuits
2.4	2.54	—	2.55
4.16	4.4	2.55	5.1
4.8	5.08	—	5.1
6.9	7.26	—	7.65
12.0	12.7	7.65	12.70
12.47	13.2	7.65	12.70
13.2	13.97	8.4	—
13.8	14.52	8.4	—

### HVL/cc Switchgear Quick Ship Program—5–15 kV, 600 A

The HVL/cc quick ship program provides basic fused and unfused load interrupter switch configurations for standalone or transformer primary applications. The Quick Ship program offers faster delivery, but with fewer options.

Three-pole, 600 A individual HVL/cc switches are available in free-standing indoor (NEMA 1) enclosures. These switches are available unfused or with provisions for Square D™ brand current-limiting DIN/E fuses. Factory optional accessories include auxiliary bays, main bus, auxiliary switches, and distribution class surge arresters. The fuse access panel is mechanically interlocked with the switch mechanism. Key interlocks are not an available option with Digest-listed HVL/cc switches. (1) Set screw type lugs for (2) #2–350 kcmil copper or aluminum cables are provided for line and load connections.

**Fuses are not furnished with this equipment.** For fuse information, refer to [General Purpose E-Rated Current-Limiting Fuses: Type DIN/E for HVL/cc Switches](#), page 11-25.

**NOTE:** Cable entry and exit must be opposite to maintain the minimum sections shown.

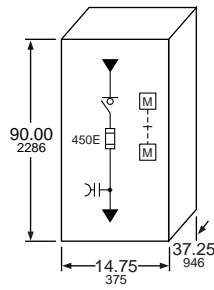

5 kV Indoor N1  
Top Cable In/Bottom Cable  
Out Switch in Position A

Mechanical interlock between switch and fuse access panel.

**NOTE:** Mechanical interlock is standard on switches.

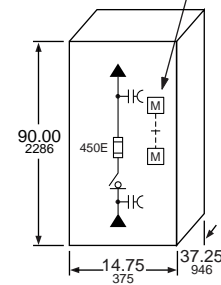

5 kV Indoor N1  
Top Cable In/Bottom Cable Out  
Switch in Position B

#### Provisions for Future Expansion

- All “single” HVL/cc switches have provisions for future expansion on either side
- Order main bus kits for copper 600 A bus

#### 600 A Single Switch Unfused

- Manual over-toggle mechanism, no grounding switch
- Includes (1) set screw for (2) #2–350 kcmil Cu or Al conductors per phase
- Application A = Top entry (incoming—cable or main bus), bottom exit (load—cable or main bus)
- Application B = Bottom entry (incoming—cable or main bus), top exit (load—cable or main bus)

**Table 11.22: Unfused Switch Selection**

Catalog No.	kV Rating	Fuse Range	Application	Width	
				in	mm
HVLC14305N	4.76	—	A	14.75	375
HVLC20305N	4.76	—	A	20.00	508
HVLC14315N	15	—	A	14.75	375
HVLC20315N	15	—	A	20.00	508
HVLCB14305N	4.76	—	B	14.75	375
HVLCB20305N	4.76	—	B	20.00	508
HVLCB14315N	15	—	B	14.75	375
HVLCB20315N	15	—	B	20.00	508



**600 A Single Switch Fused**

- Provisions only for Square D™ brand current-limiting DIN/E fuses—order separately
- Manual over-toggle mechanism, no grounding switch
- Includes (1) set screw lug for (2) #2–350 kcmil Cu or Al conductor per phase
- Application A = Top entry (incoming—cable or main bus), bottom exit (load—cable or main bus)
- Application B = Bottom entry (incoming—cable or main bus), top exit (load—cable or main bus)

**Table 11.23: Fused Switch Selection**

Catalog No.	kV Rating	Fuse Range	Application	Width	
				in	mm
HVLC14305D	4.76	10–450E	A	14.75	375
HVLC20305D	4.76	10–450E	A	20.00	508
HVLC14315D	15	10–200E	A	14.75	375
HVLC20315D	15	10–200E	A	20.00	508
HVLCB14305D	4.76	10–450E	B	14.75	375
HVLCB20305D	4.76	10–450E	B	20.00	508
HVLCB14315D	15	10–200E	B	14.75	375
HVLCB20315D	15	10–200E	B	20.00	508

**600 A Incoming Line Auxiliary Bay**

For bottom incoming cable to application A (bottom cable exit) switch(es), order 600 A tin plated Cu main bus to adjacent section from bus table. Includes (1) set screw lug for (2) #2–350 kcmil Cu or Al conductor per phase.

**Table 11.24: Bays for Bottom Entry/Bottom Exit Cables**

Catalog No.	kV Rating	Fuse Range	Application	Width	
				in	mm
HVLC14A	4.76/15	—	A	14.75	375
HVLC20A	4.76/15	—	A	20.00	508

For top incoming cable to application B (top cable exit) switch(es), order 600 A tin plated Cu main bus to adjacent section from main bus kits table. Includes (1) set screw lug for (2) #2–350 kcmil Cu or Al conductor per phase.

**Table 11.25: Bays for Top Entry/Top Exit Cables**

Catalog No.	kV Rating	Fuse Range	Application	Width	
				in	mm
HVLCB14A	4.76/15	—	B	14.75	375
HVLCB20A	4.76/15	—	B	20.00	508

**600 A Tin Plated Copper Main Bus Kits**

**Table 11.26: Bus Kits**

Catalog No.	Left (From) Application	Width		Right (To) Application	Width	
		in	mm		in	mm
HVLCMBA14A14	A	14.75	375	A	14.75	375
HVLCMBA14A20	A	14.75	375	A	20.00	508
HVLCMBA20A14	A	20.00	508	A	14.75	375
HVLCMBA20A20	A	20.00	508	A	20.00	508
HVLCMBB14B14	B	14.75	375	B	14.75	375
HVLCMBB14B20	B	14.75	375	B	20.00	508
HVLCMBB20B14	B	20.00	508	B	14.75	375
HVLCMBB20B20	B	20.00	508	B	20.00	508

**Ratings**

HVL/cc Switch with manually operated type OTM mechanism in cubicle enclosure (does not include internal ground switch). Ratings are based on an X/R ratio of 1.6.

**Table 11.27: HVL/cc Switch Ratings**

Switch (kV)—maximum design	5.5	17.5
BIL (kV)	60	95
Frequency (Hertz)	50/60	50/60
Withstand (kV)	19	36
Continuous current (amperes)	600	600
Interrupting current (amperes)	600	600
Fault close (amperes asymmetrical)	40,000	40,000
Integrated switch and fuse rating (amperes symmetrical) <sup>[6]</sup>	65,000	65,000
Momentary current (amperes asymmetrical)	40,000	40,000
Short time current, 2 seconds (amperes symmetrical)	25,000	25,000
Operations at Full Load	100	100
Mechanical Endurance (number of operations)	1000	1000

[6] 50,000 for 630 A fuse.

Class 6045 / Refer to Catalog 6045CT9801

Factory Modifications

Table 11.28: Factory Modifications

Catalog No.	Description
HVLCX3	Auxiliary switch 2 N.O.–2 N.C. contact

Distribution Class Surge Arresters

(One Set of Three) Switch Load Side Connected or Incoming Line Bay)

Table 11.29: Surge Arresters

Catalog No.	kV Rating	Section Width Minimum Required	
		in	mm
HVLCDSA3	3 kV, 2.55 kV MCOV	14.75	375
HVLCDSA6	6 kV, 5.10 kV MCOV	14.75	375
HVLCDSA9	9 kV, 7.65 kV MCOV	14.75	375
HVLCDSA10	10 kV, 8.40 kV MCOV	14.75	375
HVLCDSA12	12 kV, 10.20 kV MCOV	14.75	375
HVLCDSA15	15 kV, 12.70 kV MCOV	20.00	508
HVLCDSA18	18 kV, 15.3 kV MCOV	20.00	508

600 A “Single” HVL/cc Switch with PROVISIONS ONLY for Square D™ brand Current-Limiting, Non-Disconnect Type Fuses for Cable Connection to Power-Dry™, Power-Cast™, and Uni-Cast™ Transformers

(FLC = 300 A MAXIMUM)

RH—Transformer on right, LH—Transformer on Left

Application A = Top Entry (Incoming Cables)

Application B = Bottom Entry (Incoming Cables)

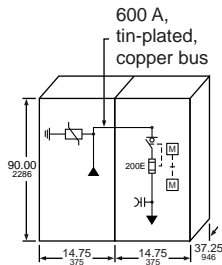

Listed Metal-Enclosed Interrupter Switchgear

Table 11.30: 600 A “Single” HVL/cc Switch Selection

Catalog No.	kV Rating	Fuse Range	Ap- plication	Width		RH / LH
				in	mm	
HVLC14405DGR	4.76	10–450E	A	14.75	375	RH
HVLC14405DGL	4.76	10–450E	A	14.75	375	LH
HVLC14415DGR	4.76	10–450E	A	14.75	375	RH
HVLC14415DGL	4.76	10–450E	A	14.75	375	LH
HVLC144200E	15	10–200E	A	20.00	508	RH
HVLC144200E	15	10–200E	A	20.00	508	LH
HVLC144200E	15	10–200E	A	20.00	508	RH
HVLC144200E	15	10–200E	A	20.00	508	LH
HVLC144200E	15	10–200E	A	20.00	508	RH
HVLC144200E	15	10–200E	A	20.00	508	LH
HVLC144200E	15	10–200E	A	20.00	508	RH
HVLC144200E	15	10–200E	A	20.00	508	LH
HVLC144200E	15	10–200E	A	20.00	508	RH
HVLC144200E	15	10–200E	A	20.00	508	LH
HVLC144200E	15	10–200E	A	20.00	508	RH
HVLC144200E	15	10–200E	A	20.00	508	LH

**NOTE:** Switches with transformer connections are painted ANSI 49. Standalone switches are painted ANSI 61. Transformer connections in HVL/cc switches are based on standard Square D™ brand transformer connections. If these switches are used to connect to other manufacturers' transformers, then connections must match standard Square D™ brand transformer connections. (Cable connections are furnished with the transformer.)

**General Purpose E-Rated Current-Limiting Fuses: Type DIN/E for HVL/cc Switches**

- Integrated rating for 600 A HVL/cc switches with Square D™ brand DIN/E fuses listed below is 65 kA rms symmetrical amperes.
- Current-limiting fuses increase the integrated short-circuit current rating because of their energy-limiting capabilities.
- To increase the short-circuit current rating of the entire lineup of switchgear, current-limiting fuses must be used in the entrance sections.

**Table 11.31: Fuse Selection**

Catalog No.	kV Rating	Fuse Rating	Set of Fuses [7]	Fuse Size	Section Width Required	
					in	mm
55DE010	5.5	10E	1	Actual	14.75	375
55DE015	5.5	15E	1	Actual	14.75	375
55DE020	5.5	20E	1	Actual	14.75	375
55DE025	5.5	25E	1	Actual	14.75	375
55DE030	5.5	30E	1	Actual	14.75	375
55DE040	5.5	40E	1	Actual	14.75	375
55DE050	5.5	50E	1	Actual	14.75	375
55DE065	5.5	65E	1	Actual	14.75	375
55DE080	5.5	80E	1	Actual	14.75	375
55DE100	5.5	100E	1	Actual	14.75	375
55DE125	5.5	125E	1	Actual	14.75	375
55DE150	5.5	150E	1	Actual	14.75	375
55DE175	5.5	175E	1	Actual	14.75	375
55DE200	5.5	200E	1	Actual	14.75	375
55DE250	5.5	250E	1	Actual	14.75	375
55DE300	5.5	300E	1	Actual	14.75	375
55DE350	5.5	350E	1	Actual	14.75	375
55DE400	5.5	400E	1	Actual	14.75	375
55DE450	5.5	450E	1	Actual	14.75	375
175DE010	15.5	10E	1	Actual	14.75	375
175DE015	15.5	15E	1	Actual	14.75	375
175DE020	15.5	20E	1	Actual	14.75	375
175DE025	15.5	25E	1	Actual	14.75	375
175DE030	15.5	30E	1	Actual	14.75	375
175DE040	15.5	40E	1	Actual	14.75	375
175DE050	15.5	50E	1	Actual	14.75	375
175DE065	15.5	65E	1	Actual	14.75	375
175DE080	15.5	80E	1	Actual	14.75	375
175DE100	15.5	100E	1	Actual	14.75	375
175DE125	15.5	125E	1	Actual	14.75	375
175DE150	15.5	150E	1	Actual	14.75	375
155DE175	15.5	175E	1	Actual	14.75	375
155DE200	15.5	200E	1	Actual	14.75	375

**600 A “Duplex” HVL/cc Switch with PROVISIONS ONLY for Square D™ brand Current-Limiting, Non-Disconnect Type Fuses for Cable Connection to Power-Dry, Power-Cast, and Uni-Cast Transformers**

- FLC = 300 A maximum
- RH—Transformer on right
- LH—Transformer on left includes mechanical interlock to prevent paralleling of sources
- Application A = top entry (incoming cables)
- Application B = bottom entry (incoming cables)

**Table 11.32: 600 A “Duplex” HVL/cc Switch Selection**

Catalog No.	kV Rating	Fuse Range	Applicati-on	Width		RH / LH
				in	mm	
HVLCOA14505DGR	4.76	10–450E	A	14.75	375	RH
HVLCOA20505DGR	4.76	10–450E	A	20.00	508	RH
HVLCOA14505DGL	4.76	10–450E	A	14.75	375	LH
HVLCOA20505DGL	4.76	10–450E	A	20.00	508	LH
HVLCOA14515DGR	15	10–200E	A	14.75	375	RH
HVLCOA20515DGR	15	10–200E	A	20.00	508	RH
HVLCOA14515DGL	15	10–200E	A	14.75	375	LH
HVLCOA20515DGL	15	10–200E	A	20.00	508	LH
HVLCOB14505DGR	4.76	10–450E	B	14.75	375	RH
HVLCOB20505DGR	4.76	10–450E	B	20.00	508	RH
HVLCOB14505DGL	4.76	10–450E	B	14.75	375	LH
HVLCOB20505DGL	4.76	10–450E	B	20.00	508	LH
HVLCOB14515DGR	15	10–200E	B	14.75	375	RH
HVLCOB20515DGR	15	10–200E	B	20.00	508	RH
HVLCOB14515DGL	15	10–200E	B	14.75	375	LH
HVLCOB20515DGL	15	10–200E	B	20.00	508	LH

[7] Each set of fuses contains three fuses, so, for example, two sets of fuses yield a total of six fuses.

Class **6045** / Refer to Catalog **6045CT9801**

### Ordering Information

1. Select switch catalog number based on fused or unfused and cable entry locations (top or bottom) from [Table 11.22 Unfused Switch Selection, page 11-22](#), or [Table 11.23 Fused Switch Selection, page 11-23](#).
2. Select incoming line auxiliary bay from [Table 11.24 Bays for Bottom Entry/Exit Cables, page 11-23](#), or [Table 11.25 Bays for Top Entry/Exit Cables, page 11-23](#), if required.
3. Select main bus from [Table 11.26 Bus Kits, page 11-23](#), if required.
4. Select catalog numbers for factory modifications from [Table 11.28 Factory Modifications, page 11-24](#), if required.
5. If fused, select DIN/E fuses from [Table 11.31 Fuse Selection, page 11-25](#).

### Ordering Example

Order indoor 600 A, 5 kV, HVL/cc switch with bottom incoming and bottom outgoing cables (1) #2 AWG per phase, (1) set 200E fuses, and (1) set 6 kV surge arresters.

Order:	Catalog No.
Switch w/fuse provisions and bottom exit load cables	HVLCCA14305D
600 incoming line auxiliary bay (Application A—bottom entry)	HVLCCA14A
Main Bus (Application A—14 in. to Application A—14 in.)	HVLCMBA14A14
6 kV LAs	HVLCDSA6
Set 200E fuses	55DE200



Listed Metal-Enclosed Interrupter Switchgear

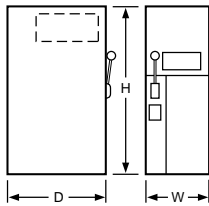

Side view Front view

Recommended power cable conduit area

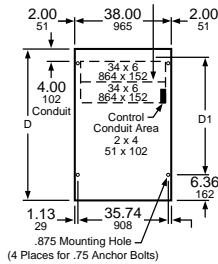

### HVL Metal-Enclosed Load Interrupter Switchgear—Full Range

HVL™ 5–38 kV Load Interrupter is the most popular ANSI-rated switchgear in its class in America. Among medium voltage interrupter switchgear, both the switch and the enclosure stand as industry benchmarks in the areas of design, manufacturing, and performance. Load interrupter switchgear must perform a number of critical functions in a unit substation - protecting equipment and disconnecting faulted lines and transformers. Designed and tested to the latest applicable standards, HVL has been engineered to provide superior protection for your distribution system.

HVL switchgear is available for various applications and configurations, including:

- Individual service entrance bays
- Multiple-bay lineups incorporating HVL load interrupters
- Substation primaries

Square D™ brand metal-enclosed switchgear has become an industry standard for its better system performance, lower maintenance cost, easier system expansion, and reduced system expense.

A full range of ratings and options are available but not listed in this publication. Contact your nearest Schneider Electric sales office or your local Schneider Electric distributor.

Table 11.33: Ratings

Maximum design voltage (kV)	4.76	15	17	25.8	29	38
BIL (kV)	60	95	95	125	125	150
Frequency (Hz)	50/60	50/60	50/60	50/60	50/60	50/60
Continuous amperes	600/1200	600/1200	600	600/1200	600/1200	600
Interrupting amperes	600/1200	600/1200	600	600	400	400
Momentary (kA asymmetrical)	40/61/80	40/61/80	61	40/61	40/61	40
Fault close (kA asymmetrical)	40/61	40/61	40	28	28	20
Capacitor switching (kVAR)	2400	2400	–	–	–	–
Short time rating 2 seconds (kA symmetrical)	25/38/50	25/38/50	25	25	25	25
Low frequency withstand (kV)	19	36	36	60	60	80

#### Standard Features

- 11 gauge steel enclosure
- Direct drive mechanism
- Permanently attached operating handle
- Visible isolation viewing window
- Mechanical interlocked fuse access door
- Provision for padlock and key interlock
- Highly flexible design
- ANSI 61 paint

#### Options

- Outdoor construction
- Square D™ brand DIN-style current-limiting fuses
- Boric acid fuses
- Silver or tin plated copper bus
- 600, 1200, or 2000 A main bus
- Heat shrink insulated bus
- Motor operator
- Shunt trip
- Fuselogic™ tripping system
- Roof bushings
- Key interlocks
- Surge arresters
- Utility metering bays
- Duplex switch
- Transformer connections
- Infrared windows for thermal scanning of connections

#### Fuselogic™

Fuselogic is a protection system that provides the ultimate in medium voltage fuse protection. This patented system utilizes the Square D™ brand current-limiting fuses with mechanical sensors that function without any auxiliary power requirements. Several combinations of Fuselogic functions can be combined to provide simple blown fuse indication contacts with mechanical lockout to anti-single phasing protection. Anti-single phasing requires the optional stored energy mechanism (SEM). Fuselogic is available on both HVL/cc™ and HVL switches.

Class 6040 / Refer to Catalog 6040CT9201 or Brochure 6040BR9401

### HVL Switchgear Quick Ship Program—5 kV–15 kV, 600 A

The HVL quick ship program provides basic fused and unfused load interrupter switch configurations for stand-alone or transformer primary applications. The Quick Ship program offers faster delivery, but with fewer options.

Three-pole, 600 A individual HVL switches are available in free-standing indoor (NEMA 1) or outdoor (NEMA 3R) enclosures. The switches used in these enclosures are UL Recognized and are listed under Category WIQG2 in File E140591(M). These switches are available unfused or with provisions for DIN—style, Square D™ brand current-limiting fuses or for boric acid fuses. Factory optional accessories include auxiliary switches, extra cable terminating lugs and distribution class surge arresters. The door is mechanically interlocked with the switch operating handle and provisions for key interlocks are standard. Set screw type lugs for one #2 solid—600 kcmil copper or aluminum cables are provided for line and load connections. Other standard features include a bolted enclosure with a viewing window, ground pad, and space heater (NEMA 3R only). Control power for heater must be from external source. **Fuses are not furnished with this equipment.** For fuse information, refer to [Table 11.45 DIN/E Current-Limiting Fuses, Non-Disconnecting Type](#), page 11-31, or [Table 11.46 Boric Acid Fuses](#), page 11-32. Many of the fuses listed in these tables are available from stock. Switches are listed in the tables below and on [page 11-29](#).

**Table 11.34: 600 A “Single” Switch Unfused**

Catalog No.	kV Rating	Fuse Range	Enclosure Type
HVL305NG	4.76	—	NEMA 1
HVL305NW	4.76	—	NEMA 3R
HVL315NG	15	—	NEMA 1
HVL315NW	15	—	NEMA 3R

**Table 11.35: 600 A “Single” Switch with PROVISIONS ONLY for Square D™ brand Current-Limiting, Non-Disconnect Type Fuses**

Catalog No.	kV Rating	Fuse Range	Enclosure Type
HVL305DEG	4.76	10–450E	NEMA 1
HVL305DEW	4.76	10–450E	NEMA 3R
HVL315DEG1	15	10–100E	NEMA 1
HVL315DEG2	15	125–200E	NEMA 1
HVL315DEW1	15	10–100E	NEMA 3R
HVL315DEW2	15	125–200E	NEMA 3R

**Table 11.36: 600 A “Single” Switch with PROVISIONS ONLY for S&C Boric Acid Non-Disconnect Type Fuses [8]**

Catalog No.	kV Rating	Fuse Range	Enclosure Type
HVL305BG	4.76	10E–400E	NEMA 1
HVL305BW	4.76	10E–400E	NEMA 3R
HVL315BG	15	10E–400E	NEMA 1
HVL315BW	15	10E–400E	NEMA 3R
HVL317BG	17	10E–400E	NEMA 1
HVL317BW	17	10E–400E	NEMA 3R

**Table 11.37: Ratings**

Max. Design Voltage (kV)	4.76	15.0
BIL (kV)	60	95
Frequency (Hz)	50/60	50/60
Continuous amperes	600	600
Interrupting amperes	600	600
Momentary (amperes asymmetrical)	40,000	40,000
Fault close (amperes asymmetrical)	40,000	40,000
Capacitor switching (kVAR)	2,400	2,400
Short-time rating, 2 seconds (amperes symmetrical)	25,000	25,000
Low frequency withstand (kV)	19	36

**Table 11.38: Distribution Class Surge Arresters**

System L-L Voltage kV		Arrester MCOV-kV	
Nominal	Maximum	Effectively Grounded Neutral Circuits	Impedance Grounded and Ungrounded Circuits
2.4	2.54	—	2.55
4.16	4.4	2.55	5.1
4.8	5.08	—	5.1
6.9	7.26	—	7.65
12.0	12.7	7.65	12.70
12.47	13.2	7.65	12.70
13.2	13.97	8.4	—
13.8	14.52	8.4	—

**Table 11.39: Enclosure Type**

Type	W		D		H		Weight	
	in	mm	in	mm	in	mm	lbs	kg
Indoor	38.00	965	54.50	1384	90.00	2286	1200	545
Outdoor	38.00	965	60.00	1524	97.50	2477	1400	636

[8] Boric acid fuses may increase lead times. Contact the factory for availability.

**Provisions for Future Expansion**

All “single” Digest switches have provisions for future expansion on either side. Order kits HVMB for top crossover copper 600 A bus and HVLC for line connections to the top bus. (See Table 11.44 Factory Modifications, page 11-30.)

**HVL Switches for Power-Dry II™, Power-Cast II™, and Uni-Cast II™ Transformer Connections**

HVL switches can be configured for close coupling cable connections to listed dry type transformers for primary main switches of unit substations. These are listed in the tables below with current-limiting or boric acid fuses. Both single and duplex switch mains are included in this selection. Transformers are listed on page and may not be suitable for close coupling. For transformer availability and specific configurations, contact your local Schneider Electric sales office. All connections in this digest are based on standard Square D™ brand transformer connections. If these switches are used to connect to other manufacturers’ transformers, then connections must coordinate with standard Square D™ brand transformer connections. (Cable connections are furnished with the transformer.)

**Table 11.40: 600 A “Single” Switch with PROVISIONS ONLY for Square D™ brand Current-Limiting, Non-Disconnect Type Fuses for Cable Connection to Power-Dry II, Power-Cast II, and Uni-Cast II Transformers (FLC = 300 A max.) RH—Transformer on Right, LH—Transformer on Left**

Catalog No.	kV Rating	Fuse Range	Enclosure Type	RH / LH
HVL405DEGR	4.76	10–450E	NEMA 1	RH
HVL405DEGL	4.76	10–450E	NEMA 1	LH
HVL405DEWRH	4.76	10–450E	NEMA 3R	RH
HVL405DEWLH	4.76	10–450E	NEMA 3R	LH
HVL415DEGR1	15	10–100E	NEMA 1	RH
HVL415DEGR2	15	125–200E	NEMA 1	RH
HVL415DEGL1	15	10–100E	NEMA 1	LH
HVL415DEGL2	15	125–200E	NEMA 1	LH
HVL415DEWR1H	15	10–100E	NEMA 3R	RH
HVL415DEWR2H	15	125–200E	NEMA 3R	RH
HVL415DEWL1H	15	10–100E	NEMA 3R	LH
HVL415DEWL2H	15	125–200E	NEMA 3R	LH

**Table 11.41: 600 A “Duplex” Switch with PROVISIONS ONLY for Square D™ brand Current-Limiting, Non-Disconnect Type Fuses for Cable Connection to Power-Dry II, Power-Cast II, and Uni-Cast II Transformers (FLC = 300 A max.) RH—Transformer on Right, LH—Transformer on Left**

Catalog No.	kV Rating	Fuse Range	Enclosure Type	RH / LH
HVL505DEGR	4.76	10–450E	NEMA 1	RH
HVL505DEGL	4.76	10–450E	NEMA 1	LH
HVL505DEWRH	4.76	10–450E	NEMA 3R	RH
HVL505DEWLH	4.76	10–450E	NEMA 3R	LH
HVL515DEGR1	15	10–100E	NEMA 1	RH
HVL515DEGR2	15	125–200E	NEMA 1	RH
HVL515DEGL1	15	10–100E	NEMA 1	LH
HVL515DEGL2	15	125–200E	NEMA 1	LH
HVL515DEWR1H	15	10–100E	NEMA 3R	RH
HVL515DEWR2H	15	125–200E	NEMA 3R	RH
HVL515DEWL1H	15	10–100E	NEMA 3R	LH
HVL515DEWL2H	15	125–200E	NEMA 3R	LH

**Table 11.42: 600 A “Single” Switch with PROVISIONS ONLY for S&C Boric Acid Non-Disconnect Type Fuses for Cable Connection to Power-Dry II, Power-Cast II, and Uni-Cast II Transformers [9]**

(FLC = 300 A max.) RH—Transformer on Right, LH—Transformer on Left

Catalog No.	kV Rating	Fuse Range	Enclosure Type	RH / LH
HVL405BGR	4.76	10E–400E	NEMA 1	RH
HVL405BGL	4.76	10E–400E	NEMA 1	LH
HVL405BWRH	4.76	10E–400E	NEMA 3R	RH
HVL405BWLH	4.76	10E–400E	NEMA 3R	LH
HVL415BGR	15	10E–400E	NEMA 1	RH
HVL415BGL	15	10E–400E	NEMA 1	LH
HVL415BWRH	15	10E–400E	NEMA 3R	RH
HVL415BWLH	15	10E–400E	NEMA 3R	LH

[9] Includes fuse holder only. See Table 11.46 Boric Acid Fuses, page 11-32 for fuse refills. Boric acid fuses may increase lead times. Contact the factory for availability.

Class 6040 / Refer to Catalog 6040CT9201 or Brochure 6040BR9401

**Table 11.43: 600 A “Duplex” Switch with PROVISIONS ONLY for S&C Boric Acid Non-Disconnect Type Fuses for Cable Connection to Power-Dry II, Power-Cast II, and Uni-Cast II Transformers [10]**  
(FLC = 300 A max.) RH—Transformer on Right, LH—Transformer on Left

Catalog No.	kV Rating	Fuse Range	Enclosure Type	RH / LH
HVL505BGR	4.76	10E–400E	NEMA 1	RH
HVL505BGL	4.76	10E–400E	NEMA 1	LH
HVL505BWRH	4.76	10E–400E	NEMA 3R	RH
HVL505BWLH	4.76	10E–400E	NEMA 3R	LH
HVL515BGR	15	10E–400E	NEMA 1	RH
HVL515BGL	15	10E–400E	NEMA 1	LH
HVL515BWRH	15	10E–400E	NEMA 3R	RH
HVL515BWLH	15	10E–400E	NEMA 3R	LH

**NOTE:** Switches with transformer connections are painted ANSI 49. Standalone switches are painted ANSI 61.

### Fuse Selection

The rule of thumb method for selecting fuses for transformer protection is 1.33 times the self-cooled full load current of the transformer or the next higher fuse rating. Selection of the fuse is the customer’s responsibility and should be based on transformer and system characteristics.

- **Maximum Fuse Size:**  
Maximum fuse size should be determined by comparing the fuse total clearing curve to the transformer damage curve. Contact Schneider Electric for transformer overload and short-circuit withstand capability.
- **Minimum Fuse Size:**  
Minimum fuse size shall carry the transformer magnetizing inrush current of 12 times full load amperes for 0.1 second.

**Table 11.44: Factory Modifications**

Catalog No.	Description
HVMB	Main Bus Kit, 600 A copper
HVLC	Line side connector kit (main bus) 600 A with 2–1/0=500 MCM lugs (bottom entry only) Provisions for key interlocks—Type KFL Kirk key lock with a 0-inch bolt projection (Kirk item master number KFL000010SH)
HVLX3	Auxiliary switch 2 N.O.—2 N.C. contact
HVLC2	Set screw type lugs 1/0—500 kcmil (qty. 3)
<b>Distribution Class Surge Arresters [11]</b>	
HVDSA3	3 kV, 2.55 MCOV
HVDSA6	6 kV, 5.10 MCOV
HVDSA9	9 kV, 7.65 MCOV
HVDSA10	10 kV, 8.40 MCOV
HVDSA12	12 kV, 10.20 MCOV
HVDSA15	15 kV, 12.70 MCOV

### Standard Features

- Switches for transformer primaries are cable connected only.
- Key interlocks must be ordered and coordinated by customer.
- Standard color is ANSI 61 for standalone units; ANSI 49 for switches connecting to transformers.
- If switches are purchased to coordinate with Square D™ brand transformers, composite drawings and shipment coordination will not be available.
- Switches are not designed for any special dimensions for retrofit purposes. For dimensions other than shown, contact your nearest Schneider Electric sales office or your local Schneider Electric distributor.

### Ordering Information

1. Select switch catalog number based on fused or unfused and enclosure type.
2. Select catalog numbers for factory modifications from the table above.
3. If fused, select fuse from Table 11.45 DIN/E Current-Limiting Fuses, Non-Disconnecting Type (Extended Travel Blown Fuse Indicator), page 11-31 or Table 11.46 Boric Acid Fuses, page 11-32.
4. Price switch and fuses separately. Switches are furnished with provisions only for current-limiting fuse or boric acid fuse.

[10] Includes fuse holder only. See Table 11.46 Boric Acid Fuses, page 11-32 for fuse refills. Boric acid fuses may increase lead times. Contact the factory for availability.

[11] Load side connected



**Square D™ Brand DIN/E Fuse Selection Tables—HVL**

**Table 11.45: DIN/E Current-Limiting Fuses, Non-Disconnecting Type [12][13][14] (Extended Travel Blown Fuse Indicator)**

Continuous Current	Fuse Mounting Clip [15]		Catalog No. [16][17]
	Centers (in)	Diameter (mm)	
<b>5 kV Fuse</b>			
10E	17.4	51	55DE010
15E	17.4	51	55DE015
20E	17.4	51	55DE020
25E	17.4	51	55DE025
30E	17.4	51	55DE030
40E	17.4	51	55DE040
50E	17.4	51	55DE050
65E	17.4	51	55DE065
80E	17.4	51	55DE080
100E	17.4	51	55DE100
125E	17.4	76	55DE125
150E	17.4	76	55DE150
175E	17.4	76	55DE175
200E	17.4	76	55DE200
250E	17.4	76	55DE250
300E	17.4	76	55DE300
350E	17.4	76	55DE350
400E	17.4	76	55DE400
450E	17.4	76	55DE450
<b>15 kV Fuse</b>			
10E	17.4	51	175DE010
15E	17.4	51	175DE015
20E	17.4	51	175DE020
25E	17.4	51	175DE025
30E	17.4	51	175DE030
40E	17.4	76	175DE040
50E	17.4	76	175DE050
65E	17.4	76	175DE065
80E	17.4	76	175DE080
100E	17.4	88	175DE100
125E	21.14	88	175DE125
150E	21.14	88	175DE150
175E	21.14	88	155DE175
200E	21.14	88	155DE200

[12] Square D™ brand DIN/E fuses are shown in this table. For fuses produced by other manufacturers, contact your nearest Schneider Electric sales office or your local Schneider Electric distributor.

[13] Current-limiting fuses will increase the integrated short-circuit ratings beyond the non-fusible units. Contact your nearest Schneider Electric sales office or your local Schneider Electric distributor.

[14] Caution—These fuses will not work for the MiniBreak. See Table 11.17 Current-Limiting Fuses, page 11-17 for the appropriate MiniBreak fuses.

[15] All fuses are single barrel arrangement with ferrule diameters per the chart.

[16] Contact your Schneider Electric representative for current stock quantities.

[17] Includes one set of three fuses, packed in a single box.

Class 6040 / Refer to Catalog 6040CT9201 or Brochure 6040BR9401

**Boric Acid Fuse Selection Tables—HVL**

**Table 11.46: Boric Acid Fuses [18]**

Continuous Current	Fuse Type [19]	Catalog No.	Fuse Type [20]	Catalog No. [21][22]
<b>5 kV Fuse Refill</b>				
10E	SM-5S	5SM5010	RBA400	405WBAF010
15E	SM-5S	5SM5015	RBA400	405WBAF015
20E	SM-5S	5SM5020	RBA400	405WBAF020
25E	SM-5S	5SM5025	RBA400	405WBAF025
30E	SM-5S	5SM5030	RBA400	405WBAF030
40E	SM-5S	5SM5040	RBA400	405WBAF040
50E	SM-5S	5SM5050	RBA400	405WBAF050
65E	SM-5S	5SM5065	RBA400	405WBAF065
80E	SM-5S	5SM5080	RBA400	405WBAF080
100E	SM-5S	5SM5100	RBA400	405WBAF100
125E	SM-5S	5SM5125	RBA400	405WBAF125
150E	SM-5S	5SM5150	RBA400	405WBAF150
175E	SM-5S	5SM5175	—	—
200E	SM-5S	5SM5200	RBA400	405WBAF200
250E	SM-5S	5SM5250	RBA400	405WBAF250
300E	SM-5S	5SM5300	RBA400	405WBAF300
400E	SM-5S	5SM5400	RBA400	405WBAF400
<b>15 kV Fuse Refill</b>				
10E	SM-5S	15SM5010	RBA400	415WBAF010
15E	SM-5S	15SM5015	RBA400	415WBAF015
20E	SM-5S	15SM5020	RBA400	415WBAF020
25E	SM-5S	15SM5025	RBA400	415WBAF025
30E	SM-5S	15SM5030	RBA400	415WBAF030
40E	SM-5S	15SM5040	RBA400	415WBAF040
50E	SM-5S	15SM5050	RBA400	415WBAF050
65E	SM-5S	15SM5065	RBA400	415WBAF065
80E	SM-5S	15SM5080	RBA400	415WBAF080
100E	SM-5S	15SM5100	RBA400	415WBAF100
125E	SM-5S	15SM5125	RBA400	415WBAF125
150E	SM-5S	15SM5150	RBA400	415WBAF150
175E	SM-5S	15SM5175	—	—
200E	SM-5S	15SM5200	RBA400	415WBAF200
250E	SM-5S	15SM5250	RBA400	415WBAF250
300E	SM-5S	15SM5300	RBA400	415WBAF300
400E	SM-5S	15SM5400	RBA400	415WBAF400

[18] S&C Boric Acid Fuses

Type SM-5S fuses are manufactured by the S&C Electric Company. SM-5S has a 25.0 kA symmetrical short-circuit rating from 2.4 kV to 17.0 kV. For 16.5 kV ratings, only S&C boric acid fuses can be used.

[19] Cutler-Hammer - Westinghouse Fuses

Type RBA-400 fuses are manufactured by Cutler-Hammer - Eaton Corporation. RBA-400 has a 37.5 kA symmetrical ampere short-circuit rating from 2.4 kV to 4.8 kV and 29.4 kA symmetrical from 12 kV to 13.8 kV.

[20] Caution—These fuses will not work for the MiniBreak. See Table 11.17 Current-Limiting Fuses, page 11-17 for the appropriate MiniBreak fuses.

[21] Contact your Schneider Electric representative for current stock quantities.

[22] Includes one set of three fuses, packed in a single box.



Listed Metal-Enclosed Interrupter Switchgear



**GHA Gas-Insulated Switchgear (UL Listed)**

Easy, innovative, and economical up to 38kV

GHA Medium Voltage (MV) switchgear is an ideal solution for a variety of applications and requirements. GHA is well suited for public and industrial distribution networks, infrastructure projects, petrochemical oil and gas industries, and container substations to name a few. This compact and modular switchgear offers both flexibility and a long, low-maintenance service life.

Each section consists of sealed-for-life SF<sub>6</sub> modules, which contain the fixed vacuum circuit breaker, disconnect switch, and innovative busbar system. By design, there is no gas handling throughout the service life of the equipment, from installation until recycling at the end of life of the switchgear. Utilize the cutting-edge B-link busbar to easily install, extend, or replace gear in the middle of a lineup, without handling SF<sub>6</sub>. Like the gas-filled modules, the B-link system does not require any maintenance.

Front accessible and ideal for a variety of applications, GHA represents the new generation of robust, extremely compact, and low maintenance MV switchgear.

**Table 11.47: Ratings**

Rated Voltage (kV)	Rated Lightning Impulse Withstand Voltage (kV)	Rated Power Frequency Withstand Voltage (kV)	Rated Short-Time Withstand Current (kA)	Rated Busbar Current (A)	Rated Current of Outgoing Feeders with Natural Cooling (A)	Arc Resistant per IEEE C37.20.7
12	75	28	40	2500	2500	40 ka duration for 0.5 seconds
15	95	38	40	2500	2500	
27	125	50	40	2500	2500	
38	170	80	40	2500	2500	

**Table 11.48: Dimensions**

Electrical Characteristics		Dimensions (in./mm)				
Rated Voltage (kV)	Rated nominal current (A)	Cubical Width			Depth	Section Height
		Main/Feeder	Bus Tie with Circuit Breaker	Bus Sectionalizer		
12 17.5 24 38	≤ 1200	23.6/600	31.5/800	23.6/600	62.8/1595	94.5/2400 (with 31.5/800 LV compartment)
	2500	35.5/900	39.4/1000	23.6/600	62.8/1595	

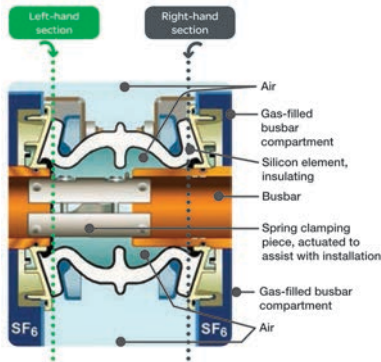



Listed Metal-Enclosed  
Interrupter Switchgear

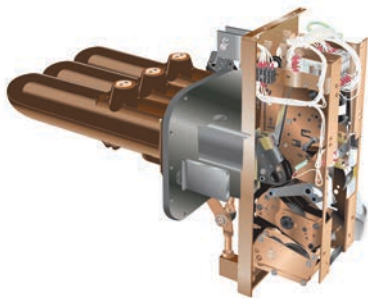

CBGS-0 Circuit Breaker

**CBGS-0 Gas-Insulated Switchgear (UL Listed)**

Easy innovative and economical up to 38kV

CBGS-0 Medium Voltage (MV) switchgear is compact and easy to install and operate. Due to the insulating gas as well as the solidly insulated busbar and cable connections the medium voltage circuit is protected from environmental influences reducing the risk of arc flash events.

Each section consists of a sealed-for-life SF<sub>6</sub> tank which contains the fixed SF range circuit breaker and disconnect switch. By design there is no gas handling throughout the service life of the equipment from installation until recycling at the end of life of the switchgear.

Front accessible and ideal for a variety of applications from transformer substations to primary power distribution in markets ranging from mining and metals renewable installations container substations and heavy industry where space is at a premium.

**Table 11.49: Ratings**

Rating	Main/Feeder	Bus Section	Bus Riser	Disconnecting Switch	Auxiliary Services
Nominal voltage (kV)	15 27 38	15 27 38	15 27 38	15 27 38	15 27 38
Busbar system rated current (A)	1200/2000	1200/2000	1200/2000	1200/2000	1200/2000
Outgoing rated current (A)	1200/2000	1200/2000	1200/2000	1200/2000	—
Short-time withstand current (kA)	25–31.5	25–31.5	25–31.5	25–31.5	Limited by the fuse

**Table 11.50: General Electrical Characteristics**

Rated Voltage		kV Rating	
		27	38
Rated Insulation Level	Power frequency 60 Hz. (efficient kV)	60	70
	Lightning impulse withstand voltage (kV peak)	125	150
Rated normal current (A)	Busbar system	1200/2000	
	Incoming/outgoing	1200/2000	
Short circuit breaking current (kA)		25/31.5	
Short circuit breaking current (kA peak)		63/80	
Short time withstand current (kA/s)		Max 25/2–31.5/2	
Gas pressure at 200 °C (psi)		18.85	
Standard degrees of protection	High voltage compartment	IP65	
	Low voltage compartment	IP3X–IP41	

**Table 11.51: Dimensions and Weights**

Modular Functional Unit (s)	Continuous Current Rating (A)	Dimensions Inches (mm)			Weight lbs. (kg)
		Width	Depth	Height	
Main/feeder bus section	1200	23.5 (598)	55.1 (1400)	92.5 (2350)	1598 (725)
	2000	47.2 (1198)			2249 (1020)
Bus riser disconnecting switch	1200	23.5 (598)			1058 (480)
	2000	47.2 (1198)			2052 (930)
VT auxiliary section	Not applicable	23.5 (598)		926 (420)	

11 SWITCHBOARDS AND SWITCHGEAR

**DVCAS Switchgear for Wind Farm Applications**

DVCAS medium voltage (MV) switchgear from Schneider Electric is designed to meet the electrical switching, protection, and connection needs of wind farm applications up to 38 kV. Three different modules are available:

- Transformer protection module D
- Outgoing line module O
- Incoming line module I

For standard wind power applications, a maximum of four modules can be connected in various configurations to provide the most commonly used wind power functions.

DVCAS switchgear is designed, manufactured, and tested in accordance with the following standards:

- C37.20.3
- C37.54
- CAN/CSA C22.2 No.31-M89
- UL Listed
- IEEE Cable Bushings

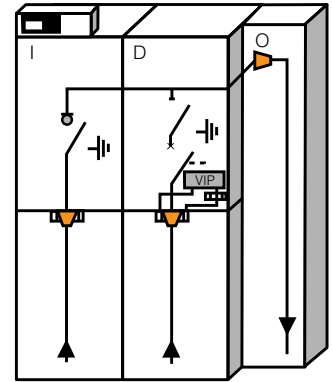

Typical IDO Configuration

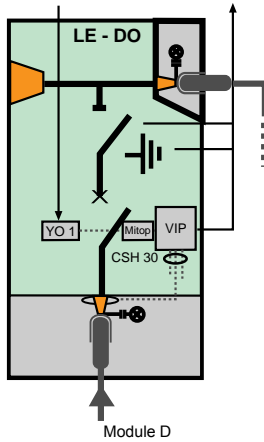

Module D

**Transformer Protection Module D**

DVCAS switchgear module D provides transformer protection. Construction features include:

- Metal base frame
- Operating mechanism and relay compartment
  - disconnector operating mechanism
  - operating mechanism of the circuit breaker
  - protection relay VIP, Sepam, or Micom
  - zero sequence current transformer CSH 30
- MV cable compartment
  - bushings for cable connection
  - Three CRc current sensors per phase
- Stainless steel, gas-tight tank
  - busbar system
  - three position disconnector
  - circuit breaker

### Outgoing Line Module O

DVCAS switchgear module O functions as an outgoing line to a downstream wind generator. There are two medium voltage cables per phase. Construction features include:

- Metal base frame
- Voltage presence indicator
- MV cable compartment
  - bushings for cable connection
  - clamps for MV cable connection

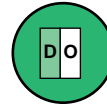

**D + O**  
Transformer protection + Outgoing line

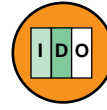

**(I + D + O)**  
Incoming line + Transformer protection + Outgoing line

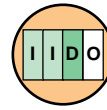

**(I + I + D + O)**  
Two Incoming lines + Transformer protection + Outgoing line

**Recommended Configurations**

### Incoming Line Module I

DVCAS switchgear module I is a three-position switch-disconnector. It is recommended for the incoming line function from an upstream wind generator for the following reasons:

- Reduces downtime caused by faults
- Helps with fault detection
- Reduces interruptions due to maintenance work
- Improves energization works

Module I is always connected to module D on the right with single-phase, coupling bushings. Construction features include:

- Metal base frame
  - operating mechanism of the switch-disconnector
  - motor for the operating mechanism (optional)
- MV cable compartment
  - bushings for cable connection
- Stainless steel, gas-tight tank
  - busbar system
  - three position disconnector

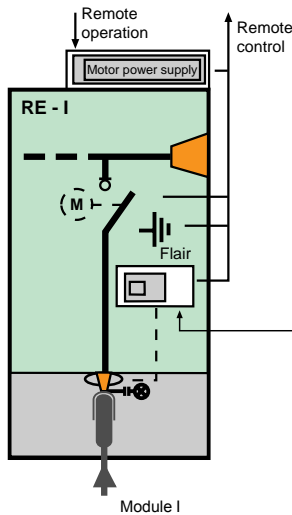

**Table 11.52: Ratings**

Type	Rating
Frequency (Hz)	50/60
Rated voltage (kV)	38
<b>Insulation level</b>	
Power frequency withstand voltage (kV)	70
Lightning impulse withstand voltage, peak (kV)	170
Rated current of the main busbar (A)	600
Short time withstand current (kA/s)	20/3 [1]
Short circuit breaking current capacity (kA)	20 [1]
Short circuit making capacity, peak (kA)	50
Internal arc withstand IAC AFL (kA/1s)	20 [1]
<b>Degree of protection (NEMA/IP)</b>	
HV compartment	6/67
LV and operating mechanism compartment	6P/3X
SF6 gas pressure at 20 °C (PSI/bar)	4.35/0.3

[1] 25 kA for circuit breaker switchgear module D.



Listed Metalclad Switchgear



Two-high Masterclad 5–27 kV Indoor, Metalclad Switchgear



Vacuum VR Circuit Breaker for Masterclad Switchgear



Masterclad 27 kV, Outdoor Non Walk-in, Metalclad Switchgear

**Masterclad™ Medium Voltage Metalclad Switchgear (UL Listed)  
The Reliability of a Quality Design**

The quality of Square D™ brand Masterclad medium voltage metalclad switchgear stems from a design and manufacturing process that focuses on long-term switchgear performance with the highest degree of reliability.

Based on specific customer application needs, Schneider Electric engineers and technicians select the appropriate standard sections and bus configurations, with the ability to customize where needed. After the specified circuit breakers, instrument and control power transformers, relays, meters and other components are selected and approved. All are factory-assembled, wired, and tested as a complete assembly.

**Table 11.53: Ratings**

Nominal voltage (kV)	4.16		7.2		13.8		24.9			
Maximum voltage (kV)	4.76		8.25		15.0		27.0			
BIL (kV)	60		95		95		125			
Frequency (Hz)	50/60									
Continuous amperes (A)	1200–4000									
MVA (reference only)	250	350	500	500	750	1000	1500	1250	2000	
Short-time rating (kA) 3 seconds	40	50	63	50	25	40	50	63	25	40
Close and latch rating (kA) (peak)	104	130	164	130	65	104	130	164	68	108

**Type VR Vacuum Circuit Breaker**

The VR breaker is a horizontal drawout type designed to provide long life, reduced maintenance, and ease of handling. The Type RI advanced design motor-charged stored energy mechanism is a model of reliability with simplicity-with an operating life exceeding ANSI requirements. The VR circuit breaker is UL labeled and includes a permanently mounted manual charging handle.

Standard features include:

- 3-cycle interrupting rating
- Rated per ANSI/IEEE C37.06, C37.09, C37.013, C37.54
- UL Listed
- Motor operated, spring-charged, stored-energy operating mechanism
- Permanently mounted manual charging handle
- Five normally open and normally closed auxiliary contacts
- Wheels that roll directly to floor level from lower cell

**Switchgear Construction**

- High-speed operation—3–cycles
- Removable (draw-out) circuit breaker
- Grounded metal barriers enclose all live parts
- Automatic shutters driven by breaker racking mechanism
- Closed door breaker position indication
- Closed door breaker racking mechanism
- Insulated main bus—aluminum or copper
- Standard glass polyester insulators or optional epoxy and porcelain insulators
- Mechanical interlocks
- Disconnect type CPT and VT trucks
- Grounded breaker truck in and between test/disconnected and connected positions
- Low voltage instrument/control compartment isolated from primary voltage areas
- Compliance to ANSI/IEEE standards C37.20.2 and C37.55 (designed and tested to comply with or exceed ANSI and IEEE standards)
- ISO 9001 Certification (Designed and manufactured in a facility that is Quality Systems Certified by Underwriters Laboratories, Inc.® to ISO 9001)
- Indoor NEMA 1 enclosure
- Outdoor NEMA 3R enclosure
  - Walk-in enclosure
  - Non walk-in enclosure

## Active, Arc-Resistant

### Arc Terminator™ Arc Extinguishing System

Active system detects and controls the effects of internal arcing faults. It complies with ANSI C37.20.7 requirements for arc-resistant switchgear for Type 1, Type 2B, and Type 2C enclosures, even with the switchgear doors open.

In the event of a confirmed arcing fault inside a Masterclad switchgear or Motorpact equipment lineup containing an Arc Terminator (AT) system, the AT system provides a low impedance parallel path to effectively transfer the fault current from the arc to the 3-phase main bus assembly of the switchgear.

The AT system consists of the following components:

- A high-speed closing, or shorting, switch is designed to close on the main bus of the switchgear. This creates a three-phase short circuit fault confined to the main bus. Upstream protective device must clear fault within allowed time per applicable standard.
- The controller box is the central processing device that responds to the signals given by the current sensors and the optical sensors. The current sensor module and the control logic process incoming current and optical signals and send a signal to the output triggering circuit. The output triggering circuit releases stored energy to initiate closing of the mechanical switch and provides optical isolation to prevent false triggering
- Optical sensors are located in each medium voltage compartment within switchgear structures. A dedicated, properly sized set of current transformers is located at the incoming power source(s).

#### Benefits

- Prevents pressure buildup
- Reduces release of toxic materials
- Eliminates need for reinforced switchgear
- Eliminates special requirements for buildings or plenums
- Minimizes equipment damage
- Reduces operating downtime



Arc Terminator™  
Arc Extinguishing System

## Passive, Arc-Resistant

### Masterclad™ Medium Voltage Switchgear

This switchgear and all its components meet the IEEE C37.20.7 arc-resistant test guideline for Type 2B enclosures as well as all other applicable ANSI, UL, and CSA standards for metalclad switchgear.

Switchgear Construction:

- Arc exhaust options: vented, arc shield, arc planum and duct
- High-speed operation—3-cycles
- Removable (draw-out) circuit breaker
- Fully compartmentalized construction
- Grounded metal barriers enclose all live parts
- Automatic shutters driven by breaker racking mechanism
- Closed door breaker position indication
- Closed door breaker racking mechanism
- Insulated copper main bus
- Standard glass polyester supports
- Mechanical interlocks
- Disconnect type CPT and VT trucks
- Grounded breaker truck in and between test/disconnected and connected positions
- Low voltage instrument/control compartment isolated from primary voltage areas
- Compliance to ANSI standards C37.06, C37.09, C37.013, C37.54 and C37.55 (designed and tested to comply with or exceed ANSI and IEEE standards)

#### Ratings

- Up to 63 kA arc containment for 0.5 seconds
- Voltage ratings from 2.4 kV to 15 kV up to 4,000 A
- Type 2B construction, one- and two-high structures



Two-high, Masterclad 5–15 kV  
Metalclad, Arc-Resistant Switchgear





Unit Substation

**Power-Zone Load Center Unit Substations**

**Table 11.54: Complete Close Coupled Unit Substations Available**

Product Type	Class Nos.	Digest Section No.
<b>Primary Section</b>		
Medium voltage load interrupter switchgear	6040, 6045	11
Metalclad switchgear	6055	
Low voltage Power-Style™ QED switchboard	2741–2744	
Air terminal chamber	7240, 7310, 7320, 7421–23	
<b>Transformer Section</b>		
Open, ventilated dry—Power-Dry™	7421–23	14
Open, ventilated dry/cast resin combination—Uni-Cast™	7320	
Open, ventilated cast resin—Power-Cast™	7310	
Mineral oil or high fire point fluid—liquid	7240	
<b>Secondary Section</b>		
Medium voltage load interrupter switchgear	6040	11
Metalclad switchgear	6055	
Medium voltage motor control center	8198	
Low voltage Power-Style QED switchboard	2741–2744	
Air terminal chamber	7240, 7310, 7320, 7421–23	
Low voltage drawout switchgear	6037	
Low voltage Model 6 motor control centers	8998	17



Model III Package Unit Substation with HVL/cc Load Interrupter Switch (on left)

**Power-Zone Model III Package Unit Substations**

**General**

Power-Zone Model III package unit substations combine a primary switch, dry-type transformer, and I-Line™ distribution section into a single, compact unit. All components are engineered, manufactured, and tested by Schneider Electric. The substation is available with a UL listing.

The Model III is only 49 inches deep and 90 inches high, which allows the entire substation to pass through standard size doorways and narrow hallways.

The Model III is front accessible; the transformer taps are accessible from the side. For proper ventilation, a minimum distance of 12 inches should be maintained on the transformer side of the equipment.

Model III package unit substations are ideal for renovations and high rise applications requiring increased customer electrical demand as well as new construction requiring multiple zones and a small footprint.

**75–1000 kVA at 480 V; 75–500 kVA at 240 V**

Available with primary voltages of 2400–13800 V. Forced air cooling (AA/FA) provides an additional 33%. Features 220 °C insulation and 150 °C, 115 °C, or 80 °C temperature rise. Largest 80 °C or 115 °C rise unit available is 750 kVA.

The secondary circuit breaker distribution section may be equipped with an individually mounted secondary main breaker or an I-Line distribution panelboard. Branch circuit breakers from PowerPact™ B to PowerPact RLC 1200 A may be installed. PowerPact M-, P-, and R-frame molded case circuit breakers are available with electronic trip units.

Additional options include PowerLogic™ and ION™ series metering, surge arresters, and I-Line™ plug-on units with a Surgeloc™ Surge Protective Device (SPD).

**Incoming Line Section**

Most Model IIIs are supplied with a Square D™ brand fused HVL/cc 600 A load interrupter switch. The HVL/cc offers the smallest footprint in the industry and is an exclusive sealed interruption type compartmentalized switch. Where switching and overcurrent protection are provided elsewhere, a full-height air-filled terminal chamber can be provided in place of the switch.

**Table 11.55: Primary Switch Ratings, Type HVL/cc**

Nominal Voltage	4.16	13.8
BIL	60	95
Continuous amperes	600	600
Interrupting amperes	600	600
Fault close (kA asymmetrical)	40	40
Momentary current (kA asymmetrical 10 cycles)	40	40
Duty-cycle-fault-close (number of operations)	4	4
Grounding switch fault close (kA asymmetrical)	40	40
Short-time rating (kA asymmetrical 2 seconds)	25	25
Dielectric withstand (kV 1 minute)	19	36
Electrical endurance (close-open)	100	100
Mechanical endurance (close-open)	1000	1000

**Transformer Section**

Special barrel wound dry-type transformers employing resin encapsulated VPI (Vacuum Pressure Impregnation) techniques are used to achieve the low-loss, compact design necessary for the space-saving package substation concept. Class H, 220 °C insulation is used throughout. Temperature rise is 150 °C as standard, although 80 °C or 115 °C low temperature premium transformers are available through 750 kVA. Aluminum windings are standard with copper as an option. Four full capacity 2-1/2 percent taps are provided—two above nominal voltage and two below.

Fan cooling is optional. When selected, it increases the capacity rating of the transformer an additional 33 percent. The Model 98 digital controller is employed. This system provides precision control through the use of three high accuracy thermocouple type sensors—one in each phase of the windings.

The controller has a membrane front panel for displaying the temperature of all three phases with individual readings. The hottest phase is automatically displayed. The Model 98 digital controller features simple three-button operation with fan, alarm and trip function settings and is Powerlogic™ compatible.

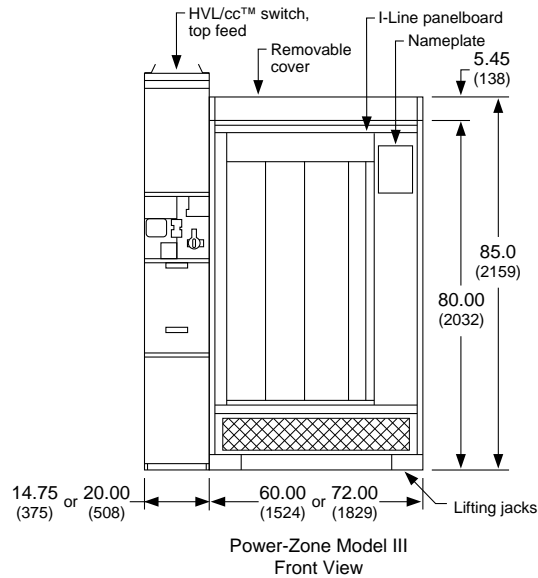

**Table 11.56: Transformer Basic Insulation Levels**

KV Class	Primary Voltages	BIL	600 Hz Test
1.2	< 600 V Secondary	10	4 kV
2.5	2400	20	10 kV
5.0	4160, 4800	30	12 kV
7.2	6900, 7200	30	12 kV
8.7	8320	45	19 kV
15.0	12, 12.47, 13.2, 13.8	60	31 kV

**Distribution Section**

**I-Line™ Mounted Molded Case Circuit Breakers**

Molded case circuit breakers are group mounted in an I-Line panelboard section offering the inherent ease of installation for which the plug-on I-Line circuit breaker has become known. All circuit breakers are quick-make, quick-break, thermal magnetic, permanent trip type and are factory-calibrated and sealed for accurate overcurrent response and maximum short-circuit strength. PowerPact™ P and R circuit breakers are available with solid-state MicroLogic™ trip units. Current limiting high interrupting capacity FI, KI, and LI circuit breakers are also available. Circuit breakers may be safely back-fed for use as main circuit breakers. All circuit breakers are UL listed and carry integrated equipment rating when used exclusively with other Square D™ brand circuit breakers in intended assemblies.

I-Line panel is available in 1200 A. Maximum mounting space is 108 inches. Tin-plated copper bus is standard.

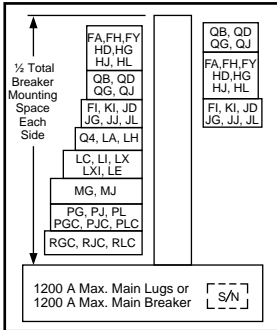
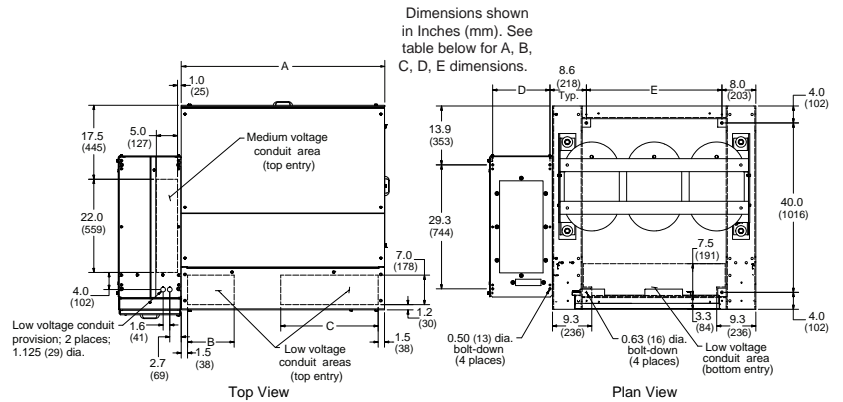

HCR-U 1200 A I-Line panelboards can be used for up to 600 Vac. They are UL Listed under File E33139.

**Table 11.57: Substation Dimensions and Approximate Weights**

kVA	Temperature Rise °C	Dimensions (for above drawings)					Estimated Weight
		A	B	C	D	E	
75	80, 115, 150	48	11.0	23.0	13.5	32.0	3600
112.5							
150							
225							
300	80, 115, 150	48	11.0	23.0	13.5	32.0	4500
500							6000
500	80, 115	60	18.5	27.0	18.75	44.0	6200
750							6700
1000							7500

Contact your nearest Schneider Electric sales office for ordering assistance.



Listed Controllers

### Motorpact™ Medium Voltage Motor Controllers (UL Listed)

Square D™ brand Motorpact medium voltage motor controllers from Schneider Electric are designed and manufactured to tackle the toughest power and process control challenges. Our motor controllers feature industry-first innovations that provide unmatched performance, high reliability, low maintenance and exclusive technologies. Motorpact medium voltage motor controllers are designed to provide the most efficient means to control and protect a wide range of applications and may be configured for motor starting, transformer feeders, capacitor feeders, or future spaces. The design has fewer losses inside the controller, providing more efficient use of power for the connected load.

Motorpact controllers are designed to meet or exceed the standards for NEMA ICS3 Part 2, UL Standard 347, and IEC 60470. UL and cULus labels are standard.

Starting application for squirrel cage induction motors:

- Full voltage non-reversing
- Full voltage reversing
- 2-speed, 2-winding, 2-speed, 1-winding
- Reduced voltage non-reversing
  - Auto transformers
  - Solid state soft start
  - Sequential soft start (S3) multi-motor starting

Enclosures are available in NEMA Type 1, 1A, and 3R and feature the smallest footprint in the industry at 14.75 inches wide. Enclosures that are 20 inches and 29.5 inches wide are also available for FVNR.

Optional arc resistant enclosures are available that meet IEEE C37.20.7.

Units are designed as one-high construction for ease of use with a optimum height for the operator controls and isolation switch disconnect handle.

Full front and or front and rear accessibility are provided. A full height cable pulling area is standard.

Controller voltage ratings range from 2.3–7.2 kV vacuum contactors feature a drawout design and have ratings of 200, 400, 450, and 720 A.

Options include live line indicators, blown fuse tripping, solid state protective relays, power factor correction capacitors, surge arresters, surge capacitors and a cable grounding switch.

# Section 12

## Busway



Powerbus 100-400 A

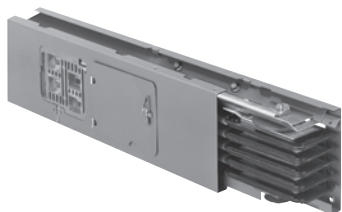

I-Line Plug-in Busway 225-600 A

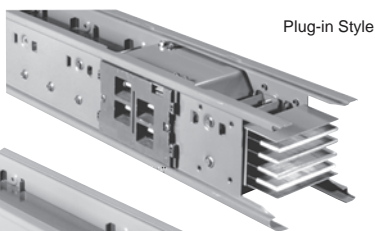

Plug-in Style

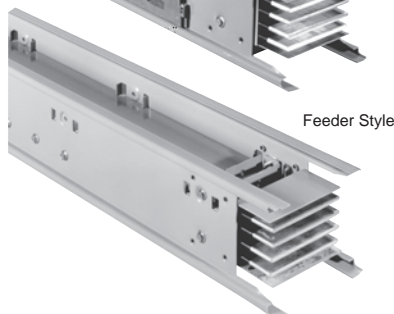

Feeder Style

I-Line II Busway 800-5000 A



I-Line Plug-in Units

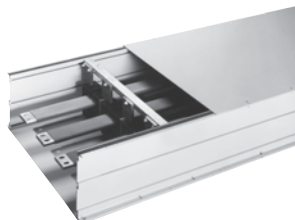

Power-Zone Busway

<b>Powerbus™ Busway</b>	<b>12-2</b>
Powerbus™ Busway	12-2
Powerbus Plug-In Units	12-3
Powerbus Plug-in Units with Metering	12-5
<b>I-Line™ Busway</b>	<b>12-6</b>
Standard Components	12-6
<b>I-Line™ II Busway</b>	<b>12-7</b>
800 A–5000 A Busway	12-7
I-Line™ II Straight Lengths, Fittings, and Accessories	12-7
800 A to 5000 A “Factory Assembled” Busway Systems (or Components)	12-9
Additions, Accessories, and Electrical Data	12-10
Electrical Data for I-Line II Busway	12-10
Plug-In Units	12-10
Fusible Plug-In Units, Class R Fuse Kits, and Hooksticks	12-10
Surge Protective Device Plug-In Units	12-11
PowerPact™ H-, and J-Frame Plug-in Units	12-12
PowerPact™ H-, J-, and L-Frame Plug-in Units with Electronic Trip	12-13
H-, J-, and L-Frame Plug-In Units with Electronic Trip and Communication	12-15
PowerPact™ M-Frame Plug-in Units with Basic Electronic Trip	12-15
PowerPact™ P-Frame Plug-in Units	12-16
PowerPact™ R-Frame Plug-in Units	12-17
<b>Power-Zone™ Busway</b>	<b>12-18</b>
Non-Segregated Bus	12-18

### Distinct service advantages make your Busway installation “hassle-free”

- **Missing Link** program guarantees shipment in a maximum of 5 working days of a small quantity (10 pieces or less) of standard indoor feeder straight lengths and fittings for US destinations. Orders for international destinations require 2 additional days for processing. The quantity of working days guaranteed by this program excludes the day of receipt of the order. Contact your local sales office for outdoor busway and for additional details of this program.
- **Measurement Services** are offered for your critical and complex projects. Schneider Electric will assist with field measurement and assume responsibility for the layout and exact fit of all components. Contact your local Schneider Electric sales office for exact details.
- **Emergency Service**; we are on call 24 hours a day, 7 days a week, 365 days a year. For emergencies, call 1-888-SquareD (1-888-778-2733).
- **Quick Ship** program provides product availability for time sensitive orders. The program is available through the product selectors and offers a limited selection of I-Line busway footage and fittings. Contact your local Schneider Electric sales office for exact details.

### Powerbus Busway Construction

Powerbus busway construction consists of a light-weight electrical grade all-aluminum housing with up to five (5) silver-plated copper conductor bars for maximum electrical efficiency. The total product offer includes straight sections, fittings, accessories, and plug-in units for a total installation. This busway is available in 400 A, 225 A and 100 A ratings. A 50% integral ground is standard.

### Straight Sections

Straight sections of busway are available in 10 ft. and 4 ft. lengths in a painted black finish. The Enhanced busway offer includes 10 plug-in openings on each side of a 10 ft. section and 3 plug-in openings on each side of a 4 ft. section.

### Metering and Communications Options

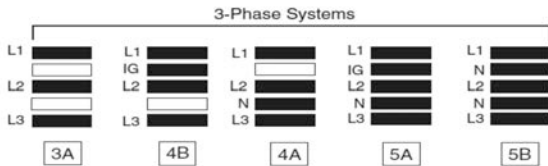

Single phase systems and DC systems are also available. Contact your local Schneider Electric representative.

Powerbus busway tap boxes and plug-in units are available with optional metering and communication capabilities, which include an integrated display and the ability to remotely monitor the busway.

Table 12.1: 3Ø3W—Powerbus Straight Lengths and Fittings—600 V Maximum

Amperage	Component	Configuration 3A—Catalog No.[1]	Configuration 4B—Catalog No.[1]
100 A	Enhanced Straight 10 ft.	PBCE3A100AST120B	PBCE4B100AST120B
	Enhanced Straight 4 ft.	PBCE3A100AST048B	PBCE4B100AST048B
	Elbow – Left	PBCF3A100ALLB	PBCF4B100ALLB
	Elbow – Right	PBCF3A100ALRB	PBCF4B100ALRB
	Cross Fitting	PBCF3A100ACRB	PBCF4B100ACRB
	Tap Box	PBCF3A100ATBB	PBCF4B100ATBB
	Tap Box w/Meter[2][3]	PBCF3A100ATBM( )B	PBCF4B100ATBM( )B
225 A	Enhanced Straight 10 ft.	PBCE3A225AST120B	PBCE4B225AST120B
	Enhanced Straight 4 ft.	PBCE3A225AST048B	PBCE4B225AST048B
	Elbow – Left	PBCF3A225ALLB	PBCF4B225ALLB
	Elbow – Right	PBCF3A225ALRB	PBCF4B225ALRB
	Cross Fitting	PBCF3A225ACRB	PBCF4B225ACRB
	Tap Box	PBCF3A225ATBB	PBCF4B225ATBB
	Tap Box w/Meter[3]	PBCF3A225ATBM( )B	PBCF4B225ATBM( )B
400 A	Enhanced Straight 10 ft.	PBCE3A400AST120B	PBCE4B400AST120B
	Enhanced Straight 4 ft.	PBCE3A400AST048B	PBCE4B400AST048B
	Elbow – Left	PBCF3A400ALLB	PBCF4B400ALLB
	Elbow – Right	PBCF3A400ALRB	PBCF4B400ALRB
	Cross Fitting	PBCF3A400ACRB	PBCF4B400ACRB
	Tap Box	PBCF3A400ATBB	PBCF4B400ATBB
	Tap Box w/Meter[3]	PBCF3A400ATBM( )B	PBCF4B400ATBM( )B

Table 12.2: 3Ø4W—Straight Lengths and Fittings—600 V Maximum

Amperage	Component	Configuration 4A—Catalog No.[1]	Configuration 5A—Catalog No.[1]	Configuration 5B—Catalog No.[1]
100 A	Enhanced Straight 10 ft.	PBCE4A100AST120B	PBCE5A100AST120B	PBCE5B100AST120B
	Enhanced Straight 4 ft.	PBCE4A100AST048B	PBCE5A100AST048B	PBCE5B100AST048B
	Elbow – Left	PBCF4A100ALLB	PBCF5A100ALLB	PBCF5B100ALLB
	Elbow – Right	PBCF4A100ALRB	PBCF5A100ALRB	PBCF5B100ALRB
	Cross Fitting	PBCF4A100ACRB	PBCF5A100ACRB	PBCF5B100ACRB
	Tap Box	PBCF4A100ATBB	PBCF5A100ATBB	PBCF5B100ATBB
	Tap Box w/Meter[2][3]	PBCF4A100ATBM( )B	PBCF5A100ATBM( )B	PBCF5B100ATBM( )B
225 A	Enhanced Straight 10 ft.	PBCE4A225AST120B	PBCE5A225AST120B	PBCE5B225AST120B
	Enhanced Straight 4 ft.	PBCE4A225AST048B	PBCE5A225AST048B	PBCE5B225AST048B
	Elbow – Left	PBCF4A225ALLB	PBCF5A225ALLB	PBCF5B225ALLB
	Elbow – Right	PBCF4A225ALRB	PBCF5A225ALRB	PBCF5B225ALRB
	Cross Fitting	PBCF4A225ACRB	PBCF5A225ACRB	PBCF5B225ACRB
	Tap Box	PBCF4A225ATBB	PBCF5A225ATBB	PBCF5B225ATBB
	Tap Box w/Meter[3]	PBCF4A225ATBM( )B	PBCF5A225ATBM( )B	PBCF5B225ATBM( )B
400 A	Enhanced Straight 10 ft.	PBCE4A400AST120B	PBCE5A400AST120B	PBCE5B400AST120B
	Enhanced Straight 4 ft.	PBCE4A400AST048B	PBCE5A400AST048B	PBCE5B400AST048B
	Elbow – Left	PBCF4A400ALLB	PBCF5A400ALLB	PBCF5B400ALLB
	Elbow – Right	PBCF4A400ALRB	PBCF5A400ALRB	PBCF5B400ALRB
	Cross Fitting	PBCF4A400ACRB	PBCF5A400ACRB	PBCF5B400ACRB
	Tap Box	PBCF4A400ATBB	PBCF5A400ATBB	PBCF5B400ATBB
	Tap Box w/Meter[3]	PBCF4A400ATBM( )B	PBCF5A400ATBM( )B	PBCF5B400ATBM( )B

[1] Busway catalog numbers shown include a black painted finish. Contact your local Schneider Electric representative for a natural aluminum finish option.

[2] For 100 A busway only, add an (L), for top cable access, or a (U), for bottom cable access, before the last letter in the catalog no., which is (B).

[3] Replace the ( ) in the Tap Box w/Meter catalog number with the meter suffix number in Table 12.3 Meter Suffix Number, page 12-3. The meter will be configured based on system voltage.

**Table 12.3: Meter Suffix Number**

Meter Suffix	System Voltage
1	208Y/120 V 3Ø4W
2	240 V 3Ø3W
4	415/240 V 3Ø4W
5	480Y/277 V 3Ø4W

**Table 12.4: Accessories<sup>[4]</sup>**

Description	100 A	225 A	400 A
	Catalog No.	Catalog No.	Catalog No.
Standard Hanger	PB100FH	PB225FH	PB400FH
Side Mount Hanger	PB100HFW	PB225HFW	PB400HFW
Vertical Sway Brace	PB100VSB	PB225VSB	PB400VSB
End Closure	PB100AEC	PB225AEC	PB400AEC
Wall Flange	PB100WF	PB225WF	PB400WF
Plug-in Opening Cover	PBPIOCVR	PBPIOCVR	PBPIOCVR

**Table 12.5: Hooksticks**

Length	Catalog No.
8'	515608
14'	515614
4'—8' extension pole <sup>[5]</sup>	PBHS0408
8'—15' extension pole <sup>[5]</sup>	PBHS0815

**Powerbus Plug-In Units**

Powerbus plug-in units are rated maximum 100 A and may be offered as field installable or factory assembled units. All units conform to NEMA type 1. An optional kit is available for QO units to raise the protection to IP54. This kit raises the QOR unit to moisture protection of IPX3.

**Three-Phase Systems**

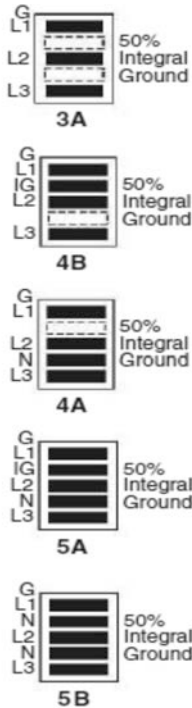

**Table 12.6: Plug-In Units—Circuit breakers not included**

Busbar Configuration	3 Spaces for QO/QOB Circuit Breakers	3 Spaces for QO/QOB Circuit Breakers	3 Spaces for QO/QOB Circuit Breakers 3 Openings for Receptacles <sup>[6]</sup>
	Tap Box <sup>[7]</sup>	QO Unit	QOR Unit
	Catalog Number	Catalog Number	Catalog Number
4B	PBPTB4B100	PBPQO4B100	PBPQOR4B100
3A	PBPTB3A100	PBPQO3A100	PBPQOR3A100
4A	PBPTB4A100	PBPQO4A100	PBPQOR4A100
5A	PBPTB5A100	PBPQO5A100	PBPQOR5A100

[4] For the NetShelter™ IT Rack-Mounting Bracket, refer to 5600CT9101.  
 [5] For single-pole operation on QO and ED circuit breakers.  
 [6] Certain NEMA receptacles can be field installed in this unit. Consult your local Schneider Electric representative.  
 [7] Plug-in tap box to be installed on 100 A and 225 A busways only.

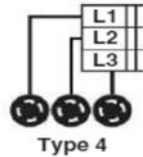
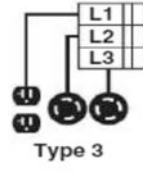
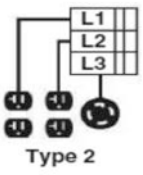
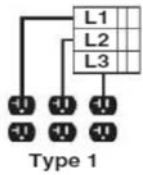

Table 12.7: 120 V Factory Assembled Units: 1-pole QO/QOB circuit breakers with NEMA 5-15R or 5-20R receptacles<sup>[8][9]</sup>

Circuit Breaker Rating	Type	4A Configuration Catalog Number	5A Configuration Catalog Number	5B Configuration Catalog Number
<b>Type 1 (3 circuit breakers w. 3 duplex receptacles)</b>				
15	QO	PBPQOR4A100M115	PBPQOR5A100M115	PBPQOR5B100M115
15	QOB	PBPQOR4A100M115B	PBPQOR5A100M115B	PBPQOR5B100M115B
20	QO	PBPQOR4A100M120	PBPQOR5A100M120	PBPQOR5B100M120
20	QOB	PBPQOR4A100M120B	PBPQOR5A100M120B	PBPQOR5B100M120B
<b>Type 2 (3 circuit breakers w. 2 duplex/1 locking recept.)</b>				
15	QO	PBPQOR4A100M215	PBPQOR5A100M215	PBPQOR5B100M215
15	QOB	PBPQOR4A100M215B	PBPQOR5A100M215B	PBPQOR5B100M215B
20	QO	PBPQOR4A100M220	PBPQOR5A100M220	PBPQOR5B100M220
20	QOB	PBPQOR4A100M220B	PBPQOR5A100M220B	PBPQOR5B100M220B
<b>Type 3 (3 circuit breakers w. 1 duplex/2 locking recept.)</b>				
15	QO	PBPQOR4A100M315	PBPQOR5A100M315	PBPQOR5B100M315
15	QOB	PBPQOR4A100M315B	PBPQOR5A100M315B	PBPQOR5B100M315B
20	QO	PBPQOR4A100M320	PBPQOR5A100M320	PBPQOR5B100M320
20	QOB	PBPQOR4A100M320B	PBPQOR5A100M320B	PBPQOR5B100M320B
<b>Type 4 (3 circuit breakers w. 3 locking receptacles)</b>				
15	QO	PBPQOR4A100M415	PBPQOR5A100M415	PBPQOR5B100M415
15	QOB	PBPQOR4A100M415B	PBPQOR5A100M415B	PBPQOR5B100M415B
20	QO	PBPQOR4A100M420	PBPQOR5A100M420	PBPQOR5B100M420
20	QOB	PBPQOR4A100M420B	PBPQOR5A100M420B	PBPQOR5B100M420B

Table 12.8: Factory Assembled Units: One (1) QOU circuit breaker and one (1) drop cord with connector<sup>[10][11]</sup>

Circuit Breaker Rating	Poles	NEMA Connector	Drop Cord Length (ft)	4A Configuration Catalog Number	5A Configuration Catalog Number	5B Configuration Catalog Number
15 A	1	L5-15	3	PBPQOU4A100COOL515	PBPQOU5A100COOL515	PBPQOU5B100COOL515
20 A	1	L5-20	3	PBPQOU4A100COOL520	PBPQOU5A100COOL520	PBPQOU5B100COOL520
30 A	1	L5-30	3	PBPQOU4A100COOL530	PBPQOU5A100COOL530	PBPQOU5B100COOL530
15 A	2	L6-15	3	PBPQOU4A100COOL615	PBPQOU5A100COOL615	PBPQOU5B100COOL615
20 A	2	L6-20	3	PBPQOU4A100COOL620	PBPQOU5A100COOL620	PBPQOU5B100COOL620
30 A	2	L6-30	3	PBPQOU4A100COOL630	PBPQOU5A100COOL630	PBPQOU5B100COOL630
20 A	3	L21-20	3	PBPQOU4A100COOL2120	PBPQOU5A100COOL2120	PBPQOU5B100COOL2120
30 A	3	L21-30	3	PBPQOU4A100COOL2130	PBPQOU5A100COOL2130	PBPQOU5B100COOL2130
15 A	1	L5-15	6	PBPQOU4A100FOOL515	PBPQOU5A100FOOL515	PBPQOU5B100FOOL515
20 A	1	L5-20	6	PBPQOU4A100FOOL520	PBPQOU5A100FOOL520	PBPQOU5B100FOOL520
30 A	1	L5-30	6	PBPQOU4A100FOOL530	PBPQOU5A100FOOL530	PBPQOU5B100FOOL530
15 A	2	L6-15	6	PBPQOU4A100FOOL615	PBPQOU5A100FOOL615	PBPQOU5B100FOOL615
20 A	2	L6-20	6	PBPQOU4A100FOOL620	PBPQOU5A100FOOL620	PBPQOU5B100FOOL620
30 A	2	L6-30	6	PBPQOU4A100FOOL630	PBPQOU5A100FOOL630	PBPQOU5B100FOOL630
20 A	3	L21-20	6	PBPQOU4A100FOOL2120	PBPQOU5A100FOOL2120	PBPQOU5B100FOOL2120
30 A	3	L21-30	6	PBPQOU4A100FOOL2130	PBPQOU5A100FOOL2130	PBPQOU5B100FOOL2130

[8] Many more factory assembled units are available using combinations of 1P/2P/3P circuit breakers with other NEMA receptacles. Maximum of 3 breaker spaces available. Consult your local Schneider Electric representative.  
 [9] See Digest Section 7, QO™ and QOU Miniature Circuit Breakers, page 7-11 for QOU circuit breaker information.  
 [10] Factory assembled units are available using combinations of 1P/2P/3P circuit breakers with other NEMA and IEC type receptacles. Maximum of three drop cords with six breaker spaces available. Consult your local Schneider Electric representative.  
 [11] See Digest Section 7, QO™ and QOU Miniature Circuit Breakers, page 7-11 for QOU circuit breaker information. Catalog numbers shown have the breaker in the top slot in the front cover and the drop cord in the left position in the base of the unit. Other combinations are available.



**Powerbus Plug-in Units with Metering**

Powerbus plug-in units with metering are rated maximum 100 A and are offered as factory assembled units. All units conform to NEMA type 1.

**Table 12.9: Factory Assembled Units with NEMA Connectors and Metering<sup>[12][13]</sup>**

Circuit Breaker		NEMA Connector	Drop Cord Length (ft)	Catalog Number <sup>[14][15]</sup>		
Rating	Poles			4A Configuration	5A Configuration	5B Configuration
15 A	1	L5-15	3	PBPEDU4A100COOL515M( )	PBPEDU5A100COOL515M( )	PBPEDU5B100COOL515M( )
20 A	1	L5-20	3	PBPEDU4A100COOL520M( )	PBPEDU5A100COOL520M( )	PBPEDU5B100COOL520M( )
30 A	1	L5-30	3	PBPEDU4A100COOL530M( )	PBPEDU5A100COOL530M( )	PBPEDU5B100COOL530M( )
15 A	2	L6-15	3	PBPEDU4A100COOL615M( )	PBPEDU5A100COOL615M( )	PBPEDU5B100COOL615M( )
20 A	2	L6-20	3	PBPEDU4A100COOL620M( )	PBPEDU5A100COOL620M( )	PBPEDU5B100COOL620M( )
30 A	2	L6-30	3	PBPEDU4A100COOL630M( )	PBPEDU5A100COOL630M( )	PBPEDU5B100COOL630M( )
20 A	3	L21-20	3	PBPEDU4A100COOL2120M( )	PBPEDU5A100COOL2120M( )	PBPEDU5B100COOL2120M( )
30 A	3	L21-30	3	PBPEDU4A100COOL2130M( )	PBPEDU5A100COOL2130M( )	PBPEDU5B100COOL2130M( )
15 A	1	L5-15	6	PBPEDU4A100FOOL515M( )	PBPEDU5A100FOOL515M( )	PBPEDU5B100FOOL515M( )
20 A	1	L5-20	6	PBPEDU4A100FOOL520M( )	PBPEDU5A100FOOL520M( )	PBPEDU5B100FOOL520M( )
30 A	1	L5-30	6	PBPEDU4A100FOOL530M( )	PBPEDU5A100FOOL530M( )	PBPEDU5B100FOOL530M( )
15 A	2	L6-15	6	PBPEDU4A100FOOL615M( )	PBPEDU5A100FOOL615M( )	PBPEDU5B100FOOL615M( )
20 A	2	L6-20	6	PBPEDU4A100FOOL620M( )	PBPEDU5A100FOOL620M( )	PBPEDU5B100FOOL620M( )
30 A	2	L6-30	6	PBPEDU4A100FOOL630M( )	PBPEDU5A100FOOL630M( )	PBPEDU5B100FOOL630M( )
20 A	3	L21-20	6	PBPEDU4A100FOOL2120M( )	PBPEDU5A100FOOL2120M( )	PBPEDU5B100FOOL2120M( )
30 A	3	L21-30	6	PBPEDU4A100FOOL2130M( )	PBPEDU5A100FOOL2130M( )	PBPEDU5B100FOOL2130M( )

**Table 12.10: Factory Assembled Units with IEC Connectors and Metering<sup>[12][13]</sup>**

Circuit Breaker		IEC 60309 Connector <sup>[16]</sup>	Drop Cord Length (ft)	Catalog Number <sup>[15][17]</sup>		
Rating	Poles			4A Configuration	5A Configuration	5B Configuration
20	2	2-Pole, 3-Wire Grounding	3	PBPEDU4A100COOS3420M( )	PBPEDU5A100COOS3420M( )	PBPEDU5B100COOS3420M( )
30	2	2-Pole, 3-Wire Grounding	3	PBPEDU4A100COOS3430M( )	PBPEDU5A100COOS3430M( )	PBPEDU5B100COOS3430M( )
60	2	2-Pole, 3-Wire Grounding	3	PBPEDU4A100COOS3460M( )	PBPEDU5A100COOS3460M( )	PBPEDU5B100COOS3460M( )
20	3	3-Pole, 4-Wire Grounding	3	PBPEDU4A100COOS4420M( )	PBPEDU5A100COOS4420M( )	PBPEDU5B100COOS4420M( )
30	3	3-Pole, 4-Wire Grounding	3	PBPEDU4A100COOS4430M( )	PBPEDU5A100COOS4430M( )	PBPEDU5B100COOS4430M( )
60	3	3-Pole, 4-Wire Grounding	3	PBPEDU4A100COOS4460M( )	PBPEDU5A100COOS4460M( )	PBPEDU5B100COOS4460M( )
20	3	4-Pole, 5-Wire Grounding	3	PBPEDU4A100COOS5420M( )	PBPEDU5A100COOS5420M( )	PBPEDU5B100COOS5420M( )
30	3	4-Pole, 5-Wire Grounding	3	PBPEDU4A100COOS5430M( )	PBPEDU5A100COOS5430M( )	PBPEDU5B100COOS5430M( )
60	3	4-Pole, 5-Wire Grounding	3	PBPEDU4A100COOS5460M( )	PBPEDU5A100COOS5460M( )	PBPEDU5B100COOS5460M( )

**Table 12.11: Meter Suffix Number**

Meter Suffix <sup>[18]</sup>	System Voltage
1	208Y/120 V 3Ø4W
2	240 V 3Ø3W
4	415/240 V 3Ø4W
5	480Y/277 V 3Ø4W

**Table 12.12: Gateway Plug-in Unit (480 V Max)<sup>[19]</sup>**

4A Configuration	5A Configuration	5B Configuration
Catalog No.	Catalog No.	Catalog No.
PBPEGX4A100T	PBPEGX5A100T	PBPEGX5B100T

**Table 12.13: NEMA Receptacles and Connectors<sup>[20]</sup>**

Wiring	Voltage	NEMA Non-Locking			NEMA Locking		
		15 A	20 A	30 A	15 A	20 A	30 A
2-pole, 3-wire grounding	120	5-15	5-20	5-30	L5-15	L5-20	L5-30
2-pole, 3-wire grounding	240	6-15	6-20	6-30	L6-15	L6-20	L6-20
3-pole, 4-wire grounding	120/240	14-15	14-20	14-30	—	L14-20	L14-30
3-pole, 4-wire grounding	3Ø 240	15-15	15-20	15-30	—	L15-20	L15-30
4-pole, 5-wire grounding	3ØY 120/208	—	—	—	—	L21-20	L21-30

**Table 12.14: Short Circuit Current Rating<sup>[21]</sup>**

Product	Short-Circuit Current Rating KA, RMS Symmetrical UL 3-Cycle Test
100 A	14 kA
225 A	22 kA
400 A	35 kA

[12] See Digest Section 9, For NF Merchandised Panelboards, page for ED circuit breaker information. Catalog numbers shown have the breaker in the top slot in the front cover and the drop cord in the left position in the base of the unit. Other combinations are available. The Power Meter display will be located below the breaker space. For remote monitoring capabilities, a gateway is required. The gateway is located in the tap box with metering or in a separate gateway plug-in unit listed below. The units with metering can be daisy-chained together back to the gateway. A maximum of 30 units should be daisy-chained together to one gateway.

[13] Factory assembled units are available using combinations of 1P/2P/3P circuit breakers with other NEMA and IEC type receptacles. Maximum of three drop cords with three breaker spaces available. Consult your local Schneider Electric representative.

[14] For IP54 splash resistant construction, add an "M54" suffix.

[15] For metering, replace ( ) in catalog number with the appropriate number in Table 12.11 Meter Suffix Number, page 12-5. Connectors must be rated for appropriate voltages.

[16] Other IEC Connectors are available.

[17] For the offer without metering, do not use the suffix "M" or any numbers following.

[18] Replace ( ) in above tables with the appropriate meter suffix number. Connectors must be rated for appropriate voltages.

[19] For remote monitoring capabilities, a gateway is required. The gateway is located in the tap box with metering or in a separate gateway plug-in unit listed above. Units with metering can be daisy-chained together back to the gateway. A maximum of 30 units should be daisy-chained together to one gateway.

[20] Additional NEMA, IEC, and California Standard type receptacles and connectors are available.

[21] See 5600CT9101 for fuse and circuit breaker series connected ratings.

I-Line™ Standard Components and Accessories

Table 12.15: Standard Components—Aluminum

Aluminum		G PH PH PH N		G PH PH PH N		G PH PH PH N		G PH PH PH N		G PH PH PH N	
Number of Poles and Voltage	Rating (A)	10'-0" Length	6'-0" Length	Front Elbow <sup>[1]</sup>	Top Elbow <sup>[1]</sup>	Plug-In Tee	Plug-In Tap Box				
		Catalog No.	Catalog No.	Catalog No.	Catalog No.	Catalog No.	Catalog No.				
3Ø3W	225	AP30210	AP3026	AP302LF ( )	AP302LT ( )	PTT23W	PTB302				
	400	AP30410	AP3046	AP304LF ( )	AP304LT ( )	PTT33W	PBTB306				
	600	AP30610	AP3066	AP306LF ( )	AP306LT ( )	PTT43W	PBTB306				
3Ø4W	225	AP50210	AP5026	AP502LF ( )	AP502LT ( )	PTT24W	PTB502				
	400	AP50410	AP5046	AP504LF ( )	AP504LT ( )	PTT34W	PBTB506				
	600	AP50610	AP5066	AP506LF ( )	AP506LT ( )	PTT44W	PBTB506				
3Ø3W + Integral Ground Bus	225	AP302G10	AP302G6	AP302GLF ( )	AP302GLT ( )	PTT23WG	PTB302G				
	400	AP304G10	AP304G6	AP304GLF ( )	AP304GLT ( )	PTT33WG	PBTB306G				
	600	AP306G10	AP306G6	AP306GLF ( )	AP306GLT ( )	PTT43WG	PBTB306G				
3Ø4W + Integral Ground Bus	225	AP502G10	AP502G6	AP502GLF ( )	AP502GLT ( )	PTT24WG	PTB502G				
	400	AP504G10	AP504G6	AP504GLF ( )	AP504GLT ( )	PTT34WG	PBTB506G				
	600	AP506G10	AP506G6	AP506GLF ( )	AP506GLT ( )	PTT44WG	PBTB506G				

Table 12.16: Standard Components—Copper

Copper		G PH PH PH N		G PH PH PH N		G PH PH PH N		G PH PH PH N		G PH PH PH N	
Number of Poles and Voltage	Rating (A)	10'-0" Length	6'-0" Length	Front Elbow <sup>[1]</sup>	Top Elbow <sup>[1]</sup>	Plug-In Tee	Plug-In Tap Box				
		Catalog No.	Catalog No.	Catalog No.	Catalog No.	Catalog No.	Catalog No.				
3Ø3W	225	CP30210	CP3026	CP302LF ( )	CP302LT ( )	PTT23W	PTB302				
	400	CP30410	CP3046	CP304LF ( )	CP304LT ( )	PTT33W	PBTB306				
	600	CP30610	CP3066	CP306LF ( )	CP306LT ( )	PTT43W	PBTB306				
3Ø4W	225	CP50210	CP5026	CP502LF ( )	CP502LT ( )	PTT24W	PTB502				
	400	CP50410	CP5046	CP504LF ( )	CP504LT ( )	PTT34W	PBTB506				
	600	CP50610	CP5066	CP506LF ( )	CP506LT ( )	PTT44W	PBTB506				
3Ø3W + Integral Ground Bus	225	CP302G10	CP302G6	CP302GLF ( )	CP302GLT ( )	PTT23WG	PTB302G				
	400	CP304G10	CP304G6	CP304GLF ( )	CP304GLT ( )	PTT33WG	PBTB306G				
	600	CP306G10	CP306G6	CP306GLF ( )	CP306GLT ( )	PTT43WG	PBTB306G				
3Ø4W + Integral Ground Bus	225	CP502G10	CP502G6	CP502GLF ( )	CP502GLT ( )	PTT24WG	PTB502G				
	400	CP504G10	CP504G6	CP504GLF ( )	CP504GLT ( )	PTT34WG	PBTB506G				
	600	CP506G10	CP506G6	CP506GLF ( )	CP506GLT ( )	PTT44WG	PBTB506G				

Table 12.17: Common Accessories

Ampere Rating		Hanger <sup>[2]</sup>				End Closure	Wall Flange	Floor Flange
Aluminum	Copper	Flatwise	Vertical	Edgewise	Seismic	Catalog No.	Catalog No.	Catalog No.
225	225	HP2F	HP2V	HP3E	HP2SH	ACP2EC	ACP2WF	ACP2FF
400	400	HP3F	HP3V	HP3E	HP3SH	ACP3EC	ACP3WF	ACP3FF
—	600	HP3F	HP3V	HP3E	HP3SH	ACP3EC	ACP3WF	ACP3FF
600	—	HP5F	HP4V	HP5E	HP5SH	ACP4EC	ACP4WF	ACP4FF

[1] Add "I" for inside elbow; add "O" for outside elbow.

[2] For seismic applications, seismic hangers must be used with horizontal mount flatwise or edgewise busway. Vertical mount busway may use standard fixed or spring hangers.

I-Line™ II Straight Lengths, Fittings, and Accessories

Table 12.18: Straight Lengths (10 ft.) and Plug-in Tap Box

Number of Poles	Ampere Rating	Aluminum		Both Aluminum and Copper	Copper	
		G PH PH PH N	G PH PH PH N	G PH PH PH N	G PH PH PH N	G PH PH PH N
		10'0" Length		Plug-In Tap Box <sup>[1][2]</sup>	10'0" Length	
Feeder Style <sup>[3]</sup>		Plug-In Style <sup>[4]</sup>	Catalog No.	Feeder Style <sup>[3]</sup>		Plug-In Style <sup>[4]</sup>
Catalog No.		Catalog No.		Catalog No.		Catalog No.
3Ø3W + Integral Ground Bus	800	AF2308G10ST	AP2308G10ST	PTB316G ( )	CF2308G10ST	CP2308G10ST
	1000	AF2310G10ST	AP2310G10ST	PTB316G ( )	CF2310G10ST	CP2310G10ST
	1200	AF2312G10ST	AP2312G10ST	PTB316G ( )	CF2312G10ST	CP2312G10ST
	1350	AF2313G10ST	AP2313G10ST	PTB316G ( )	CF2313G10ST	CP2313G10ST
	1600	AF2316G10ST	AP2316G10ST	PTB316G ( )	CF2316G10ST	CP2316G10ST
	2000	AF2320G10ST	AP2320G10ST	—	CF2320G10ST	CP2320G10ST
	2500	AF2325G10ST	AP2325G10ST	—	CF2325G10ST	CP2325G10ST
	3000	AF2330G10ST	AP2330G10ST	—	CF2330G10ST	CP2330G10ST
	3200	—	—	—	CF2332G10ST	CP2332G10ST
	4000	AF2340G10ST	AP2340G10ST	—	CF2340G10ST	CP2340G10ST
5000	—	—	—	CF2350G10ST	CP2350G10ST	
3Ø4W + Integral Ground Bus	800	AF2508G10ST	AP2508G10ST	PTB516G ( )	CF2508G10ST	CP2508G10ST
	1000	AF2510G10ST	AP2510G10ST	PTB516G ( )	CF2510G10ST	CP2510G10ST
	1200	AF2512G10ST	AP2512G10ST	PTB516G ( )	CF2512G10ST	CP2512G10ST
	1350	AF2513G10ST	AP2513G10ST	PTB516G ( )	CF2513G10ST	CP2513G10ST
	1600	AF2516G10ST	AP2516G10ST	PTB516G ( )	CF2516G10ST	CP2516G10ST
	2000	AF2520G10ST	AP2520G10ST	—	CF2520G10ST	CP2520G10ST
	2500	AF2525G10ST	AP2525G10ST	—	CF2525G10ST	CP2525G10ST
	3000	AF2530G10ST	AP2530G10ST	—	CF2530G10ST	CP2530G10ST
	3200	—	—	—	CF2532G10ST	CP2532G10ST
	4000	AF2540G10ST	AP2540G10ST	—	CF2540G10ST	CP2540G10ST
5000	—	—	—	CF2550G10ST	CP2550G10ST	

Table 12.19: Fittings (All Feeder Style)

Number of Poles	Ampere Rating	Aluminum			Copper		
		End Tap Box	Edgewise Elbow	Flatwise Elbow	End Tap Box	Edgewise Elbow	Flatters Elbow
Catalog No.		Catalog No.	Catalog No.	Catalog No.	Catalog No.	Catalog No.	
3Ø3W with Integral Ground Bus	800	AF2308GETBMB	AF2308GLEM11	AF2308GLFM11	CF2308GETBMB	CF2308GLEM11	CF2308GLFM11
	1000	AF2310GETBMB	AF2310GLEM11	AF2310GLFM12	CF2310GETBMB	CF2310GLEM11	CF2310GLFM11
	1200	AF2312GETBMB	AF2312GLEM11	AF2312GLFM13	CF2312GETBMB	CF2312GLEM11	CF2312GLFM12
	1350	AF2313GETBMB	AF2313GLEM11	AF2313GLFM13	CF2313GETBMB	CF2313GLEM11	CF2313GLFM12
	1600	AF2316GETBMB	AF2316GLEM11	AF2316GLFM13	CF2316GETBMB	CF2316GLEM11	CF2316GLFM12
	2000	AF2320GETBMB	AF2320GLEM11	AF2320GLFM15	CF2320GETBMB	CF2320GLEM11	CF2320GLFM13
	2500	AF2325GETBMB	AF2325GLEM11	AF2325GLFM17	CF2325GETBMB	CF2325GLEM11	CF2325GLFM15
	3000	AF2330GETBMB	AF2330GLEM11	AF2330GLFM18	CF2330GETBMB	CF2330GLEM11	CF2330GLFM16
	3200	—	—	—	CF2332GETBMB	CF2332GLEM11	CF2332GLFM17
	4000	AF2340GETBMB	AF2340GLEM11	AF2340GLFM22	CF2340GETBMB	CF2340GLEM11	CF2340GLFM21
5000	—	—	—	CF2350GETBMB	CF2350GLEM11	CF2350GLFM21	
3Ø4W with Integral Ground Bus	800	AF2508GETBMB	AF2508GLEM11	AF2508GLFM11	CF2508GETBMB	CF2508GLEM11	CF2508GLFM11
	1000	AF2510GETBMB	AF2510GLEM11	AF2510GLFM12	CF2510GETBMB	CF2510GLEM11	CF2510GLFM11
	1200	AF2512GETBMB	AF2512GLEM11	AF2512GLFM12	CF2512GETBMB	CF2512GLEM11	CF2512GLFM12
	1350	AF2513GETBMB	AF2513GLEM11	AF2513GLFM13	CF2513GETBMB	CF2513GLEM11	CF2513GLFM12
	1600	AF2516GETBMB	AF2516GLEM11	AF2516GLFM13	CF2516GETBMB	CF2516GLEM11	CF2516GLFM12
	2000	AF2520GETBMB	AF2520GLEM11	AF2520GLFM15	CF2520GETBMB	CF2520GLEM11	CF2520GLFM13
	2500	AF2525GETBMB	AF2525GLEM11	AF2525GLFM17	CF2525GETBMB	CF2525GLEM11	CF2525GLFM15
	3000	AF2530GETBMB	AF2530GLEM11	AF2530GLFM18	CF2530GETBMB	CF2530GLEM11	CF2530GLFM16
	3200	—	—	—	CF2532GETBMB	CF2532GLEM11	CF2532GLFM17
	4000	AF2540GETBMB	AF2540GLEM11	AF2540GLFM22	CF2540GETBMB	CF2540GLEM11	CF2540GLFM21
5000	—	—	—	CF2550GETBMB	CF2550GLEM11	CF2550GLFM21	

Table 12.20: Accessories

Ampere Rating		Hangers <sup>[5]</sup>				End Closure	Wall Flange	
Al	Cu	Horizontal Mount Busway		Vertical Mount Busway		Seismic	Catalog No.	
		Flatwise	Edgewise	Fixed	Spring			
—	800	HF38F	HF43E	HFV	HFVS1	HF38SH	ACF38EC	ACF38WF
800	1000	HF43F	HF43E	HFV	HFVS1	HF43SH	ACF43EC	ACF43WF
1000	1200	HF53F	HF58E	HFV	HFVS1	HF53SH	ACF53EC	ACF53WF
—	1350	HF58F	HF58E	HFV	HFVS2	HF58SH	ACF58EC	ACF58WF
1200	—	HF63F	HF67E	HFV	HFVS1	HF63SH	ACF63EC	ACF63WF

[1] To complete the catalog number, replace the blank with an "H" for the plug-in unit to be mounted on horizontally—oriented busway and "V" for the plug-in unit to be mounted on vertically-oriented busway.  
 [2] Cannot be used for 800 A copper busway.  
 [3] Feeder style available in lengths from 16 to 120 inches.  
 [4] Plug-in style also available in 4, 6, and 8 foot lengths.  
 [5] For seismic applications, seismic hangers must be used with horizontal mount flatwise or edgewise busway. Vertical mount busway may use standard fixed or spring hangers.

**Table 12.20 Accessories (cont'd.)**

Ampere Rating		Hangers <sup>[6]</sup>				End Closure	Wall Flange	
Al	Cu	Horizontal Mount Busway		Vertical Mount Busway		Seismic	Catalog No.	Catalog No.
		Flatwise	Edgewise	Fixed	Spring			
—	1600	HF67F	HF67E	HFV	HFVS2	HF67SH	ACF67EC	ACF67WF
1350	—	HF73F	HF78E	HFV	HFVS1	HF73SH	ACF73EC	ACF73WF
—	2000	HF78F	HF78E	HFV	HFVS2	HF78SH	ACF78EC	ACF78WF
1600	—	HF88F	HF88E	HFV	HFVS1	HF88SH	ACF88EC	ACF88WF
2000	—	HF13F	HF13E	HFV	HFVS2	HF13SH	ACF13EC	ACF13WF
—	2500	HF13F	HF13E	HFV	HFVS8	HF13SH	ACF13EC	ACF13WF
2500	—	HF16F	HF16E	HFV	HFVS2	HF16SH	ACF17EC	ACF17WF
—	3000	HF15F	HF15E	HFV	HFVS8	HF15SH	ACF15EC	ACF15WF
—	3200	HF16F	HF16E	HFV	HFVS8	HF16SH	ACF17EC	ACF17WF
3000	—	HF19F	HF19E	HFV	HFVS8	HF19SH	ACF19EC	ACF19WF
4000	—	HF26F	HF26E	HFV	HFVS8	HF26SH	ACF26EC	ACF26WF
—	4000	HF24F	HF24E	HFV	HFVS8	HF24SH	ACF24EC	ACF24WF
—	5000	HF25F	HF26E	HFV	HFVS8	HF25SH	ACF25EC	ACF25WF

<sup>[6]</sup> For seismic applications, seismic hangers must be used with horizontal mount flatwise or edgewise busway. Vertical mount busway may use standard fixed or spring hangers.

### Standard Straight Lengths

The basic component of a busway system is a straight section with a “joint pak” factory-affixed to one end. Plug-in busway is available in standard lengths of 4, 6, 8, and 10 feet. Feeder busway is available in lengths from 16” to 120” in increments of 1”.

### Riser Busway

We also offer a “Riser” Plug-In busway with openings on one side only for riser installations. This busway offers the same short circuit ratings as our standard plug-in busway.

### Indoor Drip Resistant and IP54 Splash Resistant Busway

These water resistant features are available as an option for indoor plug-in and feeder busway.

### Outdoor Construction

Outdoor construction is only available in feeder busway. It prevents the entry of rain and can be installed in any mounting position.

### High Short Circuit Bracing

I-Line busway is available with either standard short circuit bracing or high short circuit bracing. [Electrical Data for I-Line II Busway, page 12-10](#) lists maximum short circuit ratings for each busway type and rating.

### Hangers

Indoor horizontal busway requires one hanger for every 10 feet of busway. Vertical indoor busway requires one hanger for every 16 feet. Outdoor feeder busway requires one hanger for every 5 feet in horizontal mounting and one hanger for every 10 feet in vertical mounting.

### Elbows

90° elbows are standard. 91° elbows to 179° elbows in 1° increments are also available.

### Tee

90° flatwise tees fittings are standard. Edgewise tees and crosses are also available.

### Indoor Tap Boxes

Feeder cable tap boxes are used at the end (-ETBMB) or center (-CTB) of a busway run and incorporate a short section of busway into their construction. See [5600CT9101](#) for the length of the tap box.

Plug-in cable tap boxes are plugged into the side of the busway (at any opening except the very last opening of a run).

Lugs other than standard mechanical lugs are available.

### Service Heads

Service heads are of outdoor construction and include Square D<sup>™</sup> brand standard lugs.

### Unfused Reducer

Unfused reducers are used to reduce from a higher amperage busway to a lower amperage.

**NOTE:** The National Electric Code does not allow the use of unfused reducers in vertical riser installations. Refer to the NEC for restrictions in industrial installations.

### Fused or Circuit Breaker Cubicle

These are used as in-line overcurrent protection devices. They can be used in conjunction with an unfused reducer to offer a device which reduces a run of busway in ampacity and offers overcurrent protection.

### I-Line to I-Line II Adapter

This adapter is used to join I-Line II busway (800 A–5000 A) to existing installations of original I-Line busway. If connecting to an existing “slot end” of original I-Line, use a “bolt end” adapter (-12B), and vice versa.

### Expansion Fittings

The expansion fitting is built into a 3 ft. – 4 in. straight length for 800 A–5000 A and a 5 feet – 0 inch straight length for 225 A–600 A. Limit of expansion or contraction is ±1-1/2 inches. Not available in outdoor construction.

### Bussed Transformer Connection

A bussed transformer connection is used when the busway physically attaches (other than cable) to a three phase transformer. For power company vault termination information, consult the factory.

### Transformer Taps

Transformer taps are used to make cable connection to transformers. Lugs other than standard Square D brand lugs are available. Note that taps need **NOT** be located directly above transformers for cable connections.

### Connection to Competitive Busway

Consult your nearest Schneider Electric sales office.

Electrical Data for I-Line II Busway

<b>Standards:</b>	UL857 (File Number E22182); CSA C22.2 No. 27-1994 (File Number LL-61778); IEC 61439-6
<b>Systems:</b>	AC-3Ø3W, 3Ø4W, 1Ø2W, 1Ø3W. DC-2-pole. All neutrals are 100% capacity.
<b>Voltage:</b>	600 volts AC/DC, 50 Hz and 60 Hz
<b>Integral Ground:</b>	50% capacity as standard for 800 A to 5000 A, as an option on 225 A to 600 A
<b>Enclosure:</b>	Indoor, indoor drip resistant, indoor splash resistant (IP54), and outdoor (indoor drip resistant, indoor splash resistant (IP54), and outdoor are available in I-Line II [800-5000 A] busway only)

Table 12.21: Short Circuit Ratings: UL 3 Cycle Test (KA, RMS Symmetrical)<sup>[7]</sup>

Ampere Rating	Aluminum				Copper			
	AOF2 AF2	AOFH AFH2	AP AP2/AR2	APH APH2/ARH2	COF2 CF2	COFH CFH2	CP CP2/CR2	CPH CPH2/CRH2
225	—	—	22	—	—	—	22	—
400	—	—	22	42	—	—	22	42
600	—	—	22	42	—	—	22	42
800	50	85	50	75	50	85	50	75
1000	50	100	50	100	50	85	50	75
1200	50	100	50	100	50	100	50	100
1350	50	100	50	100	50	100	50	100
1600	50	100	50	100	50	100	50	100
2000	100	150	125	150	50	100	65	100
2500	100	150	125	150	100	150	125	150
3000	100	150	125	150	100	150	125	150
3200	—	—	—	—	100	150	125	150
4000	150	200	200	200	150	200	200	200
5000	—	—	—	—	150	200	200	200

Fusible Plug-In Units, Class R Fuse Kits, and Hooksticks

Table 12.22: Fusible Plug-In Units<sup>[8]</sup>

Ampere Rating	Type of Connection	240 Vac 3-Pole, 3 Fuse + G	120/208 Vac, (240 Vac Max.) 4-Pole, 3 Fuse + G	600 Vac 3-Pole, 3 Fuse + G	277/480 Vac, (600 Vac Max.) 4-Pole, 3 Fuse + G
		Catalog No.	Catalog No.	Catalog No.	Catalog No.
30	Plug-in	PQ3203G	PQ4203G	PQ3603G	PQ4603G
60		PQ3206G	PQ4206G	PQ3606G	PQ4606G
100		PQ3210G	PQ4210G	PQ3610G	PQ4610G
200		PQ3220G	PQ4220G	PQ3620G	PQ4620G
200 <sup>[9]</sup>		PS3220G <sup>[9]</sup>	PS4220G <sup>[9]</sup>	PS3620G <sup>[9]</sup>	PS4620G <sup>[9]</sup>
400		PBQ3640G <sup>[10]</sup>	PBQ4640G <sup>[10]</sup>	PBQ3640G <sup>[10]</sup>	PBQ4640G <sup>[10]</sup>
600		PBQ3660G <sup>[10]</sup>	PBQ4660G <sup>[10]</sup>	PBQ3660G <sup>[10]</sup>	PBQ4660G <sup>[10]</sup>
800	Bolt-on	—	—	PTQ36080G ( ) <sup>[11]</sup>	PTQ46080G ( ) <sup>[11]</sup>
1000		—	—	PTQ36100G ( ) <sup>[11]</sup>	PTQ46100G ( ) <sup>[11]</sup>
1200		—	—	PTQ36120G ( ) <sup>[11]</sup>	PTQ46120G ( ) <sup>[11]</sup>

**Class J Fuses** – Provisions for installing Class J fuses are included in 30 through 600 A fusible devices. Conversion to Class J fuse spacing requires relocating the load side fuse base assembly from standard Class H fuse location to an alternate position in the enclosure.



"Hook-Swing" Mounting

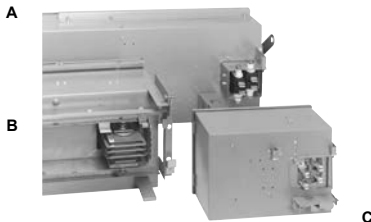

A – High Ampere Plug-In Connection  
B – High Ampere Bolt-On Connection  
C – Low Ampere Plug-In Connection

There are three different types of plug-in connections:

- High Ampere Bolt-On Connection (catalog numbers that begin with "PT")—bolted "joint pack" type connection
  - Used on I-Line/I-Line II busway amperages 800 A aluminum and greater.
  - Used on I-Line/I-Line II busway amperages 1000 A copper and greater.
- High Ampere Plug-In Connection (catalog numbers that begin with "PB")—individual bolted jaws for connections
- Low Ampere Plug-In Connection (catalog numbers that begin with "P," except for "PB" and "PT")—spring pressure jaws for connection

Table 12.23: Class R Fuse Kits<sup>[12]</sup>

Switch Size (A)	Voltage Rating	Kit <sup>[12]</sup> Catalog No.
30	250 V <sup>[13]</sup>	QMB30R
	600 V <sup>[13]</sup>	QMB36R
60	250 V <sup>[13]</sup>	QMB36R
	600 V <sup>[13]</sup>	QMB60R
100 200	All	HRK1020
400 600	All	QMB4060R

**Class R Fuse Kits** when installed reject all but class R fuses.

<sup>[7]</sup> 6-cycle and 30-cycle, and fuse/circuit breaker series connected ratings are available. Please reference 5600CT9101.

<sup>[8]</sup> For IP54 splash resistant construction, add an "M54" suffix.

<sup>[9]</sup> For use on vertical riser applications only.

<sup>[10]</sup> For vertical riser applications, order auxiliary mounting kit—Catalog Number PBQ4060RMK.

<sup>[11]</sup> This device uses bolt-on connection. It may be used only on plug-in busway with same number of poles. To complete the catalog number, replace the blank with an "H" for the plug-in unit to be mounted on horizontally-oriented busway and "V" for the plug-in unit to be mounted on vertically-oriented busway. Not for use on 800 A copper busway.

<sup>[12]</sup> Kit must be field installed.

<sup>[13]</sup> Contains parts to convert two units.

**Table 12.24: Hooksticks**

Length	Catalog No.
8'	515608
14'	515614

**Surge Protective Device Plug-In Units**

All Busway SPD Plug-In Units include as standard:

- Individually Fused Modules
- Circuit Breaker Disconnect
- Cover Mounted Diagnostic Panel
- EMI/RFI Filter
- Audible Alarm with Test/Disable/Enable

**Table 12.25: Surge Capacity**

System Voltage	160,000 Amperes Per Phase	240,000 Amperes Per Phase
	Catalog Number <sup>[14]</sup>	Catalog Number <sup>[14]</sup>
208Y/120 Vac, 3Ø4W/Grd.	PIU2IMA16	PIU2IMA24
240Y/120 Vac, 3Ø4W/Grd.	PIU3IMA16	PIU3IMA24
480Y/277 Vac, 3Ø4W/Grd.	PIU4IMA16	PIU4IMA24
600Y/347 Vac, 3Ø4W/Grd.	PIU8IMA16	PIU8IMA24

**Table 12.26: Options**

Description	When Required Add Suffix to Catalog Number
Surge Counter and Dry Contacts	—
Remote Monitor with Dry Contacts	M

[14] For IP54 splash resistant construction, add an "M54" suffix.

### H- and J-Frame Plug-In Units

**Table 12.27: H-Frame Circuit Breaker Plug-in Units—Standard (80%) Rated—3Ø3W**

Trip Rating Ampere	D Interrupting	G Interrupting	J Interrupting	L Interrupting
	Catalog No. [15]	Catalog No. [15]	Catalog No. [15]	Catalog No. [15]
<b>3Ø3W + G, 600 Vac 50/60 Hz</b>				
15	PHD36015G	PHG36015G	PHJ36015G	PHL36015G
20	PHD36020G	PHG36020G	PHJ36020G	PHL36020G
30	PHD36030G	PHG36030G	PHJ36030G	PHL36030G
40	PHD36040G	PHG36040G	PHJ36040G	PHL36040G
50	PHD36050G	PHG36050G	PHJ36050G	PHL36050G
60	PHD36060G	PHG36060G	PHJ36060G	PHL36060G
70	PHD36070G	PHG36070G	PHJ36070G	PHL36070G
80	PHD36080G	PHG36080G	PHJ36080G	PHL36080G
90	PHD36090G	PHG36090G	PHJ36090G	PHL36090G
100	PHD36100G	PHG36100G	PHJ36100G	PHL36100G
125	PHD36125G	PHG36125G	PHJ36125G	PHL36125G
150	PHD36150G	PHG36150G	PHJ36150G	PHL36150G

**Table 12.28: H-Frame Circuit Breaker Plug-in Units—Standard (80%) Rated—3Ø4W**

Trip Rating Ampere	D Interrupting	G Interrupting	J Interrupting	L Interrupting
	Catalog No. [15]	Catalog No. [15]	Catalog No. [15]	Catalog No. [15]
<b>3Ø4W + G, 600 Vac Max. 50/60 Hz</b>				
15	PHD36015GN	PHG36015GN	PHJ36015GN	PHL36015GN
20	PHD36020GN	PHG36020GN	PHJ36020GN	PHL36020GN
30	PHD36030GN	PHG36030GN	PHJ36030GN	PHL36030GN
40	PHD36040GN	PHG36040GN	PHJ36040GN	PHL36040GN
50	PHD36050GN	PHG36050GN	PHJ36050GN	PHL36050GN
60	PHD36060GN	PHG36060GN	PHJ36060GN	PHL36060GN
70	PHD36070GN	PHG36070GN	PHJ36070GN	PHL36070GN
80	PHD36080GN	PHG36080GN	PHJ36080GN	PHL36080GN
90	PHD36090GN	PHG36090GN	PHJ36090GN	PHL36090GN
100	PHD36100GN	PHG36100GN	PHJ36100GN	PHL36100GN
125	PHD36125GN	PHG36125GN	PHJ36125GN	PHL36125GN
150	PHD36150GN	PHG36150GN	PHJ36150GN	PHL36150GN

**Table 12.29: J-Frame Circuit Breaker Plug-in Units—Standard (80%) Rated—3Ø3W**

Trip Rating Ampere	D Interrupting	G Interrupting	J Interrupting	L Interrupting
	Catalog No. [15]	Catalog No. [15]	Catalog No. [15]	Catalog No. [15]
<b>3Ø3W + G, 600 Vac 50/60 Hz</b>				
175	PJD36175G	PJG36175G	PJJ36175G	PJL36175G
200	PJD36200G	PJG36200G	PJJ36200G	PJL36200G
225	PJD36225G	PJG36225G	PJJ36225G	PJL36225G
250	PJD36250G	PJG36250G	PJJ36250G	PJL36250G

**Table 12.30: J-Frame Circuit Breaker Plug-in Units—Standard (80%) Rated—3Ø4W**

Trip Rating Ampere	D Interrupting	G Interrupting	J Interrupting	L Interrupting
	Catalog No. [15]	Catalog No. [15]	Catalog No. [15]	Catalog No. [15]
<b>3Ø4W + G, 600 Vac Max. 50/60 Hz</b>				
175	PJD36175GN	PJG36175GN	PJJ36175GN	PJL36175GN
200	PJD36200GN	PJG36200GN	PJJ36200GN	PJL36200GN
225	PJD36225GN	PJG36225GN	PJJ36225GN	PJL36225GN
250	PJD36250GN	PJG36250GN	PJJ36250GN	PJL36250GN

**Table 12.31: Circuit Breaker Interrupting Ratings**

Interrupting Ratings (kA)	D	G	J	L	R
240 V	25	65	100	125	200
480 V	18	35	65	100	200
600 V	14	18	25	50	100

[15] For IP54 splash resistant construction, add an "M54" suffix.



**H-, J-, and L-Frame Plug-In Units with Electronic Trip**

**Table 12.32: H- and J-Frame Circuit Breaker Plug-in Units with Electronic Trip—Standard (80%) Rated—3Ø3W**

Trip Rating Ampere	Trip Function <sup>[16]</sup>	Trip Unit <sup>[17]</sup>	D Interrupting	G Interrupting	J Interrupting	L Interrupting
			Catalog Number <sup>[18]</sup> [19][20]	Catalog Number <sup>[18]</sup> [19][20]	Catalog Number <sup>[18]</sup> [19][20]	Catalog Number <sup>[18]</sup> [19][20]
<b>MicroLogic Standard Trip Unit</b>						
3Ø3W + G, 600 Vac 50/60 Hz						
60	LI	3.2	PHD36060GU31X	PHG36060GU31X	PHJ36060GU31X	PHL36060GU31X
100			PHD36100GU31X	PHG36100GU31X	PHJ36100GU31X	PHL36100GU31X
150			PHD36150GU31X	PHG36150GU31X	PHJ36150GU31X	PHL36150GU31X
250			PJD36250GU31X	PJG36250GU31X	PJJ36250GU31X	PJL36250GU31X
60	LSI	3.2 S	PHD36060GU33X	PHG36060GU33X	PHJ36060GU33X	PHL36060GU33X
100			PHD36100GU33X	PHG36100GU33X	PHJ36100GU33X	PHL36100GU33X
150			PHD36150GU33X	PHG36150GU33X	PHJ36150GU33X	PHL36150GU33X
250			PJD36250GU33X	PJG36250GU33X	PJJ36250GU33X	PJL36250GU33X
<b>MicroLogic Ammeter Trip Unit</b>						
3Ø3W + G, 600 Vac 50/60 Hz						
60	LSI	5.2 A	PHD36060GU43X	PHG36060GU43X	PHJ36060GU43X	PHL36060GU43X
100			PHD36100GU43X	PHG36100GU43X	PHJ36100GU43X	PHL36100GU43X
150			PHD36150GU43X	PHG36150GU43X	PHJ36150GU43X	PHL36150GU43X
250			PJD36250GU43X	PJG36250GU43X	PJJ36250GU43X	PJL36250GU43X
<b>MicroLogic Energymeter Trip Unit</b>						
3Ø3W + G, 600 Vac 50/60 Hz						
60	LSI	5.2 E	PHD36060GU53X	PHG36060GU53X	PHJ36060GU53X	PHL36060GU53X
100			PHD36100GU53X	PHG36100GU53X	PHJ36100GU53X	PHL36100GU53X
150			PHD36150GU53X	PHG36150GU53X	PHJ36150GU53X	PHL36150GU53X
250			PJD36250GU53X	PJG36250GU53X	PJJ36250GU53X	PJL36250GU53X

**Table 12.33: H- and J-Frame Circuit Breaker Plug-in Units with Electronic Trip—Standard (80%) Rated—3Ø4W**

Trip Rating Ampere	Trip Function <sup>[16]</sup>	Trip Unit <sup>[17]</sup>	D Interrupting	G Interrupting	J Interrupting	L Interrupting
			Catalog Number <sup>[18]</sup> [19][20]	Catalog Number <sup>[18]</sup> [19][20]	Catalog Number <sup>[18]</sup> [19][20]	Catalog Number <sup>[18]</sup> [19][20]
<b>MicroLogic Standard Trip Unit</b>						
3Ø4W + G, 600 Vac 50/60 Hz						
60	LI	3.2	PHD36060GNU31X	PHG36060GNU31X	PHJ36060GNU31X	PHL36060GNU31X
100			PHD36100GNU31X	PHG36100GNU31X	PHJ36100GNU31X	PHL36100GNU31X
150			PHD36150GNU31X	PHG36150GNU31X	PHJ36150GNU31X	PHL36150GNU31X
250			PJD36250GNU31X	PJG36250GNU31X	PJJ36250GNU31X	PJL36250GNU31X
60	LSI	3.2 S	PHD36060GNU33X	PHG36060GNU33X	PHJ36060GNU33X	PHL36060GNU33X
100			PHD36100GNU33X	PHG36100GNU33X	PHJ36100GNU33X	PHL36100GNU33X
150			PHD36150GNU33X	PHG36150GNU33X	PHJ36150GNU33X	PHL36150GNU33X
250			PJD36250GNU33X	PJG36250GNU33X	PJJ36250GNU33X	PJL36250GNU33X
<b>MicroLogic Ammeter Trip Unit</b>						
3Ø4W + G, 600 Vac 50/60 Hz						
60	LSI	5.2 A	PHD36060GNU43X	PHG36060GNU43X	PHJ36060GNU43X	PHL36060GNU43X
100			PHD36100GNU43X	PHG36100GNU43X	PHJ36100GNU43X	PHL36100GNU43X
150			PHD36150GNU43X	PHG36150GNU43X	PHJ36150GNU43X	PHL36150GNU43X
250			PJD36250GNU43X	PJG36250GNU43X	PJJ36250GNU43X	PJL36250GNU43X
60	LSIG	6.2 A	PHD36060GNU44X	PHG36060GNU44X	PHJ36060GNU44X	PHL36060GNU44X
100			PHD36100GNU44X	PHG36100GNU44X	PHJ36100GNU44X	PHL36100GNU44X
150			PHD36150GNU44X	PHG36150GNU44X	PHJ36150GNU44X	PHL36150GNU44X
250			PJD36250GNU44X	PJG36250GNU44X	PJJ36250GNU44X	PJL36250GNU44X
<b>MicroLogic Energymeter Trip Unit</b>						
3Ø4W + G, 600 Vac 50/60 Hz						
60	LSI	5.2 E	PHD36060GNU53X	PHG36060GNU53X	PHJ36060GNU53X	PHL36060GNU53X
100			PHD36100GNU53X	PHG36100GNU53X	PHJ36100GNU53X	PHL36100GNU53X
150			PHD36150GNU53X	PHG36150GNU53X	PHJ36150GNU53X	PHL36150GNU53X
250			PJD36250GNU53X	PJG36250GNU53X	PJJ36250GNU53X	PJL36250GNU53X
60	LSIG	6.2 E	PHD36060GNU54X	PHG36060GNU54X	PHJ36060GNU54X	PHL36060GNU54X
100			PHD36100GNU54X	PHG36100GNU54X	PHJ36100GNU54X	PHL36100GNU54X
150			PHD36150GNU54X	PHG36150GNU54X	PHJ36150GNU54X	PHL36150GNU54X
250			PJD36250GNU54X	PJG36250GNU54X	PJJ36250GNU54X	PJL36250GNU54X

[16] If alternate trip functions are required, contact your local Schneider Electric field office for pricing.

[17] For Trip Unit information, refer to *MicroLogic Trip Units*, page 7-61.

[18] For communication capabilities, add the communication suffix as shown in Table 12.36 Communication Suffix, page 12-15. The communication package will be configured based on the system voltage specified by the communication suffix.

[19] For availability on 100% rated, see 5600CT9101.

[20] For IP54 splash resistant construction, add an "M54" suffix.

Table 12.34: L-Frame Circuit Breaker Plug-in Units with Electronic Trip—Standard (80%) Rated—3Ø3W

Trip Rating Ampere	Trip Function [21][22]	Trip Unit[23]	G Interrupting		J Interrupting		L Interrupting		R Interrupting	
			Catalog Number[24][25][26][27]	Catalog Number[24][25][26][27]	Catalog Number[24][25][26][27]	Catalog Number[24][25][26][27]	Catalog Number[24][25][26][27]	Catalog Number[24][25][26][27]		
Basic Electronic Trip Unit										
3Ø3W + G, 600 Vac 50/60 Hz										
250	LI	1.0	PBLG36250G	PBLJ36250G	—	—	—	—	—	—
300			PBLG36300G	PBLJ36300G	—	—	—	—	—	—
350			PBLG36350G	PBLJ36350G	—	—	—	—	—	—
400			PBLG36400G	PBLJ36400G	—	—	—	—	—	—
500			PBLG36500G	PBLJ36500G	—	—	—	—	—	—
600			PBLG36600G	PBLJ36600G	—	—	—	—	—	—
MicroLogic Standard Trip Unit										
3Ø3W + G, 600 Vac 50/60 Hz										
250	LI	3.3	PBLG36250GU31X	PBLJ36250GU31X	PBL36250GU31X	PBLR36250GU31X	—	—	—	—
400			PBLG36400GU31X	PBLJ36400GU31X	PBL36400GU31X	PBLR36400GU31X	—	—	—	—
600			PBLG36600GU31X	PBLJ36600GU31X	PBL36600GU31X	PBLR36600GU31X	—	—	—	—
250	LSI	3.3 S	PBLG36250GU33X	PBLJ36250GU33X	PBL36250GU33X	PBLR36250GU33X	—	—	—	—
400			PBLG36400GU33X	PBLJ36400GU33X	PBL36400GU33X	PBLR36400GU33X	—	—	—	—
600			PBLG36600GU33X	PBLJ36600GU33X	PBL36600GU33X	PBLR36600GU33X	—	—	—	—
MicroLogic Ammeter Trip Unit										
3Ø3W + G, 600 Vac 50/60 Hz										
400	LSI	5.3 A	PBLG36400GU43X	PBLJ36400GU43X	PBL36400GU43X	PBLR36400GU43X	—	—	—	—
600			PBLG36600GU43X	PBLJ36600GU43X	PBL36600GU43X	PBLR36600GU43X	—	—	—	—
MicroLogic Energymeter Trip Unit										
3Ø3W + G, 600 Vac 50/60 Hz										
400	LSI	5.3 E	PBLG36400GU53X	PBLJ36400GU53X	PBL36400GU53X	PBLR36400GU53X	—	—	—	—
600			PBLG36600GU53X	PBLJ36600GU53X	PBL36600GU53X	PBLR36600GU53X	—	—	—	—

Table 12.35: L-Frame Circuit Breaker Plug-in Units with Electronic Trip—Standard (80%) Rated—3Ø4W

Trip Rating Ampere	Trip Function [21][22]	Trip Unit[23]	G Interrupting		J Interrupting		L Interrupting		R Interrupting	
			Catalog Number[24][25][26][27]	Catalog Number[24][25][26][27]	Catalog Number[24][25][26][27]	Catalog Number[24][25][26][27]	Catalog Number[24][25][26][27]	Catalog Number[24][25][26][27]		
Basic Electronic Trip Unit										
3Ø4W + G, 600 Vac 50/60 Hz										
250	LI	1.0	PBLG36250GN	PBLJ36250GN	—	—	—	—	—	—
300			PBLG36300GN	PBLJ36300GN	—	—	—	—	—	—
350			PBLG36350GN	PBLJ36350GN	—	—	—	—	—	—
400			PBLG36400GN	PBLJ36400GN	—	—	—	—	—	—
500			PBLG36500GN	PBLJ36500GN	—	—	—	—	—	—
600			PBLG36600GN	PBLJ36600GN	—	—	—	—	—	—
MicroLogic Standard Trip Unit										
3Ø4W + G, 600 Vac 50/60 Hz										
250	LI	3.3	PBLG36250GNU31X	PBLJ36250GNU31X	PBL36250GNU31X	PBLR36250GNU31X	—	—	—	—
400			PBLG36400GNU31X	PBLJ36400GNU31X	PBL36400GNU31X	PBLR36400GNU31X	—	—	—	—
600			PBLG36600GNU31X	PBLJ36600GNU31X	PBL36600GNU31X	PBLR36600GNU31X	—	—	—	—
250	LSI	3.3 S	PBLG36250GNU33X	PBLJ36250GNU33X	PBL36250GNU33X	PBLR36250GNU33X	—	—	—	—
400			PBLG36400GNU33X	PBLJ36400GNU33X	PBL36400GNU33X	PBLR36400GNU33X	—	—	—	—
600			PBLG36600GNU33X	PBLJ36600GNU33X	PBL36600GNU33X	PBLR36600GNU33X	—	—	—	—
MicroLogic Ammeter Trip Unit										
3Ø4W + G, 600 Vac 50/60 Hz										
400	LSI	5.3 A	PBLG36400GNU43X	PBLJ36400GNU43X	PBL36400GNU43X	PBLR36400GNU43X	—	—	—	—
600			PBLG36600GNU43X	PBLJ36600GNU43X	PBL36600GNU43X	PBLR36600GNU43X	—	—	—	—
400	LSIG	6.3 A	PBLG36400GNU44X	PBLJ36400GNU44X	PBL36400GNU44X	PBLR36400GNU44X	—	—	—	—
600			PBLG36600GNU44X	PBLJ36600GNU44X	PBL36600GNU44X	PBLR36600GNU44X	—	—	—	—
MicroLogic Energymeter Trip Unit										
3Ø4W + G, 600 Vac 50/60 Hz										
400	LSI	5.3 E	PBLG36400GNU53X	PBLJ36400GNU53X	PBL36400GNU53X	PBLR36400GNU53X	—	—	—	—
600			PBLG36600GNU53X	PBLJ36600GNU53X	PBL36600GNU53X	PBLR36600GNU53X	—	—	—	—
400	LSIG	6.3 E	PBLG36400GNU54X	PBLJ36400GNU54X	PBL36400GNU54X	PBLR36400GNU54X	—	—	—	—
600			PBLG36600GNU54X	PBLJ36600GNU54X	PBL36600GNU54X	PBLR36600GNU54X	—	—	—	—

[21] If alternate trip functions are required, contact your local Schneider Electric field office for pricing.

[22] L-frame circuit breaker plug-in units with basic electronic trip units have a fixed, long-time and adjustable, instantaneous setting.

[23] For Trip Unit information, refer to [MicroLogic Trip Units](#), page 7-61.

[24] For communication capabilities, add the communication suffix as shown in [Table 12.36 Communication Suffix](#), page 12-15. The communication package will be configured based on the system voltage specified by the communication suffix.

[25] For availability on 100% rated, see [5600CT9101](#).

[26] For IP54 splash resistant construction, add an "M54" suffix.

[27] For vertical riser applications, order auxiliary mounting kit—Catalog Number PBQ4060RMK.

*New!*
**H-, J-, and L-Frame Plug-In Units with Electronic Trip and Communication**

Hardware communication packages are now available on Powerpact H-, J-, and L-Frame Plug-in Units with Electronic Trip. These hardware communication packages will provide you the capability to access and monitor circuit breaker data from these plug-in units. The packages are available in Modbus and Ethernet.

Add the appropriate communication system voltage suffix to the end of the associated H-, J-, or L-Frame breaker with electronic trip, for example: PHD36060GNU31XIFE4.

**Table 12.36: Communication Suffix<sup>[28]</sup>**

System Voltage	Communication	Communication Type Suffix	System Voltage Suffix
Up to 480Y/277 V	Ethernet	IFE	4
	Modbus	IFM	
480 V only	Ethernet	IFE	5
	Modbus	IFM	
600Y/347 V, 600 V	Ethernet	IFE	6
	Modbus	IFM	

**M-Frame Plug-In Units**
**Table 12.37: M-Frame Circuit Breaker Plug-in Units with Adjustable Basic Electronic Trip Unit (ET 1.0)<sup>[29][30][31]</sup>**

Frame Rating Ampere	System	G Interrupting Catalog Number <sup>[32]</sup>	J Interrupting Catalog Number <sup>[32]</sup>
800	3Ø3W + G	PTMG36800G( )	PTMJ36800G( )
	3Ø4W + G	PTMG36800GN( )	PTMJ36800GN( )

<sup>[28]</sup> Communication packages are housed in a separate enclosure mounted adjacent to the plug-in units.

<sup>[29]</sup> The ET 1.0 trip unit cannot be field replaced or have the long-time trip point setting adjusted.

<sup>[30]</sup> All these devices use bolt-on connection. It may be used only on busway with same number of poles. Not for use on 800 A copper busway. To complete the catalog number, replace the blank with an "H" for horizontal applications and "V" for vertical applications.

<sup>[31]</sup> All M-frame plug-in units are 800 A frame, and the trip setting can be adjusted to 300 A, 350 A, 400 A, 450 A, 500 A, 600 A, 700 A, or 800 A.

<sup>[32]</sup> For IP54 splash resistant construction, add an "M54" suffix.

**P-Frame Plug-In Units**

**Table 12.38: P-Frame Circuit Breaker Plug-in Units—3Ø3W<sup>[33]</sup>**

Trip Rating Ampere	Trip Function <sup>[34]</sup>	Trip Unit <sup>[35]</sup>	Interrupting Rating	
			G Catalog Number <sup>[36][37][38][39]</sup>	J Catalog Number <sup>[36][37][38][39]</sup>
<b>MicroLogic Standard Trip Unit</b>				
3Ø3W + G, 600 Vac 50/60 Hz				
400	LI	3.0	PTPG36040G( )U31A	PTPJ36040G( )U31A
600			PTPG36060G( )U31A	PTPJ36060G( )U31A
800			PTPG36080G( )U31A	PTPJ36080G( )U31A
1000			PTPG36100G( )U31A	PTPJ36100G( )U31A
1200			PTPG36120G( )U31A	PTPJ36120G( )U31A
400	LSI	5.0	PTPG36040G( )U33A	PTPJ36040G( )U33A
600			PTPG36060G( )U33A	PTPJ36060G( )U33A
800			PTPG36080G( )U33A	PTPJ36080G( )U33A
1000			PTPG36100G( )U33A	PTPJ36100G( )U33A
1200			PTPG36120G( )U33A	PTPJ36120G( )U33A
<b>MicroLogic Ammeter Trip Unit</b>				
3Ø3W + G, 600 Vac 50/60 Hz				
400	LI	3.0 A	PTPG36040G( )U41A	PTPJ36040G( )U41A
600			PTPG36060G( )U41A	PTPJ36060G( )U41A
800			PTPG36080G( )U41A	PTPJ36080G( )U41A
1000			PTPG36100G( )U41A	PTPJ36100G( )U41A
1200			PTPG36120G( )U41A	PTPJ36120G( )U41A
400	LSI	5.0 A	PTPG36040G( )U43A	PTPJ36040G( )U43A
600			PTPG36060G( )U43A	PTPJ36060G( )U43A
800			PTPG36080G( )U43A	PTPJ36080G( )U43A
1000			PTPG36100G( )U43A	PTPJ36100G( )U43A
1200			PTPG36120G( )U43A	PTPJ36120G( )U43A
400	LSIG	6.0 A	PTPG36040G( )U44A	PTPJ36040G( )U44A
600			PTPG36060G( )U44A	PTPJ36060G( )U44A
800			PTPG36080G( )U44A	PTPJ36080G( )U44A
1000			PTPG36100G( )U44A	PTPJ36100G( )U44A
1200			PTPG36120G( )U44A	PTPJ36120G( )U44A

**Table 12.39: P-Frame Circuit Breaker Plug-in Units—3Ø4W**

Trip Rating Ampere	Trip Function	Trip Unit	Interrupting Rating	
			G Catalog Number <sup>[36][37][38]</sup>	J Catalog Number <sup>[36][37][38]</sup>
<b>MicroLogic Standard Trip Unit</b>				
3Ø4W + G, 600 Vac 50/60 Hz				
400	LI	3.0	PTPG36040GN( )U31A	PTPJ36040GN( )U31A
600			PTPG36060GN( )U31A	PTPJ36060GN( )U31A
800			PTPG36080GN( )U31A	PTPJ36080GN( )U31A
1000			PTPG36100GN( )U31A	PTPJ36100GN( )U31A
1200			PTPG36120GN( )U31A	PTPJ36120GN( )U31A
400	LSI	5.0	PTPG36040GN( )U33A	PTPJ36040GN( )U33A
600			PTPG36060GN( )U33A	PTPJ36060GN( )U33A
800			PTPG36080GN( )U33A	PTPJ36080GN( )U33A
1000			PTPG36100GN( )U33A	PTPJ36100GN( )U33A
1200			PTPG36120GN( )U33A	PTPJ36120GN( )U33A
<b>MicroLogic Ammeter Trip Unit</b>				
3Ø4W + G, 600 Vac 50/60 Hz				
400	LI	3.0 A	PTPG36040GN( )U41A	PTPJ36040GN( )U41A
600			PTPG36060GN( )U41A	PTPJ36060GN( )U41A
800			PTPG36080GN( )U41A	PTPJ36080GN( )U41A
1000			PTPG36100GN( )U41A	PTPJ36100GN( )U41A
1200			PTPG36120GN( )U41A	PTPJ36120GN( )U41A
400	LSI	5.0 A	PTPG36040GN( )U43A	PTPJ36040GN( )U43A
600			PTPG36060GN( )U43A	PTPJ36060GN( )U43A
800			PTPG36080GN( )U43A	PTPJ36080GN( )U43A
1000			PTPG36100GN( )U43A	PTPJ36100GN( )U43A
1200			PTPG36120GN( )U43A	PTPJ36120GN( )U43A
400	LSIG	6.0 A	PTPG36040GN( )U44A	PTPJ36040GN( )U44A
600			PTPG36060GN( )U44A	PTPJ36060GN( )U44A
800			PTPG36080GN( )U44A	PTPJ36080GN( )U44A
1000			PTPG36100GN( )U44A	PTPJ36100GN( )U44A
1200			PTPG36120GN( )U44A	PTPJ36120GN( )U44A

[33] The 250 A is available as a special device. Contact your local Schneider Electric field office for ordering information.  
 [34] If alternate trip functions are required, contact your local Schneider Electric field office for pricing.  
 [35] For Trip Unit information, refer to [MicroLogic Trip Units](#), page 7-61.  
 [36] Listed catalog numbers are for 80% rated circuit breakers. For 100% rated circuit breakers, replace the blank with an "HC" for horizontal applications and "VC" for vertical applications. For example, the catalog number for a 100% standard trip unit with standard LI trip functions at 800 A 3Ø3W for a horizontal application would be PTPG36080GHCUC31A.  
 [37] The standard rating plug supplied with a trip unit will be the "A" rating plug. To specify an alternative rating plug, replace the "A" at the end of the catalog number with the applicable suffix letter. See [Table 7.126 Rating Plugs](#), page 7-64 for rating plug catalog suffix letters.  
 [38] All these devices use bolt-on connection. It may be used only on busway with same number of poles. Not for use on 800 A copper busway. To complete the catalog number, replace the blank with an "H" for horizontal applications and "V" for vertical applications.  
 [39] For IP54 splash resistant construction, add an "M54" suffix.

**R-Frame Plug-In Units**

**Table 12.40: R-Frame Circuit Breaker Plug-in Units—3Ø3W<sup>[40]</sup>**

Trip Rating Ampere	Trip Function	Trip Unit	Interrupting Rating		
			G	J	L
			Catalog Number <sup>[41][42][43][44]</sup>	Catalog Number <sup>[41][42][43][44]</sup>	Catalog Number <sup>[41][42][43][44]</sup>
<b>MicroLogic Standard Trip Unit</b>					
3Ø3W + G, 600 Vac 50/60 Hz					
800	LI	3.0	PTRG36080G( )JU31A	PTRJ36080G( )JU31A	PTRL36080G( )JU31A
1000			PTRG36100G( )JU31A	PTRJ36100G( )JU31A	PTRL36100G( )JU31A
1200			PTRG36120G( )JU31A	PTRJ36120G( )JU31A	PTRL36120G( )JU31A
1600			PTRG36160G( )JU31A	PTRJ36160G( )JU31A	PTRL36160G( )JU31A
800	LSI	5.0	PTRG36080G( )JU33A	PTRJ36080G( )JU33A	PTRL36080G( )JU33A
1000			PTRG36100G( )JU33A	PTRJ36100G( )JU33A	PTRL36100G( )JU33A
1200			PTRG36120G( )JU33A	PTRJ36120G( )JU33A	PTRL36120G( )JU33A
1600			PTRG36160G( )JU33A	PTRJ36160G( )JU33A	PTRL36160G( )JU33A
<b>MicroLogic Ammeter Trip Unit</b>					
3Ø3W + G, 600 Vac 50/60 Hz					
800	LI	3.0 A	PTRG36080G( )JU41A	PTRJ36080G( )JU41A	PTRL36080G( )JU41A
1000			PTRG36100G( )JU41A	PTRJ36100G( )JU41A	PTRL36100G( )JU41A
1200			PTRG36120G( )JU41A	PTRJ36120G( )JU41A	PTRL36120G( )JU41A
1600			PTRG36160G( )JU41A	PTRJ36160G( )JU41A	PTRL36160G( )JU41A
800	LSI	5.0 A	PTRG36080G( )JU43A	PTRJ36080G( )JU43A	PTRL36080G( )JU43A
1000			PTRG36100G( )JU43A	PTRJ36100G( )JU43A	PTRL36100G( )JU43A
1200			PTRG36120G( )JU43A	PTRJ36120G( )JU43A	PTRL36120G( )JU43A
1600			PTRG36160G( )JU43A	PTRJ36160G( )JU43A	PTRL36160G( )JU43A
800	LSIG	6.0 A	PTRG36080G( )JU44A	PTRJ36080G( )JU44A	PTRL36080G( )JU44A
1000			PTRG36100G( )JU44A	PTRJ36100G( )JU44A	PTRL36100G( )JU44A
1200			PTRG36120G( )JU44A	PTRJ36120G( )JU44A	PTRL36120G( )JU44A
1600			PTRG36160G( )JU44A	PTRJ36160G( )JU44A	PTRL36160G( )JU44A

**Table 12.41: R-Frame Circuit Breaker Plug-in Units—3Ø4W<sup>[40]</sup>**

Trip Rating Ampere	Trip Function	Trip Unit	Interrupting Rating		
			G	J	L
			Catalog Number <sup>[41][42][43][44]</sup>	Catalog Number <sup>[41][42][43][44]</sup>	Catalog Number <sup>[41][42][43][44]</sup>
<b>MicroLogic Standard Trip Unit</b>					
3Ø4W + G, 277/480 Vac (600 Vac Max.) 50/60 Hz					
800	LI	3.0	PTRG36080GN( )JU31A	PTRJ36080GN( )JU31A	PTRL36080GN( )JU31A
1000			PTRG36100GN( )JU31A	PTRJ36100GN( )JU31A	PTRL36100GN( )JU31A
1200			PTRG36120GN( )JU31A	PTRJ36120GN( )JU31A	PTRL36120GN( )JU31A
1600			PTRG36160GN( )JU31A	PTRJ36160GN( )JU31A	PTRL36160GN( )JU31A
800	LSI	5.0	PTRG36080GN( )JU33A	PTRJ36080GN( )JU33A	PTRL36080GN( )JU33A
1000			PTRG36100GN( )JU33A	PTRJ36100GN( )JU33A	PTRL36100GN( )JU33A
1200			PTRG36120GN( )JU33A	PTRJ36120GN( )JU33A	PTRL36120GN( )JU33A
1600			PTRG36160GN( )JU33A	PTRJ36160GN( )JU33A	PTRL36160GN( )JU33A
<b>MicroLogic Ammeter Trip Unit</b>					
3Ø4W + G, 277/480 Vac (600 Vac Max.) 50/60 Hz					
800	LI	3.0 A	PTRG36080GN( )JU41A	PTRJ36080GN( )JU41A	PTRL36080GN( )JU41A
1000			PTRG36100GN( )JU41A	PTRJ36100GN( )JU41A	PTRL36100GN( )JU41A
1200			PTRG36120GN( )JU41A	PTRJ36120GN( )JU41A	PTRL36120GN( )JU41A
1600			PTRG36160GN( )JU41A	PTRJ36160GN( )JU41A	PTRL36160GN( )JU41A
800	LSI	5.0 A	PTRG36080GN( )JU43A	PTRJ36080GN( )JU43A	PTRL36080GN( )JU43A
1000			PTRG36100GN( )JU43A	PTRJ36100GN( )JU43A	PTRL36100GN( )JU43A
1200			PTRG36120GN( )JU43A	PTRJ36120GN( )JU43A	PTRL36120GN( )JU43A
1600			PTRG36160GN( )JU43A	PTRJ36160GN( )JU43A	PTRL36160GN( )JU43A
800	LSIG	6.0 A	PTRG36080GN( )JU44A	PTRJ36080GN( )JU44A	PTRL36080GN( )JU44A
1000			PTRG36100GN( )JU44A	PTRJ36100GN( )JU44A	PTRL36100GN( )JU44A
1200			PTRG36120GN( )JU44A	PTRJ36120GN( )JU44A	PTRL36120GN( )JU44A
1600			PTRG36160GN( )JU44A	PTRJ36160GN( )JU44A	PTRL36160GN( )JU44A

<sup>[40]</sup> The 600 A is available as a special device. Contact your local Schneider Electric field office for ordering information.

<sup>[41]</sup> Listed catalog numbers are for 80% rated circuit breakers. For 100% rated circuit breakers, replace the blank with an "HC" for horizontal applications and "VC" for vertical applications. For example, the catalog number for a 100% standard trip unit with standard LI trip functions at 800 A 3Ø3W for a horizontal application would be PTPG36080GHCU31A.

<sup>[42]</sup> The standard rating plug supplied with a trip unit will be the "A" rating plug. To specify an alternative rating plug, replace the "A" at the end of the catalog number with the applicable suffix letter. See Table 7.126 Rating Plugs, page 7-64 for rating plug catalog suffix letters.

<sup>[43]</sup> All these devices use bolt-on connection. It may be used only on busway with same number of poles. Not for use on 800 A copper busway. To complete the catalog number, replace the blank with an "H" for horizontal applications and "V" for vertical applications.

<sup>[44]</sup> For IP54 splash resistant construction, add an "M54" suffix.

## Non-Segregated Bus

- Non-segregated phase bus
- 600 V through 38 kV (1200 A–6000 A)
- Aluminum, steel or stainless steel housing
- Aluminum or copper bus bars
- Insulated with fluidized bed epoxy (5 kV–38 kV)
- Complete line of fittings provides for any configuration
- Indoor trapeze and outdoor column supports
- For use in utilities, industrial and commercial facilities



Power-Zone bus is custom designed, manufactured and tested per ANSI C37.23 standards to meet customer specifications. The 600 V product is also UL Listed. It is a completely coordinated package of equipment with all the auxiliary material and supports for connecting transformers, switchgear, MCCs, and motors, in all types of utility, industrial, and commercial facilities.

### Bus Options

Some available options are special momentary rating, special housing material and/or finish, special conductor supports, heaters and thermostats, and ground bus.

### Weatherproof Bus

All weatherproof runs must be equipped with strip heaters to eliminate condensation and, if applicable, a thermostat. A heater should be used for every seven (7) foot of bus and no more than 20 heaters can be controlled by one thermostat. Also, each bus run should have its own thermostat. The heaters are rated 240 V, 500 watts and operate at 120 V, 125 watts.

### Flanged Ends

A flanged end is used to terminate the bus into switchgear, motor control centers, switchboards, or any rigid bus-to-bus connection. It consists of a gasketed equipment flange, up to 1'-0" of 3Ø3W conductor (3Ø4W as applicable), necessary insulation tapes, and required bolting hardware.

### Cable Tap Box

A cable tap box includes a gasketed and accessible termination box, lugs, necessary insulation tape (between bus and lugs only), and required bolting hardware. Lug sizes and quantity should be specified by purchaser.

### Transformer/Generator Connection

This type of termination should be used whenever the bus is connecting to a transformer, generator, motor, switch or any connection where the bus bars are connecting to porcelain mounted equipment terminals. It will include the same components as a flanged end plus one set of flexible braid type connectors and a terminal box (if required).

### Bushing Box (Weatherhead)

A bushing box is used on service entrance run where the cable connection to the bus must be made via porcelain bushings. It is comprised of the same components as a transformer connection plus 3 through stud type apparatus bushings, bushing stud connectors (lug pads) and a strip heater.

**Ground Bus**

The bus housing is designed and constructed to provide an electrically continuous ground path. The side rails of the bus housings are capable of carrying the full rated phase current continuously and, under short circuit conditions, are capable of carrying up to 60 kA RMS asymmetrical fault current for 3 seconds. Consequently, a separate ground bus is not necessary unless specified.

**Wall Entrance Seal**

A wall entrance seal consists of a wall throat, wall flange (one side of wall only), and a barrier which prevents air or vapor from passing from one room to another or from outdoors to indoors. It also carries a 1/2 hour fire rating. Consult factory for higher fire ratings.

**Table 12.42: Wall Flange**

Description
Optional (in addition to wall entrance seal)
Aluminum
14 Gauge Steel
14 Gauge 304 Stainless Steel
14 Gauge 316 Stainless Steel

**Equipment Entrance Seal**

An equipment entrance seal should be used whenever a barrier is required to prevent the passing of flame and/or gasses between the bus housing and the terminating equipment.

**Expansion Fittings**

An expansion fitting is used to counteract the strain placed on the bus due to the expansion and contraction of the building or the bus itself. One should be used whenever the bus run crosses a building expansion joint and whenever a straight run of bus exceeds 60 feet.

**Flexible Housing (Misalignment) Collar**

Required at terminations or wall penetrations when vibrations due to seismic forces may cause damage to the bus. It may also be used to adjust for the “settling” of terminating equipment after installation.

**Supporting Steel (Hangers)**

Supports should be added on the basis of one for every 10 ft. for indoor and one for every 12 ft. for outdoor. Indoor supports are a trapeze type hanger while outdoor supports are a single or double column type support. Consult factory for other type supports.

**Table 12.43: Hangers/Supports**

Support Description	Maximum Height Options
Indoor Trapeze Hanger	—
Outdoor, Single Column Support	12 feet
Outdoor, Double Column Support	22 feet

**Hazardous or Seismic Locations**

Consult factory for bus runs which are to be installed in a location which is classified as hazardous or in a seismic location.

**Standard Construction**

Standard construction is as follows:

- Conductor (plating): Copper (silver) or Aluminum (tin)
- Conductor Insulation (5 kV through 38 kV only): epoxy
- Conductor Supports: Glass reinforced polyester blocks (5 kV and 15 kV); porcelain (38 kV)
- Housing Material: Extruded Aluminum (1/8-inch Nominal)
- Housing Construction: Totally Enclosed Non-ventilated
- Joint Insulation: EPR and PVC tape
- BIL Rating: 30 kV (600 V), 60 kV (5 kV) and 95 kV (15 kV)
- Momentary (Short Circuit) Rating: 75 kA (600 V), 60 kA (5 kV, 15 kV), and 39 kA (38 kV)
- Ground Conductor: Housing (100% rated)

**Table 12.44: Bus Enclosures**

Material and Finish
Painted Aluminum (1/8" Nominal)
Painted 14 Gauge Steel
Painted 11 Gauge Steel
Painted 14 Gauge 304 Stainless Steel
Painted 14 Gauge 316 Stainless Steel

**Table 12.45: Momentary (Asymmetrical Short Circuit) Ratings**

Voltage Class	Ampere Options
600 V	75 kA
	100 kA
	125 kA
	150 kA
5 kV 15 kV	60 kA
	80 kA
	100 kA
	150 kA
38 kV	39 kA
	49 kA
	62 kA
	100 kA



# Section 13

## Wire Management



Wireway

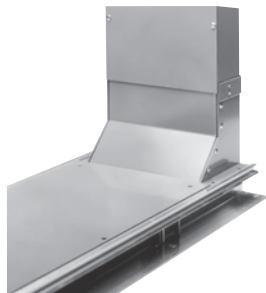

Wall Duct

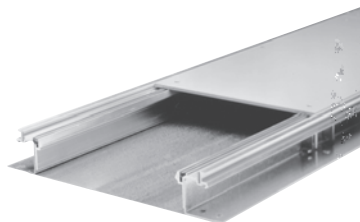

Trench Duct

<b>Wireway</b>	<b>13-2</b>
<hr/>	
General Purpose—NEMA Type 1	13-2
Oiltight—NEMA Type 12	13-3
Raintight Wireway—NEMA Type 3R	13-4
Raintight Trough—NEMA Type 3R	13-4
<b>Wall Duct</b>	<b>13-5</b>
<hr/>	
Wall Duct General Description	13-5
Components and Accessories	13-5
Wall Duct Accessories	13-6
<b>Trench Duct</b>	<b>13-7</b>
<hr/>	
Trench Duct General Description	13-7
Trench Duct Fittings	13-7
Accessories and Components	13-8

## General Purpose—NEMA Type 1

For more information on Wireway, refer to Catalog [5100CT0101](#).

### Standards

Square-Duct wireway is Underwriters Laboratories listed as steel enclosed wireway and auxiliary gutter. CSA listing is also available.



Painted Hinge-Cover  
Type LDB—ANSI 49 Gray  
Polyester Powder Finish

### Sizes

2-1/2", 4", and 6" sizes are manufactured from 16 gauge steel. Straight lengths are available with or without knockouts. Knockouts are of various sizes in sides and bottom of wireway. 8", 10", and 12" sizes are made of 14 gauge steel and are furnished without knockouts.

**Table 13.1: General Purpose (Connectors not supplied; order separately)**<sup>[1][2]</sup>

Component	2-1/2" x 2-1/2"		4" x 4"		6" x 6"		8" x 8"	10" x 10"	12" x 12" <sup>[3]</sup>
	Catalog Number		Catalog Number		Catalog Number		Cat. No.	Cat. No.	Cat. No.
	With Knockouts	Without Knockouts	With Knockouts	Without Knockouts	With Knockouts	Without Knockouts	Without Knockouts	Without Knockouts	Without Knockouts
1' Length	LDB21KO	LDB21	LDB41KO	LDB41	LDB61KO	LDB61	LDB81	LDB101	LDB121
2' Length	LDB22KO	LDB22	LDB42KO	LDB42	LDB62KO	LDB62	LDB82	LDB102	LDB122
3' Length	LDB23KO	LDB23	LDB43KO	LDB43	LDB63KO	LDB63	LDB83	LDB103	LDB123
4' Length	LDB24KO	LDB24	LDB44KO	LDB44	LDB64KO	LDB64	LDB84	LDB104	LDB124
5' Length	LDB25KO	LDB25	LDB45KO	LDB45	LDB65KO	LDB65	LDB85	LDB105	LDB125
6' Length	—	—	LDB46KO	LDB46	LDB66KO	LDB66	LDB86	LDB106	—
10' Length	LDB210KO	LDB210	LDB410KO	LDB410	LDB610KO	LDB610	LDB810	LDB1010	LDB1210
90° L	—	LDB290L	—	LDB490L	—	LDB690L	LDB890L	LDB1090L	LDB1290L
90° Sweep L	—	LDB290LS	—	LDB490LS	—	LDB690LS	LDB890LS	LDB1090LS	LDB1290LS
45° L	—	LDB245L	—	LDB445L	—	LDB645L	LDB845L	LDB1045L	LDB1245L
Tee	—	LDB2T	—	LDB4T	—	LDB6T	LDB8T	LDB10T	LDB12T
Junction Box	—	LDB2J	—	LDB4J	—	LDB6J	LDB8J	LDB10J	LDB12J
Telescope Ftg.	—	LDB2TF	—	LDB4TF	—	LDB6TF	LDB8TF	LDB10TF	LDB12TF
Connector <sup>[2]</sup>	—	LDB2C	—	LDB4C	—	LDB6C	LDB8C	LDB10C	LDB12C
Drop/Brkt Hgr.	—	LDB2H	—	LDB4H	—	LDB6H	LDB8H	LDB10H	LDB12H
Support Hanger	—	LDB2SH	—	LDB4SH	—	LDB6SH	LDB8SH	LDB10SH	LDB12SH
Closing Plate	LDB2CPKO	LDB2CP	LDB4CPKO	LDB4CP	LDB6CPKO	LDB6CP	LDB8CP <sup>[4]</sup>	LDB10CP <sup>[4]</sup>	LDB12CP <sup>[4]</sup>
Panel Adapter	—	LDB2A	—	LDB4A	—	LDB6A	LDB8A	LDB10A	LDB12A
Open Adapter	—	LDB2OA	—	LDB4OA	—	LDB6OA	LDB8OA	LDB10OA	LDB12OA
Reducer	—	—	—	LDB42R	—	LDB64R	LDB86R	LDB108R	LDB1210R
	—	—	—	—	—	—	—	—	LDB128R
Adapter to "LD" <sup>[5]</sup>	—	LDB2GASK	—	LDB4GAS	—	LDB6GAS	LDB8GASK	LDB10GASK	—
Barrier Kit—5 ft. long w/hardware	—	—	—	LJB45B	—	LJB65B	LJB85B	—	—
5 pc. Barrier Pack—5 ft. long	—	—	—	LJB45BKM	—	LJB65BKM	—	—	—
5 pc. Barrier Bracket—2 compartment	—	—	—	LJB4BB2C	—	LJB6BB2C	—	—	—
5 pc. Barrier Bracket—3 compartment	—	—	—	LJB4BB3C	—	LJB6BB3C	—	—	—

[1] For wireway fill information, see NEC 376.

[2] Add connectors for all lengths and fittings, except closing plates, reducers, and adapters.

[3] Painted 12" x 12" wireway is not furnished with hinge-cover (screw-cover only).

[4] These closing plates also available with knockout. Add "KO" to cat #.

[5] Adapters to competitors' wireways also available. Contact your nearest Schneider Electric sales office for availability.



**Oiltight—NEMA Type 12**

Type LJB Oiltight lay-in wireway is fully gasketed and used to protect runs of electrical wiring from oil, water, coolants, dirt, or dust as well as physical damage. This wireway is manufactured to exceed oiltight and NFPA standards for industrial control equipment. Lengths and fittings are made of 14 gauge steel with 10 gauge end flanges. Straight lengths and fittings have hinged covers with oil resistant gasket all around and are held closed with pull-down latches. All lengths and fittings are without knockouts. Type LJB lay-in Wireway is finished with ANSI-49 gray polyester powder finish over a corrosion resistant phosphate preparation. All Type LJB oiltight wireway is UL listed as steel enclosed wireway and auxiliary gutter. Conforms to NEMA Type 12.

**Table 13.2: Type LJB Lay-in [6]**

Description	2-1/2" x 2-1/2"	4" x 4"	6" x 6"	8" x 8"	12" x 6"
	Catalog No.	Catalog No.	Catalog No.	Catalog No.	Catalog No.
1" Nipple	LJB201	LJB401	LJB601	—	—
2" Nipple	LJB202	LJB402	LJB602	—	—
3" Nipple	LJB203	LJB403	LJB603	—	—
6" Length	LJB206	LJB406	LJB606	—	—
1' Length	LJB21	LJB41	LJB61	LJB806	LJB12606
2' Length	LJB22	LJB42	LJB62	LJB81	LJB1261
3' Length	LJB23	LJB43	LJB63	LJB82	LJB1262
4' Length	LJB24	LJB44	LJB64	LJB83	LJB1263
5' Length	LJB25	LJB45	LJB65	LJB84	LJB1264
10' Length [7]	LJB210	LJB410	LJB610	LJB85	LJB1265
45° Top Opening	LJB245LT	LJB445LT	LJB645LT	LJB88	LJB1266
45° Inside Opening	LJB245LI	LJB445LI	LJB645LI	LJB890LI	LJB12690LI
45° Outside Opening	LJB245LO	LJB445LO	LJB645LO	LJB890LO	LJB12690LO
90° Inside Opening	LJB290LI	LJB490LI	LJB690LI	LJB890LT	LJB12690LT
90° Outside Opening	LJB290LO	LJB490LO	LJB690LO	LJB890LOT	—
90° Outside Top Opening	—	LJB490LOT	LJB690LOT	LJB890TO	—
90° Top Opening	LJB290LT	LJB490LT	LJB690LT	LJB890TF	LJB12690TF
Tee—Top Opening	LJB2TT	LJB4TT	LJB6TT	LJB8CP	LJB126CP
Tee—Outside Opening	LJB2TO	LJB4TO	LJB6TO	LJB8A	LJB126A
Cross	LJB2X	LJB4X	LJB6X	LJB8BH	—
Junction Box	LJB2JB	LJB4JB	LJB6JB	LJB8DH	—
Telescopic Fitting	LJB2TF	LJB4TF	LJB6TF	LJB8C	LJB126C
Closing Plate	LJB2CP	LJB4CP	LJB6CP	LJB890C	LJB12690C
Panel Adapter	LJB2A	LJB4A	LJB6A	—	—
Bracket Hanger	LJB2BH	LJB4BH	LJB6BH	—	—
Drop Hanger	LJB2DH	LJB4DH	LJB6DH	—	—
Extra Connector Kit [6]	LJB2C	LJB4C	LJB6C	—	—
90° Connector	LJB290C	LJB490C	LJB690C	—	—
Reducer to 2"	—	LJB42R	—	—	—
Reducer to 4"	—	—	LJB64R	—	LJB1264R
Reducer to 6"	—	—	—	LJB86R	LJB1266R
Cut-off fitting—not Lay-in	LJB2CF	LJB4CF	LJB6CF	LJB8CFL	LJB126CFL
Cut-off fitting—Lay-in	LJB2CFL	LJB4CFL	LJB6CFL	—	—
Transposition Fitting—CCW (Str)	LJB21CCW	LJB41CCW	LJB61CCW	—	—
Transposition Fitting—CW (Str)	LJB21CW	LJB41CW	LJB61CW	—	—
Transposition Elbow—CCW	LJB290LCCW	LJB490LCCW	LJB690LCCW	LJB890LCCW	—
Transposition Elbow—CW	LJB290LCW	LJB490LCW	LJB690LCW	LJB890LCW	—
Swivel fitting—Wireway to Wireway	LJB2S	LJB4S	LJB6S	LJB8S	—
Swivel fitting—Wireway to Box	LJB2SB	LJB4SB	LJB6SB	LJB8SB	—
Flex Fitting—Feed Through	LJB2FF	LJB4FF	LJB6FF	LJB8FF	—
Barrier Kit—5 ft. long w/hardware	—	LJB45B	LJB65B	LJB85B	LJB1265B
5 pc. Barrier Pack—5 ft. long	—	LJB45BKM	LJB65BKM	—	—
5 pc. Barrier Bracket—2 compartment	—	LJB4BB2C	LJB6BB2C	—	—
5 pc. Barrier Bracket—3 compartment	—	LJB4BB3C	LJB6BB3C	—	—

[6] Connector kit furnished with each length and fitting.  
[7] 10 foot straight lengths UL listed for up to 10 foot hanger spacing.

### Raintight Wireway—NEMA Type 3R

Outdoor raintight wireway is used to protect electrical wiring against rain, sleet, and physical damage. Unique drip shield cover protects wiring from weather and maintains the “lay-in” feature for ease of wiring installation. Lengths and fittings are constructed of 16 gauge galvanized steel with ANSI-49 gray polyester powder finish over a corrosion resistant phosphate preparation. Underwriters Laboratories Listed as steel enclosed wireway and auxiliary gutter (*horizontal mounting only*). Conforms to NEMA Type 3R.

**Table 13.3: Raintight Wireway**

Description <sup>[8]</sup>	4" x 4"	6" x 6"	8" x 8"
	Catalog Number	Catalog Number	Catalog Number
1' Length	LDRB41M	LDRB61M	LDRB81M
5' Length	LDRB45M	LDRB65M	LDRB85M
10' Length	LDRB410M	LDRB610M	LDRB810M
90° L	LDRB490L	LDRB690L	LDRB890L
30° Sweep L	LDRB430SE	LDRB630SE	LDRB830SE
Tee	LDRB4T	LDRB6T	LDRB8T
Junction Box	LDRB4J	LDRB6J	LDRB8J
Panel Adapter	LDRB44A	LDRB66A	LDRB88A
Connector <sup>[8]</sup>	LDRB4C	LDRB6C	LDRB8C
Closing Plate	LDRB4CP	LDRB6CP	LDRB8CP
Drop Hanger	LDRB4DH	LDRB6DH	LDRB8DH
Wall Hanger	LDRB4WH	LDRB6WH	LDRB8WH
Reducer	—	LDRB64R	LDRB86R

### Raintight Trough—NEMA Type 3R

Raintight trough is designed for ganging meter devices, panelboards, switches, and circuit breaker enclosures. Each length is a completely enclosed section with a removable cover that has provisions for sealing.

**Design:** 4" and 6" wireway is constructed of 16 gauge galvanized steel. 8", 10", and 12" wireway is constructed of 14 gauge galvanized steel. All raintight troughs conform to NEMA Type 3R.

**Finish:** ANSI-49 gray polyester powder finish over a corrosion resistant phosphate preparation. All raintight troughs are Underwriters Laboratories listed as steel enclosed wireway and auxiliary gutter (*horizontal mounting only*).

**Table 13.4: Raintight Trough**

Length	4" x 4"	6" x 6"	8" x 8"	10" x 10"	12" x 12"
	Cat. No.	Cat. No.	Cat. No.	Cat. No.	Cat. No.
1'	RDB41	RDB61	—	—	—
2'	RDB42	RDB62	RDB82	RDB102	RDB122
3'	RDB43	RDB63	RDB83	RDB103	RDB123
4'	RDB44	RDB64	RDB84	—	—
5'	RDB45	RDB65	RDB85	RDB105	RDB125
6'	—	RDB66	RDB86	RDB106	RDB126

<sup>[8]</sup> Add connectors for all lengths and fittings.

**Wall Duct General Description**

UL Listed, File E65247, for Enclosure of Wiring to X-Ray Machines. Also available in aluminum for MRI application.

Wall duct is used as the continuation for standard trench duct in the floor. Wall duct can be routed up the wall and across the ceiling or under the finished floor (in ceiling space below) to provide a continuous lay-in raceway system from control consoles and floor equipment to overhead apparatus. Devices are furnished complete with covers and are available for either flush or surface mounted installations.



Typical Surface Mount, Straight-Length Wall Duct

**General Notes:**

- Standard construction is 14 gauge steel with gray electrodeposition paint. Alternate construction is painted aluminum.
- Covers and coupling devices are furnished with each device.
- Wire retainers are furnished with each device.
- Straight lengths are field cut to length.
- Partitions and tunnels are to be field modified and installed where required.
- Hangers or other mounting devices to be furnished by others.

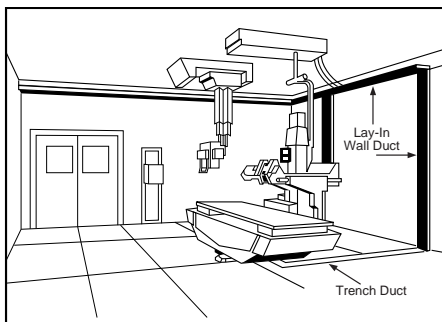

With SURFACE Covers (Matching Width)

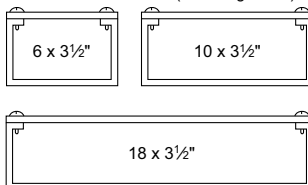

With FLUSH Covers (2" Oversize)

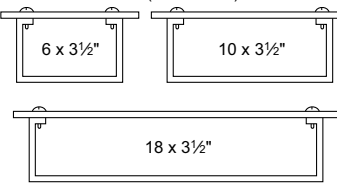

**Components and Accessories**

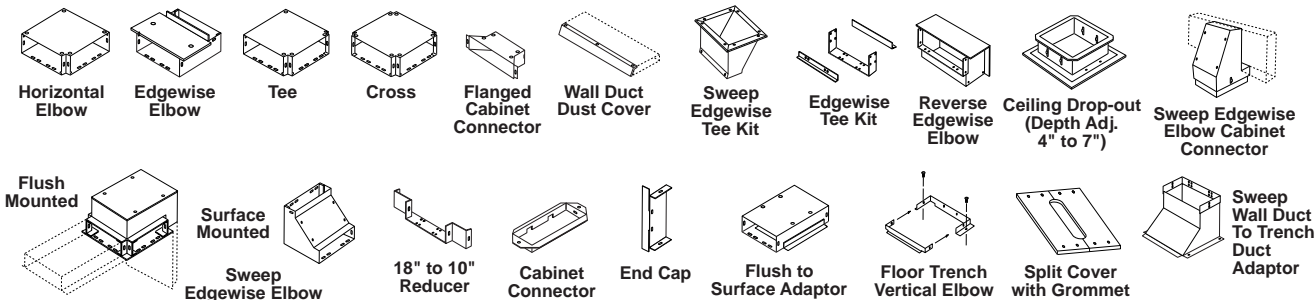

Table 13.5: Lay-In Wall Duct Components [1]

Component	Flush Cover		Surface Cover	
	Catalog Number	Weight Lbs.	Catalog Number	Weight Lbs.
5'-0" Straight Length With Cover 6"W	RWT06S60	22.5	RWT06S60S	20.4
	RWT10S60	39.2	RWT10S60S	36.4
	RWT18S60	62.2	RWT18S60S	59.4
1'-6" Straight Length With Cover 6"W	RWT06S18	12.6	RWT06S18S	12.6
	RWT10S18	16.4	RWT10S18S	16.3
	RWT18S18	23.3	RWT18S18S	23.3
Horizontal Elbow With Cover—90° 6"W	RWT06HE	6.5	RWT06HES	6.0
	RWT10HE	9.3	RWT10HES	8.1
	RWT18HE	24.9	RWT18HES	23.7
Horizontal Elbow With Cover—45° 6"W	—	—	RWT06HE45S	6.0
	—	—	RWT10HE45S	8.1
	—	—	RWT18HE45S	23.7
Edgewise Elbow With Cover 6"W	RWT06EE	5.5	RWT06EES	5.5
	RWT10EE	7.5	RWT10EES	7.4
	RWT18EE	11.1	RWT18EES	11.0
Tee With Cover 6"W	RWT06TE	6.2	RWT06TES	5.9
	RWT10TE	8.5	RWT10TES	7.3
	RWT18TE	24.1	RWT18TES	22.9
Cross With Cover 10"W	RWT10XE	1.3	RWT10XES	6.2
	RWT18XE	1.8	RWT18XES	21.8
Flanged Cabinet Connector With Cover 10"W	RWT10CUC	8.0	RWT10CUCS	7.8
Reverse Edgewise Elbow With Cover 6"W	RWT06REE	5.8	RWT06REES	5.7
	RWT10REE	7.5	RWT10REES	7.4
	RWT18REE	11.1	RWT18REES	11.0
Sweep Edgewise Elbow With Cover 6"W	—	10.0	RWT06SSEES	4.8
	RWT10SFEE	12.0	RWT10SSEES	11.8
	RWT18SFEE	16.5	RWT18SSEES	16.3
Sweep Edgewise Elbow Cabinet Connector 10"W	—	—	RWT10SWEECC	14.0
	—	—	RWT18SWEECC	20.0

[1] All devices available in aluminum. Add "A" suffix to the catalog number.

Wall Duct Accessories

Table 13.6: Lay-In Wall Duct Accessories [2]

Accessories	Catalog Number	Weight Lbs.
5'-0" Partition	RWTP60	5.4
Straight through tunnel for tees [3] 10"W 18"W	RWT10ST RWT18ST	2.9 3.8
90° Elbow tunnel for crosses [3] 10"W 18"W	RWT10ET RWT18ET	3.2 5.1
3 compartment tunnel for tees 10"W 18"W	RWT10PTE RWT18PTE	5.0 6.0
3 compartment tunnel for crosses 10"W 18"W	RWT10PXE RWT18PXE	8.0 9.0
Edgewise Tee Kit 10"W 18"W	RWT10ETK RWT18ETK	1.3 2.1
Sweep Edgewise Tee Kit 10"W 18"W	RWT10SWET RWT18SWET	8.0 8.0
Flush to Surface Adaptor 10"W 18"W	RWT10FS RWT18FS	11.9 16.4
Ceiling Drop-Out 12x12 Flush Cover 8"x8"	RWTCDO	15.0
Extra Coupling Device 10"W 18"W	RWT10COUP RWT18COUP	.4 .5
Extra Straight Cover—30" long (Order 2 pcs. for 5 ft. of duct.) Flush 10"W 18"W Surface 10"W 18"W	RWT10SCOV RWT18SCOV RWT10SCOVS RWT18SCOVs	7.2 13.0 6.1 11.8

Table 13.7: Wall Duct Accessories [2]

Accessories	Catalog Number	Weight Lbs.
Reducer Coupling— 18" to 10" 10" to 6"	RWTRC RWT06RC	2.1 1.6
Cabinet Connector 6"W 10"W 18"W	RWT06CC RWT10CC RWT18CC	1.0 1.3 2.4
End Cap 6"W 10"W 18"W	RWT06EC RWT10EC RWT18EC	1.0 1.3 1.8
Vertical Elbows for: 6" Trench to 6" Wall Duct 12" Trench to 10" Wall Duct 12" Trench to 18" Wall Duct 18" Trench to 10" Wall Duct 18" Trench to 18" Wall Duct	RWT06FTVE06 RWT10FTVE12 RWT18FTVE12 RWT10FTVE18 RWT18FTVE18	1.1 1.2 1.2 1.2 1.3
Sweep Trench Duct to Wall Duct Adapter (available in surface cover only) 12" Trench to 10" Wall Duct 18" Trench to 18" Wall Duct	RWT10SWFTVE12 RWT18SWFTVE18	10.0 14.0
Split Cover with Grommet 12" long—3"x 8" Opening Flush 6"W 10"W 18"W Surface 6"W 10"W 18"W	RWT06ACP RWT10ACP RWT18ACP RWT06ACPS RWT10ACPS RWT18ACPS	2.6 3.1 4.8 2.0 2.7 4.0
Dust Cover—5 ft. long	RWTDcov60	5.5
Grommet—100 ft. roll	RWTBG100	

[2] All devices available in aluminum. Add "A" suffix to the catalog number.  
[3] Tunnels form a 3" wide compartment.

**Trench Duct General Description**

- STANDARD LENGTH of trench duct is 10 ft. Gasketed cover plates are ordered and shipped separately.
- FEATURES of trench duct:
  - Trench duct width is cover plate width.
  - Tub width is trench duct width less 1.8".
  - Overall width (bottom flange to flange) is 3" wider than trench duct width.
  - Standard depth is adjustable from 2-3/8" to 3-3/8". Also available as standard is depth adjustable from 3" to 4". To order, change "2" to "3". Ex. RSV063100120. Applies to trench duct, elbows, crosses, tees, and reducers. Other depths available.
  - Tees, crosses, horizontal elbows, and reducers are shipped complete with cover plates assembled.
  - Grey vinyl tile trim is furnished as standard. Aluminum is available when requested.
  - All compartments over 17" wide must be supported with dividers or posts.

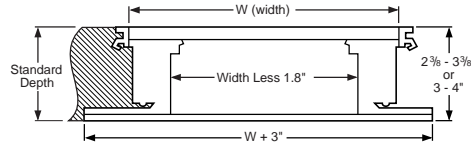
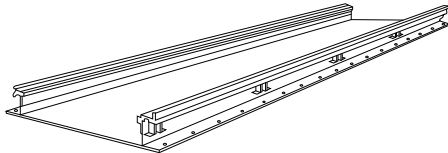
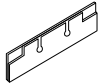
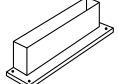
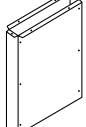
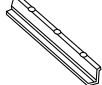

**Table 13.8: Assembled Trench Duct**

Straight Sections	Trench Duct			
	Length	Width	Catalog Number	
Full Length	10'-0"	6"	RSV062100120	
		9"	RSV092100120	
		12"	RSV122100120	
		18"	RSV182100120	
		24"	RSV242100120	
		30"	RSV302100120	
	Covers Only (5 Plates per 10' Length) [1]			
	24"	6"	RCP0624	
		9"	RCP0924	
		12"	RCP1224	
18"		RCP1824		
24"		RCP2424		
12"	12"	RCP1212		
	18"	RCP1812		
Factory Cut-to-Length (12" Wide Only)	6'-0"L	12"	RSV122100072	
	4'-3- 1/2"L	12"	RSV122100051.5	
	3'-3- 1/2"L	12"	RSV122100039.5	
	2'-0"L	12"	RSV122100024	
	1'-0"L	12"	RSV122100012	
	0'-3-1/2"L	12"	RSV122100003.5	
	3-24" Long Covers [2]			
	2-24" Long Covers & 1 - Wall Duct Vertical Elbow [2]			
	1-24" & 1-12" Long Cover & 1-Wall Duct Vertical Elbow [2]			
	1-24" Long Cover [2]			
1-12" Long Cover [2]				
1-Wall Duct Vertical Elbow [2]				

**Trench Duct Fittings**

**Table 13.9: Trench Duct Fittings**

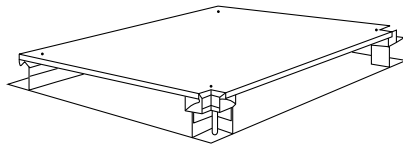

Item	Width [3]	Catalog No.
 End Closures [4]	6" 9" 12" 18" 24" 30"	REC06 REC09 REC12 REC18 REC24 REC30
 Vertical Elbows	6" 9" 12" 18" 24" 30"	RVE06 RVE09 RVE12 RVE18 RVE24 RVE30
 Riser and Cabinet Connector (Removable Front)	6" 9" 12" 18" 24" 30"	RRC06 RRC09 RRC12 RRC18 RRC24 RRC30
 Z-Divider 5'-0" [4] Adjustable Barrier and Support Strip		RZD60
Tape for Trench Duct (180 ft. rolls)		G1414
Marker for Cellular Floor		G1426

[1] Straight length cover plates are shipped separately and must be ORDERED SEPARATELY.  
 [2] Covers and/or vertical elbows for connecting trench duct to lay-in wall duct—ORDER SEPARATELY.  
 [3] All devices through 18" width are available in aluminum. Height is factory-set to customer specifications from 2-1/2 to 4 inches. (Non-Adjustable)  
 [4] For 3" to 4" trench duct, add a "3" to end of catalog number.



Tee

Table 13.10: Trench Duct Elbows, Tees, and Crosses

Item	Complete Device	
	Width	Catalog Number
90° Horizontal Elbows 	6"	RHV06210009
	9"	RHV09210012
	12"	RHV12210015
	18"	RHV18210021
	24"	RHV24210027
30"	RHV30210033	
45° Horizontal Elbow [5]	12"	RHV12245
Tees [5] 	6"	RTV06210011
	9"	RTV09210014
	12"	RTV12210017
	18"	RTV18210023
	24"	RTV24210029
30"	RTV30210035	
Crosses [5] 	6"	RXV06210012
	9"	RXV09210015
	12"	RXV12210018
	18"	RXV18210024
	24"	RXV24210030
30"	RXV30210036	

Accessories and Components

Table 13.11: Trench Duct Accessories





Item/Catalog Number			Item/Catalog Number		
	Right Hand Reducer 18" to 12" Cover Included	RRV182100012RR		U-Compartment 5'-0" Long x 3 -1/2" Wide with Adjustable Height Sides	RUC60
	Left Hand Reducer 18" to 12" Cover Included	RRV182100012LR		9" and 12" wide trench 18" and 24" wide trench 30" wide trench Support Channel Leveling Legs Not Included	G1500T12 G1500T24 G1500T36
				5/16 x 18 x 3"	G19103
	Reducing Tee 18" to 12" Cover Included	RTV182100017		Cover Lifter (Suction Cup Device)	G1735S
	Spacer Bar and Barrier Adjustment Gage	6" 9" 12" 18" 24" 30"		Tunnels for Trench Duct Elbows (Tee or Cross) Straight through tunnel 90° elbow tunnel	90° tunnel for 12" trench 90° tunnel for 18" trench Straight tunnel for 12" trench Straight tunnel for 18" trench
	Support Post Strips 5'	RSP60			RSV122ET RSV182ET RSV122ST RSV182ST

Table 13.12: Grommets

Grommet Material (50 ft. rolls)	RG50
---------------------------------	------

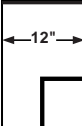
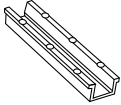
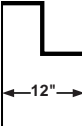
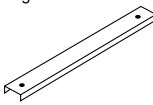
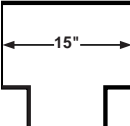
[5] Includes cover; shipped attached. All coverplate corner notches are 1-1/2" deep.

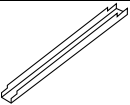
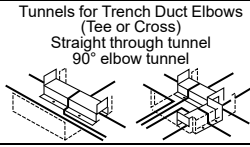

# Section 14

## Transformers

General Purpose Dry Type  
600 Volts and Below



Type T and Type TF



Medium Voltage  
Distribution Transformer



### EZ Selector–Selection Assistance 14-2

LV Transformers EZ Selector–Selection Assistance	14-2
LV Transformers EZ Selector–Selection Assistance	14-2

### Low-Voltage Dry-Type Distribution Transformers 14-3

Overview	14-3
General Purpose Dry Type 600 Volts and Below Overview	14-3
DOE 2016 Energy Efficient Three Phase	14-4
DOE 2016 Energy Efficient Single Phase and Single Phase Watchdog	14-7
Accessories	14-8
Enclosures and Accessories	14-8
Mini Power-Zone Unit Substation	14-10
Sealed, Mini Power-Zone™ Unit Substation	14-10
Resin Encapsulated Three and Single Phase Transformers	14-11
Resin Encapsulated Export Model and Buck Boost Transformers	14-12
Non-Ventilated and Transformer House	14-13
PZC Transformer Enclosures	14-13

### Industrial Control Transformers 14-14

Type T and Type TF	14-14
Transformer Disconnects	14-19
Transformer Disconnects for NEMA Type 1 and Type 12 Enclosures	14-19

### Instrument, 600 Volt Class 14-20

Voltage and Current Transformers	14-20
Voltage Transformers	14-20
Current Transformers	14-20

### Energy Efficient, Dry Type 2.4, 5, and 15 kV 14-21

DOE 2016 Energy Efficient Medium Voltage Distribution Transformers	14-21
Medium Voltage Distribution Transformers	14-21
Dry Type Medium Voltage Transformers	14-22
1,201–15,000 Vac Three-Phase Indoor Transformers	14-22
1,201–15,000 Vac Single-Phase Indoor Transformers	14-23
Transformer Enclosures	14-24



## LV Transformers EZ Selector–Selection Assistance

### LV Transformers EZ Selector

#### Steps to select an LV transformer.

1. Select product type:
  - Three Phase – Energy Efficient – EX (DOE 2016)
  - Three Phase – Energy Efficient – EX, K-13 Rated (DOE 2016)
  - Three Phase – Energy Efficient – EX, Watchdog Low Temperature Rise (DOE 2016)
  - Single Phase – Energy Efficient – EE (DOE 2016)
  - Three Phase – Resin Encapsulated
  - Single Phase – Resin Encapsulated
2. Select kVA Rating – 15, 30, 45, 75, 112.5, 150, 225, 300, 500, or 750 kVA
3. Select Primary Voltage – 208, 240, 480, or 600 Vac Delta
4. Select Secondary Voltage – 208Y/120, 240 Vac Delta 120 V CT, 480Y/277
5. Select Mounting – Floor, Wall
6. Select Enclosure – Indoor (Type 1), Indoor (Type 2), Indoor/Outdoor (Type 3R), Indoor/Outdoor (Type 4X)
7. Select Temperature Rise – 55°C, 80°C, 115°C, 150°C
8. Select Material – Aluminum, Copper
9. Select Sound Level – 39 dB (6 dB below), 44 dB (6 dB below), 47 dB (3 dB below), 49 dB (6 dB below), 54 dB (6 dB below), 58 dB (6 dB below)

#### Additional Information

Search for “LV Transformers” from our technical FAQs page: [www.schneider-electric.us/en/faqs](http://www.schneider-electric.us/en/faqs)

For catalog information, please use this link: [LV Transformer Documents](#)

**General Purpose Dry Type 600 Volts and Below Overview**

The Energy Policy and Conservation Act of 1975 (EPCA), update in the Energy Policy Act of 2005, authorized the Department of Energy (DOE) to evaluate and set minimum efficiency levels for Low Voltage Distribution Transformers. The DOE published a final rule prescribing new energy conservation standards for distribution transformers. 78 FR 23335 (April 18, 2013).

10 CFR 431.196: The efficiency of a low-voltage dry-type distribution transformer manufactured on or after January 1, 2016, shall be no less than that required for their kVA rating in the table below. Low-voltage dry-type distribution transformers with kVA ratings not appearing in the table shall have their minimum efficiency level determined by linear interpolation of the kVA and efficiency values immediately above and below that kVA rating. All efficiency values are at thirty-five percent of nameplate-rated load temperature corrected to 75°C, determined according to the DOE Test Method for Measuring the Energy Consumption of Distribution Transformers under Appendix A to Subpart K of 10 CFR part 431. [https://www1.eere.energy.gov/buildings/appliance\\_standards/standards.aspx?productid=55&action=viewcurrent](https://www1.eere.energy.gov/buildings/appliance_standards/standards.aspx?productid=55&action=viewcurrent)

Energy Conservation Standards for Low-Voltage Dry-Type Distribution Transformers			
Single phase		Three phase	
kVA	Efficiency % [1]	kVA	Efficiency % [1]
15	97.70	15	97.89
25	98.00	30	98.23
37.5	98.20	45	98.40
50	98.30	75	98.60
75	98.50	112.5	98.74
100	98.60	150	98.83
167	98.70	225	98.94
250	98.80	300	99.02
333	98.90	500	99.14
—	—	750	99.23
—	—	1000	99.28

Distribution transformer means a transformer that (1) has an input voltage of 34.5 kV or less; (2) has an output voltage of 600 V or less; (3) is rated for operation at a frequency of 60 Hz; and (4) has a capacity of 10 to 2500 kVA for liquid-immersed units and 15 to 2500 kVA for dry-type units.

Low voltage dry-type distribution transformer means a distribution transformer that: has an input voltage of 600 V or less, is air-cooled, and not used oil as a coolant.

The following product offering must comply with the table above:

- Three- and single-phase
- Step up and step down transformers
- General purpose ventilated transformers (isolation transformers)
- Watchdog general purpose ventilated transformers (low temperature rise)
- Transformers designed for harmonic applications (K-rated, harmonic mitigating, data center transformers, etc.)
- General purpose open core and coil transformers

The following low voltage transformers do not need to comply with the table above:

- Auto-transformers
- Drive isolation transformers
- Non-ventilated transformers
- Resin encapsulated transformers
- Buck boost transformers
- Control transformers (machine tool)
- Medical isolation panel transformers compliance with UL 1047 (tables 30.1 and 30.2) (SPECIAL IZ — LOW LEAKAGE)

**New Three-Phase Offering from Square D — DOE 2016 EX**

- Exceed the efficiency levels from 10 CFR 431.196
- Terminals sized to handle wire ranges to match Square D circuit breakers, switches, panelboards, etc. Located to meet NEC bending radius and layout to simplify connections
- IZ Levels to allow for designing with the minimum AIC Panels available
- In-rush current limited to expand the Square D circuit breaker options at both 125 and 250% sizing
- Sound level at 3 dB for all designs, but up to 6–10 dB below on certain units—QUIET QUALITY
- 1/2 in. clearance from the rear and side, **UL 1561alcove testing all enclosures to not exceed 90°C on adjacent walls**
- Four product families of the DOE 2016 EX: General purpose, aluminum and copper windings, 150°C rise; Watchdog, low temperature rise, aluminum and copper windings, 115 or 80°C rise; Two solutions for harmonic loads: K-13 Wye secondary, harmonic mitigating transformers and K-9 ZigZag secondary, harmonic mitigating transformers.

[1] Efficiencies are determined at the following reference conditions: (1) for no-load losses, at the temperature of 20°C; (2) for load-losses, at the temperature of 75°C and 35% of nameplate load. (Source: Table 4–2 of National Electrical Manufacturers Association (NEMA) Standard TP–1–2002, *Guide for Determining Energy Efficiency for Distribution Transformers.*)

DOE 2016 Energy Efficient Three Phase

Table 14.1: EXN & EX Three-Phase 60 Hz, 208Y/120 Vac Secondary; UL Listed

kVA	Catalog No.	Minimum Efficiency @ 35% 75°C	Full Capacity Taps	Degree C Temp. Rise	Insulation Class	%I <sub>Z</sub>	Sound Level dB	Weight (lbs) [2]	Enclosure[3]
<b>480 Vac Delta Primary, Aluminum Windings</b>									
15	EXN15T3H	97.89%	6-2.5%2+4-	150	220	4.03%	39 dB	188	17M
30	EXN30T3H	98.23%	6-2.5%2+4-	150	220	3.80%	39 dB	303	18M
45	EXN45T3H	98.40%	6-2.5%2+4-	150	220	4.10%	39 dB	369	19M
75	EXN75T3H	98.60%	6-2.5%2+4-	150	220	4.90%	44 dB	515	20M
112.5	EXN112T3H	98.74%	6-2.5%2+4-	150	220	3.70%	44 dB	724	21M
150	EXN150T3H	98.83%	6-2.5%2+4-	150	220	3.10%	44 dB	933	22M
225	EX225T3H	98.94%	6-2.5%2+4-	150	220	4.4%	52 dB	1450	25J
300	EX300T3H	99.02%	6-2.5%2+4-	150	220	5.0%	52 dB	1860	25J
500	EX500T68H	99.14%	4-2.5%2+2-	150	220	4.9%	57 dB	2915	30J
750	EX750T68H	99.23%	4-2.5%2+2-	150	220	—	61 dB	4000	31J
<b>600 Vac Delta Primary, Aluminum Windings</b>									
15	EXN15T65H	97.89%	6-2.5%2+4-	150	220	4.32%	39 dB	188	17M
30	EXN30T65H	98.23%	6-2.5%2+4-	150	220	3.70%	39 dB	324	18M
45	EXN45T65H	98.40%	6-2.5%2+4-	150	220	4.10%	39 dB	368	19M
75	EXN75T65H	98.60%	6-2.5%2+4-	150	220	4.67%	44 dB	513	20M
112.5	EXN112T65H	98.74%	6-2.5%2+4-	150	220	3.62%	44 dB	727	21M
150	EXN150T65H	98.83%	6-2.5%2+4-	150	220	3.14%	44 dB	1002	22M
225	EX225T65H	98.94%	6-2.5%2+4-	150	220	5.2%	52 dB	1450	25J
300	EX300T65H	99.02%	6-2.5%2+4-	150	220	5.3%	52 dB	1860	25J
500	EX500T79H	99.14%	4-2.5%2+2-	150	220	—	57 dB	2915	30J
750	EX750T79H	99.23%	4-2.5%2+2-	150	220	—	61 dB	4000	31J
<b>208 Vac Delta Primary, Aluminum Windings[4]</b>									
15	EXN15T3156H	97.89%	192/200/208/216/232/240/248	150	220	4.04%	39 dB	192	17M
30	EXN30T3156H	98.23%	192/200/208/216/232/240/248	150	220	3.22%	39 dB	363	18M
45	EXN45T3156H	98.40%	192/200/208/216/232/240/248	150	220	4.04%	39 dB	396	19M
75	EXN75T3156H	98.60%	192/200/208/216/232/240/248	150	220	4.88%	44 dB	526	20M
112.5	EXN112T3156H	98.74%	192/200/208/216/232/240/248	150	220	3.48%	44 dB	811	21M
150	EXN150T3156H	98.83%	192/200/208/216/232/240/248	150	220	3.22%	44 dB	1015	22M
225	EX225T211H	98.94%	3-5%1+2-	150	220	4.7%	52 dB	1450	25J
300	EX300T211H	99.02%	3-5%1+2-	150	220	4.4%	52 dB	1860	25J
500	EX500T211H	99.14%	3-5%1+2-	150	220	—	57 dB	2915	30J
<b>240 Vac Delta Primary, Aluminum Windings[4]</b>									
15	EXN15T3156H	97.89%	192/200/208/216/232/240/248	150	220	4.04%	39 dB	192	17M
30	EXN30T3156H	98.23%	192/200/208/216/232/240/248	150	220	3.22%	39 dB	363	18M
45	EXN45T3156H	98.40%	192/200/208/216/232/240/248	150	220	4.04%	39 dB	396	19M
75	EXN75T3156H	98.60%	192/200/208/216/232/240/248	150	220	4.88%	44 dB	526	20M
112.5	EXN112T3156H	98.74%	192/200/208/216/232/240/248	150	220	3.48%	44 dB	811	21M
150	EXN150T3156H	98.83%	192/200/208/216/232/240/248	150	220	3.22%	44 dB	1015	22M
225	EX225T239H	98.94%	3-5%1+2-	150	220	4.6%	52 dB	1450	25J
300	EX300T239H	99.02%	3-5%1+2-	150	220	5.2%	52 dB	1860	25J
500	EX500T239H	99.14%	3-5%1+2-	150	220	—	57 dB	2915	30J
<b>480 Vac Delta Primary, Copper Windings</b>									
15	EXN15T3HCU	97.89%	6-2.5%2+4-	150	220	4.06%	39 dB	222	17M
30	EXN30T3HCU	98.23%	6-2.5%2+4-	150	220	4.08%	39 dB	356	18M
45	EXN45T3HCU	98.40%	6-2.5%2+4-	150	220	3.44%	39 dB	399	19M
75	EXN75T3HCU	98.60%	6-2.5%2+4-	150	220	4.99%	44 dB	661	20M
112.5	EXN112T3HCU	98.74%	6-2.5%2+4-	150	220	3.27%	44 dB	974	21M
150	EXN150T3HCU	98.83%	6-2.5%2+4-	150	220	3.60%	44 dB	1156	22M
225	EX225T3HCU	98.94%	6-2.5%2+4-	150	220	5.7%	52 dB	1545	25J
300	EX300T3HCU	99.02%	6-2.5%2+4-	150	220	6.0%	52 dB	1975	25J
500	EX500T68HCU	99.14%	4-2.5%2+2-	150	220	4.8%	57 dB	3705	30J
750	EX750T68HCU	99.23%	4-2.5%2+2-	150	220	5.3%	61 dB	4400	31J

Table 14.2: EXN & EX Three-Phase 60 Hz, 480Y/277 Vac Secondary; UL Listed

kVA	Catalog No.	Minimum Efficiency @ 35% 75°C	Full Capacity Taps	Degree C Temp. Rise	Insulation Class	%I <sub>Z</sub>	Sound Level	Weight (lbs)[2]	Enclosure[3]
<b>208 Vac Delta Primary, Aluminum Windings [5]</b>									
15	EXN15T3155H	97.89%	192/200/208/216/232/240/248	150	220	4.01%	39 dB	191	17M
30	EXN30T3155H	98.23%	192/200/208/216/232/240/248	150	220	3.43%	39 dB	335	18M
45	EXN45T3155H	98.40%	192/200/208/216/232/240/248	150	220	3.86%	39 dB	395	19M
75	EXN75T3155H	98.60%	192/200/208/216/232/240/248	150	220	3.94%	44 dB	544	20M
112.5	EXN112T3155H	98.74%	192/200/208/216/232/240/248	150	220	3.67%	44 dB	735	21M
150	EXN150T3155H	98.83%	192/200/208/216/232/240/248	150	220	3.12%	44 dB	1020	22M
225	EX225T212H	98.94%	3-5%1+2-	150	220	5.8%	52 dB	1450	25J
300	EX300T212H	99.02%	3-5%1+2-	150	220	5.2%	52 dB	1860	25J
500	EX500T212H	99.14%	3-5%1+2-	150	220	4.8%	57 dB	2915	30J
<b>480 Vac Delta Primary, Aluminum Windings</b>									
15	EXN15T1814H	97.89%	6-2.5%2+4-	150	220	4.62%	39 dB	191	17M
30	EXN30T1814H	98.23%	6-2.5%2+4-	150	220	3.50%	39 dB	333	18M
45	EXN45T1814H	98.40%	6-2.5%2+4-	150	220	3.95%	39 dB	373	19M
75	EXN75T1814H	98.60%	6-2.5%2+4-	150	220	5.03%	44 dB	531	20M
112.5	EXN112T1814H	98.74%	6-2.5%2+4-	150	220	3.53%	44 dB	730	21M
150	EXN150T1814H	98.83%	6-2.5%2+4-	150	220	3.08%	44 dB	1012	22M
225	EX225T1814H	98.94%	6-2.5%2+4-	150	220	4.6%	52 dB	1450	25J
300	EX300T1814H	99.02%	6-2.5%2+4-	150	220	5.4%	52 dB	1860	25J
500	EX500T76H	99.14%	4-2.5%2+2-	150	220	—	57 dB	2915	30J

[2] Not for construction, Contact your local Schneider Electric representative for certified prints.

[3] For enclosure styles, see Table 14.8 Enclosure Dimensions and Accessories, page 14-8

[4] 3156 Catalog Numbers are shipped connected as 240 V.

[5] 3155 Catalog Numbers are shipped connected as 240 V.

**Table 14.3: EXN & EX Three Phase 60 Hz, 240 Vac Delta Secondary; UL Listed**

120 Volt Center Tap - Limited to 7.5% Loading, Design for Ground Reference and Light Maintenance Loading.										
kVA	Catalog No.	Minimum Efficiency @ 35% 75°C	Full Capacity Taps	Degree C Temp. Rise	Insulation Class	%Z	Sound Level dB	Weight (lbs) [6]	Enclosure[7]	
<b>480 Vac Delta Primary, Aluminum Windings</b>										
15	EXN15T6HCT	0.9789	6-2.5%2+4-	150	220	4.70%	39 dB	193	17M	
30	EXN30T6HCT	0.9823	6-2.5%2+4-	150	220	2.99%	39 dB	361	18M	
45	EXN45T6HCT	0.984	6-2.5%2+4-	150	220	4.06%	39 dB	369	19M	
75	EXN75T6HCT	0.986	6-2.5%2+4-	150	220	5.08%	44 dB	529	20M	
112.5	EXN112T6HCT	0.9874	6-2.5%2+4-	150	220	3.47%	44 dB	730	21M	
150	EXN150T6HCT	0.9883	6-2.5%2+4-	150	220	3.08%	44 dB	1007	22M	
225	EX225T6HCT	98.94%	6-2.5%2+4-	150	220	4.5%	52 dB	1820	25J	
300	EX300T6HCT	99.02%	6-2.5%2+4-	150	220	5.2%	52 dB	1960	25J	
500	EX500T63HCT	99.14%	4-2.5%2+2-	150	220	4.9%	57 dB	3090	30J	
750	EX750T63HCT	99.23%	4-2.5%2+2-	150	220	4.9%	61 dB	4120	31J	
<b>480 V Delta Primary, 208Y/120 Secondary, Aluminum Windings</b>										
15	EXN15T6H	97.89%	6-2.5%2+4-	150	220	4.70%	39dB	193	17M	
30	EXN30T6H	98.23%	6-2.5%2+4-	150	220	2.99%	39dB	361	18M	
45	EXN45T6H	98.40%	6-2.5%2+4-	150	220	4.06%	39dB	369	19M	
75	EXN75T6H	98.60%	6-2.5%2+4-	150	220	5.08%	44dB	529	20M	
112.5	EXN112T6H	98.74%	6-2.5%2+4-	150	220	3.47%	44dB	730	21M	
150	EXN150T6H	98.83%	6-2.5%2+4-	150	220	3.08%	44dB	1007	22M	
15	EXN15T6H	97.89%	6-2.5%2+4-	150	220	4.70%	39 dB	193	17M	
30	EXN30T6H	98.23%	6-2.5%2+4-	150	220	2.99%	39 dB	361	18M	
45	EXN45T6H	98.40%	6-2.5%2+4-	150	220	4.06%	39 dB	369	19M	
75	EXN75T6H	98.60%	6-2.5%2+4-	150	220	5.08%	44dB	529	20M	
112.5	EXN112T6H	98.74%	6-2.5%2+4-	150	220	3.47%	44 dB	730	21M	
150	EXN150T6H	98.83%	6-2.5%2+4-	150	220	3.08%	44 dB	1007	22M	

Watchdog transformers, by design, reduce energy consumption at loads greater than 50% loading, giving fewer BTUs/hour at those loading levels. The life expectancy is greater than that of 150°C rise General Purpose units.

- Aluminum or copper windings
- Two temperature rise options: 115°C rise on 220°C insulation systems (15% continuous emergency overload capacity); 80°C rise on 220°C insulation systems (30% continuous emergency overload capacity)

**Table 14.4: EXN & EX Three Phase 60 Hz; UL Listed**

kVA	Catalog No.	Minimum Efficiency @ 35% 75°C	Full Capacity Taps	Degree C Temp. Rise	Insulation Class	%Z	Sound Level	Weight (lbs) [6]	Enclosure[7]	
<b>480 V Delta Primary, 208Y/120 Secondary, Aluminum Windings</b>										
15	EXN15T3HF	97.89%	6-2.5%2+4-	115	220	3.98%	39 dB	184	17M	
30	EXN30T3HF	98.23%	6-2.5%2+4-	115	220	2.92%	39 dB	324	18M	
45	EXN45T3HF	98.40%	6-2.5%2+4-	115	220	3.46%	39 dB	400	19M	
75	EXN75T3HF	98.60%	6-2.5%2+4-	115	220	5.07%	44 dB	527	20M	
112.5	EXN112T3HF	98.74%	6-2.5%2+4-	115	220	3.30%	44 dB	806	21M	
150	EXN150T3HF	98.83%	6-2.5%2+4-	115	220	3.29%	44 dB	1012	22M	
225	EX225T3HF	98.94%	6-2.5%2+4-	115	220	4.5%	49 dB	1825	24J	
300	EX300T3HF	99.02%	6-2.5%2+4-	115	220	30.0%	49 dB	1975	25J	
500	EX500T68HF	99.14%	4-2.5%2+2-	115	220	4.9%	56 dB	3100	30J	
750	EX750T68HF	99.23%	4-2.5%2+2-	115	220	5.0%	58 dB	4125	31J	
<b>480 V Delta Primary, 208Y/120 Secondary, Copper Windings</b>										
15	EXN15T3HFUCU	97.89%	6-2.5%2+4-	115	220	3.90%	39 dB	219	17M	
30	EXN30T3HFUCU	98.23%	6-2.5%2+4-	115	220	3.98%	39 dB	358	18M	
45	EXN45T3HFUCU	98.40%	6-2.5%2+4-	115	220	3.72%	39 dB	412	19M	
75	EXN75T3HFUCU	98.60%	6-2.5%2+4-	115	220	4.01%	44 dB	653	20M	
112.5	EXN112T3HFUCU	98.74%	6-2.5%2+4-	115	220	3.42%	44 dB	899	21M	
150	EXN150T3HFUCU	98.83%	6-2.5%2+4-	115	220	4.56%	44 dB	1303	22M	
225	EX225T3HFUCU	98.94%	6-2.5%2+4-	115	220	6.8%	49 dB	1545	24J	
300	EX300T3HFUCU	99.02%	6-2.5%2+4-	115	220	5.0%	49 dB	1975	25J	
500	EX500T68HFUCU	99.14%	4-2.5%2+2-	115	220	4.8%	56 dB	3705	30J	
750	EX750T68HFUCU	99.23%	4-2.5%2+2-	115	220	5.3%	58 dB	4400	31J	
<b>480 V Delta Primary, 208Y/120 Secondary, Aluminum Windings</b>										
15	EXN15T3HB	97.89%	6-2.5%2+4-	80	220	4.01%	39 dB	195	17M	
30	EXN30T3HB	98.23%	6-2.5%2+4-	80	220	4.37%	39 dB	345	18M	
45	EXN45T3HB	98.40%	6-2.5%2+4-	80	220	4.10%	39 dB	416	19M	
75	EXN75T3HB	98.60%	6-2.5%2+4-	80	220	5.05%	44 dB	580	20M	
112.5	EXN112T3HB	98.74%	6-2.5%2+4-	80	220	2.54%	44 dB	949	21M	
150	EXN150T3HB	98.83%	6-2.5%2+4-	80	220	3.92%	44 dB	1208	22M	
225	EX225T3HB	98.94%	6-2.5%2+4-	80	220	4.6%	49 dB	1975	25J	
300	EX300T68HB	99.02%	4-2.5%2+2-	80	220	4.4%	56 dB	3100	30J	
500	EX500T68HB	99.14%	4-2.5%2+2-	80	220	4.9%	58 dB	4125	31J	
<b>480 V Delta Primary, 208Y/120 Secondary, Copper Windings</b>										
15	EXN15T3HBCU	97.89%	6-2.5%2+4-	80	220	4.53%	39 dB	235	17M	
30	EXN30T3HBCU	98.23%	6-2.5%2+4-	80	220	2.76%	39 dB	407	18M	
45	EXN45T3HBCU	98.40%	6-2.5%2+4-	80	220	4.12%	39 dB	509	19M	
75	EXN75T3HBCU	98.60%	6-2.5%2+4-	80	220	5.61%	44 dB	690	20M	
112.5	EXN112T3HBCU	98.74%	6-2.5%2+4-	80	220	3.76%	44 dB	1146	21M	
150	EXN150T3HBCU	98.83%	6-2.5%2+4-	80	220	5.45%	44 dB	1424	22M	
225	EX225T3HBCU	98.94%	6-2.5%2+4-	80	220	6.9%	49 dB	1975	25J	
300	EX300T68HBCU	99.02%	4-2.5%2+2-	80	220	5.0%	56 dB	3705	30J	
500	EX500T68HBCU	99.14%	4-2.5%2+2-	80	220	4.8%	58 dB	4400	31J	

[6] Not for construction, Contact your local Schneider Electric representative for certified prints.

[7] For enclosure styles, see Table 14.8 Enclosure Dimensions and Accessories, page 14-8

**DOE 2016 Low Voltage Distribution Transformers designed for applications with harmonic loads.**

Square D offers offers Delta - Wye 30°Phase Shift transformers which reconfigure the harmonic models and mitigate the harmful effects of triplens. UL Listed with the following K-ratings to handle excess heat created by harmonic wave forms, K4 and K13. Available with aluminum or copper windings and 150°C or 115°C Rise with 220C insulation system.

**Table 14.5: EXN & EX Three Phase 60 Hz, 30° Phase Shift, 480 Delta to 208Y/120; UL Listed, K-RATED**

kVA	Catalog No.	Minimum Efficiency @ 35% 75°C	Full Capacity Taps	Degree C Temp. Rise	Insulation Class	%IZ	Sound Level	Weight (lbs) [8]	Enclosure [9]
<b>480 Delta Primary, 208Y/120 Secondary, Aluminum Windings, 150°C Rise, 220C Insulation, K13 Listed</b>									
15	EXN15T3HNLP	97.89%	6-2.5%2+4-	150	220	4.51%	39 dB	195	17M
30	EXN30T3HNLP	98.23%	6-2.5%2+4-	150	220	4.18%	39 dB	336	18M
45	EXN45T3HNLP	98.40%	6-2.5%2+4-	150	220	4.71%	39 dB	400	19M
75	EXN75T3HNLP	98.60%	6-2.5%2+4-	150	220	5.26%	44 dB	580	20M
112.5	EXN112T3HNLP	98.74%	6-2.5%2+4-	150	220	3.70%	44 dB	802	21M
150	EX150T3HNLP	98.83%	6-2.5%2+4-	150	220	3.00%	44 dB	1825	25J
225	EX225T3HNLP	98.94%	6-2.5%2+4-	150	220	3.30%	49 dB	1975	25J
<b>480 Delta Primary, 208Y/120 Secondary, Copper Windings, 150°C Rise, 220C Insulation, K13 Listed</b>									
15	EXN15T3HCUNLP	97.89%	6-2.5%2+4-	150	220	4.96%	39 dB	235	17M
30	EXN30T3HCUNLP	98.23%	6-2.5%2+4-	150	220	3.06%	39 dB	407	18M
45	EXN45T3HCUNLP	98.40%	6-2.5%2+4-	150	220	4.41%	39 dB	509	19M
75	EXN75T3HCUNLP	98.60%	6-2.5%2+4-	150	220	5.56%	44 dB	700	20M
112.5	EXN112T3HCUNLP	98.74%	6-2.5%2+4-	150	220	3.33%	44 dB	1000	21M
150	EX150T3HCUNLP	98.83%	6-2.5%2+4-	150	220	4.60%	44 dB	1545	25J
225	EX225T3HCUNLP	98.94%	6-2.5%2+4-	150	220	3.80%	49 dB	1975	25J
<b>480 Vac Delta Primary, 208Y/120 Secondary, Aluminum Winding, K4</b>									
15	EXN15T3HNL	97.89%	6-2.5%2+4-	150	220	4.30%	39 dB	184	17M
30	EXN30T3HNL	98.23%	6-2.5%2+4-	150	220	3.15%	39 dB	324	18M
45	EXN45T3HNL	98.40%	6-2.5%2+4-	150	220	4.13%	39 dB	392	19M
75	EXN75T3HNL	98.60%	6-2.5%2+4-	150	220	5.21%	44 dB	527	20M
112.5	EXN112T3HNL	98.74%	6-2.5%2+4-	150	220	3.80%	44 dB	713	21M
150	EXN150T3HNL	98.83%	6-2.5%2+4-	150	220	3.37%	44 dB	1012	22M
<b>480 Vac Delta Primary, 208Y/120 Secondary, Copper Winding, K4</b>									
15	EXN15T3HCUNL	97.89%	6-2.5%2+4-	150	220	4.22%	39 dB	219	17M
30	EXN30T3HCUNL	98.23%	6-2.5%2+4-	150	220	4.23%	39 dB	358	18M
45	EXN45T3HCUNL	98.40%	6-2.5%2+4-	150	220	3.95%	39 dB	412	19M
75	EXN75T3HCUNL	98.60%	6-2.5%2+4-	150	220	4.15%	44 dB	548	20M
112.5	EXN112T3HCUNL	98.74%	6-2.5%2+4-	150	220	3.52%	44 dB	899	21M
150	EXN150T3HCUNL	98.83%	6-2.5%2+4-	150	220	4.35%	44 dB	1303	22M

[8] Not for construction, Contact your local Schneider Electric representative for certified prints.

[9] For enclosure styles, see Table 14.8 Enclosure Dimensions and Accessories, page 14-8

**DOE 2016 Energy Efficient Single Phase and Single Phase Watchdog**

**Table 14.6: EE Single-Phase 60 Hz, 120 / 240 Vac Secondary; cULus Listed**

kVA	Catalog No.	Minimum Efficiency @ 35% 75°C	Full Capacity Taps [10]	Degree C Temp. Rise	Insulation Class	%IZ	Sound Level dB	Weight (lbs) [11]	Enclosure [12]
<b>240 x 480 Vac Primary, Aluminum Windings</b>									
15	EE15S3H	97.70%	480 Vac 6-2.5% 2+4- 240 Vac 3-5% 1+2-	150	220	6.1%	45dB	215	17D
25	EE25S3H	98.00%		150	220	5.9%	45dB	275	17H
37.5	EE37S3H	98.20%		150	220	6.1%	45dB	340	18H
50	EE50S3H	98.30%		150	220	5.1%	45dB	395	18H
75	EE75S3H	98.50%		150	220	5.7%	50dB	619	21D
100	EE100S3H	98.60%		150	220	4.7%	50dB	682	22D
167	EE167S3H	98.70%		150	220	3.9%	55dB	982	24D
250	EE250S3H	98.80%		150	220	5.7%	55dB	1060	25D
333	EE333S3H	98.90%	150	220	6.3%	60dB	1854	31D	
<b>600 Vac Primary, Aluminum Windings</b>									
15	EE15S3534H	97.70%	6-2.5%2+4-	150	220	4.0	45dB	215	17D
25	EE25S3534H	98.00%	6-2.5%2+4-	150	220	4.3	45dB	275	17H
37.5	EE37S3534H	98.20%	6-2.5%2+4-	150	220	3.8	45dB	400	18H
50	EE50S3534H	98.30%	6-2.5%2+4-	150	220	4.2	45dB	450	18H
75	EE75S3534H	98.50%	6-2.5%2+4-	150	220	3.2	50dB	605	21D
100	EE100S3534H	98.60%	6-2.5%2+4-	150	220	2.9	50dB	795	22D
167	EE167S3534H	98.70%	6-2.5%2+4-	150	220	4.7	55dB	985	24D
250	EE250S3534H	98.80%	6-2.5%2+4-	150	220	—	55dB	1065	25D
333	EE333S3534H	98.90%	6-2.5%2+4-	150	220	—	60dB	1865	31D
<b>208 Vac Primary, Aluminum Windings</b>									
15	EE15S60H	97.70%	2 - 5% FCBN	150	220	4.3	45dB	200	17D
25	EE25S60H	98.00%	2 - 5% FCBN	150	220	4.1	45dB	275	17H
37.5	EE37S60H	98.20%	2 - 5% FCBN	150	220	3.6	45dB	397	18H
50	EE50S60H	98.30%	2 - 5% FCBN	150	220	5.7	45dB	420	18H
75	EE75S60H	98.50%	2 - 5% FCBN	150	220	3.6	50dB	621	21D
100	EE100S60H	98.60%	2 - 5% FCBN	150	220	6.3	50dB	795	22D
167	EE167S60H	98.70%	2 - 5% FCBN	150	220	4.2	55dB	985	24D
<b>277 Vac Primary, Aluminum Windings</b>									
15	EE15S61H	97.70%	2 - 5% FCBN	150	220	5.8	45dB	225	17D
25	EE25S61H	98.00%	2 - 5% FCBN	150	220	5.8	45dB	285	17H
37.5	EE37S61H	98.20%	2 - 5% FCBN	150	220	5.7	45dB	410	18H
50	EE50S61H	98.30%	2 - 5% FCBN	150	220	5.1	45dB	460	18H
75	EE75S61H	98.50%	2 - 5% FCBN	150	220	5.6	50dB	630	21D
100	EE100S61H	98.60%	2 - 5% FCBN	150	220	6.5	50dB	795	22D
167	EE167S61H	98.70%	2 - 5% FCBN	150	220	4.9	55dB	995	24D

**Table 14.7: EE Single Phase Watchdog Transformers: 60 Hz, cULus Listed**

kVA	Catalog No.	Minimum Efficiency @ 35% 75°C	Full Capacity Taps	Degree C Temp. Rise	Insulation Class	%IZ	Sound Level dB	Weight (lbs) [11]	Enclosure [12]	
<b>240 x 480 Vac Primary, 120 / 240 Vac Secondary, Aluminum Windings</b>										
15	EE15S3HF	97.70%	480 Vac 6-2.5% 2+4- 240 Vac 3-5% 1+2-	115	220	3.5%	45dB	275	17D	
25	EE25S3HF	98.00%			220	4.0%	45dB	340	18H	
37.5	EE37S3HF	98.20%			220	3.7%	45dB	395	18H	
50	EE50S3HF	98.30%			220	3.7%	45dB	620	21D	
75	EE75S3HF	98.50%			220	3.5%	50dB	685	22D	
100	EE100S3HF	98.60%			220	3.5%	50dB	985	24D	
15	EE15S3HB	97.70%			80	220	1.7%	45dB	280	17D
25	EE25S3HB	98.00%			80	220	3.9%	45dB	345	18H
37.5	EE37S3HB	98.20%			80	220	3.7%	45dB	400	18H
50	EE50S3HB	98.30%			80	220	3.6%	45dB	625	21D
75	EE75S3HB	98.50%			80	220	3.4%	50dB	690	22D
100	EE100S3HB	98.60%			80	220	3.4%	50dB	995	24D

Other primary and secondary combinations are available via the Schneider Electric Product Configurator. Contact your local Schneider Electric representative for more information.

[10] FCBN = Full Capacity Below Normal.  
 [11] Not for construction, Contact your local Schneider Electric representative for certified prints.  
 [12] For enclosure styles, see Table 14.8 Enclosure Dimensions and Accessories, page 14-8

Enclosures and Accessories



Style D and H—Type 2 Rated  
Converts to Type 3R with Weathershield



Style M—Type 2 Rated  
Converts to Type 3R with Weathershield



Style J—Type 1 Rated  
Converts to Type 2 with Drip Shield  
Converts to Type 3R with Weathershield

Table 14.8: Enclosure Dimensions and Accessories

Enclosure Number/ Style		Height		Width <sup>[13]</sup>		Depth		Mounting	Weathershield	Wall Mounting Bracket <sup>[14]</sup>	Ceiling Mounting Bracket <sup>[15]</sup>	Drip Shield
		in.	mm	in.	mm	in.	mm					
17	D	27	686	20	508	16	406	Floor	WS363	WMB361362	CMB363	—
	H	37	940	20	508	16	406	Floor	WS363	WMB361362	CMB363	—
18	D	30	762	20	508	20	508	Floor	WS363	WMB363364	CMB363	—
	H	37	940	20	508	20	508	Floor	WS363	WMB363364	CMB363	—
19	D	30	762	30	762	20	508	Floor	WS364	WMB363364	CMB364	—
20	D	37	940	30	762	20	508	Floor	WS364	WMB363364	CMB364	—
21	D	37	940	30	762	24	610	Floor	WS364	—	CMB364	—
22	D	43.8	1111	32	813	27	686	Floor	WS380	—	CMB380	—
24	D	49.5	1257	35	889	28.5	724	Floor	WS381	—	CMB381	—
25	D	49.5	1257	41	1041	32	813	Floor	WS382	—	—	—
26	D	57.5	1461	41	1041	32	813	Floor	WS382	—	—	—
28	D	60	1524	56	1422	36	914	Floor	WS370A	—	—	—
29	D	68	1727	56	1422	36	914	Floor	WS370A	—	—	—
30	D	71	1803	48	1219	36	914	Floor	WS383	—	—	—
31	D	74	1880	56	1422	40.5	1029	Floor	WS384	—	—	—
17	M	23.98	609	21.50	546	21.18	538	Floor	7400WS17M	7400WMB17M	7400CMB17M	—
18	M	28.31	719	25.51	648	24.69	627	Floor	7400WS18-M19M	7400WMB18M19M20-M	7400CMB18M19M20M	—
19	M	29.33	745	25.51	648	25.94	659	Floor	7400WS18-M19M	7400WMB18M19M20-M	7400CMB18M19M20M	—
20	M	33.50	851	30.08	764	27.44	697	Floor	7400WS20M	7400WMB18M19M20-M	7400CMB18M19M20M	—
21	M	37.52	953	31.30	795	28.43	722	Floor	7400WS21M	n/a	7400CMB21M	—
22	M	40.59	1031	33.66	855	32.56	827	Floor	7400WS22M	n/a	7400CMB22M	—
24	—	—	—	—	—	—	—	—	—	—	—	—
25	J	57.5	1461	40.1	1019	32.75	832	Floor	7400WS25J	—	—	7400DS25J
30	J	71	1803	48.25	1226	37.9	963	Floor	7400WS30J	—	—	7400DS30J
31	J	76	1930	56	1422	44.5	1130	Floor	7400WS31J	—	—	7400DS31J

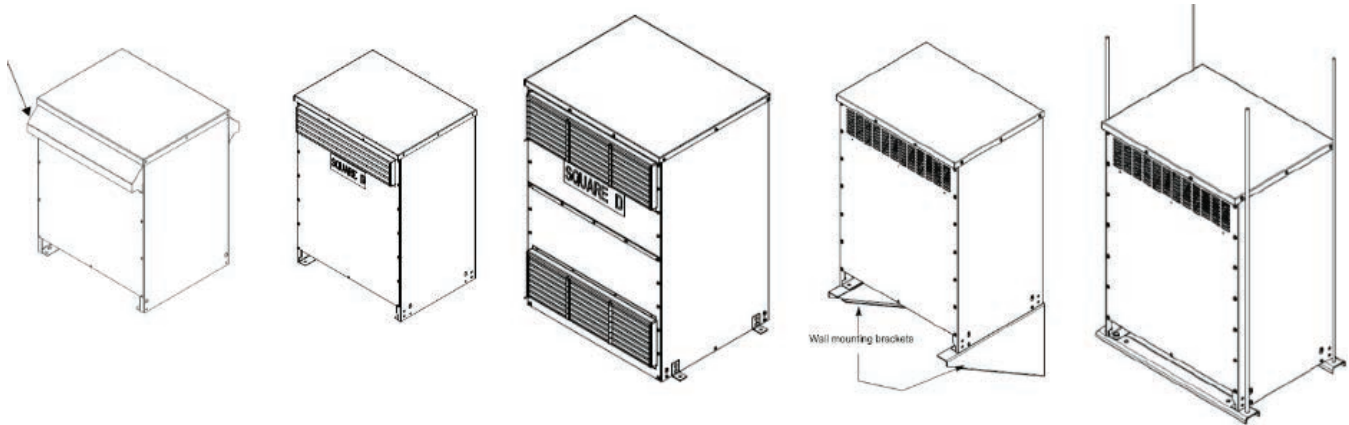

New Optional Floor Mounting Kit — Enclosures M and J

[13] These dimensions are not for construction. Contact your local Schneider Electric.

[14] Wall mounting brackets are used with units weighing no more than 700 lbs.

[15] Ceiling mounting brackets are used with units weighing no more than 1200 lbs.





Table 14.9: Mechanical Lug Kits

Catalog No.	Lugs Per Kit	Wire Range	Cap Screws	Current Range	Grounding Lugs per Kit	Wire Range	Bonding Lugs per Kit	Wire Range
<b>Single-Phase Primary, Single-Phase Secondary, Three-Phase Delta Primary, Three-Phase Delta Secondary</b>								
DASKP100	3	1/0–14 STR	1/4 x 1 in.	Up to 100 A	Not applicable	Not applicable	Not applicable	Not applicable
DASKP250	3	350 kcmil–6 STR	3/8 x 2 in.	101 to 250 A				
DASKP400	3	600 kcmil–4 STR (2) 250 kcmil–1/0 STR	3/8 x 2 in.	201 to 400 A				
DASKP600	6	600 kcmil–4 STR (2) 250 kcmil–1/0 STR	3/8 x 2 in.	601 to 800 A				
DASKP1000	9	600 kcmil–2 STR	3/8 x 2 in.	601 to 800 A				
DASKP1200	12	600 kcmil–2 STR	3/8 x 2 in.	801 to 1200 A				
<b>Single-Phase Primary and Secondary, Three-Phase Wye Secondary, Three-Phase Delta with Center Tap</b>								
DASKGS100	5	1/0–14 STR	1/4 x 1 in.	Up to 100 A	1	(4) 2/0 to 14 STR	1	2 to 14 STR
DASKGS250	5	350 kcmil–6 STR	3/8 x 2 in.	101 to 250 A	1	(4) 2/0 to 14 STR	1	2 to 14 STR
DASKGS400	5	600 kcmil–4 STR (2) 250 kcmil–1/0 STR	3/8 x 2 in.	201 to 400 A	1	(4) 2/0 to 14 STR	1	1/0 to 14 STR
DASKGS600	10	600 kcmil–2 STR	3/8 x 2 in.	601 to 800 A	1	(4) 350 kcmil to 6 STR	1	250 kcmil to 6 STR
DASKGS1000	15	600 kcmil–2 STR	3/8 x 2 in.	601 to 800 A	1	(4) 350 kcmil to 6 STR	1	250 kcmil to 6 STR
DASKGS1200	20	600 kcmil–2 STR	3/8 x 2 in.	801 to 1200 A	1	(4) 350 kcmil to 6 STR	1	250 kcmil to 6 STR
DASKGS2000	25	600 kcmil–2 STR	3/8 x 2 in.	1201 to 2000 A	1	(4) 350 kcmil to 6 STR	1	250 kcmil to 6 STR

Lugs are not supplied with transformer units. They must be purchased separately.

Table 14.10: Compression Lug Kits

Transformer kVA Sizes	Kit Catalog No.	Terminal Lugs		Aluminum or Copper Conductor Range (AWG or kcmil)	Hardware Included	
		Qty.	Catalog No.		Qty.	Cap Screws
15–37 ½ 1Ø 15–45 3Ø	VCELSK1	8	VCCEL02114S1	#8–1/0 #4–300 kcmil	8	1/4 x 1 in.
		5	VCCEL030516H1		1	1/4 x 2 in.
50–75 1Ø 75–112 ½ 3Ø	VCELSK2	13	VCCEL030516H1	#4–300 kcmil	8	1/4 x 1 in.
			VCCEL030516H1		3	1/4 x 3/4 in.
100–167 1Ø 150–300 3Ø	VCELSK3	3	VCCEL07512H1	500–750 kcmil Al 500 kcmil Cu	16	3/8 x 2 in.
		26	VCCEL07512H1			
500 3Ø	VCELSK4	34	VCCEL07512H1	500–750 kcmil Al 500 kcmil Cu	21	3/8 x 2 in.

Schneider Electric Low Voltage Transformers have been qualified to the site-specific requirements of the following listed model building code and/or standard. (International Building Code, California Building Code, Uniformed Building Code). Qualification based on tri-axial shake table test results conducted in accordance with the AC156 test protocol3 (Acceptance Criteria for Seismic Qualification Testing of Nonstructural Components).

- Enclosure 1A to 11A, 12C to 16C, 12B to 15B (Resin Encapsulated Transformers)
- Enclosure 17D to 31D, 17H to 18H, 17K to 22K, 25J to 31J (Ventilated Transformers)
- Enclosure 17K to 20K with wall mounting bracket (Ventilated Transformers)
- Enclosure 17E to 31E (Non-ventilated Transformers)
- Enclosure MPZ A, AA, B, BB, C, CC (MPZB)

Product is Listed for installation in Hospitals State of California–OSHPD Special Seismic Certification Preapproval OSP-0023-10.

Accessory Lables–required for Building Inspection–OSHPD		
OSP Label Catalog Number	Products	Enclosure Style
7400CAOSHPDABC	Resin encapsulated, buck boost transformers	Style A, B, C
7400CAOSHPDDH	Ventilated Type EE, drive isolation, auto-transformers	Style D, H
7400CAOSHPDF	Low voltage 750 and 1000 kVA Type EE	Style F
7400CAOSHPDJ	Ventilated Type EX	Style J
7400CAOSHPDK	Ventilated Type EX	Style K
7400CAOSHPDKO	Ventilated Type EX, wall-mounted using Square D brackets	Style K with WMB
7400CAOSHPDMPZB	Mini Power Zone Bolt-on	A, AA, B, BB, C, CC

**Sealed, Mini Power-Zone™ Unit Substation**

The Square D™ brand Mini Power-Zone™ unit substation from Schneider Electric provides the answer to requirements for a compact unit substation at low amperage ratings.. This complete package yields considerable savings on floor space, installation, and overall cost.

**NOTE:** Mini Power-Zone unit substations are UL 1062 Listed File E92978 design in a Type 3R enclosure allowing for indoor or outdoor applications. Designed for wall-mounting, the unit substation leverages Schneider Electric components integrated into one device..

- Epoxy resin encapsulated low voltage transformer
- H-frame main circuit breaker
- Secondary main circuit breaker
- Square D panel board or load center allowing for QO™ or QOB™ branch circuit breakers

*New!*

New MPU solution leverages the latest load center interiors, giving customers more flexibility for branch circuit requirements. Additionally design with a tiered dead front construction. The first dead front allows access to the secondary main circuit breaker, distribution panel board, and the second dead front. The second dead front allows access to the primary main circuit breaker and incoming voltage connection points.



**Table 14.11: Distribution System Square D Load Centers (allowing plug-on QO circuit breakers only)**

kVA	Catalog No.	Full Capacity Taps <sup>[16]</sup>	Enclosure	Weight (lbs)	Primary Main Circuit Breaker Rating (A)	Secondary Main Circuit Breaker Rating (A)	Spaces for Branch Circuit Breakers
<b>Single Phase Unit Substation Input: 480 Vac, 18 kAIC; Output: 120 / 240 Vac</b>							
3	MPU3S40F	2-5% FCBN	MPU-A	85	15	15	10
5	MPU5S40F	2-5% FCBN	MPU-A	135	15	30	10
7.5	MPU7S40F	2-5% FCBN	MPU-A	145	20	40	10
10	MPU10S40F	2-5% FCBN	MPU-A	220	30	60	10
15	MPU15S40F	2-5% FCBN	MPU-B	350	60	80	22
25	MPU25S40F	2-5% FCBN	MPU-B	425	100	125	22
<b>Three-Phase Unit Substation Input: 480 Vac 18 kAIC; Output: 208Y / 120 Vac</b>							
15	MPU15T2F	2-5% FCBN	MPU-C	510	40	60	27
22.5	MPU22T2F	2-5% FCBN	MPU-C	670	60	80	27
30	MPU30T2F	2-5% FCBN	MPU-C	695	90	100	27

**Table 14.12: Bolt-On Circuit Breakers**

kVA	Catalog No.				Full Capacity Taps <sup>[16]</sup>	Enclosure	Weight (lbs)	Primary Main Circuit Breaker Rating (A)	Secondary Main Circuit Breaker Rating (A)	Spaces for Branch Circuit Breakers
	18 kAIC		25 kAIC	65 kAIC						
<b>Single-Phase Unit Substation Input: 480 Vac, 18 kAIC; Output: 120 / 240 Vac</b>										
3	MPZB3S40F	MPZB3S40FSS	MPZB3S40F25K	MPZB3S40F65K	2-5% FCBN	MPZ-AA	85	15	15	16
5	MPZB5S40F	MPZB5S40FSS	MPZB5S40F25K	MPZB5S40F65K	2-5% FCBN	MPZ-AA	135	15	30	16
7.5	MPZB7S40F	MPZB7S40FSS	MPZB7S40F25K	MPZB7S40F65K	2-5% FCBN	MPZ-AA	145	20	40	16
10	MPZB10S40F	MPZB10S40FSS	MPZB10S40F25K	MPZB10S40F65K	2-5% FCBN	MPZ-AA	220	30	60	16
15	MPZB15S40F	MPZB15S40FSS	MPZB15S40F25K	MPZB15S40F65K	2-5% FCBN	MPZ-BB	350	60	80	28
25	MPZB25S40F	MPZB25S40FSS	MPZB25S40F25K	MPZB25S40F65K	2-5% FCBN	MPZ-BB	425	100	125	28
<b>Three-Phase Unit Substation Input: 480 Vac, 18 kAIC; Output 208Y / 120 Vac</b>										
15	MPZB15T2F	MPZB15T2FSS	MPZB15T2F25K	MPZB15T2F65K	2-5% FCBN	MPZ-CC	510	40	60	27
22.5	MPZB22T2F	MPZB22T2FSS	MPZB22T2F25K	MPZB22T2F65K	2-5% FCBN	MPZ-CC	670	60	80	27
30	MPZB30T2F	MPZB30T2FSS	MPZB30T2F25K	MPZB30T2F65K	2-5% FCBN	MPZ-CC	695	90	100	27

**Table 14.13: Enclosure Dimensions and Accessories**

Enclosure Number/Style		Height		Width		Depth		Mounting
		in.	mm	in.	mm	in.	mm	
MPU	A	32.9	836	14.0	356	11.8	300	Wall
MPU	B	43.2	1097	21.0	533	13.5	343	Wall
MPU	C	45.2	1148	27.4	696	13.5	343	Wall
MPZ	BB	51.1	1298	21.4	544	13.5	343	Wall
MPZ	C	45.2	1148	27.4	696	13.5	343	Wall
MPZ	CC	48.6	1234	27.4	696	13.5	343	Wall

**NOTE:** Dimensions should not be used for construction. Contact you local Schneider Electric representative for certified prints.  
FCBN = Full Capacity Below Normal

[16] FCBN = Full Capacity Below Normal.

**Resin Encapsulated Three and Single Phase Transformers**

**Table 14.14: Resin Encapsulated Three and Single Phase Transformers**

kVA	Type 3R STD			Type 3R 304 Stainless			Type 4X 304 Stainless					
	Catalog No.	Weight (lbs) <sup>[17]</sup>	Enclosure <sup>[18]</sup>	Catalog No.	Weight (lbs) <sup>[17]</sup>	Enclosure <sup>[19]</sup>	Catalog No.	Weight (lbs) <sup>[17]</sup>	Enclosure <sup>[19]</sup>	Full Capacity Taps <sup>[20]</sup>	Deg C Temp. Rise	Insulation Class
<b>Three Phase—480 Vac Delta Primary 208Y/120 Vac Secondary, 60 Hz; UL/cULus Listed</b>												
3	3T2F	120	12C	3T2SS	120	12C	4X3T2FSS	165	54X	2-5%FCBN	115	180
6	6T2F	145	12C	6T2SS	145	12C	4X6T2FSS	195	54X	2-5%FCBN	115	180
9	9T2F	235	14C	9T2SS	235	14C	4X9T2FSS	290	54X	2-5%FCBN	115	180
15	15T2F	300	14C	15T2SS	300	14C	4X15T2FSS	350	54X	2-5%FCBN	115	180
30	30T2F	660	16C	30T2SS	660	16C	4X30T2FSS	850	55X	2-5%FCBN	115	180
<b>Three Phase—480 Vac Delta Primary 240 Vac Delta Secondary, 60 Hz; UL/cULus Listed</b>												
3	3T5F	120	12C	3T5SS	120	12C	4X3T5FSS	165	54X	2-5%FCBN	115	180
6	6T5F	145	12C	6T5SS	145	12C	4X6T5FSS	195	54X	2-5%FCBN	115	180
9	9T75F	235	14C	9T75SS	235	14C	4X9T75FSS	290	54X	2-5%FCBN	115	180
15	15T75F	300	14C	15T75SS	300	14C	4X15T75FSS	350	54X	2-5%FCBN	115	180
30	30T75F	660	16C	30T75SS	660	16C	4X30T75FSS	850	55X	2-5%FCBN	115	180
<b>Single Phase—240 x 480 Vac Primary 120/240 Vac Secondary, 60 Hz; UL/cULus Listed</b>												
1	1S1F	21.2	7A	1S1FSS	21.2	7A	4X1S1FSS	48	51X	None	115	180
1.5	1.5S1F	30.1	8A	1.5S1FSS	30.1	8A	4X1.5S1FSS	55	51X	None	115	180
2	2S1F	39.1	9A	2S1FSS	39.1	9A	4X2S1FSS	55	51X	None	115	180
3	3S1F	60	10A	3S1FSS	60	10A	4X3S1FSS	75	52X	None	115	180
5	5S1F	115	13B	5S1FSS	115	13B	4X5S1FSS	125	52X	None	115	180
7.5	7.5S1F	135	13B	7.5S1FSS	135	13B	4X7.5S1FSS	150	52X	None	115	180
10	10S1F	165	13B	10S1FSS	165	13B	4X10S1FSS	180	52X	None	115	180
15	15S1F	225	15B	15S1FSS	225	15B	4X15S1FSS	390	53X	None	115	180
25	25S1F	300	15B	25S1FSS	300	15B	4X25S1FSS	450	53X	None	115	180
<b>Single Phase—480 Vac Primary 120/240 Vac Secondary, 60 Hz; UL/cULus Listed</b>												
1	1S40F	21.2	7A	1S40FSS	21.2	7A	4X1S40FSS	48	51X	2-5%FCBN	115	180
1.5	1.5S40F	30.1	8A	1.5S40FSS	30.1	8A	4X1.5S40FSS	55	51X	2-5%FCBN	115	180
2	2S40F	39.1	9A	2S40FSS	39.1	9A	4X2S40FSS	55	51X	2-5%FCBN	115	180
3	3S40F	60	10A	3S40FSS	60	10A	4X3S40FSS	75	52X	2-5%FCBN	115	180
5	5S40F	115	13B	5S40FSS	115	13B	4X5S40FSS	125	52X	2-5%FCBN	115	180
7.5	7.5S40F	135	13B	7.5S40FSS	135	13B	4X7.5S40FSS	150	52X	2-5%FCBN	115	180
10	10S40F	165	13B	10S40FSS	165	13B	4X10S40FSS	180	52X	2-5%FCBN	115	180
15	15S40F	225	15B	15S40FSS	225	15B	4X15S40FSS	390	53X	2-5%FCBN	115	180
25	25S40F	300	15B	25S40FSS	300	15B	4X25S40FSS	450	53X	2-5%FCBN	115	180
<b>Single Phase—600 Vac Primary 120/240 Vac Secondary, 60 Hz; UL/cULus Listed</b>												
1	1S51F	21.2	7A	1S51FSS	21.2	7A	4X1S51FSS	48	51X	None	115	180
1.5	1.5S51F	30.1	8A	1.5S51FSS	30.1	8A	4X1.5S51FSS	55	51X	None	115	180
2	2S51F	39.1	9A	2S51FSS	39.1	9A	4X2S51FSS	55	51X	None	115	180
3	3S4F	60	10A	3S4FSS	60	10A	4X3S4FSS	75	52X	2-5%FCBN	115	180
5	5S4F	115	13B	5S4FSS	115	13B	4X5S4FSS	125	52X	2-5%FCBN	115	180
7.5	7.5S4F	135	13B	7.5S4FSS	135	13B	4X7.5S4FSS	150	52X	2-5%FCBN	115	180
10	10S4F	165	13B	10S4FSS	165	13B	4X10S4FSS	180	52X	2-5%FCBN	115	180
15	15S4F	225	15B	15S4FSS	225	15B	4X15S4FSS	390	53X	2-5%FCBN	115	180
25	25S4F	300	15B	25S4FSS	300	15B	4X25S4FSS	450	53X	2-5%FCBN	115	180
<b>Single Phase—208 Vac Primary 120/240 Vac Secondary, 60 Hz; UL/cULus Listed</b>												
1	1S7F	21.2	7A	1S7FSS	21.2	7A	4X1S7FSS	48	51X	None	115	180
1.5	1.5S7F	30.1	8A	1.5S7FSS	30.1	8A	4X1.5S7FSS	55	51X	None	115	180
2	2S7F	39.1	9A	2S7FSS	39.1	9A	4X2S7FSS	55	51X	None	115	180
3	3S60F	60	10A	3S60FSS	60	10A	4X3S60FSS	75	52X	2-5%FCBN	115	180
5	5S60F	115	13B	5S60FSS	115	13B	4X5S60FSS	125	52X	2-5%FCBN	115	180
7.5	7.5S60F	135	13B	7.5S60FSS	135	13B	4X7.5S60FSS	150	52X	2-5%FCBN	115	180
10	10S60F	165	13B	10S60FSS	165	13B	4X10S60FSS	180	52X	2-5%FCBN	115	180
15	15S60F	225	15B	15S60FSS	225	15B	4X15S60FSS	390	53X	2-5%FCBN	115	180
25	25S60F	300	15B	25S60FSS	300	15B	4X25S60FSS	450	53X	2-5%FCBN	115	180
<b>Single Phase—277 Vac Primary 120/240 Vac Secondary, 60 Hz; UL/cULus Listed</b>												
1	1S8F	21.2	7A	1S8FSS	21.2	7A	4X1S8FSS	48	51X	None	115	180
1.5	1.5S8F	30.1	8A	1.5S8FSS	30.1	8A	4X1.5S8FSS	55	51X	None	115	180
2	2S8F	39.1	9A	2S8FSS	39.1	9A	4X2S8FSS	55	51X	None	115	180
3	3S61F	60	10A	3S61FSS	60	10A	4X3S61FSS	75	52X	2-5%FCBN	115	180
5	5S61F	115	13B	5S61FSS	115	13B	4X5S61FSS	125	52X	2-5%FCBN	115	180
7.5	7.5S61F	135	13B	7.5S61FSS	135	13B	4X7.5S61FSS	150	52X	2-5%FCBN	115	180
10	10S61F	165	13B	10S61FSS	165	13B	4X10S61FSS	180	52X	2-5%FCBN	115	180
15	15S61F	225	15B	15S61FSS	225	15B	4X15S61FSS	390	53X	2-5%FCBN	115	180
25	25S61F	300	15B	25S61FSS	300	15B	4X25S61FSS	450	53X	2-5%FCBN	115	180

**Table 14.15: Single-Phase—120/240 Vac Secondary 60 Hz; cULus Listed**

kVA	240 x 480 Primary Catalog No.	Weight (lbs) <sup>[17]</sup>	Enclosure <sup>[19]</sup>	600 Primary Catalog No.	Weight (lbs) <sup>[17]</sup>	Enclosure <sup>[19]</sup>	Full Capacity Taps	Degree C Temperature Rise	Insulation Class
0.05	50SV1A	4.2	1A	50SV51A	4.2	1A	None	55	105
0.1	100SV1A	4.5	2A	100SV51A	4.5	2A	None	55	105
0.15	150SV1A	6.2	3A	150SV51A	6.2	3A	None	55	105
0.25	250SV1B	10.5	4A	250SV51B	10.5	4A	None	80	130
0.5	500SV1B	13.8	5A	500SV51B	13.8	5A	None	80	130
0.75	750SV1F	15.5	6A	750SV51F	15.5	6A	None	115	180

[17] Not for construction, Contact your local Schneider Electric representative for certified prints.  
 [18] For enclosure styles, see Table 14.8 Enclosure Dimensions and Accessories, page 14-8  
 [19] For enclosure styles, see Enclosure Dimensions, page 14-12  
 [20] FCBN = Full Capacity Below Normal.

**Resin Encapsulated Export Model and Buck Boost Transformers Single Phase Export Model**

These general purpose transformers accommodate voltage systems world wide. Export model transformers 10 kVA and smaller, CE marked in addition to being cULus Listed. For CE marked transformers in other ratings, contact your local Schneider Electric representative for CE marked transformers up to 300 kVA, single and three phase.

**Table 14.16: Single-Phase—110 / 220 Vac Secondary; 50/60 Hz; cULus Listed (240 x 480 Vac Primary to 120 / 240 Vac Secondary - 60 Hz only)**

kVA	220 x 440 Primary Catalog No.	Weight (lbs)[21]	Enclosure[22]	Full Capacity Taps	Degree C Temperature Rise	Insulation Class
1	1S67F	21.2	7A	190/200/208/220 x 380/400/416/440	115	180
2	2S67F	39.1	9A	190/200/208/220 x 380/400/416/440	115	180
3	3S67F	55.2	10A	190/200/208/220 x 380/400/416/440	115	180
5	5S67F	135	13B	190/200/208/220 x 380/400/416/440	115	180
7.5	7S67F	165	13B	190/200/208/220 x 380/400/416/440	115	180
10	10S67F	165	13B	190/200/208/220 x 380/400/416/440	115	180

**Sealed Single-Phase Buck and Boost**

When buck and boost transformers are interconnected as an autotransformer, they can supply small changes in voltage. Wiring diagrams and sizing are available from catalog 7414CT0201 or www.buckboostcalculator.com.

Units can also be used as isolation transformers for:

120 x 240 to 12/24 or 16/32 and 240 x 480 to 24/48 by connecting using the diagram on the nameplate.

**NOTE:** When used to supply a three-phase four-wire load, the source must be three-phase four-wire.

kVA	120 x 240 Vac Primary 60 Hz		240 x 480 Vac Primary 60 Hz	Weight (lbs)[21]	Enclosure[22]	Degree C Temperature Rise	Insulation Class
	12/24 Vac Secondary	16/32 Vac Secondary	24/48 Vac Secondary				
0.05	50SV43A	50SV46A	50SV82A	4.2	1A	55	105
0.1	100SV43A	100SV46A	100SV82A	4.5	2A	55	105
0.15	150SV43A	150SV46A	150SV82A	6.2	3A	55	105
0.25	250SV43B	250SV46B	250SV82B	10.5	4A	80	130
0.5	500SV43B	500SV46B	500SV82B	13.8	5A	80	130
0.75	750SV43F	750SV46F	750SV82F	15.5	6A	115	180
1	1S43F	1S46F	1S82F	21.2	7A	115	180
1.5	1.5S43F	1.5S46F	1.5S82F	30.1	8A	115	180
2	2S43F	2S46F	2S82F	39.1	9A	115	180
3	3S43F	3S46F	3S82F	60		115	180

\* See table 14.17 3 kVA Buck Boost

**3 kVA Buck Boost**

**Table 14.17: Enclosure Dimensions**

Enclosure Number/ Style		Height		Width		Depth		Mounting
		in.	mm	in.	mm	in.	mm	
1	A	5.00	127	4.47	114	3.44	87	Wall
2	A	5.50	140	4.47	114	3.44	87	Wall
3	A	5.00	127	4.85	123	3.75	95	Wall
4	A	5.50	140	5.23	133	4.06	103	Wall
5	A	6.19	157	6.19	157	4.69	119	Wall
6	A	6.69	170	6.19	157	4.69	119	Wall
7	A	8.13	207	6.94	176	5.31	135	Wall
8	A	8.25	210	8.68	220	6.56	167	Wall
9	A	9.56	243	8.68	220	6.56	167	Wall
10	A	10.50	267	8.62	219	6.50	165	Wall
11	A	12.56	319	8.62	219	6.50	165	Wall
<b>* 3 kVA Buck Boost</b>		14.5	—	8.62	—	6.5	—	—
12	C	13.50	343	14.75	375	9	229	Wall
13	B	14.75	375	9.75	248	11.75	298	Wall
14	C	14.75	375	19.1	485	2.25	311	Wall
15	B	20.00	508	15	381	13.5	343	Wall
16	C	22.00	559	25	635	13.5	343	Wall
51	X	9.5	24	10	25	7.75	20	Wall
52	X	12	30	13.75	35	13.75	35	Wall
53	X	24	61	21.5	55	16.38	42	Floor
54	X	23	58	25.5	65	13.75	35	Floor
55	X	31.5	80	31.5	80	16.25	41	Floor

These dimensions are not for construction. Contact your local Schneider Electric representative for certified prints.

Fingersafe™ terminal block cover kits for encapsulated transformers can be used to meet touch-safe requirements.

Enclosure	Kit Catlog Number	Description
7A (1 kVA)	7400ENT9	Terminal Block H1, H2, H3, H4, H5, H6, H7, H8, H9, H10 and X1, X2, X3, X4
9A (2 kVA)	7400ENT11	Terminal Block H1, H2, H3, H4, H5, H6, H7, H8, H9, H10 and X1, X2, X3, X4
10A (3 kVA)	7400ENT11	Terminal Block H1, H2, H3, H4, H5, H6, H7, H8, H9, H10 and X1, X2, X3, X4
13B (5–10 kVA)	7400ENT13	Terminal Block H1, H2, H3, H4, H5, H6, H7, H8, H9, H10 and X1, X2, X3, X4

[21] Not for construction, Contact your local Schneider Electric representative for certified prints.

[22] For enclosure styles, see Enclosure Dimensions, page 14-12



Style A—Type 3R Rated



Style B—Type 3R Rated



Style C—Type 3R Rated



Style X—Type 4X Rated

**Non-Ventilated and Transformer House**

**Table 14.18: NV Three Phase; 60 Hz; 208Y / 120 Vac Secondary**<sup>[23]</sup>

kVA	Type 3R - IP 54 Catalog No.	Type 3R - IP 54 Catalog 304 Stainless Steel	Full Capacity Taps	Degree C Temp. Rise	Insulation Class	%IZ	Weight (lbs) <sup>[24]</sup>	Enclosure <sup>[25]</sup>
<b>480 Vac Delta Primary, Aluminum Windings</b>								
15	15T3HNV	15T3HNVSS	6-2.5%2+4-	150	220	2.8	—	—
30	30T3HNV	30T3HNVSS	6-2.5%2+4-	150	220	3.5	340	19E
45	45T3HNV	45T3HNVSS	6-2.5%2+4-	150	220	3.3	510	19E
75	75T3HNV	75T3HNVSS	6-2.5%2+4-	150	220	2.5	1025	22E
112.5	112T3HNV	112T3HNVSS	6-2.5%2+4-	150	220	3.3	1250	24E
150	150T3HNV	150T3HNVSS	6-2.5%2+4-	150	220	2.9	2000	25E
225	225T3HNV	225T3HNVSS	6-2.5%2+4-	150	220	4.3	2100	30E
300	300T3HNV	300T3HNVSS	6-2.5%2+4-	150	220	2.8	3950	31E

**Table 14.19: NV Single Phase; 60 Hz; 120/240 Vac Secondary**<sup>[23]</sup>

kVA	Type 3R - IP 54 Catalog No.	Type 3R - IP 54 Catalog 304 Stainless Steel	Full Capacity Taps	Degree C Temp. Rise	Insulation Class	%IZ	Weight (lbs) <sup>[24]</sup>	Enclosure <sup>[25]</sup>
<b>240 x 480 Vac Primary, Aluminum Windings</b>								
15	15S3HNV	15S3HNVSS	480 Vac 6 - 2.5% 2+4- 240 Vac 3 - 5% 1+2-	150	220	4.4	230	17E
25	25S3HNV	25S3HNVSS		150	220	4.1	310	18E
37.5	37S3HNV	37S3HNVSS		150	220	4.4	350	18E
50	50S3HNV	50S3HNVSS		150	220	3.1	450	21E
75	75S3HNV	75S3HNVSS		150	220	2.9	880	24E
100	100S3HNV	100S3HNVSS		150	220	1.7	975	25E

**Table 14.20: Enclosure Dimensions and Accessories**

Enclosure Number/ Style	Height		Width		Depth		Mounting	Wall Mounting Bracket	Ceiling Mounting Bracket	Insulation Class oC	
	in.	mm	in.	mm	in.	mm					
17	E	27	686	20	508	16	406	Floor	WMB361362	CMB363	220
18	E	30	762	20	508	20	508	Floor	WMB363364	CMB363	220
19	E	30	762	30	762	20	508	Floor	WMB363364	CMB364	220
21	E	37	940	30	762	24	610	Floor	—	CMB364	220
22	E	43.75	1111	32	813	27	686	Floor	—	CMB380	220
24	E	49.5	1257	35	889	28.5	724	Floor	—	CMB381	220
25	E	49.5	1257	41	1041	32	813	Floor	—	—	220
26	E	57.5	1461	41	1041	32	813	Floor	—	—	220
28	E	60	1524	56	1422	36	914	Floor	—	—	220
29	E	68	1727	56	1422	36	914	Floor	—	—	220
30	E	71	1803	48	1219	36	914	Floor	—	—	220
31	E	74	1880	56	1422	40.5	1029	Floor	—	—	220

These dimensions are not for construction. Contact your local Schneider Electric representative for certified prints.



Style E—IP55 Rated



**PZC Transformer Enclosures**

Power Zone Center house is installed over the standard ventilated units to provide additional security and environmental protection.

**Type 3R enclosure Option No. 1 constructed of 304 stainless steel for corrosive protection.**

Designed to allow energy efficient transformers to be installed in environments requiring more protection.

**Type 3R enclosure Option No. 2 constructed of painted galvanized for safety**

Designed to allow energy efficient transformers to be secured with a padlockable handle for security, which is ideal for school yards.

PZC transformer enclosures are shipped separately from transformers so they can be pre-installed on the job site.

Four standard enclosures of each type material are available for installation of transformer enclosure types D and H.

Drawings are in the Classic Technical Library. Search by catalog number, which is the same as the drawing number.

**Table 14.21: Stainless Steel Option**

Catalog No.	L	W	H	Weight	Enclosure
7400SS3R-001	3'-8"	3'-4"	4'-9"	450 lbs	17D, 17H, 18D, 18H, 19D, 20D, 21D, 22D
7400SS3R-002	4'-6"	3'-9"	6'-0"	500 lbs	24D, 25D, 26D, 36D, 37D
7400SS3R-003	5'-8"	4'-1"	7'-0"	550 lbs	28D, 29D, 30D, 38D
7400SS3R-004	6'-4"	4'-9"	7'-10"	600 lbs	31D, 45D

**Table 14.22: Painted Galvanized Option**

Catalog No.	L	W	H	Weight	Enclosure
7400PG3R-001	3'-8"	3'-4"	4'-9"	450 lbs	17D, 17H, 18D, 18H, 19D, 20D, 21D, 22D
7400PG3R-002	4'-6"	3'-9"	6'-0"	500 lbs	24D, 25D, 26D, 36D, 37D
7400PG3R-003	5'-8"	4'-1"	7'-0"	550 lbs	28D, 29D, 30D, 38D
7400PG3R-004	6'-4"	4'-9"	7'-10"	600 lbs	31D, 45D

[23] Lugs are furnished by customer.

[24] Not for construction, Contact your local Schneider Electric representative for certified prints.

[25] For enclosure styles, see Table 14.20 Enclosure Dimensions and Accessories, page 14-13

### Type T and Type TF

Type T transformers are designed with low impedance windings for excellent voltage regulation and can accommodate the high inrush current associated with contactors, starters, solenoids, and relays. Type T transformers are manufactured using the most advanced insulating materials and are the best choice if size and cost are of concern.

Type TF transformers include factory-installed primary and secondary fuse blocks. Type TF transformers consist of two primary fuse blocks and one secondary fuse block. The primary includes rejection-style clips to increase the AIC ratings for the fuses. Since the fuse blocks are mounted on the top of the transformer, Type TF transformers are interchangeable with Type T transformers except for their increased height.

#### Selection Guide

1. Determine the inrush and sealed VA of each coil in the control circuit and the VA of all other components.
2. Total the **sealed** VA of all operating coils and the VA of all other loads. (This determines the minimum VA size required for the circuit.)
3. Total the **inrush** VA of all coils that are starting at the same time and all loads and coils that are running.
4. Locate a value in the VA column of [Table 14.23 Regulation Chart for Type T, page 14-14](#), shown below, that is **equal to** or **greater than** the value calculated in step 2.
5. In the VA row selected in step 4, find the inrush value under the appropriate voltage regulation column of [Table 14.23 Regulation Chart for Type T, page 14-14](#), shown below. If this value is **greater than** the calculated value from step 3, this is the correct transformer VA rating.

If the inrush value on the selected VA row is **not greater than** the calculated value from step 3, use the next higher transformer VA rating, that is, the rating on the next row.

If your supply voltage is stable and fluctuates less than 5%, Schneider Electric recommends you use the 90% secondary voltage column. If your supply voltage is not stable and fluctuates more than 10% we recommend you use the 95% secondary voltage column. We recommend that you never use the 85% secondary voltage column since magnetic devices lose life expectancy if they are continuously started at 85% of rated voltage.

**Table 14.23: Regulation Chart for Type T**

VA	Inrush VA @ 20% power factor			Inrush VA @ 40% power factor		
	95% Secondary Voltage	90% Secondary Voltage	85% Secondary Voltage	95% Secondary Voltage	90% Secondary Voltage	85% Secondary Voltage
50	193	266	339	151	215	282
75	271	396	500	210	318	430
100	339	499	659	266	404	549
150	666	893	1120	529	731	942
200	588	815	1041	459	659	866
250	1416	1910	2388	1057	1494	1936
300	1634	2184	2709	1194	1681	2169
350	1894	2592	3261	1392	2005	2621
500	3197	4104	4981	2374	3195	4019
750	3770	5515	7231	2887	4391	5945
1000	6587	9079	11430	4706	6886	9051
1500	19324	23983	28607	15066	19361	23756
2000	31384	38777	6161	24794	31630	38667
3000	26539	39934	52713	19355	30721	42216
5000	53111	85265	116277	39368	66309	93882





**Table 14.24: 240 x 480 V Primary, 120 V Secondary; 230 x 460 V Primary, 115 V Secondary; 220 x 440 V Primary, 110 V Secondary**

VA		Type T	Type TF	Weight	Height				Width		Depth		Accesso-ry Finger-safe Covers
UL/CSA/NOM	CE	Catalog No.			Type T		Type TF		in.	mm	in.	mm	
		in.	mm		in.	mm							
25	25	9070T25D1	9070TF25D1	2.5	2.58	66	4.00	102	3.00	76	3.09	79	FSC1
50	50	9070T50D1	9070TF50D1	2.5	2.58	66	4.00	102	3.00	76	3.09	79	FSC1
75	75	9070T75D1	9070TF75D1	3.8	2.89	73	4.18	106	3.38	86	3.34	85	FSC1
100	100	9070T100D1	9070TF100D1	3.8	2.89	73	4.18	106	3.38	86	3.34	85	FSC1
150	150	9070T150D1	9070TF150D1	5.5	3.20	81	4.50	114	3.75	95	3.59	91	FSC1
200	200	9070T200D1	9070TF200D1	5.5	3.20	81	4.50	114	3.75	95	3.59	91	FSC1
250	160	9070T250D1	9070TF250D1	7.1	3.20	81	4.50	114	3.75	95	5.30	135	FSC2
300	200	9070T300D1	9070TF300D1	8.5	3.84	98	5.13	130	4.50	114	4.74	120	FSC2
350	250	9070T350D1	9070TF350D1	10.5	3.84	98	5.13	130	4.50	114	5.11	130	FSC2
500	300	9070T500D1	9070TF500D1	11.9	3.84	98	5.13	130	4.50	114	5.49	139	FSC2
750	500	9070T750D1	9070TF750D1	11.0	4.51	115	5.80	147	5.25	133	5.61	143	FSC2
1000	630	9070T1000D1	9070TF1000D1	20.6	4.51	115	5.80	147	5.25	133	6.30	160	FSC2
1500	1000	9070T1500D1	9070TF1500D1	34.0	6.17	157	7.46	190	7.06	179	5.92	150	FSC2
2000	1500	9070T2000D1	9070TF2000D1	47.0	6.17	157	7.46	190	7.06	179	7.17	182	FSC2
3000	2000	9070T3000D1	—	60.0	8.75	222	—	—	9.00	229	7.24	184	FSC2
5000	3000	9070T5000D1	—	89.0	8.75	222	—	—	9.00	229	9.15	232	FSC2

**Table 14.25: 208 Vac Primary, 120 Vac Secondary**

VA		Type T	Type TF	Weight	Height				Width		Depth		Accesso-ry Finger-safe Covers
UL/CSA/NOM	CE	Catalog No.			Type T		Type TF		in.	mm	in.	mm	
		in.	mm		in.	mm							
25	25	9070T25D3	9070TF25D3	2.5	2.58	66	4.00	102	3.00	76	3.09	79	FSC1
50	50	9070T50D3	9070TF50D3	2.5	2.58	66	4.00	102	3.00	76	3.09	79	FSC1
75	75	9070T75D3	9070TF75D3	3.8	2.89	73	4.18	106	3.38	86	3.34	85	FSC1
100	100	9070T100D3	9070TF100D3	3.8	2.89	73	4.18	106	3.38	86	3.34	85	FSC1
150	150	9070T150D3	9070TF150D3	5.5	3.20	81	4.50	114	3.75	95	3.59	91	FSC1
200	200	9070T200D3	9070TF200D3	5.5	3.20	81	4.50	114	3.75	95	3.59	91	FSC1
250	160	9070T250D3	9070TF250D3	7.1	3.20	81	4.50	114	3.75	95	5.30	135	FSC2
300	200	9070T300D3	9070TF300D3	8.5	3.84	98	5.13	130	4.50	114	4.74	120	FSC2
350	250	9070T350D3	9070TF350D3	10.5	3.84	98	5.13	130	4.50	114	5.11	130	FSC2
500	300	9070T500D3	9070TF500D3	11.9	3.84	98	5.13	130	4.50	114	5.49	139	FSC2
750	500	9070T750D3	9070TF750D3	11.0	4.51	115	5.80	147	5.25	133	5.61	143	FSC2
1000	630	9070T1000D3	9070TF1000D3	20.6	4.51	115	5.80	147	5.25	133	6.30	160	FSC2
1500	1000	9070T1500D3	9070TF1500D3	34.0	6.17	157	7.46	190	7.06	179	5.92	150	FSC2
2000	1500	9070T2000D3	9070TF2000D3	47.0	6.17	157	7.46	190	7.06	179	7.17	182	FSC2
3000	2000	9070T3000D3	—	60.0	8.75	222	—	—	9.00	229	7.24	184	FSC2
5000	3000	9070T5000D3	—	89.0	8.75	222	—	—	9.00	229	9.15	232	FSC2

**Table 14.26: 600 Vac Primary, 120 Vac Secondary**

VA		Type T	Type TF	Weight	Height				Width		Depth		Accesso-ry Finger-safe Covers
UL/CSA/NOM	CE	Catalog No.			Type T		Type TF		in.	mm	in.	mm	
		in.	mm		in.	mm							
25	25	9070T25D5	9070TF25D5	2.5	2.58	66	4.00	102	3.00	76	3.09	79	FSC1
50	50	9070T50D5	9070TF50D5	2.5	2.58	66	4.00	102	3.00	76	3.09	79	FSC1
75	75	9070T75D5	9070TF75D5	3.8	2.89	73	4.18	106	3.38	86	3.34	85	FSC1
100	100	9070T100D5	9070TF100D5	3.8	2.89	73	4.18	106	3.38	86	3.34	85	FSC1
150	150	9070T150D5	9070TF150D5	5.5	3.20	81	4.50	114	3.75	95	3.59	91	FSC1
200	200	9070T200D5	9070TF200D5	5.5	3.20	81	4.50	114	3.75	95	3.59	91	FSC1
250	160	9070T250D5	9070TF250D5	7.1	3.20	81	4.50	114	3.75	95	5.30	135	FSC2
300	200	9070T300D5	9070TF300D5	8.5	3.84	98	5.13	130	4.50	114	4.74	120	FSC2
350	250	9070T350D5	9070TF350D5	10.5	3.84	98	5.13	130	4.50	114	5.11	130	FSC2
500	300	9070T500D5	9070TF500D5	11.9	3.84	98	5.13	130	4.50	114	5.49	139	FSC2
750	500	9070T750D5	9070TF750D5	11.0	4.51	115	5.80	147	5.25	133	5.61	143	FSC2
1000	630	9070T1000D5	9070TF1000D5	20.6	4.51	115	5.80	147	5.25	133	6.30	160	FSC2
1500	1000	9070T1500D5	9070TF1500D5	34.0	6.17	157	7.46	190	7.06	179	5.92	150	FSC2
2000	1500	9070T2000D5	9070TF2000D5	47.0	6.17	157	7.46	190	7.06	179	7.17	182	FSC2
3000	2000	9070T3000D5	—	60.0	8.75	222	—	—	9.00	229	7.24	184	FSC2
5000	3000	9070T5000D5	—	89.0	8.75	222	—	—	9.00	229	9.15	232	FSC2

**Table 14.27: 277 Vac Primary, 120 Vac Secondary**

VA		Type T	Type TF <sup>[1]</sup>	Weight	Height				Width		Depth		Accesso-ry Finger-safe Covers
UL/CSA/NOM	CE	Catalog No.			Type T		Type TF		in.	mm	in.	mm	
		in.	mm		in.	mm							
25	25	9070T25D4	—	2.5	2.58	66	—	—	3.00	76	3.09	79	FSC1
50	50	9070T50D4	—	2.5	2.58	66	—	—	3.00	76	3.09	79	FSC1
75	75	9070T75D4	—	3.8	2.89	73	—	—	3.38	86	3.34	85	FSC1
100	100	9070T100D4	—	3.8	2.89	73	—	—	3.38	86	3.34	85	FSC1
150	150	9070T150D4	—	5.5	3.20	81	—	—	3.75	95	3.59	91	FSC1
200	200	9070T200D4	—	5.5	3.20	81	—	—	3.75	95	3.59	91	FSC1
250	160	9070T250D4	—	7.1	3.20	81	—	—	3.75	95	5.30	135	FSC2
300	200	9070T300D4	—	8.5	3.84	98	—	—	4.50	114	4.74	120	FSC2
350	250	9070T350D4	—	10.5	3.84	98	—	—	4.50	114	5.11	130	FSC2
500	300	9070T500D4	—	11.9	3.84	98	—	—	4.50	114	5.49	139	FSC2
750	500	9070T750D4	—	11.0	4.51	115	—	—	5.25	133	5.61	143	FSC2
1000	630	9070T1000D4	—	20.6	4.51	115	—	—	5.25	133	6.30	160	FSC2
1500	1000	9070T1500D4	—	34.0	6.17	157	—	—	7.06	179	5.92	150	FSC2
2000	1500	9070T2000D4	—	47.0	6.17	157	—	—	7.06	179	7.17	182	FSC2
3000	2000	9070T3000D4	—	60.0	8.75	222	—	—	9.00	229	7.24	184	FSC2
5000	3000	9070T5000D4	—	89.0	8.75	222	—	—	9.00	229	9.15	232	FSC2

[1] TF units are design for line to line voltages on the primary, 277 Vac is a line to neutral voltage.

**Table 14.28: 240 x 480 V Primary, 120/240 V Secondary; 230 x 460 V Primary, 115/230 V Secondary; 220 x 440 V Primary, 110/220 V Secondary**

VA		Type T	Type TF[2]	Weight	Height				Width		Depth		Accessory Finger-safe Covers
UL/CSA/NOM	CE	Catalog No.			Type T		Type TF		in.	mm	in.	mm	
					in.	mm	in.	mm					
25	25	9070T25D31	9070TF25D31	2.5	2.58	66	4.00	102	3.00	76	3.09	79	FSC1
50	50	9070T50D31	9070TF50D31	2.5	2.58	66	4.00	102	3.00	76	3.09	79	FSC1
75	75	9070T75D31	9070TF75D31	3.8	2.89	73	4.18	106	3.38	86	3.34	85	FSC1
100	100	9070T100D31	9070TF100D31	3.8	2.89	73	4.18	106	3.38	86	3.34	85	FSC1
150	150	9070T150D31	9070TF150D31	5.5	3.20	81	4.50	114	3.75	95	3.59	91	FSC1
200	200	9070T200D31	9070TF200D31	5.5	3.20	81	4.50	114	3.75	95	3.59	91	FSC1
250	160	9070T250D31	9070TF250D31	7.1	3.20	81	4.50	114	3.75	95	5.30	135	FSC2
300	200	9070T300D31	9070TF300D31	8.5	3.84	98	5.13	130	4.50	114	4.74	120	FSC2
350	250	9070T350D31	9070TF350D31	10.5	3.84	98	5.13	130	4.50	114	5.11	130	FSC2
500	300	9070T500D31	9070TF500D31	11.9	3.84	98	5.13	130	4.50	114	5.49	139	FSC2
750	500	9070T750D31	9070TF750D31	11.0	4.51	115	5.80	147	5.25	133	5.61	143	FSC2
1000	630	9070T1000D31	9070TF1000D31	20.6	4.51	115	5.80	147	5.25	133	6.30	160	FSC2
1500	1000	9070T1500D31	9070TF1500D31	34.0	6.17	157	7.46	190	7.06	179	5.92	150	FSC2
2000	1500	9070T2000D31	9070TF2000D31	47.0	6.17	157	7.46	190	7.06	179	7.17	182	FSC2
3000	2000	9070T3000D31	—	60.0	8.75	222	—	—	9.00	229	7.24	184	FSC2
5000	3000	9070T5000D31	—	89.0	8.75	222	—	—	9.00	229	9.15	232	FSC2

**Table 14.29: 600 Vac Primary, 120/240 Vac Secondary**

VA		Type T	Type TF[2]	Weight	Height				Width		Depth		Accessory Finger-safe Covers
UL/CSA/NOM	CE	Catalog No.			Type T		Type TF		in.	mm	in.	mm	
					in.	mm	in.	mm					
25	25	9070T25D37	9070TF25D37	2.5	2.58	66	4.00	102	3.00	76	3.09	79	FSC1
50	50	9070T50D37	9070TF50D37	2.5	2.58	66	4.00	102	3.00	76	3.09	79	FSC1
75	75	9070T75D37	9070TF75D37	3.8	2.89	73	4.18	106	3.38	86	3.34	85	FSC1
100	100	9070T100D37	9070TF100D37	3.8	2.89	73	4.18	106	3.38	86	3.34	85	FSC1
150	150	9070T150D37	9070TF150D37	5.5	3.20	81	4.50	114	3.75	95	3.59	91	FSC1
200	200	9070T200D37	9070TF200D37	5.5	3.20	81	4.50	114	3.75	95	3.59	91	FSC1
250	160	9070T250D37	9070TF250D37	7.1	3.20	81	4.50	114	3.75	95	5.30	135	FSC2
300	200	9070T300D37	9070TF300D37	8.5	3.84	98	5.13	130	4.50	114	4.74	120	FSC2
350	250	9070T350D37	9070TF350D37	10.5	3.84	98	5.13	130	4.50	114	5.11	130	FSC2
500	300	9070T500D37	9070TF500D37	11.9	3.84	98	5.13	130	4.50	114	5.49	139	FSC2
750	500	9070T750D37	9070TF750D37	11.0	4.51	115	5.80	147	5.25	133	5.61	143	FSC2
1000	630	9070T1000D37	9070TF1000D37	20.6	4.51	115	5.80	147	5.25	133	6.30	160	FSC2
1500	1000	9070T1500D37	9070TF1500D37	34.0	6.17	157	7.46	190	7.06	179	5.92	150	FSC2
2000	1500	9070T2000D37	9070TF2000D37	47.0	6.17	157	7.46	190	7.06	179	7.17	182	FSC2
3000	2000	9070T3000D37	—	60.0	8.75	222	—	—	9.00	229	7.24	184	FSC2
5000	3000	9070T5000D37	—	89.0	8.75	222	—	—	9.00	229	9.15	232	FSC2

**Table 14.30: 380/400/415 Vac Primary, 115/230 Vac Secondary**

VA		Type T	Type TF	Weight	Height				Width		Depth		Accessory Finger-safe Covers
UL/CSA/NOM	CE	Catalog No.			Type T		Type TF		in.	mm	in.	mm	
					in.	mm	in.	mm					
25	25	9070T25D33	9070TF25D33	2.5	2.58	66	4.00	102	3.00	76	3.09	79	FSC1
50	50	9070T50D33	9070TF50D33	2.5	2.58	66	4.00	102	3.00	76	3.09	79	FSC1
75	75	9070T75D33	9070TF75D33	3.8	2.89	73	4.18	106	3.38	86	3.34	85	FSC1
100	100	9070T100D33	9070TF100D33	3.8	2.89	73	4.18	106	3.38	86	3.34	85	FSC1
150	150	9070T150D33	9070TF150D33	5.5	3.20	81	4.50	114	3.75	95	3.59	91	FSC1
200	200	9070T200D33	9070TF200D33	5.5	3.20	81	4.50	114	3.75	95	3.59	91	FSC1
250	160	9070T250D33	9070TF250D33	7.1	3.20	81	4.50	114	3.75	95	5.30	135	FSC2
300	200	9070T300D33	9070TF300D33	8.5	3.84	98	5.13	130	4.50	114	4.74	120	FSC2
350	250	9070T350D33	9070TF350D33	10.5	3.84	98	5.13	130	4.50	114	5.11	130	FSC2
500	300	9070T500D33	9070TF500D33	11.9	3.84	98	5.13	130	4.50	114	5.49	139	FSC2
750	500	9070T750D33	9070TF750D33	11.0	4.51	115	5.80	147	5.25	133	5.61	143	FSC2
1000	630	9070T1000D33	9070TF1000D33	20.6	4.51	115	5.80	147	5.25	133	6.30	160	FSC2
1500	1000	9070T1500D33	9070TF1500D33	34.0	6.17	157	7.46	190	7.06	179	5.92	150	FSC2
2000	1500	9070T2000D33	9070TF2000D33	47.0	6.17	157	7.46	190	7.06	179	7.17	182	FSC2
3000	2000	9070T3000D33	—	60.0	8.75	222	—	—	9.00	229	7.24	184	FSC2
5000	3000	9070T5000D33	—	89.0	8.75	222	—	—	9.00	229	9.15	232	FSC2

**Field Installed Fuse Blocks—Design for Line to Line Primary Voltages and Line to Neutral Secondary Voltages**

**Table 14.31: Accessories**

Catalog No.	Voltage Codes			Description	Order Qty
<b>Fuse Kit</b>					
—	D1, D2, D3, D4, D5, D13, D14, D15, D23, D31, D33, D37	D20, D32	D19, D50	—	—
9070FB3A	T25–T200	T25–T150	—	3-pole fuse block for primary and secondary fusing, accommodates 1-1/2 x 13/32 in. midget fuse (2 rejection and 1 non-rejection)	1
9070FB3B	T250–T3000	T250–T2000	T25–T2000		1
9070FB2A	T25–T200	T25–T150	—	2-pole fuse block for primary fusing, accommodates 1-1/2 x 13/32 in. midget fuse (2 rejection)	1
9070FB2B	T250–T3000	T250–T2000	T25–T2000		1
9070SF25A	T25–T200	T25–T150	—	Secondary fuse clips accommodates 1-1/4 x 1/4 in. fuse	10
9070SF25B	T250–T3000	T250–T2000	T25–T2000		10
9070SF41A	T25–T200	T25–T150	—	Secondary fuse clips accommodates 1-1/2 x 13/32 in. fuse	10
9070SF41B	T250–T3000	T250–T2000	T25–T2000		10
9070FB1A	T25–T200	T25–T150	—	Secondary fuse block accommodates 1-1/4 x 1/4 in. fuse	1
9070FB1B	T250–T3000	T250–T2000	T25–T2000		1
9070FP1	—	—	—	Fuse puller for TF and FB kits	10

[2] TF designed for line to line primary and line to neutral secondary. If secondary connected in series, fuse block should be disconnected.



**Table 14.32: 208/230/460 Vac Primary, 115 Vac Secondary**

VA		Type T	Type TF	Weight	Height				Width		Depth		Accessory Finger-safe Covers
UL/CSA/NOM	CE	Catalog No.			Type T		Type TF		in.	mm	in.	mm	
		in.	mm		in.	mm							
50	50	9070T50D20	9070TF50D20	4.0	2.89	73	4.18	106	3.38	86	3.34	85	FSC1
75	75	9070T75D20	9070TF75D20	5.5	2.89	73	4.18	106	3.38	86	3.34	85	FSC1
100	100	9070T100D20	9070TF100D20	5.5	3.20	81	4.50	114	3.75	95	3.59	91	FSC1
150	150	9070T150D20	9070TF150D20	5.5	3.20	81	4.50	114	3.75	95	3.59	91	FSC1
200	200	9070T200D20	9070TF200D20	8.5	3.20	81	4.50	114	3.75	95	5.30	135	FSC2
250	160	9070T250D20	9070TF250D20	10.5	3.84	98	5.13	130	4.50	114	4.74	120	FSC2
300	200	9070T300D20	9070TF300D20	10.5	3.84	98	5.13	130	4.50	114	5.11	130	FSC2
350	250	9070T350D20	9070TF350D20	11.9	3.84	98	5.13	130	4.50	114	5.49	139	FSC2
500	300	9070T500D20	9070TF500D20	11.0	4.51	115	5.80	147	5.25	133	5.61	143	FSC2
750	500	9070T750D20	9070TF750D20	20.6	4.51	115	5.80	147	5.25	133	6.30	160	FSC2
1000	630	9070T1000D20	9070TF1000D20	34.0	6.17	157	7.46	190	7.06	179	5.92	150	FSC2
1500	1000	9070T1500D20	9070TF1500D20	47.0	6.17	157	7.46	190	7.06	179	7.17	182	FSC2
2000	1500	9070T2000D20	9070TF2000D20	60.0	8.75	222	—	—	9.00	229	7.24	184	FSC2
3000	2000	9070T3000D20	—	89.0	8.75	222	—	—	9.00	229	9.15	232	FSC2

**Table 14.33: 240/480/600 V Primary, 120 V Secondary; 230/460/575 V Primary, 115 V Secondary; 220/440/550 V Primary to 110 V Secondary**

VA		Type T	Type TF	Weight	Height				Width		Depth		Accessory Finger-safe Covers
UL/CSA/NOM	CE	Catalog No.			Type T		Type TF		in.	mm	in.	mm	
		in.	mm		in.	mm							
50	50	9070T50D32	9070TF50D32	3.8	2.89	73	4.18	106	3.38	86	3.34	85	FSC1
75	75	9070T75D32	9070TF75D32	3.8	2.89	73	4.18	106	3.38	86	3.34	85	FSC1
100	100	9070T100D32	9070TF100D32	5.5	3.20	81	4.50	114	3.75	95	3.59	91	FSC1
150	150	9070T150D32	9070TF150D32	5.5	3.20	81	4.50	114	3.75	95	3.59	91	FSC1
200	200	9070T200D32	9070TF200D32	7.1	3.20	81	4.50	114	3.75	95	5.30	135	FSC2
250	160	9070T250D32	9070TF250D32	8.5	3.84	98	5.13	130	4.50	114	4.74	120	FSC2
300	200	9070T300D32	9070TF300D32	10.5	3.84	98	5.13	130	4.50	114	5.11	130	FSC2
350	250	9070T350D32	9070TF350D32	11.9	3.84	98	5.13	130	4.50	114	5.49	139	FSC2
500	300	9070T500D32	9070TF500D32	11.0	4.51	115	5.80	147	5.25	133	5.61	143	FSC2
750	500	9070T750D32	9070TF750D32	20.6	4.51	115	5.80	147	5.25	133	6.30	160	FSC2
1000	630	9070T1000D32	9070TF1000D32	34.0	6.17	157	7.46	190	7.06	179	5.92	150	FSC2
1500	1000	9070T1500D32	9070TF1500D32	47.0	6.17	157	7.46	190	7.06	179	7.17	182	FSC2
2000	1500	9070T2000D32	9070TF2000D32	60.0	8.75	222	—	—	9.00	229	7.24	184	FSC2
3000	2000	9070T3000D32	—	89.0	8.75	222	—	—	9.00	229	9.15	232	FSC2

**Table 14.34: 240/416/480/600 Vac Primary, 99/120/130 Vac Secondary; 230/400/460/575 Vac Primary, 95/115/125 Vac Secondary; 220/380/440/550 Vac Primary, 90/110/120 Vac Secondary; 208/360/416/520 Vac Primary, 85/104/115 Vac Secondary**

VA		Type T	Type TF	Weight	Height				Width		Depth		Accessory Finger-safe Covers
UL/CSA/NOM	CE	Catalog No.			Type T		Type TF		in.	mm	in.	mm	
		in.	mm		in.	mm							
50	50	9070T50D50	9070TF50D50	4.0	2.89	73	4.19	106	3.38	86	4.43	113	FSC23
75	75	9070T75D50	9070TF75D50	7.2	3.20	81	4.50	114	3.75	95	4.70	119	FSC23
100	100	9070T100D50	9070TF100D50	7.1	3.20	81	4.50	114	3.75	95	4.70	119	FSC23
150	150	9070T150D50	9070TF150D50	8.5	3.84	98	5.14	131	4.50	114	4.74	120	FSC23
200	200	9070T200D50	9070TF200D50	10.5	3.84	98	5.14	131	4.50	114	5.11	130	FSC23
250	160	9070T250D50	9070TF250D50	10.5	3.84	98	5.14	131	4.50	114	5.11	130	FSC23
300	200	9070T300D50	9070TF300D50	11.9	3.84	98	5.14	131	4.50	114	5.49	139	FSC23
350	250	9070T350D50	9070TF350D50	11.0	4.51	115	5.81	148	5.25	133	5.61	143	FSC23
500	300	9070T500D50	9070TF500D50	11.0	4.51	115	5.81	148	5.25	133	5.61	143	FSC23
750	500	9070T750D50	9070TF750D50	20.6	4.51	115	5.81	148	5.25	133	6.3	160	FSC23
1000	630	9070T1000D50	9070TF1000D50	34.0	6.17	157	7.47	190	7.06	179	5.92	150	FSC23
1500	1000	9070T1500D50	9070TF1500D50	47.0	6.17	157	7.47	190	7.06	179	7.17	182	FSC23
2000	1500	9070T2000D50	9070TF2000D50	60.0	7.63	194	8.93	227	9.00	229	6.38	162	FSC23

**Table 14.35: 240 x 480 Vac Primary, 120/24 Vac Secondary (24 Vac limited to 20% of nameplate VA)**

VA		Type T	Type TF	Weight	Height				Width		Depth		Accessory Finger-safe Covers
UL/CSA/NOM	CE	Catalog No.			Type T		Type TF		in.	mm	in.	mm	
		in.	mm		in.	mm							
50	50	9070T50D15	—	2.5	2.58	66	—	—	3.00	76	3.09	79	FSC1
75	75	9070T75D15	—	3.8	2.89	73	—	—	3.38	86	3.34	85	FSC1
100	100	9070T100D15	—	3.8	2.89	73	—	—	3.38	86	3.34	85	FSC1
150	150	9070T150D15	—	5.5	3.20	81	—	—	3.75	95	3.59	91	FSC1
200	200	9070T200D15	—	5.5	3.20	81	—	—	3.75	95	3.59	91	FSC1
250	160	9070T250D15	—	7.1	3.20	81	—	—	3.75	95	5.30	135	FSC2
300	200	9070T300D15	—	8.5	3.84	98	—	—	4.50	114	4.74	120	FSC2
350	250	9070T350D15	—	10.5	3.84	98	—	—	4.50	114	5.11	130	FSC2
500	300	9070T500D15	—	11.9	3.84	98	—	—	4.50	114	5.49	139	FSC2
750	500	9070T750D15	—	11.0	4.51	115	—	—	5.25	133	5.61	143	FSC2
1000	630	9070T1000D15	—	20.6	4.51	115	—	—	5.25	133	6.30	160	FSC2
1500	1000	9070T1500D15	—	34.0	6.17	157	—	—	7.06	179	5.92	150	FSC2
2000	1500	9070T2000D15	—	47.0	6.17	157	—	—	7.06	179	7.17	182	FSC2
3000	2000	9070T3000D15	—	60.0	8.75	222	—	—	9.00	229	7.24	184	FSC2
5000	3000	9070T5000D15	—	89.0	8.75	222	—	—	9.00	229	9.15	232	FSC2

**Table 14.36: Accessories**

Catalog No.	Voltage Codes		Description	Order Qty
—	D1, D2, D3, D4, D5, D13, D14, D15, D23, D31, D33, D37	D20, D32	D19, D50	—
9070FSC1	T25–T200	T25–T150	—	2 covers per kit
9070FSC2	T250–T5000	T250–T5000	—	2 covers per kit
9070FSC23	—	—	T25–T5000	2 covers per kit

Table 14.37: 240 x 480 Vac Primary, 24 Vac Secondary

VA		Type T	Weight	Height Type T		Width		Depth		Accessory Fingersafe Covers
UL/CSA/NOM	CE	Catalog No.		in.	mm	in.	mm	in.	mm	
50	50	9070T50D2	2.5	2.58	66	3.00	76	3.09	79	FSC1
75	75	9070T75D2	3.8	2.89	73	3.38	86	3.34	85	FSC1
100	100	9070T100D2	3.8	2.89	73	3.38	86	3.34	85	FSC1
150	150	9070T150D2	5.5	3.20	81	3.75	95	3.59	91	FSC1
200	200	9070T200D2	5.5	3.20	81	3.75	95	3.59	91	FSC1
250	160	9070T250D2	7.1	3.20	81	3.75	95	5.30	135	FSC2
300	200	9070T300D2	8.5	3.84	98	4.50	114	4.74	120	FSC2
350	250	9070T350D2	10.5	3.84	98	4.50	114	5.11	130	FSC2
500	300	9070T500D2	11.9	3.84	98	4.50	114	5.49	139	FSC2
750	500	9070T750D2	11.0	4.51	115	5.25	133	5.61	143	FSC2
1000	630	9070T1000D2	20.6	4.51	115	5.25	133	6.30	160	FSC2

Table 14.38: 208 Vac Primary, 24 Vac Secondary

VA		Type T	Weight	Height Type T		Width		Depth		Accessory Fingersafe Covers
UL/CSA/NOM	CE	Catalog No.		in.	mm	in.	mm	in.	mm	
50	50	9070T50D14	2.5	2.58	66	3.00	76	3.09	79	FSC1
75	75	9070T75D14	3.8	2.89	73	3.38	86	3.34	85	FSC1
100	100	9070T100D14	3.8	2.89	73	3.38	86	3.34	85	FSC1
150	150	9070T150D14	5.5	3.20	81	3.75	95	3.59	91	FSC1
200	200	9070T200D14	5.5	3.20	81	3.75	95	3.59	91	FSC1
250	160	9070T250D14	7.1	3.20	81	3.75	95	5.30	135	FSC2
300	200	9070T300D14	8.5	3.84	98	4.50	114	4.74	120	FSC2
350	250	9070T350D14	10.5	3.84	98	4.50	114	5.11	130	FSC2
500	300	9070T500D14	11.9	3.84	98	4.50	114	5.49	139	FSC2
750	500	9070T750D14	11.0	4.51	115	5.25	133	5.61	143	FSC2
1000	630	9070T1000D14	20.6	4.51	115	5.25	133	6.30	160	FSC2

Table 14.39: 120 x 240 Vac Primary, 24 Vac Secondary

VA		Type T	Weight	Height Type T		Width		Depth		Accessory Fingersafe Covers
UL/CSA/NOM	CE	Catalog No.		in.	mm	in.	mm	in.	mm	
50	50	9070T50D23	2.5	2.58	66	3.00	76	3.09	79	FSC1
75	75	9070T75D23	3.8	2.89	73	3.38	86	3.34	85	FSC1
100	100	9070T100D23	3.8	2.89	73	3.38	86	3.34	85	FSC1
150	150	9070T150D23	5.5	3.20	81	3.75	95	3.59	91	FSC1
200	200	9070T200D23	5.5	3.20	81	3.75	95	3.59	91	FSC1
250	160	9070T250D23	7.1	3.20	81	3.75	95	5.30	135	FSC2
300	200	9070T300D23	8.5	3.84	98	4.50	114	4.74	120	FSC2
350	250	9070T350D23	10.5	3.84	98	4.50	114	5.11	130	FSC2
500	300	9070T500D23	11.9	3.84	98	4.50	114	5.49	139	FSC2
750	500	9070T750D23	11.0	4.51	115	5.25	133	5.61	143	FSC2
1000	630	9070T1000D23	20.6	4.51	115	5.25	133	6.30	160	FSC2

Table 14.40: 120 Vac Primary, 12/24 Vac Secondary

VA		Type T	Weight	Height Type T		Width		Depth		Accessory Fingersafe Covers
UL/CSA/NOM	CE	Catalog No.		in.	mm	in.	mm	in.	mm	
50	50	9070T50D13	2.5	2.58	66	3.00	76	3.09	79	FSC1
75	75	9070T75D13	3.8	2.89	73	3.38	86	3.34	85	FSC1
100	100	9070T100D13	3.8	2.89	73	3.38	86	3.34	85	FSC1
150	150	9070T150D13	5.5	3.20	81	3.75	95	3.59	91	FSC1
200	200	9070T200D13	5.5	3.20	81	3.75	95	3.59	91	FSC1
250	160	9070T250D13	7.1	3.20	81	3.75	95	5.30	135	FSC2
300	200	9070T300D13	8.5	3.84	98	4.50	114	4.74	120	FSC2
350	250	9070T350D13	10.5	3.84	98	4.50	114	5.11	130	FSC2
500	300	9070T500D13	11.9	3.84	98	4.50	114	5.49	139	FSC2
750	500	9070T750D13	11.0	4.51	115	5.25	133	5.61	143	FSC2
1000	630	9070T1000D13	20.6	4.51	115	5.25	133	6.30	160	FSC2

Table 14.41: 208/240/277/380/480 Vac Primary, 24 Vac Secondary

VA		Type T	Weight	Height Type T		Width		Depth		Accessory Fingersafe Covers
UL/CSA/NOM	CE	Catalog No.		in.	mm	in.	mm	in.	mm	
50	50	9070T50D19	4.0	2.89	106	3.38	86	3.34	85	FSC23
75	75	9070T75D19	5.5	2.89	106	3.38	86	3.34	85	FSC23
100	100	9070T100D19	5.5	3.20	114	3.75	95	3.59	91	FSC23
150	150	9070T150D19	5.5	3.20	114	3.75	95	3.59	91	FSC23
200	200	9070T200D19	8.5	3.20	114	3.75	95	5.30	135	FSC23
250	160	9070T250D19	10.5	3.84	130	4.50	114	4.74	120	FSC23
300	200	9070T300D19	10.5	3.84	130	4.50	114	5.11	130	FSC23
350	250	9070T350D19	11.9	3.84	130	4.50	114	5.49	139	FSC23
500	300	9070T500D19	11.0	4.51	147	5.25	133	5.61	143	FSC23
750	500	9070T750D19	20.6	4.51	147	5.25	133	6.30	160	FSC23
1000	630	9070T1000D19	34.0	6.17	190	7.06	179	5.92	150	FSC23

**Transformer Disconnects for NEMA Type 1 and Type 12 Enclosures**



Transformer disconnects are available in NEMA Type 1 Standard, NEMA Type 12 Standard, and NEMA Type 1 Mini.

Square D™ brand transformer disconnects mount inside or outside a control system enclosure. The transformer disconnect being connected directly to the 480 Vac system controls power for auxiliary, single-phase loads when the main three-phase disconnect is either ON or OFF. The transformer disconnect is normally wired to the line side of the control panel's main disconnect.

This convenient source of 120 Vac power can be used for auxiliary or isolated loads, such as panel lighting, portable power tools, and programmable controller equipment.

Units consist of copper-wound transformers, a disconnect switch, and primary and secondary fuse blocks. All blocks are installed in NEMA Type 1 or Type 12 enclosures.

Transformer disconnects are UL Listed. Use Square D™ brand Type TF industrial control transformers and Square D™ brand disconnect switches.

Multiple enclosure options and accessories are available. See catalog 9070CT0301 or contact your local Schneider Electric representative or distributor.

- Standard NEMA Type 1
- Mini NEMA Type 1
- Compact NEMA Type 1
- NEMA Type 12

**Table 14.42: Transformer Disconnects**

VA	Catalog No.		Enclosure	H		W		D		Weight (lbs)
	Without Outlet	With Outlet		in.	mm	in.	mm	in.	mm	
<b>NEMA Type 1 Enclosure, 240 x 480 Vac Primary, 120 Vac Secondary (Compact Design)</b>										
100	9070MN100G0D1	9070MN100G0D1G13	G0	7.00	178	11.30	287	7.81	198	16
250	9070MN250G0D1	9070MN250G0D1G13	G0	7.00	178	11.30	287	7.81	198	21
500	9070MN500G0D1	9070MN500G0D1G13	G0	7.00	178	11.30	287	7.81	198	24
750	9070SK750G3D1	9070SK750G3D1G13	G3	13.40	340	14.80	376	10.21	259	47
1000	9070SK1000G3D1	9070SK1000G3D1G13	G3	13.40	340	14.80	376	10.21	259	51
1500	9070SK1500G3D1	9070SK1500G3D1G13	G3	13.40	340	14.80	376	10.21	259	65
2000	9070SK2000G3D1	9070SK2000G3D1G13	G3	13.40	340	14.80	376	10.21	259	71
3000	9070SK3000G3D1	9070SK3000G3D1G13	G3	13.40	340	14.80	376	10.21	259	85
<b>NEMA Type 1 Enclosure, 240 x 480 Vac Primary, 120 Vac Secondary</b>										
250	9070SK250G1D1	9070SK250G1D1G13	G1	9.40	239	11.80	300	8.96	228	26
500	9070SK500G1D1	9070SK500G1D1G13	G1	9.40	239	11.80	300	8.96	228	28
750	9070SK750G1D1	9070SK750G1D1G13	G1	9.40	239	11.80	300	8.96	228	33
1000	9070SK1000G1D1	9070SK1000G1D1G13	G1	9.40	239	11.80	300	8.96	228	37
1500	9070SK1500G2D1	9070SK1500G2D1G13	G2	13.40	340	14.80	376	12.21	310	67
2000	9070SK2000G2D1	9070SK2000G2D1G13	G2	13.40	340	14.80	376	12.21	310	73
3000	9070SK3000G2D1	9070SK3000G2D1G13	G2	13.40	340	14.80	376	12.21	310	87
<b>NEMA Type 1 Enclosure, 480 Vac Primary, 120 Vac Secondary</b>										
5000	9070SK5000G4D9	9070SK5000G4D9G13	G4	16.90	429	18.20	462	14.50	368	125
<b>NEMA Type 12 Enclosure, 240 x 480 Vac Primary, 120 Vac Secondary</b>										
250	9070SK250A2D1	9070SK250A2D1G13	A2	16.50	419	14.50	368	13.50	343	46
500	9070SK500A2D1	9070SK500A2D1G13	A2	16.50	419	14.50	368	13.50	343	49
750	9070SK750A2D1	9070SK750A2D1G13	A2	16.50	419	14.50	368	13.50	343	53
1000	9070SK1000A2D1	9070SK1000A2D1G13	A2	16.50	419	14.50	368	13.50	343	58
1500	9070SK1500A2D1	9070SK1500A2D1G13	A2	16.50	419	14.50	368	13.50	343	79
2000	9070SK2000A2D1	9070SK2000A2D1G13	A2	16.50	419	14.50	368	13.50	343	85
3000	9070SK3000A2D1	9070SK3000A2D1G13	A2	16.50	419	14.50	368	13.50	343	99
<b>NEMA Type 12 Enclosure, 240 x 480 Vac Primary, 120 Vac Secondary, Flange Switch</b>										
250	9070SK250A3D1	9070SK250A3D1G13	A3	15.50	394	17.00	432	10.00	254	48
500	9070SK500A3D1	9070SK500A3D1G13	A3	15.50	394	17.00	432	10.00	254	53
750	9070SK750A3D1	9070SK750A3D1G13	A3	15.50	394	17.00	432	10.00	254	57
1000	9070SK1000A3D1	9070SK1000A3D1G13	A3	15.50	394	17.00	432	10.00	254	61
1500	9070SK1500A3D1	9070SK1500A3D1G13	A3	15.50	394	17.00	432	10.00	254	75
2000	9070SK2000A3D1	9070SK2000A3D1G13	A3	15.50	394	17.00	432	10.00	254	86

## Voltage Transformers

Schneider Electric offers three models of voltage transformers, each suited for a particular application:

- Model 450R
  - Applications requiring accurate voltage measurement within the 0.3% accuracy class
  - Switchboards with 1% instrumentation
- Model 460R
  - Applications with less critical accuracy and low burden requirements
  - Transducers and other panelboard monitoring
- Model 470R
  - Extremely accurate voltage measurement
  - Low burden applications, such as PLC modules and similar, high-impedance electronic devices

**Table 14.43: Voltage Transformers**

Application	Model Number	Accuracy/Burden and Thermal Rating	Primary Voltages (120 Vac Secondary)
Large burden	450R	0.3 W, X, M, Y; 500 VA Thermal	120–600 Vac
Small burden	460R	0.6 W, 1.2X; 150 VA Thermal	120–600 Vac
Small burden	470R	0.3W, 1.2X; 150 VA Thermal	120–600 Vac

## Current Transformers

Current transformers are low cost, compact units that offer good electrical performance in a general purpose transformer.

- They are very easy to mount on the conductors.
- All current transformers feature permanent polarity marks molded into the case.

The following types of current transformers are available:

- General purpose
- Toroidal (single ratio)
- Rectangle window (single ratio)
- Split core
- Bushing (single ratio) (multi-ratio)

For part numbers, see Section 6 of the Supplemental Digest or see the Schneider Electric Product Configurator.

Contact your local Schneider Electric representative for other available features.

**Table 14.44: Current Transformers**

Window Diameter		Model Number	Usual Application			Primary Range in Amperes [1]	UL Recognized Product
in.	mm		Metering	Metering or Control Relaying	High Output Relaying		
1.3	28	2NR	X	—	—	50–300	Yes
1.56	40	5NR	X	—	—	100–600	
		54R	X	—	—	100–600	
1.94	49	64R	X	—	—	100–750	
		66R	—	X	—	100–750	
2.25	57	7RL	—	—	—	50–1500	
		7RT	—	—	—	50–1500 150–1500 [2]	
2.34	59	74R	X	—	—	200–1500	
		76R	—	X	—	200–1500	
2.50	63	74RFT	—	—	—	—	
		180R	—	X	—	100–1500	
3.50	89	200R	—	X	—	100–600	
		201R	—	X	—	100–800	
4.00	102	100R	—	X	—	200–2000	
		110R	—	X	—	200–2000	
4.25	108	170R	—	X	—	200–2000	
		312R	—	—	X	600–4000	
4.50	114	202R	—	X	X	100–1000	
		203R	—	X	—	100–3000	
5.25	133	120R	—	X	—	200–3000	
5.75	146	210R	—	X	X	200–3000	
6.25	159	151R	—	—	X	600–4000	
		152R	—	X	X	50–4000	
8.13	206	140R	—	X	X	50–6000	
		260R	X	—	—	100–4000	
2.12 x 4.25	54 x 108	273	X	—	—	200–4000	
3.50 x 6.25	89 x 159	270R	X	—	—	400–5000	
3.56 x 8.81	90 x 224	560R	X	—	—	400–5000	
7.45 x 3.75	189 x 95						

[1] With a 5 A secondary.

[2] With a 1 A secondary.

*New!*

**Medium Voltage Distribution Transformers**

New! Revised Medium Voltage Transformer Energy Efficiency Information For 2016! In 2010 Schneider Electric released new efficiencies for MV transformers based on The Department of Energy (DOE) 10 CFR Part 431 Energy Conservation program for Commercial Equipment. We are now launching even more efficient transformers to further reduce energy consumption from MV transformers. Starting January 1, 2016 certain medium voltage distribution transformers with ratings of 2,500 kVA and below, 34.5 kV primary and below and 600 Vac class secondary voltages must meet revised minimum efficiency requirements. Liquid Filled Padmounts, Liquid Filled Substations, Dry Type VPI and Power Cast products shipped after January 1, 2016 will all be included. The minimum efficiency tables are listed below. Please contact your nearest Schneider Electric Sales Office for more information. Page 14-19 and 14-20 includes our updated offer.



Power Cast II™



Liquid Filled Pad Mounted



Liquid Filled Substation



Power Dry II™

**Table 14.45: New! Standard Efficiency Levels for Liquid Immersed Distribution Transformers**

Single Phase		Three Phase	
kVA	Efficiency %	kVA	Efficiency %
10	98.7	—	—
15	98.82	—	—
25	98.95	—	—
37.5	99.05	45	98.92
50	99.11	75	99.03
75	99.19	112.5	99.11
100	99.25	150	99.16
167	99.33	225	99.23
250	99.39	300	99.27
333	99.43	500	99.35
500	99.49	750	99.4
667	99.52	1000	99.43
833	99.55	1500	99.48
—	—	2000	99.51
—	—	2500	99.53

All Efficiency values are at 50% of nameplate-rated load, determined according to the DOE Test Procedure 10 CFR 431, Subpart K, Appendix A.

**Table 14.46: New! Standard Levels for Medium Voltage Dry Type Distribution Transformers**

kVA	Single Phase			kVA	Three Phase		
	20-45kV BIL Efficiency %	46-95 kV BIL Efficiency %	> 96 kV BIL Efficiency %		20-45kV BIL Efficiency %	46-95 kV BIL Efficiency %	> 96 kV BIL Efficiency %
15	98.1	97.86	—	45	98.1	97.86	—
25	98.33	98.12	—	75	98.33	98.13	—
37.5	98.49	98.3	—	112.5	98.52	98.36	—
50	98.6	98.42	—	150	98.65	98.51	—
75	98.73	98.57	98.53	225	98.82	98.69	98.57
100	98.82	98.67	98.63	300	98.93	98.81	98.69
167	98.96	98.83	98.8	500	99.09	98.99	98.89
250	99.07	98.95	98.91	750	99.21	99.12	99.02
333	99.14	99.03	98.99	1000	99.28	99.2	99.11
500	99.22	99.12	99.09	1500	99.37	99.3	99.21
667	99.27	99.18	99.15	2000	99.43	99.36	99.28
833	99.31	99.23	99.2	2500	99.47	99.41	99.33

**NOTE:** BIL means Basic Impulse Level.

**NOTE:** All Efficiency values are at 50% of nameplate-rated load, determined according to the DOE Test Procedure 10 CFR 431, Subpart K, Appendix A.

*New!*

**Dry Type Medium Voltage Transformers**

All transformers are built with 220 °C insulation and 150 °C temperature rise. For 115 °C rise add F to catalog number. For 80 °C rise add B to catalog number. For copper windings, add CU to the end of the part number. Check with factory to verify dimensional changes and weights for copper windings or alternate temperature rises.

Standard high voltage taps: 4-2.5%, 2AN and 2BN. For 4-2.5% FCBN, add BN to catalog number.

*New!*

**1,201–15,000 Vac Three-Phase Indoor Transformers**

See Table 14.51 *New! Enclosure Dimensions*, page 14-24. Enclosures are for indoor use only. If outdoor enclosure is required, this is outside the scope of the digest, contact your local Schneider Electric Representative.

Lugs: Furnished by customer.

**Table 14.47: New! EX Three Phase Medium Voltage Transformers**

kVA	Catalog No.	Minimum Efficiency @ 50% load	Weight (lbs)	Enclosure
<b>2.4 kV and 5 kV Voltage Class 60 Hz 150°C Rise</b>				
112.5	EX112T(J)H	98.52	1200	50D
150	EX150T(J)H	98.65	1400	51D
225	EX225T(J)H	98.82	1900	51D
300	EX300T(J)H	98.93	2100	52D
500	EX500T(J)H	99.09	3000	52D
750	EX750T(J)H	99.21	5000	55F
1000	EX1000T(J)H	99.28	6000	56F
1500	EX1500T(J)H	99.37	8100	56F
2000	EX2000T(J)H	99.43	11000	57F
2500	EX2500T(J)H	99.47	13100	58F
<b>15 kV Voltage Class 60 Hz 150°C Rise</b>				
112.5	EX112T(J)H	98.36	2000	52D
150	EX150T(J)H	98.51	2200	52D
225	EX225T(J)H	98.69	2800	53D
300	EX300T(J)H	98.81	3300	53D
500	EX500T(J)H	98.99	5000	54F
750	EX750T(J)H	99.12	6000	55F
1000	EX1000T(J)H	99.2	7400	56F
1500	EX1500T(J)H	99.3	9000	56F
2000	EX2000T(J)H	99.36	11000	57F
2500	EX2500T(J)H	99.41	13000	58F
3000	EX3000T(J)H	—	18000	58F

**Table 14.48: New! Three Phase Voltage Codes**

kV Class	Code	Primary	Secondary
2.4 30 kV BIL	13	2400 Delta	208Y/120
	14	2400 Delta	480Y/277
	15	2400 Delta	240 Delta
	16	2400 Delta	480 Delta
	17	2400 Delta	600 Delta
5 30 kV BIL	18	4160 Delta	208Y/120
	19	4160 Delta	480Y/277
	20	4160 Delta	240 Delta
	21	4160 Delta	480 Delta
	22	4160 Delta	600 Delta
	23	4160Y/2400	240 Delta
	25	4160Y/2400	480 Delta
	26	4160/2400	600 Delta
	27	4800 Delta	208Y/120
	28	4800 Delta	480Y/277
	29	4800 Delta	240 Delta
15 60 kV BIL	30	4800 Delta	480 Delta
	31	4800 Delta	600 Delta
	32	7200 Delta	208Y/120
	33	7200 Delta	480Y/277
	34	7200 Delta	240 Delta
	35	7200 Delta	480 Delta
	36	7200 Delta	600 Delta
	37	12000 Delta	208Y/120
	38	12000 Delta	480Y/277
	39	12000 Delta	240 Delta
	40	12000 Delta	480 Delta
	41	12000 Delta	600 Delta
	42	12470 Delta	208Y/120
	43	12470 Delta	480Y/277
44	12470 Delta	240 Delta	
45	12470 Delta	480 Delta	
46	12470 Delta	600 Delta	
47	12470Y/7200	240 Delta	
48	12470Y/7200	480 Delta	
49	12470Y/7200	600 Delta	
50	13200 Delta	208Y/120	
51	13200 Delta	480Y/277	
52	13200 Delta	240 Delta	
53	13200 Delta	480 Delta	
54	13200 Delta	600 Delta	
55	13200Y/7620	240 Delta	
56	13200Y/7620	480 Delta	
57	13200Y/7620	600 Delta	
58	13800 Delta	208Y/120	
59	13800 Delta	480Y/277	
60	13800 Delta	240 Delta	
61	13800 Delta	480 Delta	
62	13800 Delta	600 Delta	

All secondary voltages are at 10 KV BIL. (BIL means Basic Impulse Level).

To complete the three-phase catalog numbers on this page:

1. Select the voltage you require from the chart on the pricing page.
2. Insert the voltage code number in place of the ( ) in the catalog number.

Example 1: 1,000 kVA Energy Efficient, 3Ø, 60 Hz, 150°C temp. rise, 60 kV BIL, NEMA sound level, ventilated indoor enclosure, 13.2 kV delta 480Y/277, with 2-2.5% full capacity taps. 2AN and 2BN = EX1000T51H.

Example 2: 750 KVA Energy Efficient 3Ø, 60 Hz, 80°C temp. rise, 60 kV BIL, NEMA sound level, ventilated indoor enclosure, 4160 V Delta, 480Y/277, 2-2.5% full capacity taps. 2AN and 2BN = Part number EX750T19HB.

Example 3: 500 kVA Energy Efficient, 3Ø, 60 Hz, 115°C temp. rise, Copper Windings, 60 kV BIL, NEMA sound level, ventilated indoor enclosure, 12470 Vac delta, 208Y/120, with 2-2.5% full capacity taps. 2AN and 2BN = EX500T42BCU.

*New!*

**1,201–15,000 Vac Single-Phase Indoor Transformers**

**Table 14.49: New! EX Single Phase Medium Voltage Transformers**

kVA	Catalog No.	Minimum Efficiency @ 50% load	Weight (lbs)	Enclosure
<b>2.4 kV Voltage Class 60 Hz 150 °C Rise</b>				
167	EX167S( )H	98.96	1500	51D
250	EX250S( )H	99.07	2200	52D
333	EX333S( )H	99.14	2500	52D
<b>5 kV Voltage Class 60 Hz 150 °C Rise</b>				
167	EX167S( )H	99.07	1500	52D
250	EX250S( )H	99.14	2400	52D
333	EX333S( )H	99.22	3000	53D
<b>15 kV Voltage Class 60 Hz 150 °C Rise</b>				
167	EX167S( )H	98.95	2400	52D
250	EX250S( )H	99.03	3400	53D
333	EX333S( )H	99.12	4000	53D

Lugs: Furnished by customer.

**Table 14.50: New! Single Phase Voltage Codes**

kV Class	Code	Primary	Secondary
2.4 30 kV BIL	14	2400 Delta	120/240
	25	2400 Delta	277
5 30 kV BIL	13	2400/4160Y	120/240
	15	4800 Delta	120/240
	16	4160 Delta	120/240
	24	2400/4160Y	277
	26	4800 Delta	277
	27	4160 Delta	277
15 60 kV BIL	17	4160/7200Y	120/240
	18	7200	120/240
	28	4160/7200Y	277
	29	7200	277
	19	7200/12470Y	120/240
	20	7620/13200Y	120/240
	21	12470	120/240
	22	13200	120/240
	23	13800	120/240
	30	7200/12470Y	277
	31	7620/13200Y	277
32	12470	277	
33	13200	277	
34	13800	277	

To complete the single-phase catalog numbers on this page:

1. Select the voltage you require from the chart on the pricing page.
2. Insert the voltage code number in place of the ( ) in the catalog number.

Example: 167 kVA Energy Efficient 1Ø 2400/4160Y-120/240 Vac, 1Ø 60 Hz unit is EX167S13H. The unit would be supplied with 2–2.5% above and 2–2.5% full capacity below normal taps on the primary.

*New!*

**Transformer Enclosures**

**Table 14.51: New! Enclosure Dimensions**



Style D, NEMA 1 Rated



Style F—NEMA 1 Rated

Enclosure Number/ Style		Height		Width		Depth		Mounting	NEMA 3R
		in.	mm	in.	mm	in.	mm		
50	D	40.5	1029	36.5	927	21.75	552	Floor	n/a consult factory
51	D	51.5	1308	40.5	1029	26.5	673	Floor	n/a consult factory
52	D	66	1676	50.5	1283	32	813	Floor	n/a consult factory
53	D	80	2032	64	1626	44	1118	Floor	n/a consult factory
54	F	90	2286	72	1829	50	1270	Floor	n/a consult factory
55	F	90	2286	80	2032	50	1270	Floor	n/a consult factory
56	F	90	2286	90	2286	50	1270	Floor	n/a consult factory
57	F	100	2540	100	2540	60	1524	Floor	n/a consult factory
58	F	108	2743	108	2743	60	1524	Floor	n/a consult factory

These dimensions are not for construction. Contact your local Schneider Electric sales office for certified prints.  
Special outdoor construction required for NEMA 3R applications. Contact your local Schneider Electric sales office for details.



# Section 15

## Medical Products

<b>Line Isolation Monitor (LIM)</b>	<b>15-2</b>
Iso-Gard™ Series 6—UL Recognized	15-2
<b>Remote Alarm Indicators</b>	<b>15-3</b>
IG2000P	15-3
IG2000CBM	15-3
<b>Isolated Power Panels</b>	<b>15-4</b>
<b>Accessories</b>	<b>15-5</b>
Receptacle Modules for Controlled Panels	15-5
Hospital Ground Cords and Jacks	15-5
<b>Ordering Information</b>	<b>15-6</b>



Operating Room Isolated Power Panel



Iso-Gard Series 6 LIM



IG2000CBM Remote Alarm Indicator

## Overview of Isolated Power Panels

Schneider Electric has been involved in the design and manufacture of isolated power systems since 1944. Our isolated power panels have evolved over the years and will continue to do so to meet the ever-changing needs of the health care industry.

All of our current power panels incorporate single-phase, NQ panelboard interiors that accept plug-on or bolt-on branch circuit breakers. The panels are designed to support up to 16 branch circuits, eight of which are factory-installed. Since the average number of circuits required per panel in an operating room is five, the eight factory-installed branch circuit breakers will meet the majority of applications.

The Iso-Gard™ Series 6 Line Isolation Monitor (LIM) is readily visible in all layouts, eliminating the need for a composite unit when isolation power panels are installed in operating rooms.

## Iso-Gard™ Series 6—UL Recognized

The Square D™ brand, Iso-Gard Series 6, microprocessor-controlled, line isolation monitor (LIM) is included as standard equipment in all Schneider Electric hospital isolation panels. The Iso-Gard Series 6 LIM incorporates automatic and manual self-test and self-calibration to reduce the frequency of required periodic testing. Other features include:

- Digital and analog display
- Unique audible alarm that will not be confused with other equipment
- UL component recognized and CSA classified
- Microprocessor-controlled circuitry for highest accuracy and stability
- Total hazard current factory set to 5 mA; field-capable setting to 2 mA
- Communication to MODBUS via Gateway

The Iso-Gard Series 6 LIM is also available as a replacement unit for older LIMs, is a direct replacement for all previous Schneider Electric LIMs, and is electrically compatible with all hospital isolated power systems. For more details, refer to 4805CT1301 and MED101301xx.

Schneider Electric created the following four upgrade kits to simplify the ordering process. With a single catalog number, you can now purchase all components necessary for the functional replacement of your existing Iso-Gard LIM.



Iso—Gard Series 6 LIM

Table 15.1: Upgrade Kit Ordering Information

Upgrade Kit	Includes			
	Line Isolation Monitor	Mounting Bracket	Converter Box and Wiring Harness	Transformer
IG6ADKIT	IG6M	IG6CBKTVM	Not applicable	4800XMIA
IG6BDKIT	IG6M	IG6CBKTVM	4800RA1VMAHA	4800XMIA
IG6DDKIT	IG6M	IG6CBKTVM	4800RA1VMAHA	Not applicable
IG6KIT	IG6M	IG6CBKTVM	Not applicable	Not applicable

### NEC® Requirement

The National Electrical Code® (NEC®) **requires** audible and visual alarm indication where isolation power is used (NEC 517-160). Schneider Electric offers the IG2000P and IG2000CBM remote alarm indicators for this purpose.

### IG2000P

The Iso-Gard™ IG2000P remote indicator from Schneider Electric provides remote indication of the visible and audible alarms from a line isolation monitor (LIM).

- Green LED—stays illuminated while the system is in normal condition
- Red hazard LED—illuminates when the Total Hazard Current (THC) exceeds the preset alarm level
- Audible hazard alarm—sounds when the THC exceeds the preset alarm level
- Mute button with yellow LED—silences the audible alarm on the remote indicator (local muting), or silences all audible alarms in the system (system muting)
- Test button—remotely performs a functional test of the LIM

The IG2000P remote indicator is available mounted in a one- or two-gang stainless steel faceplate for flush mounting into a panel or wall box with a two-inch minimum depth. The basic electrical connection is made using three wires.



New!

### IG2000CBM

The Iso-Gard™ IG2000CBM remote indicator from Schneider Electric provides remote indication of the visible and audible alarms and digital mA reading from an Iso-Gard Series 6 (IG6) line isolation monitor (LIM).

- Green LED—stays illuminated while the system is in normal condition
- Red hazard LED—illuminates when the Total Hazard Current (THC) exceeds the preset alarm level
- Audible hazard alarm—sounds when the THC exceeds the preset alarm level
- Mute button with yellow LED—silences the audible alarm on the remote indicator (local muting), or silences all audible alarms in the system (system muting)
- Test button—remotely performs a functional test of the LIM

The IG2000CBM remote indicator is available mounted in a two-gang stainless steel faceplate for flush mounting into a wall box with a two-inch minimum depth. The basic electrical connection is made using four wires.



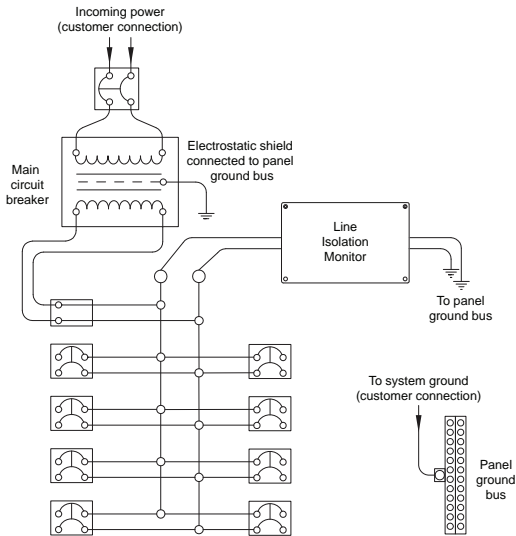

## Overview

Isolated power panels provide a small local electrical network that can be monitored from a line isolation monitor (LIM), allowing for predictive ground fault protection instead of reactive.

A typical isolated power system contains:

- Main disconnect
  - QO circuit breaker (120 V, 208 V, 240 V)
  - H-Frame circuit breaker (277 V, 480 V)
- Isolation Transformer
- Line isolation monitor
- NQ interior
- QO branch circuit breakers
  - Eight factory-installed
  - Space for eight additional
- Ground bus

Multiple layouts are available:

- Standard isolation panels
- Duplex panels
- Dual voltage panels
- Controlled panels

## Standard Isolation Panels

Standard panels offer the most compact solution for a single isolated power system feeding one operating room.

### 120 V Distribution

- Available in four options: 3, 5, 7.5, or 10 kVA
- Up to 16 branch circuits

### 208 V (240 V) Distribution

- Available in four options: 3, 5, 7.5, or 10 kVA
- One or two branch circuits

## Duplex Panels

Duplex panels offer two isolated power systems in a single panel. The systems are separated from each other by a barrier. Duplex panels provide the ability to mix and match the two systems for kVA and distribution voltage to help the designer maximize wall space while meeting the power requirements of the operating room(s).

## Dual Voltage Panels

Dual voltage panels supply both 120 V and 208 V (240 V) isolated power to an operating room.

- Back box requires a 14-inch-deep wall
- Each panel supplies up to sixteen 120 V circuits, plus two 208 V branch circuits

The standard offering includes the following:

- One 30 A, 208 V circuit for equipment such as a laser receptacle
- One 50 A, 208 V circuit for equipment such as an X-ray receptacle

## Controlled Panels

Controlled panels are designed to provide 208 V (240 V) of isolated power to multiple areas from one central location. Historically, they were used to retrofit operating rooms with 208 V. A programmable logic controller (PLC) lets the panel be designed to feed multiple load location, but only provide power to specific power modules. This helps prevent overloading of the system. Since the PLC limits the number of circuits, only the longest-possible conductor length is taken into account during start-up testing.



Schneider Electric offers 208 V or 240 V modules designed to complete the control circuit of a controlled power panel.

**Receptacle Modules for Controlled Panels**

X-ray/laser power receptacle modules provide a convenient source of power for portable X-ray and laser equipment. The receptacle provided in each module is matched to the NEMA plug configuration of the equipment with which it will be used, and is mounted behind the door on the stainless steel face plate. The door features a concealed hinge and a touch latch.



**Power/Ground Modules**

When both ground jacks and power receptacles are required, these UL Listed modules offer convenience and save labor in field wiring. The units include four power receptacles, four twist-to-lock ground jacks, and a ground bus with a generous number of lugs for external ground connections.

The main ground connection in the module accommodates up to a #1/0 cable. The units are completely factory wired; only field power connections and ground connections are necessary. They are furnished with Type 304, brushed stainless steel face plates.



4 Red Duplex Receptacles  
and 4 Ground Jacks



4 Locking Receptacles  
and 4 Ground Jacks

**Hospital Ground Cords and Jacks**

Schneider Electric provides hospital-grade devices for the supply and grounding of portable equipment.

- Hospital ground cords
  - Highly flexible wire with a heavy duty lug or clip end
  - Ground cord with lug end is UL Listed (UL 467)
  - Various lengths available



Ground Cord with Lug End



Ground Cord with Clip End

- Hospital ground jacks



Medical Isolated Power Panels

Table 15.2: 120 V Distribution

Transformer				Interior					Trim Catalog No.		Back Box Catalog No.		
kVA	Primary	Secondary	Catalog No.	LIM Included (field-installed)	Main Disconnect	Circuit Breakers (factory-installed)	Spaces	Catalog No.	Flush	Surface	Flush	Surface	
<b>Plug-on Circuit Breakers</b>													
3	208 V	120 V	SXM03BA	Iso-Gard Series 6	QOU220	Eight QO220	Eight 2-pole	SIP03BA	ST4526	ST4324	SB432406	SB432406S	
	240 V		SXM03CA										SIP03CA
	277 V		SXM03DA										SIP03DA
5	208 V	120 V	SXM05BA	Iso-Gard Series 6	QOU230	Eight QO220	Eight 2-pole	SIP05BA	ST4526	ST4324	SB432406	SB432406S	
	240 V		SXM05CA										SIP05CA
	277 V		SXM05DA										SIP05DA
	480 V		SXM05EA										SIP05EA
7.5	208 V	120 V	SXM07BA	Iso-Gard Series 6	QOU245	Eight QO220	Eight 2-pole	SIP07BA	ST4526	ST4324	SB432408	SB432408S	
	240 V		SXM07CA										SIP07CA
	277 V		SXM07DA										SIP07DA
	480 V		SXM07EA										SIP07EA
10	208 V	120 V	SXM10BA	Iso-Gard Series 6	QOU260	Eight QO220	Eight 2-pole	SIP10BA	ST4526	ST4324	SB432408	SB432408S	
	240 V		SXM10CA										SIP10CA
	277 V		SXM10DA										SIP10DA
	480 V		SXM10EA										SIP10EA

Table 15.3: 120 V Distribution on Both Sides of the Panel

Transformer				Interior									
kVA	Primary	Secondary	Catalog No.		Left				Right				Catalog No.
			Left	Right	LIM Included (field-installed)	Main Disconnect	Circuit Breakers (field-installed)	Spaces	LIM Included (field-installed)	Main Disconnect	Circuit Breakers (field-installed)	Spaces	
<b>Plug-on Circuit Breakers</b>													
3	208 V	120 V	SXM03BA	SXM03BA	Iso-Gard Series 6	QOU220	Eight QO220	Eight 2-pole	Iso-Gard Series 6	QOU220	Eight QO220	Eight 2-pole	SIX03BA03BA
	240 V		SXM03CA	SXM03CA									SIX03CA03CA
	277 V		SXM03DA	SXM03DA									SIX03DA03DA
5	208 V	120 V	SXM05BA	SXM05BA	Iso-Gard Series 6	QOU230	Eight QO220	Eight 2-pole	Iso-Gard Series 6	QOU230	Eight QO220	Eight 2-pole	SIX05BA05BA
	240 V		SXM05CA	SXM05CA									SIX05CA05CA
	277 V		SXM05DA	SXM05DA									SIX05DA05DA
	480 V		SXM05EA	SXM05EA									SIX05EA05EA
7.5	208 V	120 V	SXM07BA	SXM07BA	Iso-Gard Series 6	QOU245	Eight QO220	Eight 2-pole	Iso-Gard Series 6	QOU245	Eight QO220	Eight 2-pole	SIX07BA07BA
	240 V		SXM07CA	SXM07CA									SIX07CA07CA
	277 V		SXM07DA	SXM07DA									SIX07DA07DA
	480 V		SXM07EA	SXM07EA									SIX07EA07EA
10	208 V	120 V	SXM10BA	SXM10BA	Iso-Gard Series 6	QOU260	Eight QO220	Eight 2-pole	Iso-Gard Series 6	QOU260	Eight QO220	Eight 2-pole	SIX10BA10BA
	240 V		SXM10CA	SXM10CA									SIX10CA10CA
	277 V		SXM10DA	SXM10DA									SIX10DA10DA
	480 V		SXM10EA	SXM10EA									SIX10EA10EA
<b>Bolt-on Circuit Breakers</b>													
3	208 V	120 V	SXM03BA	SXM03BA	Iso-Gard Series 6	QOU220	Eight QOB220	Eight 2-pole	Iso-Gard Series 6	QOU220	Eight QOB220	Eight 2-pole	SIX03BA03BAB
	240 V		SXM03CA	SXM03CA									SIX03CA03CAB
	277 V		SXM03DA	SXM03DA									SIX03DA03DAB
5	208 V	120 V	SXM05BA	SXM05BA	Iso-Gard Series 6	QOU230	Eight QOB220	Eight 2-pole	Iso-Gard Series 6	QOU230	Eight QOB220	Eight 2-pole	SIX05BA05BAB
	240 V		SXM05CA	SXM05CA									SIX05CA05CAB
	277 V		SXM05DA	SXM05DA									SIX05DA05DAB
	480 V		SXM05EA	SXM05EA									SIX05EA05EAB
7.5	208 V	120 V	SXM07BA	SXM07BA	Iso-Gard Series 6	QOU245	Eight QOB220	Eight 2-pole	Iso-Gard Series 6	QOU245	Eight QOB220	Eight 2-pole	SIX07BA07BAB
	240 V		SXM07CA	SXM07CA									SIX07CA07CAB
	277 V		SXM07DA	SXM07DA									SIX07DA07DAB
	480 V		SXM07EA	SXM07EA									SIX07EA07EAB
10	208 V	120 V	SXM10BA	SXM10BA	Iso-Gard Series 6	QOU260	Eight QOB220	Eight 2-pole	Iso-Gard Series 6	QOU260	Eight QOB220	Eight 2-pole	SIX10BA10BAB
	240 V		SXM10CA	SXM10CA									SIX10CA10CAB
	277 V		SXM10DA	SXM10DA									SIX10DA10DAB
	480 V		SXM10EA	SXM10EA									SIX10EA10EAB

# Section 16

## NEMA and Definite Purpose Contactors and Starters

16 NEMA AND DEFINITE PURPOSE CONTACTORS AND STARTERS



Manual Starters and Switches



Definite Purpose Contactors and Starters



NEMA Style Type S Contactors and Starters



Lighting Contactors



Pump Panel



Combination Starters



NEMA Style TeSys N Contactors and Starters



<b>Selection Information</b>	<b>16-2</b>
<b>Manual Starters and Switches</b>	<b>16-4</b>
<b>TeSys™ U Motor Starters</b>	<b>16-12</b>
<b>TeSys™ N Contactors and Starters</b>	<b>16-13</b>
<b>Type S Full Voltage Contactors and Starters</b>	<b>16-28</b>
<b>Vacuum Contactors and Starters, Full Voltage</b>	<b>16-43</b>
<b>Type S Combination Starters</b>	<b>16-46</b>
<b>Type S Reversing Full Voltage Contactors and Starters</b>	<b>16-60</b>
<b>Reversing Vacuum Contactors, Full Voltage</b>	<b>16-66</b>
<b>Type S Reversing Combination Starters</b>	<b>16-67</b>
<b>Lighting Contactors</b>	<b>16-74</b>
<b>Definite Purpose Contactors</b>	<b>16-89</b>
<b>Definite Purpose Starters</b>	<b>16-92</b>
<b>Well-Guard Control™ Pump Panels</b>	<b>16-93</b>
<b>Duplex AC Motor Controllers</b>	<b>16-96</b>
<b>Reversing Definite Purpose Contactors</b>	<b>16-99</b>
<b>Overload Relays</b>	<b>16-100</b>
<b>Separate Enclosures</b>	<b>16-110</b>
<b>Factory Modifications (Forms)</b>	<b>16-117</b>
<b>Magnetic Coils</b>	<b>16-122</b>
<b>Replacement Parts Kits</b>	<b>16-124</b>
<b>Accessories</b>	<b>16-126</b>
<b>Thermal Units</b>	<b>16-132</b>

Selection Information



16 NEMA AND DEFINITE PURPOSE CONTACTORS AND STARTERS

Class	2510, 2511, 2512	T02, T36	8502 & 8702	8536 & 8736	8538 & 8738
		NEMA Style, Full Voltage Non-Reversing and Full Voltage Reversing			
Type of Product	Manual Starters and Switches, Non-Reversing, Reversing and Two Speed	TeSys™ N Contactors and Starters	AC Magnetic Contactors	AC Magnetic Starters	Combination Magnetic Starters with Disconnect Switch
Page	page 16-4	page 16-14	8502: page 16-29 8702: page 16-60	8536: page 16-33 8736: page 16-62	8538: page 16-47 8738: page 16-67
NEMA Sizes	M-0 M-1 M-1P	00-7	00-7	00-7	8538: 0-6 8738: 0-5
Load Voltage	Type F: 277 Vac Types K & M: 600 Vac	600 Vac Max.	600 Vac Max.	600 Vac Max.	600 Vac Max.
Current Ratings (Continuous)	Type F: 16 A Types K & M: 30 A	9-810 A	9-810 A	9-810 A	8538: 18-540 A 8738: 18-270 A
Horsepower Ratings (Maximum)	Type F: 1 Type K: 20 Type M: 10	600	0.5-600	0.5-600	8538: 0.5-400 8738: 0.5-200
Overload Relay	Type F: Melting Alloy Type K: N/A Type M: Melting Alloy	Contactors: N/A Starters: Bimetallic (Size 00-2) or Solid-State	N/A	Melting Alloy Bimetallic (Size 00-2) Solid State	Melting Alloy Bimetallic (Size 0-2) Solid State
Enclosure Types	1, Flush Mount, 3R, 4, 4X, 7 & 9 and Open	Open	1, 3R, 4, 4X, 12/3R, 7 & 9 and Open	1, 3R, 4, 4X, 12/3R, 7 & 9 and Open	1, 4, 4X, 12/3R
Approvals	UL File E42243 NLRV UR File E42243 NLRV2 CSA File LR 25490	Contactors: UL File E164862 NLDX CSA LR43364 Class 3211-24 Starters: UL File E152395 NKJH CSA LR60905 Class 3211-24	UL File E78351 NLDX CSA 60905 Class 3211-04	UL File E78351 NLDX CSA 60905 Class 3211-04	UL File E152395 NKJH7 CSA LR584 Class 3211 04



Selection Information



Class	8539 & 8739	8903L & 8903S	8903 Combination Devices	8910, 8911, 8965	8940	8941
Type of Product	Combination Magnetic Starters with PowerPact™ Circuit Breaker	Multipole electrically held and mechanically held contactors available in 30 A configurations to 12 poles and 800 A configurations to 3 poles.	Type S lighting contactors electrically held and mechanically held available with disconnect switches or PowerPact™ circuit breakers	Definite Purpose non-reversing contactors available as compact 1 or 2 pole to 40 A and 2 to 4 pole to 90 A. Reversing and Starter Configurations also available.	Well-Guard Control™ Pumping Plant Panels available with disconnect switches or PowerPact™ circuit breakers.	NEMA Style AC Duplex Motor Controllers available as a combination starter or without disconnecting means.
Page	8539: page 16-51 8739: page 16-69	page 16-74	page 16-77	8910: page 16-89 8911: page 16-92 8965: page 16-99	page 16-93 page 16-94	page 16-96
NEMA Sizes	8539: 0-7 8739: 0-6	N/A	N/A	N/A	1-7	1-4
Load Voltage	600 Vac Max.	600 Vac Max.	600 Vac Max.	600 Vac Max.	600 Vac Max.	600 Vac Max.
Current Ratings (Continuous)	8539: 18-810 A 8739: 18-540 A	8903L to 30 A 8903S to 800 A	300 A (Disconnect) 600 A (Circuit Breaker)	20-40 A (Compact) 20-90 A	27-810 A	27-135 A
Horsepower Ratings (Maximum)	8539: 0.5-600 8739: 0.5-400	N/A	N/A	0.5-50	0.5-600	0.5-100
Overload Relay	Melting Alloy Bimetallic (Size 0-1) Solid State	N/A	N/A	Melting Alloy (8911)	Melting Alloy Bimetallic Solid State	Melting Alloy Bimetallic Solid State
Enclosure Types	1, 4, 4X, 12/3R	1, 3R, 4, 4X, 12/3R and Open	1, 4, 4X, 12/3R	1	3R	1, 4, 4X, 12/3R and Open
Approvals	UL File E152395 NKJH7 CSA LR584 Class 3211 04	UL File E78427 NRNT CSA LR60905 Class 3231 01	UL File E16151 NRNT cUL File E16151 NRNT	UL E3190 NLDX2 CSA LR25490 Class 3211 04	UL/cUL 152395 NKJH	UL File E152395 NKJH7

Fractional Horsepower Manual Starters with Melting Alloy Type Thermal Overload Relay

Table 16.1: Single-Unit Types—Class 2510—Rated 16 A—Thermal Units (see Thermal Unit Selection, page 16-132)

Type of Operator	No. of Poles	Features	NEMA 1 General Purpose Enclosure Surface Mounting		General Purpose Flush Mounting (Without Pull Box)			NEMA Type 4 [1] Enclosure Watertight and Dusttight	NEMA Types 3R, 7 & 9 Enclosure Hazardous Locations Div. 1 & 2 Class I Groups B, C, & D, & Class II Groups E, F, & G	Open Type	Number of Thermal Units Required
			Standard	Oversized	Gray Flush Plate	Standard Stainless Steel Flush Plate	Jumbo Stainless Steel Flush Plate				
			Type	Type	Type	Type	Type				
<b>Basic Starter—Class 2510</b>											
Toggle	1	Standard	FG1	FGJ1	FF1	FS1	—	—	—	FO1	1
		With Red Pilot Light [2]	FG1P	FGJ1P	FF1P	FS1P	FSJ1P	—	—	FO1P	1
	2	Standard	FG2	FGJ2	FF2	FS2	—	—	—	FO2	1
		With Red Pilot Light [2]	FG2P	FGJ2P	FF2P	FS2P	FSJ2P	—	—	FO2P	1
Key	1	Standard	FG3	FGJ3	FF3	FS3	—	—	—	FO3	1
		With Red Pilot Light [2]	FG3P	FGJ3P	FF3P	FS3P	FSJ3P	—	—	FO3P	1
	2	Standard	FG4	FGJ4	FF4	FS4	—	—	—	FO4	1
		With Red Pilot Light [2]	FG4P	FGJ4P	FF4P	FS4P	FSJ4P	—	—	FO4P	1
<b>Starter with Handle Guard/Lock-Off—Class 2510</b>											
Toggle	1	Standard	FG5	FGJ5	Order basic starter plus separate handle guard kit.			FW1	FR1	[3] [4]	1
		With Red Pilot Light [2]	FG5P	FGJ5P				FW1P	—	[3] [4]	1
	2	Standard	FG6	FGJ6				FW2	FR2	[3] [4]	1
		With Red Pilot Light [2]	FG6P	FGJ6P				FW2P	—	[3] [4]	1

Table 16.2: Duplex Units—Class 2510

Type of Operator	No. of Poles	Features	NEMA 1 General Purpose Enclosure Surface Mounting	General Purpose Flush Mounting (Without Pull Box)		Replacement Starter Class 2510	Number of Thermal Units Required	
			Type	Gray Flush Plate for Wall or Cavity Mounting	Stainless Steel Flush Plate for Wall or Cavity Mounting			
<b>One Starter in Duplex Enclosure—Class 2510</b>								
Toggle	2	Standard	FG02	—	—	—	1	
		With Red Pilot Light [2]	FG02P	—	—	—		
Key	2	With Red Pilot Light [2]	FG04P	—	—	—	1	
<b>Two Starters in One Enclosure—Class 2510</b>								
Toggle	2 Each Str.	Standard	FG22	FF22	—	—	2	
		With Red Pilot Light on Each [2]	FG22P	FF22P	FS22P	—		
Key	2 Each Str.	With Red Pilot Light on Each [2]	FG44P	FF44P	FS44P	—	2	
<b>Starter and Auto-Off-Hand SPDT Selector Switch (AC Only)—Class 2510</b>								
Toggle	1	Standard	FG71	FF71	—	—	1	
		With Red Pilot Light [2]	FG71P	FF71P	FS71P	—		
	2	Standard	FG72	FF72	—	—	1	
		With Red Pilot Light [2]	FG72P	FF72P	FS72P	—		
Key	2	With Red Pilot Light [2]	FG74P	FF74P	FS74P	—	1	
<b>Two Speed Starters (AC Only)—Class 2512</b>						<b>Replacement Starter—Class 2510</b>		
Toggle	1	<b>With Mechanical Interlock:</b>						2
		Standard	FG11	FF11	—	FO1T		
		With 2 Red Pilot Lights [2]	FG11P	FF11P	—	FO1PT		
		<b>With High-Off-Low Selector Switch:</b>						
	With 2 Red Pilot Lights [2]	—	—	FS101P	FO1PT			
	2	<b>With Mechanical Interlock:</b>						2
		Standard	FG22	FF22	—	FO2T		
		With 2 Red Pilot Lights [2]	FG22P	FF22P	—	FO2PT		
<b>With High-Off-Low Selector Switch:</b>								
With 2 Red Pilot Lights [2]	—	—	FS202P	FO2PT				

Table 16.3: Horsepower Ratings, Type F (continuous current rating: 16 A)

Volts	Maximum Horsepower		
	AC Single Phase		DC 2-Pole Only
	1-Pole	2-Pole	
115	1	1	3/4
230	1	2	3/4
277	1	1	—

Table 16.4: Approvals—2510 Type F and K

Agency	Enclosed	Open
UL	UL Listed File: E42243, CCN: NLRV	UL Component Recognized File: E42243, CCN: NLRV2
CSA	CSA Certified File: LR25490, Class: 3211-05	

Table 16.5: How to Order

To Order Specify:	Catalog Number	
• Class Number	Class	Type
• Type Number	2510	FG1



Type FG2P

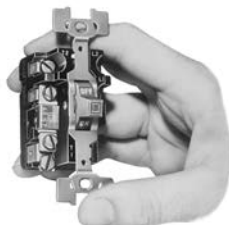

Type FO2

[1] Furnished with one 3/4" pipe tap in the bottom (reversible for top feed). For a 3/4" pipe tap in the top and bottom, add the suffix H to the Type.  
 [2] For a green pilot light, add the letter G to the catalog number (i.e. 2510FG2PG).  
 [3] For a replacement starter, order the Open type above.  
 [4] When replacing a starter equipped with a pilot light in NEMA 4 enclosure, retain the pilot light mounting bracket from the original device.

**Manual Switches, Type K**

**Table 16.6: Non-Reversing—Class 2510**

Operator Style	No. of Poles	Features	NEMA 1 General Purpose Enclosure Surface Mounting		General Purpose Flush Mounting (Without Pull Box)			NEMA 4 Enclosure <sup>[5]</sup> Watertight and Dusttight	NEMA 3R, 7 & 9 Enclosures <sup>[5]</sup> Hazardous Locations Div. 1 & 2 Class I Groups B, C, & D, & Class II Groups E, F, and G	Open Style	
			Standard	Oversized	Gray Flush Plate	Standard Stainless Steel Flush Plate	Jumbo Stainless Steel Flush Plate				
			Type	Type	Type	Type	Type				
Toggle	2	Standard	KG1	KGJ1	KF1	KS1	—	KW1	KR1	KO1	
		With Pilot Light <sup>[6]</sup>	115 Vac 230 Vac	KG1A KG1B	KGJ1A KGJ1B	KF1A KF1B	KS1A KS1B	KSJ1A KSJ1B	KW1A KW1B	—	KO1A <sup>[7]</sup> KO1B <sup>[7]</sup>
	3	Standard	KG2	KGJ2	KF2	KS2	—	KW2	KR2	KO2	
		With Pilot Light <sup>[6]</sup>	208–277 Vac 440–600 Vac	KG2B KG2C	KGJ2B KGJ2C	KF2B KF2C	KS2B KS2C	KSJ2B KSJ2C	KW2B KW2C	—	KO2B <sup>[7]</sup> KO2C <sup>[7]</sup>
	2	Standard	KG5	KGJ5	—	—	—	KW5	—	KO5	
		With Pilot Light <sup>[6]</sup>	115 Vac 230 Vac	KG5A KG5B	—	—	—	KW5A KW5B	—	KO5A <sup>[7]</sup> KO5B <sup>[7]</sup>	
	3	Standard	KG6	KGJ6	—	—	—	KW6	—	KO6	
		With Pilot Light <sup>[6]</sup>	208–277 Vac 440–600 Vac	KG6B KG6C	—	—	—	KW6B KW6C	—	KO6B <sup>[7]</sup> KO6C <sup>[7]</sup>	
	Key	2	Standard	KG3	KGJ3	KF3	KS3	—	—	—	KO3
			With Pilot Light <sup>[6]</sup>	115 Vac 230 Vac	KG3A KG3B	KGJ3A KGJ3B	KF3A KF3B	KS3A KS3B	KSJ3A KSJ3B	—	KO3A KO3B
		3	Standard	KG4	KGJ4	KF4	KS4	—	—	—	KO4
			With Pilot Light <sup>[6]</sup>	208–277 Vac 440–600 Vac	KG4B KG4C	KGJ4B KGJ4C	KF4B KF4C	KS4B KS4C	KSJ4B KSJ4C	—	KO4B KO4C

**Table 16.7: Reversing—Class 2511**

Operator Style	No. of Poles	Suitable for Motor Types	Features (Including Mechanical Interlock)	NEMA 1 General Purpose Enclosure Surface Mounting	With Flush Plate for Cavity Mounting (Without Pull Box)	Replacement Switch Class 2510	
				Type	Type	Type	
Toggle	2	1 Ø 3-Lead Repulsion-Induction	Standard	KG11	KF11	KO1T	
			With Pilot Light <sup>[6]</sup>	115 Vac 230 Vac	KG11A KG11B	KF11A KF11B	KO1AT KO1BT
	3	3 Ø; Also 1 Ø Capacitor, Split Ø, or 4-Lead Repulsion-Induction	Standard	KG22	KF22	KO2T	
			With Pilot Light <sup>[6]</sup>	110–120 Vac	KG22A	KF22A	KO2AT
				208–220 Vac	KG22B	KF22B	KO2BT
				440–600 Vac	KG22C	KF22C	KO2CT

**Table 16.8: Two Speed—Class 2512**

Operator Style	No. of Poles	Suitable for Motor Types	Features (Including Mechanical Interlock)	NEMA 1 General Purpose Enclosure Surface Mounting	With Flush Plate for Cavity Mounting (Without Pull Box)	Replacement Switch Class 2510	
				Type	Type	Type	
Toggle	2	1 Ø Two Winding (3-Lead)	Standard	KG11	KF11	KO1T	
			With 2 Pilot Lights <sup>[6]</sup>	115 Vac 230 Vac	KG11A KG11B	KF11A KF11B	KO1AT KO1BT
	3	3 Ø Separate Winding (Wye-Connected)	Standard	KG22	KF22	KO2T	
			With 2 Pilot Lights <sup>[6]</sup>	208–240 Vac	KG22B	KF22B	KO2BT
				440–600 Vac	KG22C	KF22C	KO2CT

**Table 16.9: Class 2511 and 2512 Horsepower Ratings Type K**

Device	No. of Poles	Motor Type AC	Maximum Hp			Maximum DC Hp (breaking 2 poles)		
			115 V	230 V	460–575 V	90 V	115 V	230 V
Class 2511	2	1 Ø	2	2	3	1	2	1-1/2
	3	3Ø	2	7-1/2	10			
	2	1 Ø	2	2	3			
Class 2512	3	3 Ø, Constant or Variable Torque	2	7-1/2	10	1	2	1-1/2
	3	3 Ø, Constant Hp	2	7-1/2	10			
<b>Continuous current rating</b>			30 A at 600 Vac maximum			30 A at 24 Vdc maximum		

**Table 16.10: Class 2510 Horsepower Ratings**

Class 2510	No. of Poles	Motor Type AC	Maximum Hp				Maximum DC Hp (breaking 2 poles)		
			115 V	230 V	460 V	575 V	90 V	115 V	230 V
KO1 KO3	2	Single Ø	2	2	3	3	1	2	1-1/2
KO2 KO4	3	Three Ø	2	7-1/2	10	10			
KO5 KO6	2 3	Single Ø Three Ø	2 2	3 7-1/2	7-1/2 15	10 20			
<b>Continuous current rating</b>			30 A at 600 Vac maximum				30 A at 24 Vdc maximum		

**Table 16.11: How to Order**

To Order Specify:	Catalog Number	
• Class Number	Class	Type
• Type Number	2510	KO2

<sup>[5]</sup> Furnished with one 3/4" pipe tap in the bottom (reversible for top feed). For a 3/4" pipe tap in the top and bottom, add the suffix H to the Type.  
<sup>[6]</sup> For a green pilot light, add the letter G to the catalog number (i.e. 2510FG2PG)  
<sup>[7]</sup> When replacing a starter equipped with a pilot light in NEMA 4 enclosure, retain the pilot light mounting bracket from the original device.

**Open Type**

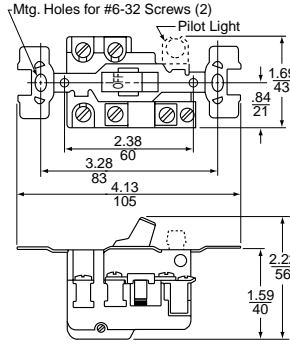

Types FO1, 1P, 2  
Fractional Hp Starter

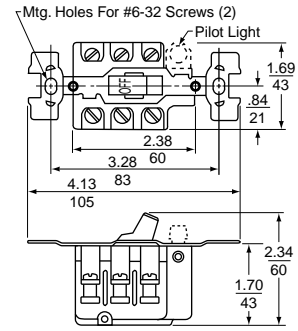

Types KO1, 1A, 1B, 2, 2B, 2C  
Types KO5, 5A, 5B, 6, 6B, 6C  
Motor Starting Switch

**NEMA 1 General Purpose Enclosure (Surface Mount)**

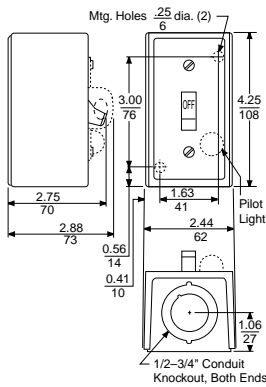

Standard  
(Class 2510 Types FG & KG, Single Unit)

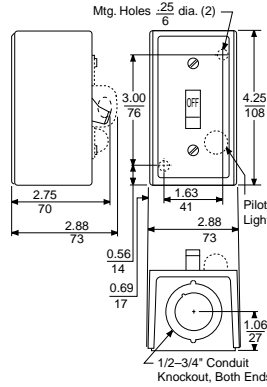

Oversized  
(Class 2510 Types FGJ & KGJ, Single Unit)

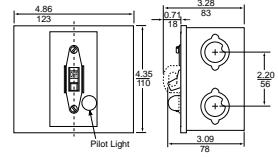

Jumbo  
(Class 9991 Type KE2, see )

**NEMA 1 General Purpose Enclosure (Flush Mount)**

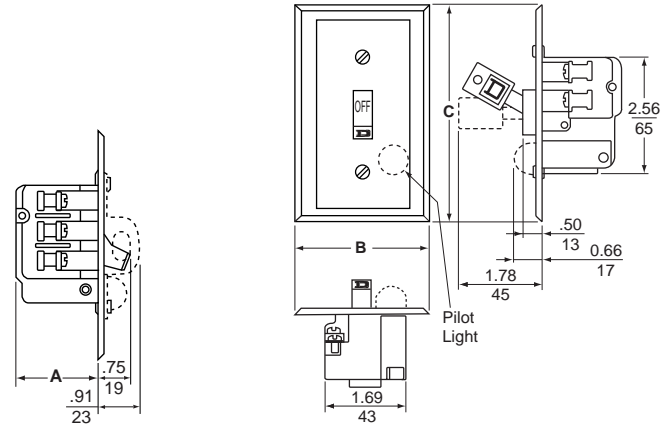

**Table 16.12: General Purpose Enclosure (Flush Mount)**

Device	Type of Operator	Class 2510 Type	Dimensions		
			A	B	C
Fractional Hp Starter	Toggle	FF1, 1P, 2, 2P, FS1, 1P, 2, 2P	1.44	2.75	4.5
		FSJ1P, 2P	1.44	3.5	5.25
	Key	KF3, 3P, 4, 4P, FS3, 3P, 4, 4P	1.44	2.75	4.5
FSJ3P, 4P		1.44	3.5	5.25	
Motor Starting Switch	Toggle	KF1, 1A, 1B, 2, 2B, 2C KS1, 1A, 1B, 2, 2B, 2C	1.75	2.75	4.5
		KSJ1A, 1B, 2B, 2C	1.75	3.5	5.25
	Key	KF3, 3A, 3B, 4, 4B, 4C KS3, 3A, 3B, 4, 4B, 4C	1.75	2.75	4.5
KSJ3A, 3B, 4B, 4C		1.75	3.5	5.25	

**NOTE:** These dimensions are for reference only. If you need precise measurements, contact the Customer Care Center at 1-888-778-2733.

**Table 16.13: NEMA 4 Watertight Die-Cast Zinc Enclosure**

Device	Class	Type
Fractional Hp Starter	2510	FW1, 1P, 2, 2P
Motor Starting Switch	2510	KW1, 1A, 1B, 2, 2B, 2C

**NEMA 4 Watertight Die-Cast Zinc Enclosure**

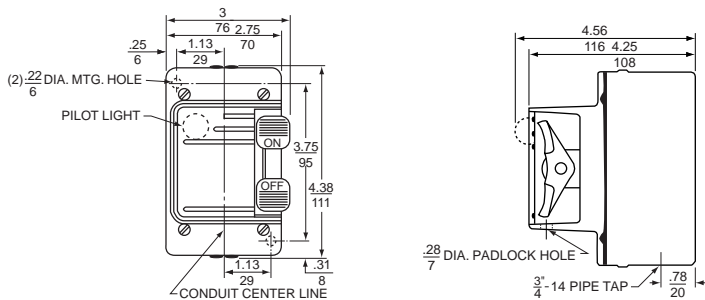

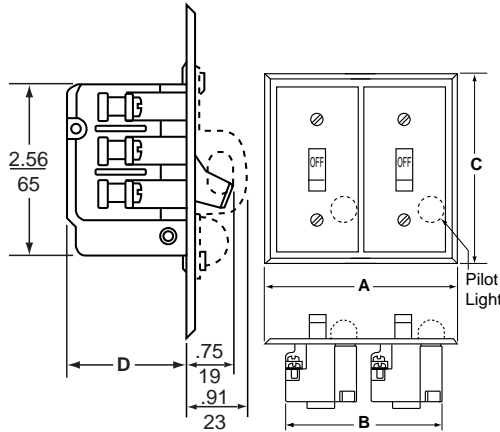
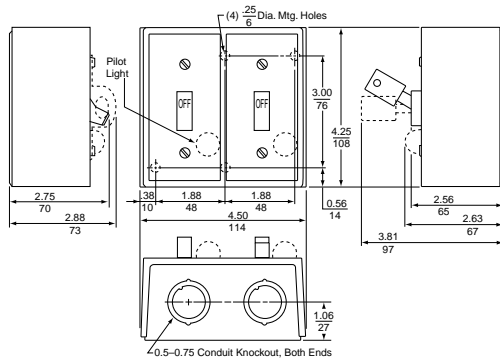
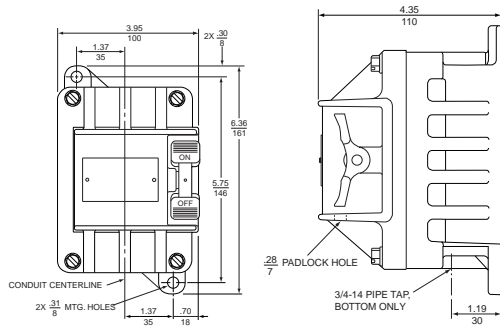

**NEMA 3R, 7, and 9 Aluminum Enclosure for Hazardous Locations**  
**Table 16.14: NEMA 3R, 7, and 9 Aluminum Enclosure for Hazardous Locations**

Device	Class	Type
Fractional Hp Starter	2510	FR1, 2
Motor Starting Switch	2510	KR1, 2

**Dimensions for Duplex Devices**

**NOTE:** These dimensions are for reference only. If you need precise measurements, contact the Customer Care Center at 1-888-778-2733.

**Table 16.15: NEMA 1 General Purpose Surface Mount Enclosure for Duplex Devices**

Device	Type of Operator	Class	Type
One Starter	Toggle	2510	FGO2, 02P
	Key	2510	FGO4P
Two Starters	Toggle	2510	FG22, 22P
	Key	2510	FG44P
One Starter and One Selector Switch <sup>[8]</sup>	Toggle	2510	FG71, 71P, 72, 72P
	Key	2510	FG74P
Reversing Switch <sup>[9]</sup>	Toggle	2511	KG11, 11A, 11B, 22, 22A, 22B, 22C
Two-Speed Starter	Toggle	2512	FG11, 11P, 22, 22P
Two-Speed Switch	Toggle	2512	KG11, 11A, 11B, 22, 22B, 22C

**Table 16.16: General Purpose Flush Mounting Plate for Duplex Devices**

Device	Type of Operator	Class	Type	Dimensions <sup>[10]</sup>			
				A	B	C	D
Two Starters	Toggle	2510	FF22, 22P	5.25	3.75	5.25	1.44
			FS22P	4.56	3.5	4.5	1.44
	Key	2510	FF44P	5.25	3.75	5.25	1.44
			FS44P	4.56	3.5	4.5	1.44
One Starter and One Selector Switch <sup>[11]</sup>	Toggle	2510	FF71, 71P, 72, 72P	5.25	0.75	5.25	2
			FS71P, 72P	4.56	3.5	4.5	2
	Key	2510	FF74P	5.25	3.75	5.25	2
			FS74P	4.56	3.5	4.5	2
Reversing Switch	Toggle	2511	KF11, 11A, 11B, KF22, 22A, KF22B, 22C	5.25	3.75	5.25	1.75
Two-Speed Starter	Toggle	2512	FF11, 11P, 22, 22P	5.25	3.75	5.25	1.44
Two-Speed Switch	Toggle	2512	KF11, 11A, 11B, KF22, 22B, 22C	5.25	3.75	5.25	1.75

[8] Selector switch is on the left and increases the overall depth to 3.5 in.  
 [9] Only one pilot light (located on right) is used on Class 2511 switches.  
 [10] Dimensions include factory wired power connections.  
 [11] Selector Switch is on left, extends 1-5/8" from mounting surface.

Integral Horsepower



Types M and T integral horsepower manual starters provide convenient On-Off operation of small single phase, polyphase or DC motors. Typical applications include small machine tools, pumps, fans and conveyors.

- Push button (M) or toggle (T) operators
- Reliable overload protection
- Pilot light and auxiliary contact available

16 NEMA AND DEFINITE PURPOSE CONTACTORS AND STARTERS

Table 16.17: Integral Horsepower Manual Starters (see Thermal Unit Selection, page 16-132)

Non-Reversing, Class 2510, Max. Voltage: 600 Vac												
No. of Poles	NEMA Size	Ratings			NEMA 1 Surface Mounting		NEMA 4/4X Watertight and Dusttight Enclosure Brushed Stainless Steel	NEMA 4/4X Watertight, Dusttight and Corrosion-Resistant Glass-Polyester Enclosure	NEMA 7 & 9 For Hazardous Locations Class I—Groups C, D Class II—Groups E, F & G	NEMA 12 Dusttight and Driptight Industrial Use Enclosure	Open Type	
		Motor Voltage	Max. Hp		Square P.B. Operator	Toggle Operator					Square P.B. Operator	Toggle Operator
			Poly-Phase	Single Phase	Type						Type	Type
2-Pole	M-0	115 230	—	1 2	MBG1	TBG1	MBW11 [13]	MBW1 [13]	MBR1 [13]	MBA1 [13]	MBO1	TBO1
	M-1	115 230	—	2 3	MCG1	TCG1	MCW11	MCW1	MCR1	MCA1	MCO1	TCO1
	M-1P	115 230	—	3 5	MCG2	TCG2	MCW12	MCW2	MCR2	MCA2	MCO2	TCO2
3-Pole	M-0	200-230 380-575	— 3 5	— —	MBG2	TBG2	MBW12 [13]	MBW2 [13]	MBR2 [13]	MBA2 [13]	MBO2	TBO2
	M-1	200-230 380-575	— 7.5 10	— —	MCG3	TCG3	MCW13	MCW3	MCR3	MCA3	MCO3	TCO3
DC 2-Pole	M-0	115 230	1 hp DC 1.5 hp DC		MBG4	TBG4	MBW14	MBW4	—	MBA4	MBO4	TBO4
	M-1	115 230	1.5 hp DC 2 hp DC		MCG5	TCG5	MCW15	MCW5	MCR5	MCA5	MCO5	TCO5



All Except NEMA 7 and 9  
File E42243  
CCN NLRV  
NEMA 7 and 9 Only  
File E58760  
CCN NPXZ



All Except NEMA 7 and 9  
File LR60905  
Class 3211-05  
NEMA 7 and 9 Only  
File LR26817  
Class 3218-04

Table 16.18: How to Order

To Order Specify:	Catalog Number	
	Class	Type
• Class Number	2510	MCA1
• Type Number		

[12] NEMA 7 & 9 enclosures are cast iron. NEMA 7 & 9 cast aluminum enclosures are also available; to order, replace the R in the catalog number with a T. For additional information, contact the Customer Care Center.

[13] Approved for group motor installations per NEC 430-53(c).

**Reversing and Two Speed**

Class 2511 reversing and Class 2512 two-speed manual starters consist of two mechanically interlocked Class 2510 Types M or T manual starters.

**Table 16.19: Reversing Class 2511**

Class	Description	Number of Poles	NEMA Size	Ratings		NEMA 1 Surface Mounting		Open Type	
				Motor Voltage	Maximum Hp	Square P.B. Operator	Toggle Operator	Square P.B. Operator	Toggle Operator
2511	Standard	3-Pole	M-0	200-230	3	MBG1	TBG1	MBO1	TBO1
				380-575	5				
			M-1	200-230	7-1/2	MCG1	TCG1	MCO1	TCO1
				380-575	10				

**Table 16.20: Two Speed, Class 2512 (Wye-Connected Separate Winding Motors Only)**

Class	Description	Number of Poles	NEMA Size	Ratings			NEMA 1 Surface Mounting		Open Type	
				Motor Voltage	Constant Hp	Constant Torque or Variable Torque	Square P.B. Operator	Toggle Operator	Square P.B. Operator	Toggle Operator
2512	Standard	3-Pole	M-0	200-230	2	3	MBG1	TBG1	MBO1	TBO1
				380-575	3	5				
			M-1	200-230	5	7-1/2	MCG1	TCG1	MCO1	TCO1
				380-575	7-1/2	10				

**Thermal Units**

Starters will not operate without properly installed thermal units and device reset. Thermal unit must be installed so that markings face the front of starter.

**Application Data**

**Size**—Available in NEMA Sizes M-0, M-1, and M-1P.

**Poles**—Two poles single phase; three poles polyphase; 2 poles DC.

**Voltage**—600 Vac max.; 250 Vdc max.

**Overload Relays**—Melting alloy thermal overload relays have provisions for one Type B thermal unit for single phase starters and three Type B thermal units for three phase starters. **All thermal units must be installed and the device reset before the starter contacts will operate.** After overload relays have tripped, allow one or two minutes for the alloy to solidify before resetting.

**Operator**—Available with a push button or toggle operator in open and NEMA 1 versions. NEMA 4/4X (stainless) and 12 versions utilize a direct acting push button only. NEMA 4/4X (polyester) and 7/9 versions utilize an external toggle to actuate a push button device inside.

**Maintenance of Equipment**

For proper performance, all equipment should be periodically inspected and maintained. Replacement contacts and interlocks are available in kit form to facilitate servicing and stocking. In addition, the service bulletin contains an exploded view of the device with components clearly marked for easy identification by description and part number.

**Mechanism Lock Off** – Both open devices and starters in NEMA 1 surface and flush mounting, and NEMA 4, 4X, 7 & 9, and 12 enclosures can be locked in the Off or Stop position.

The NEMA 1 surface mounting, 4, 4X, 7 & 9, and 12 enclosures can also be locked closed to prevent unauthorized entry.

**Table 16.21: Terminal information and Replacement Contact Kits**

NEMA Size	Power Terminals		Auxiliary Interlock Terminals		Number of Poles	Service Bulletin	Replacement Contact Kit	
	Type of Lug	Wire Size (Solid or Stranded Copper Wire) Min.-Max.	Type of Lug	Wire Size (Solid or Stranded Copper Wire) Min.-Max.			Class	Type
M-0	Pressure Wire	14–8	Pressure Wire	16–12	2 or 3	312AS	9998	ML1
M-1	Pressure Wire	14–8	Pressure Wire	16–12	2 or 3	312AS	9998	ML2
M-1P	Box Lug	14–6	Pressure Wire	16–12	2	312AS	9998	ML2

**Accessories and Modification Kits**

**One auxiliary contact**, either N.O. or N.C. can easily be added internally to any open or enclosed Type M or T manual starter. It occupies the space provided in either the upper right hand or left hand corners of the device. These contacts are for AC loads only. For electrical ratings, refer to page 16-127, Class 9999 Types SX11 or SX12.

A unique red **pilot light** assembly that clips into place is available **factory installed** on NEMA 1, 4, 4X, 12 and flush enclosures or as a **field modification kit** on the NEMA 1 surface or flush mounting enclosures. See page 16-11. The color cap assembly snaps into a knockout in the enclosure cover on the NEMA 1 enclosures. Pilot light kits are available for use on Various voltages (110-600 V). Pilot light assemblies are not available for NEMA 7 and 9 enclosures.

Approximate Dimensions



NEMA 1  
General Purpose Surface Mounting



NEMA 12  
Dusttight and Driptide  
Industrial Use



NEMA 4/4X  
Watertight and Dusttight  
Stainless Steel

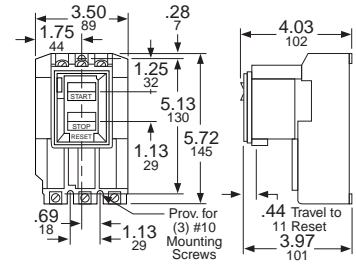

Class 2510 Type M  
Sizes M-0, M-1 and M-1P, Open Style  
Approximate Shipping Weight: 3 lb



NEMA 4/4X  
Watertight, Dusttight  
and Corrosion Resistant  
Glass Polyester



NEMA 7 & 9  
Hazardous Locations  
Cast Iron

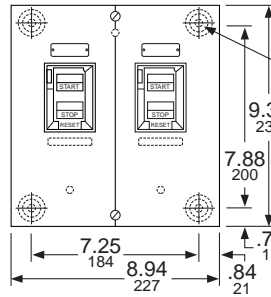

Classes 2511, 2512, Types M & T  
Sizes M-0 and M-1 NEMA 1  
General Purpose Enclosure  
Approximate Shipping Weight: 9 lb

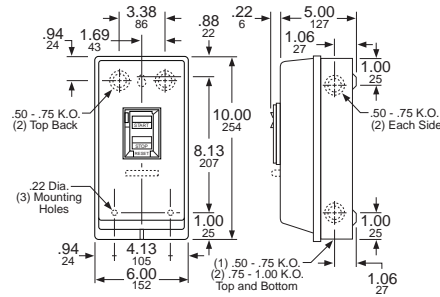
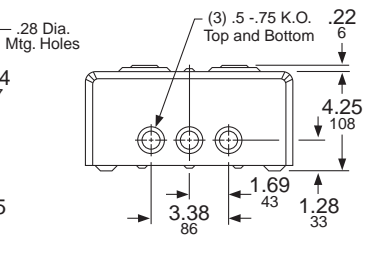

Class 2510 Type M & T Size M-1P  
NEMA 1 General Purpose Enclosure  
Approximate Shipping Weight: 5 lb

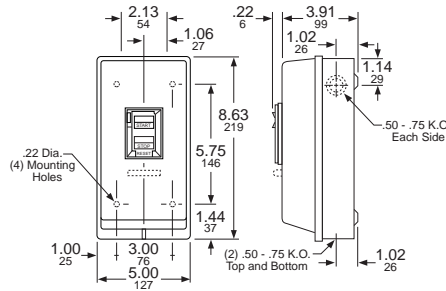

Class 2510 Types M & T Sizes M-0 and M-1  
NEMA 1 General Purpose Enclosure  
Approximate Shipping Weight: 5 lb

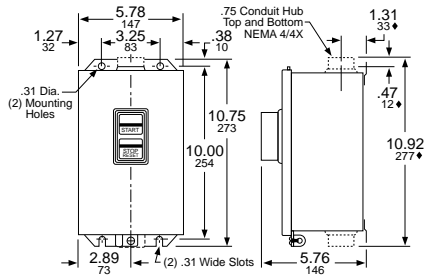

Class 2510 Type M Sizes M-0, M-1 and M-1P  
NEMA 4/4X Watertight Stainless Steel Enclosure  
NEMA 12 Dusttight Industrial Use Enclosure  
Approximate Shipping Weight: 9 lb

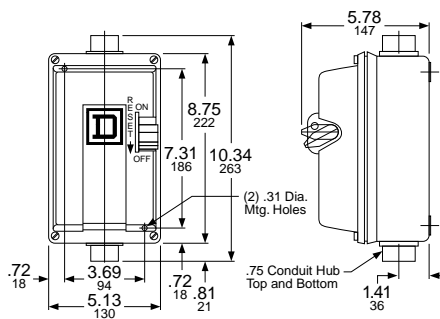

Class 2510 Type M Size M-0 (AC-DC)  
and Size M-1 (DC) NEMA 4/4X  
Watertight Corrosion-Resistant  
Glass Polyester Enclosure  
Approximate Shipping Weight—6 lb

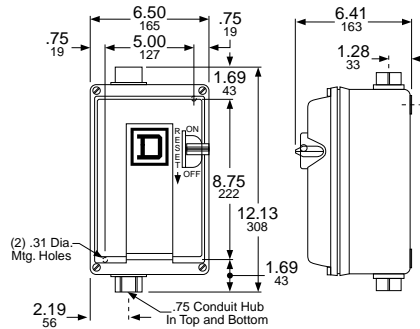

Class 2510 Type M Sizes M-1 and M-1P (AC)  
NEMA 4/4X Watertight Corrosion-Resistant  
Glass Polyester Enclosure  
Approximate Shipping Weight—6 lb

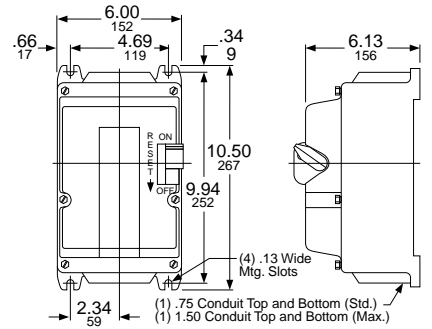

Class 2510 Type M Sizes M-0, M-1 and M-1P  
NEMA 7 & 9 Hazardous Location  
Cast Iron Enclosure  
Approximate Shipping Weight—18 lb

16 NEMA AND DEFINITE PURPOSE CONTACTORS AND STARTERS



Accessories, Modifications, and Replacement Parts

Table 16.22: P11 Pilot Light Voltage Codes

Voltage	Code
120 V	V02
200/208 V	V08
230 V	V03
460 V	V06
575 V	V07

Table 16.24: Accessories—Class 2510 Types F and K

Description	Class & Type
Handle Guard Kit with Padlock Provision [18]	2510FL1
Emergency Off Actuator	2510PB1
Additional Key for Key Operated Devices	2510FK1

Table 16.23: Modifications (Types M & T only)

Description	Factory Modifications (Forms)	Field Modification Kits, Class & Type
Red Pilot Light [14]	P11[15]	9999MP1 (110–120 V) 9999MP2 (208–240 V) 9999MP3 (440–600 V)
Auxiliary Contacts [16]	X1 (1 N.O.) X2 (1 N.C.)	9999SX11 (N.O.) 9999SX12 (N.C.)
Jumper Straps [17]	N/A	9998SO31
Contact only	Y76	N/A

Table 16.25: Pilot Light Kits—Class 2510 Types F and K

Application	Voltage	Red Pilot Light	Green Pilot Light
		Class & Type	Class & Type
Type KF, KG, KW [19]	110–120 Vac	9999PL11	9999PL11G
	208–277 Vac	9999PL12	9999PL12G
	440–600 Vac	9999PL13	9999PL13G
Type FF, FG, FW [19]	115–240 Vac/dc	9999PL10	9999PL10G

Table 16.26: Replacement Nameplates—Class 2510 Types F and K

Description	Application	Nameplate Marking	Nameplate Type Number—Class 2510			
			For Type K Switch		For Type F Starter (includes Reset Indication)	
			Without Pilot Light	With Pilot Light	Without Pilot Light	With Pilot Light
1-3/4" x 2-13/16" Nameplate with Embossed Mounting Holes for #6 Oval Head Screws	Standard commercial switch box cover or flush plate, including Square D stainless steel plates	(Blank)	FN1	—	FN2	—
		(Special marking—specify the marking desired)	FN5	—	FN6	—
1-29/32" x 3-27/32" Flat Nameplate with Mounting Holes for #6 Pan Head Screws	Square D NEMA 1 surface mounted enclosure or gray flush plate	(Blank)	FN10	FN20	FN30	FN40
		High	FN11	FN21	FN31	FN41
		Low	FN12	FN22	FN32	FN42
		Forward	FN13	—	—	—
		Reverse	FN14	FN24	—	—
		(Special marking—specify the marking desired)	FN15	FN25	FN35	FN45

Contact Kits

See page 16-124 for Class 9998 Replacement Contact Kits.

Table 16.27: Replacement Part Kits

Enclosure	Product Description	Kit Catalog No.
Replacement Toggle Kits		
NEMA 4	Type FW and KW	9998HW1
NEMA 7 & 9	Type FR and KR	9998HR2
Replacement Handle Kits		
NEMA 12	Type MBA, MCA (Ser. A & B)	9998HWA1
	Type MBA, MCA (Ser. C)	31085-381-50
NEMA 4/4X (Stainless)	Type MBW, MCW (Ser. A & B)	9998HWA1
	Type MBW, MCW (Ser. C)	31085-381-50
NEMA 4/4X (Polyester)	Type MBW (Size 0)	9998HWA1
	Type MCW (Size 1)	9998HR3
NEMA 7 and 9	Type MBR, MCR	9998HR3
Description		Kit Catalog No.
Internal Lever		9998IL1

Table 16.28: How to Order

To Order Specify:	Catalog Number	
	Class	Type
<ul style="list-style-type: none"> <li>Class Number</li> <li>Type Number</li> </ul>	9991	KE1

Table 16.29: Enclosures

For use with Class 2510 Type	Enclosure	Catalog No.
F and K	NEMA 1 Standard	9991EN1
M: Sizes M-0 & M-1		9991MG1
M: Size M-1P		9991MG2
MBO and MCO	NEMA 1 Flush Mount (with pull box and plaster adjustment)	9991MF1
	NEMA 1 Flush Mount (without pullbox but with mounting strap)	9991MF2
	NEMA 4X (Polyester)	9991MW1
	NEMA 4 (Stainless Steel)	9991MW11
FO1, FO1P, FO2, FO2P, FO3, FO3P, FO4, FO4P	NEMA 1 Oversized	9991FE1
KO1, KO1A, KO1B, KO2, KO2B, KO2C, KO3, KO3A, KO3B, KO4, KO4B, KO4C, KO5, KO5A, KO5B, KO6, KO6B, KO6C	NEMA 1 Oversized	9991KE1
	NEMA 1 Jumbo	9991KE2
	NEMA 3R	9991KE3

[14] May only be field-added to NEMA 1 enclosures. For green pilot light, order 9999SPG1 additionally.

[15] Form P11 pilot lights require a voltage code. Refer to Table 16.22. Catalog number example: 2510MBG1V02P11.

[16] For proper operation, only one auxiliary contact kit per device may be added.

[17] Used to control a single phase motor utilizing a three phase starter.

[18] Standard on Type K devices.

[19] The lens cannot be replaced. The pilot light kits for NEMA 4 enclosed units are for replacement only.

For detailed information about TeSys U, visit [www.schneider-electric.com/us](http://www.schneider-electric.com/us).



Power Base

16 NEMA AND DEFINITE PURPOSE CONTACTORS AND STARTERS

### TeSys U Selection

The NEMA style TeSys U motor starter is an integrated product—simple to choose and to install—consisting of a control unit snapped into a power base. TeSys U can be configured to fit specific applications as well. The NEMA style TeSys U starter uses the same optional accessories—reverser, current limiter, predictive maintenance options, and communication options—as the IEC TeSys U.

#### Selecting a NEMA TeSys U Motor Starter in Three Steps



Table 16.30: Step 1. Select Power Base

Control Connection	NEMA Size	Max. hp, Three Phase				Max. hp, Single Phase		Power Bases Catalog Number
		200/208 V	220/240 V	460 V	575/600 V	120 V	240 V	
With screw terminations	1	7.5	7.5	10	10	2	3	LUB32NR

Table 16.31: Voltage Codes

Volts	24	48–72	110–240
DC	BL <sup>[1]</sup>	—	—
AC	B	—	—
DC or AC	—	ES <sup>[2]</sup>	FU

Table 16.32: Step 2. Select Control Unit <sup>[3]</sup>

Setting Range A	Standard 3-phase Class 10 trip <sup>[4]</sup>	Advanced 3-Phase Class 10 trip <sup>[4]</sup>	Advanced Single-Phase Class 10 trip <sup>[4]</sup>	Advanced 3-Phase Class 20 trip <sup>[4]</sup>
0.15–0.6	LUCAX6**	LUCBX6**	LUCCX6**	LUCDX6**
0.3–1.4	LUCA1X**	LUCB1X**	LUCC1X**	LUCD1X**
1.25–5.0	LUCA05**	LUCB05**	LUCC05**	LUCD05**
3–12	LUCA12**	LUCB12**	LUCC12**	LUCD12**
4.5–18	LUCA18**	LUCB18**	LUCC18**	LUCD18**
8–32	LUCA32**	LUCB32**	LUCC32**	LUCD32**

Table 16.33: Step 3. Select Auxiliary Contacts (optional)

Terminals	Contact Indicates	Normal Contact Status	Auxiliary Contact Blocks Contact State for Each Mode <sup>[5]</sup>						Catalog Number
			Off	Ready	Run	Short Circuit Trip	Overload Trip (Manual Reset)	Overload Trip (Remote/Auto Reset) <sup>[6]</sup>	
			Screw	Ready condition	N.O.	O	I	I	
Screw	Fault condition	N.C.	I	I	I	O	O	I	
Screw	Ready condition	N.O.	O	I	I	O	O	I	LUA1C20
Screw	Fault condition	N.O.	O	O	O	I	I	O	



Control Unit



Auxiliary Contact

Table 16.34: TeSys U Auxiliary Contact Function Modules

Terminals	Contact Indicates	Normal Contact Status	Catalog Number
Screw	Power pole status	2 N.O.	LUFN20
Screw	Power pole status	1 N.O. and 1 N.C.	LUFN11
Screw	Power pole status	2 N.C.	LUFN02

Table 16.35: TeSys U Accessories

Accessories for LUB32NR	Quick Description	For details and selection, see pages:
Current limiter	Increases the breaking capacity to 130kA @ 460 V	18-25
Reverser	Stacked or side mounted (LU6MB0** <sup>[4]</sup> only)	18-25
Line phase barrier	Required for use as a self-protected combination starter (UL508 Type E)	18-25
Multifunction control unit	Has functions for monitoring and predictive maintenance	18-25
Function modules	Fault differentiation, thermal overload, motor load indication	18-25
Communication modules	Integrates into existing networks, major protocols available	18-26
Soft starter + TeSys U	Use Altistart U01Soft Starter with TeSys U	18-42
Power bus bars	TeSys U cabling accessory	18-26
Control circuit accessories	Control circuit contact block, external handles, and control circuit filters	18-26

Accessories and Dimensions: See Section 18.



E164862  
CCN NLDX



LR43364  
Class 3211 08



<sup>[1]</sup> DC voltage with range of 0.90 to 1.10 of nominal.

<sup>[2]</sup> 48–72 Vdc; 48 Vac.

<sup>[3]</sup> The control unit contains solid-state overload relay and control power source for TeSys U. For more details on the different control units, their functions, and placement on the power base see Section 18.

<sup>[4]</sup> Complete the catalog number by adding the appropriate voltage code from Table 16.31. For example: LUCAX6FU.

<sup>[5]</sup> I = closed contact; O = open contact.

<sup>[6]</sup> Requires a multifunction or advanced control unit, plus fault differentiation module LUFDDA10.

**Interpreting the Catalog Number**

**Table 16.36: TeSys N Catalog Numbering System**

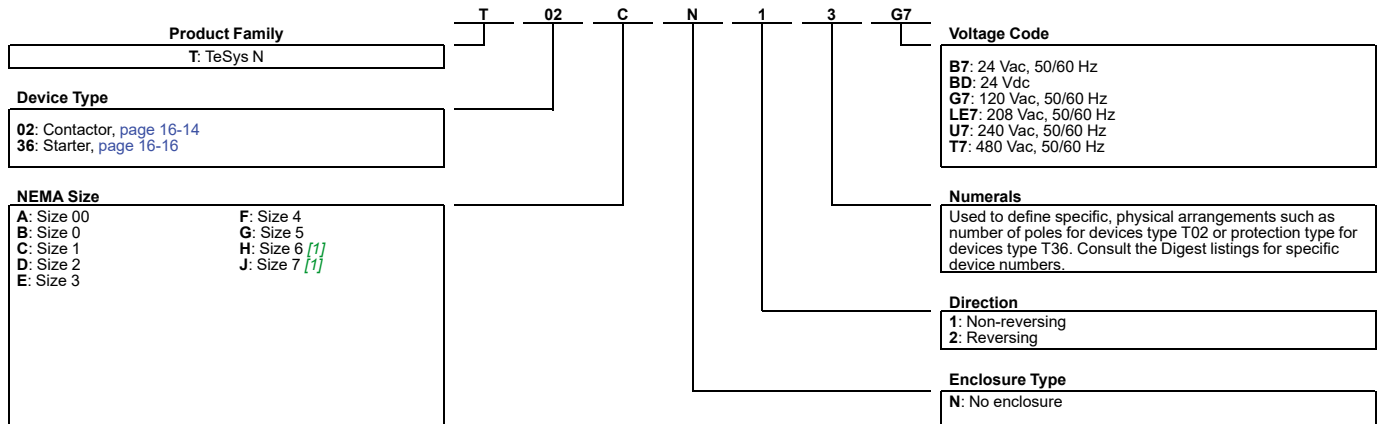

[1] Not available for reversing Type T36 devices.



TeSys N non-reversing contactor, Size 1



TeSys N non-reversing contactor, Size 3

New!

**TeSys N Non-Reversing Contactors**

TeSys N contactors are used to switch heating loads, capacitors, transformers and electric motors where overload protection is provided separately. TeSys N contactors are available in NEMA Sizes 00–7. Target market segments include hospitals; retail; food and beverage; marine; oil and gas; and mining, metals, and minerals.

**Table 16.37: TeSys N Non-Reversing Contactors, 3-Pole Polyphase, 600 Vac Max. (replace ●● with the coil voltage code)**

NEMA Size	Continuous Current Rating (A)	Motor Voltage	Max HP	Open
				Catalog No. [2]
00	9	200	1.5	T02AN13●●
		230	1.5	
		460	2	
		575	2	
0	18	200	3	T02BN13●●
		230	3	
		460	5	
		575	5	
1	27	200	7.5	T02CN13●●
		230	7.5	
		460	10	
		575	10	
2	45	200	10	T02DN13●●
		230	15	
		460	25	
		575	25	
3	90	200	25	T02EN13●●[3]
		230	30	
		460	50	
		575	50	
4	135	200	40	T02FN13●●[3]
		230	50	
		460	100	
		575	100	
5	270	200	75	T02GN13●●[3]
		230	100	
		460	200	
		575	200	
6	540	200	150	T02HN13●●[3]
		230	200	
		460	400	
		575	400	
7	810	200	—	T02JN13●●[3]
		230	300	
		460	600	
		575	600	

**Table 16.38: TeSys N Non-Reversing Contactors, 3-Pole Single Phase, 600 Vac Max.**

(replace ●● with the coil voltage code)

NEMA Size	Continuous Current Rating (A)	Motor Voltage	Max HP	Open
				Catalog Number
00	9	115	1/3	T02AN13●●
		230	1	
0	18	115	1	T02BN13●●
		230	2	
1	27	115	2	T02CN13●●
		230	3	
2	45	115	3	T02DN13●●
		230	7.5	

**Table 16.39: TeSys N Coil Voltage Codes**

Voltage	Voltage Code by NEMA Size								
	Size 00	Size 0	Size 1	Size 2	Size 3	Size 4	Size 5	Size 6	Size 7
24 Vac	B7	B7	B7	B7	B6	B6			n/a
24 Vdc	BD	BD	BD	BD	BD	BD			n/a
120 Vac	G7	G7	G7	G7	G7	G7	G7	F7	F7
208 Vac	LE7	LE7	LE7	LE7	L7	L7	L7	L7	L7
240 Vac	U7	U7	U7	U7	U7	U7	U7	U7	U7
480 Vac	T7	T7	T7	T7	S7	S7	S7	N7	N7

Dimensions: [page 16-23 to page 16-27](#)  
 Accessories: [page 16-18 to page 16-21](#)  
 Replacement Parts: [page 16-22](#)  
 Lugs: [page 16-21](#)

[2] Replace the bullets (●●) in the catalog number with the coil voltage code. Refer to voltage codes shown in [Table 16.39](#).  
 [3] Order lugs separately. See . The mounting hardware (screws, washers, and nuts) comes with the contactors, not the lugs. Starters Sizes 3–7 come with lugs.

*New!*

**TeSys N Reversing Contactors**

TeSys N reversing contactors are used for starting, stopping and reversing AC motors where overload protection is provided separately. TeSys N reversing contactors are mechanically and electrically interlocked and are available in NEMA Sizes 00–7. Target market segments include hospitals; retail; food and beverage; marine; oil and gas; and mining, metals, and minerals.



TeSys N reversing contactor, Size 00



TeSys N reversing contactor, Size 4

**Table 16.40: TeSys N Reversing Contactors, 3-Pole Polyphase, 600 Vac Max.**  
(replace ●● with the coil voltage code)

NEMA Size	Continuous Current Rating (A)	Motor Voltage	Max HP	Open
				Catalog No. [4]
00	9	200	1.5	T02AN23●●
		230	1.5	
		460	2	
		575	2	
0	18	200	3	T02BN23●●
		230	3	
		460	5	
		575	5	
1	27	200	7.5	T02CN23●●
		230	7.5	
		460	10	
		575	10	
2	45	200	10	T02DN23●●
		230	15	
		460	25	
		575	25	
3	90	200	25	T02EN23●●[5]
		230	30	
		460	50	
		575	50	
4	135	200	40	T02FN23●●[5]
		230	50	
		460	100	
		575	100	
5	270	200	75	T02GN23●●[5]
		230	100	
		460	200	
		575	200	
6	540	200	150	T02HN23●●[5]
		230	200	
		460	400	
		575	400	
7	810	200	—	T02JN23●●[5]
		230	300	
		460	600	
		575	600	

**Table 16.41: TeSys N Reversing Contactors, 3-Pole Single Phase, 600 Vac Max.**  
(replace ●● with the coil voltage code)

NEMA Size	Continuous Current Rating (A)	Motor Voltage	Max HP	Open
				Catalog No. [4]
00	9	115	1/3	T02AN23●●
		230	1	
0	18	115	1	T02BN23●●
		230	2	
1	27	115	2	T02CN23●●
		230	3	
2	45	115	3	T02DN23●●
		230	7.5	

**Table 16.42: TeSys N Coil Voltage Codes**

Voltage	Voltage Code by NEMA Size								
	Size 00	Size 0	Size 1	Size 2	Size 3	Size 4	Size 5	Size 6	Size 7
24 Vac	B7	B7	B7	B7	B6	B6	n/a		
24 Vdc	BD	BD	BD	BD	BD	BD	n/a		
120 Vac	G7	G7	G7	G7	G7	G7	G7	F7	F7
208 Vac	LE7	LE7	LE7	LE7	L7	L7	L7	L7	L7
240 Vac	U7	U7	U7	U7	U7	U7	U7	U7	U7
480 Vac	T7	T7	T7	T7	S7	S7	S7	N7	N7

Dimensions: [page 16-23](#) to [page 16-27](#)  
 Accessories: [page 16-18](#) to [page 16-21](#)  
 Replacement Parts: [page 16-22](#)  
 Lugs: [page 16-21](#)

[4] Replace the bullets (●●) in the catalog number with the coil voltage code. Refer to the voltage codes shown in [Table 16.42](#).  
 [5] Order lugs separately. See . The mounting hardware (screws, washers, and nuts) comes with the contactors, not the lugs. Starters Sizes 3–7 come with lugs.

New!

TeSys N Non-Reversing Starters

TeSys N starters are used for full-voltage starting and stopping of AC squirrel-cage motors. Starters are available in NEMA Sizes 00–7 and come standard with Motor Logic Class 10/20 selectable solid-state overload relays. Starters with bimetal overload protection can be assembled from TeSys N contactors and TeSys D overload relays.



TeSys N non-reversing starter, Size 1



TeSys N Size 1 Contactor + TeSys LRD Bimetallic Overload Relay



TeSys N non-reversing starter, Size 3



TeSys N Size 1 Contactor + TeSys LR9D Electronic Overload Relay

For more information on TeSys D relays, see Section 18.

Dimensions: page 16-23  
TeSys N Accessories: pages 16-18

Table 16.43: 3-Pole Polyphase, 600 Vac Max. (replace ●● with the coil voltage code)

NEMA Size	Continuous Current Rating (A)	Motor Voltage	Max HP	Open
				Catalog No. [6]
00	9	200	1.5	T36AN13●●
		230	1.5	
		460	2	
		575	2	
0	18	200	3	T36BN13●●
		230	3	
		460	5	
		575	5	
1 [7]	27	200	7.5	T36CN13●●
		230	7.5	
		460	10	
		575	10	
2	45	200	10	T36DN13●●
		230	15	
		460	25	
		575	25	
3	90	200	25	T36EN13●●
		230	30	
		460	50	
		575	50	
4	135	200	40	T36FN13●●
		230	50	
		460	100	
		575	100	
5	270	200	75	T36GN13●●
		230	100	
		460	200	
		575	200	
6	540	200	150	T36HN13●●
		230	200	
		460	400	
		575	400	
7	810	200	—	T36JN13●●
		230	300	
		460	600	
		575	600	

Table 16.44: TeSys N Coil Voltage Codes

Voltage	Voltage Code by NEMA Size								
	Size 00	Size 0	Size 1	Size 2	Size 3	Size 4	Size 5	Size 6	Size 7
24 Vac [8]	B7	B7	B7	B7	B6	B6	—	—	—
24 Vdc [9]	BD	BD	BD	BD	BD	BD	—	—	—
120 Vac [8]	G7	G7	G7	G7	G7	G7	G7	F7	F7
208 Vac	LE7	LE7	LE7	L7	L7	L7	L7	L7	L7
240 Vac	U7	U7	U7	U7	U7	U7	U7	U7	U7
480 Vac	T7	T7	T7	T7	S7	S7	S7	N7	N7

Table 16.45: TeSys LR9D Electronic Overload Relays

Current Setting Range (A)	For Direct Mounting to TeSys N Contactors	Class 5/10/20/30 Selectable
0.1–0.5	Size 00–1	LR9D01
0.4–2.0		LR9D02
1.6–8.0		LR9D08
6.4–32		LR9D32

Table 16.46: TeSys D Overload Relays—Ambient Compensated, Bimetallic, Direct Mounting

Current Setting Range (A)	For Direct Mounting to TeSys N Contactors	Class 10 with Single-Phase Sensitivity	Class 10 without Single-Phase Sensitivity	Class 20 with Single-Phase Sensitivity	Class 20 without Single-Phase Sensitivity
0.10–0.16	Size 00–1	LRD01	LR3D01	—	—
0.16–0.25	Size 00–1	LRD02	LR3D02	—	—
0.25–0.40	Size 00–1	LRD03	LR3D03	—	—
0.40–0.63	Size 00–1	LRD04	LR3D04	LRD04L	LR3D04L
0.63–1	Size 00–1	LRD05	LR3D05	LRD05L	LR3D05L
1–1.6	Size 00–1	LRD06	LR3D06	LRD06L	LR3D06L
1.6–2.5	Size 00–1	LRD07	LR3D07	LRD07L	LR3D07L
2.5–4	Size 00–1	LRD08	LR3D08	LRD08L	LR3D08L
4–6	Size 00–1	LRD10	LR3D10	LRD10L	LR3D10L
5.5–8	Size 00–1	LRD12	LR3D12	LRD12L	LR3D12L
7–10	Size 00–1	LRD14	LR3D14	LRD14L	LR3D14L
9–13	Size 0–1	LRD16	LR3D16	LRD16L	LR3D16L
12–18	Size 0–1	LRD21	LR3D21	LRD21L	LR3D21L
16–24	Size 0–1	LRD22	LR3D22	—	—
17–24	Size 0–1	—	—	LRD22L	LR3D22L
23–32	Size 1	LRD32	LR3D32	LRD32L	LR3D32L
9–13	Size 2	LRD313	LR3D313	LRD313L	—
12–18	Size 2	LRD318	LR3D318	LRD318L	—
16–25	Size 2	LRD325	LR3D325	LRD325L	—
23–32	Size 2	LRD332	LR3D332	LRD332L	—
30–40	Size 2	LRD340	LR3D340	LRD340L	—
37–50	Size 2	LRD350	LR3D350	LRD350L	—

[6] Replace the bullets (●●) in the catalog number with the coil voltage code. Refer to the coil voltage codes shown in Table 16.44.  
 [7] Special size combinations of the contactor and Motor Logic overload relay are available. Add 0 to the catalog number before the coil voltage for a Size 0 overload relay (6–18 A); 9 for a Size 00C (3–9 A); and 8 for a Size 00B (1.5–4.5 A)—for example, T36CN130G7.  
 [8] The 24 and 120 Vac coils are available with optional separate control; add Form S to the catalog number (for example, T36AN13B7S).  
 [9] The 24 Vdc coil requires separate control; add Form S to the catalog number (for example, T36AN13BDS).

*New!*

**TeSys N Reversing Starters**

TeSys N reversing starters are used for full-voltage starting, stopping, and reversing of AC squirrel cage motors. Reversing starters are mechanically and electrically interlocked and are available in NEMA Sizes 00 through 5. Starters come with Motor Logic Class 10/20 selectable solid-state overload relays as standard. Reversing starters with bimetal overload protection can be assembled from TeSys N reversing contactors and TeSys D overload relays. For more information on TeSys D overload relays, see Section 18.



TeSys N reversing starter, Size 00



TeSys N reversing starter, Size 4

**Table 16.47: TeSys N Reversing Starters, 3-Pole Polyphase, 600 Vac Max. (replace ●● with the coil voltage code)**

NEMA Size	Continuous Current Rating (A)	Motor Voltage	Max HP	Open
				Catalog No. [10]
00	9	200	1.5	T36AN23●●
		230	1.5	
		460	2	
		575	2	
0	18	200	3	T36BN23●●
		230	3	
		460	5	
		575	5	
1[11]	27	200	7.5	T36CN23●●
		230	7.5	
		460	10	
		575	10	
2	45	200	10	T36DN23●●
		230	15	
		460	25	
		575	25	
3	90	200	25	T36EN23●●
		230	30	
		460	50	
		575	50	
4	135	200	40	T36FN23●●
		230	50	
		460	100	
		575	100	
5	270	200	75	T36GN23●●
		230	100	
		460	200	
		575	200	

**Table 16.48: TeSys N Coil Voltage Codes**

Voltage	Voltage Code by NEMA Size						
	Size 00	Size 0	Size 1	Size 2	Size 3	Size 4	Size 5
24 Vac [12]	B7	B7	B7	B7	B6	B6	n/a
24 Vdc [13]	BD	BD	BD	BD	BD	BD	n/a
120 Vac [12]	G7	G7	G7	G7	G7	G7	G7
208 Vac	LE7	LE7	LE7	LE7	L7	L7	L7
240 Vac	U7	U7	U7	U7	U7	U7	U7
480 Vac	T7	T7	T7	T7	S7	S7	S7

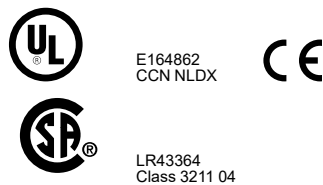

Dimensions: [page 16-23](#) to [page 16-27](#)  
 Accessories: [page 16-18](#) to [page 16-21](#)  
 Replacement Parts: [page 16-22](#)  
 Lugs: [page 16-21](#)

16 NEMA AND DEFINITE PURPOSE CONTACTORS AND STARTERS

[10] Replace the bullets (●●) in the catalog number with the coil voltage code. Refer to the coil voltage codes shown in [Table 16.48](#).  
 [11] Special size combinations of the contactor and Motor Logic overload relay are available. Add **0** to the catalog number before the coil voltage for Size 0 overload relays (6–18 A); **9** for Size 00C (3–9 A); and **8** for Size 00B (1.5–4.5 A)—for example, T36CN230G7.  
 [12] The 24 and 120 Vac coils are available with optional separate control; add **Form S** to the catalog number (for example, T36AN13B7S).  
 [13] The 24 Vdc coil requires separate control; add **Form S** to the catalog number (for example, T36AN23BDS).



Front Mounted Auxiliary Blocks

**Auxiliary Contacts, Time Delay, Mechanical Latch**

**Table 16.49: Standard, Instantaneous Auxiliary Contact Blocks**

Snap-On Mounting	Number of Contacts	Composition		Catalog Number
		N.O.	N.C.	
To front of Size 00-2 or To right side of Size 3-7	4	2	2	LADN22 [14]
		1	3	LADN13 [14]
		4	0	LADN40 [14]
		0	4	LADN04 [14]
		3	1	LADN31 [14]
	2 [15]	2 [15]	LADC22 [15]	
	2	1	1	LADN11 [14]
		2	0	LADN20 [14]
		0	2	LADN02 [14]
	To left side of Size 3-7	1	1	0
				LADN01
To side of Size 00-2	2	1	1	LAD8N11 [16]
		2	0	LAD8N20 [16]

**Table 16.50: Instantaneous Blocks with Dust-Tight Auxiliary Contacts (IP54)**

**NEMA 12**

Snap-On Mounting	Standard Contacts		Dust-Tight Contacts		Catalog Number
	N.O.	N.C.	N.O.	N.C.	
To front of Size 00-2 or To right side of Size 3-7	—	—	2	—	LA1DX20
	2	—	2	—	LA1DZ40
	1	1	2	—	LA1DZ31
	—	—	2	—	LA1DY20 [17]

**Table 16.51: Pneumatic Time Delay Contact Blocks**

Snap-On Mounting	Time Delay Contacts		Type	Range of Time Delay	Catalog Number [18]
	N.O.	N.C.			
To front of Size 00-2 or To right side of Size 3-7	1	1	On energization (on delay)	0.1 to 3 s [19]	LADT0
				0.1 to 30 s	LADT2
				10 to 180 s	LADT4
	1	1	On de-energization (off-delay)	1 to 30 s [20]	LADS2
				0.1 to 3 s [19]	LADR0
				0.1 to 30 s	LADR2
			10 to 180 s	LADR4	

**Table 16.52: Mechanical Latch Blocks with Manual or Electrical Unlatch**

Front snap-on mounting onto	Application	Catalog Number
Size 00-2	For silent operation and energy conservation	LAD6K10 [21][22]

**Table 16.53: Coil Voltage Codes for LA6DK Mechanical Latch Blocks**

Volts	24	120	208	240	480
AC or DC [23]	B	F	L	M	R

[14] For spring terminal versions of these blocks, add a **3** to the end of the catalog number (for example, LADN223). For slip-on versions, add **9** to the end of the catalog number (for example, LADN229).

[15] Including 1 N.O. + 1 N.C. make-before-break overlapping contacts.

[16] 1 block may be added to the left side of Size 00-1, AC coils only; only 1 block may be added to either side of the Size 2 contactor, AC coil only. Cannot be installed on Size 00-2 contactors with DC coils.

[17] Device comes with 4 ground terminal points.

[18] For spring terminal versions of these blocks, add a **3** to the end of the catalog number (for example, LADT23). There is no charge for this modification.

[19] Scale range is expanded between 0.1 and 0.6 seconds on the dial for more accurate settings at the lower end of the range.

[20] Switching time between the opening of the N.C. contact and the closing of the N.O. contact: 40 ms ± 15 ms.

[21] Complete the catalog number by adding the coil voltage code (for example, LAD6K10F).

[22] Does not include internal coil clearing contact.

[23] DC available at 24 V only.



**TeSys™ N Reversing Contactors: Field Assembly**

**Table 16.54: Contactors**

For assembly of reversing contactors comprising two identical, horizontally mounted contactors without common baseplate:	Mechanical interlock		Set of power connections
	Without electrical interlock	With incorporated electrical interlock (2 N. C. contacts)	Reversing contactors for motor control
	Catalog Number <a href="#">LAD9R1 [24]</a>	Catalog Number <a href="#">LAD9R1V [24]</a>	Catalog Number Included with kit
Size 00-1			
	Catalog Number <a href="#">LAD4CM</a> <a href="#">LAD9R3 [25]</a>	Catalog Number — —	Catalog Number <a href="#">LA9D65A69</a> —
LC1D40A, D50A, D65A			
Reversing contactors comprising two identical, horizontally mounted contactors			
	Catalog Number	Catalog Number	Catalog Number
Size 3		—	<a href="#">LA9FF976</a>
Size 4	<a href="#">LA9FF970</a>	—	<a href="#">LA9F15076</a>
Size 5		—	<a href="#">LA9FJ976</a>
Size 6	<a href="#">LA9FJ970</a>	—	<a href="#">LA9FK976</a>
Size 7	<a href="#">LA9FL970</a>	—	<a href="#">LA9FL976</a>
	<a href="#">LA9F•970</a>		<a href="#">LA9F•976</a>

[24] Kit including mechanical interlock and wiring.  
[25] Kit combines both LAD4CM and LA9D65A69



LA4DA1U

## Coil Suppressors and Cabling Accessories

### RC Coil Suppressor

- Transient voltage limited to 300% of nominal voltage, maximum.
- Oscillating frequency is limited to 400 Hz maximum. Slight increase in drop-out time (1.2 to 2 times normal).

**Table 16.55: Resistor/Capacitor Circuit (RC) for Reduction of Electrical Noise in AC Contactor Coils**

Installed by	Mounting on	Operating Voltage 50/60 Hz	Catalog Number
Snapping into the cavity on the right side without tools [26]	Size 00–1	24 V	LAD4RCE
		120 V	LAD4RCG
		120–240 V	LAD4RCU
Snap-on mounting, and connection without tools to the contactor coil terminals	Size 2	24 V	LAD4RC3E
		120 V	LAD4RC3G
		120–240 V	LAD4RC3U

### Varistor Coil Suppressor

- Transient voltage value limited to 200% of nominal voltage, maximum.
- Maximum reduction of transient voltage peaks. Slight increase in drop-out time (1.1 to 1.5 times normal).

**Table 16.56: Varistor (Peak Limiting) for Reduction of Electrical Noise in AC Contactor Coils**

Installed by	Mounting on	Operating Voltage 50/60 Hz	Catalog Number
Snapping into the cavity on the right side without tools [26]	Size 00–1	24 V	LAD4VE
		120 V	LAD4VG
		120–240 V	LAD4VU
Snap-on mounting, and connection without tools to the contactor coil terminals	Size 2	24 V	LAD4V3E
		120 V	LAD4V3G
		120–240 V	LAD4V3U

### Diode Coil Suppressor

- No overvoltage or oscillating frequency.
- Polarized component. Increased drop-out time (6–10 times normal).

**Table 16.57: Diode for Reduction of Electrical Noise in DC Contactor Coils**

Installed on the upper part by	Mounting on	Operating Voltage, DC	Catalog Number
Snap-on mounting and connection w/o tools to the contactor coil terminals	Size 00–1	24 Vdc	LAD4DDL
Clip-on front mounting	Size 2	24 Vdc	LAD4D3U



LAD4T3B

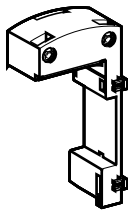

LAD4BB

### Bidirectional Diode Coil Suppressor

- Protection provided by limiting the transient voltage to 2 Uc max.
- Maximum reduction of transient voltage peaks.

**Table 16.58: Bidirectional Peak Limiting Diode**

Installed by	Mounting on	Operating Voltage 50/60 Hz and DC	Catalog Number
Snapping into the cavity on the right side of the contactor [26]	Size 00–1 [27]	24 (AC only)	LAD4TB
Clip-on front mounting and connection without tools to the contactor coil terminals [27]	Size 2	24 V	LAD4T3B
		120 V	LAD4T3G
		208–240 V	LAD4T3U

## TeSys N Cabling Accessories

**Table 16.59: Cabling Accessories**

Usage	Mounting on	Operating Voltage 50/60 Hz	Catalog Number	
For adapting existing wiring to a new product or for use with top-mounting accessory.	Size 00–1, AC only	Without coil suppression	LAD4BB	
		With coil suppression (varistor)	24 V	LAD4BBVE
			120 V	LAD4BBVG
For adapting existing wiring to a new product or for use with top-mounting accessory	Size 2, AC only	120–240 V	LAD4BBVU	
		—	LAD4BB3	

[26] Installing the suppressor into the cavity makes the electrical connection. The overall width of the contactor remains the same.

[27] For Size 00–2 with DC coils, 3-pole contactors are fitted with built-in bidirectional diode suppression as standard.

### Electronic Timers and Interface Modules

The following accessories require use of cabling accessories (LAD4BB●●) for proper mounting. See page 16-20 for illustration.

The solid-state **Electronic Serial Timer Modules** in Table 16.60 delay the energizing of the contactor coil, and feature built-in varistor surge suppression.

**Table 16.60: Electronic Serial Timer Modules**

Type	Operational Voltage 24–250 Vac	Time Delay	Catalog Number
On-delay	Size 00–2	0.1–2 s	LA4DT0U
		1.5–30 s	LA4DT2U
		25–500 s	LA4DT4U

The **Interface Modules** in Table 16.61 allow the contactor coils to be energized from low voltage and low current level signals. They come in mechanical relay and solid-state versions. The relay plus manual operation versions include a lever for manually turning the contactor on and off. When a module receives a low-level signal, it allows the separate-sourced control voltage to flow to the contactor coil. It saves space and wiring time compared to conventional interposing relays.

**Table 16.61: Interface Modules [28]**

Interface Type	Operational Voltage 24–250 Vac	Input Voltage	Catalog Number
Relay	Size 00–2	24 Vdc	LA4DFB
Relay Plus Manual Operation	Size 00–2	24 Vdc	LA4DLB
Solid State	Size 00–2	24 Vdc	LA4DWB

**Table 16.62: Lugs and Lug Kits [29]**

TeSys N Contactor	Lugs		Lug Kits[30]	Cable size AWG range
	Line Size	Load Side		
Size 3	3 each DZ2FF1	3 each DZ2FF1	DZ2FF6	14 to 2/0
Size 4	3 each DZ2FG1	3 each DZ2FG1	DZ2FG6	6 to 3/0
Size 5	3 each DZ2FJ1	3 each DZ2FJ1	DZ2FJ6	4 to 500 MCM
Size 6	3 each DZ2FK1	3 each DZ2FK1	DZ2FK6	2 x 2 to 600 MCM
Size 7	1 each DZ2FL1 DZ2FL2 DZ2FL3	1 each DZ2FL1 DZ2FL2 DZ2FL3	DZ2FL6	3 x 2 to 600 MCM

**Table 16.63: TeSys Safety-Chain Identification System**

Description	Compatibility	Package Qty	Catalog Number
Red retrofit contactor safety cover	Size 00–2	10	LAD9ET1S
Red auxiliary contact block, 2 N.O. + 2 N.C.	Size 00–2	1	LADN22S



LA4DFB



LAD9ET1S



LADN22S

[28] Adapter required. See Table 16.59.

[29] The mounting hardware (screws, washers, and nuts) comes with the contactors, not the lugs. Starters Sizes 3–7 come with lugs.

[30] Lug kits include 6 lugs.

## Replacement Contacts and Coils

Table 16.64: Replacement Contact Sets [31]

For use on contactors	Number of Poles	Catalog Number
Size 3–4	3 poles	LA5FF431
Size 5	3 poles	LA5F400803
Size 6	3 poles	LA5F500803
Size 7	3 poles	LA5F630803

## TeSys N Magnet Coils

Table 16.65: Size 00–1 AC Coils

Rated Nominal Voltage	Catalog Number 50/60 Hz
24	LXD1B7
32	LXD1C7
36	LXD1CC7
42	LXD1D7
48	LXD1E7
60	LXD1EE7
100	LXD1K7
110	LXD1F7
115	LXD1FE7
120	LXD1G7
127	LXD1FC7
200	LXD1L7
208	LXD1LE7
220/230	LXD1M7
230	LXD1P7
230/240	LXD1U7
277	LXD1W7
380/400	LXD1Q7
400	LXD1V7
415	LXD1N7
440	LXD1R7
480	LXD1T7
575	LXD1SC7
600	LXD1X7
Specifications	50/60 Hz
Average consumption - Inrush (inductance 0.75) - Sealed (inductance 0.3)	70 VA 7 VA
Operating range@ 60 °C	50 Hz: 80–110% of nominal 60 Hz: 85–110% of nominal

Table 16.66: Size 2 AC Coils

Rated Nominal Voltage V	Catalog Number 50/60 Hz
24	LXD3B7
32	LXD3C7
42	LXD3D7
48	LXD3E7
100	LXD3K7
110	LXD3F7
115	LXD3FE7
120	LXD3G7
127	LXD3FC7
200	LXD3L7
208	LXD3LE7
220	LXD3M7
230	LXD3P7
240	LXD3U7
277	LXD3W7
380	LXD3Q7
400	LXD3V7
415	LXD3N7
440	LXD3R7
480	LXD3T7
500	LXD3S7
575	LXD3SC7
600	LXD3X7
Specification	50/60 Hz
Average consumption: - Inrush (inductance 0.3) - Sealed (inductance 0.3)	140 VA (inductance: 0.9) 7.5 VA (inductance: 0.9)
Operating range at $\theta < 55\text{ °C} / 131\text{ °F}$	80–115% of nominal voltage

Table 16.67: Size 3–7 AC Coils

Contactor Size	Hz	Catalog Number	Catalog Number Suffix [32]												
			24 V	48 V	110 V	120 V	208 V	220 V	240 V	277 V	380 V	415 V	440 V	480 V	600 V
Size 3–4	40–400	LX9FF	— [33]	048	110	127	200	220	240	280	380	415	415	500	— [33]
Size 5	40–400	LX1FH	0242	0482	1102	1272	2002	2202	2402	2772	3802	3802	4402	5002	6002
Size 6 [34]	40–400	LX1FK	—	048	110	110	200	220	240	280	380	415	415	415	600
Size 7 [34]	40–400	LX1FL	—	048	110	110	200	220	240	260	380	415	415	415	600

Table 16.68: Size 3–4 DC Coils

Device Type	Catalog Number	Catalog Number Suffix [35]										
		24 V	36 V	48 V	60 V	72 V	110 V	125 V	220 V	250 V	440 V	
Size 3–4	LX4FF	024	035	048	060	070	110	125	220	250	440	

[31] Provided per pole: 2 fixed contacts, 1 movable contact, 2 deflectors, 1 backplate, and the mounting screws and washers.

[32] Complete the catalog number by adding the suffix (for example, LX9FF020).

[33] LX1FF020 and LC1FF475 coils will be available for replacement only.

[34] The 600 V coils for Sizes 6 and 7 do not include an auxiliary contact for holding circuits. If required, select the appropriate contacts from page 16-18.

[35] Complete the catalog number by adding the suffix (for example, LX4FF024).

**TeSys™ N Non-Reversing Contactors**

**Table 16.69: TeSys N Contactors, Size 00–1, Non-Reversing [36]**

Dimensional Diagram	Dimension	Description	Dimensions			
			AC Coil		DC Coil	
			in.	mm	in.	mm
	b	Without add-on accessories	3.35	85	3.35	85
	b1	With LAD4BB	3.86	98	n/a	n/a
		With LA4D*2	4.49	114	n/a	n/a
		With LA4DF, DT	4.84	123	n/a	n/a
		With LA4DR, DW, DL	5.12	130	n/a	n/a
	c	Without cover or add-on blocks	3.54	90	3.90	99
		With cover, without add-on blocks	3.62	92	3.98	101
	c1	With LADN or LADC	4.84	123	5.20	132
	c2	With LAD6K10	5.31	135	5.67	144
	c3	With LADT, R, S	5.63	143	5.98	152
With LADT, R, S and sealing cover		5.79	147	6.14	156	

**Table 16.70: TeSys N Contactors, Size 2, Non-Reversing [36]**

Dimensional Diagram	Dimension	Description	Dimensions	
			AC or DC Coils	
			in.	mm
	a	Contactors	2.17	55
	b1	With LA4 DB3 or LAD 4BB3	5.35	136
		With LA4 DF, DT	6.18	157
		With LA4 DM, DW, DL	6.54	166
	c	Without cover or add-on blocks	4.65	118
		With cover, without add-on blocks	4.72	120
	c1	With LAD N or C (2 or 4 contacts)	5.91	150
	c2	With LAD 6K10 or LA6 DK	6.42	163
	c3	With LAD T, R, S	6.73	171
		With LAD T, R, S and sealing cover	6.89	175

**Table 16.71: TeSys N Contactors, Size 3–7, Non-Reversing**

Dimensional Diagram, Size 3–5	Dimension	Dimensions					
		T02EN13		T02FN13		T02GN13	
		in.	mm	in.	mm	in.	mm
	a	6.4	163.5	6.4	163.5	8.4	213
	P	1.5	37	1.6	40	1.9	48
	Q	1.2	29.5	1	26	1.7	43
	Q1	2.4	60	2.3	57.5	2.9	74
	S	0.8	20	0.8	20	1	25
	ø	M6		M8		M10	
	f	5.2	131	5.2	131	5.8	147
	b	6.4	162	6.7	170	8.1	206
	b1	5.4	137	5.4	137	5.7	145
	M	5.8	147	5.9	150	7.1	181
	H	4.9	124	4.9	124	6.2	158
	c	6.7	171	6.7	171	8.6	219
	L	4.2	107	4.2	107	5.7	145
	X1 220–500 V	0.4	10	0.4	10	0.4	10

Dimensional Diagram, Size 6	Dimension	T02HN13	
		in.	mm
		a	9.2
P	2.2	55	
Q	1.8	46	
Q1	3	77	
S	1.2	30	
ø	M10		
f	5.9	150	
b	9.4	238	
b1	8.2	209	
M	8.2	208	
H	6.8	172	
c	9.1	232	
L	5.7	146	
X1 220–500 V	0.6	15	

Dimensional Diagram, Size 7	Dimension	T02JN13	
		in.	mm
		a	12.2
P	3.2	80	
Q	2.4	60	
Q1	3.5	89	
S	1.6	40	
ø	M12		
f	7.1	181	
b	12	304	
b1	11	280	
M	10.4	264	
H	8	202	
c	10	255	
L	6.1	155	
X1 220–500 V	0.8	20	

[36] DIN rail and panel mountable.

TeSys™ N Reversing Contactors

Table 16.72: TeSys N Size 00–1, Reversing Contactors [37]

Dimensional Diagram	Dimension	Dimensions			
		AC Coil		DC Coil	
		in.	mm	in.	mm
	a: Without side-mount accessories	3.54	90	3.54	90
	b: Contactor base	3.35	85	3.35	85
	c: With cover, without add-on blocks	3.62	92	3.98	101
	e1	0.35	9	0.35	9
	e2	0.20	5	0.20	5
	G: Mounting holes	3.15	80	3.15	80

Table 16.73: TeSys N Size 2, Reversing Contactors [37]

Dimensional Diagram	Description	Dimensions	
		AC and DC Coils	
		in.	mm
	Width	4.69	119
	Height	4.80	122
	Depth with cover, without add-on blocks	4.72	120
	Load side mounting hole width	2.52	64
	Line side mounting hole width	3.40	101.5
	Mounting hole height	5.04	128

Table 16.74: TeSys N Size 3–7, Reversing Contactors

Dimensional Diagram	Dimension	Dimensions									
		T02EN23		T02FN23		T02GN23		T02HN23		T02JN23	
		in.	mm	in.	mm	in.	mm	in.	mm	in.	mm
	D	0.38	9.7	0.38	9.7	0.56	14.2	0.56	14.2	0.56	14.2
	H	7.96	202.2	7.96	202.2	15.27	387.9	15.27	387.9	22.25	565.2
	L	11.75	298.5	11.75	298.5	18	457.2	18	457.2	30	762.0
	M	7	177.8	7	177.8	14	355.6	14	355.6	19.75	501.7
	N	0.49	12.5	0.49	12.5	0.62	15.8	0.62	15.8	1.25	31.8
	R	0.49	12.5	0.49	12.5	0.62	15.8	0.62	15.8	0.69	17.5
	W	12.71	322.8	12.71	322.8	19.27	489.5	19.27	489.5	31.38	797.0
	X	5.16	131.0	5.16	131.0	5.79	147.0	5.91	150.0	7.13	181.0

[37] DIN rail and panel mountable.

**TeSys N Starters, Size 00–2**

**Table 16.75: TeSys N Size 00–2 Dimensions**

**Non-reversing**  
T36AN13 / T36BN13 / T36CN13 / T36DN13

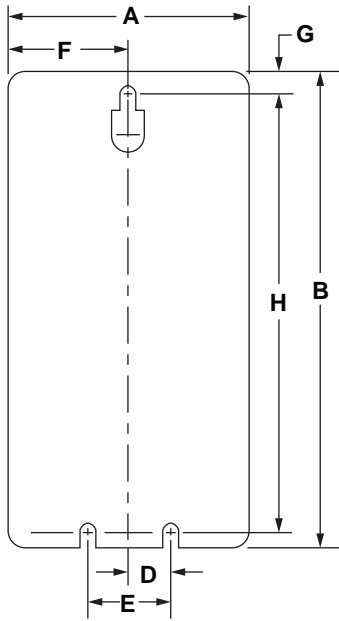

**Reversing**  
T36AN23 / T36BN23 / T36CN23 / T36DN23

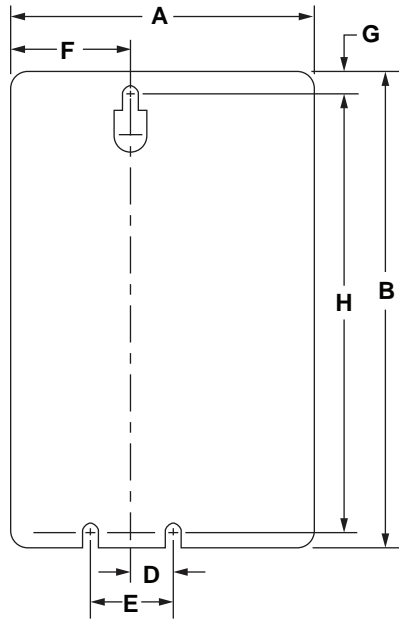

**Depth**

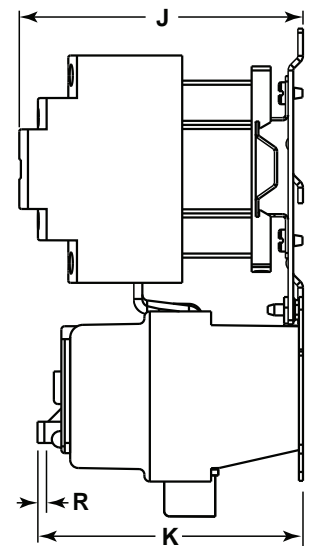

**Table 16.76: TeSys N Size 00–2, Non-Reversing and Reversing Starters**

Dimension	Non-Reversing								Reversing							
	Size 00 T36AN13		Size 0 T36BN13		Size 1 T36CN13		Size 2 T36DN13		Size 00 T36AN23		Size 0 T36BN23		Size 1 T36CN23		Size 2 T36DN23	
	in.	mm	in.	mm	in.	mm	in.	mm	in.	mm	in.	mm	in.	mm	in.	mm
A	3.19	81.0	3.19	81.0	3.19	81.0	3.19	81.0	43.9	111.5	43.9	111.5	43.9	111.5	5.19	131.8
B	6.64	168.7	6.64	168.7	6.64	168.7	8.61	218.7	6.64	168.7	6.64	168.7	6.64	168.7	8.61	218.7
D	0.5	12.7	0.5	12.7	0.5	12.7	0.5	12.7	0.5	12.7	0.5	12.7	0.5	12.7	0.5	12.7
E	1.0	25.4	1.0	25.4	1.0	25.4	1.0	25.4	1.0	25.4	1.0	25.4	1.0	25.4	1.0	25.4
F	1.59	40.5	1.59	40.5	1.59	40.5	1.59	40.5	1.59	40.5	1.59	40.5	1.59	40.5	1.59	40.5
G	0.20	5.2	0.20	5.2	0.20	5.2	0.20	5.2	0.20	5.2	0.20	5.2	0.20	5.2	0.20	5.2
H	6.16	156.5	6.16	156.5	6.16	156.5	8.22	208.8	6.16	156.5	6.16	156.5	6.16	156.5	8.22	208.8
J (AC Coil)	4.17	105.9	4.17	105.9	4.17	105.9	4.94	125.4	4.17	105.9	4.17	105.9	4.17	104.9	4.94	125.4
J (DC Coil)	4.52	114.9	4.52	114.9	4.52	114.9			4.52	114.9	4.52	114.9	4.52	114.9		
K	3.90	99.0	3.90	99.0	3.90	99.0	3.90	99.0	3.90	99.0	3.90	99.0	3.90	99.0	3.90	99.0
R <sup>[38]</sup>	0.24	6.1	0.24	6.1	0.24	6.1	0.24	6.1	0.24	6.1	0.24	6.1	0.24	6.1	0.24	6.1

[38] Reset travel.

TeSys N Starters, Size 3–4

Table 16.77: TeSys N Size 3–4 Dimensions

Non-Reversing  
T36EN13 / T36FN13

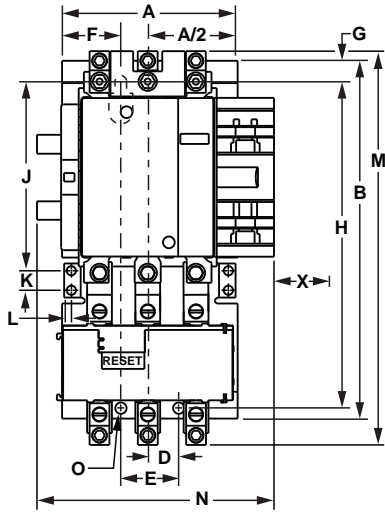

Reversing  
T36EN23 / T36FN23

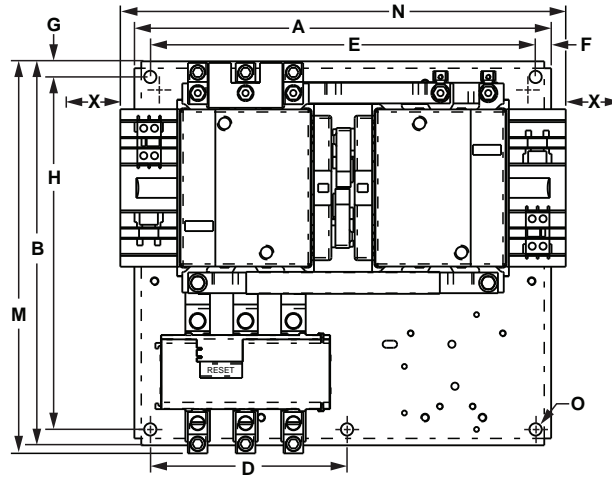

Depth

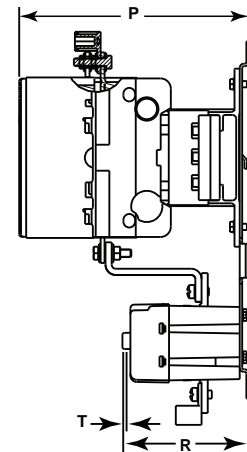

16 NEMA AND DEFINITE PURPOSE CONTACTORS AND STARTERS

Table 16.78: TeSys N Size 3–4, Non-Reversing and Reversing Starters

Dimension	Non-Reversing				Reversing			
	Size 3 T36EN13		Size 4 T36FN13		Size 3 T36EN23		Size 4 T36FN23	
	in.	mm	in.	mm	in.	mm	in.	mm
A	5.31	134.9	5.31	134.9	12.71	322.8	12.71	322.8
B	10.82	274.8	10.82	274.8	11.71	297.4	11.71	297.4
D	0.88	22.4	0.88	22.4	6.0	152.4	6.0	152.4
E	1.75	44.5	1.75	44.5	11.75	298.5	11.75	298.5
F	1.78	45.0	1.78	45.0	0.48	12.2	0.48	12.2
G	0.32	8.1	0.32	8.1	0.48	12.2	0.48	12.2
H	10.19	258.8	10.19	258.8	10.75	273.1	10.75	273.1
J	6.03	153.2	6.03	153.2	—	—	—	—
K	0.59	15.0	0.59	15.0	—	—	—	—
L	0.22	5.6	0.22	5.6	—	—	—	—
M	11.91	302.4	11.91	302.4	11.96	303.8	11.96	303.8
N	6.57	166.8	6.57	166.8	13.58	344.9	13.58	344.9
O	0.375	9.5	0.375	9.5	0.375	9.5	0.375	9.5
P	6.96	176.7	6.96	176.7	7.18	182.4	7.18	182.4
R	3.8	97	3.8	97	3.8	97	3.8	97
T <sup>[39]</sup>	0.24	6.1	0.24	6.1	0.24	6.1	0.24	6.1
X <sup>[40]</sup>	5.16	131.0	5.16	131.0	5.16	131.0	5.16	131.0

[39] Reset travel.  
[40] Minimum distance for coil removal.



**TeSys N Starters, Size 5–7**

**Table 16.79: TeSys N Size 5–7 Dimensions**

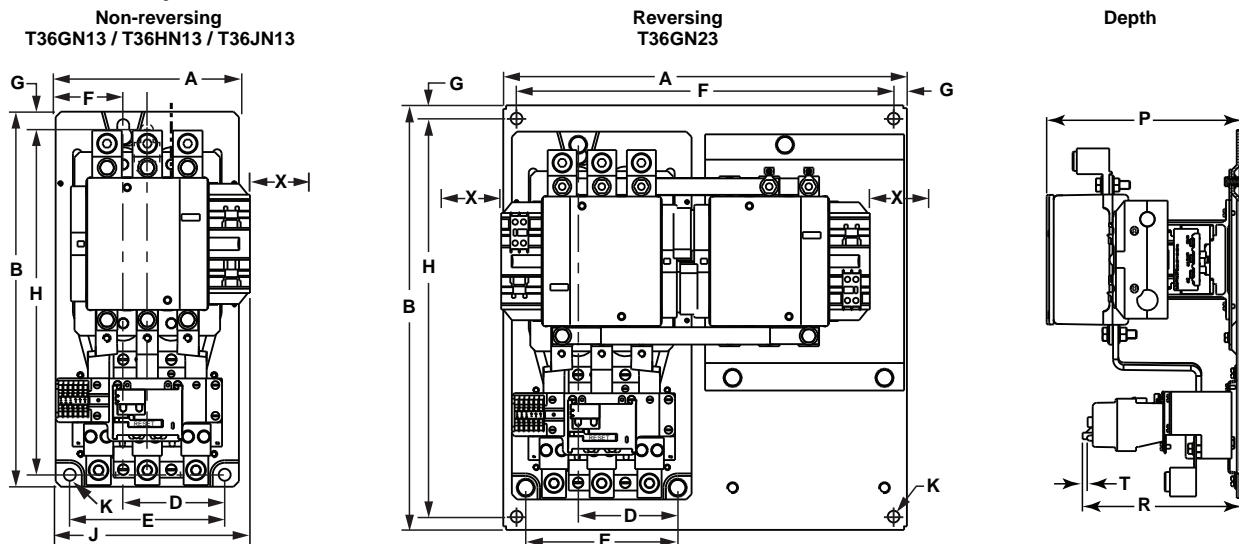

**Table 16.80: TeSys N Size 5–7, Non-Reversing and Reversing Starters**

Dimension	Non-Reversing						Reversing	
	Size 5 T36GN13		Size 6 T36HN13		Size 7 T36JN13		Size 5 T36GN23	
	in.	mm	in.	mm	in.	mm	in.	mm
A	8.58	217.9	8.58	217.9	8.58	217.9	19.3	489.4
B	17.56	446.0	19.75	501.7	23.58	598.9	20.3	514.8
D	4.75	120.7	4.75	120.7	4.75	120.7	4.75	120.7
E	7.25	184.2	7.25	184.2	7.25	184.2	7.25	184.2
F	3.17	80.4	3.17	80.4	3.17	80.4	18.0	457.2
G	0.63	16.0	0.63	16.0	0.63	16.0	0.63	16.1
H	16.37	415.8	18.56	463.6	22.38	565.9	19.0	482.6
J	9.91	251.6	9.91	251.6	9.91	251.6	—	—
K	0.56	14.2	0.56	14.2	0.56	14.2	0.56	14.2
P	9.32	236.8	9.32	236.8	9.32	236.8	9.95	252.7
R	7.38	187.0	9.16	232.7	8.07	205.0	7.38	187.0
T <sup>[41]</sup>	0.24	6.1	0.24	6.1	0.24	6.1	0.24	6.1
X <sup>[41]</sup>	5.79	147.1	5.91	150.1	7.13	181.1	5.79	147.1

[41] Minimum distance for coil removal.

**Catalog Numbering**

**Type S C G 3 V02**

**Form S**

**Class 8536**

General Classification	
8502	Contactors
8536	Starter
8538	Combination Starter with Disconnect Switch
8539	Combination Starter with Circuit Breaker
8702	Reversing Contactor
8736	Reversing Starter
8738	Reversing Combination Starter with Disconnect Switch
8739	Reversing Combination Starter with Circuit Breaker
8810	Two Speed Starter ▲
8903	Type S Lighting Contactors ▲
8940	Pumping Plant Panel ▲
8941	Duplex Controller ▲

▲Consult the Table of Contents for page numbers.

**Design**  
Type S NEMA Contactors and Starters

NEMA Size		Rating (8903 only)	
A	Size 00		
B	Size 0	M	30 A
C	Size 1	P	60 A
D	Size 2	Q	100 A
E	Size 3	V	200 A
F	Size 4	X	300 A
G	Size 5	Y	400 A
H	Size 6	Z	600 A
J	Size 7	J	800 A

Enclosure	
A	NEMA 12 Industrial Use
F	NEMA 1 Flush Mounting General Purpose
G	NEMA 1 General Purpose Surface Mounting
H	NEMA 3R Rainproof
O	Open Style Device (no enclosure)
R	NEMA 7 & 9 Hazardous Environments, Spin Top™
T	NEMA 7 & 9 Hazardous Environments, Bolted
W	NEMA 4 Watertight, 4X Corrosion Resistant

**Numerals**

Used to designate specific physical arrangements, such as the number of poles, fuse clip size, etc.; but the numbering varies with the Class of the equipment. Consult the Digest listings for the specific device numbers.

**Voltage Code**

AC operated devices without control transformer

Code	Voltage/Frequency
V01	24/60
V02	120/60 or 110/50
V06	480/60 or 440/50
V07	600/60 or 550/50
V08	208/60

V81: 480 V Primary, 120 V Secondary for units using a fused transformer control circuit (Form F4T)

This is only a partial listing. Consult the Digest page for each product for more options.

**Common Forms (factory modifications)**

A	Start-Stop pushbuttons in the enclosure cover
C	Hand-Off-Auto selector switch in the enclosure cover
E	Bimetallic overload relays
F4T	Fused transformer control circuit (primary fuses only)
FF4T	Fused transformer control circuit (primary & secondary fuses)
H	Solid-state overload relay (SSOLR)
P1	Red ON pilot light in the enclosure cover
P2	Green OFF pilot light in the enclosure cover
S	Separate control circuit
X01	One normally closed auxiliary contact N.C.
X10	One normally open auxiliary contact N.O.

Consult "Factory Modifications (Forms)" for additional Form designations. When more than one Form is applied to a single device, arrange the Forms in alphanumerical order.

**Table 16.81: How to Order**

To Order Specify:	Catalog Number			
	Class	Type	Voltage Code	Form(s)
<ul style="list-style-type: none"> <li>Class Number</li> <li>Type Number</li> <li>Voltage Code</li> <li>Form(s): see page 16-117</li> </ul>	8539	SCG44	V06	AH30P1X11

**Description:** NEMA Size 1 (10 hp) electronic motor circuit protector (MCP) combo starter in a NEMA 1 enclosure with a 480 V coil, start/stop push button (A), trip-class selectable SSOLR (H30), red pilot light (P1), and 1 N.O. and 1 N.C. auxiliary contact (X11).

**IMPORTANT:** This information is intended for general interpretation of the catalog numbers. Do not use it to create catalog numbers for this product line.

For more ordering information, refer to the Product Selector at [www.schneider-electric.com/us/](http://www.schneider-electric.com/us/).

**NOTE:** The terms *Class*, *Type*, and *Form* do not appear in the catalog number.

Devices are wired from the factory according to customer preference as follows:

- Common control
- Separate control (Form S)
- Control power transformer (CPT)

**NOTE:** TeSys T devices are unwired.



Type SCO2  
Size 1, 3-Pole Contactor

**General Information**

Class 8502 Type S magnetic contactors are used to switch heating loads, capacitors, transformers, and electric motors where overload protection is provided separately. Class 8502 contactors are available in NEMA Sizes 00–7. Type S contactors are designed for operation up to 600 Vac, 50–60 Hz.

**NOTE:** In Table 16.82, replace ●●● with the voltage code shown in Table 16.83.

**Table 16.82: 3-Pole Polyphase—600 Vac Maximum—50–60 Hz**

NEMA Size	Continuous Current Ratings	Motor Voltage	Max. Hp	Open Type	NEMA 1 General Purpose Enclosure	NEMA 4 & 4X Watertight, Dusttight Brushed Stainless Steel Enclosure (Size 0-5) [1]
				Type	Type	Type
00	9	200 230 460 575	1.5 1.5 2 2	SAO12●●●	SAG12●●●	Use Size 0
0	18	200 230 460 575	3 3 5 5	SBO2●●●	SBG2●●●	SBW12●●●
1	27	200 230 460 575	7.5 7.5 10 10	SCO2●●●	SCG2●●●	SCW12●●●
2	45	200 230 460 575	25 15 25 25	SDO2●●●	SDG2●●●	SDW12●●●
3	90	200 230 460 575	25 30 50 50	SEO2●●●	SEG2●●●	SEW12●●●
4	135	200 230 460 575	40 50 100 100	SFO2●●●	SFG2●●●	SFW12●●●
5	270	200 230 460 575	75 100 200 200	SGO2●●●	SGG2●●●	SGW12●●●
6	540	200 230 460 575	150 200 400 400	SHO2●●●	SHG2●●●	SHW2●●●
7	810	200 230 460 575	— 300 600 600	SJO2●●●	SJG2●●●	SJW2●●●

**Table 16.83: Coil Voltage Codes**

Voltage		Code
60 Hz	50 Hz	
24 [2]	—	V01
120 [3]	110	V02
208	—	V08
240	220	V03
277	—	V04
480	440	V06
600	550	V07
Specify	Specify	V99

**NOTE:** For voltage codes used with control transformers, see . Form S (separate control) is used when a separate source of power is available for the control (coil) voltage. Available at no charge.

Dimensions: [page 16-39](#)

Factory Modifications (Forms) [page 16-117](#)

Separate Enclosures (Class 9991): [page 16-110](#)

Replacement Parts (Class 9998): [page 16-122](#)

Type S Accessories (Class 9999): [page 16-125](#)

For How to Order Information, see [page 16-28](#).

[1] Size 6 and 7 are NEMA 4 only, painted sheet steel enclosures.

[2] 24 V coils are not available on Sizes 4–7. On Sizes 00–3, where 24 V coils are available, **Form S** (separate control) must be specified (for example, order as 8502SBO2V01S).

[3] 120 V polyphase contactors are wired for separate control. **Form S** must be specified (i.e., order as 8502SCO2V02S).

3-Pole Polyphase—NEMA 4X, 7 & 9, and 12/3R

NOTE: In Table 16.84, replace ●●● with the voltage code shown in Table 16.83.

For information on field modification of NEMA 12 enclosures, see page 16-112.

Table 16.84: 3-Pole Polyphase—600 Vac Maximum—50–60 Hz

NEMA Size	Continuous Current Ratings	Motor Voltage	Max. Hp	NEMA 4X Watertight, Dusttight, Corrosion-Resistant Glass-Polyester Enclosure	NEMA 7 & 9 Hazardous Locations Div. 1 & 2 Class I, Groups C & D Class II, Groups E, F, & G			NEMA 12/3R [4] Dusttight & Driptight Industrial Use Enclosure
					Bolted Type		Spin Top™ Type	
					Type	Cast Iron [5]		
00	9	200	1-1/2	Use Size 0	Use Size 0	Use Size 0	Use Size 0	Use Size 0
		230	1-1/2					
		460	2					
		575	2					
0	18	200	3	SBW22●●●	SBT2●●●	SBT42●●●	SBR2●●●	SBA2●●●
		230	3					
		460	5					
		575	5					
1	27	200	7-1/2	SCW22●●●	SCT2●●●	SCT42●●●	SCR2●●●	SCA2●●●
		230	7-1/2					
		460	10					
		575	10					
2	45	200	10	SDW22●●●	SDT2●●●	SDT42●●●	SDR2●●●	SDA2●●●
		230	15					
		460	25					
		575	25					
3	90	200	25	SEW22●●●	—	SET42●●●	SER2●●●	SEA2●●●
		230	30					
		460	50					
		575	50					
4	135	200	40	SFW22●●●	—	SFT42●●●	SFR2●●●	SFA2●●●
		230	50					
		460	100					
		575	100					
5	270	200	75	—	—	—	—	SGA2●●●
		230	100					
		460	200					
		575	200					
6	540	200	150	—	—	—	—	SHA2●●●
		230	200					
		460	400					
		575	400					
7	810	200	—	—	—	—	—	SJA2●●●
		230	300					
		460	600					
		575	600					

Auxiliary Units

Auxiliary contacts and power poles can be added in the factory or the field on all Type S starters and contactors. Table 16.85 shows the maximum number of auxiliary units, in addition to the holding circuit contact, that can be added to a given size starter or contactor. In addition, it is possible to add a second internal contact on NEMA Size 0, 1, and 2 contactors and starters.

Table 16.85: Auxiliary Units—Class 8502 and 8536

NEMA Size	Type	No. of Poles—Basic Contactor	Maximum Number of External Auxiliary Units (in addition to holding circuit contact)
00	SA	2–3	4 single-circuit auxiliary contacts (N.O. or N.C.) if second internal auxiliary contact is not used.
0–2	SB–SD	1–3	4 single-circuit auxiliary contacts (N.O. or N.C.) [7]
		4–5	2 single-circuit auxiliary contacts (N.O. or N.C.) plus 1 power pole adder (1 or 2 poles, N.O. or N.C.)
3–4	SE–SF	2–5	3 single-circuit auxiliary contacts (N.O. or N.C.)
5	SG	2–3	2 single-circuit auxiliary contacts (N.O. or N.C.) plus 1 NEMA Size 0–1 or Size 2 power pole adder (1 or 2 poles, N.O. or N.C.)
6–7	SH–SJ	2–3	3 single-circuit auxiliary contacts (N.O. or N.C.)
			2 single-circuit auxiliary contacts (N.O. or N.C.) plus 1 NEMA Size 0–1 or Size 2 power pole adder (1 or 2 poles, N.O. or N.C.)

Dimensions page 16-39  
 Factory Modifications (Forms) page 16-117  
 Separate Enclosures (Class 9991) page 16-110  
 Replacement Parts (Class 9998) page 16-92  
 Type S Accessories (Class 9999) page 16-125  
 For How to Order Information, see page 16-28.

[4] NEMA 12 enclosures can be field modified for outdoor non-corrosive and non-service entrance rated applications.  
 [5] Limited to one pilot light, and a selector switch or Start-Stop push button.  
 [6] NEMA 7 and 9 bolted cast aluminum are not UL listed.  
 [7] When adding 4 external auxiliary contacts to one Size 0 or 1 contactor, remove one of the return springs.

**Single-Phase, 4- and 5-Pole Polyphase—  
Open Style or NEMA 1, 4 & 4X Enclosures**

NOTE: In Table 16.86, replace ●●● with the voltage code shown in Table 16.83.

**Table 16.86: 600 Vac Maximum—50–60 Hz**

NEMA Size	Continuous Current Ratings	Motor Voltage	Max. Hp	Open Type	NEMA 1 General Purpose Enclosure	NEMA 4 & 4X—Watertight, Dusttight, Brushed Stainless Steel Enclosure (Size 0-5)[8]
				Type	Type	Type
<b>1-Pole Single Phase</b>						
0	18	115 230	1 2	SBO5●●●	SBG5●●●	SBW15●●●
1	27	115 230	2 3	SCO5●●●	SCG5●●●	SCW15●●●
<b>2-Pole Single Phase</b>						
00	9	115 230	1/3 1	SAO11●●●	SAG11●●●	Use Size 0
0	18	115 230	1 2	SBO1●●●	SBG1●●●	SBW11●●●
1	27	115 230	2 3	SCO1●●●	SCG1●●●	SCW11●●●
2	45	115 230	3 7-1/2	SDO1●●●	SDG1●●●	SDW11●●●
3	90	—	—	SEO1●●●	SEG1●●●	SEW11●●●
4	135	—	—	SFO1●●●	SFG1●●●	SFW11●●●
5	270	—	—	SGO1●●●	SGG1●●●	SGW11●●●
6	540	—	—	SHO1●●●	SHG1●●●	SHW1●●●
7	810	—	—	SJO1●●●	SJG1●●●	SJW1●●●
<b>4-Pole Polyphase</b>						
0	18	200 230 460 575	3 3 5 5	SBO3●●●	SBG3●●●	SBW13●●●
1	27	200 230 460 575	7-1/2 7-1/2 10 10	SCO3●●●	SCG3●●●	SCW13●●●
2	45	200 230 460 575	10 15 25 25	SDO3●●●	SDG3●●●	SDW13●●●
3	90	200 230 460 575	25 30 50 50	SEO3●●●	SEG3●●●	SEW13●●●
4	135	200 230 460 575	40 50 100 100	SFO3●●●	SFG3●●●	SFW13●●●
<b>5-Pole Polyphase</b>						
0	18	200 230 460 575	3 3 5 5	SBO4●●●	SBG4●●●	SBW14●●●
1	27	200 230 460 575	7-1/2 7-1/2 10 10	SCO4●●●	SCG4●●●	SCW14●●●
2	45	200 230 460 575	10 15 25 25	SDO4●●●	SDG4●●●	SDW14●●●
3	90	200 230 460 575	25 30 50 50	SEO4●●●	SEG4●●●	SEW14●●●
4	135	200 230 460 575	40 50 100 100	SFO4●●●	SFG4●●●	SFW14●●●

 Dimensions: [page 16-39](#)

 Factory Modifications (Forms): [page 16-117](#)

 Separate Enclosures (Class 9991): [page 16-110](#)

 Replacement Parts (Class 9998): [page 16-92](#)

 Type S Accessories (Class 9999): [page 16-125](#)

 For How to Order Information, see [page 16-28](#).

[8] Size 6 and 7 are NEMA 4 only, painted sheet steel enclosures.

**Single-Phase and 4- and 5-Pole Polyphase—  
NEMA 4X, 7 & 9, and 12/3R Enclosures**

NOTE: In Table 16.87, replace ●●● with the voltage code shown in Table 16.83.

For information on field modification of NEMA 12 enclosures, see page 16-112.

Table 16.87: 600 Vac Maximum—50–60 Hz

NEMA Size	Continuous Current Ratings	Motor Voltage	Max. Hp	NEMA 4X Watertight, Dusttight Corrosion-Resistant Glass-Polyester Enclosure	NEMA 7 & 9, Div. 1 & 2 Hazardous Locations Class I, Groups C & D Class II, Groups E, F & G		NEMA 12/3R [9] Dusttight & Driptight Industrial Use Enclosure	
				Type	Bolted Type		Spin Top™ Type	Type
					Cast Iron [10]	Cast Aluminum[11]		
<b>1-Pole Single Phase</b>								
0	18	115 230	1 2	—	SBT5●●●	SBT45●●●	SBR5●●●	SBA5●●●
1	27	115 230	2 3	—	SCT5●●●	SCT45●●●	SCR5●●●	SCA5●●●
<b>2-Pole Single Phase</b>								
00	9	115 230	1/3 1	Use Size 0	Use Size 0		Use Size 0	Use Size 0
0	18	115 230	1 2	SBW21●●●	SBT1●●●	SBT41●●●	SBR1●●●	SBA1●●●
1	27	115 230	2 3	SCW21●●●	SCT1●●●	SCT41●●●	SCR1●●●	SCA1●●●
2	45	115 230	3 7-1/2	SDW21●●●	SDT1●●●	SDT41●●●	SDR1●●●	SDA1●●●
3	90	—	—	Consult the Customer Care Center at 1-888-778-2733.	—	SET41●●●	SER1●●●	SEA1●●●
4	135	—	—		—	SFT41●●●	SFR1●●●	SFA1●●●
5	270	—	—		—	—	—	SGA1●●●
6	540	—	—		—	—	—	SHA1●●●
7	810	—	—		—	—	—	SJA1●●●
<b>4-Pole Polyphase</b>								
0	18	200 230 460 575	3 3 5 5	SBW23●●●	SBT3●●●	Consult the Customer Care Center at 1-888-778-2733.	SBR3●●●	SBA3●●●
1	27	200 230 460 575	7-1/2 7-1/2 10 19	SCW23●●●	SCT3●●●		SCR3●●●	SCA3●●●
2	45	200 230 460 575	10 15 25 25	SDW23●●●	SDT3●●●		SDR3●●●	SDA3●●●
3	90	200 230 460 575	25 30 50 50	Consult the Customer Care Center at 1-888-778-2733.			SER3●●●	SEA3●●●
4	135	200 230 460 575	40 50 100 100				SFR3●●●	SFA3●●●
<b>5-Pole Polyphase</b>								
0	18	200 230 460 575	3 3 5 5	Consult the Customer Care Center at 1-888-778-2733.	—	—	—	SBA4●●●
1	27	200 230 460 575	7-1/2 7-1/2 10 10		—	—	—	SCA4●●●
2	45	200 230 460 575	10 15 25 25		—	—	—	SDA4●●●
3	90	200 230 460 575	25 30 50 50		—	—	—	SEA4●●●
4	135	200 230 460 575	40 50 100 100		—	—	—	SFA4●●●

Coil voltage codes and page number reference for additional information are shown on page 16-29.

For How to Order Information, see page 16-28.

16 NEMA AND DEFINITE PURPOSE CONTACTORS AND STARTERS

[9] NEMA 12 enclosures can be field modified for outdoor non-corrosive and non-service entrance rated applications.  
[10] Limited to one pilot light, and a selector switch or Start-Stop push button.  
[11] NEMA 7 and 9 bolted cast aluminum are not UL listed.



Type SCO3...H30  
Size 1, Three-Pole Starter with Motor Logic™ SSOLR



Schneider Electric offers express shipping for factory modified NEMA Type 1 and Type 12/3R Enclosed Starters. When you need them fast, our Laser™ Delivery program is the answer to getting your product when you need it most. Ask for Laser™ Delivery, then select the product and the modifications you need when you place your order. It's as easy as that!

**General Information**

Type S magnetic starters are used for full-voltage starting and stopping of AC squirrel cage motors. Motor overload protection for three-phase starter applications can be provided through one of four options, as follows:

- Solid-State Overload Relay Protection (Motor Logic™ SSOLR)**  
These ambient insensitive overload relays are available on Sizes 00 through 6 and standard on size 7. They provide phase loss and phase unbalance protection. To order, add Form **H30** (for selectable trip class 10 or 20 protection). For more information about Motor Logic SSOLRs, see [page 16-101](#) and [page 16-119](#). (Catalog no. example: 8536SCO3V06H30)
- Adapted Bimetallic or Solid-State Overload Relay (NEMA Sizes 00–1)**  
The Adapted Bimetallic or Solid-State relay option includes a specially designed adapter that attaches with bus bars to the Type S NEMA contactor. This adapter allows direct mounting of the IEC Style bimetallic (LRD or LR3D) or solid-state (LR9D) overload relay. To order this starter configuration, add **Form E** (adapter only) to the standard catalog number. The LRD, LR3D, or LR9D overload relay must be purchased separately, based on the FLA of the motor, and installed in the field to properly operate the starter. For the Adapted Bimetallic device only, if the FLA is known at the time of purchase, you can order the starter with the overload relay installed. For more information and a list of options, see [Adapted Bimetallic Overload Relay Forms, page 16-119](#). (Catalog no. example: 8536SCO3V06E—without overload relay).
- TeSys T Motor Management System (NEMA Sizes 1–6)**  
TeSys T is a flexible system that integrates seamlessly into your automation system through five major communication protocols. TeSys T can predict what will happen in the process, as it accurately monitors current, voltage, and power over a wide range. For additional information about TeSys T Motor Management System, see [page 16-103](#) and [page 16-120](#). NOTE: The full catalog number contains a four-character Form number (for example, 8536SCO3V06**H616**).
- Melting Alloy Type Thermal Overload Relays (NEMA Sizes 00–6)**  
Melting alloy type thermal overload relays utilize the use of replaceable thermal units. These thermal units must be ordered separately and installed to operate the starter. Thermal unit selection begins on [page 16-132](#). The catalog number includes no Form number (for example, 8536SCO3V06).

**3-Pole Polyphase—NEMA 1, 4 & 4X**

NOTE: In [Table 16.88](#), replace ●●● with the voltage code shown in .

**Table 16.88: 3-Pole Polyphase—600 Vac Maximum—50–60 Hz, with Motor Logic SSOLR<sup>[12]</sup>**

NEMA Size	Continuous Current Ratings	Motor Voltage	Max. Hp	Open Type	NEMA 1 General Purpose Enclosure	NEMA 4 & 4X Watertight, Dusttight Brushed Stainless Steel Enclosure (Size 0-5) <sup>[13]</sup>	NEMA 4X Watertight, Dusttight, Corrosion-Resistant Glass-Polyester Enclosure
				Type	Type	Type	Type
00	9	200 230 460 575	1.5 1.5 2 2	SAO12●●●H30 <sup>[14]</sup>	SAG12●●●H30 <sup>[14]</sup>	Use Size 0	Use Size 0
0	18	200 230 460 575	3 3 5 5	SBO2●●●H30 <sup>[14]</sup>	SBG2●●●H30 <sup>[14]</sup>	SBW12●●●H30 <sup>[14]</sup>	SBW22●●●H30 <sup>[14]</sup>
1	27	200 230 460 575	7.5 7.5 10 10	SCO3●●●H30 <sup>[14]</sup>	SCG3●●●H30 <sup>[14]</sup>	SCW13●●●H30 <sup>[14]</sup>	SCW23●●●H30 <sup>[14]</sup>
2	45	200 230 460 575	10 15 25 25	SDO1●●●H30 <sup>[14]</sup>	SDG1●●●H30 <sup>[14]</sup>	SDW11●●●H30 <sup>[14]</sup>	SDW21●●●H30 <sup>[14]</sup>
3	90	200 230 460 575	25 30 50 50	SEO1●●●H30	SEG1●●●H30	SEW11●●●H30	SEW21●●●H30
4	135	200 230 460 575	40 50 100 100	SFO1●●●H30	SFG1●●●H30	SFW11●●●H30	SFW21●●●H30
5	270	200 230 460 575	75 100 200 200	SGO1●●●H30	SGG1●●●H30	SGW11●●●H30	—
6	540	200 230 460 575	150 200 400 400	SHO2●●●H30	SHG2●●●H30	SHW2●●●H30	—
7	810	200 230 460 575	300 600 600	SJO2●●●H30	SJG2●●●H30	SJW2●●●H30	—

[12] To order melting alloy overload relay, remove form "H30" from part number.

[13] Size 6 and 7 are NEMA 4 only, painted sheet steel enclosures.

[14] **Form H30**, with the possibility of a fourth character to select a lower FLA range (for example, **H308**). See "Solid-State Overload Relay Forms" on [page 16-119](#)

**3-Pole Polyphase—NEMA 7 & 9 and 12/3R**

**NOTE:** In Table 16.89, replace ●●● with the voltage code shown in .

For information on field modification of NEMA 12 enclosures, see page 16-112.

For Form H30\* (special lower-FLA factory-assembled starter combinations with Motor Logic SSOLR protection), see Solid-State Overload Relay Forms, page 16-119.

**Table 16.89: 3-Pole Polyphase—600 Vac Maximum—50–60 Hz<sup>[15]</sup>**

NEMA Size	Continuous Current Ratings	Motor Voltage	Max. Hp	NEMA 7 & 9 For Hazardous Locations Div. 1 & 2 Class I—Groups C, D Class II—Groups E, F, & G		Spin Top™ Type	NEMA 12/3R <sup>[16]</sup> Dusttight & Driptight Industrial Use Enclosure
				Bolted Type			
				Cast Iron <sup>[17]</sup>	Cast Aluminum <sup>[18]</sup>		
00	9	200 230 460 575	1.5 1.5 2 2	Use Size 0		Use Size 0	Use Size 0
0	18	200 230 460 575	3 3 5 5	SBT2●●●H30 <sup>[19]</sup>	SBT42●●●H30 <sup>[19]</sup>	SBR2●●●H30 <sup>[19]</sup>	SBA2●●●H30 <sup>[19]</sup>
1	27	200 230 460 575	7.5 7.5 10 10	SCT3●●●H30 <sup>[19]</sup>	SCT43●●●H30 <sup>[19]</sup>	SCR3●●●H30 <sup>[19]</sup>	SCA3●●●H30 <sup>[19]</sup>
2	45	200 230 460 575	10 15 25 25	SDT1●●●H30 <sup>[19]</sup>	SDT41●●●H30 <sup>[19]</sup>	SDR1●●●H30 <sup>[19]</sup>	SDA1●●●H30 <sup>[19]</sup>
3	90	200 230 460 575	25 30 50 50	—	SET43●●●H30	SER3●●●H30	SEA1●●●H30
4	135	200 230 460 575	40 50 100 100	—	SFT41●●●H30	SFR1●●●H30	SFA1●●●H30
5	270	200 230 460 575	75 100 200 200	—	—	—	SGA1●●●H30
6	540	200 230 460 575	150 200 400 400	—	—	—	SHA2●●●H30
7	810	200 230 460 575	— 300 600 600	—	—	—	SJA2●●●H30

16 NEMA AND DEFINITE PURPOSE CONTACTORS AND STARTERS



Schneider Electric offers express shipping for factory modified NEMA Type 1 and Type 12/3R Enclosed Starters. When you need them fast, our Laser™ Delivery program is the answer to getting your product when you need it most. Ask for Laser™ Delivery, then select the product and the modifications you need when you place your order. It's as easy as that!

**Table 16.90: Coil Voltage Codes**

Voltage		Code
60 Hz	50 Hz	
24 <sup>[20]</sup>	—	V01
120 <sup>[21]</sup>	110	V02
208	—	V08
240	220	V03
277	—	V04
480	440	V06
600	550	V07
Specify	Specify	V99

**NOTE:** For voltage codes used with control transformers, see page 16-118.

Form S (separate control) is used when a separate source of power is available for the control (coil) voltage.

Dimensions: page 16-39

Factory Modifications (Forms): page 16-117

Separate Enclosures (Class 9991): page 16-110

Replacement Parts (Class 9998): page 16-122

Type S Accessories (Class 9999): page 16-125

For How to Order Information, see page 16-28.

[15] To order melting alloy overload relay, remove form "H30" from part number.

[16] NEMA 12 enclosures can be field modified for outdoor non-corrosive and non-service entrance rated applications.

[17] Limited to one pilot light, and a selector switch or Start-Stop push button.

[18] NEMA 7 and 9 bolted cast aluminum are not UL listed.

[19] Form H30, with the possibility of a fourth character to select a lower FLA range (for example, H308). See "Solid-State Overload Relay Forms" on page 16-119

[20] 24 V coils are not available on Sizes 4–7. On Sizes 00–3, where 24 V coils are available, Form S (separate control) must be specified (i.e., order as 8536SB02V01S).

[21] 120 V Polyphase contactors are wired for separate control. Form S (separate control) must be specified (i.e., order as 8536SCO2V02S).



**2-Pole Single Phase—Open or NEMA 1, 4, and 4X**

NOTE: In Table 16.91, replace ●●● with the voltage code shown in .

For melting alloy thermal units, see page 16-132.

**Table 16.91: 2-Pole Single Phase—600 Vac Maximum—50–60 Hz (require 1 melting alloy thermal unit)**

NEMA Size	Continuous Current Ratings	Motor Voltage	Max. Hp	Open Type	NEMA 1 General Purpose Enclosure	NEMA 4 & 4X Watertight, Dusttight Brushed Stainless Steel Enclosure	NEMA 4X Watertight, Dusttight, Corrosion-Resistant Glass-Polyester Enclosure
				Type	Type	Type	Type
00	9	115 230	1/3 1	SAO11●●●	SAG11●●●	Use Size 0	Use Size 0
0	18	115 230	1 2	SBO1●●●	SBG1●●●	SBW11●●●	SBW21●●●
1	27	115 230	2 3	SCO1●●●	SCG1●●●	SCW11●●●	SCW21●●●
1P	36	115 230	3 5	SCO2●●●	SCG2●●●	SCW12●●●	SCW22●●●
2	45	115 230	3 7-1/2	SDO6●●●	SDG6●●●	SDW16●●●	SDW26●●●

**4-Pole, 2-Phase—Open and NEMA 1, 4, and 4X**

NOTE: In Table 16.92, replace ●●● with the voltage code shown in .

For melting alloy thermal units, see page 16-132.

**Table 16.92: 4-Pole, 2-Phase—600 Vac Maximum—50–60 Hz (require 2 melting alloy thermal units)**

NEMA Size	Continuous Current Ratings	Motor Voltage	Max. Hp	Open Type	NEMA 1 General Purpose Enclosure	NEMA 4 & 4X Watertight, Dusttight Brushed Stainless Steel Enclosure	NEMA 4X Watertight, Dusttight, Corrosion-Resistant Glass-Polyester Enclosure
				Type	Type	Type	Type
0	18	200 230 460 575	3 3 5 5	SBO3●●●	SBG3●●●	SBW13●●●	SBW23●●●
1	27	200 230 460 575	7-1/2 7-1/2 10 10	SCO4●●●	SCG4●●●	SCW14●●●	SCW24●●●
2	45	200 230 460 575	10 15 25 25	SDO2●●●	SDG2●●●	SDW12●●●	SDW22●●●
3	90	200 230 460 575	25 30 50 50	SEO2●●●	SEG2●●●	SEW12●●●	Consult the Customer Care Center at (1-888-778-2733)
4	135	200 230 460 575	40 50 100 100	SFO2●●●	SFG2●●●	SFW12●●●	

**Table 16.93: Coil Voltage Codes**

Voltage		Code
60 Hz	50 Hz	
24 [22]	—	V01
120 [23]	110	V02
208	—	V08
240	220	V03
277	—	V04
480	440	V06
600	550	V07
Specify	Specify	V99

NOTE: For voltage codes used with control transformers, see page 16-118.

Form S (separate control) is used when a separate source of power is available for the control (coil) voltage. Form S is provided at no charge.

Dimensions: page 16-39

Factory Modifications (Forms): page 16-117

Separate Enclosures (Class 9991): page 16-110

Replacement Parts (Class 9998): page 16-122

Type S Accessories (Class 9999) page 16-125

For How to Order Information, see page 16-28.

 [22] 24 V coils are not available on Sizes 4–7. On sizes 00–3, where 24 V coils are available, **Form S** (separate control) must be specified (i.e., order as 8536SBO2V01S).

 [23] 120 V polyphase starters are wired for separate control. **Form S** (separate control) must be specified (for example, order as 8536SCO2V02S).

**2-Pole Single Phase—NEMA 7 & 9 and 12/3R**

NOTE: In Table 16.94, replace ●●● with the voltage code shown in .

For melting alloy thermal units, see page 16-132.

For information on field modification of NEMA 12 enclosures, see page 16-112.

**Table 16.94: 2-Pole Single Phase—600 Vac Maximum—50–60 Hz (require 1 melting alloy thermal unit)**

NEMA Size	Continuous Current Ratings	Motor Voltage	Max. Hp	NEMA 7 & 9 Hazardous Locations, Div. 1 & 2 Class I, Groups C & D Class II, Groups E, F, & G			NEMA 12/3R [24] Dusttight & Driptight Industrial Use Enclosure
				Bolted Type		Spin Top™ Type	Type
				Cast Iron [25]	Cast Aluminum [26]		
00	9	115 230	1/3 1	Use Size 0		Use Size 0	Use Size 0
0	18	115 230	1 2	SBT1●●●	SBT41	SBR1●●●	SBA1●●●
1	27	115 230	2 3	SCT1●●●	SCT41	SCR1●●●	SCA1●●●
1P	36	115 230	3 5	SCT2●●●	SCT42	SCR2●●●	SCA2●●●
2	45	115 230	3 7-1/2	SDT6●●●	SDT46	SDR6●●●	SDA6●●●

**4-Pole, 2-Phase—NEMA 7 & 9 and 12/3R**

NOTE: In Table 16.95, replace ●●● with the voltage code shown in .

For melting alloy thermal units, see page 16-132.

For information on field modification of NEMA 12 enclosures, see page 16-112.

**Table 16.95: 4-Pole 2-Phase—600 Vac Maximum—50–60 Hz (require 2 melting alloy thermal units)**

NEMA Size	Continuous Current Ratings	Motor Voltage	Max. Hp	Coil Voltage	NEMA 7 & 9 Hazardous Locations Class I, Groups C & D Class II, Groups E, F, & G			NEMA 12/3R [24] Dusttight & Driptight Industrial Use Enclosure
					Bolted Type		Spin Top™ Type	Type
					Cast Iron [25]	Cast Aluminum		
0	18	200 230 460 575	3 3 5 5	208 240 480 600	SBT3●●●	Consult the Customer Care Center at 1-888-778-2733	SBR3●●●	SBA3●●●
1	27	200 230 460 575	7-1/2 7-1/2 10 10	208 240 480 600	SCT4●●●		SCR4●●●	SCA4●●●
2	45	200 230 460 575	10 15 25 25	208 240 480 600	SDT2●●●		SDR2●●●	SDA2●●●
3	90	200 230 460 575	25 30 50 50	208 240 480 600	Consult the Customer Care Center at 1-888-778-2733		SER2●●●	SEA2●●●
4	135	200 230 460 575	40 50 100 100	208 240 480 600			—	SFA2●●●

Dimensions: page 16-39

Factory Modifications (Forms): page 16-117

Separate Enclosures (Class 9991): page 16-110

Replacement Parts (Class 9998): page 16-122

Type S Accessories (Class 9999): page 16-125

For How to Order Information, see page 16-28.

[24] NEMA 12 enclosures can be field modified for outdoor non-corrosive and non-service entrance rated applications.

[25] Limited to one pilot light, and a selector switch or Start-Stop push button.

[26] NEMA 7 and 9 bolted cast aluminum are not UL listed.



**Types SB–SD With Auxiliary Load Terminals**

Capacitors are sometimes used in motor branch circuits to improve power factor. The Size 0–2 Type SB–SD starters listed in Table 16.96 include three auxiliary terminals to allow easy connection of power factor correction capacitors. When capacitors are connected using these terminals, no adjustment to the selection of thermal units is necessary. The auxiliary terminals accept 12–16 AWG solid or stranded wire. NEMA Size 3 and 4 starters have provisions for auxiliary connections. User must supply lugs as necessary.

The Type S starters with auxiliary load terminals may also be used to control two motors simultaneously from a single starter. However, this application is tightly restricted by Section 430-53 of the National Electrical Code. Refer to the NEC for restrictions regarding overload protection, size of controller and motor branch circuit protection.

**NOTE:** In Table 16.96, replace ●●● with the voltage code shown in .

For melting alloy thermal units, see page 16-132.

**Table 16.96: 3-Pole Polyphase—600 Vac Maximum—50–60 Hz (devices require 3 melting alloy thermal units)**

NEMA Size	Motor Voltage	Max. Hp	Open Style Type
0	200	3	SBTO2●●●
	230	3	
	460	5	
	575	5	
1	200	7-1/2	SCTO3●●●
	230	7-1/2	
	460	10	
	575	10	
2	200	10	SDTO1●●●
	230	15	
	460	25	
	575	25	

**Extra Capacity Single Phase Starters (Not NEMA Style)**

**NOTE:** In Table 16.97, replace ●●● with the voltage code shown in .

For melting alloy thermal units, see page 16-132.

For information on field modification of NEMA 12 enclosures, see page 16-112.

**Table 16.97: 2-Pole Single Phase—250 Vac Maximum—50–60 Hz (require 1 melting alloy thermal unit)**

Motor Voltage	Max. Hp	Open Style	NEMA 1 General Purpose Enclosure	NEMA 3R Rainproof, Sleet Resistant, Outdoor Use Enclosure	NEMA 4 & 4X Watertight, Dusttight Brushed Stainless Steel Enclosure	NEMA 4X Watertight Corrosion Resistant Glass-Polyester Enclosure	NEMA 12/3R [27] Dusttight and Driptight Industrial Use Enclosure
		Type	Type	Type	Type	Type	Type
115 230	5 10	SDO8●●● [28]	—	SDH8●●● [28]	—	—	—
115 230	7-1/2 15	SEO6●●●	SEG6●●●	SEH6●●●	SEW16●●●	SEW26●●●	SEA6●●●

**Table 16.98: Coil Voltage Codes**

Voltage		Code
60 Hz	50 Hz	
24 [29]	—	V01
120 [30]	110	V02
208	—	V08
240	220	V03
277	—	V04
480	440	V06
600	550	V07
Specify	Specify	V99

**NOTE:** For voltage codes used with control transformers, see page 16-118. Form S (separate control) is used when a separate source of power is available for the control (coil) voltage. Form S is supplied at no charge.

Dimensions: page 16-39

Factory Modifications (Forms): page 16-117

Separate Enclosures (Class 9991): page 16-110

Replacement Parts (Class 9998): page 16-122

Type S Accessories (Class 9999): page 16-125

For How to Order Information, see page 16-28.

[27] NEMA 12 enclosures can be field modified for outdoor non-corrosive and non-service entrance rated applications.

[28] Uses a Size 3 overload relay.

[29] 24 V coils are not available on Sizes 4–7. On Sizes 00–3, where 24 V coils are available, Form S (separate control) must be specified.

[30] 120 Volt Polyphase starters are wired for separate control and must be ordered with Form S (i.e., 8536SCO2V02S).



**Dimensions for Open Type and NEMA 1 Enclosures**

**NOTE:** These dimensions are for reference only. If you need precise measurements, contact the Customer Care Center at 1-888-778-2733.

**Table 16.101: Dimensions for Class 8502 Open Type**

NEMA Size	Type	No. of Poles	Fig. No.	Dimensions, in. (Refer to Figure 1)									Wt (lb)
				A in.	B in.	C in.	D in.	E in.	F in.	G in.	H in.	I in.	
00	SAO	2-3	1	3.22	4.34	4.22	1.63	1.63	0.22	3.94	—	—	4
0	SBO	1-3	1	3.22	4.34	4.22	1.63	1.63	0.22	3.94	—	—	4
1	SCO	4-5	1	4.25	4.34	4.22	1.63	2.63	0.22	3.94	—	—	4.5
2	SDO	2-3	1	4.31	5.13	4.94	2.16	2.16	0.22	4.59	0.53	1.06	6.75
		4-5		5.63	5.13	4.94	2.16	3.47	0.22	4.59	0.53	1.06	8.25
3	SEO	2-3	1	5.47	7.09	6.5	1.88	3.53	0.31	6.03	3.25	4.75	14
		4-5		9.75	7.88	6.5	3.94	5.81	0.31	7	4.53	9.06	22
4	SFO	2-3	1	6	8.19	6.5	2.06	3.94	0.31	7	3.59	5.31	18
		4-5		9.75	8.19	6.5	3.94	5.81	0.31	7	4.53	9.06	22
5	SGO	2-3	1	8.67	12.31	8.75	3.25	5.81	0.63	11.13	4.75	7.25	45
6	SHO	2-3	1	10.55	28.06	9	3.53	7.03	5.06	18.56	4.75	7.25	80
7	SJO	2-3	1	10.55	37.25	10.88	3.53	7.03	7.22	22.38	4.75	7.25	135

**Table 16.102: Dimensions for 8536 Open Type**

NEMA Size	Type	No. of Poles	Fig. No.	Dimensions, in. (Refer to Figure 2)									Wt (lb)
				A in.	B in.	C in.	D in.	E in.	F in.	G in.	H in.	I in.	
00, 0, 1, 1P	SAO SCO	2-3	2	3.5	6.77	4.22	0.5	1	1.61	0.2	6.25	3.97	5
0, 1	SBO SCO	4	2	4.53	6.77	4.22	0.5	1	2.67	0.2	6.25	3.97	5.5
2	SDO	2-3	2	4.31	7.81	4.94	0.5	1	2.16	0.2	7.34	4.06	7.75
		4		5.63	7.81	4.94	0.5	1	3.47	0.2	7.34	4.06	9.25
3	SEO	2-3	2	5.47	11.09	6.5	0.88	1.75	3.59	0.31	10.19	5.75	17
		4		9.75	12.13	6.5	1.81	1.75	5.81	0.31	11.19	5.75	25
4	SFO	3	2	6	12.88	6.5	1.81	1.75	3.94	0.31	11.19	5.75	22
		4		9.75	12.88	6.5	1.81	1.75	5.91	0.31	11.19	5.75	25
5	SGO	3	2	8.56	17.56	8.75	4.75	7.25	5.38	0.63	16.38	6	62
6	SHO	3	2	12.34	28.06	9	4.75	7.25	5.78	5.06	18.56	8.69	85
7	SJO	3	2	12.34	37.25	10.88	4.75	7.25	5.78	7.22	22.38	9	140

**Table 16.103: Dimensions for NEMA 1 General Purpose Enclosure**

NEMA Size	Type	No. of Poles	Fig. No.	Dimensions, in.													
				A	B	C		D	E	F	G	H	I	J	K	L	
						8502	8536										
00	SAG	All	3	6	10	5.28	5.56	3	0.88	8.13	1	0.94	4.13	5	—	—	
0	SBG	All	3	6	10	5.28	5.56	3	0.88	8.13	1	0.94	4.13	5	—	—	
1	SCG	All	3														
2	SDG	All	3	7.81	12.69	6.03	6.31	—	1.09	10.5	1.09	1.09	5.63	5.75	1.09	5.63	
3	SEG	All	3	11.44	21.81	8	8.38	—	1.53	18.75	1.53	1.53	8.38	7.75	1.53	8.38	
4	SFG	All	5	11.25	25.16	9	9	8.59	1.25	1.25	22.31	1.44	0.44	—	—	—	
5	SGG	All	5	17.22	44.22	12.81	12.94	13	2.13	2.13	40	2.13	0.56	—	—	—	
6	SHG	All	4	65.75	20.22	13.13	13.13	—	11	64.5	2.31	5.5	—	—	—	—	
7	SJG	All	4	93	34.5	23.5	23.5	Floor Mounting									

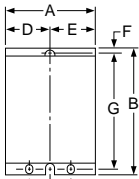

**Figure 1**  
Class 8502

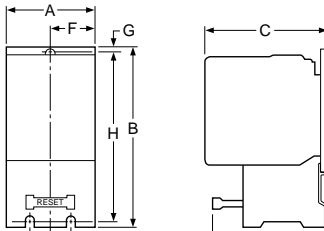

**Figure 2**  
Class 8536

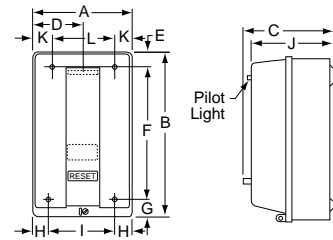

**Figure 3**

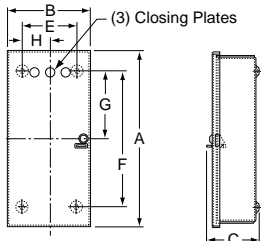

**Figure 4**

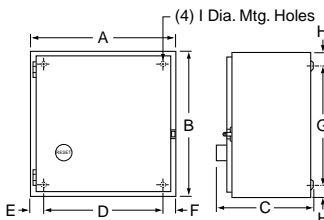

**Figure 5**

Dimensions for NEMA 4 and 4X Enclosures

For the dimensions in Table 16.104 and Table 16.105, see Figure 6.

Table 16.104: NEMA 4 and 4X—Stainless Steel Watertight Enclosure

NEMA Size	Class	Type	No. of Poles	Dimensions, in.												Hub Dia.		
				A	B	C	D	E	F	G	H	I	J	K	L	Bot. Only W	Top & Bot. X	
0 and 1	8502	SBW	All	6.38	7.13	13.19	1.56	3.25	12	0.59	1.19	11.78	1.63	2.31	0.31	3/4"	1"	
		SCW	All	6.38	7.81	13.19	1.56	3.25	12	0.59	1.88	11.78	1.63	2.31	0.31			
2	8502	SDW	All	8.13	7.88	16.19	1.56	5	15	1.09	1.94	14.75	2	2.63	0.31	3/4"	1-1/2"	
		SCW	All	8.13	8.56	16.19	1.56	5	15	1.09	2.88	14.75	2	2.63	0.31			
3 and 4	8502	SEW	All	18.16	8.75	32.22	3.08	12	30.5	0.88	3.69	26.72	2.56	3.19	0.44	3/4"	2-1/2"	
		SFW	All	18.16	9.56	32.22	3.08	12	30.5	0.88	4.5	26.72	2.56	3.19	0.44			
5	8502 & 8536	SGW	All	17.22	12.63	47.22	4.13	9	46	0.63	4.59	28.31	3.13	5.75	0.56	3/4"	3-1/2"	
6 [37]	8502 & 8536	SHW	All	20.22	12.13	65.22	4.13	12	64	0.63	4.59	30.81	2.69	4.5	0.56	3/4"	(2) 3"	
7 [37]	8502 & 8536	SJW	All	34.5	23.5	101	Floor Mounting											

Table 16.105: NEMA 4 and 4X—Stainless Steel Watertight Enclosure with Form FF4T

NEMA Size	Class	Type	No. of Poles	Dimensions, in.											
				A	B	C	D	E	F	G	H	I	J	K	L
0 and 1	8502	SBW	All	12.63	7.13	14.69	2.56	7.5	13.5	0.59	3.19	18.81	1.66	2.31	0.31
		SCW	All	12.63	7.81	14.69	2.56	7.5	13.5	0.59	3.88	18.41	1.66	2.31	0.31
2	8502	SDW	All	14.88	7.56	16.31	2.56	9.75	15	0.66	3.19	20.88	2	2.63	0.31
		SCW	All	14.88	8.25	16.31	2.56	9.75	15	0.66	3.88	20.88	2	2.63	0.31
3 and 4	8502	SEW	2-3	Same as Standard NEMA 4 dimensions, see above.											
		SFW	2-3	Same as Standard NEMA 4 dimensions, see above.											
5	8502 & 8536	SGW	All	Same as Standard NEMA 4 dimensions, see above.											
		SHW	All	Same as Standard NEMA 4 dimensions, see above.											
6 [37]	8502 & 8536	SHW	All	Form FF4T is supplied as standard. Refer to Table 16.321.											
7 [37]	8502 & 8536	SJW	All	Form FF4T is supplied as standard. Refer to Table 16.321.											

For the dimensions in Table 16.106, see Figure 7.

Table 16.106: NEMA 4X—Watertight and Corrosion Resistant Glass Polyester Enclosures, Sizes 00-2, without Form FF4T

Size	Type	No. of Poles	Dimensions, in.												Hub		Weight (lb)
			A	B	C	D	E	F	G	H	I	J	K	L	Bot. Only W	Top & Bot. X	
0, 1	SBW SCW	All	6.5	6.44	12.13	0.75	5	8.75	1.69	3.34	10.06	1.31	2.13	0.31	0.75	1	17
			8.5	7.06	13.88	0.75	7	10.5	1.69	3.91	11.94	1.63	2.38	0.31	0.75	1.5	22

For the dimensions in Table 16.107, see Figure 8.

Table 16.107: NEMA 4X—Watertight and Corrosion Resistant Glass Polyester Enclosures

NEMA Size	Type	No. of Poles	Dimensions, in.				
			A	B	C	E	F
0-2 with Form FF4T	SBW	All	16.88	9.78	22.75	10.13	21.5
	SCW						
	SDW						
3-4	SEW	All	25.81	11.94	33.5	18.5	32.25
	SFW						

NOTE: Devices with Form FF4T may use a larger enclosure. Consult the Customer Care Center at 1-888-778-2733 for dimensions.

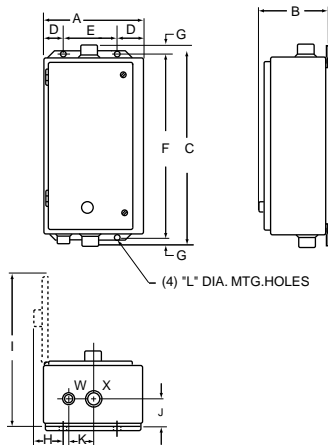

Figure 6: NEMA 4 and 4X—Stainless Steel Watertight Enclosure

NOTE: These dimensions are for reference only. If you need precise measurements, contact the Customer Care Center at 1-888-778-2733.

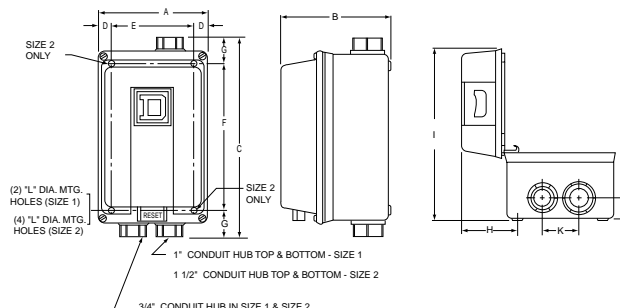

Figure 7: NEMA 4X—Watertight and Corrosion Resistant Glass Polyester Enclosures, Sizes 0-2, without Form FF4T

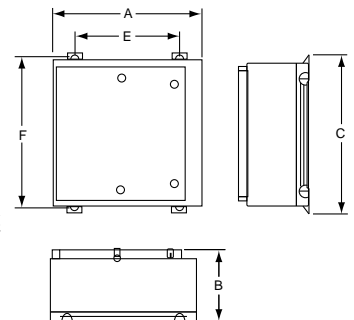

Figure 8: NEMA 4X—Watertight and Corrosion Resistant Glass Polyester Enclosures

[37] Size 6 and 7 are NEMA 4 painted sheet steel enclosures.

**NEMA 7 and 9 Enclosures**

**NOTE:** These dimensions are for reference only. If you need precise measurements, contact the Customer Care Center at 1-888-778-2733.

**Table 16.108: NEMA 7 and 9 Enclosures**

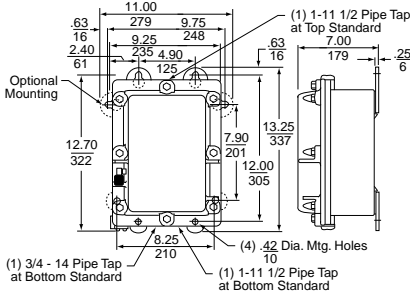

**Bolted Cover, Cast Iron Enclosure, NEMA Size 0 and 1 (weight: 59 lb)**

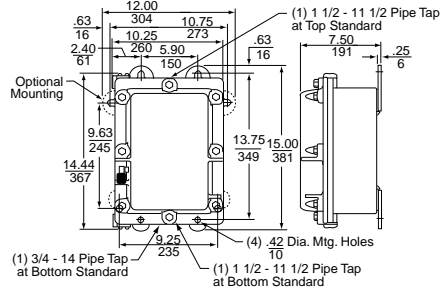

**Bolted Cover, Cast Iron Enclosure, NEMA Size 2 (weight: 75 lb)**

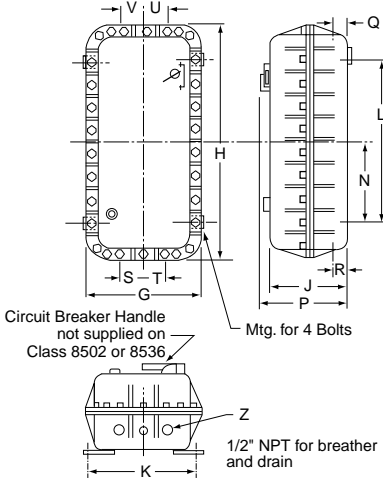

**Bolted Cover, Cast Aluminum Enclosure**

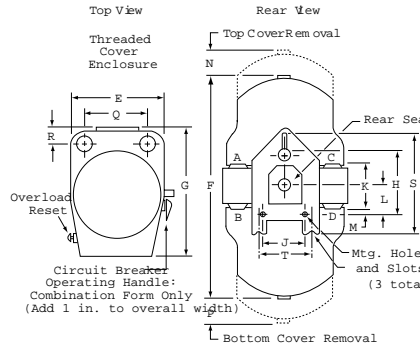

**Spin Top™ Enclosure**

**Table 16.109: NEMA 7 and 9—Bolted Cover, Cast Aluminum Dimensions**

NEMA Size	Type	Dimensions, in.										Z Dia.	Wt. (lb)
		G	H	J	K	L	N	P	Q, R	S, T, U, V			
0-1	SBT	14.25	17.25	9.5	12.25	8.88	4.5	11	2.38	3.13	1.5	75	
	SCT												
2	SDT	13.63	27.63	9.5	12.25	19.25	9.63	11	2.38	3.13	1.5	115	
3-4	SET	18.13	31.63	10	16.25	19.25	9.63	12.63	2.38	3.75	2.5	180	
	SFT												

**Table 16.110: NEMA 7 and 9—Spin Top™ Enclosure Dimensions**

Conduit Sizes Loc. A, B, C & D			Dimensions, in.														Wt. (lb)
NEMA Size	Std.	Type	E	F	G	H	J	K	L	M	N	P	Q	R	S	T	
0-1	1.25	SBR	10.63	26	15.25	8	4.75	5.38	3.75	1.06	7.5	11	7.31	2.06	—	—	70
		SCR															
2	1.5	SDR	13.88	30.5	19.25	8	4.75	5.25	3.75	1.06	7	18	9.38	2.75	—	—	100
3-4	2.5	SER															
SFR			13.38	39.5	20.25	8	4.75	7.5	3.75	—	7.75	23	8.63	3	—	—	165 195

Dimensions for NEMA 12/3R Enclosures

NOTE: These dimensions are for reference only. If you need precise measurements, contact the Customer Care Center at 1-888-778-2733.

Table 16.111: NEMA 12/3R—Dusttight Enclosure

NEMA Size	Type	No. of Poles	Dimensions, in.										Weight (lb)	
			A	B	C	D	E	F	G	H	I	J	Class 8502	Class 8536
0	SBA	All	6.38	8.53	12.75	1.56	3.25	12	0.38	3.56	12.25	0.31	15	16
1	SCA	All												
2	SDA	All	8.13	9.28	16	1.56	5	15	0.5	3.56	15.38	0.31	22	23
3	SEA	All	18.16	9.56	31.5	3.08	12	30.5	0.5	4.5	26.72	0.44	65	68
4	SFA	All												
5	SGA	All	17.22	13.44	47	4.13	9	46	0.5	5.41	28.31	0.56	160	177
6	SHA	All	20.22	13	65	4.13	12	64	0.5	6.44	30.88	0.69	228	233
7	SJA	All	34.5	23.5	93	Floor Mounting						—	—	

Table 16.112: NEMA 12/3R—Dusttight Enclosure With Form FF4T

NEMA Size	Type	No. of Poles	Dimensions, in.									
			A	B	C	D	E	F	G	H	I	J
0	SBA	All	11.88	8	13.5	2.81	6.75	12.75	0.38	3.91	18.38	0.31
1	SCA	All										
2	SDA	All	14.88	8.13	16	2.56	9.75	15	0.38	3.66	21.5	0.31
3	SEA	2-3	Same as Standard NEMA 12 dimensions, see above.									
4	SFA	2-3	Same as Standard NEMA 12 dimensions, see above.									
5	SGA	All	Same as Standard NEMA 12 dimensions, see above.									
6	SHA	All	Form FF4T comes standard. Refer to page 16-118.									
7	SJA	All	Form FF4T comes standard. Refer to page 16-118.									

Table 16.113: NEMA 3R—Rainproof and Sleet Resistant Enclosures

Size	Type	No. of Poles	Dimensions, in.																	K.O. X	K.O. Y	
			A	B	C	D1	D2	E	F	G1	G2	H1	H2	J	K	L	M	N	P			
0, 1	SBH SCH	All	8.84	12.28	7.13	1.38	1.44	6	7.5	2.59	2.19	2.06	2.63	14.28	1.38	1.38	1.88	4.38	1.84	1.84	1/2 3/4 1	1/2 3/4 1
2	SDH	All	9.84	16.28	8.63	1.38	1.44	7	11.5	2.59	2.19	2.06	2.63	16.78	1.31	1.75	2.13	4.88	1.84	1.84	1 1-1/4 1-1/2	1/2 3/4
3	SEH	All	12.84	25.28	8.63	1.38	1.44	10	20.5	2.59	2.19	2.06	2.63	19.78	1.31	1.94	2.44	6.38	1.84	1.84	1 1-1/4 2 2-1/2	1/2 3/4
4	SFH	All	12.84	40.28	9.13	1.38	1.44	10	35.5	2.59	2.19	2.06	2.63	20.28	1.31	2.31	2.69	6.38	1.84	1.84	1 1-1/4 2 2-1/2	1/2 3/4

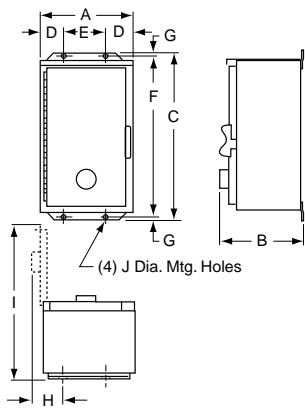

Figure 16.1: NEMA 12/3R

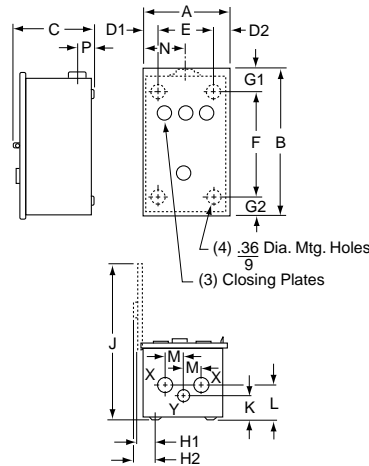

Figure 16.2: NEMA 3R

16 NEMA AND DEFINITE PURPOSE CONTACTORS AND STARTERS



**General Information**

Class 8502 Type W non-reversing vacuum contactors used to switch capacitors, transformers and electric motors where overload protection is separately provided. Type W vacuum contactors are designed for operation at 600 Volts, 50/60 Hz. (See page 16-66 for Class 8702 Reversing Vacuum Contactors.)

**NOTE:** In Table 16.114, replace the three bullets (●●●) in the catalog number with the coil voltage code. Refer to the standard coil voltage codes listed in Table 16.117.



Class 8502 Type WH

**Table 16.114: Class 8502—Full Voltage, 3-Pole Vacuum Contactors**

NEMA Size	Enclosed Ampere Rating	Locked Rotor Current (A)	Motor Voltage	Max. Hp	Open Style Type
4	135	1080	200	40	WFO3●●●
			230	50	
			460	100	
			575	100	
5	270	2160	200	75	WGO3●●●
			230	100	
			460	200	
			575	200	
6	540	4320	200	150	WHO3●●●
			230	200	
			460	400	
			575	400	

**Table 16.115: Class 9998—Replacement Coils for Class 8502 and 8702 Vacuum Contactors (Includes Rectifier)**

Size	Type	Poles	Class and Type	Suffix Number (Complete Coil Number Consists of Class and Type Followed by Suffix Number)			
				120 V 110 V	240 V 220 V	480 V 440 V	600 V 550 V
4	WF	3	9998WF	120	240	480	600
5	WG	3	9998WG				
6	WH	3	9998WH				

**Table 16.116: Class 9999—Vacuum Contactor Kits**

Kit Description	For Use With		Class 9999 Type
	Type	Size	
Auxiliary Contacts, Non-Convertible 1-N.O. & 1-N.C. Isolated Contacts	WF-WG WH	4-5 6	WX11
Coil Circuit Auxiliary Contacts 1-N.O. & 1-N.C. Isolated Contacts, Delayed Break 1-N.C. Isolated Contact	WF WG- WH	4 5-6	WCX11 WLX01
Lug Kits (include 6 lugs)	WG WH	5 6	LWU5 LWU6

**Table 16.117: Coil Voltage Codes**

Volts	110	120	220	240	440	480	550	600
50 Hz	V02	—	V03	—	V06	—	V07	—
60 Hz	—	V02	—	V03	—	V06	—	V07

**Table 16.118: Dimensions, Class 8502**

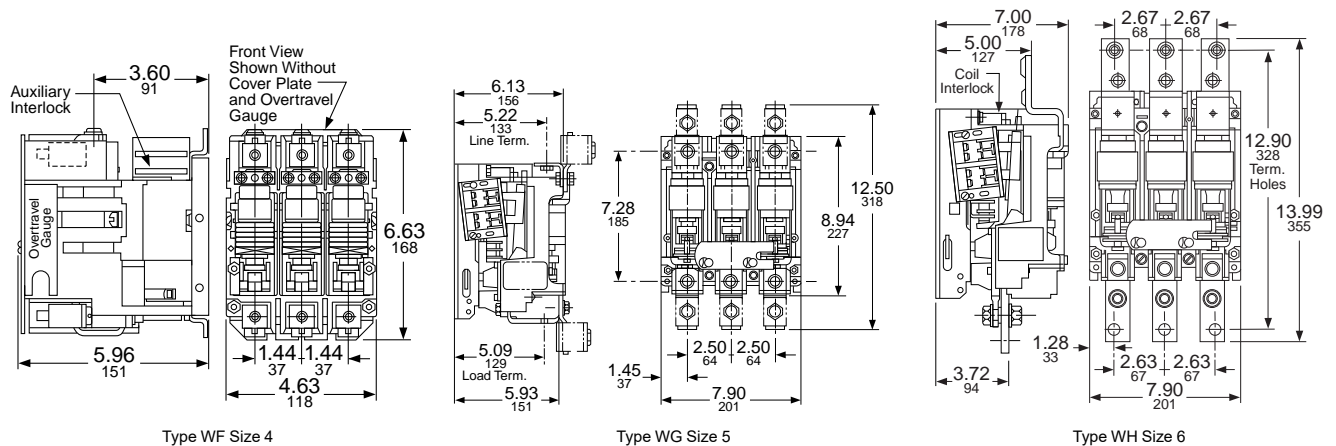

For How to Order Information, see page 16-28.



Class 8502 Type VF

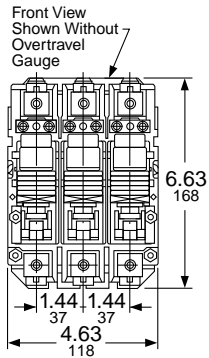
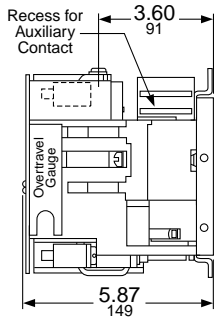

Dimensions for Class 8502 Type VF Size 4

For How to Order Information, see page 16-28.

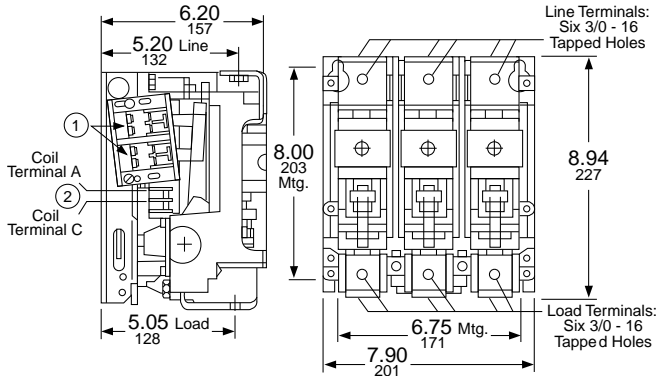

- Two dual circuit auxiliary contacts can be located on both sides of contactor.
- Coil Terminals B and D located on opposite side of contactor.

Dimensions for Class 8502 Type VG Size 5

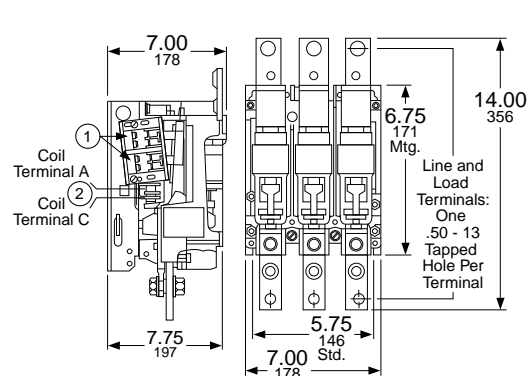

- Two dual circuit auxiliary contacts can be located on both sides of contactor.
- Coil terminals B and D located on opposite side of contactor.

Dimensions for Class 8502 Type VH Size 6

General Information—Type V Vacuum Contactors

The Class 8502 Type V vacuum contactor is a three-pole device rated 1500 V that meets UL508 (1.5 kV) and CSA. Vacuum technology offers long life and low maintenance in a compact, lightweight design. The contactor is suitable for contaminated atmospheres because the main contacts are sealed in vacuum bottles. Also, since gravity is not used to assist contactor operation, the Class 8502 contactor can be mounted in any plane without special modifications. Type V vacuum contactors are designed for the control of inductive or non-inductive loads at voltages from 200–1500 Vac.

**NOTE:** In Table 16.119, replace the three bullets (●●●) in the catalog number with the coil voltage code. Refer to the standard coil voltage codes listed in Table 16.122.

Table 16.119: Class 8502—Full Voltage 3 Pole Vacuum Contactors

NEMA Size	Enclosed Ampere Rating	Locked Rotor Current (A)	Motor Voltage	Max. Hp	Open Style Type
4	160	1080	200	50	VFO3●●●
			230	60	
			460	125	
			575	150	
			800	200	
			1000	250	
5	320	2160	200	100	VGO3●●●
			230	125	
			460	250	
			575	300	
			800	400	
			1000	—	
6	540	4320	200	150	VHO3●●●
			230	200	
			460	400	
			575	400	
			800	—	
			1000	—	
			1500	1300	

Table 16.120: Class 9998—Replacement Coils for Class 8502/8702 (contains rectifier)

Size	Type	Poles	Class and Type	Suffix (the complete coil number consists of the Class, Type, and suffix)			
				110/120 V	220/240 V	440/480 V	550/600 V
4	VF	3	9998WF	120	240	480	600
5	VG	3	9998WG	120	240	480	600
6	VH	3	9998WH	120	240	480	600

Table 16.121: Class 9999—Vacuum Starter Kits

For Use With Type	Size	Kit Description	Class 9999 Type
VF-VG VH	4-5 6	Auxiliary Contacts, Non-Convertible 1 N.O. & 1 N.C. Isolated Contacts	WX11
VF VG-VH	4 5-6	Coil Circuit Auxiliary Contacts 1 N.O. & 1 N.C. Isolated Contacts, Delayed Break 1 N.C. Isolated Contact	WCX11 WLX01
VG VH	5 6	Lug Kits, 6 lugs included	LWU5 LWU6

Table 16.122: Coil Voltage Codes

Voltage	110	120	220	240	440	480	550	600
50 Hz	V02	—	V03	—	V06	—	V07	—
60 Hz	—	V02	—	V03	—	V06	—	V07

**General Information—Type W Vacuum Starters**

Class 8536 Type W non-reversing vacuum starters are used to switch electric motors where overload protection is not separately provided.

Type W vacuum starters are designed for operation at 600 V, 50/60 Hz. Starters are available exclusively with Motor Logic™ solid-state overload relay (SSOLR), Class 10/20 selectable.

**NOTE:** In Table 16.123, replace the three bullets (●●●) in the catalog number with the coil voltage code. Refer to the standard coil voltage codes listed in Table 16.126.

**Table 16.123: Class 8536—Full Voltage Vacuum Starters**

NEMA Size	Enclosed Ampere Rating	Locked Rotor Current (A)	Motor Voltage	Max. Hp	Open Style
					Type
4	135	1080	200	40	WFO3●●●
			230	50	
			460	100	
			575	100	
5	270	2160	200	75	WGO3●●●
			230	100	
			460	200	
			575	200	
6	540	4320	200	150	WHO3●●●
			230	200	
			460	400	
			575	400	

**Table 16.124: Class 9998—Replacement Coils for Class 8536 Vacuum Starters**

Size	Type	Poles	Class and Type	Suffix Number (Complete Coil Number Consists of Class and Type Followed by Suffix Number)			
				120 V 110 V	240 V 220 V	480 V 440 V	600 V 550 V
4	WF	All	9998WF	120	240	480	600
5	WG	All	9998WG	120	240	480	600
6	WH	All	9998WH	120	240	480	600

**Table 16.125: Class 9999—Vacuum Starter Kits**

For Use With		Kit Description	Class 9999 Type
Type	Size		
WF-WG	4-5	Auxiliary Contacts, Non-Convertible 1 N.O. & 1 N.C. Isolated Contacts	WX11
WH	6		
WF	4	Coil Circuit Auxiliary Contacts 1 N.O. & 1 N.C. Isolated Contacts, Delayed Break 1 N.C. Isolated Contact	WCX11 WLX01
WG-WH	5-6		
WG	5	Lug Kits (6) lugs included	LUW5

**Table 16.126: Coil Voltage Codes**

Voltage	110	120	220	240	440	480	550	600
50 Hz	V02	—	V03	—	V06	—	V07	—
60 Hz	—	V02	—	V03	—	V06	—	V07

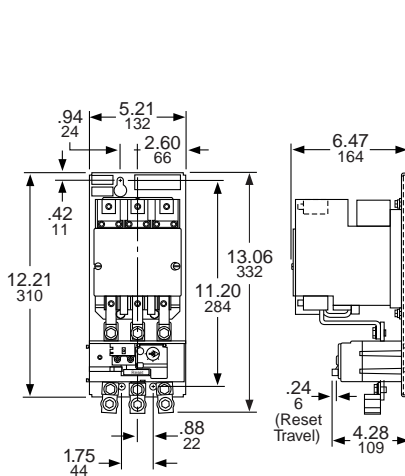

Dimensions for Class 8536 Type WF Size 4

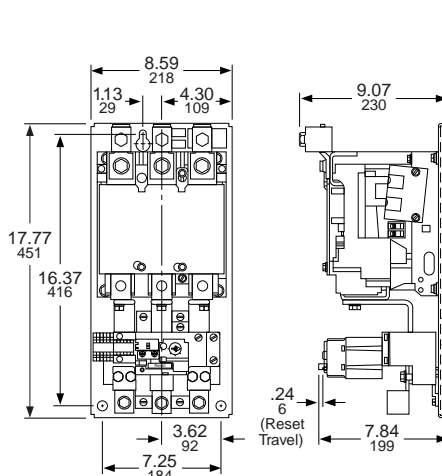

Dimensions for Class 8536 Type WG Size 5

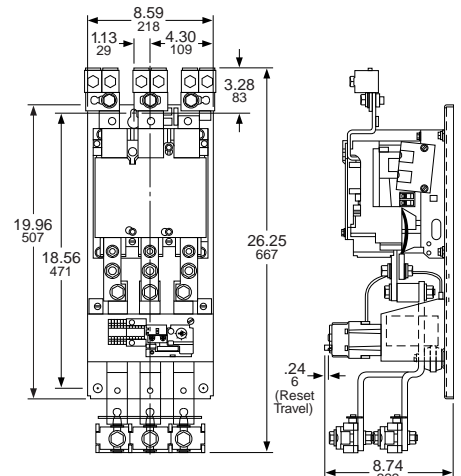

Dimensions for Class 8536 Type WH Size 6

For How to Order Information, see page 16-28



**Pre-Configured NEMA Combination Motor Starters**

Save time with these simple & easy pre-configured fusible or motor circuit protector combination starters. These combination starters have the most commonly used accessories, pre-installed for quick installation. With the NEMA 12/3R enclosure, these combination starters are ready for use in most common indoor and outdoor applications. The Motor Logic electronic overload provides a wide selection range of FLA without the need for additional melting alloys.

These combination starters contain the most common features, saving you time and money:

- Fusible Disconnect (class H/K) or Motor Circuit Protector
- Ideal for indoor or outdoor applications (3R/12 enclosure)
- Trusted Square D Type S Starter with Electronic Overload
- Hand-Off-Auto with Green ON, Red OFF LED lights
- Auxiliary contacts
- SPDT Aux on disconnect

**Table 16.127: Fusible Disconnect Switch**

Voltage (Vac)	Horsepower	NEMA Size	Fuse Clip Size (A)	Overload Range (FLA)	Catalog No.
208/240	0.75-2	0 or 1	30	3-9	8538SCASP4
208/240	3-7.5	1	60	9-27	8538SCASP5
480/600	5-10	0 or 1	30	6-18	8538SCASP6
208/240	5-10 (208) 5-15 (240)	1 or 2	60	15-45	8538SDASP4
480/600	15-25	2	60	15-45	8538SDASP6

**Table 16.128: Motor Circuit Protector**

Voltage (Vac)	Horsepower	NEMA Size	Fuse Clip Size (A)	Overload Range (FLA)	Catalog No.
240/480	0.75-2 (240) 1.5-5 (480)	1	30	3-9	8539SCASP6
240/480	3-7.5 (240) 7.5-15 (480)	2	30	9-27	8539SDASP5
240/480	5-10 (240) 15-25 (480)	2	50	15-45	8539SDASP6

**NOTE:** For melting alloy overload relay options for the above, please consult your local Schneider Electric representative.

- If 120 V is not available, add a transformer:
- 480/240 V to 120 V: 9070TF100D1
  - 208 V to 120 V: 9070TF100D3



- If Class R fuses are used, add fuse clips:
- Class R 250 V, 30 A: RFK03
  - Class R 250 V, 60 A: RFK06
  - Class R 600 V, 30 A: RFK06
  - Class R 600 V, 60 A: RFK06H



**Fusible Disconnect Switch Type**  
**3-Pole Polyphase—600 Vac Maximum—50–60 Hz**

Class 8538 and 8539 Type S combination starters combine the requirements of motor overload and short circuit protection into one package. These starters are manufactured according to NEMA standards and are UL Listed (some Form numbers may not be listed—contact the Customer Care Center). Class 8538 and 8539 combination starters operate at 600 Vac maximum, 50–60 Hz, and can be provided with one of four overloaded relay styles (refer to page 16-33).

For Form H30\* (special lower-FLA factory-assembled starter combinations with Motor Logic SSOLR protection), see [Solid-State Overload Relay Forms](#), page 16-119.

**Table 16.129: Class 8538 Fusible Full Voltage Type (Class H Fuse Clips), with Motor Logic SSOLR (replace ●● with the voltage code)[1]**

Ratings			Fuse Clip Size (A)	NEMA 1 General Purpose Enclosure	NEMA 4 & 4X Watertight and Dusttight Enclosure Stainless Steel (304) (Sizes 0-5)[2]	NEMA 4X Watertight, Dusttight and Corrosion Resistant Polyester Enclosure	NEMA 12/3R[3] Dusttight and Driptight Industrial Use Enclosure	
Motor Voltage (Starter Voltage)	Max. Hp Polyphase	NEMA Size		Type [4]	Type [4]	Type [4]	With External Reset	Without External Reset
200 (208)	3	0	30	SBG12●●●H30 [5]	SBW12●●●H30 [5]	SBW22●●●H30 [5]	SBA22●●●H30 [5]	SBA12●●●H30 [5]
	5	1	30	SCG12●●●H30 [5]	SCW12●●●H30 [5]	SCW22●●●H30 [5]	SCA22●●●H30 [5]	SCA12●●●H30 [5]
	7-1/2		60	SCG13●●●H30 [5]	SCW13●●●H30 [5]	SCW23●●●H30 [5]	SCA23●●●H30 [5]	SCA13●●●H30 [5]
	10	2	60	SDG12●●●H30 [5]	SDW12●●●H30 [5]	SDW22●●●H30 [5]	SDA22●●●H30 [5]	SDA12●●●H30 [5]
	20	3	100	SEG15●●●H30	SEW15●●●H30	SEW25●●●H30	SEA25●●●H30	SEA15●●●H30
	25		200	SEG12●●●H30	SEW12●●●H30	—	SEA22●●●H30	SEA12●●●H30
	40		200	SFG15●●●H30	SFW15●●●H30	—	SFA25●●●H30	SFA15●●●H30
	75	5	400	SGG15●●●H30	SGW15●●●H30	—	SGA25●●●H30	SGA15●●●H30
150	6	600	SHG13●●●H30	SHW13●●●H30	—	SHA23●●●H30	SHA13●●●H30	
230 (240)	3	0	30	SBG12●●●H30 [5]	SBW12●●●H30 [5]	SBW22●●●H30 [5]	SBA22●●●H30 [5]	SBA12●●●H30 [5]
	5	1	30	SCG12●●●H30 [5]	SCW12●●●H30 [5]	SCW22●●●H30 [5]	SCA22●●●H30 [5]	SCA12●●●H30 [5]
	7-1/2		60	SCG13●●●H30 [5]	SCW13●●●H30 [5]	SCW23●●●H30 [5]	SCA23●●●H30 [5]	SCA13●●●H30 [5]
	15	2	60	SDG12●●●H30	SDW12●●●H30 [5]	SDW22●●●H30 [5]	SDA22●●●H30 [5]	SDA12●●●H30 [5]
	25	3	100	SEG15●●●H30	SEW15●●●H30	SEW25●●●H30	SEA25●●●H30	SEA15●●●H30
	30		200	SEG12●●●H30	SEW12●●●H30	—	SEA22●●●H30	SEA12●●●H30
	50		200	SFG15●●●H30	SFW15●●●H30	—	SFA25●●●H30	SFA15●●●H30
	100	5	400	SGG15●●●H30	SGW15●●●H30	—	SGA25●●●H30	SGA15●●●H30
200	6	600	SHG13●●●H30	SHW13●●●H30	—	SHA23●●●H30	SHA13●●●H30	
460 (480)	5	0	30	SBG13●●●H30 [5]	SBW13●●●H30 [5]	SBW23●●●H30 [5]	SBA23●●●H30 [5]	SBA13●●●H30 [5]
	10	1	30	SCG14●●●H30 [5]	SCW14●●●H30 [5]	SCW24●●●H30 [5]	SCA24●●●H30 [5]	SCA14●●●H30 [5]
	15	2	30	SDG16●●●H301	SDW16●●●H301	SDW26●●●H301	SDA26●●●H301	SDA16●●●H301
	25		60	SDG14●●●H30 [5]	SDW14●●●H30 [5]	SDW24●●●H30 [5]	SDA24●●●H30 [5]	SDA14●●●H30 [5]
	50	3	100	SEG13●●●H30	SEW13●●●H30	SEW23●●●H30	SEA23●●●H30	SEA13●●●H30
	100	4	200	SFG13●●●H30	SFW13●●●H30	—	SFA23●●●H30	SFA13●●●H30
	200	5	400	SGG13●●●H30	SGW13●●●H30	—	SGA23●●●H30	SGA13●●●H30
	400	6	600	SHG12●●●H30	SHW12●●●H30	—	SHA22●●●H30	SHA12●●●H30
575 (600)	5	0	30	SBG13●●●H30	SBW13●●●H30	SBW23●●●H30	SBA23●●●H30	SBA13●●●H30
	10	1	30	SCG14●●●H30	SCW14●●●H30	SCW24●●●H30	SCA24●●●H30	SCA14●●●H30
	15	2	30	SDG16●●●H301	SDW16●●●H301	SDW26●●●H301	SDA26●●●H301	SDA16●●●H301
	25		60	SDG14●●●H30	SDW14●●●H30	SDW24●●●H30	SDA24●●●H30	SDA14●●●H30
	50	3	100	SEG13●●●H30	SEW13●●●H30	SEW23●●●H30	SEA23●●●H30	SEA13●●●H30
	100	4	200	SFG13●●●H30	SFW13●●●H30	—	SFA23●●●H30	SFA13●●●H30
	200	5	400	SGG13●●●H30	SGW13●●●H30	—	SGA23●●●H30	SGA13●●●H30
	400	6	600	SHG12●●●H30	SHW12●●●H30	—	SHA22●●●H30	SHA12●●●H30



**3or5 Days**  
Laser Delivery

Schneider Electric offers express shipping for factory modified NEMA Combo Starters. When you need them fast, our Laser™ Delivery program is the answer to getting your product when you need it most. Ask for Laser™ Delivery, then select the product and the modifications you need when you place your order. It's as easy as that!

16 NEMA AND DEFINITE PURPOSE CONTACTORS AND STARTERS

**NOTE:** Some control transformers may require the use of oversized enclosures. Refer to .

**Table 16.130: Class 8538 Fusible Disconnect Switch Type (Class H Fuse Clips), Single Phase, [6][7] with Melting Alloy Overload Relays (see Thermal Unit Selection, page 16-132)**

Motor Voltage	Max. Hp	Coil Voltage	NEMA Size	Poles	Fuse Clip Size (A)	NEMA 1 General Purpose Enclosure	NEMA 4 & 4X Watertight and Dusttight Enclosure Stainless Steel (304)	NEMA 4X Watertight, Dusttight and Corrosion Resistant Polyester Enclosure	NEMA 12/3R[3] Dusttight and Driptight Industrial Use Enclosure	
						Type	Type	Type	With External Reset	Without External Reset
120	1	120	0	2	30	SBG62V02	SBW62V02	SBW65V02	SBA65V02	SBA62V02
	2		30		SCG62V02	SCW62V02	SCW65V02	SCA65V02	SCA62V02	
	3		60		SDG62V02	SDW62V02	SDW65V02	SDA65V02	SDA62V02	
240	2	240	0	2	30	SBG62V03	SBW62V03	SBW65V03	SBA65V03	SBA62V03
	3		30		SCG62V03	SCW62V03	SCW65V03	SCA65V03	SCA62V03	
	7-1/2		60		SDG62V03	SDW62V03	SDW65V03	SDA65V03	SDA62V03	

For How to Order Information, see page 16-28.

[1] To order melting alloy overload relay, remove form "H30" from part number.  
 [2] Size 6 starters are NEMA 4 painted sheet steel enclosures.  
 [3] NEMA 12 enclosures can be field modified for outdoor non-corrosive and non-service entrance rated applications. See page 16-112 for more information.  
 [4] Replace the three bullets (●●●) in the catalog number with the coil voltage code. Refer to the standard coil voltage codes shown in  
 [5] **Form H30**, with the possibility of a fourth character to select a lower FLA range (for example, **H308**). See "Solid-State Overload Relay Forms" on page 16-119  
 [6] Single-phase units require one thermal unit. They are not available with **Form H••** (solid-state overload relays).  
 [7] Not included in the Laser™ Delivery program.

### Non-Fusible Disconnect Switch Type 3-Pole Polyphase—600 Vac Maximum—50–60 Hz

For Form H30\* (special lower-FLA factory-assembled starter combinations with Motor Logic SSOLR protection), see [Solid-State Overload Relay Forms](#), page 16-119.

**Table 16.131: Class 8538 Non-Fusible Full Voltage Type, Non-Reversing, with Motor Logic SSOLR (replace ●●● with the voltage code)<sup>[8]</sup>**

Motor Voltage (Starter Voltage)	Ratings		NEMA 1 General Purpose Enclosure Type [11]	NEMA 4 & 4X Watertight and Dusttight Enclosure Stainless Steel (304) (Sizes 0–5) <sup>[9]</sup> Type [11]	NEMA 4X Watertight, Dusttight and Corrosion Resistant Polyester Enclosure Type [11]	NEMA 12/3R <sup>[10]</sup> Dusttight and Driptight Industrial Enclosure	
	Max. Hp Polyphase	NEMA Size				With External Reset Type [11]	Without External Reset Type [11]
200 (208)	3	0	SBG11●●●H30 [12]	SBW11●●●H30 [12]	SBW21●●●H30 [12]	SBA21●●●H30 [12]	SBA11●●●H30 [12]
	7-1/2	1	SCG11●●●H30 [12]	SCW11●●●H30 [12]	SCW21●●●H30 [12]	SCA21●●●H30 [12]	SCA11●●●H30 [12]
	10	2	SDG11●●●H30 [12]	SDW11●●●H30 [12]	SDW21●●●H30 [12]	SDA21●●●H30 [12]	SDA11●●●H30 [12]
	25	3	SEG11●●●H30	SEW11●●●H30	SEW21●●●H30	SEA21●●●H30	SEA11●●●H30
	40	4	SFG11●●●H30	SFW11●●●H30	—	SFA21●●●H30	SFA11●●●H30
	75	5	SGG11●●●H30	SGW11●●●H30	—	SGA21●●●H30	SGA11●●●H30
150	6	SHG11●●●H30	SHW11●●●H30	—	SHA21●●●H30	SHA11●●●H30	
230 (240)	3	0	SBG11●●●H30 [12]	SBW11●●●H30 [12]	SBW21●●●H30 [12]	SBA21●●●H30 [12]	SBA11●●●H30 [12]
	7-1/2	1	SCG11●●●H30 [12]	SCW11●●●H30 [12]	SCW21●●●H30 [12]	SCA21●●●H30 [12]	SCA11●●●H30 [12]
	15	2	SDG11●●●H30 [12]	SDW11●●●H30 [12]	SDW21●●●H30 [12]	SDA21●●●H30 [12]	SDA11●●●H30 [12]
	30	3	SEG11●●●H30	SEW11●●●H30	SEW21●●●H30	SEA21●●●H30	SEA11●●●H30
	50	4	SFG11●●●H30	SFW11●●●H30	—	SFA21●●●H30	SFA11●●●H30
	100	5	SGG11●●●H30	SGW11●●●H30	—	SGA21●●●H30	SGA11●●●H30
200	6	SHG11●●●H30	SHW11●●●H30	—	SHA21●●●H30	SHA11●●●H30	
460 (480)	5	0	SBG11●●●H30 [12]	SBW11●●●H30 [12]	SBW21●●●H30 [12]	SBA21●●●H30 [12]	SBA11●●●H30 [12]
	10	1	SCG11●●●H30 [12]	SCW11●●●H30 [12]	SCW21●●●H30 [12]	SCA21●●●H30 [12]	SCA11●●●H30 [12]
	25	2	SDG11●●●H30 [12]	SDW11●●●H30 [12]	SDW21●●●H30 [12]	SDA21●●●H30 [12]	SDA11●●●H30 [12]
	50	3	SEG11●●●H30	SEW11●●●H30	SEW21●●●H30	SEA21●●●H30	SEA11●●●H30
	100	4	SFG11●●●H30	SFW11●●●H30	—	SFA21●●●H30	SFA11●●●H30
	200	5	SGG11●●●H30	SGW11●●●H30	—	SGA21●●●H30	SGA11●●●H30
400	6	SHG11●●●H30	SHW11●●●H30	—	SHA21●●●H30	SHA11●●●H30	
575 (600)	5	0	SBG11●●●H30	SBW11●●●H30	SBW21●●●H30	SBA21●●●H30	SBA11●●●H30
	10	1	SCG11●●●H30	SCW11●●●H30	SCW21●●●H30	SCA21●●●H30	SCA11●●●H30
	25	2	SDG11●●●H30	SDW11●●●H30	SDW21●●●H30	SDA21●●●H30	SDA11●●●H30
	50	3	SEG11●●●H30	SEW11●●●H30	SEW21●●●H30	SEA21●●●H30	SEA11●●●H30
	100	4	SFG11●●●H30	SFW11●●●H30	—	SFA21●●●H30	SFA11●●●H30
	200	5	SGG11●●●H30	SGW11●●●H30	—	SGA21●●●H30	SGA11●●●H30
400	6	SHG11●●●H30	SHW11●●●H30	—	SHA21●●●H30	SHA11●●●H30	

**Table 16.132: Class 8538 Non-Fusible Disconnect Switch Type, Single Phase, with Melting Alloy Overload Relay <sup>[13]</sup> <sup>[14]</sup> (see [Thermal Unit Selection](#), page 16-132)**

Motor Voltage	Max. Hp	Coil Voltage	NEMA Size	Poles	NEMA 1 General Purpose Enclosure Type	NEMA 4 & 4X Watertight and Dusttight Enclosure Stainless Steel (304) Type	NEMA 4X Watertight, Dusttight and Corrosion Resistant Polyester Enclosure Type	NEMA 12/3R <sup>[10]</sup> Dusttight and Driptight Industrial Enclosure	
								With External Reset Type	Without External Reset Type
120	1	120	0	2	SBG61V02	SBW61V02	SBW64V02	SBA64V02	SBA61V02
	2		SCG61V02		SCW61V02	SCW64V02	SCA64V02	SCA61V02	
	3		SDG61V02		SDW61V02	SDW64V02	SDA64V02	SDA61V02	
240	2	240	0	2	SBG61V03	SBW61V03	SBW64V03	SBA64V03	SBA61V03
	3		SCG61V03		SCW61V03	SCW64V03	SCA64V03	SCA61V03	
	7-1/2		SDG61V03		SDW61V03	SDW64V03	SDA64V03	SDA61V03	

**NOTE:** Some control transformers may require the use of oversized enclosures. Refer to .

**Table 16.133: Coil Voltage Codes**

Voltage	Code	
	60 Hz	50 Hz
24 <sup>[15]</sup>		V01
120 <sup>[16]</sup>		V02
208		V08
240		V03
277		V04
480		V06
600		V07
Specify	Specify	V99

**NOTE:** For voltage codes used with control transformers, see page . Form S (separate control) is used when a separate source of power is available for the control (coil) voltage. Form S is available at no charge.

For How to Order Information, see [page 16-28](#).

16 NEMA AND DEFINITE PURPOSE CONTACTORS AND STARTERS



[8] To order melting alloy overload relay, remove form "H30" from part number.  
 [9] Size 6 starters are NEMA 4 painted sheet steel enclosures.  
 [10] NEMA 12 enclosures can be field modified for outdoor non-corrosive and non-service entrance rated applications. See [page 16-112](#) for more information.  
 [11] Replace the three bullets (●●●) in the catalog number with the coil voltage code. Refer to the standard coil voltage codes shown in  
 [12] **Form H30**, with the possibility of a fourth character to select a lower FLA range (for example, **H308**). See "Solid-State Overload Relay Forms" on [page 16-119](#)  
 [13] Single-phase units require one thermal unit. They are not available with **Form H••** (solid-state overload relays).  
 [14] Not included in the Laser™ Delivery program.  
 [15] 24 V coils are not available on Sizes 4–7. On Sizes 00–3, where 24 V coils are available, **Form S** (separate control) must be specified (for example, order as 8538SBG11V01S).  
 [16] These voltage codes must include **Form S** (furnished at no charge).  
 When specifying **Form S**, please include the motor voltage when ordering (for example, order as 8538SCG11V02S).

**Fusible Disconnect Switch Type with Class R Fuse Clips  
3-Pole Polyphase—600 Vac Maximum—50–60 Hz**

For Form H30\* (special lower-FLA factory-assembled starter combinations with Motor Logic SSOLR protection), see [Solid-State Overload Relay Forms](#), page 16-119.

**Table 16.134: Class 8538 Fusible (with Class R Fuse Clips) Full Voltage Type, Non-Reversing, with Motor Logic SSOLR (100,000 AIC Rated) (replace ●●● with the voltage code)<sup>[17]</sup>**

Ratings				NEMA 1 General Purpose Enclosure	NEMA 4 & 4X Watertight and Dusttight Enclosure Stainless Steel (304) (Sizes 0–5) <sup>[18]</sup>	NEMA 4 & 4X Watertight, Dusttight and Corrosion Resistant Polyester Enclosure	NEMA 12/3R <sup>[19]</sup> Dusttight and Driptight Industrial Enclosure	
Motor Voltage (Starter Voltage)	Max. Hp Polyphase	NEMA Size	Fuse Clip Size (A)				With External Reset	Without External Reset
				Type <sup>[20]</sup>	Type <sup>[20]</sup>	Type <sup>[20]</sup>	Type <sup>[20]</sup>	Type <sup>[20]</sup>
200 (208)	3	0	30	SBG32●●●H30 <sup>[21]</sup>	SBW32●●●H30 <sup>[21]</sup>	SBW42●●●H30 <sup>[21]</sup>	SBA42●●●H30 <sup>[21]</sup>	SBA32●●●H30 <sup>[21]</sup>
	5	1	30	SCG32●●●H30 <sup>[21]</sup>	SCW32●●●H30 <sup>[21]</sup>	SCW42●●●H30 <sup>[21]</sup>	SCA42●●●H30 <sup>[21]</sup>	SCA32●●●H30 <sup>[21]</sup>
	7-1/2	1	30	SCG33●●●H30 <sup>[21]</sup>	SCW33●●●H30 <sup>[21]</sup>	SCW43●●●H30 <sup>[21]</sup>	SCA43●●●H30 <sup>[21]</sup>	SCA33●●●H30 <sup>[21]</sup>
	10	2	60	SDG32●●●H30 <sup>[21]</sup>	SDW32●●●H30 <sup>[21]</sup>	SDW42●●●H30 <sup>[21]</sup>	SDA42●●●H30 <sup>[21]</sup>	SDA32●●●H30 <sup>[21]</sup>
	20	3	100	SEG35●●●H30	SEW35●●●H30	SEW45●●●H30	SEA45●●●H30	SEA35●●●H30
	25	3	200	SEG32●●●H30	SEW32●●●H30	—	SEA42●●●H30	SEA32●●●H30
	40	4	200	SFG35●●●H30	SFW35●●●H30	—	SFA45●●●H30	SFA35●●●H30
75	5	400	SGG35●●●H30	SGW35●●●H30	—	SGA45●●●H30	SGA35●●●H30	
150	6	600	SHG33●●●H30	SHW33●●●H30	—	SHA43●●●H30	SHA33●●●H30	
230 (240)	3	0	30	SBG32●●●H30 <sup>[21]</sup>	SBW32●●●H30 <sup>[21]</sup>	SBW42●●●H30 <sup>[21]</sup>	SBA42●●●H30 <sup>[21]</sup>	SBA32●●●H30 <sup>[21]</sup>
	5	1	30	SCG32●●●H30 <sup>[21]</sup>	SCW32●●●H30 <sup>[21]</sup>	SCW42●●●H30 <sup>[21]</sup>	SCA42●●●H30 <sup>[21]</sup>	SCA32●●●H30 <sup>[21]</sup>
	7-1/2	1	30	SCG33●●●H30 <sup>[21]</sup>	SCW33●●●H30 <sup>[21]</sup>	SCW43●●●H30 <sup>[21]</sup>	SCA43●●●H30 <sup>[21]</sup>	SCA33●●●H30 <sup>[21]</sup>
	15	2	60	SDG32●●●H30 <sup>[21]</sup>	SDW32●●●H30 <sup>[21]</sup>	SDW42●●●H30 <sup>[21]</sup>	SDA42●●●H30 <sup>[21]</sup>	SDA32●●●H30 <sup>[21]</sup>
	25	3	100	SEG35●●●H30	SEW35●●●H30	SEW45●●●H30	SEA45●●●H30	SEA35●●●H30
	30	3	200	SEG32●●●H30	SEW32●●●H30	—	SEA42●●●H30	SEA32●●●H30
	50	4	200	SFG35●●●H30	SFW35●●●H30	—	SFA45●●●H30	SFA35●●●H30
100	5	400	SGG35●●●H30	SGW35●●●H30	—	SGA45●●●H30	SGA35●●●H30	
200	6	600	SHG33●●●H30	SHW33●●●H30	—	SHA43●●●H30	SHA33●●●H30	
460 (480)	5	0	30	SBG33●●●H30 <sup>[21]</sup>	SBW33●●●H30 <sup>[21]</sup>	SBW43●●●H30 <sup>[21]</sup>	SBA43●●●H30 <sup>[21]</sup>	SBA33●●●H30 <sup>[21]</sup>
	10	1	30	SCG34●●●H30 <sup>[21]</sup>	SCW34●●●H30 <sup>[21]</sup>	SCW44●●●H30 <sup>[21]</sup>	SCA44●●●H30 <sup>[21]</sup>	SCA34●●●H30 <sup>[21]</sup>
	15	2	30	SDG36●●●H301	SDW36●●●H301	SDW46●●●H301	SDA46●●●H301	SDA36●●●H301
	25	2	60	SDG34●●●H30 <sup>[21]</sup>	SDW34●●●H30 <sup>[21]</sup>	SDW44●●●H30 <sup>[21]</sup>	SDA44●●●H30 <sup>[21]</sup>	SDA34●●●H30 <sup>[21]</sup>
	50	3	100	SEG33●●●H30	SEW33●●●H30	SEW43●●●H30	SEA43●●●H30	SEA33●●●H30
	100	4	200	SFG33●●●H30	SFW33●●●H30	—	SFA43●●●H30	SFA33●●●H30
	200	5	400	SGG33●●●H30	SGW33●●●H30	—	SGA43●●●H30	SGA33●●●H30
400	6	600	SHG32●●●H30	SHW32●●●H30	—	SHA42●●●H30	SHA32●●●H30	
575 (600)	5	0	30	SBG33●●●H30 <sup>[21]</sup>	SBW33●●●H30 <sup>[21]</sup>	SBW43●●●H30 <sup>[21]</sup>	SBA43●●●H30 <sup>[21]</sup>	SBA33●●●H30 <sup>[21]</sup>
	10	1	30	SCG34●●●H30 <sup>[21]</sup>	SCW34●●●H30 <sup>[21]</sup>	SCW44●●●H30 <sup>[21]</sup>	SCA44●●●H30 <sup>[21]</sup>	SCA34●●●H30 <sup>[21]</sup>
	15	2	30	SDG36●●●H301	SDW36●●●H301	SDW46●●●H301	SDA46●●●H301	SDA36●●●H301
	25	2	60	SDG34●●●H30 <sup>[21]</sup>	SDW34●●●H30 <sup>[21]</sup>	SDW44●●●H30 <sup>[21]</sup>	SDA44●●●H30 <sup>[21]</sup>	SDA34●●●H30 <sup>[21]</sup>
	50	3	100	SEG33●●●H30	SEW33●●●H30	SEW43●●●H30	SEA43●●●H30	SEA33●●●H30
	100	4	200	SFG33●●●H30	SFW33●●●H30	—	SFA43●●●H30	SFA33●●●H30
	200	5	400	SGG33●●●H30	SGW33●●●H30	—	SGA43●●●H30	SGA33●●●H30
400	6	600	SHG32●●●H30	SHW32●●●H30	—	SHA42●●●H30	SHA32●●●H30	

**NOTE:** Some control transformers may require the use of oversized enclosures. Refer to .

**Table 16.135: Class 8538 Fusible Disconnect Switch Type (Class R Fuses), Single Phase with Melting Alloy Overload Relay<sup>[22][23]</sup> (see [Thermal Unit Selection](#), page 16-132)**

Motor Voltage	Max. Hp	Coil Voltage	NEMA Size	Poles	Fuse Clip Size (A)	NEMA 1 General Purpose Enclosure	NEMA 4 & 4X Watertight and Dusttight Enclosure Stainless Steel	NEMA 4X Watertight, Dusttight and Corrosion Resistant Polyester Enclosure	NEMA 12/3R Dusttight and Driptight Industrial Use Enclosure	
						Type	Type	Type	With External Reset	Without External Reset
120	1	120	0	2	30	SBG63V02	SBW63V02	SBW66V02	SBA66V02	SBA63V02
	2		30		SCG63V02	SCW63V02	SCW66V02	SCA66V02	SCA63V02	
	3		60		SDG63V02	SDW63V02	SDW66V02	SDA66V02	SDA63V02	
240	2	240	0	2	30	SBG63V03	SBW63V03	SBW66V03	SBA66V03	SBA63V03
	3		30		SCG63V03	SCW63V03	SCW66V03	SCA66V03	SCA63V03	
	7-1/2		60		SDG63V03	SDW63V03	SDW66V03	SDA66V03	SDA63V03	

**Table 16.136: Coil Voltage Codes**

Voltage	Code
24 <sup>[24]</sup>	V01
120 <sup>[25]</sup>	V02
208	V08
240	V03
277	V04
480	V06
600	V07
Specify	V99

**NOTE:** For voltage codes used with control transformers, see . Form S (separate control) is used when a separate source of power is available for the control (coil) voltage. Form S is available at no charge.

For How to Order Information, see [page 16-28](#).



[17] To order melting alloy overload relay, remove form "H30" from part number.  
 [18] Size 6 starters are NEMA 4 painted sheet steel enclosures.  
 [19] NEMA 12 enclosures can be field modified for outdoor non-corrosive and non-service entrance rated applications. See [page 16-112](#) for more information.  
 [20] Replace the three bullets (●●●) in the catalog number with the coil voltage code. Refer to the standard coil voltage codes shown in [Table 16.136](#).  
 [21] **Form H30**, with the possibility of a fourth character to select a lower FLA range (for example, **H308**). See "Solid-State Overload Relay Forms" on [page 16-119](#).  
 [22] Single-phase units require one thermal unit. They are not available with **Form H\*\*** (solid-state overload relays).  
 [23] Not included in the Laser™ Delivery program.  
 [24] 24 V coils are not available on Sizes 4–7. On Sizes 00-3, where 24 V coils are available, **Form S** (separate control) must be specified (i.e., order as 8538SBG32V01S).  
 [25] These voltage codes must include **Form S** (provided at no charge). When specifying **Form S**, please include the motor voltage when ordering (for example, order as 8538SCG32V02S).





For How to Order Information, see page 16-28.

**Electronic Motor Circuit Protector (MCP)  
3-Pole Polyphase—600 Vac Maximum—50–60 Hz**

For Form H30\* (special lower-FLA factory-assembled starter combinations with Motor Logic SSOLR protection), see Solid-State Overload Relay Forms, page 16-119.

**Table 16.140: Class 8539 Full Voltage Type, Non-Reversing, 200–240 V, with Motor Logic SSOLR (replace ●●● with the voltage code)[34]**

Ratings				NEMA 1 General Purpose Enclosure	NEMA 4 & 4X Watertight and Dusttight Stainless Steel (304) Enclosure (Sizes 0–5)[35]	NEMA 4 & 4X Watertight, Dusttight, and Corrosion Resistant Polyester Enclosure	NEMA 12/3R[36] Dusttight and Driptight Industrial Use Enclosure	
Motor Voltage (Starter Voltage)	Hp Range Polyphase	NEMA Size	Circuit Breaker (See Page 7-32 for Breaker Adjustment Range)	Type [37]	Type [37]	Type [37]	With External Reset Type [37]	Without External Reset Type [37]
200 (208)	0.25–3	0	HLL36030M71	SBG43●●●H30 [38]	SBW43●●●H30 [38]	SBW53●●●H30 [38]	SBA53●●●H30 [38]	SBA43●●●H30 [38]
	0.25–5 7.5	1	HLL36030M71 HLL36050M72	SCG44●●●H30 [38] SCG45●●●H30 [38]	SCW44●●●H30 [38] SCW45●●●H30 [38]	SCW54●●●H30 [38] SCW55●●●H30 [38]	SCA54●●●H30 [38] SCA55●●●H30 [38]	SCA44●●●H30 [38] SCA45●●●H30 [38]
	1.5–5 7.5–10	2	HLL36030M71 HLL36050M72	SDG42●●●H301 SDG43●●●H30 [38]	SDW42●●●H301 SDW43●●●H30 [38]	SDW52●●●H301 SDW53●●●H30 [38]	SDA52●●●H301 SDA53●●●H30 [38]	SDA42●●●H301 SDA43●●●H30 [38]
	15–25	3	HLL36100M73	SEG42●●●H30	SEW42●●●H30	SEW52●●●H30	SEA52●●●H30	SEA42●●●H30
	30–40	4	JLL36250M75	SFG44●●●H30	SFW44●●●H30	SFW54●●●H30	SFA54●●●H30	SFA44●●●H30
	50–60 75	5	JLL36250M75 LJL36400M36	SGG44●●●H30 SGG45●●●H30	SGW44●●●H30 SGW45●●●H30	—	SGA54●●●H30 SGA55●●●H30	SGA44●●●H30 SGA45●●●H30
	100 125–150	6	LJL36400M36 LJL36600M42	SHG43●●●H30 SHG45●●●H30	SHW43●●●H30 SHW45●●●H30	—	SHA53●●●H30 SHA55●●●H30	SHA43●●●H30 SHA45●●●H30
230 (240)	0.25–3	0	HLL36030M71	SBG43●●●H30 [38]	SBW43●●●H30 [38]	SBW53●●●H30 [38]	SBA53●●●H30 [38]	SBA43●●●H30 [38]
	0.25–7.5	1	HLL36030M71	SCG44●●●H30 [38]	SCW44●●●H30 [38]	SCW54●●●H30 [38]	SCA54●●●H30 [38]	SCA44●●●H30 [38]
	1.5–7.5 10 15	2	HLL36030M71 HLL36050M72 HLL36100M73	SDG42●●●H301 SDG43●●●H30 [38] SDG44●●●H30 [38]	SDW42●●●H301 SDW43●●●H30 [38] SDW44●●●H30 [38]	SDW52●●●H301 SDW53●●●H30 [38] SDW54●●●H30 [38]	SDA52●●●H301 SDA53●●●H30 [38] SDA54●●●H30 [38]	SDA42●●●H301 SDA43●●●H30 [38] SDA44●●●H30 [38]
	15–30	3	HLL36100M73	SEG42●●●H30	SEW42●●●H30	SEW52●●●H30	SEA52●●●H30	SEA42●●●H30
	40–50	4	JLL36250M75	SFG44●●●H30	SFW44●●●H30	SFW54●●●H30	SFA54●●●H30	SFA44●●●H30
	60 75–100	5	JLL36250M75 LJL36400M36	SGG44●●●H30 SGG46●●●H30	SGW44●●●H30 SGW45●●●H30	—	SGA54●●●H30 SGA55●●●H30	SGA44●●●H30 SGA45●●●H30
	125–150 200	6	LJL36600M42 PLL34080M68	SHG45●●●H30 SHG46●●●H30	SHW45●●●H30 SHW46●●●H30	—	SHA55●●●H30 SHA56●●●H30	SHA45●●●H30 SHA46●●●H30
	250–300	7	PLL36100M69	SJG43●●●H30	SJW43●●●H30	—	SJA53●●●H30	—

**NOTE:** Some control transformers may require the use of oversized enclosures. Refer to Control Transformer Selection, page 16-57.

**Table 16.141: Coil Voltage Codes**

Voltage		Code
60 Hz	50 Hz	
24[39]	—	V01
120[40]	110	V02
208	—	V08
240	220	V03
277	—	V04
480	440	V06
600	550	V07
Specify	Specify	V99

**NOTE:** For voltage codes used with control transformers, see page 16-118. Form S (separate control) is used when a separate source of power is available for the control (coil) voltage. Form S is available at no charge.

Dimensions: page 16-58  
Factory Modifications (Forms): page 16-117  
Replacement Parts (Class 9998): page 16-122  
Type S Accessories (Class 9999): page 16-125

For How to Order Information, see page 16-28.



NEMA Type 1 Enclosure with 30 mm Operators



Refer to page 16-31 for details.

[34] To order melting alloy overload relay, remove form "H30" from part number.  
 [35] Size 6 and 7 are NEMA 4 sheet steel enclosures.  
 [36] NEMA 12 enclosures can be field modified for outdoor non-corrosive and non-service entrance rated applications. See page 16-112 for more information.  
 [37] Replace the three bullets (●●●) in the catalog number with the coil voltage code. Refer to the standard coil voltage codes shown in Table 16.141.  
 [38] **Form H30**, with the possibility of a fourth character to select a lower FLA range (for example, **H308**). See "Solid-State Overload Relay Forms" on page 16-119  
 [39] 24 V coils are not available on Sizes 4–7. On Sizes 0–3, where 24 V coils are available, **Form S** (separate control) must be specified (for example, order as 8539SBG41V01S).  
 [40] These voltage codes must include **Form S** (supplied at no charge). When specifying **Form S**, please supply motor voltage when ordering (for example, order as 8539SCG41V02S).

For Form H30\* (special lower-FLA factory-assembled starter combinations with Motor Logic SSOLR protection), see [Solid-State Overload Relay Forms](#), page 16-119.

**Table 16.142: Class 8539 Full Voltage Type, Non-Reversing, 460–600 V, with Motor Logic SSOLR and Electronic Motor Circuit Protector (MCP) (replace ●●● with the voltage code)<sup>[41]</sup>**

Ratings				NEMA 1 General Purpose Enclosure	NEMA 4 & 4X Watertight and Dusttight Enclosure, Stainless Steel (304) (Sizes 0–5) <sup>[42]</sup>	NEMA 4 & 4X Watertight, Dusttight, and Corrosion Resistant Polyester Enclosure	NEMA 12/3R <sup>[43]</sup> Dusttight and Driptight Industrial Use Enclosure		
Motor Voltage (Starter Voltage)	Hp Range Polyphase	NEMA Size	Circuit Breaker (See Page 7-32 for Breaker Adjustment Range)	Type <sup>[44]</sup>	Type <sup>[44]</sup>	Type <sup>[44]</sup>	With External Reset Type <sup>[44]</sup>	Without External Reset Type <sup>[44]</sup>	
460 (480)	0.25–5	0	HLL36030M71	SBG43●●●H30 <sup>[45]</sup>	SBW43●●●H30 <sup>[45]</sup>	SBW53●●●H30 <sup>[45]</sup>	SBA53●●●H30 <sup>[45]</sup>	SBA43●●●H30 <sup>[45]</sup>	
	0.25–10	1	HLL36030M71	SCG44●●●H30 <sup>[45]</sup>	SCW44●●●H30 <sup>[45]</sup>	SCW54●●●H30 <sup>[45]</sup>	SCA54●●●H30 <sup>[45]</sup>	SCA44●●●H30 <sup>[45]</sup>	
	5–15 20–25	2	HLL36030M71 HLL36050M72	SDG42●●●H301 SDG43●●●H30	SDW42●●●H301 SDW43●●●H30 <sup>[45]</sup>	SDW52●●●H301 SDW53●●●H30 <sup>[45]</sup>	SDA52●●●H301 SDA53●●●H30 <sup>[45]</sup>	SDA42●●●H301 SDA43●●●H30 <sup>[45]</sup>	
	20–25 30–50	3	HLL36050M72 HLL36100M73	SEG41●●●H30 SEG42●●●H30	SEW41●●●H30 SEW42●●●H30	SEW51●●●H30 SEW52●●●H30	SEA51●●●H30 SEA52●●●H30	SEA41●●●H30 SEA42●●●H30	
	60–100	4	JLL36250M75	SFG44●●●H30	SFW44●●●H30	SFW54●●●H30	SFA54●●●H30	SFA44●●●H30	
	125 150–200	5	JLL36250M75 LJL36400M36	SGG44●●●H30 SGG45●●●H30	SGW44●●●H30 SGW45●●●H30	—	SGA54●●●H30 SGA55●●●H30	SGA44●●●H30 SGA45●●●H30	
	250–350 400	6	LJL36600M42 PLL34080M68	SHG45●●●H30 SHG46●●●H30	SHW45●●●H30 SHW46●●●H30	—	SHA55●●●H30 SHA56●●●H30	SHA45●●●H30 SHA46●●●H30	
	500 600	7	PLL36080M68 PLL36100M69	SJG42●●●H30 SJG43●●●H30	SJW42●●●H30 SJW43●●●H30	—	SJA52●●●H30 SJA53●●●H30	—	
	575 (600)	0.25–5	0	HLL36030M71	SBG43●●●H30 <sup>[45]</sup>	SBW43●●●H30 <sup>[45]</sup>	SBW53●●●H30 <sup>[45]</sup>	SBA53●●●H30 <sup>[45]</sup>	SBA43●●●H30 <sup>[45]</sup>
		0.25–10	1	HLL36030M71	SCG44●●●H30 <sup>[45]</sup>	SCW44●●●H30 <sup>[45]</sup>	SCW54●●●H30 <sup>[45]</sup>	SCA54●●●H30 <sup>[45]</sup>	SCA44●●●H30 <sup>[45]</sup>
5–20 25		2	HLL36030M71 HLL36050M72	SDG42●●●H301 SDG43●●●H30 <sup>[45]</sup>	SDW42●●●H301 SDW43●●●H30 <sup>[45]</sup>	SDW52●●●H301 SDW53●●●H30 <sup>[45]</sup>	SDA52●●●H301 SDA53●●●H30 <sup>[45]</sup>	SDA42●●●H301 SDA43●●●H30 <sup>[45]</sup>	
25–30 40–50		3	HLL36050M72 HLL36100M73	SEG41●●●H30 SEG42●●●H30	SEW41●●●H30 SEW42●●●H30	SEW51●●●H30 SEW52●●●H30	SEA51●●●H30 SEA52●●●H30	SEA41●●●H30 SEA42●●●H30	
60–100		4	JLL36250M75	SFG44●●●H30	SFW44●●●H30	SFW54●●●H30	SFA54●●●H30	SFA44●●●H30	
125–150 200		5	JLL36250M75 LJL36400M36	SGG44●●●H30 SGG45●●●H30	SGW44●●●H30 SGW45●●●H30	—	SGA54●●●H30 SGA55●●●H30	SGA44●●●H30 SGA45●●●H30	
250 300–400		6	LJL36400M36 LJL36600M42	SHG43●●●H30 SHG45●●●H30	SHW43●●●H30 SHW45●●●H30	—	SHA53●●●H30 SHA55●●●H30	SHA43●●●H30 SHA45●●●H30	
500–600		7	PLL34100M69	SJG41●●●H30	SJW41●●●H30	—	SJA51●●●H30	—	

**NOTE:** Some control transformers may require the use of oversized enclosures. Refer to .

**Table 16.143: Coil Voltage Codes**

Voltage		Code
60 Hz	50 Hz	
24 <sup>[46]</sup>	—	V01
120 <sup>[47]</sup>	110	V02
208	—	V08
240	220	V03
277	—	V04
480	440	V06
600	550	V07
Specify	Specify	V99

**NOTE:** For voltage codes used with control transformers, see . Form S (separate control) is used when a separate source of power is available for the control (coil) voltage. Form S is available at no charge.

Dimensions: [page 16-58](#)  
 Factory Modifications (Forms): [page 16-117](#)  
 Replacement Parts (Class 9998): [page 16-92](#)  
 Type S Accessories (Class 9999): [page 16-125](#)

For How to Order Information, see [page 16-28](#).

**NEMA Size 0–2 in Oversized Enclosure  
 3-Pole Polyphase—600 Vac Maximum—50–60 Hz**

For Form H30\* (special lower-FLA factory-assembled starter combinations with Motor Logic SSOLR protection), see [Solid-State Overload Relay Forms](#), page 16-119.

**Table 16.144: Class 8539 Electronic Motor Circuit Protectors (MCP) in Oversized Enclosure, NEMA Size 0–2<sup>[41][48][49]</sup>  
 Full Voltage Type, Non-Reversing with Motor Logic SSOLR (replace ●●● with the voltage code)**

Ratings				NEMA 1 General Purpose Enclosure	NEMA 4 & 4X Watertight and Dusttight Stainless Steel (304) Enclosure	NEMA 12/3R <sup>[43]</sup> Dusttight and Driptight Industrial Use Enclosure	
Motor Voltage (Starter Voltage)	Hp Range Polyphase	NEMA Size	Circuit Breaker (See Page 7-32 for Breaker Adjustment Range)	Type <sup>[44]</sup>	Type <sup>[44]</sup>	With External Reset Type <sup>[44]</sup>	Without External Reset Type <sup>[44]</sup>
200 (208)	0.25–3	0	HLL36030M71	SBG43S8●●●H30 <sup>[45]</sup>	SBW43S8●●●H30 <sup>[45]</sup>	SBA53S8●●●H30 <sup>[45]</sup>	SBA43S8●●●H30 <sup>[45]</sup>
	0.25–5	1	HLL36030M71	SCG44S8●●●H30 <sup>[45]</sup>	SCW44S8●●●H30 <sup>[45]</sup>	SCA54S8●●●H30 <sup>[45]</sup>	SCA44S8●●●H30 <sup>[45]</sup>

[41] To order melting alloy overload relay, remove form "H30" from part number.

[42] Size 6 and 7 are NEMA 4 only, painted sheet steel enclosures.

[43] NEMA 12 enclosures can be field modified for outdoor non-corrosive and non-service entrance rated applications. See [page 16-112](#) for more information.

[44] Replace the three bullets (●●●) in the catalog number with the coil voltage code. Refer to the standard coil voltage codes shown in [Table 16.143](#).

[45] **Form H30**, with the possibility of a fourth character to select a lower FLA range (for example, **H308**). See "Solid-State Overload Relay Forms" on [page 16-119](#)

[46] 24 V coils are not available on Sizes 4–7. On Sizes 00–3, where 24 V coils are available,

**Form S** (separate control) must be specified (i.e., order as 8539SBG41V01S).

[47] These voltage codes must include **Form S** (furnished at no charge). When specifying **Form S**, please include the motor voltage when ordering (for example, order as 8539SCG41V02S).

[48] Not included in the Laser™ Delivery program.

[49] For NEMA Size 3–5 starters in oversized NEMA 1, 4 or 12 enclosures, contact factory for pricing and TAG number.

**Table 16.144 Class 8539 Electronic Motor Circuit Protectors (MCP) in Oversized Enclosure, NEMA Size 0–2** [16.144][16.144] NEMA Size 0–2 in Oversized Enclosure 3-Pole Polyphase-600 Vac Max\_1602\_18 [16.144] Full Voltage Type, Non-Reversing with Motor Logic SSOLR (replace ●●● with the voltage code) (cont'd.)

Motor Voltage (Starter Voltage)	Ratings			NEMA 1 General Purpose Enclosure	NEMA 4 & 4X Watertight and Driptight Stainless Steel (304) Enclosure	NEMA 12/3R [58] Dusttight and Driptight Industrial Use Enclosure	
	Hp Range Polyphase	NEMA Size	Circuit Breaker (See Page 7-32 for Breaker Adjustment Range)	Type [59]	Type [59]	With External Reset	Without External Reset
				Type [59]	Type [59]	Type [59]	Type [59]
230 (240)	7.5		HLL36050M72	SCG45S8●●●H30[50]	SCW45S8●●●H30[50]	SCA55S8●●●H30[50]	SCA45S8●●●H30[50]
	1.5–5 7.5–10	2	HLL36030M71 HLL36050M72	SDG42S8●●●H301 SDG43S8●●●H30[50]	SDW42S8●●●H301 SDW43S8●●●H30[50]	SDA52S8●●●H301 SDA53S8●●●H30[50]	SDA42S8●●●H301 SDA43S8●●●H30[50]
	0.25–3	0	HLL36030M71	SBG43S8●●●H30[50]	SBW43S8●●●H30[50]	SBA53S8●●●H30[50]	SBA43S8●●●H30[50]
	0.25–7.5	1	HLL36030M71	SCG44S8●●●H30[50]	SCW44S8●●●H30[50]	SCA54S8●●●H30[50]	SCA44S8●●●H30[50]
	1.5–7.5 10 15	2	HLL36030M71 HLL36050M72 HLL36100M73	SDG42S8●●●H301 SDG43S8●●●H30[50] SDG44S8●●●H30[50]	SDW42S8●●●H301 SDW43S8●●●H30[50] SDW44S8●●●H30[50]	SDA52S8●●●H301 SDA53S8●●●H30[50] SDA54S8●●●H30[50]	SDA42S8●●●H301 SDA43S8●●●H30[50] SDA44S8●●●H30[50]
460 (480)	0.25–5	0	HLL36030M71	SBG43S8●●●H30[50]	SBW43S8●●●H30[50]	SBA53S8●●●H30[50]	SBA43S8●●●H30[50]
	0.25–10	1	HLL36030M71	SCG44S8●●●H30[50]	SCW44S8●●●H30[50]	SCA54S8●●●H30[50]	SCA44S8●●●H30[50]
	5–15 20–25	2	HLL36030M71 HLL36050M72	SDG42S8●●●H301 SDG43S8●●●H30[50]	SDW42S8●●●H301 SDW43S8●●●H30[50]	SDA52S8●●●H301 SDA53S8●●●H30[50]	SDA42S8●●●H301 SDA43S8●●●H30[50]
575 (600)	0.25–5	0	HLL36060M71	SBG43S8●●●H30[50]	SBW43S8●●●H30[50]	SBA53S8●●●H30[50]	SBA43S8●●●H30[50]
	0.25–10	1	HLL36030M71	SCG44S8●●●H30[50]	SCW44S8●●●H30[50]	SCA54S8●●●H30[50]	SCA44S8●●●H30[50]
	5–20 25	2	HLL36030M71 HLL36050M72	SDG42S8●●●H301 SDG43S8●●●H30[50]	SDW42S8●●●H301 SDW43S8●●●H30[50]	SDA52S8●●●H301 SDA53S8●●●H30[50]	SDA42S8●●●H301 SDA43S8●●●H30[50]

**NOTE:** Some control transformers may require the use of oversized enclosures. Refer to .

**Table 16.145: Coil Voltage Codes**

Voltage		Code
60 Hz	50 Hz	
24 [56]	—	V01
120 [57]	110	V02
208	—	V08
240	220	V03
277	—	V04
480	440	V06
600	550	V07
Specify	Specify	V99

**NOTE:** For voltage codes used with control transformers, see page 16-118. Form S (separate control) is used when a separate source of power is available for the control (coil) voltage. Form S is available at no charge.

Dimensions: page 16-58

Factory Modifications (Forms): page 16-117

Replacement Parts (Class 9998): page 16-122

Type S Accessories (Class 9999): page 16-125

For How to Order Information, see page 16-28.

[58] NEMA 12 enclosures can be field modified for outdoor non-corrosive and non-service entrance rated applications. See page 16-112 for more information.

[59] Replace the three bullets (●●●) in the catalog number with the coil voltage code. Refer to the standard coil voltage codes shown in Table 16.145.

[50] Form H30, with the possibility of a fourth character to select a lower FLA range (for example, H308). See "Solid-State Overload Relay Forms" on page 16-119

[56] 24 V coils are not available on Sizes 4–7. On Sizes 00–3, where 24 V coils are available, Form S (separate control) must be specified (for example, order as 8539SBG41S8V01S).

[57] These voltage codes must include Form S (provided at no charge). When specifying Form S, please include the motor voltage when ordering (for example, order as 8539SCG41S8V02S).

Thermal Magnetic Circuit Breaker

Full Voltage Type

3-Pole Polyphase—600 Vac Maximum—50–60 Hz

For Form H30\* (special lower-FLA factory-assembled starter combinations with Motor Logic SSOLR protection), see [Solid-State Overload Relay Forms](#), page 16-119.

Table 16.146: Class 8539 Full Voltage, Thermal-Magnetic Circuit Breaker Type, Non-Reversing, with Motor Logic SSOLR (replace ●●● with the voltage code)<sup>[58]</sup>

Ratings					NEMA 1 General Purpose Enclosure	NEMA 4 & 4X Watertight and Dusttight Enclosure Stainless Steel (304) (Sizes 0–5) <sup>[59]</sup>	NEMA 4 & 4X Watertight, Dusttight and Corrosion Resistant Polyester Enclosure	NEMA 12/3R/60 Dusttight and Driptight Industrial Use Enclosure		
Motor Voltage (Starter Voltage)	Max. Hp Polyphase	NEMA Size	Circuit Breaker		Type [61]	Type [61]	Type [61]	With External Reset Type [61]	Without External Reset Type [61]	
			Type	Ampere Rating						
200 (208)	2	0	HLL36015	15	SBG1●●●H30 [62]	SBW1●●●H30 [62]	SBW11●●●H30 [62]	SBA11●●●H30 [62]	SBA1●●●H30 [62]	
	3		HLL36020	20	SBG3●●●H30 [62]	SBW3●●●H30 [62]	SBW13●●●H30 [62]	SBA13●●●H30 [62]	SBA3●●●H30 [62]	
	5	1	HLL36035	35	SCG5●●●H30 [62]	SCW5●●●H30 [62]	SCW15●●●H30 [62]	SCA15●●●H30 [62]	SCA5●●●H30 [62]	
	7-1/2		HLL36050	50	SCG2●●●H30 [62]	SCW2●●●H30 [62]	SCW12●●●H30 [62]	SCA12●●●H30 [62]	SCA2●●●H30 [62]	
	10	2	HLL36060	60	SDG1●●●H30 [62]	SDW1●●●H30 [62]	SDW11●●●H30 [62]	SDA11●●●H30 [62]	SDA1●●●H30 [62]	
	15		HLL36100	100	SEG3●●●H30	SEW3●●●H30	SEW13●●●H30	SEA13●●●H30	SEA3●●●H30	
	20	3	HLL36125	125	SEG1●●●H30	SEW1●●●H30	SEW11●●●H30	SEA11●●●H30	SEA1●●●H30	
	25		HLL36150	150	SEG5●●●H30	SEW5●●●H30	SEW15●●●H30	SEA15●●●H30	SEA5●●●H30	
	30	4	JLL36200	200	SFG3●●●H30	SFW3●●●H30	SFW13●●●H30	SFA13●●●H30	SFA3●●●H30	
	40		JLL36250	250	SFG4●●●H30	SFW4●●●H30	SFW14●●●H30	SFA14●●●H30	SFA4●●●H30	
50	5	JLL36250	250	SGG6●●●H30	SGW6●●●H30	—	SGA16●●●H30	SGA6●●●H30		
60–75		LLL36400U33X	400	SGG4●●●H30	SGW4●●●H30	—	SGA14●●●H30	SGA4●●●H30		
100–125	6	LLL36600U33X	600	SHG4●●●H30	SHW4●●●H30	—	SHA14●●●H30	SHA4●●●H30		
150		MJL36800	800	SHG5●●●H30	SHW5●●●H30	—	SHA15●●●H30	SHA5●●●H30		
230 (240)	2	0	HLL36015	15	SBG1●●●H30 [62]	SBW1●●●H30 [62]	SBW11●●●H30 [62]	SBA11●●●H30 [62]	SBA1●●●H30 [62]	
	3		HLL36020	20	SBG3●●●H30 [62]	SBW3●●●H30 [62]	SBW13●●●H30 [62]	SBA13●●●H30 [62]	SBA3●●●H30 [62]	
	5	1	HLL36035	35	SCG5●●●H30 [62]	SCW5●●●H30 [62]	SCW15●●●H30 [62]	SCA15●●●H30 [62]	SCA1●●●H30 [62]	
	7-1/2		HLL36045	45	SCG6●●●H30 [62]	SCW6●●●H30 [62]	SCW16●●●H30 [62]	SCA16●●●H30 [62]	SCA6●●●H30 [62]	
	10	2	HLL36060	60	SDG1●●●H30 [62]	SDW1●●●H30 [62]	SDW11●●●H30 [62]	SDA11●●●H30 [62]	SDA1●●●H30 [62]	
	15		HLL36090	90	SDG7●●●H30 [62]	SDW7●●●H30 [62]	SDW17●●●H30 [62]	SDA17●●●H30 [62]	SDA7●●●H30 [62]	
	20	3	HLL36100	100	SEG3●●●H30	SEW3●●●H30	SEW13●●●H30	SEA13●●●H30	SEA3●●●H30	
	25–30		HLL36150	150	SEG5●●●H30	SEW5●●●H30	SEW15●●●H30	SEA15●●●H30	SEA5●●●H30	
	40	4	JLL36225	225	SFG1●●●H30	SFW1●●●H30	SFW11●●●H30	SFA11●●●H30	SFA1●●●H30	
	50		JLL36250	250	SFG4●●●H30	SFW4●●●H30	SFW14●●●H30	SFA14●●●H30	SFA4●●●H30	
	60	5	JLL36250	250	SGG6●●●H30	SGW6●●●H30	—	SGA16●●●H30	SGA6●●●H30	
	75		LLL36400U33X	400	SGG4●●●H30	SGW4●●●H30	—	SGA14●●●H30	SGA4●●●H30	
	100	6	LLL36600U33X	600	SGG2●●●H30	SGW2●●●H30	—	SGA12●●●H30	SGA2●●●H30	
125	LLL36600U33X		600	SHG4●●●H30	SHW4●●●H30	—	SHA14●●●H30	SHA4●●●H30		
150–200	7	MJL36800	800	SHG5●●●H30	SHW5●●●H30	—	SHA15●●●H30	SHA5●●●H30		
250–300		PKL36100	1200	SJG3●●●H30	SJW3●●●H30	—	SJA13●●●H30	—		

NOTE: Some control transformers may require the use of oversized enclosures. Refer to .

Table 16.147: Coil Voltage Codes

Voltage		Code
60 Hz	50 Hz	
24 <sup>[63]</sup>	—	V01
120 <sup>[64]</sup>	110	V02
208	—	V08
240	220	V03
277	—	V04
480	440	V06
600	550	V07
Specify	Specify	V09

NOTE: For voltage codes used with control transformers, see page 16-118. Form S (separate control) is used when a separate source of power is available for the control (coil) voltage. Form S is provided at no charge.

Dimensions: [page 16-58](#)  
 Factory Modifications (Forms): [page 16-117](#)  
 Replacement Parts (Class 9998): [page 16-122](#)  
 Type S Accessories (Class 9999): [page 16-125](#)  
 For How to Order Information, see [page 16-28](#).

16 NEMA AND DEFINITE PURPOSE CONTACTORS AND STARTERS

[58] To order melting alloy overload relay, remove form "H30" from part number.

[59] Size 6 and 7 are NEMA 4 only, painted sheet steel enclosures.

[60] NEMA 12 enclosures can be field modified for outdoor non-corrosive and non-severe entrance rated applications. See [page 16-112](#) for more information.

[61] Replace the three bullets (●●●) in the catalog number with the coil voltage code. Refer to the standard coil voltage codes listed in [Table 16.147](#).

[62] Form H30, with the possibility of a fourth character to select a lower FLA range (for example, H308). See "Solid-State Overload Relay Forms" on [page 16-119](#)

[63] 24 V coils are not available on Sizes 4–7. On Sizes 00–3, where 24 V coils are available,

Form S (separate control) must be specified (for example, order as 8539SBG1V01S).

[64] These voltage codes must include Form S (provided at no charge). When specifying Form S, please include the motor voltage when ordering (for example, order as 8539SCG5V02S).

**Line Voltage Type**  
**3-Pole Polyphase—600 Vac Maximum—50–60 Hz**

For Form H30\* (special lower-FLA factory-assembled starter combinations with Motor Logic SSOLR protection), see [Solid-State Overload Relay Forms](#), page 16-119.

**Table 16.148: Class 8539 Line Voltage, Thermal-Magnetic Circuit Breaker Type, Non-Reversing, with Motor Logic SSOLR (replace ●●● with the voltage code)<sup>[65]</sup>**

Ratings					NEMA 1 General Purpose Enclosure	NEMA 4 & 4X Watertight and Dusttight Stainless Steel (304) Enclosure (Sizes 0–5) <sup>[66]</sup>	NEMA 4 & 4X Watertight Dusttight and Corrosion Resistant Polyester Enclosure	NEMA 12/3R/67 Dusttight and Driptight Industrial Use Enclosure		
Motor Voltage (Starter Voltage)	Max. Hp Polyphase	NEMA Size	Circuit Breaker		Type <sup>[68]</sup>	Type <sup>[68]</sup>	Type <sup>[68]</sup>	With External Reset	Without External Reset	
			Type	Ampere Rating				Type <sup>[68]</sup>	Type <sup>[68]</sup>	
460 (480)	5	0	HLL36015	15	SBG1●●●H30 <sup>[69]</sup>	SBW1●●●H30 <sup>[69]</sup>	SBW11●●●H30 <sup>[69]</sup>	SBA11●●●H30 <sup>[69]</sup>	SBA1●●●H30 <sup>[69]</sup>	
	7.5 10	1	HLL36025 HLL36030	25 30	SCG3●●●H30 <sup>[69]</sup> SCG7●●●H30 <sup>[69]</sup>	SCW3●●●H30 <sup>[69]</sup> SCW7●●●H30 <sup>[69]</sup>	SCW13●●●H30 <sup>[69]</sup> SCW17●●●H30 <sup>[69]</sup>	SCA13●●●H30 <sup>[69]</sup> SCA17●●●H30 <sup>[69]</sup>	SCA3●●●H30 <sup>[69]</sup> SCA7●●●H30 <sup>[69]</sup>	
	15 20 25	2	HLL36045 HLL36060 HLL36070	45 60 70	SDG3●●●H30 <sup>[69]</sup> SDG1●●●H30 <sup>[69]</sup> SDG5●●●H30 <sup>[69]</sup>	SDW3●●●H30 <sup>[69]</sup> SDW1●●●H30 <sup>[69]</sup> SDW5●●●H30 <sup>[69]</sup>	SDW13●●●H30 <sup>[69]</sup> SDW11●●●H30 <sup>[69]</sup> SDW15●●●H30 <sup>[69]</sup>	SDA13●●●H30 <sup>[69]</sup> SDA11●●●H30 <sup>[69]</sup> SDA15●●●H30 <sup>[69]</sup>	SDA3●●●H30 <sup>[69]</sup> SDA1●●●H30 <sup>[69]</sup> SDA5●●●H30 <sup>[69]</sup>	
	30 40 50	3	HLL36080 HLL36100 HLL36150	80 100 150	SEG7●●●H30 SEG3●●●H30 SEG5●●●H30	SEW7●●●H30 SEW3●●●H30 SEW5●●●H30	SEW17●●●H30 SEW13●●●H30 SEW15●●●H30	SEA17●●●H30 SEA13●●●H30 SEA15●●●H30	SEA7●●●H30 SEA3●●●H30 SEA5●●●H30	
	60 75 100	4	JLL36150 JLL36200 JLL36250	150 200 250	SFG5●●●H30 SFG3●●●H30 SFG4●●●H30	SFW5●●●H30 SFW3●●●H30 SFW4●●●H30	SFW15●●●H30 SFW13●●●H30 SFW14●●●H30	SFA15●●●H30 SFA13●●●H30 SFA14●●●H30	SFA5●●●H30 SFA3●●●H30 SFA4●●●H30	
	125–150 200	5	LLL36400U33X LLL36600U33X	400 600	SGG4●●●H30 SGG2●●●H30	SGW4●●●H30 SGW2●●●H30	—	SGA14●●●H30 SGA12●●●H30	SGA4●●●H30 SGA2●●●H30	
	250 300–400	6	LLL36600U33X MJL36800	600 800	SHG4●●●H30 SHG5●●●H30	SHW4●●●H30 SHW5●●●H30	—	SHA14●●●H30 SHA15●●●H30	SHA4●●●H30 SHA5●●●H30	
	500–600	7	PLL36120	1200	SJG3●●●H30	SJW3●●●H30	—	SJA13●●●H30	—	
	575 (600)	5	0	HLL36015	15	SBG1●●●H30 <sup>[69]</sup>	SBW1●●●H30 <sup>[69]</sup>	SBW11●●●H30 <sup>[69]</sup>	SBA11●●●H30 <sup>[69]</sup>	SBA1●●●H30 <sup>[69]</sup>
		7.5 10	1	HLL36020 HLL36025	20 25	SCG8●●●H30 <sup>[69]</sup> SCG3●●●H30 <sup>[69]</sup>	SCW8●●●H30 <sup>[69]</sup> SCW3●●●H30 <sup>[69]</sup>	SCW18●●●H30 <sup>[69]</sup> SCW13●●●H30 <sup>[69]</sup>	SCA18●●●H30 <sup>[69]</sup> SCA13●●●H30 <sup>[69]</sup>	SCA8●●●H30 <sup>[69]</sup> SCA3●●●H30 <sup>[69]</sup>
		15 20 25	2	HLL36035 HLL36045 HLL36060	35 45 60	SDG8●●●H301 SDG3●●●H30 <sup>[69]</sup> SDG1●●●H30 <sup>[69]</sup>	SDW8●●●H301 SDW3●●●H30 <sup>[69]</sup> SDW1●●●H30 <sup>[69]</sup>	SDW18●●●H301 SDW13●●●H30 <sup>[69]</sup> SDW11●●●H30 <sup>[69]</sup>	SDA18●●●H301 SDA13●●●H30 <sup>[69]</sup> SDA11●●●H30 <sup>[69]</sup>	SDA8●●●H301 SDA3●●●H30 <sup>[69]</sup> SDA1●●●H30 <sup>[69]</sup>
		30 40 50	3	HLL36070 HLL36090 HLL36100	70 90 100	SEG4●●●H30 SEG6●●●H30 SEG3●●●H30	SEW4●●●H30 SEW6●●●H30 SEW3●●●H30	SEW14●●●H30 SEW16●●●H30 SEW13●●●H30	SEA14●●●H30 SEA16●●●H30 SEA13●●●H30	SEA4●●●H30 SEA6●●●H30 SEA3●●●H30
		60–75 100	4	JLL36150 JLL36250	150 250	SFG5●●●H30 SFG4●●●H30	SFW5●●●H30 SFW4●●●H30	SFW15●●●H30 SFW14●●●H30	SFA15●●●H30 SFA14●●●H30	SFA5●●●H30 SFA4●●●H30
		125–150 200	5	JLL36250 LLL36400U33X	250 400	SGG6●●●H30 SGG4●●●H30	SGW6●●●H30 SGW4●●●H30	—	SGA16●●●H30 SGA14●●●H30	SGA6●●●H30 SGA4●●●H30
250–350 400		6	LLL36600U33X MJL36800	600 800	SHG4●●●H30 SHG5●●●H30	SHW4●●●H30 SHW5●●●H30	—	SHA14●●●H30 SHA15●●●H30	SHA4●●●H30 SHA5●●●H30	
500–600		7	PKL36100	1200	SJG2●●●H30	SJW2●●●H30	—	SJA12●●●H30	—	

**Table 16.149: Class 8539 Thermal Magnetic Circuit Breaker Type, Single Phase<sup>[70][71]</sup> with Melting Alloy Overload Relays**

Motor Voltage	Max. Hp	Coil Voltage	NEMA Size	Poles	Circuit Breaker (Type)	Ampere Rating	NEMA 1 General Purpose Enclosure	NEMA 4 & 4X Watertight and Dusttight Stainless Steel (304) Enclosure (Sizes 0–2)	NEMA 4 & 4X Watertight, Dusttight and Corrosion Resistant Polyester Enclosure	NEMA 12/3R/67 Dusttight and Driptight Industrial Use Enclosure	
							Type	Type	Type	With External Reset	Without External Reset
120	1 2 3	120	0	2	HLL26030 HLL26050 HLL26080	30 50 80	SBG72V02	SBW72V02	SBW75V02	SBA75V02	SBA72V02
			SCG72V02				SCW72V02	SCW75V02	SCA75V02	SCA72V02	
			SDG71V02				SDW71V02	SDW74V02	SDA74V02	SDA71V02	
240	2 3 7.5	240	0	2	HLL26025 HLL26035 HLL26080	25 35 80	SBG71V03	SBW71V03	SBW74V03	SBA74V03	SBA71V03
			SCG71V03				SCW71V03	SCW74V03	SCA74V03	SCA71V03	
			SDG71V03				SDW71V03	SDW74V03	SDA74V03	SDA71V03	

**NOTE:** Some control transformers may require the use of oversized enclosures. Refer to [page 16-57](#). For How to Order Information, see [page 16-28](#).



[65] To order melting alloy overload relay, remove form "H30" from part number.  
 [66] Size 6 and 7 are NEMA 4 only, painted sheet steel enclosures.  
 [67] NEMA 12 enclosures can be field modified for outdoor non-corrosive and non-service entrance rated applications. See [page 16-112](#) for more information.  
 [68] Replace the three bullets (●●●) in the catalog number with the coil voltage code. Refer to the standard coil voltage codes listed in [Table 16.147](#).  
 [69] **Form H30**, with the possibility of a fourth character to select a lower FLA range (for example, **H308**). See "Solid-State Overload Relay Forms" on [page 16-119](#).  
 [70] Not included in the Laser™ Delivery program.  
 [71] Single-phase units require one thermal unit and are not available with Form H●● (solid-state overload relay).

Application Data

Table 16.150: Class 8539—UL Listed Short Circuit Ratings

Motor Circuit Protector Type			
NEMA Size	Enclosure	AIC at 480 Vac (RMS)	AIC at 600 Vac (RMS)
0, 1	Standard <sup>[72]</sup>	100,000	35,000
2 thru 5	Standard <sup>[72]</sup>	100,000	50,000
6	Standard <sup>[72]</sup>	65,000	18,000
7	Standard <sup>[72]</sup>	65,000	30,000

Table 16.151: Electronic Motor Circuit Protector (MCP) Selection by HP Ratings of Induction-type Squirrel-Cage Motors

3Ø, 60 Hz Voltages				Full-Load (A)	Suffix
200 Vac	230 Vac	460 Vac	575 Vac		
.5–5	.5–7.5	.75–15	1–20	1.5–25	M71
5–10	5–15	10–30	15–40	14–42	M72
10–25	15–30	25–60	30–75	30–80	M73
20–40	25–50	50–100	60–125	58–130	M74
40–60	50–75	100–150	125–200	114–217	M75

**NOTE:** The MCP adjustable trip range is determined by the suffix of the circuit breaker catalog number. This table indicates the trip range which corresponds to a given suffix number. The MCP motor circuit protector should be adjusted to a level just above locked-rotor current of the motor. This setting will provide optimum overcurrent protection for the motor. For more information on MCP instantaneous-trip circuit breakers, refer to the MCP circuit breaker section of this catalog.

Table 16.152: Class 8539, UL Listed Short Circuit Ratings

Thermal Magnetic Circuit Breaker Type			
NEMA Size	Enclosure	AIC at 480 Vac (RMS)	AIC at 600 Vac (RMS)
0, 1	Standard <sup>[72]</sup>	100,000	35,000
2 thru 5	Standard <sup>[72]</sup>	100,000	50,000
6	Standard <sup>[72]</sup>	65,000	18,000
7	Standard <sup>[72]</sup>	65,000	30,000

Table 16.153: Class 8538—UL Listed Short Circuit Ratings

NEMA Size	NEMA Fuse Class	Enclosure	Available Amperes RMS Symmetrical
0–3	Class H or K	Standard <sup>[73]</sup>	5,000
0–3	Class R/J	Standard <sup>[73]</sup>	100,000
0–2	Class H or K	Oversize	5,000
0–2	Class R/J	Standard	100,000
4–5	Class H or K	Standard <sup>[73]</sup>	10,000
4–5	Class R/J	Standard <sup>[73]</sup>	100,000
6	Class H or K	Standard <sup>[73]</sup>	18,000
6	Class R/J	Standard <sup>[73]</sup>	100,000

Table 16.154: 2: Motor Code Letter Table

Horsepower	Motor Code Letters
1/2 or less	A-L
3/4–1-1/2	A-K
2–3	A-J
5–25	A-H
30–125	A-G
150 or more	A-F

**NOTE:** The combination starter selection tables on page 16-51 to page 16-52 are suitable for motors with locked-rotor current letters according to NEC Table 430-7(b) as listed in Table 16.154. For other motors, a special thermal-magnetic circuit breaker with adjustable magnetic trip settings for the specific motor is required. When ordering for these special applications, specify the motor horsepower, voltage, frequency, full-load current, and code letter (or locked rotor current) to help ensure proper protection.

Table 16.155: Terminals

NEMA Size	Type	Type of Lug	Line Terminals on Disconnect		Power Terminals On Magnetic Starter			Control Terminals On Magnetic Starter		
			Wire Range		Type of Lug	Wire Range	Wires Per Terminal	Type of Lug	Wire Range	Wires Per Terminal
			Switch	Circuit Breaker						
0 & 1	SB & SC	Box Lug	14–1/0 Cu/Al	(1) 14-3/0 Al or Cu	Pressure Wire	14–8 Cu	1 or 2	Pressure Wire	16–12 Cu	2
2	SD	Box Lug	14–1/0 Cu/Al	(1) 14-3/0 Al or Cu	Box Lug	14–4 Cu	1	Pressure Wire	16–12 Cu	2
3	SE	Box Lug	14–1/0 Cu/Al	(1) 14-3/0 Al or Cu	Box Lug	14–0 Cu	1	Pressure Wire	16–12 Cu	2
4	SF	Box Lug	6–300 MCM Cu/Al	(1) 4-4/0 Al or Cu ( JLL Breaker 150 A - 175 A ) (1) 3/0 - 350 MCM Al or Cu ( JLL Breaker 200 A - 250 A )	Box Lug	8–250 MCM Cu	1	Pressure Wire	16–12 Cu	2
5	SG	Box Lug	One 4–500 MCM Cu	(1) 2 - 500 MCM Al or (1) 2 - 350 MCM Cu (DJL36400 Breaker) (2) 2/0 - 500 MCM Al or (2) 2/0 - 350 MCM Cu (DLL36600 Breaker) (1) 3/0 - 350 MCM Al or (1) 3/0 - 350 MCM Cu (JLL36250 Breaker)	Box Lug	4–500 MCM Cu	1	Pressure Wire	16–12 Cu	2
6	SH	Box Lug	—	(2) 2/0 - 500 MCM Al or (2) 2/0 - 350 MCM Cu (DJL36600 Breaker, DLL Breaker) (1) 2 - 600 MCM Al or (1) 2 - 350 MCM Cu (DJL36400 Breaker) (3) 3/0 - 500 MCM Al or (3) 3/0 - 350 MCM Cu (MJL36800 Breaker ) (3) 3/0 - 500 MCM Al or (3) 3/0 - 350 MCM Cu (PLL34080M68 Breaker)	Parallel Groove	250–500 MCM Cu <sup>[74]</sup>	1 or 2	Pressure Wire	16–12 Cu <sup>[75]</sup>	2
7	SJ	Box Lug	—	(4) 3/0 - 300 MCM Al or CU (PJL, PKL, PLL Breaker)	Parallel Groove	250–500 MCM Cu	1–4	Pressure Wire	16–12 Cu	2

[72] Standard enclosure includes: NEMA 1, 4 and 4X stainless, and 12/3R.  
 [73] Standard enclosure includes non-oversize NEMA 1, 4 and 4X stainless, and 12.  
 [74] Order Class 9999 Type SCU6 parts kit to convert power terminals to accept sizes 2/0–300 MCM wire.  
 [75] Terminal block range limited to 16–14.



**Accessories—Interlocks and Control Transformers**

A one or twopole electrical interlock can be added to the disconnect switch or circuit breaker. So if a separate control circuit is used, the magnetic starter can be de-energized when the disconnect is switched to the Off position. See Table 16.156 for proper interlock selection.

For electrical ratings of disconnect and circuit breaker interlocks, see Table 16.157.

An electrical interlock may also be factory installed in either a disconnect switch or circuit breaker combination starter. Specify **Form Y74** for single-pole or **Form Y75** for two-pole interlocks.

**Table 16.156: Disconnect Switch and Breaker Interlocks**

Class	Type	SPDT (Y74)		DPDT (Y75)	
		Class 9999 Type	Class 9999 Type	Class 9999 Type	Class 9999 Type
8538 [76]	SB, SC, SD (Series B)	R6	R7		
	SD (Series C)	R43	R44		
	SB, SC (Series C)	R45	R46		
8538, 8738	SE, SF (Series A)	R8	R9		
	SE (Series B & C)	R41	R42		
	SF (Series B & C)	R39	R40		
	SG	R35	R36		
	8539, 8739	SB, SC, SD, SE, SF, SG (Series K)	R26	R27	
8538	SBA, SCA, SBG, SCG (Series D and above)	TC11	TC21		
8538	SBAS8, SCAS8, SBGS8, SCGS8 (Series D and above)	TC10	TC20		
8738	SBAS8, SCAS8, SBGS8, SCGS8 (Series E and above)	TC10	TC20		
8738	SBA, SCA, SBG, SCG (Series E and above)	TC11	TC21		
8538	SDA, SDA[76], SDG, SDG[76] (Series D and above)	TC10	TC20		
8738	SDA, SDG (Series E and above)	TC10	TC20		
8538, 8738	SEA, SEG (Series D and above)	TC10	TC20		

**Table 16.157: Disconnect Switch and Breaker Interlock Electrical Ratings**

Class 9999 Type R6, 8, 26, 35, 39, 41, 43, 45, TC10, & TC11				Class 9999 Type R7, 9, 27, 36, 40, 42, 44, 46 & TC 20, 21					
AC—50 or 60 Hz									
Volts	Maximum Current			Volts	Maximum Current			Continuous Carrying Current (A)	
	Make (A)	Break (A)	Continuous Carrying Current (A)		Make (A)	VA	Break (A)		VA
120	40	15	15	120	30	3450	3	345	10
240	20	10	15	240	15	3450	1.5	345	10
480	10	6	15	480	7.5	3450	0.75	345	10
600	8	5	15	600	6	3450	0.6	345	10

**Table 16.158: Control Transformer Selection**

NEMA Size	Starter Type	Standard Capacity (Form FF4T)	Additional Capacity		
			50 VA (Form FF4T10)	100 VA (Form FF4T11)	200 VA (Form FF4T12)
Class 9070 Type [77]					
0 & 1	SB & SC	TF100	TF150	TF200	TF300 [78][79]
2	SD	TF100	TF150	TF200	TF300
3	SE	TF150	TF200	TF300	TF500
4	SF	TF300	TF300	TF500	T500
5	SG	TF100 and 8501XO20	TF100 and 8501XO20	TF150 and 8501XO20	TF300 and 8501XO20
6	SH	EO3S2 is standard	N/A	EO3FS2 and T100	EO3S2 and TF200
7	SJ	EO19S2 is standard	N/A	EO19S2 and TF100	EO3S2 and TF200

**NOTE:** 9070TF transformers are now standard in Series K combination starters.

**Internal Auxiliary Switch**—Circuit breakers can be supplied with a factory installed auxiliary switch for remote indication of an open and/or tripped or a closed breaker. One (specify **Form Y741**) or two (specify **Form Y751**) auxiliary switches can be supplied. The switches are supplied with normally open and normally closed circuits with a common connection. Contacts must be used on the same polarity and are rated 15 A at 240 Vac. The auxiliary switches are located internally and are furnished with 19-20 inch long leads.

**Alarm Switch**—The alarm switch only operates when the breaker is tripped. It is used to actuate bell alarms and warning lights. The alarm switch is factory installed only (specify **Form Y742**) and consists of a single pole single throw switch which is normally open except when the breaker is tripped. The contacts are rated 4 A at 240 Vac. This switch is located in the breaker and is supplied with 19-20 inch long leads.

**Transformer Selection**—Space and drilling are provided in all disconnect switch and circuit breaker combination starters in NEMA 1, 4 & 4X stainless and polyester, 12 and 7 & 9 bolted enclosures for the field addition (or factory installation) of a Class 9070 control circuit transformer and Class 9999 Type SFR4 fuse holder. This kit can be either panel mounted or side mounted on the Type S starter. For standard control transformer selection in combination starters, see . Consult the field office for transformer additions to NEMA 7 and 9 Spin Top™ enclosures. For secondary fuse holder, order 9080PF1.

**Fuse Block Mounting Brackets**—The standard capacity transformer, Class 9070 Type T100, for the Size 0 and 1 starters mounts to the right of the magnetic starter.

**Standards**—Most combination starters and forms are UL Listed in file E152395, Category NKJH, and CSA File CR 584.

[76] Class 8538 type numbers ending in suffix **S8**.

[77] Complete the contactor or starter Class and Type with the voltage code. See *Full Voltage Contactors and Starters Forms*, page 16-118.

[78] Requires oversized enclosure. (Size 2 reversing enclosure.)

[79] Available in standard enclosure with Mag-Gard™ circuit breaker and non-fusible disconnect switch. Requires oversized enclosure with thermal-magnetic circuit breakers and fusible disconnect switches. (Size 2 reversing enclosure.)

Approximate Dimensions

Table 16.159: See Figure: NEMA 1 Enclosure, Sizes 0–2

NEMA Size	Class	Type	Dimensions, in. [80]														Top & Bottom		Sides	Wt. (lb)		
			A	B	C	D	E	F	G	H	I	J	K	L	M	N	O	P	W		X	Y
0-1	8538	SBG, SCG	9.5	22.5	8.34	6.38	20.5	14.66	1.81	1.69	3	2.31	1.06	3.25	2.19	1.25	0.88	—	0.5-0.75	0.5-0.75	0.5	38
	8539	SBG, SCG	9.5	22.5	9.84	6.38	20.5	14.66	1.81	1.69	3	2.31	1.06	3.25	2.19	1.25	0.88	—	0.5-0.75	0.5-0.75	0.5	38
2	8538, 8539	SDG	10.5	26	9.59	7.38	24	16.91	2.13	2	4	2.31	1.06	3.25	2.19	1.25	0.88	—	1-1.25	0.5-0.75	0.5	54

Table 16.160: See Figure: NEMA 1 Enclosure, Sizes 3–6

NEMA Size	Class	Type	Dimensions, in. [80]														Top & Bottom		Sides	Wt. (lb)		
			A	B	C	D	E	F	G	H	I	J	K	L	M	N	O	P	W		X	Y
3 [81]	8538, 8539	SEG	15.25	42	10.59	9.25	3	22.72	41	0.5	—	2.83	3.53	5	2.69	5.38	1.28	0.91	1-1.25 2-2.5	0.5-0.75	0.5	102
4	8538	SFG	16	52.5	10.53	10	3	23.66	51.5	0.5	—	2.83	3.53	5	2.69	5.38	1.28	0.91	2.5	0.5-0.75	0.5	163
	8539	SFG	16	52.5	10.53	10	3	23.66	51.5	0.5	—	2.83	3.53	5	2.69	5.38	1.28	0.91	2.5	0.5-0.75	0.5	163
5	8538	SGG	20	78	15.5	12	4	29.41	77	0.5	—	3.52	4.61	9.25	3.19	—	—	—	0.5-0.75 [82]	3	—	450
	8539	SGG	20	66	13.72	12	4	29.41	65	0.5	—	3.52	4.61	5	3.19	—	—	—	0.5-0.75	3	—	420
6 [83]	8538, 8539	SHG	36	90	21.03	—	—	41.38	—	—	—	—	—	5	—	—	—	—	—	—	—	—

Table 16.161: See Figure: NEMA 12/3R Enclosure

NEMA Size	Class	Type	Dimensions, in. [84]										Wt. (lb)
			A	B	C	D	E	F	G	H	I	J	
0-1	8538	SBA	9.5	8.34	24	3.25	2.5	4.5	23.5	0.59	4.44	14.31	40
	8539	SCA	9.5	9.84	24	3.25	2.5	4.5	23.5	0.59	4.44	14.31	40
2	8538, 8539	SDA	10.5	9.59	27.75	3.25	2.5	5.5	27	0.38	4.13	16.56	55
3 [81]	8538, 8539	SEA	15.25	10.59	42	5	3	9.25	41	0.5	5.06	22.31	111
4	8538	SFA	16	10.53	52.5	5	3	10	51.5	0.5	4.19	22.97	170
	8539	SFA	16	10.53	52.5	5	3	10	51.5	0.5	5.19	22.97	170
5	8538	SGA	20	13.72	78	9.25	4	12	77	0.5	7.78	29.41	—
	8539	SGA	20	13.72	66	5	4	12	65	0.5	7.78	27.41	440
6 [83]	8538, 8539	SHA	36	17	90	5	—	—	—	—	—	47.38	—

Table 16.162: See Figure: NEMA 4 and 4X Stainless Steel Enclosure

NEMA Size	Class	Type	Dimensions, in. [80]												Bottom	Top & Bot.	Wt. (lb)
			A	B	C	D	E	F	G	H	I	J	K	L	W	X	
0-1	8538	SBW	9.5	8.34	24.06	3.25	2.5	4.5	23.5	0.59	3.03	1.31	2.31	14.28	0.75 Hub	1 Hub	40
	8539	SCW	9.5	9.84	24.06	3.25	2.5	4.5	23.5	0.59	3.03	1.31	2.31	14.28	0.75 Hub	1 Hub	40
2	8538, 8539	SDW	10.5	9.59	27.75	3.25	2.5	5.5	27	0.59	3	2	2.63	16.53	0.75 Hub	1.5 Hub	55
3 [81]	8538, 8539	SEW	15.25	10.59	42	5	3.19	10.25	40.5	0.59	3	2.56	3.19	22.19	0.75 Hub	2.5 Hub	111
4	8538	SFW	16	10.53	52.5	5	3.56	11	51	0.59	3	2.56	3.19	22.47	0.75 Hub	2.5 Hub	158
	8539	SFW	16	10.53	52.5	3.25	2.5	11	51	0.59	3	2.56	3.19	22.47	0.75 Hub	2.5 Hub	120
5	8538	SGW	20	13.72	78	9.25	4	12	77	0.56	4.5	3	3.5	29.41	0.75 Hub	3.5 Hub	—
	8539	SGW	20	13.72	66	5	4	12	65	0.56	4.5	3	3.5	29.41	0.75 Hub	3.5 Hub	440
6 [83]	8538, 8539	SHW	36	17	90	—	—	—	—	—	—	—	—	47.88	—	—	—

NOTE: These dimensions are for reference only. If you need precise measurements, contact the Customer Care Center at 1-888-778-2733.

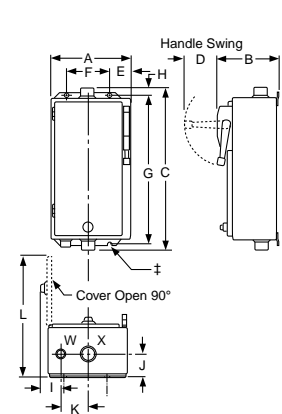
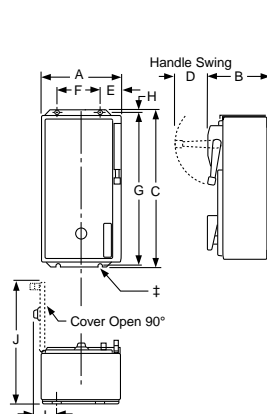
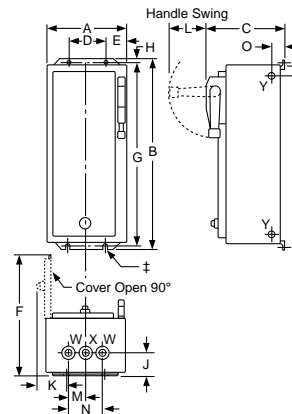
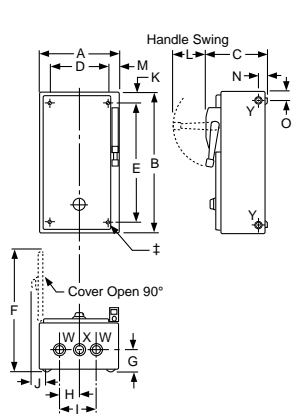

Figure 16.3: NEMA 1 Enclosure, Size 0–2      Figure 16.4: NEMA 1 Enclosure, Size 3–6      Figure 16.5: NEMA 12 Enclosure      Figure 16.6: NEMA 4 and 4X Stainless Steel Enclosure

± = 4 mounting holes: 0.31 in. (8 mm) dia. for Sizes 0, 1, and 2; 0.44 in. (11 mm) dia. for Sizes 3 and 4; 0.56 in. (14 mm) dia., located on external flanges, for Size 5.

NOTE: Illustrations may not represent the actual enclosure. They are intended for dimensional information only.

[80] Dimensions also for Form FF4T (standard control transformer). Form FF4T11 (100 VA extra capacity) and Form FF4T12 (200 VA extra capacity) could require the use of an oversized enclosure. Refer to .

[81] Class 8538 Size 3 devices with 200 A fuse clips use dimensions for Class 8538 Size 4.

[82] Left side only.

[83] Size 6 enclosures are floor mounting.

[84] Dimensions include space for control circuit transformers.



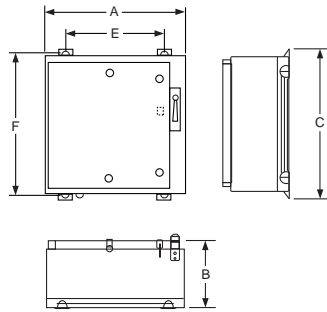

**Figure 16.7: NEMA 4X Polyester Enclosure**

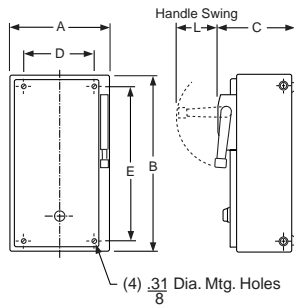

**Figure 16.8: Class 8538 and 8539 in Oversize Enclosures—NEMA 1, 4 & 4X Stainless, and 12/3R**

**Enclosures**

**NOTE:** These dimensions are for reference only. If you need precise measurements, contact the Customer Care Center at 1-888-778-2733.

**Table 16.163: See Figure: NEMA 4X Polyester Enclosure, page 16-59 [85]**

NEMA Size	Class	Type	Dimensions, in.				
			A	B	C	E	F
0, 1	8538	SBW	13.72	11.4	26.94	6.25	25.75
0, 1	8539	SCW SDW					
0, 1, & 2	8738, 8739	SBW	25.25	11.4	27.00	17.88	25.75
2	8538, 8539	SCW SDW					
3-4	8538, 8738 8539, 8739	SEW SFW [86]	26.31	11.4	33.50	18.50	32.25

**Table 16.164: See Figure: Class 8538 and 8539 in Oversize Enclosures—NEMA 1, 4 & 4X Stainless, and 12/3R, page 16-59**

NEMA Size	NEMA Type Encl.	Dimensions, in.					
		Wide A	High B	Deep C	Handle L	Mounting	
						D	E
0-2	1	15	28.33	9.59	3.25	11.625	26.25
	4	15	30.03	9.59	3.25	10	29.75
	12	15	31	10.97	3.25	9	30.25

**Information on Hubs**

Hubs are supplied with each NEMA Type 4X combination starter as shown in Table 16.165.

Note that hubs are only installed in stainless steel enclosures; they are not installed in polyester enclosures.

**Table 16.165: Hub Sizes**

NEMA Size	Quantity	Hub Size (in.)
0 and 1	1	0.75
	2	1.00
2	1	0.75
	2	1.50
3 and 4	1	0.75
	2	2.50

**NOTE:** Illustrations may not represent the actual enclosure—they are intended for dimensional information only.

**Table 16.166: Conduit Sizes LOC A, B, C and D**

NEMA Size	Standard
0-1	1.25
2	1.5
3-4	2.5
5	4

[85] Dimensions also for Form F4T (standard control transformer) and Form F4T10 (50 VA additional capacity). Other control transformers may require the use of oversized enclosures. Refer to

[86] 8539 Size 4 only.



NEMA 00, 0, and 1 Reversing Contactor

**General Information**

Class 8702 Type S reversing magnetic contactors are used for starting, stopping, and reversing AC motors where overload protection is separately provided. Class 8702 reversing contactors consist of two Class 8502 contactors mechanically and electrically interlocked. Open type devices, Sizes 0–5, are available in either horizontal or vertical arrangements. Sizes 00, 6, and 7 are available as horizontal only. Enclosed devices, Size 00–7, use horizontally arranged components. Type S reversing contactors are designed for operation at up to 600 Vac, 50/60 Hz.

**NOTE:** In Table 16.167, replace the three bullets (●●●) in the catalog number with the coil voltage code. Refer to the standard coil voltage codes listed in Table 16.168.

For information on field modification of NEMA 12 enclosures, see page 16-112.

**Table 16.167: 600 Vac Maximum—50–60 Hz**

NEMA Size	Continuous Current Ratings	Motor Voltage	Max. Hp	Open Type		NEMA 1 General Purpose Enclosure	NEMA 4 & 4X Watertight, Dusttight Brushed Stainless Steel Enclosure (Sizes 0–5) <sup>[1]</sup>	NEMA 7 & 9 <sup>[2]</sup> Hazardous Locations, Div. 1 & 2 Class I, Groups C & D Class II, Groups E, F & G		NEMA 12/3R/3J Dusttight & Driptight Industrial Use Enclosure
				Vertical Type	Horizontal Type	Type	Type	Bolted Aluminum Type	SPIN TOP™ Type	Type
00	9	200 230 460 575	1.5 1.5 2 2	—	SAO4●●●	SAG4●●●	Use Size 0	Use Size 0	Use Size 0	Use Size 0
0	18	200 230 460 575	3 3 5 5	SBO12●●●	SBO4●●●	SBG4●●●	SBW14●●●	SBT49●●●	SBR9●●●	SBA4●●●
1	27	200 230 460 575	7.5 7.5 10 10	SCO7●●●	SCO8●●●	SCG8●●●	SCW14●●●	SCT49●●●	SCR9●●●	SCA4●●●
2	45	200 230 460 575	10 15 25 25	SDO1●●●	SDO2●●●	SDG2●●●	SDW11●●●	SdT43●●●	SDR3●●●	SDA1●●●
3	90	200 230 460 575	25 30 50 50	SEO1●●●	SEO2●●●	SEG2●●●	SEW11●●●	—	—	SEA1●●●
4	135	200 230 460 575	40 50 100 100	SFO1●●●	SFO3●●●	SFG3●●●	SFW11●●●	—	—	SFA1●●●
5	270	200 230 460 575	75 100 200 200	SGO1●●●	SGO3●●●	SGG3●●●	SGW11●●●	—	—	SGA1●●●
6	540	200 230 460 575	150 200 400 400	—	SHO1●●●	SHG1●●●	SHW1●●●	—	—	SHA1●●●
7	810	200 230 460 575	300 600 600	—	SJO1●●●	SJG1●●●	SJW1●●●	—	—	SJA1●●●

**Table 16.168: Coil Voltage Codes**

Voltage		Code
60 Hz	50 Hz	
24 <sup>[4]</sup>	—	V01
120 <sup>[5]</sup>	110	V02
208	—	V08
240	220	V03
277	—	V04
480	440	V06
600	550	V07
Specify	Specify	V99

**NOTE:** For voltage codes used with control transformers, see page 16-118. Form S (separate control) is used when a separate source of power is available for the control (coil) voltage. Form S is available at no charge.

Dimensions: page 16-64  
 Factory Modifications (Forms) page 16-117  
 Separate Enclosures (Class 9991): page 16-110  
 Replacement Parts (Class 9998): page 16-122  
 Type S Accessories (Class 9999): page 16-125

For How to Order Information, see page 16-28.

[1] NEMA 4 and 4X stainless steel enclosures (sizes 0–5) have a brushed finish. Sizes 6 and 7 are painted sheet steel and are rated NEMA 4 only.

[2] NEMA 7 and 9 bolted are not UL listed.

[3] NEMA 12 enclosures can be field modified for outdoor non-corrosive and non-service entrance rated applications.

[4] 24 V coils are not available on Sizes 4-7. On Sizes 00-3, where 24 V coils are available, **Form S** (separate control) can be specified (i.e., order as 8702SAO4V01S).

[5] This voltage code can include **Form S** for separate control (provided at no charge) (for example, order as 8702SAO4V02S).

Single-Phase and 4-Pole Polyphase

NOTE: In Table 16.169, replace the three bullets (●●●) in the catalog number with the coil voltage code. Refer to the standard coil voltage codes listed in Table 16.168.

For information on field modification of NEMA 12 enclosures, see page 16-112.

Table 16.169: 600 Vac Maximum—50–60 Hz

NEMA Size	Continuous Current Ratings	Motor Voltage	Max. Hp	Type of Motor	Open Type		NEMA 1 General Purpose Enclosure	NEMA 4 & 4X Watertight, Dusttight Brushed Stainless Steel Enclosure	NEMA 7 & 9 [6] Hazardous Locations, Div. 1 & 2 Class I, Groups C & D Class II, Groups E, F & G		NEMA 12/3R [7] Dusttight & Driptight Industrial Use Enclosure
					Vertical Type	Horizontal Type	Type	Type	Bolted Type	Spin Top™ Type	Type
<b>2-Pole Single Phase</b>											
00	9	115 230	1/3 1	Single Phase 3-Wire	—	SAO1●●●	SAG1●●●	Use Size 0	Use Size 0	Use Size 0	Use Size 0
0	18	115 230	1 2		SBO9●●●	SBO1●●●	SBG1●●●	SBW11●●●	SBT46●●●	SBR6●●●	SBA1●●●
1	27	115 230	2 3		SCO1●●●	SCO2●●●	SCG2●●●	SCW11●●●	SCT46●●●	SCR6●●●	SCA1●●●
<b>3-Pole Single Phase</b>											
00	9	115 230	1/3 1	4-Wire Rep.-Ind.	—	SAO2●●●	SAG2●●●	Use Size 0	Use Size 0	Use Size 0	Use Size 0
		115 230	1/3 1	4-Wire Split Ph.	—	SAO3●●●	SAG3●●●	Use Size 0	Use Size 0	Use Size 0	Use Size 0
0	18	115 230	1 2	4-Wire Rep.-Ind.	SBO10●●●	SBO2●●●	SBG2●●●	SBW12●●●	SBT47●●●	SBR7●●●	SBA2●●●
		115 230	1 2	4-Wire Split Ph.	SBO11●●●	SBO3●●●	SBG3●●●	SBW13●●●	SBT48●●●	SBR8●●●	SBA3●●●
1	27	115 230	2 3	4-Wire Rep.Ind.	SCO3●●●	SCO4●●●	SCG4●●●	SCW12●●●	SCT47●●●	SCR7●●●	SCA2●●●
		115 230	2 3	4-Wire Split Ph.	SCO5●●●	SCO6●●●	SCG6●●●	SCW13●●●	SCT48●●●	SCR8●●●	SCA3●●●
<b>4-Pole Polyphase</b>											
0	18	200 230 460 575	3 3 5 5	2 Phase 4-Wire	SBO13●●●	SBO5●●●	SBG5●●●	SBW15●●●	Consult the Customer Care Center at 1-888-778-2733	SBR10●●●	SBA5●●●
		1	27		200 230 460 575	7.5 7.5 10 10	SCO9●●●	SCO10●●●		SCG10●●●	SCW15●●●
2	45				200 230 460 575	10 15 25 25	—	SDO4●●●		SDG4●●●	SDW12●●●
		3	90		200 230 460 575	25 30 50 50	—	SEO4●●●	SEG4●●●	SEW12●●●	—
4	135				200 230 460 575	40 50 100 100	—	SFO4●●●	SFG4●●●	SFW12●●●	—

Auxiliary Units

Table 16.170 shows the maximum number of auxiliary units (in addition to the holding circuit and interlocking contacts) that can be added to either the forward or reverse contactor or starter.

Table 16.170: Auxiliary Units—Class 8702, 8736, and 8810

NEMA Size (Type)	No. of Poles—Basic Contactor	Maximum number of auxiliary units on each contactor, forward or reverse (in addition to internal holding circuit and interlocking contacts)
00 (SA)	2–3	2 single circuit auxiliary contacts (N.O. or N.C.)
0–2 (SB–SD)	2–3	4 single circuit auxiliary contacts (N.O. or N.C.) [8]
	4	2 single circuit auxiliary contacts (N.O. or N.C.)
3–7 (SE–SJ)	Any	2 single circuit auxiliary contacts (N.O. or N.C.)

Dimensions: page 16-64  
Factory Modifications (Forms): page 16-117  
Separate Enclosures (Class 9991): page 16-110  
Replacement Parts (Class 9998): page 16-122  
Type S Accessories (Class 9999): page 16-125  
For How to Order Information, see page 16-28.

[6] NEMA 7 and 9 bolted are not UL listed.  
[7] NEMA 12 enclosures can be field modified for outdoor non-corrosive and non-service entrance rated applications.  
[8] When adding 4 external auxiliary contacts to one Size 0 or 1 contactor, remove one of the return springs.

Introduction and Overload Relays

NEMA Sizes 00, 0, 1 Reversing Starter



Horizontal Type

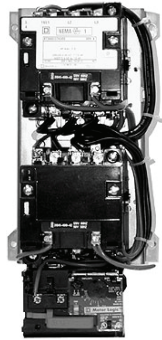

Vertical Type

Class 8736 Type S reversing magnetic starters are used for full-voltage starting, stopping, and reversing AC squirrel cage motors. Class 8736 starters consist of one Class 8502 contactor and one Class 8536 starter mechanically and electrically interlocked. Open type devices, Sizes 0–5, are available in either horizontal or vertical arrangements. Sizes 00, 6, and 7 are available as horizontal only. Enclosed devices use horizontally arranged components. Type S starters are designed for operation at up to 600 Vac, 50/60 Hz. For How to Order Information, see page 16-28

Motor Logic™ Solid-State Overload Relay (SSOLR) Protection

These ambient insensitive overload relays are available on three phase sizes 00 through 6 and standard on size 7. They provide phase loss, phase unbalance protection. To order, add Form H30 (for selectable trip class 10 or 20 protection). For more information about Motor Logic solid-state overload relays (SSOLRs), see pages 16-101 and page 16-119. (Catalog no. example: 8736SCO8V06H30)

**New!** Adapted Bimetallic or Solid-State Overload Relay (NEMA Sizes 00–1)

The Adapted Bimetallic or Solid-State starter includes a specially designed adapter that attaches with bus bars to the Type S NEMA contactor. This adapter allows direct mounting of the IEC Style bimetallic (LRD or LR3D) or solid-state (LR9D) overload relay (OLR). To order this starter configuration, add Form E (adapter only) to the standard catalog number. The LRD, LR3D, or LR9D OLR must be purchased separately, based on the FLA of the motor, and installed in the field to properly operate the starter. For the Adapted Bimetallic device only, if the FLA is known at the time of purchase, you can order the starter with the OLR installed. For more information and a list of options, see Adapted Bimetallic Overload Relay Forms, page 16-119. (Catalog no. example: 8736SCO8V06E—without OLR)

**New!** TeSys T Motor Management System (NEMA Sizes 1–6)

TeSys T is a flexible system that integrates seamlessly into your automation system through five major communication protocols. TeSys T can predict what will happen in the process, as it accurately monitors current, voltage, and power over a wide range. For additional information about the TeSys T Motor Management System, see page 16-103 (for example, 8736SCO8V06H616).

Melting Alloy Overload Relays

Melting alloy type thermal overload blocks are installed as part of the starter, and thermal elements must be selected and installed separately in order to operate the starter. For a three-phase motor, three thermal units must be ordered using the tables beginning under page 16-133. The catalog number includes no Form number (for example, 8736SCO8V06).

Type S Reversing Starters, 3–Pole Polyphase

**NOTE:** In Table 16.171, replace the three bullets (●●●) in the catalog number with the coil voltage code. Refer to the standard coil voltage codes shown in . For information on field modification of NEMA 12 enclosures, see page 16-112. For Form H30\* (special lower-FLA factory-assembled starter combinations with Motor Logic SSOLR protection), see Solid-State Overload Relay Forms, page 16-119.

Table 16.171: 3–Pole Polyphase, 600 Vac Maximum, 50–60 Hz, with Motor Logic SSOLR [9]

NEMA Size	Continuous Current Ratings	Motor Voltage	Max. Hp	Open Style		NEMA 1 General Purpose Enclosure	NEMA 4 & 4X Watertight, Dusttight Brushed Stainless Steel Enclosure (Sizes 0–5) [10]	NEMA 7 & 9 [11] Hazardous Locations Class I, Groups C & D Class II, Groups E, F & G		NEMA 12/3R [12] Dusttight, Driptight Industrial Use Enclosure
				Vertical	Horizontal			Bolted, Type	SPIN-TOP™, Type	
				Type	Type					
00	9	200 230 460 575	1.5 1.5 2 2	—	SAO16●●●H30 [13]	SAG16●●●H30 [13]	Use Size 0	Use Size 0	Use Size 0	Use Size 0
0	18	200 230 460 575	3 3 5 5	SBO10●●●H30 [13]	SBO4●●●H30 [13]	SBG4●●●H30 [13]	SBW14●●●H30 [13]	SBT49●●●H30 [13]	SBR9●●●H30 [13]	SBA4●●●H30 [13]
1	27	200 230 460 575	7.5 7.5 10 10	SCO7●●●H30 [13]	SCO8●●●H30 [13]	SCG8●●●H30 [13]	SCW14●●●H30 [13]	SCT49●●●H30 [13]	SCR9●●●H30 [13]	SCA4●●●H30 [13]
2	45	200 230 460 575	10 15 25 25	SDO1●●●H30 [13]	SDO2●●●H30 [13]	SDG2●●●H30 [13]	SDW11●●●H30 [13]	SDT43●●●H30 [13]	SDR3●●●H30 [13]	SDA1●●●H30 [13]
3	90	200 230 460 575	25 30 50 50	SEO1●●●H30	SEO2●●●H30	SEG2●●●H30	SEW11●●●H30	—	—	SEA1●●●H30
4	135	200 230 460 575	40 50 100 100	SFO1●●●H30	SFO3●●●H30	SFG3●●●H30	SFW11●●●H30	—	—	SFA1●●●H30
5	270	200 230 460 575	75 100 200 200	SGO1●●●H30	SGO3●●●H30	SGG3●●●H30	SGW11●●●H30	—	—	SGA1●●●H30

[9] To order melting alloy overload relay, remove form "H30" from part number.

[10] NEMA 4 and 4X stainless steel enclosures (sizes 0–5) have a brushed finish. Sizes 6 and 7 are painted sheet steel and are rated NEMA 4 only.

[11] NEMA 7 and 9 bolted are not UL listed.

[12] NEMA 12 enclosures can be field modified for outdoor non-corrosive and non-service entrance rated applications.

[13] Form H30, with the possibility of a fourth character to select a lower FLA range (for example, H308). See "Solid-State Overload Relay Forms" on page 16-119

**Table 16.171 3-Pole Polyphase, 600 Vac Maximum, 50–60 Hz, with Motor Logic SSOLR [16.171] (cont'd.)**

NEMA Size	Continuous Current Ratings	Motor Voltage	Max. Hp	Open Style		NEMA 1 General Purpose Enclosure	NEMA 4 & 4X Watertight, Dusttight Brushed Stainless Steel Enclosure (Sizes 0–5) [14]	NEMA 7 & 9 [15] Hazardous Locations Class I, Groups C & D Class II, Groups E, F & G		NEMA 12/3R [16] Dusttight, Driptight Industrial Use Enclosure
				Vertical	Horizontal			Bolted, Type	SPIN-TOP™, Type	
				Type	Type	Type	Type	Type		
6	540	200 230 460 575	150 200 400 400	—	SHO1●●●H30	SHG1●●●H30	SHW1●●●H30	—	—	SHA1●●●H30
7	810	200 230 460 575	300 600 600	—	SJO1●●●H30	SJG1●●●H30	SJW1●●●H30	—	—	SJA1●●●H30

**Type S, 2- and 3-Pole Single Phase, 4-Pole Polyphase**

Devices require melting alloy thermal units, page 16-132.

**NOTE:** In Table 16.172, replace the three bullets (●●●) in the catalog number with the coil voltage code. Refer to the standard coil voltage codes shown in .

For information on field modification of NEMA 12 enclosures, see page 16-112 .

**Table 16.172: 2- and 3-Pole Single Phase, 4-Pole Polyphase, 600 Vac Maximum—50–60 Hz**

NEMA Size	Continuous Current Ratings	Motor Voltage	Max. Hp	Type of Motor	Open Type		NEMA 1 General Purpose Enclosure	NEMA 4 & 4X Watertight, Dusttight Brushed Stainless Steel Enclosure	NEMA 7 & 9 [15] Hazardous Locations Class I, Groups C & D Class II, Groups E, F & G		NEMA 12/3R [16] Dusttight Industrial Use Enclosure
					Vertical Type	Horizontal Type			Bolted Type	Spin Top™ Type	
<b>2-Pole Single Phase—1 Thermal Unit Required</b>											
00	9	115 230	1/3 1	Single Phase 3-Wire	—	SAO13●●●	SAG13●●●	Use Size 0	Use Size 0	Use Size 0	Use Size 0
0	18	115 230	1 2		SBO7●●●	SBO1●●●	SBG1●●●	SBW11●●●	SBT46●●●	SBR6●●●	SBA1●●●
1	27	115 230	2 3		SCO1●●●	SCO2●●●	SCG2●●●	SCW11●●●	SCT46●●●	SCR6●●●	SCA1●●●
<b>3-Pole Single Phase—1 Thermal Unit Required</b>											
00	9	115 230	1/3 1	4-Wire Rep.-Ind.	—	SAO14●●●	SAG14●●●	Use Size 0	Use Size 0	Use Size 0	Use Size 0
		115 230	1/3 1	4-Wire Split Ph.	—	SAO15●●●	SAG15●●●	Use Size 0	Use Size 0	Use Size 0	Use Size 0
0	18	115 230	2 2	4-Wire Rep.-Ind.	SBO8●●●	SBO2●●●	SBG2●●●	SBW12●●●	SBT47●●●	SBR7●●●	SBA2●●●
		115 230	1 2	4-Wire Split Ph.	SBO9●●●	SBO3●●●	SBG3●●●	SBW13●●●	SBT48●●●	SBR8●●●	SBA3●●●
1	27	115 230	2 3	4-Wire Rep.-Ind.	SCO3●●●	SCO4●●●	SCG4●●●	SCW12●●●	SCT47●●●	SCR7●●●	SCA2●●●
		115 230	2 3	4-Wire Split Ph.	SCO5●●●	SCO6●●●	SCG6●●●	SCW13●●●	SCT48●●●	SCR8●●●	SCA3●●●
<b>4-Pole Polyphase—2 Thermal Units Required</b>											
0	18	200 230 460 575	3 3 5 5	2 Phase 4-Wire	SBO11●●●	SBO5●●●	SBG5●●●	SBW15●●●	Consult the Customer Care Center at 1-888-778-2733	SBR10●●●	SBA5●●●
1	27	200 230 460 575	7.5 7.5 10 10		SCO9●●●	SCO10●●●	SCG10●●●	SCW15●●●		SCR10●●●	SCA5●●●
2	45	200 230 460 575	10 15 25 25		—	SDO4●●●	SDG4●●●	SDW12●●●		SDR4●●●	SDA2●●●
3	90	200 230 460 575	25 30 50 50		—	SEO4●●●	SEG4●●●	SEW12●●●	—	—	SEA2●●●
4	135	200 230 460 575	40 50 100 100		—	SFO4●●●	SFG4●●●	SFW12●●●	—	—	SFA2●●●

**Table 16.173: Coil Voltage Codes**

Voltage		Code
60 Hz	50 Hz	
24 [17]	—	V01
120 [18]	110	V02
208	—	V08
240	220	V03
277	—	V04
480	440	V06
600	550	V07
Specify	Specify	V99

**NOTE:** For voltage codes used with control transformers, see page 16-118. Form S (separate control) is used when a separate source of power is available for the control (coil) voltage. Form S is supplied at no charge.

Dimensions: page 16-64  
 Factory Modifications (Forms) page 16-117  
 Separate Enclosures (Class 9991): page 16-110  
 Replacement Parts (Class 9998): page 16-122  
 Type S Accessories (Class 9999): page 16-125

For How to Order Information, see page 16-28.

[14] NEMA 4 and 4X stainless steel enclosures (sizes 0–5) have a brushed finish. Sizes 6 and 7 are painted sheet steel and are rated NEMA 4 only.

[15] NEMA 7 and 9 bolted are not UL listed.

[16] NEMA 12 enclosures can be field modified for outdoor non-corrosive and non-service entrance rated applications.

[17] 24 V coils are not available on Sizes 4–7. On Sizes 00–3, where 24 V coils are available, Form S (separate control) must be specified (for example, order as 8736SCO1V01S).

[18] This voltage code can include Form S for separate control (provided at no charge) (for example, order as 8736SBO7V02S).

Open and NEMA 1 Enclosures

NOTE: These dimensions are for reference only. If you need precise measurements, contact the Customer Care Center at 1-888-778-2733.

Table 16.174: Open Style, 2 or 3-Pole Only (Mounting: H = Horizontal; V = Vertical)

See Figures: Class 8702 Contactor, Open Type and Class 8736 Starter, Open Type

NEMA Size	Type	Mtg.	Fig. No.	Dimensions, in.													Wt. (lb)
				A	B	C	D	E	F	G	H	I	J	K	L	M	
<b>Class 8702 Contactors</b>																	
00	SAO	H	1	7.13	5	5.31	—	—	3.41	0.47	4.34	0.19	5.5	0.91	—	—	12
0, 1	SBO	H	1	7.13	5	5.31	—	—	3.41	0.47	4.34	0.19	5.5	0.91	—	—	12
	SCO	V	1[19]	5.47	9.22	5.31	5.5	0.22	—	0.61	8	0.61	5.03	0.22	—	—	12
2	SDO	H	1	9	6.88	6.03	—	—	4.5	0.38	5.63	0.25	6	1.5	—	—	16
		V	1[19]	6.75	11.38	6.03	6.25	0.25	—	0.5	10.38	0.5	0.25	0.25	—	—	16
3	SEO	H	1	12.72	7.97	7	11.75	0.48	—	0.48	7	0.48	11.75	0.48	—	—	35
		V	1[19]	7.20	19	7	6.25	0.48	—	1.02	17	0.98	6.25	0.48	—	—	35
4	SFO	H	1	14.25	11.69	7	13.25	0.5	—	0.5	8	1.84	13.25	0.5	—	—	45
		V	1[19]	7.97	23.91	7	7	0.48	—	1.81	20.25	1.19	7	0.48	—	—	45
5	SGO	H	1	19.31	16.19	9.38	18	0.66	—	1.03	14	1.16	18	0.66	—	—	98
		V	1[19]	10.75	34.41	9.38	9.5	0.63	—	1.25	32	1.16	9.5	0.63	—	—	98
6	SHO	H	1	22.38	28.05	9.52	18	0.63	—	3.83	21.19	3.03	18	0.77	—	—	195
7	SJO	H	1	24.25	37.25	13.81	19.75	1.52	—	—	30	—	—	—	—	—	310
<b>Class 8736 Starters</b>																	
00	SAO	H	2	7.13	6.91	5.31	—	—	3.41	0.47	4.34	6.22	4.53	5.06	0.66	—	13
0, 1	SBO	H	2	7.13	6.91	5.31	—	—	3.41	0.47	4.34	6.22	4.53	5.06	0.66	—	13
	SCO	V	2[19]	5.47	11.52	5.31	5.03	0.22	—	0.61	8	10.70	2.52	5.06	0.22	5.03	13
2	SDO	H	2	9	8.5	6.03	—	—	4.5	0.38	5.63	7.5	5	5.16	1.5	—	18
		V	2[19]	6.75	13.48	6.03	6.25	0.25	—	0.78	10.38	12.97	3.13	5.16	0.25	6	18
3	SEO	H	2	12.72	11.72	7	11.75	0.48	—	0.48	10.75	10.75	6.25	6.25	0.48	11.75	38
		V	2[19]	7.31	22.25	7	6.25	0.48	—	1.02	20.75	—	6.25	6.25	0.48	6.25	38
4	SFO	H	2	14.25	14.59	7	13.25	0.5	—	1.84	12.25	12.25	13.25	6.25	0.5	13.25	48
		V	2[19]	7.97	26.81	7	7	0.48	—	1.84	24.5	—	4.05	6.25	0.48	7	48
5	SGO	H	2	19.31	20.91	9.38	18	0.66	—	1.28	19	19	18	6.63	0.63	18	115
		V	2[19]	10.75	39.16	9.38	9.5	0.66	—	1.28	37.25	37.25	9.5	6.63	0.63	9.5	115
6	SHO	H	2	22.38	28.05	9.52	18	0.69	—	3.83	21.19	3.03	18	0.77	—	—	200
7	SJO	H	1	24.25	37.25	13.81	19.75	1.52	—	—	30	—	—	—	—	—	315

16 NEMA AND DEFINITE PURPOSE CONTACTORS AND STARTERS

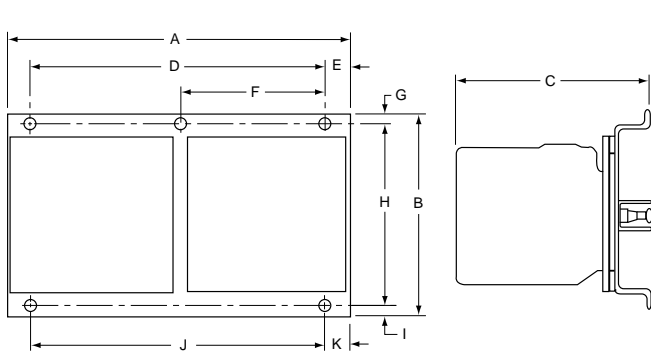

Figure 16.9: Class 8702 Contactor, Open Type

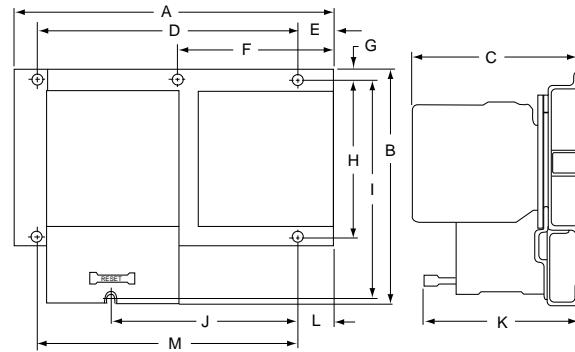

Figure 16.10: Class 8736 Starter, Open Type

Table 16.175: NEMA 1, Class 8702 and 8736 (see Figure: NEMA 1)

NEMA Size	Dimensions—In.										Weight (lb)	
	A	B	C		D	E	F	G	H	I	8702	8736
00, 0 [20]	11.88	11.88	7.41	7.53	9.75	1.06	1.06	9.75	1.06	0.31	16	17
1 [21]	14.88	14.13	7.56	7.66	12.75	1.06	1.06	12	1.06	0.31	24	25
2 [21]	18.16	29.16	9.25	9.25	15.5	1.33	1.33	26.5	1.33	0.44	95	98
3 [20]	35.22	46.22	12.81	12.94	31	2.11	2.11	42	2.11	0.56	298	315
4 [20]	36.22	62.22	19.47		Floor Mounting.						400	405
5	34.5	93	23.5								—	—

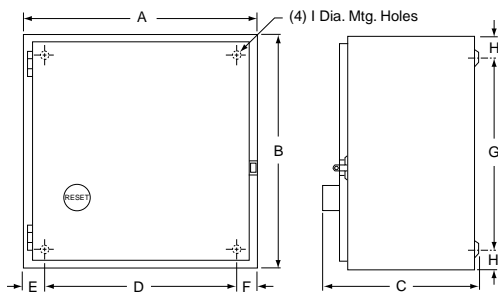

Figure 16.11: NEMA 1

[19] The vertical design differs from the horizontal design figure shown for the corresponding NEMA size, but the dimensions listed apply.

[20] 3-Pole only.

[21] The standard enclosure has space for a fused control transformer, Form FF4T, on Sizes 0-2 (except 4-pole devices, Size 0 and 1).

**NEMA 4, 4X, 7, 9, and 12/3R Enclosures**

Table 16.176: See Figure: NEMA 4 and 4X—Stainless Steel [22]

NEMA Size	Class Number	Dimensions, in.												Hub Dia.		Weight (lb)		
		A	B	C	D	E	F	G	H	I	J	K	L	W Bot. Only	X Top & Bot.	8702	8736	
0[23] 1[23]	8702, 8736	12.63	7.81	14.69	2.56	7.5	13.5	0.59	3.88	18.41	1.66	2.31	0.31	0.75	1	25	26	
2[23]	8702, 8736	14.88	8.25	15.75	2.56	9.75	15	0.38	3.88	20.88	1.72	2.63	0.31	0.75	1.5	33	35	
3[24] 4[24]	8702	18.16	8.75	32.22	3.08	12	30.5	0.88	3.69	26.72	2.56	3.19	0.44	0.75	2.5	96	—	
	8736	18.16	9.56	32.22	3.08	12	30.5	0.88	4.5	26.72	2.56	3.19	0.44	0.75	2.5	—	99	
5	8702	35.22	12.13	49.22	4.11	27	48	0.63	4.59	45.81	2.97	3.5	0.56	0.75	3.5	300	—	
	8736	35.22	12.94	49.22	4.11	27	48	0.63	5.41	45.81	2.97	3.5	0.56	0.75	3.5	—	317	
6	8702, 8736	36.22	19.47	70.13	Floor Mounting												500	505
7	8702, 8736	34.5	23.5	101													—	—

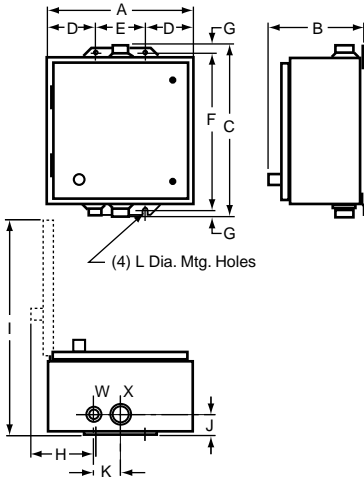

Figure 16.12: NEMA 4 and 4X—Stainless Steel

Table 16.178: Spin Top™ Enclosure—see figure in Table 16.108 NEMA 7 and 9 Enclosures, page 16-41

NEMA Size	Type	Dimensions, in.																	Wt. (lb)				
		A	B[26]	B[27]	C[26]	C[27]	D	E[26]	E[27]	F	G[26]	G[27]	H[26]	H[27]	J[26]	J[27]	K	L		M	N	P	R
0-1	SBR SCR	12	41.06	46.13	68.06	79.13	16.75	7.25	12.25	7.69	26.13	26.13	3	9	24	24	8.5	2.06	9.38	5.25	1.5	0.38	70
2	SDR	16.13	48.5	50.5	81.5	85	20.25	12.13	9.13	8.63	27.75	32.75	8	4.5	25	30	12	2.63	11	5.5	2.5	0.38	100
3	SER	Consult the Customer Care Center at 1-888-778-2733.																					

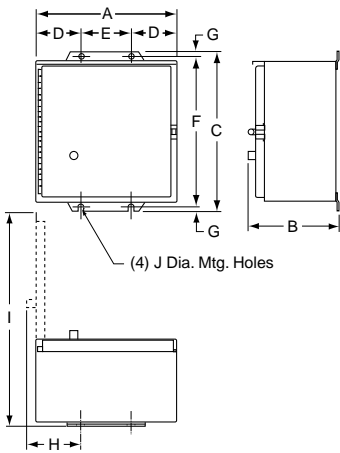

Figure 16.13: NEMA 12/3R

Table 16.177: Bolted Cover, Cast Aluminum Enclosure—see figure in Table 16.108 NEMA 7 and 9 Enclosures, page 16-41

NEMA Size	Type	Dimensions, in. [25]									Wt. (lb)
		G	H	J	K	L	N	P	Q, R	S, T, U, V	
0-2	SBT SCT SDT	14.25	27.63	9.5	12.25	19.25	9.63	11.5	2.38	3.13	115
3-4	SET SFT	24.5	45.63	13.75	22.5	27.5	13.75	15.38	3.44	4	180

NOTE: These dimensions are for reference only. If you need precise measurements, contact the Customer Care Center at 1-888-778-2733.

Table 16.179: See Figure: NEMA 12/3R

NEMA Size	Class	Dimensions, in.										Weight (lb)				
		A	B	C	D	E	F	G	H	I	J	8702	8736			
0[23] 1[23]	8702 8736	11.88	7.75	13.75	2.56	6.75	12.75	0.5	3.66	18.13	0.31	23	24			
2[23]	8702 8736	14.88	7.88	16	2.56	9.75	15	0.5	3.66	21.25	0.31	31	32			
3[24] 4[24]	8702	18.16	9.25	31.5	3.08	12	30.5	0.5	3.69	26.72	0.44	96	—			
	8736	18.16	9.56	31.5	3.08	12	30.5	0.5	4.5	26.72	0.44	—	99			
5	8702	35.22	13.13	49	4.13	27	48	0.5	5.31	45.88	0.56	302	—			
	8736	35.22	13.94	49	4.13	27	48	0.5	6.13	45.88	0.56	—	319			
6	8702 8736	36.22	19.47	62.22	Floor Mounting										490	495
7	8702 8736	34.5	23.5	93											—	—

NOTE: These dimensions are for reference only. If you need precise measurements, contact the Customer Care Center at 1-888-778-2733.

[22] Size 6 and 7 are NEMA 4 sheet steel enclosures.  
 [23] The standard enclosure has space for a fused control transformer, Form FF4T, on Sizes 0-2 (except 4-pole devices, Size 0 and 1).  
 [24] 3-Pole only.  
 [25] Dimensions shown for 2 or 3-Pole devices only.  
 [26] Without control transformer.  
 [27] With control transformer (Form FF4T).



Class 8702 Type W Reversing Vacuum Contactor

**Class 8702 Type W**

Class 8702 Type W Reversing Vacuum Contactors are used to switch capacitors, transformers and electric motors where overload protection is separately provided. Type W reversing vacuum contactors are designed for operation at 600 V, 50/60 Hz.

**Auxiliary Contacts**—An auxiliary contact block, Class 9999 Type WX11, with one normally open contact and one normally closed contact, is used with Size 4, 5 and 6 vacuum contactors. Additional auxiliary contact units may be added to the Size 4 and 5 reversing contactors in the field. A maximum of 2 units may be added to the Size 4; a maximum of 1 unit may be added to the Size 5.

**Termination Means**—The Size 4 reversing vacuum contactor is supplied with line and load side lugs. The Size 5 and 6 reversing vacuum contactors are supplied without line and load side lugs.

**NOTE:** In Table 16.180, replace the three bullets (●●●) in the catalog number with the coil voltage code. Refer to the standard coil voltage codes listed in Table 16.182. Replacement coils are listed in Table 16.181.

**Table 16.180: Class 8702 Full Voltage Reversing Vacuum Contactors (Horizontal Only) 3-Pole Polyphase—600 Vac Maximum—50–60 Hz**

NEMA Size	Enclosed Ampere Rating	Motor Voltage	Maximum Horsepower	Open Style
				Type
4	135	200	40	WFO3●●●
		230	50	
		380	75	
		460	100	
		575	100	
5	270	200	75	WGO3●●●
		230	100	
		380	150	
		460	200	
		575	200	
6	540	200	150	WHO3V●●●
		230	200	
		380	300	
		460	400	
		575	400	

**Table 16.181: Class 9998—Replacement Coils for Class 8702 Reversing Contactors**

Size	Type	Poles	Class and Type	Suffix Number (Complete Coil Number Consists of Class and Type Followed by Suffix Number)			
				120 V	240 V	480 V	600 V
4	WF	All	9998WF	120	240	480	600
5	WG	All	9998WG	120	240	480	600
6	WH	All	9998WH	120	240	480	600

**Table 16.182: Coil Voltage Codes**

Voltage	110	120	220	240	440	480	550	600
50 Hz	V02		V03		V06		V07	
60 Hz		V02		V03		V06		V07

**Table 16.183: Approximate Dimensions**

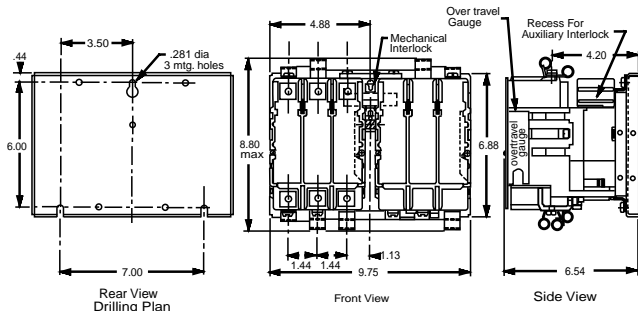

Size 4 Reversing Contactor Outline with Lugs, Class 8702 WF

**Table 16.184: Class 9999—Vacuum Starter Kits**

For Use With Type	Size	Kit Description	Class 9999 Type
WF–WG WH	4–5 6	Auxiliary Contacts, Non-Convertible 1 N.O. & 1 N.C. Isolated Contacts	WX11
WF WG–WH	4 5–6	Coil Circuit Auxiliary Contacts 1 N.O. & 1 N.C. Isolated Contacts, Delayed Break 1 N.C. Isolated Contact	WCX11 WLX01
WG	5	Lug Kits 6 lugs included	LUW5

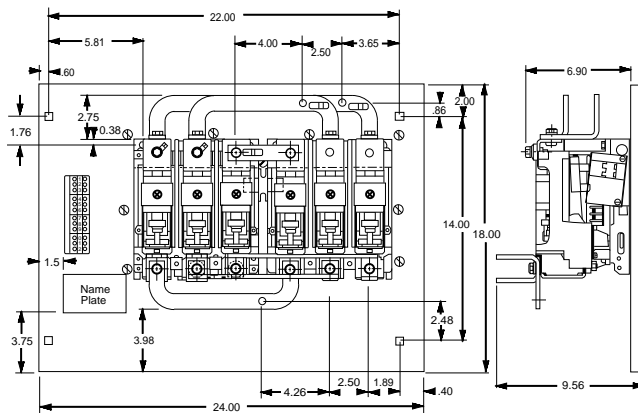

Size 5 Reversing Contactor Outline without Lugs, Class 8702 WG

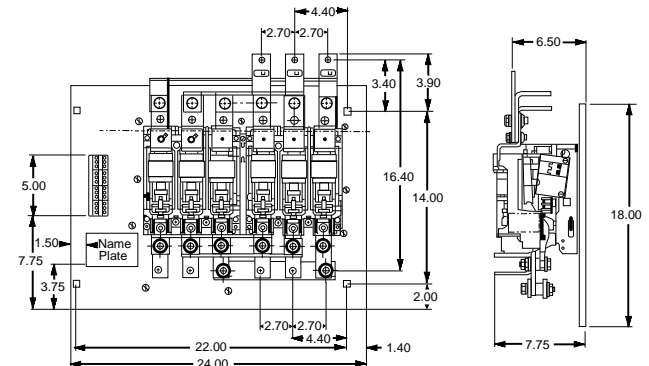

Size 6 Reversing Contactor Outline without Lugs, Class 8702 WH  
For How to Order Information, see page 16-28.



**Class 8738 Fusible Disconnect Switch Type 3-Pole Polyphase—600 Vac Maximum—50–60 Hz**

Class 8738 and 8739 Type S reversing combination starters combine the requirements of motor overload and short circuit protection into one convenient package. Type S reversing combination starters are manufactured in accordance with NEMA standards, and are UL Listed (although some Form numbers may not be listed—contact your nearest Square D/Schneider Electric sales office for further information). Class 8738 and 8739 reversing combination starters are designed to operate at 600 Vac, 50–60 Hz, and are available with one of four types of overload relays. See page 16-62 for more information. For Class J fuses, use Form Y1072 (no charge).

For Form H30• (special lower-FLA factory-assembled starter combinations with Motor Logic SSOLR protection), see Solid-State Overload Relay Forms, page 16-119

**Table 16.185: Class 8738 Full-Voltage Type, Fusible (With Class H Fuse Clips) Reversing with Motor Logic SSOLR (replace ●●● with the voltage code)[1]**

Motor Voltage (Starter Voltage)	Ratings			NEMA 1 General Purpose Enclosure	NEMA 4 & 4X Watertight, Dusttight, Corrosion Resistant Steel (304) Enclosure	NEMA 4X Watertight, Dusttight, Corrosion Resistant Polyester Enclosure	NEMA 12/3R[2] Dusttight and Driptight Industrial Use Enclosure	
	Max. Hp Polyphase	NEMA Size	Fuse Clip Size (A)	Type [3]	Type [3]	Type [3]	With External Reset	Without External Reset
				Type [3]	Type [3]	Type [3]	Type [3]	Type [3]
200 (208)	3	0	30	SBG12●●●H30 [4]	SBW12●●●H30 [4]	SBW22●●●H30 [4]	SBA22●●●H30 [4]	SBA12●●●H30 [4]
	5	1	30	SCG12●●●H30 [4]	SCW12●●●H30 [4]	SCW22●●●H30 [4]	SCA22●●●H30 [4]	SCA12●●●H30 [4]
	7.5		60	SCG13●●●H30 [4]	SCW13●●●H30 [4]	SCW23●●●H30 [4]	SCA23●●●H30 [4]	SCA13●●●H30 [4]
	10	2	60	SDG12●●●H30 [4]	SDW12●●●H30 [4]	SDW22●●●H30 [4]	SDA22●●●H30 [4]	SDA12●●●H30 [4]
	20	3	100	SEG15●●●H30	SEW15●●●H30	—	SEA25●●●H30	SEA15●●●H30
	40	4	200	SFG15●●●H30	SFW15●●●H30	—	SFA25●●●H30	SFA15●●●H30
	75	5	400	SGG15●●●H30	SGW15●●●H30	—	SGA25●●●H30	SGA15●●●H30
230 (240)	3	0	30	SBG12●●●H30 [4]	SBW12●●●H30 [4]	SBW22●●●H30 [4]	SBA22●●●H30 [4]	SBA12●●●H30 [4]
	5	1	30	SCG12●●●H30 [4]	SCW12●●●H30 [4]	SCW22●●●H30 [4]	SCA22●●●H30 [4]	SCA12●●●H30 [4]
	7.5		60	SCG13●●●H30 [4]	SCW13●●●H30 [4]	SCW23●●●H30 [4]	SCA23●●●H30 [4]	SCA13●●●H30 [4]
	15	2	60	SDG12●●●H30 [4]	SDW12●●●H30 [4]	SDW22●●●H30 [4]	SDA22●●●H30 [4]	SDA12●●●H30 [4]
	25	3	100	SEG15●●●H30	SEW15●●●H30	—	SEA25●●●H30	SEA15●●●H30
	50	4	200	SFG15●●●H30	SFW15●●●H30	—	SFA25●●●H30	SFA15●●●H30
	100	5	400	SGG15●●●H30	SGW15●●●H30	—	SGA25●●●H30	SGA15●●●H30
460 (480)	5	0	30	SBG13●●●H30 [4]	SBW13●●●H30 [4]	SBW23●●●H30 [4]	SBA23●●●H30 [4]	SBA13●●●H30 [4]
	10	1	30	SCG14●●●H30 [4]	SCW14●●●H30 [4]	SCW24●●●H30 [4]	SCA24●●●H30 [4]	SCA14●●●H30 [4]
	15		30	SDG16●●●H301	SDW16●●●H301	SDW26●●●H301	SDA26●●●H301	SDA16●●●H301
	25	2	60	SDG14●●●H30 [4]	SDW14●●●H30 [4]	SDW24●●●H30 [4]	SDA24●●●H30 [4]	SDA14●●●H30 [4]
	50	3	100	SEG13●●●H30	SEW13●●●H30	—	SEA23●●●H30	SEA13●●●H30
	100	4	200	SFG13●●●H30	SFW13●●●H30	—	SFA23●●●H30	SFA13●●●H30
	200	5	400	SGG13●●●H30	SGW13●●●H30	—	SGA23●●●H30	SGA13●●●H30
575 (600)	5	0	30	SBG13●●●H30	SBW13●●●H30	SBW23●●●H30	SBA23●●●H30	SBA13●●●H30
	10	1	30	SCG14●●●H301	SCW14●●●H301	SCW24●●●H301	SCA24●●●H301	SCA14●●●H301
	15		30	SDG16●●●H30	SDW16●●●H30	SDW26●●●H30	SDA26●●●H30	SDA16●●●H30
	25	2	60	SDG14●●●H30	SDW14●●●H30	SDW24●●●H30	SDA24●●●H30	SDA14●●●H30
	50	3	100	SEG13●●●H30	SEW13●●●H30	—	SEA23●●●H30	SEA13●●●H30
	100	4	200	SFG13●●●H30	SFW13●●●H30	—	SFA23●●●H30	SFA13●●●H30
	200	5	400	SGG13●●●H30	SGW13●●●H30	—	SGA23●●●H30	SGA13●●●H30

**Table 16.186: Coil Voltage Codes**

Voltage		Code
60 Hz	50 Hz	
24[5]	—	V01
120[6]	110	V02
208	—	V08
240	220	V03
277	—	V04
480	440	V06
600	550	V07
Specify	Specify	V99

**NOTE:** For voltage codes used with control transformers, see page 16-118.

Form S (separate control) is used when a separate source of power is available for the control (coil) voltage. Form S is available at no charge.

Dimensions: page 16-72

Factory Modifications (Forms): page 16-117

Replacement Parts (Class 9998): page 16-122

Type S Accessories (Class 9999): page 16-125

For How to Order Information, see page 16-28.

[1] To order melting alloy overload relay, remove form "H30" from part number.

[2] NEMA 12 enclosures can be field modified for outdoor non-corrosive and non-service entrance rated applications. See page 16-112 for more information.

[3] Replace the three bullets (●●●) in the catalog number with the coil voltage code. Refer to the standard coil voltage codes shown in Table 16.186.

[4] Form H30, with the possibility of a fourth character to select a lower FLA range (for example, H308). See "Solid-State Overload Relay Forms" on page 16-119

[5] 24 V coils are not available on Sizes 4–7. On Sizes 00–3, where 24 V coils are available,

Form S (separate control) must be specified (for example, order as 8738SBG12V01S).

[6] These voltage codes must include Form S (supplied at no charge) (for example, order as 8738SC13V02S).

### Non-Fusible and Fusible Disconnect Switch Type 3-Pole Polyphase—600 Vac Maximum—50–60 Hz

For Form H30\* (special lower-FLA factory-assembled starter combinations with Motor Logic SSOLR protection), see [Solid-State Overload Relay Forms](#), page 16-119

**Table 16.187: Class 8738 Non-Fusible Disconnect Switch Type—Full-Voltage, Reversing, with Motor Logic SSOLR (replace ●●● with the voltage code)[7]**

Motor Voltage (Starter Voltage)	Ratings			NEMA 1 General Purpose Enclosure	NEMA 4 & 4X Watertight, Dusttight, Stainless Steel (304) Enclosure	NEMA 4X Watertight, Dusttight, Corrosion Resistant Polyester Enclosure	NEMA 12/3R/3J Dusttight and Driptight Industrial Use Enclosure	
	Max. Hp Polyphase	NEMA Size	Fuse Clip Size (A)	Type [9]	Type [9]	Type [9]	With External Reset	Without External Reset
				Type [9]	Type [9]	Type [9]	Type [9]	Type [9]
200 (208)	3	0	None	SBG11●●●H30 [10]	SBW11●●●H30 [10]	SBW21●●●H30 [10]	SBA21●●●H30 [10]	SBA11●●●H30 [10]
	7-1/2	1	None	SCG11●●●H30 [10]	SCW11●●●H30 [10]	SCW21●●●H30 [10]	SCA21●●●H30 [10]	SCA11●●●H30 [10]
	10	2	None	SDG11●●●H30 [10]	SDW11●●●H30 [10]	SDW21●●●H30 [10]	SDA21●●●H30 [10]	SDA11●●●H30 [10]
	25	3	None	SEG11●●●H30	SEW11●●●H30	—	SEA21●●●H30	SEA11●●●H30
	40	4	None	SFG11●●●H30	SFW11●●●H30	—	SFA21●●●H30	SFA11●●●H30
230 (240)	75	5	None	SGG11●●●H30	SGW11●●●H30	—	SGA21●●●H30	SGA11●●●H30
	3	0	None	SBG11●●●H30 [10]	SBW11●●●H30 [10]	SBW21●●●H30 [10]	SBA21●●●H30 [10]	SBA11●●●H30 [10]
	7-1/2	1	None	SCG11●●●H30 [10]	SCW11●●●H30 [10]	SCW21●●●H30 [10]	SCA21●●●H30 [10]	SCA11●●●H30 [10]
	15	2	None	SDG11●●●H30 [10]	SDW11●●●H30 [10]	SDW21●●●H30 [10]	SDA21●●●H30 [10]	SDA11●●●H30 [10]
	30	3	None	SEG11●●●H30	SEW11●●●H30	—	SEA21●●●H30	SEA11●●●H30
460 (480)	50	4	None	SFG11●●●H30	SFW11●●●H30	—	SFA21●●●H30	SFA11●●●H30
	100	5	None	SGG11●●●H30	SGW11●●●H30	—	SGA21●●●H30	SGA11●●●H30
	5	0	None	SBG11●●●H30 [10]	SBW11●●●H30 [10]	SBW21●●●H30 [10]	SBA21●●●H30 [10]	SBA11●●●H30 [10]
	10	1	None	SCG11●●●H30 [10]	SCW11●●●H30 [10]	SCW21●●●H30 [10]	SCA21●●●H30 [10]	SCA11●●●H30 [10]
	25	2	None	SDG11●●●H30 [10]	SDW11●●●H30 [10]	SDW21●●●H30 [10]	SDA21●●●H30 [10]	SDA11●●●H30 [10]
575 (600)	50	3	None	SEG11●●●H30	SEW11●●●H30	—	SEA21●●●H30	SEA11●●●H30
	100	4	None	SFG11●●●H30	SFW11●●●H30	—	SFA21●●●H30	SFA11●●●H30
	200	5	None	SGG11●●●H30	SGW11●●●H30	—	SGA21●●●H30	SGA11●●●H30
	5	0	None	SBG11●●●H30 [10]	SBW11●●●H30 [10]	SBW21●●●H30 [10]	SBA21●●●H30 [10]	SBA11●●●H30 [10]
	10	1	None	SCG11●●●H30 [10]	SCW11●●●H30 [10]	SCW21●●●H30 [10]	SCA21●●●H30 [10]	SCA11●●●H30 [10]

**Table 16.188: Class 8738 Fusible Disconnect Switch Type with Class R Fuse Clips—100,000 AIC Rating (replace ●●● with the voltage code)[7]**

Motor Voltage (Starter Voltage)	Ratings			NEMA 1 General Purpose Enclosure	NEMA 4 & 4X Watertight, Dusttight, Stainless Steel (304) Enclosure	NEMA 4X Watertight, Dusttight, Corrosion Resistant Polyester Enclosure [11]	NEMA 12/3R/3J Dusttight and Driptight Industrial Use Enclosure	
	Max. Hp Polyphase	NEMA Size	Fuse Clip Size (A)	Type [9]	Type [9]	Type [9]	With External Reset	Without External Reset
				Type [9]	Type [9]	Type [9]	Type [9]	Type [9]
200 (208)	3	0	30	SBG32●●●H30 [10]	SBW32●●●H30 [10]	SBW42●●●H30 [10]	SBA42●●●H30 [10]	SBA32●●●H30 [10]
	5		30	SCG32●●●H30 [10]	SCW32●●●H30 [10]	SCW42●●●H30 [10]	SCA42●●●H30 [10]	SCA32●●●H30 [10]
	7-1/2	1	60	SCG33●●●H30 [10]	SCW33●●●H30 [10]	SCW43●●●H30 [10]	SCA43●●●H30 [10]	SCA33●●●H30 [10]
	10	2	60	SDG32●●●H30 [10]	SDW32●●●H30 [10]	SDW42●●●H30 [10]	SDA42●●●H30 [10]	SDA32●●●H30 [10]
	20	3	100	SEG35●●●H30	SEW35●●●H30	—	SEA45●●●H30	SEA35●●●H30
	40	4	200	SFG35●●●H30	SFW35●●●H30	—	SFA45●●●H30	SFA35●●●H30
230 (240)	75	5	400	SGG35●●●H30	SGW35●●●H30	—	SGA45●●●H30	SGA35●●●H30
	3	0	30	SBG32●●●H30 [10]	SBW32●●●H30 [10]	SBW42●●●H30 [10]	SBA42●●●H30 [10]	SBA32●●●H30 [10]
	5		30	SCG32●●●H30 [10]	SCW32●●●H30 [10]	SCW42●●●H30 [10]	SCA42●●●H30 [10]	SCA32●●●H30 [10]
	7-1/2	1	60	SCG33●●●H30 [10]	SCW33●●●H30 [10]	SCW43●●●H30 [10]	SCA43●●●H30 [10]	SCA33●●●H30 [10]
	15	2	60	SDG32●●●H30 [10]	SDW32●●●H30 [10]	SDW42●●●H30 [10]	SDA42●●●H30 [10]	SDA32●●●H30 [10]
	25	3	100	SEG35●●●H30	SEW35●●●H30	—	SEA45●●●H30	SEA35●●●H30
460 (480)	50	4	200	SFG35●●●H30	SFW35●●●H30	—	SFA45●●●H30	SFA35●●●H30
	100	5	400	SGG35●●●H30	SGW35●●●H30	—	SGA45●●●H30	SGA35●●●H30
	5	0	30	SBG33●●●H30 [10]	SBW33●●●H30 [10]	SBW43●●●H30 [10]	SBA43●●●H30 [10]	SBA33●●●H30 [10]
	10	1	30	SCG34●●●H30 [10]	SCW34●●●H30 [10]	SCW44●●●H30 [10]	SCA44●●●H30 [10]	SCA34●●●H30 [10]
	15		30	SDG36●●●H301	SDW36●●●H301	SDW46●●●H301	SDA46●●●H301	SDA36●●●H301
	25	2	60	SDG34●●●H30 [10]	SDW34●●●H30 [10]	SDW44●●●H30 [10]	SDA44●●●H30 [10]	SDA34●●●H30 [10]
575 (600)	50	3	100	SEG33●●●H30	SEW33●●●H30	—	SEA43●●●H30	SEA33●●●H30
	100	4	200	SFG33●●●H30	SFW33●●●H30	—	SFA43●●●H30	SFA33●●●H30
	200	5	400	SGG33●●●H30	SGW33●●●H30	—	SGA43●●●H30	SGA33●●●H30
	5	0	30	SBG33●●●H30 [10]	SBW33●●●H30 [10]	SBW43●●●H30 [10]	SBA43●●●H30 [10]	SBA33●●●H30 [10]
	10	1	30	SCG34●●●H30 [10]	SCW34●●●H30 [10]	SCW44●●●H30 [10]	SCA44●●●H30 [10]	SCA34●●●H30 [10]
	15		30	SDG36●●●H301	SDW36●●●H301	SDW46●●●H301	SDA46●●●H301	SDA36●●●H301

For How to Order Information, see [page 16-28](#).

[7] To order melting alloy overload relay, remove form "H30" from part number.

[8] NEMA 12 enclosures can be field modified for outdoor non-corrosive and non-service entrance rated applications. See [page 16-112](#) for more information.

[9] Replace the three bullets (●●●) in the catalog number with the coil voltage code. Refer to the standard coil voltage codes shown in [Table 16.190](#).

[10] Form H30, with the possibility of a fourth character to select a lower FLA range (for example, H308). See "Solid-State Overload Relay Forms" on [page 16-119](#)

[11] 5,000 AIC Rating

**Electronic Motor Circuit Protector (MCP)  
3-Pole Polyphase—600 Vac Maximum—50–60 Hz**

For Form H30• (special lower-FLA factory-assembled starter combinations with Motor Logic SSOLR protection), see [Solid-State Overload Relay Forms](#), page 16-119

**Table 16.189: Class 8739 Full-Voltage Type, Reversing with Motor Logic SSOLR (replace ●●● with the voltage code)<sup>[12]</sup>**

Motor Voltage (Starter Voltage)	Ratings			NEMA 1 General Purpose Enclosure Type [15]	NEMA 4 & 4X Watertight, Dusttight, Stainless Steel (304) Enclosure (Sizes 0-5) <sup>[13]</sup> Type [15]	NEMA 4X Watertight, Dusttight, Corrosion Resistant Polyester Enclosure Type [15]	NEMA 12/3R <sup>[14]</sup> Dusttight and Driptight Industrial Use Enclosure		
	NEMA Size	Hp Range Polyphase	Circuit Breaker (See Page 7-32 for Breaker Adjustment Range)				With External Reset Type [15]	Without External Reset Type [15]	
200 (208)	0	0.25–3	HLL36030M71	SBG43●●●H30 [16]	SBW43●●●H30 [16]	SBW53●●●H30 [16]	SBA53●●●H30 [16]	SBA43●●●H30 [16]	
		0.25–5	HLL36030M71	SCG44●●●H30 [16]	SCW44●●●H30 [16]	SCW54●●●H30 [16]	SCA54●●●H30 [16]	SCA44●●●H30 [16]	
	1	7.5	HLL36050M72	SCG45●●●H30 [16]	SCW45●●●H30 [16]	SCW55●●●H30 [16]	SCA55●●●H30 [16]	SCA45●●●H30 [16]	
		1.5–5	HLL36030M71	SDG42●●●H301	SDW42●●●H301	SDW52●●●H301	SDA52●●●H301	SDA42●●●H301	
	2	7.5–10	HLL36050M72	SDG43●●●H30 [16]	SDW43●●●H30 [16]	SDW53●●●H30 [16]	SDA53●●●H30 [16]	SDA43●●●H30 [16]	
		15–25	HLL36100M73	SEG42●●●H30	SEW42●●●H30	SEW52●●●H30	SEA52●●●H30	SEA42●●●H30	
	3	30–40	JLL36250M75	SFG44●●●H30	SFW44●●●H30	SFW54●●●H30	SFA54●●●H30	SFA44●●●H30	
		50–60	JLL36250M75	SGG44●●●H30	SGW44●●●H30	—	SGA54●●●H30	SGA44●●●H30	
	4	75	LJL36400M36	SGG45●●●H30	SGW45●●●H30	—	SGA55●●●H30	SGA45●●●H30	
		100	LJL36400M36	SHG43●●●H30	SHW43●●●H30	—	SHA53●●●H30	SHA43●●●H30	
	5	125–150	LJL36600M42	SHG45●●●H30	SHW45●●●H30	—	SHA55●●●H30	SHA45●●●H30	
		200	PLL34080M68	SHG46●●●H30	SHW46●●●H30	—	SHA56●●●H30	SHA46●●●H30	
230 (240)	0	0.25–3	HLL36030M71	SBG43●●●H30 [16]	SBW43●●●H30 [16]	SBW53●●●H30 [16]	SBA53●●●H30 [16]	SBA43●●●H30 [16]	
		0.25–7.5	HLL36030M71	SCG44●●●H30 [16]	SCW44●●●H30 [16]	SCW54●●●H30 [16]	SCA54●●●H30 [16]	SCA44●●●H30 [16]	
	1	1.5–7.5	HLL36030M71	SDG42●●●H301	SDW42●●●H301	SDW52●●●H301	SDA52●●●H301	SDA42●●●H301	
		10	HLL36050M72	SDG43●●●H30 [16]	SDW43●●●H30 [16]	SDW53●●●H30 [16]	SDA53●●●H30 [16]	SDA43●●●H30 [16]	
	2	15	HLL36100M73	SDG44●●●H30 [16]	SDW44●●●H30 [16]	SDW54●●●H30 [16]	SDA54●●●H30 [16]	SDA44●●●H30 [16]	
		15–30	HLL36100M73	SEG42●●●H30	SEW42●●●H30	SEW52●●●H30	SEA52●●●H30	SEA42●●●H30	
	3	40–50	JLL36250M75	SFG44●●●H30	SFW44●●●H30	SFW54●●●H30	SFA54●●●H30	SFA44●●●H30	
		60	JLL36250M75	SGG44●●●H30	SGW44●●●H30	—	SGA54●●●H30	SGA44●●●H30	
	4	75–100	LJL36400M36	SGG45●●●H30	SGW45●●●H30	—	SGA55●●●H30	SGA45●●●H30	
		125–150	LJL36600M42	SHG45●●●H30	SHW45●●●H30	—	SHA55●●●H30	SHA45●●●H30	
	5	200	PLL34080M68	SHG46●●●H30	SHW46●●●H30	—	SHA56●●●H30	SHA46●●●H30	
		0.25–5	HLL36030M71	SBG43●●●H30 [16]	SBW43●●●H30 [16]	SBW53●●●H30 [16]	SBA53●●●H30 [16]	SBA43●●●H30 [16]	
460 (480)	0	0.25–10	HLL36030M71	SCG44●●●H30 [16]	SCW44●●●H30 [16]	SCW54●●●H30 [16]	SCA54●●●H30 [16]	SCA44●●●H30 [16]	
		5–15	HLL36030M71	SDG42●●●H301	SDW42●●●H301	SDW52●●●H301	SDA52●●●H301	SDA42●●●H301	
	1	20–25	HLL36050M72	SDG43●●●H30 [16]	SDW43●●●H30 [16]	SDW53●●●H30 [16]	SDA53●●●H30 [16]	SDA43●●●H30 [16]	
		30–50	HLL36100M73	SEG41●●●H30	SEW41●●●H30	SEW51●●●H30	SEA51●●●H30	SEA41●●●H30	
	2	30–50	HLL36100M73	SEG42●●●H30	SEW42●●●H30	SEW52●●●H30	SEA52●●●H30	SEA42●●●H30	
		60–100	JLL36250M75	SFG44●●●H30	SFW44●●●H30	SFW54●●●H30	SFA54●●●H30	SFA44●●●H30	
	3	125	JLL36250M75	SGG44●●●H30	SGW44●●●H30	—	SGA54●●●H30	SGA44●●●H30	
		150–200	LJL36400M36	SGG45●●●H30	SGW45●●●H30	—	SGA55●●●H30	SGA45●●●H30	
	4	250–350	LJL36600M42	SHG45●●●H30	SHW45●●●H30	—	SHA55●●●H30	SHA45●●●H30	
		400	PLL34080M68	SHG46●●●H30	SHW46●●●H30	—	SHA56●●●H30	SHA46●●●H30	
	575 (600)	0	0.25–5	HLL36030M71	SBG43●●●H30 [16]	SBW43●●●H30 [16]	SBW53●●●H30 [16]	SBA53●●●H30 [16]	SBA43●●●H30 [16]
			0.25–10	HLL36030M71	SCG44●●●H30 [16]	SCW44●●●H30 [16]	SCW54●●●H30 [16]	SCA54●●●H30 [16]	SCA44●●●H30 [16]
1		5–20	HLL36030M71	SDG42●●●H301	SDW42●●●H301	SDW52●●●H301	SDA52●●●H301	SDA42●●●H301	
		25	HLL36050M72	SDG43●●●H30 [16]	SDW43●●●H30 [16]	SDW53●●●H30 [16]	SDA53●●●H30 [16]	SDA43●●●H30 [16]	
2		25–30	HLL36050M72	SEG41●●●H30	SEW41●●●H30	SEW51●●●H30	SEA51●●●H30	SEA41●●●H30	
		40–50	HLL36100M73	SEG42●●●H30	SEW42●●●H30	SEW52●●●H30	SEA52●●●H30	SEA42●●●H30	
3		60–100	JLL36250M75	SFG44●●●H30	SFW44●●●H30	SFW54●●●H30	SFA54●●●H30	SFA44●●●H30	
		125–150	JLL36250M75	SGG44●●●H30	SGW44●●●H30	—	SGA54●●●H30	SGA44●●●H30	
4		200	LJL36400M36	SGG45●●●H30	SGW45●●●H30	—	SGA55●●●H30	SGA45●●●H30	
		250	LJL36400M36	SHG43●●●H30	SHW43●●●H30	—	SHA53●●●H30	SHA43●●●H30	
5		300–400	LJL36600M42	SHG45●●●H30	SHW45●●●H30	—	SHA55●●●H30	SHA45●●●H30	

**Table 16.190: Coil Voltage Codes**

Voltage		Code
60 Hz	50 Hz	
24 <sup>[17]</sup>	—	V01
120 <sup>[18]</sup>	110	V02
208	—	V08
240	220	V03
277	—	V04
480	440	V06
600	550	V07
Specify	Specify	V99

**NOTE:** For voltage codes used with control transformers, see [page 16-118](#).

Form S (separate control) is used when a separate source of power is available for the control (coil) voltage. Form S is available at no charge.

Dimensions: [page 16-72](#)

Factory Modifications (Forms): [page 16-117](#)

Replacement Parts (Class 9998): [page 16-122](#)

Type S Accessories (Class 9999): [page 16-125](#)

For How to Order Information, see [page 16-28](#).

[12] To order melting alloy overload relay, remove form "H30" from part number.

[13] Size 6 starters are NEMA 4 painted sheet steel enclosures.

[14] NEMA 12 enclosures can be field modified for outdoor non-corrosive and non-service entrance rated applications. See [page 16-112](#) for more information.

[15] Replace the three bullets (●●●) in the catalog number with the coil voltage code. Refer to the standard coil voltage codes shown in [Table 16.190](#).

[16] **Form H30**, with the possibility of a fourth character to select a lower FLA range (for example, **H308**). See "Solid-State Overload Relay Forms" on [page 16-119](#)

[17] 24 V coils are not available on Sizes 4–7. On Sizes 00–3, where 24 V coils are available, **Form S** (separate control) must be specified (for example, order as 8739SBG41V01S).

[18] These voltage codes must include **Form S** (provided at no charge) (for example, order as 8739SCG41V02S).

### Thermal Magnetic Circuit Breaker 3-Pole Polyphase—600 Vac Maximum—50–60 Hz

For Form H30\* (special lower-FLA factory-assembled starter combinations with Motor Logic SSOLR protection), see [Solid-State Overload Relay Forms](#), page 16-119

Table 16.191: Class 8739 Full-Voltage Type, Reversing, 200–240 V, with Motor Logic SSOLR (replace ●● with the voltage code)<sup>[19]</sup>

Ratings					NEMA 1 General Purpose Enclosure	NEMA 4 & 4X Watertight and Dusttight Enclosure Stainless Steel (304) (Sizes 0-5) <sup>[20]</sup>	NEMA 4X Watertight, Dusttight and Corrosion Resistant Polyester Enclosure	NEMA 12/3R <sup>[21]</sup> Dusttight and Driptight Industrial Use Enclosure	
Motor Voltage (Starter Voltage)	Max. Hp Polyphase	NEMA Size	Circuit Breaker		Type <sup>[22]</sup>	Type <sup>[22]</sup>	Type <sup>[22]</sup>	With External Reset	Without External Reset
			Type	Ampere Rating				Type <sup>[22]</sup>	Type <sup>[22]</sup>
200 (208)	2	0	HLL36015	15	SBG1●●●H30 <sup>[23]</sup>	SBW1●●●H30 <sup>[23]</sup>	SBW11●●●H30 <sup>[23]</sup>	SBA11●●●H30 <sup>[23]</sup>	SBA1●●●H30 <sup>[23]</sup>
	3		HLL36020	20	SBG3●●●H30 <sup>[23]</sup>	SBW3●●●H30 <sup>[23]</sup>	SBW13●●●H30 <sup>[23]</sup>	SBA13●●●H30 <sup>[23]</sup>	SBA3●●●H30 <sup>[23]</sup>
	5	1	HLL36035	35	SCG5●●●H30 <sup>[23]</sup>	SCW5●●●H30 <sup>[23]</sup>	SCW15●●●H30 <sup>[23]</sup>	SCA15●●●H30 <sup>[23]</sup>	SCA5●●●H30 <sup>[23]</sup>
	7.5		HLL36050	50	SCG2●●●H30 <sup>[23]</sup>	SCW2●●●H30 <sup>[23]</sup>	SCW12●●●H30 <sup>[23]</sup>	SCA12●●●H30 <sup>[23]</sup>	SCA2●●●H30 <sup>[23]</sup>
	10	2	HLL36060	60	SDG1●●●H30 <sup>[23]</sup>	SDW1●●●H30 <sup>[23]</sup>	SDW11●●●H30 <sup>[23]</sup>	SDA11●●●H30 <sup>[23]</sup>	SDA1●●●H30 <sup>[23]</sup>
	15		HLL36100	100	SEG3●●●H30	SEW3●●●H30	SEW13●●●H30	SEA13●●●H30	SEA3●●●H30
	20	3	HLL36125	125	SEG1●●●H30	SEW1●●●H30	SEW11●●●H30	SEA11●●●H30	SEA1●●●H30
	25		HLL36150	150	SEG5●●●H30	SEW5●●●H30	SEW15●●●H30	SEA15●●●H30	SEA5●●●H30
	30	4	JLL36200	200	SFG3●●●H30	SFW3●●●H30	SFW13●●●H30	SFA13●●●H30	SFA3●●●H30
	40		JLL36250	250	SFG4●●●H30	SFW4●●●H30	SFW14●●●H30	SFA14●●●H30	SFA4●●●H30
50	5	JLL36250	250	SGG6●●●H30	SGW6●●●H30	—	SGA16●●●H30	SGA6●●●H30	
60–75		LLL36400U33X	400	SGG4●●●H30	SGW4●●●H30	—	SGA14●●●H30	SGA4●●●H30	
100–125	6	LLL36600U33X	600	SHG4●●●H30	SHW4●●●H30	—	SHA14●●●H30	SHA4●●●H30	
150		MJL36800	800	SHG5●●●H30	SHW5●●●H30	—	SHA15●●●H30	SHA5●●●H30	
230 (240)	2	0	HLL36015	15	SBG1●●●H30 <sup>[23]</sup>	SBW1●●●H30 <sup>[23]</sup>	SBW11●●●H30 <sup>[23]</sup>	SBA11●●●H30 <sup>[23]</sup>	SBA1●●●H30 <sup>[23]</sup>
	3		HLL36020	20	SBG3●●●H30 <sup>[23]</sup>	SBW3●●●H30 <sup>[23]</sup>	SBW13●●●H30 <sup>[23]</sup>	SBA13●●●H30 <sup>[23]</sup>	SBA3●●●H30 <sup>[23]</sup>
	5	1	HLL36035	35	SCG5●●●H30 <sup>[23]</sup>	SCW5●●●H30 <sup>[23]</sup>	SCW15●●●H30 <sup>[23]</sup>	SCA15●●●H30 <sup>[23]</sup>	SCA5●●●H30 <sup>[23]</sup>
	7.5		HLL36045	45	SCG6●●●H30 <sup>[23]</sup>	SCW6●●●H30 <sup>[23]</sup>	SCW16●●●H30 <sup>[23]</sup>	SCA16●●●H30 <sup>[23]</sup>	SCA6●●●H30 <sup>[23]</sup>
	10	2	HLL36060	60	SDG1●●●H30 <sup>[23]</sup>	SDW1●●●H30 <sup>[23]</sup>	SDW11●●●H30 <sup>[23]</sup>	SDA11●●●H30 <sup>[23]</sup>	SDA1●●●H30 <sup>[23]</sup>
	15		HLL36090	90	SDG7●●●H30 <sup>[23]</sup>	SDW7●●●H30 <sup>[23]</sup>	SDW17●●●H30 <sup>[23]</sup>	SDA17●●●H30 <sup>[23]</sup>	SDA7●●●H30 <sup>[23]</sup>
	20	3	HLL36100	100	SEG3●●●H30	SEW3●●●H30	SEW13●●●H30	SEA13●●●H30	SEA3●●●H30
	25–30		HLL36150	150	SEG5●●●H30	SEW5●●●H30	SEW15●●●H30	SEA15●●●H30	SEA5●●●H30
	40	4	JLL36225	225	SFG1●●●H30	SFW1●●●H30	SFW11●●●H30	SFA11●●●H30	SFA1●●●H30
	50		JLL36250	250	SFG4●●●H30	SFW4●●●H30	SFW14●●●H30	SFA14●●●H30	SFA4●●●H30
60	5	JLL36250	250	SGG6●●●H30	SGW6●●●H30	—	SGA16●●●H30	SGA6●●●H30	
75		LLL36400U33X	400	SGG4●●●H30	SGW4●●●H30	—	SGA14●●●H30	SGA4●●●H30	
100	6	LLL36600U33X	600	SGG2●●●H30	SGW2●●●H30	—	SGA12●●●H30	SGA2●●●H30	
125		LLL36600U33X	600	SHG4●●●H30	SHW4●●●H30	—	SHA14●●●H30	SHA4●●●H30	
150–200	6	MJL36800	800	SHG5●●●H30	SHW5●●●H30	—	SHA15●●●H30	SHA5●●●H30	

Table 16.192: Coil Voltage Codes

Voltage		Code
60 Hz	50 Hz	
24 <sup>[24]</sup>	—	V01
120 <sup>[25]</sup>	110	V02
208	—	V08
240	220	V03
277	—	V04
480	440	V06
600	550	V07
Specify	Specify	V99

**NOTE:** For voltage codes used with control transformers, see [page 16-118](#). Form S (separate control) is used when a separate source of power is available for the control (coil) voltage. Form S is available at no charge.

Dimensions: [page 16-72](#)  
 Factory Modifications (Forms): [page 16-117](#)  
 Replacement Parts (Class 9998): [page 16-122](#)  
 Type S Accessories (Class 9999): [page 16-125](#)  
 For How to Order Information, see [page 16-28](#).

<sup>[19]</sup> To order melting alloy overload relay, remove form "H30" from part number.

<sup>[20]</sup> Size 6 starters are NEMA 4 painted sheet steel enclosures.

<sup>[21]</sup> NEMA 12 enclosures can be field modified for outdoor non-corrosive and non-service entrance rated applications. See [page 16-112](#) for more information.

<sup>[22]</sup> Replace the three bullets (●●●) in the catalog number with the coil voltage code. Refer to the standard coil voltage codes shown in [Table 16.192](#).

<sup>[23]</sup> Form H30, with the possibility of a fourth character to select a lower FLA range (for example, H308). See "Solid-State Overload Relay Forms" on [page 16-119](#)

<sup>[24]</sup> 24 V coils are not available on Sizes 4–7. On Sizes 00–3, where 24 V coils are available, Form S (separate control) must be specified (for example, order as 8739SBG1V01S).

<sup>[25]</sup> These voltage codes must include Form S (provided at no charge) (for example, order as 8739SCG5V02S).



by Schneider Electric

www.se.com/us

# Reversing

Class 8739 / Refer to Catalog 8538CT9701

# Type S Reversing Combination Starters

## Thermal Magnetic Circuit Breaker

### 3-Pole Polyphase—600 Vac Maximum—50–60 Hz

For Form H30\* (special lower-FLA factory-assembled starter combinations with Motor Logic SSOLR protection), see [Solid-State Overload Relay Forms](#), page 16-119

Table 16.193: Class 8739 Full-Voltage Type, Reversing, 460–600 V, with Motor Logic SSOLR (replace ●●● with the voltage code)<sup>[26]</sup>

Ratings				NEMA 1 General Purpose Enclosure	NEMA 4 & 4X Watertight, Dusttight, Stainless Steel (304) Enclosure (Sizes 0–5) <sup>[27]</sup>	NEMA 4X Watertight, Dusttight, Corrosion Resistant Polyester Enclosure	NEMA 12/3R <sup>[28]</sup> Dusttight and Driptight Industrial Use Enclosure			
Motor Voltage (Starter Voltage)	Max. Hp Polyphase	NEMA Size	Circuit Breaker		Type [29]	Type [29]	Type [29]	With External Reset	Without External Reset	
			Type	Ampere Rating				Type [29]	Type [29]	
460 (480)	5	0	HLL36015	15	SBG1●●●H30 [30]	SBW1●●●H30 [30]	SBW11●●●H30 [30]	SBA11●●●H30 [30]	SBA1●●●H30 [30]	
	7-1/2 10	1	HLL36025 HLL36030	25 30	SCG3●●●H30 [30] SCG7●●●H30 [30]	SCW3●●●H30 [30] SCW7●●●H30 [30]	SCW13●●●H30 [30] SCW17●●●H30 [30]	SCA13●●●H30 [30] SCA17●●●H30 [30]	SCA3●●●H30 [30] SCA7●●●H30 [30]	
	15 20 25	2	HLL36045 HLL36060 HLL36070	45 60 70	SDG3●●●H30 [30] SDG1●●●H30 [30] SDG5●●●H30 [30]	SDW3●●●H30 [30] SDW1●●●H30 [30] SDW5●●●H30 [30]	SDW13●●●H30 [30] SDW11●●●H30 [30] SDW15●●●H30 [30]	SDA13●●●H30 [30] SDA11●●●H30 [30] SDA15●●●H30 [30]	SDA3●●●H30 [30] SDA1●●●H30 [30] SDA5●●●H30 [30]	
	30 40 50	3	HLL36080 HLL36100 HLL36150	80 100 150	SEG6●●●H30 SEG3●●●H30 SEG5●●●H30	SEW6●●●H30 SEW3●●●H30 SEW5●●●H30	SEW16●●●H30 SEW13●●●H30 SEW15●●●H30	SEA16●●●H30 SEA13●●●H30 SEA15●●●H30	SEA6●●●H30 SEA3●●●H30 SEA5●●●H30	
	60 75 100	4	JLL36105 JLL36200 JLL36250	150 200 250	SFG5●●●H30 SFG3●●●H30 SFG4●●●H30	SFW5●●●H30 SFW3●●●H30 SFW4●●●H30	SFW15●●●H30 SFW13●●●H30 SFW14●●●H30	SFA15●●●H30 SFA13●●●H30 SFA14●●●H30	SFA5●●●H30 SFA3●●●H30 SFA4●●●H30	
	125–150 200	5	LLL36400U33X LLL36600U33X	400 600	SGG4●●●H30 SGG2●●●H30	SGW4●●●H30 SGW2●●●H30	—	SGA14●●●H30 SGA12●●●H30	SGA4●●●H30 SGA2●●●H30	
	250 300–400	6	LLL36600U33X MJL36800	600 800	SHG4●●●H30 SHG5●●●H30	SHW4●●●H30 SHW5●●●H30	—	SHA14●●●H30 SHA15●●●H30	SHA4●●●H30 SHA5●●●H30	
	575 (600)	5	0	HLL36015	15	SBG1●●●H30	SBW1●●●H30	SBW11●●●H30	SBA11●●●H30	SBA1●●●H30
		7-1/2 10	1	HLL36020 HLL36025	20 25	SCG8●●●H30 SCG3●●●H30	SCW8●●●H30 SCW3●●●H30	SCW18●●●H30 SCW13●●●H30	SCA18●●●H30 SCA13●●●H30	SCA8●●●H30 SCA3●●●H30
		15 20 25	2	HLL36035 HLL36045 HLL36060	35 45 60	SDG8●●●H301 SDG3●●●H30 SDG1●●●H30	SDW8●●●H301 SDW3●●●H30 SDW1●●●H30	SDW18●●●H301 SDW13●●●H30 SDW11●●●H30	SDA18●●●H301 SDA13●●●H30 SDA12●●●H30	SDA8●●●H301 SDA3●●●H30 SDA1●●●H30
		30 40 50	3	HLL36070 HLL36090 HLL36100	70 90 100	SEG4●●●H30 SEG6●●●H30 SEG3●●●H30	SEW4●●●H30 SEW6●●●H30 SEW3●●●H30	SEW14●●●H30 SEW16●●●H30 SEW13●●●H30	SEA14●●●H30 SEA16●●●H30 SEA13●●●H30	SEA4●●●H30 SEA6●●●H30 SEA3●●●H30
		60–75 100	4	JLL36150 JLL36250	150 250	SFG5●●●H30 SFG4●●●H30	SFW5●●●H30 SFW4●●●H30	SFW15●●●H30 SFW14●●●H30	SFA15●●●H30 SFA14●●●H30	SFA5●●●H30 SFA4●●●H30
125–150 200		5	JLL36250 LLL36400U33X	250 400	SGG6●●●H30 SGG4●●●H30	SGW6●●●H30 SGW4●●●H30	—	SGA16●●●H30 SGA14●●●H30	SGA6●●●H30 SGA4●●●H30	
250–350 400		6	LLL36600U33X MJL36800	600 800	SHG4●●●H30 SHG5●●●H30	SHW4●●●H30 SHW5●●●H30	—	SHA14●●●H30 SHA15●●●H30	SHA4●●●H30 SHA5●●●H30	

16 NEMA AND DEFINITE PURPOSE CONTACTORS AND STARTERS

Table 16.194: Coil Voltage Codes

Voltage		Code
60 Hz	50 Hz	
24 [31]	—	V01
120 [32]	110	V02
208	—	V08
240	220	V03
480	440	V06
600	550	V07
Specify	Specify	V99

NOTE: For voltage codes used with control transformers, see page 16-118.

Form S (separate control) is used when a separate source of power is available for the control (coil) voltage. Form S is available at no charge.

For How to Order Information, see page 16-28.

Table 16.195: Class 8738 UL Listed Short Circuit Ratings

NEMA Size	Fuse Clip Type	Enclosure [33]	Ampere Interrupting Capability Rating (AIC)
0–3	Standard	Standard	5,000
0–3	Class R	Standard	100,000
4–5	Standard	Standard	10,000
4–5	Class R	Standard	100,000

Table 16.196: Class 8739 UL Listed Short Circuit Ratings

Motor Circuit Protector Type			
NEMA Size	Voltage	Enclosure [33]	Ampere Interrupting Capability Rating (AIC)
0–1	480	Standard	100,000
0–1	481 – 600	Standard	35,000
2–5	480	Standard	100,000
2–5	481 – 600	Standard	50,000
6	480	Standard	65,000
6	600	Standard	18,000
Thermal Magnetic Circuit Breaker Type			
0–1	480	Standard	100,000
0–1	481–600	Standard	35,000
2–5	480	Standard	100,000
2–5	481–600	Standard	50,000
6	480	Standard	65,000
6	600	Standard	18,000

[26] To order melting alloy overload relay, remove form "H30" from part number.

[27] Size 6 starters are NEMA 4 painted sheet steel enclosures.

[28] NEMA 12 enclosures can be field modified for outdoor non-corrosive and non-service entrance rated applications. See page 16-112 for more information.

[29] Replace the three bullets (●●●) in the catalog number with the coil voltage code. Refer to the standard coil voltage codes shown in Table 16.194.

[30] Form H30, with the possibility of a fourth character to select a lower FLA range (for example, H308). See "Solid-State Overload Relay Forms" on page 16-119

[31] 24 V coils are not available on Sizes 4–7. On Sizes 00–3, where 24 V coils are available, Form S (separate control) must be specified (for example, order as 8739SBG2V01S).

[32] These voltage codes must include Form S (provided at no charge) (for example, order as 8739SDG3V02S).

[33] Standard enclosures include NEMA 1; 4 and 4X stainless; and 12/3R.

**NEMA 1, 12, and 3R Dimensions**

**NOTE:** These dimensions are for reference only. If you need precise measurements, contact the Customer Care Center at 1-888-778-2733.

**Table 16.197: See Figure: NEMA 1 Enclosure (Sizes 0–2), page 16-72**

NEMA Size	Class	Type	Dimensions (in.) [34]														Top & Bottom		Sides	Wt. (lb)		
			A	B	C	D	E	F	G	H	I	J	K	L	M	N	O	P	W		X	Y
0-1	8738, 8739	SBG SCG	13.75	23	8.34	10.63	21	18.91	1.88	1.88	3.75	2.31	1.06	3.25	2.19	1.25	0.88	—	0.25–0.75–1	0.25–0.75–1	0.25	49
2	8738, 8739	SDG	15	28.75	9.59	11.63	26.25	21.47	2.19	2	4	2.56	1.25	3.25	2.19	1.25	0.91	—	1–1.25	1–1.25	0.25	80

**Table 16.198: See Figure: NEMA 1 Enclosure (Sizes 3–6), page 16-72**

NEMA Size	Class	Type	Dimensions (in.) [34]														Top & Bottom		Sides	Wt. (lb)		
			A	B	C	D	E	F	G	H	I	J	K	L	M	N	O	P	W		X	Y
3	8738, 8739	SEG	18.5	44	10.59	12.5	3	25.97	43.5	0.25	—	2.81	3.5	5	2.69	5.38	1.22	0.91	1–1.25 2–2.25	0.25–0.75	0.25	245
	8739	SFG	21	51.5	10.53	15	3	30.72	51	0.25	—	2.81	3.5	5	2.69	5.38	1.22	0.91	2.5	0.25–0.75	0.25	—
4	8738	SFG	18.5	44	10.59	12.5	3	25.97	43.5	0.25	—	2.81	3.5	5	2.69	5.38	1.22	0.91	1–1.25 2–2.25	0.25–0.75	0.25	—
	8739	SFG	18.5	44	10.59	12.5	3	25.97	43.5	0.25	—	2.81	3.5	5	2.69	5.38	1.22	0.91	1–1.25 2–2.25	0.25–0.75	0.25	—
5	8738	SGG	30	77	15.5	22	4	39.41	76	0.25	—	3.5	6.28	9.25	3.19	—	—	—	0.25–0.75	3	—	—
	8739	SGG	30	65	13.72	22	4	39.41	64	0.25	—	3.5	6.28	5	3.19	—	—	—	0.25–0.75	3	—	—
6	8738, 8739	SHG	36	90	17.03	—	—	—	—	—	—	—	—	—	—	—	—	—	—	—	—	—

**Table 16.199: See Figure: NEMA 12/3R Enclosure, page 16-72**

NEMA Size	Class	Type	Dimensions (in.) [34]										Wt. (lb)
			A	B	C	D	E	F	G	H	I	J	
0-1	8738, 8739	SBA SCA	13.75	10.09	24.75	3.25	2.5	8.75	24	0.38	3.75	20.31	52
2	8738, 8739	SDA	15	10.97	31	3.25	3	9	30.25	0.38	3.75	23.44	95
3	8738, 8739	SEA	18.5	10.59	45	5	3	12.5	44	0.25	3.75	25.59	255
	8738	SFA	21	10.59	52.5	5	3	15	51.5	0.25	3.75	30.34	—
4	8739	SFA	18.5	10.59	45	3.25	3	12.5	44	0.25	3.75	25.59	—
	8738	SGA	30	15.5	78	9.25	4	22	77	0.25	7.5	39.41	—
5	8738	SGA	30	15.5	66	—	4	22	65	0.25	7.5	37.88	—
	8739	SGA	30	15.5	66	—	4	22	65	0.25	7.5	37.88	—
6 [35]	8739	SHA	36	17.03	90	—	—	—	—	—	—	—	—

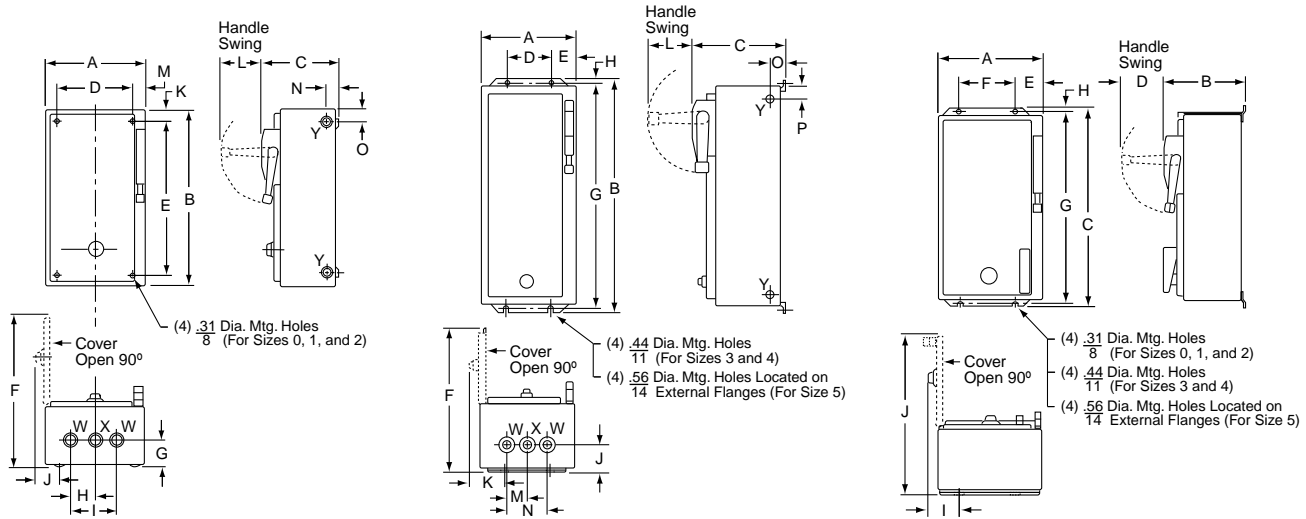

**Figure 16.14: NEMA 1 Enclosure (Sizes 0–2) Figure 16.15: NEMA 1 Enclosure (Sizes 3–6) Figure 16.16: NEMA 12/3R Enclosure**

**NOTE:** Illustrations may not represent the actual enclosure; they are intended for dimensional information only.

[34] The dimensions shown in all tables above are also for **Form FF4T** (standard control transformer), **Form FF4T11** (100 VA extra-capacity), and **Form FF4T12** (200 VA extra-capacity).

[35] Size 6 enclosures are floor mounting.

**NEMA 4, 4X Dimensions**

NOTE: These dimensions are for reference only. If you need precise measurements, contact the Customer Care Center at 1-888-778-2733.

Table 16.200: See Figure: **NEMA 4X Polyester Enclosure, page 16-73 [36]**

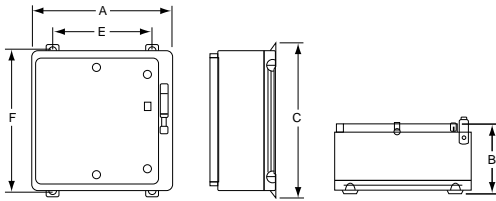

Figure 16.17: NEMA 4X Polyester Enclosure

NEMA Size	Class	Type	Dimensions (in inches) [37]				
			A	B	C	E	F
0-2	8738 & 8739	SBW	25.25	11.4	27.00	17.88	25.75
		SCW SDW					
3-4	8739	SEW	26.31	11.4	33.50	18.50	32.25
		SFW					

Table 16.201: See Figure: **NEMA 4 & 4X Stainless Steel Enclosure, page 16-73**

NEMA Size	Class	Type	Dimensions (in inches) [38]												Bottom W	Top & Bot. X	Wt. (lb)
			A	B	C	D	E	F	G	H	I	J	K	L			
0-1	8738, 8739	SBW	13.75	8.34	25.19	3.25	2.5	8.75	24	0.59	3	1.63	2.31	18.53	0.75 Hub	1 Hub	52
		SCW															
2	8738, 8739	SDW	15	9.59	30.03	3.25	2.5	10	29.75	0.63	3	2	2.63	21.03	0.75 Hub	1.5 Hub	95
3	8738, 8739	SEW	18.5	10.56	45.19	5	3	12.5	44	0.59	3.5	2.63	3.19	25.5	0.75 Hub	2.5 Hub	255
4	8738, 8739	SEW	21	10.53	52.69	5	3	15	51.5	0.59	3.5	2.63	3.19	30.25	0.75 Hub	2.5 Hub	—
		SFW															
5	8738, 8739	SEW	30	15.5	78.09	9.25	4	22	77	0.56	6.09	3	3.5	39.41	0.75 Hub	3.5 Hub	—
		SFW															
6	8739	SEW	36	17.03	98	—	—	—	—	—	—	—	—	—	—	—	—
		SFW															

NOTE: Illustrations may not represent the actual enclosure; they are intended for dimensional information only.

**Information on Hubs**

Hubs are supplied with each NEMA 4X combination starter as shown in Table 16.202. Note that hubs are only installed in stainless steel enclosures; they are supplied but not installed in polyester enclosures.

Table 16.202: Hubs

NEMA Size	Quantity	Hub Size (in.)
0-1	1	0.75
	2	1.00
2	1	0.75
	2	1.50
3-4	1	0.75
	2	2.50

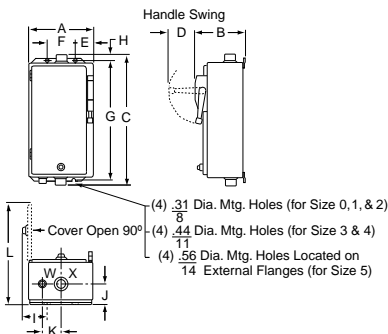
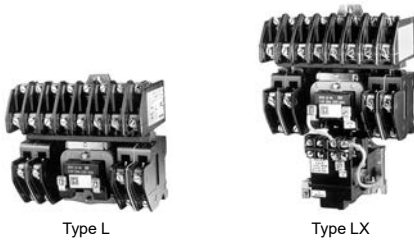

Figure 16.18: NEMA 4 & 4X Stainless Steel Enclosure

[36] See Table 16.202 for important information on hubs for NEMA 4X enclosures.  
 [37] The dimensions shown in all tables above are also for Form FF4T (standard control transformer), Form FF4T11 (100 VA extra-capacity), and Form FF4T12 (200 VA extra-capacity).  
 [38] Dimensions also for Form F4T (standard control transformer), Form F4T11 (100 VA extra capacity) and Form F4T12 (200 VA extra capacity).



Features

- LED ready [1]
- 30 A fluorescent lighting rating, 20 A tungsten lighting rating
- Electrically and mechanically held
- 2 through 12-pole versions
- Field-convertible contacts with N.O. and N.C. indicators (8 N.C. contacts maximum [2])
- Silver-Cadmium-Oxide double break contacts

**NOTE:** When ordering contactors with more than 8 poles, the catalog number configuration is the number of normally open contacts followed by a 0 and then the number of normally closed contacts (i.e. for 4 N.O. and 6 N.C. on a 10-pole contactor, order 8903LG406V02).



File E78427  
CCN NRNT



File LR60905  
Class 3211 07

Table 16.203: Multipole Lighting Contactors (50–60 Hz) (replace ●●● with the voltage code)

Contact Ampere Ratings	No. of Poles	NEMA 1 General Purpose Enclosure	NEMA 1 Flush Mounting General Purpose Enclosure with Plaster Adjustment	NEMA 3R Rainproof Enclosure[3]	NEMA 4 & 4X Watertight, Dusttight, and Corrosion-Resistant Glass-Polyester Enclosure	NEMA 4 & 4X Watertight, Dusttight Brushed Stainless Steel Enclosure	NEMA 12/3R[4] Dusttight and Driptight Industrial Use Enclosure	Open Type [5]
		Type [6]	Type [6]	Type [6]	Type [6]	Type [6]	Type [6]	Type [6]
<b>Electrically Held[2]</b>								
30 [6]	2	LG20●●●	LF20●●●	LH20●●●	LWW20●●●	LW20●●●	LA20●●●	LO20●●●
	3	LG30●●●	LF30●●●	LH30●●●	LWW30●●●	LW30●●●	LA30●●●	LO30●●●
	4	LG40●●●	LF40●●●	LH40●●●	LWW40●●●	LW40●●●	LA40●●●	LO40●●●
	6	LG60●●●	LF60●●●	LH60●●●	LWW60●●●	LW60●●●	LA60●●●	LO60●●●
	8	LG80●●●	LF80●●●	LH80●●●	LWW80●●●	LW80●●●	LA80●●●	LO80●●●
30 [6]	10	LG1000●●●	LF1000●●●	LH1000●●●	LWW1000●●●	LW1000●●●	LA1000●●●	LO1000●●●
	12	LG1200●●●	LF1200●●●	LH1200●●●	LWW1200●●●	LW1200●●●	LA1200●●●	LO1200●●●
	<b>Mechanically Held [2] [7]</b>							
30 [6]	2	LXG20●●●	LXF20●●●	—	LXWW20●●●	LXW20●●●	LXA20●●●	LXO20●●●
	3	LXG30●●●	LXF30●●●	—	LXWW30●●●	LXW30●●●	LXA30●●●	LXO30●●●
	4	LXG40●●●	LXF40●●●	—	LXWW40●●●	LXW40●●●	LXA40●●●	LXO40●●●
	6	LXG60●●●	LXF60●●●	—	LXWW60●●●	LXW60●●●	LXA60●●●	LXO60●●●
	8	LXG80●●●	LXF80●●●	—	LXWW80●●●	LXW80●●●	LXA80●●●	LXO80●●●
30 [6]	10	LXG1000●●●	LXF1000●●●	—	LXWW1000●●●	LXW1000●●●	LXA1000●●●	LXO1000●●●
	12	LXG1200●●●	LXF1200●●●	—	LXWW1200●●●	LXW1200●●●	LXA1200●●●	LXO1200●●●

**NOTE:** If a holding circuit contact is required for proper operation, order an additional contact.

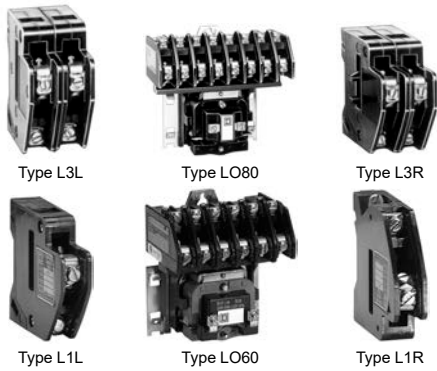

Power Pole Kits

The kits in Table 16.204 are used to add 30 A power poles to existing Type L contactors when additional circuits are required. Type L lighting contactors come with mounting brackets, so that adder poles may be mounted from the front by a single captive screw. Adder poles come standard with N.O. contacts which are convertible to N.C.

For How to Order Information, see page 16-28.

**NOTE:** 12 N.C. poles are only available with a 120 V coil (V02).

Table 16.204: Power Poles for Type L or LX

Power Pole Adder Kit[8]		Can Only Be Added to Contactor Type[9]
Class 8903 Type		
Single Pole	L1L	LO60, LXO60, LO80, LXO80, LO1000, LXO1000
	L1R	
Double Pole	L3L	
	L3R	

Table 16.205: Coil Voltage Codes

Voltage		Code
60 Hz	50 Hz	
24	—	V01
120	110	V02
208	—	V08
240	220	V03
277	—	V04
480	440	V06
Specify	Specify	V99

Table 16.206: How to Order

To Order Specify:		Catalog Number		
• Class Number	• Voltage Code	Class	Type	Voltage Code
• Type Number	• Form(s)			
				CF4R6

Factory Modifications (Forms): page 16-79

Replacement Coils: page 16-122

Replacement Contacts: page 16-124

- [1] Conforms to NEMA -410 -2015 and UL508: Table 46.1 and Section 61C test procedures for LED loads up to 16 A at 120 V. Devices were tested to 20 A at 120 V and conform to the test requirements.
- [2] Factory conversion of N.O. contacts to N.C., order by catalog number (for example, for 6 N.O. and 2 N.C. poles on an 8 pole contactor, order as 8903LG62V02). Versions are available from the factory with up to 12 N.C. poles for Type L (electrically held) or 2, 4, or 6 N.C. poles for Type LX (mechanically held). For field conversion, there is a maximum of eight N.C. poles for Type L (electrically held) and a maximum of six N.C. poles for Type LX (mechanically held) contactors.
- [3] Cannot support control transformer Forms.
- [4] NEMA 12 enclosures can be field modified for outdoor non-corrosive and non-service entrance rated applications. See page 16-112 for more information.
- [5] Separate enclosures are available for these devices. It may be possible to improve delivery by ordering an open type contactor and separate Class 9991 enclosure.
- [6] Replace the three bullets (●●●) in the catalog number with the coil voltage code. Refer to the standard voltage codes listed in Table 16.205. All lighting contactors come with separate control as standard.
- [7] When ordering **Form C** on mechanically held devices, you must also include **Form R6**.
- [8] 8903LO (electrically held) devices can accommodate 10 or 12 N.C. contacts use **only** 120 V 60Hz coils.
- [9] LO60 and LXO60: add single-pole kits only, 1 on each side, for converting to 8-pole. To maintain proper operation, the contactor cannot be converted to more than 8 poles. LO80 and LXO80: use single-pole kits, 1 on each side, for converting to 10-pole and use two-pole kits, 1 on each side, for converting to 12-pole. LO1000 and LXO1000: remove the existing single-pole kit and install two-pole kits, 1 on each side, for converting to 12-pole.





Electrically Held



Mechanically Held



**Features**

- Electrically and mechanically held
- 30–800 A lighting ratings
- LED ready [10]
- 2- through 5-pole versions (5-poles through 200 A)
- UL Listed short-circuit rating up to 100,000 Amperes
- Factory wired controls and clearly marked termination points
- Quick ship on most items in 5–7 days

**Table 16.207: Coil Voltage Codes**

Voltage [11]		Code
60 Hz	50 Hz	
24 [12]	—	V01
120	110	V02
208	—	V08
240	220	V03
277	—	V04 [13]
480	440	V06
Specify	Specify	V99

**Table 16.208: Multipole Lighting Contactors—Type S, 50–60 Hz (replace ●●● with the voltage code)**

Contact Ampere Ratings	No. of Poles	NEMA 1 General Purpose Enclosure	NEMA 1 Flush Mounting General Purpose Enclosure with Plaster Adjustment	NEMA Type 3R Rainproof Enclosure [14]	NEMA 4 & 4X Watertight, Dusttight and Corrosion-Resistant Glass-Polyester Enclosure	NEMA Type 4 & 4X [15] Watertight and Dusttight Enclosure	NEMA Type 12/3R [16] Dusttight and Driptight Industrial Use Enclosure	Open Type
		Type [17]	Type [17]	Type [17]	Type [17]	Type [17]	Type [17]	Type [17]
<b>Electrically Held [11]</b>								
30	2	SMG1●●●	SMF1●●●	SMH1●●●	SMW21●●●	SMW1●●●	SMA1●●●	SMO1●●● [18]
	3	SMG2●●●	SMF2●●●	SMH2●●●	SMW22●●●	SMW2●●●	SMA2●●●	SMO2●●● [18]
	4	SMG3●●●	SMF3●●●	SMH3●●●	SMW23●●●	SMW3●●●	SMA3●●●	SMO3●●● [18]
	5	SMG4●●●	SMF4●●●	SMH4●●●	SMW24●●●	SMW4●●●	SMA4●●●	SMO4●●● [18]
	2	SPG1●●●	SPF1●●●	SPH1●●●	SPW21●●●	SPW1●●●	SPA1●●●	SPO1●●● [18]
60	3	SPG2●●●	SPF2●●●	SPH2●●●	SPW22●●●	SPW2●●●	SPA2●●●	SPO2●●● [18]
	4	SPG3●●●	SPF3●●●	SPH3●●●	SPW23●●●	SPW3●●●	SPA3●●●	SPO3●●● [18]
	5	SPG4●●●	SPF4●●●	SPH4●●●	SPW24●●●	SPW4●●●	SPA4●●●	SPO4●●● [18]
	2	SQG1●●●	SQF1●●●	SQH1●●●	SQW21●●●	SQW1●●●	SQA1●●●	SQO1●●● [18]
	3	SQG2●●●	SQF2●●●	SQH2●●●	SQW22●●●	SQW2●●●	SQA2●●●	SQO2●●● [18]
100	4	SQG3●●●	—	SQH3●●●	—	SQW3●●●	SQA3●●●	SQO3●●● [18]
	5	SQG4●●●	—	SQH4●●●	—	SQW4●●●	SQA4●●●	SQO4●●● [18]
	2	SVG1●●●	—	SVH1●●●	—	SVW1●●●	SVA1●●●	SVO1●●●
	3	SVG2●●●	—	SVH2●●●	—	SVW2●●●	SVA2●●●	SVO2●●●
	4	SVG3●●●	—	—	—	SVW3●●●	SVA3●●●	SVO3●●●
200	5	SVG4●●●	—	—	—	SVW4●●●	SVA4●●●	SVO4●●●
	2	SXG1●●●	—	—	—	SXW1●●●	SXA1●●●	SXO1●●●
	3	SXG2●●●	—	—	—	SXW2●●●	SXA2●●●	SXO2●●●
	2	SYG1●●●	—	—	—	SYW1●●●	SYA1●●●	SYO1●●●
	3	SYG2●●●	—	—	—	SYW2●●●	SYA2●●●	SYO2●●●
400 [19]	2	SZG1●●●	—	—	—	SZW1●●●	SZA1●●●	SZO1●●●
	3	SZG2●●●	—	—	—	SZW2●●●	SZA2●●●	SZO2●●●
600 [19]	2	SJG1●●●	—	—	—	SJW1●●●	SJA1●●●	SJO1●●●
	3	SJG2●●●	—	—	—	SJW2●●●	SJA2●●●	SJO2●●●
800 [19]	2	—	—	—	—	—	—	—
	3	—	—	—	—	—	—	—
<b>Mechanically Held [11]</b>								
30	2	SMG10●●●	SMF10●●●	—	SMW31●●●	SMW10●●●	SMA10●●●	SMO10●●● [18]
	3	SMG11●●●	SMF11●●●	—	SMW32●●●	SMW11●●●	SMA11●●●	SMO11●●● [18]
	4	SMG12●●●	SMF12●●●	—	SMW33●●●	SMW12●●●	SMA12●●●	SMO12●●● [18]
	5	SMG13●●●	SMF13●●●	—	SMW34●●●	SMW13●●●	SMA13●●●	SMO13●●● [18]
	2	SPG10●●●	SPF10●●●	—	SPW31●●●	SPW10●●●	SPA10●●●	SPO10●●● [18]
60	3	SPG11●●●	SPF11●●●	—	SPW32●●●	SPW11●●●	SPA11●●●	SPO11●●● [18]
	4	SPG12●●●	SPF12●●●	—	SPW33●●●	SPW12●●●	SPA12●●●	SPO12●●● [18]
	5	SPG13●●●	SPF13●●●	—	SPW34●●●	SPW13●●●	SPA13●●●	SPO13●●● [18]
	2	SQG10●●●	SQF10●●●	—	SQW31●●●	SQW10●●●	SQA10●●●	SQO10●●● [18]
	3	SQG11●●●	SQF11●●●	—	SQW32●●●	SQW11●●●	SQA11●●●	SQO11●●● [18]
100	4	SQG12●●●	—	—	—	SQW12●●●	SQA12●●●	SQO12●●● [18]
	5	SQG13●●●	—	—	—	SQW13●●●	SQA13●●●	SQO13●●● [18]
	2	SVG10●●●	—	—	—	SVW10●●●	SVA10●●●	SVO10●●●
	3	SVG11●●●	—	—	—	SVW11●●●	SVA11●●●	SVO11●●●
	4	SVG12●●●	—	—	—	SVW12●●●	SVA12●●●	SVO12●●●
200	2	SXG13●●●	—	—	—	SXW13●●●	SXA13●●●	SXO13●●●
	3	SXG14●●●	—	—	—	SXW14●●●	SXA14●●●	SXO14●●●
300	2	SYG16●●●	—	—	—	SYW16●●●	SYA16●●●	SYO16●●●
	3	SYG17●●●	—	—	—	SYW17●●●	SYA17●●●	SYO17●●●
400	2	SZG18●●●	—	—	—	SZW18●●●	SZA18●●●	SZO18●●●
	3	SZG19●●●	—	—	—	SZW19●●●	SZA19●●●	SZO19●●●

**NOTE:** If a holding circuit contact is required for proper operation, order an additional contact.

[10] Conforms to NEMA -410 -2015 and UL508: Table 46.1 and Section 61C test procedures for LED loads up to 16 A at 120 V. Devices were tested to 20 A at 120 V and conform to the test requirements.

[11] Lighting contactors come with separate control as standard—except electrically held 400, 600, and 800 A devices, which come with common control as standard.

[12] 24 V coils are not available for 200–800 A devices. Contact your local sales office for more information.

[13] On 400–800 A electrically held contactors, for voltage code V04, you must select Form S (separate control).

[14] Cannot support control transformer forms.

[15] For contactor sizes 30–300 A, NEMA 4 and 4X enclosures are brush finished stainless steel. Sizes 400–800 A are painted sheet steel.

[16] NEMA 12 enclosures can be field modified for outdoor non-corrosive and non-service entrance rated applications. See page 16-112 for more information.

[17] Replace the three bullets (●●●) in the catalog number with the coil voltage code. Refer to the standard voltage codes in Table 16.207.

[18] Separate enclosures are available for these devices. It may be possible to improve delivery time by ordering an open type contactor and a separate Class 9991 enclosure from the section, Separate Enclosures, page 16-110.

[19] Form FF4T comes standard; include the line voltage when ordering. Control voltage is 120–60.

**Power Pole Kits for Type S Only**

A single-pole or double-pole kit can be added to any 2- or 3-pole 30 or 60 A Type S lighting contactor to make a 4- or 5-pole device. Factory assembled 4- and 5-pole contactors utilize the basic 3-pole device with a single or double-pole kit installed. Only one power pole can be added per contactor. Sufficient room is provided in all enclosure styles for the addition of a power pole kit.

**Table 16.209: Power Pole Kits for Type S Only**

Ampere Rating	Description	Class 9999 Type
30	One N.O.	SB6
	One N.C.	SB7
	One N.O. and One N.C.	SB8
	Two N.O.	SB9
	Two N.C.	SB10
60	One N.O.	SB21 [20]
	One N.C.	SB22 [20]
	One N.O. and One N.C.	SB23 [20]
	Two N.O.	SB24 [20]
	Two N.C.	SB25 [20]

Factory Modifications (Forms): [page 16-79](#)

Replacement Coils: [page 16-122](#)

Replacement Contacts: [page 16-124](#)

Dimensions: [page 16-83](#)

For How to Order Information, see [page 16-28](#).

[20] When power pole is added to 60 Ampere contactor, a 4-pole coil is also required. Order from [Table 16.331](#). 60 A power poles are suitable for use with copper or aluminum wire.



File E16151  
CCN NRNT

**NOTE:** If a holding circuit contact is required for proper operation, order an additional contact.

**Features**

The features include: disconnect switch and circuit breaker versions; rugged flange-mounted handle; easy installation; occupation of less space; increased operator protection; room to spare for modifications; Class R fuse clips standard; electrically and mechanically held; 30–600 A.

It is desirable to install the branch-circuit protective device and lighting contactor, combining switching and over-current protection, in one enclosure. Combination lighting contactors are well suited for industrial, highway and area lighting applications, or where a lighting circuit may have to be disconnected for periodic maintenance. They may also be used for resistance heating loads.

**Table 16.210: Fusible or Non-Fusible Disconnect Switch—3-Pole, 50–60 Hz (replace ●●● with the voltage code)**

Contactor Ampere Rating	Fuse Clip Size (A)	Fuse Clip Spacing (V)	NEMA 1 General Purpose Enclosure	NEMA 4 & 4X <sup>[21]</sup> Watertight and Dusttight Enclosure Stainless Steel	NEMA 12/3R <sup>[22]</sup> Dusttight, Oiltight Driptight, Industrial Use Enclosure
			Type <sup>[23]</sup>	Type <sup>[23]</sup>	Type <sup>[23]</sup>
<b>Electrically Held<sup>[24]</sup></b>					
30	None	—	SMG60●●●	SMW60●●●	SMA60●●●
	30	600	SMG61●●●	SMW61●●●	SMA61●●●
	30	250	SMG62●●●	SMW62●●●	SMA62●●●
60	None	—	SPG60●●●	SPW60●●●	SPA60●●●
	60	600	SPG61●●●	SPW61●●●	SPA61●●●
	60	250	SPG62●●●	SPW62●●●	SPA62●●●
100	None	—	SQG60●●●	SQW60●●●	SQA60●●●
	100	600	SQG61●●●	SQW61●●●	SQA61●●●
	100	250	SQG62●●●	SQW62●●●	SQA62●●●
200	None	—	SVG60●●●	SVW60●●●	SVA60●●●
	200	600	SVG61●●●	SVW61●●●	SVA61●●●
	200	250	SVG62●●●	SVW62●●●	SVA62●●●
300	None	—	SXG60●●●	SXW60●●●	SXA60●●●
	400	600	SXG61●●●	SXW61●●●	SXA61●●●
	400	250	SXG62●●●	SXW62●●●	SXA62●●●
<b>Mechanically Held<sup>[24]</sup></b>					
30	None	—	SMG70●●●	SMW70●●●	SMA70●●●
	30	600	SMG71●●●	SMW71●●●	SMA71●●●
	30	250	SMG72●●●	SMW72●●●	SMA72●●●
60	None	—	SPG70●●●	SPW70●●●	SPA70●●●
	60	600	SPG71●●●	SPW71●●●	SPA71●●●
	60	250	SPG72●●●	SPW72●●●	SPA72●●●
100	None	—	SQG70●●●	SQW70●●●	SQA70●●●
	100	600	SQG71●●●	SQW71●●●	SQA71●●●
	100	250	SQG72●●●	SQW72●●●	SQA72●●●
200	None	—	SVG70●●●	SVW70●●●	SVA70●●●
	200	600	SVG71●●●	SVW71●●●	SVA71●●●
	200	250	SVG72●●●	SVW72●●●	SVA72●●●
300	None	—	SXG70●●●	SXW70●●●	SXA70●●●
	400	600	SXG71●●●	SXW71●●●	SXA71●●●
	400	250	SXG72●●●	SXW72●●●	SXA72●●●

**Table 16.211: Coil Voltage Codes <sup>[24]</sup>**

Voltage		Code
60 Hz	50 Hz	
24 <sup>[25]</sup>	—	V01
120	110	V02
208	—	V08
240	220	V03
277	—	V04
480	440	V06
Specify	Specify	V99

**Table 16.212: Circuit Breaker—3-Pole, 50–60 Hz (replace ●●● with the voltage code)**

Contactor Ampere Rating	Circuit Breaker		NEMA 1 General Purpose Enclosure	NEMA 4 & 4X <sup>[21]</sup> Watertight and Dusttight Enclosure Stainless Steel (30-300 A)	NEMA 12/3R <sup>[22]</sup> Dusttight, Oiltight, Driptight, Industrial Use Enclosure
	Ampere Rating	Maximum Volts	Type <sup>[23]</sup>	Type <sup>[23]</sup>	Type <sup>[23]</sup>
<b>Electrically Held<sup>[24]</sup></b>					
30	30	600	SMG81●●●	SMW81	SMA81●●●
60	60	600	SPG81●●●	SPW81●●●	SPA81●●●
100	100	600	SQG81●●●	SQW81●●●	SQA81●●●
200	200	600	SVG81●●●	SVW81●●●	SVA81●●●
300	300	600	SXG81●●●	SXW81●●●	SXA81●●●
400	400	600	SYG81●●●	SYW81●●●	SYA81●●●
600	600	600	SZG81●●●	SZW81●●●	SZA81●●●
<b>Mechanically Held<sup>[24]</sup></b>					
30	30	600	SMG91●●●	SMW91●●●	SMA91●●●
60	60	600	SPG91●●●	SPW91●●●	SPA91●●●
100	100	600	SQG91●●●	SQW91●●●	SQA91●●●
200	200	600	SVG91●●●	SVW91●●●	SVA91●●●
300	300	600	SXG91●●●	SXW91●●●	SXA91●●●
400	400	600	SYG91●●●	SYW91●●●	SYA91●●●
600	600	600	SZG91●●●	SZW91●●●	SZA91●●●

For How to Order Information, see page 16-28.

[21] For NEMA 4 and 4X watertight, dusttight, and corrosion-resistant glass-polyester enclosures, add Form G18 (limited to 100 A max.). 400 and 600 A enclosures are painted sheet steel (NEMA Type 4 & 4X).

[22] NEMA 12 enclosures can be field modified for outdoor non-corrosive and non-service entrance rated applications. See page 16-112 for more information.

[23] Replace the three bullets (●●●) in the catalog number with the coil voltage code. Refer to the standard voltage codes shown in Table 16.207.

[24] The control/coil voltage must be specified.

[25] 24 V coils are not available for 200 A or larger devices. Contact the Customer Care Center for additional information.

**NIGHT-MASTER**®

16 NEMA AND DEFINITE PURPOSE CONTACTORS AND STARTERS



Long Version



Short Version



**Night-Master Combination Lighting Contactors**

The Class 8903 Night-Master Outdoor Combination Lighting Contactor is the only product on the market that is UL Listed for Service Entrance. This allows the contactor to be pole mounted when used to control lighting in remote locations such as parks, monuments, group sports facilities, and streets and highways.

Factory modifications such as photocells, time switches, key operated selector switches, and the combination of photocells and time switches (photocell on, time switch off) allow the Night-Master to be located in applications where manual operation of lights is not practical.

Night-Master comes in long and short versions in sizes 30 through 200 Amperes. Most common modifications can be provided from the factory, or added in the field to the pre-drilled and pre-tapped panels.

NIGHT-MASTER Outdoor Combination Lighting Contactors offer a disconnecting means, overcurrent protection, and a lighting contactor in one NEMA 3R Rainproof enclosure. These combination units satisfy the requirements of the National Electrical Code and UL 508 for service entrance equipment.

**Features**

- Solid neutral standard
- Grounding lug standard
- Padlocking provisions
- Short and long versions available
- Electrically held Type S lighting contactor
- Eliminates the need for separate mounted safety switches
- Additional panel space eliminates the need for external mounting of time clocks
- Separate control comes standard on all lighting contactors

**NOTE:** If a holding circuit contact is required for proper operation, order an additional contact.

**Table 16.213: Disconnect Switch Type—3-Pole (replace ●●● with the voltage code)**

Contactor Ampere Rating	Fuse Clip Size (A)	Fuse Clip Spacing (V)	Short Version		Long Version	
			Class 8903 Type 3R [26]	Class 8903 Type 3R Stainless Steel [26]	Class 8903 Type 3R [26]	Class 8903 Type 3R Stainless Steel [26]
30	30	600	SMC61●●●	SMH61●●●	SMC63●●●	SMH63●●●
	30	250	SMC62●●●	SMH62●●●	SMC64●●●	SMH64●●●
60	60	600	SPC61●●●	SPH61●●●	SPC63●●●	SPH63●●●
	60	250	SPC62●●●	SPH62●●●	SPC64●●●	SPH64●●●
100	100	600	SQC61●●●	SQH61●●●	SQC63●●●	SQH63●●●
	100	250	SQC62●●●	SQH62●●●	SQC64●●●	SQH64●●●
200	200	600	SVC61●●●	SVH61●●●	SVC63●●●	SVH63●●●
	200	250	SVC62●●●	SVH62●●●	SVC64●●●	SVH64●●●

**Table 16.214: Coil Voltage Codes**

Voltage		Code
60 Hz	50 Hz	
24 [27]	—	V01
120	110	V02
208	—	V08
240	220	V03
277	—	V04
480	440	V06
Specify	Specify	V99

**Table 16.215: Circuit Breaker Type—3-Pole (replace ●●● with the voltage code)**

Contactor Ampere Rating	Circuit Breaker		Short Version		Long Version	
	Ampere Rating	Maximum Volts	Class 8903 Type 3R [26]	Class 8903 Type 3R Stainless Steel [26]	Class 8903 Type 3R [26]	Class 8903 Type 3R Stainless Steel [26]
30	30	600	SMC81●●●	SMH81●●●	SMC83●●●	SMH83●●●
60	60	600	SPC81●●●	SPH81●●●	SPC83●●●	SPH83●●●
100	100	600	SQC81●●●	SQH81●●●	SQC83●●●	SQH83●●●
200	200	600	SVC81●●●	SVH81●●●	SVC83●●●	SVH83●●●

For How to Order Information, see page 16-28.

[26] Replace the three bullets (●●●) in the catalog number with the coil voltage code. Refer to the standard voltage codes listed in Table 16.214.

[27] 24 V coils are not available for 200 A devices. Contact your local sales office for additional information.

**Factory Modifications (Forms)**

**NOTE:** If a UL label is required, consult the Customer Care Center at 1-888-778-2733. Some Forms are not UL Listed.

Standard Equipment dimensions and enclosure construction may not apply when certain special features are added. Such cases should be referred to the factory with a complete description when precise dimensions are required.

**Table 16.216: Lighting Contactor Forms (Factory Modifications)**

Description	Form Letter	NEMA Enclosure Type	Used On					Rating (A)							
			Std.		Combo		Night-Master 30-200 A	30 Type L	30	60	100	200	300	400, 600, 800	
			Elec. Held	Mech. Held	Elec. Held	Mech. Held									
On-Off push button(momentary contact)	A3	1	—	Y	—	Y	—	Y	Y	Y	Y	Y	Y	Y	Y
	A3	3R, 4, 12	—	Y	—	Y	—	Y	Y	Y	Y	Y	Y	Y	Y
On-Off push button (with holding circuit interlock)	A12	Any	Y	—	Y	—	Y	Y	Y	Y	Y	Y	Y	Y	Y
Hand-Off-Auto selector switch. To substitute a key operated selector switch, use Form C33 and specify positions, legend marking, and key removal. This form must be used with another selector switch form (example: CC33).	C	1	Y	Y [28]	Y	Y [28]	—	Y	Y	Y	Y	Y	Y	Y	Y
	C	3R, 4, 12	Y	Y [28]	Y	Y [28]	Y	Y	Y	Y	Y	Y	Y	Y	Y
On-Off selector switch. To substitute a key operated selector switch, use Form C33 and specify positions, legend marking, and key removal. This form must be used with another selector switch form (example: C33C6).	C6	1	Y	Y	Y	Y	—	Y	Y	Y	Y	Y	Y	Y	Y
	C6	3R, 4, 12	Y	Y	Y	Y	Y	Y	Y	Y	Y	Y	Y	Y	Y
Control circuit fuse (1 fuse)	F	Any	Y	Y	Y	Y	Y	Y	Y	Y	Y	Y	Y	Y	Y
Control circuit fuses (2 fuses)	F4	Any	Y	Y	Y	Y	Y	Y	Y	Y	Y	Y	Y	Y	Y
Control circuit transformer standard capacity 50/60 Hz															
Primary Fuses	Secondary Fuses	Transformer capacity													
2 [29]	0	Std.	F4T	1, 4, 12	Y	Y	Y	Y	Y	Y	Y	Y	Y	Y	Y
2	1	Std.	FF4T	1, 4, 12	Y	Y	Y	Y	Y	Y	Y	Y	Y	Y	Y
2	1	100 VA Additional	FF4T11	1, 4, 12	Y	Y	Y	Y	Y	Y	Y	Y	Y	Y	Y
2	1	200 VA Additional	FF4T12	1, 4, 12	Y	Y	Y	Y	Y	Y [30]	Y	Y	Y	Y	Y
2	1	300 VA Additional	FF4T13	1, 4, 12	Y	Y	Y	Y	Y	Y	Y [30]	Y	Y	Y	Y
Noise reduced enclosure and shock mounted panel	G4	Any	—	Y	—	—	—	Y	Y	Y	Y	Y	Y	Y	Y
Addition of photoelectric receptacle	G10	1 [32], 3R, 12	Y	—	Y	—	Y	Y	Y	Y	Y	Y	Y	Y	Y
Addition of photoelectric receptacle with photo-cell	G101	1 [32], 3R, 12	Y	—	Y	—	Y	Y	Y	Y	Y	Y	Y	Y	Y
Addition of photoelectric receptacle and relay (R6)[33]	G10R6	1 [32], 12	—	Y	—	Y	—	Y	Y	Y	Y	Y	Y	Y	Y
With photo-cell installed [33]	G101R6	1 [32], 12	—	Y	—	Y	—	Y	Y	Y	Y	Y	Y	Y	Y
Addition of terminal blocks (other than standard). The designation xx represents the number of terminals needed. Available in multiples of 5 only.															
Wired	G56xx	Any	Y	Y	Y	Y	Y	Y	Y	Y	Y	Y	Y	Y	Y
Unwired	G50xx	Any	Y	Y	Y	Y	Y	Y	Y	Y	Y	Y	Y	Y	Y
Addition of 24 hour time clock (120-277 V only)	K14	1, 4, 12	Y	Y	Y	Y	—	Y	Y	Y	Y	Y	Y	Y	Y
Addition of 24 hour time clock w/day omission (120-277 V)	K141	1, 4, 12	Y	Y	Y	Y	—	Y	Y	Y	Y	Y	Y	Y	Y
Addition of 7 day time clock (120-277 V)	K142	1, 4, 12	Y	Y	Y	Y	—	Y	Y	Y	Y	Y	Y	Y	Y
Addition of 24 hour time clock (120-277 V only)	K14	3R	—	—	—	—	Y	—	Y	Y	Y	Y	Y	—	—
Addition of 24 hr time clock w/skip day (120-277 V)	K141	3R	—	—	—	—	Y	—	Y	Y	Y	Y	Y	—	—
Addition of 7 day time clock (120-277 V)	K142	3R	—	—	—	—	Y	—	Y	Y	Y	Y	Y	—	—
Addition of solid neutral terminal block	N	1, 4, 12	Y	Y	Y	Y	Std.	Y	Y	Y	Y	Y	Y	Y	Y
Red pilot light	P1	Any	Y	Y	Y	Y	Y	Y	Y	Y	Y	Y	Y	Y	Y
Two or more lights [34] (each)	P	Any	Y	Y	Y	Y	Y	Y	Y	Y	Y	Y	Y	Y	Y
Red push-to-test pilot light	P21	Any	Y	Y	Y	Y	Y	Y	Y	Y	Y	Y	Y	Y	Y
Interlock necessary for pilot light one needed for each additional pilot light	[35]	Any	Y	Y	Y	Y	Y	Y	Y	Y [36]	Y	Y	Y	Y	Y
Two-wire interface for mechanically held [33]	R6	Any	—	Y	—	Y	—	Y	Y	Y	Y	Y	Y	Y	Y
Addition of undervoltage and overvoltage relay	R46	Any	Y	Y	Y	Y	Y	Y	Y	Y	Y	Y	Y	Y	Y
Three wire control for long distance applications[33]	R62	Any	—	Y	—	Y	—	Y	Y	Y	Y	Y	Y	Y	Y
Auxiliary contacts (specify number of N.O. + N.C.)	X	Any	Y	Y	Y	Y	Y	Y	Y	Y [36]	Y	Y	Y	Y	Y
Auxiliary electrical interlock installed on disconnect switch or circuit breaker operating mechanism	Y74	Any	—	—	Y	Y	Y	—	Y	Y	Y	Y	Y	Y	Y
Coil transient suppressor (120 Vac only)	Y145	Any	Y	Y	Y	Y	Y	Y	Y	Y	Y	Y	Y	—	—
Addition of lightning arrestor	Y1532	Any	Y	Y	Y	Y	Y	Y	Y	Y	Y	Y	Y	Y	Y
Substitute copper only lugs for standard	Y157	Any	Y	Y	Y	Y	Y	—	—	Y	Y	Y	Y	Y	Y

[28] When ordering Form C on mechanically held devices, you must also include Form R6.  
 [29] Transformer voltage codes.  
 [30] Single primary voltage must be specified using the codes shown in Table 16.217.  
 [31] Mechanically held only. Electrically held device has a control circuit requiring a 120 V secondary, therefore, a transformer is supplied. The transformer comes wired to L1 and L2 unless Form S is called for. It is supplied with two primary and one secondary fuse.  
 [32] Photocell mounted on a NEMA 1 enclosure is designed for indoor areas which rely on natural light. Addition of the photocell does not make the enclosure suitable for outdoor (NEMA Type 3R) installations.  
 [33] Available for 24 V, 120 V, 240 V, 277 V and 480 V applications only.  
 [34] For electrically held enclosed devices, the first pilot is wired in parallel with the coil. Operating interlocks are required for all additional pilot lights. Mechanically held devices require operating interlocks for all pilot lights.  
 [35] Do not use Form X for any interlock wired in series with a pilot light, but do specify how the pilot light and interlock are to be wired into the circuit.  
 [36] Electrically held 20 A multipole contactors cannot add interlocks. Additional poles can be used for the same function, however. Mechanically held (Type LX) provide one double throw auxiliary (or status) contact as standard.

Table 16.217: Voltage Codes

Voltage at 60 Hz (primary–secondary)	Code
120–24	V89
208–120	V84
240–24	V82
240–120	V80
277–120	V85
480–24	V83
480–120	V81
480–240	V87
600–120	V86

Order Example			
Class	Type	Voltage Code	Form [37]
8903	SMG2	V81	FF4T

You have device 8903SMG2V02. V02 means that you need a coil voltage of 120-60/110-50, wired for separate control.  
You want to add Form FF4T, with transformer voltages of 480 V primary, 120 V secondary. The new and complete Class, Type, Voltage Code and Form number are:

16 NEMA AND DEFINITE PURPOSE CONTACTORS AND STARTERS

Table 16.218: Lighting Contactor Field Modifications

Description	Types L & LX		Type S						Form No.
	30 A Kit	30 A Kit	60 A Kit	100 A Kit	200 A Kit	300 A Kit	400, 600, 800 A Kit		
<b>Auxiliary Contacts</b>									
1 N.O. LH or RH Mounting	—	9999SX6	9999SX6	9999SX6	9999SX6	9999SX6	9999SX6	X	
1 N.C. LH or RH Mounting	—	9999SX7	9999SX7	9999SX7	9999SX7	9999SX7	9999SX7		
1 N.C. & 1 N.O. Isolated LH or RH	—	9999SX8	9999SX8	9999SX8	9999SX8	9999SX8	9999SX8		
1 N.O. Overlapping LH or RH	—	9999SX9	9999SX9	9999SX9	9999SX9	9999SX9	9999SX9		
1 N.C. Overlapping LH or RH	—	9999SX10	9999SX10	9999SX10	9999SX10	9999SX10	9999SX10		
<b>Control Circuit Fuse Holder</b>									
Single Fuse Unit	9999LLX and 9999SFR3	9999SFR3	9999SFR3	9999SFR3	9999SFR3	9999SFR3	9999SFR3	F	
Two Fuse Unit	9999LLX and 9999SFR4	9999SFR4	9999SFR4	9999SFR4	9999SFR4	9999SFR4	9999SFR4	F4	
<b>Transformers</b>	9070TF50	9070TF100	9070TF100	9070TF150	9070TF300	9070TF500	9070TF750	T	
<b>Oversized Enclosures (Non-Combo)</b>									
NEMA 1	9991SDG3	9991SDG3	9991SDG3	—	—	—	—	—	
NEMA 4	9991SDW3	9991SDW3	9991SDW3	—	—	—	—	—	
NEMA 12	9991SDA3	9991SDA3	9991SDA3	—	—	—	—	—	
<b>Standard Enclosures</b>									
NEMA 1—Surface Mount	9991LXG1	9991SCG7 [38]	9991SDG7 [38]	9991SFG8	9991SFG4	9991SGG8	—	—	
NEMA 3R	9991SDH1	9991SCH2	9991SDH1	9991SEH1	9991SFH1	—	—	—	
NEMA 4—Standard	9991SDW1	9991SCW1	9991SDW1	—	—	—	—	—	
NEMA 4—With 2 Cvr Mtd. Clsng Pits	9991SDW11	9991SCW11	9991SDW11	9991SEW11	—	—	—	—	
NEMA 4X—Glass Polyester	9991SDW20	9991SCW20	9991SDW20	—	—	—	—	—	
NEMA 12	9991SDA11	9991SCA11	9991SDA11	9991SEA11	—	—	—	—	
NEMA 1—Flushmount—Complete	—	—	—	9991SEF11	—	—	—	—	
NEMA 1—Flush Mount Parts	—	—	—	—	—	—	—	—	
<b>FLUSH PARTS</b>									
Standard—Elec. held	9991SDF13	9991SCF11	9991SDF11	—	—	—	—	—	
Standard—Mech. held	9991SDF13	9991SCF13	9991SDF13	—	—	—	—	—	
Mounting Strap	9991SDF2	9991SCF2	9991SDF2	—	—	—	—	—	
Pull Box	9991SDF1	9991SCF1	9991SDF1	—	—	—	—	—	
Internal Operator Mounting Bracket	3010215901	3010215901	3010215901	3010215901	3010215901	3010215901	3010215901	G53	
Solid Neutral	9999SN1	9999SN1	9999SN1	9999SN1	9999SN2	9999SN2	9999SN3 [39]	N	
<b>Combination Lighting Contactor Disconnect Interlock Kit</b>									
Breaker Type	—	9999R26	9999R26	9999R26	9999R26	9999R26	9999R26	Y74	
1-Pole	—	9999R27	9999R27	9999R27	9999R27	9999R27	9999R27		
Disconnect Type	—	9999TC11	9999TC10	9999TC10	9999R8	9999R35	9999R26	Y74	
1-Pole	—	9999TC21	9999TC20	9999TC20	9999R9	9999R36	9999R27		
<b>Lightning Arrestor</b>									
175 Vac to Ground Max 2 or 3 wire Grounded	SDSA1175	SDSA1175	SDSA1175	SDSA1175	SDSA1175	SDSA1175	SDSA1175	Y1532	
650 Vac to Ground Max 3 or 4 wire Grounded	SDSA3650	SDSA3650	SDSA3650	SDSA3650	SDSA3650	SDSA3650	SDSA3650		

[37] Form numbers should always be shown in alphabetical order.  
 [38] For electrically held only.  
 [39] Limited to 400 and 600 A versions. 800 A is a factory modification only.

## Cover Mounted Control Units

Table 16.219: Mechanically Held

Description	Form No.	TYPE LX		TYPE S				
		30 A Kit	30 A Kit	60 A Kit	100 A Kit	200 A Kit	300 A Kit	400, 600, 800 A Kit
<b>Push Button (On-Off)</b> NEMA 1 Enclosure 9001KA2	A3	9999BLX 9999LXPB	[40]	9001KA2 9999SA3 [41]	9001KA2 9999SA3 [41]	9001KA2 9999SA3 [41]	9001KA2 9999SA3 [41]	9001KA2 9999SA3 [41]
NEMA 3R, 4 or 12 Enclosure 9001KA2 9999SA3 [41]		9001KA2 9999SA3 [41]	9001KA2 9999SA3 [41]	9001KA2 9999SA3 [41]	9001KA2 9999SA3 [41]	9001KA2 9999SA3 [41]	9001KA2 9999SA3 [41]	9001KA2 9999SA3 [41]
<b>Selector Switch (2 Position)</b> NEMA 1 Enclosure NEMA 3R, 4 or 12 Enclosure	C6	9999BLX 9999LXS	9001KN244 9001KS11BH1	9001KN244 9001KS11BH1	9001KN244 9001KS11BH1	9001KN244 9001KS11BH1	9001KN244 9001KS11BH1	9001KN244 9001KS11BH1
NEMA 3R, 4 or 12 Enclosure 9001KN244 9001KS11BH1		9001KN244 9001KS11BH1	9001KN244 9001KS11BH1	9001KN244 9001KS11BH1	9001KN244 9001KS11BH1	9001KN244 9001KS11BH1	9001KN244 9001KS11BH1	9001KN244 9001KS11BH1
<b>Selector Switch (3 Position)</b> NEMA 1 Enclosure (must include two wire control relay, Form R6)	C	9999BLX 9999SC2	9001KN260 9001KS46BH2	9001KN260 9001KS46BH2	9001KN260 9001KS46BH2	9001KN260 9001KS46BH2	9001KN260 9001KS46BH2	9001KN260 9001KS46BH2
NEMA 3R, 4 or 12 Enclosure 9001KN260 9001KS46BH2		9001KN260 9001KS46BH2						
<b>Two Wire Control Relay</b> (Form R6) [42]	R6	9999RLX CA2SK11 [43]	8501XO11	8501XO11	8501XO11	8501XO11	8501XO11	8501XO11

Table 16.220: Electrically Held

Description	Form No.	TYPE L		TYPE S				
		30 A Kit	30 A Kit	60 A Kit	100 A Kit	200 A Kit	300 A Kit	400, 600, 800 A Kit
<b>Pilot Lights (Red and Green)</b> NEMA 1 Enclosure NEMA 3R, 4 or 12 Enclosure	P1	9999SP28R	9999SP28R	9999SP3R 9999SP28R	[44] 9999SP14R 9999SP28R	[45] 9999SP28R 9999SP28R	[45] 9999SP28R 9999SP28R	9999SP28R 9999SP28R
<b>Push Buttons [46]</b> NEMA 1 Enclosure NEMA 3R, 4 or 12 Enclosure	A12	9999BLX 9999SA10	9999SA10	9999SA10	9999SA3	9999SA3	9999SA3	9999SA3
NEMA 3R, 4 or 12 Enclosure 9999SA3		9999SA3	9999SA3	9999SA3	9999SA3	9999SA3	9999SA3	9999SA3
<b>Selector Switch (2 Position)</b> NEMA 1 Enclosure NEMA 3R, 4 or 12 Enclosure	C6	9999BLX 9999SC22	9999SC22	9999SC22	9999SC22	9001KN244 9001KS11BH1	9001KN244 9001KS11BH1	9001KN244 9001KS11BH1
NEMA 3R, 4 or 12 Enclosure 9001KN244 9001KS11BH1		9001KN244 9001KS11BH1	9001KN244 9001KS11BH1	9001KN244 9001KS11BH1	9001KN244 9001KS11BH1	9001KN244 9001KS11BH1	9001KN244 9001KS11BH1	9001KN244 9001KS11BH1
<b>Selector Switch (3 Position)</b> NEMA 1 Enclosure NEMA 3R, 4 or 12 Enclosure	C	9999BLX 9999SC2	9999SC2	9999SC2	9999SC2	9999SC8	9999SC8	9999SC8
NEMA 3R, 4 or 12 Enclosure 9999SC8		9999SC8	9999SC8	9999SC8	9999SC8	9999SC8	9999SC8	9999SC8

[40] No field installed kit available.

[41] Mechanically held contactors need two distinct signals to operate. An N.O. contact block must be added to the Class 9999 Type SA3 push button kit.

[42] Form R6 available for 24 V, 120 V, 240 V and 277 V only.

[43] Insert CA2SK11( ) voltage code from page 23-21.

[44] 2- or 3-pole only. For 4- or 5-pole use Class 9999SP15R.

[45] The coil voltage must be the same as the pilot light rating. Kit contains one (1) Class 9001, Type KP1R6 120 V/60 Hz red pilot light control unit. For other voltages, refer to the Class 9001, Type KP Control Section.

[46] Requires holding circuit interlock for Type S or additional power pole on Type L devices.

Open Type

Table 16.221: Open Type

Rating (A)	Type	No. of Poles	Electrically Held				Type	Mechanically Held					
			Dimensions					Dimensions					
			A	B	C	E		A	B	C	D	E	F
30	LO	2-4	2.88 73	5 127	4.62 117	3.12 79	LXO	2.88 73	—	—	8.81 224	3.25 83	7.70 196
		6	4.25 108	5 127	4.62 117	3.12 79		4.25 108	—	—	8.81 224	3.25 83	7.70 196
		8-12	5.63 143	5 127	4.62 117	3.12 79		5.63 143	—	—	8.81 224	3.25 83	7.70 196
30	SMO	2-3	4.34 110	3.22 82	4.22 107	3.50 89	—	7.15 182	3.79 96	4.68 119	—	6.04 153	—
		4-5	4.34 110	4.25 108	4.22 107	3.50 89	—	7.15 182	4.54 115	4.68 119	—	6.04 153	—
60	SPO	2-3	5.33 135	4.31 110	4.94 125	5.50 140	—	8.25 210	4.61 117	5.23 133	—	7.81 198	—
		4-5	6.22 158	5.61 142	4.94 125	5.50 140	—	8.70 221	5.90 150	5.23 133	—	7.81 198	—
100	SQO	2-3	7.09 180	5.45 138	6.50 165	7.26 184	—	10.13 257	5.94 151	6.72 171	—	7.26 184	—
		4-5	7.82 199	9.75 248	6.50 165	7.26 184	—	10.56 268	9.75 248	6.72 171	—	7.26 184	—
200	SVO	2-3	9.14 232	6.00 152	6.50 165	9.14 232	SVO	11.35 288	6.00 152	6.72 171	—	9.14 232	—
		4, 5[47]	9.14 232	9.75 248	6.50 165	9.14 232		11.55 293	9.75 248	6.72 171	—	9.14 232	—
300	SXO	2-3	12.31 313	8.66 220	8.74 222	12.25 311	SXO	12.31 313	8.66 220	10.50 267	—	12.31 313	—
400	SYO	2-3	—	12.33 313	9.00 229	27.78 706	SYO	—	8.66 220	10.50 267	—	21.00 533	—
600	SZO			—	—	—	—	—	—	—	—	—	—
800	SJO	2-3	—	12.33 313	11.94 303	42.70 1085	—	—	—	—	—	—	

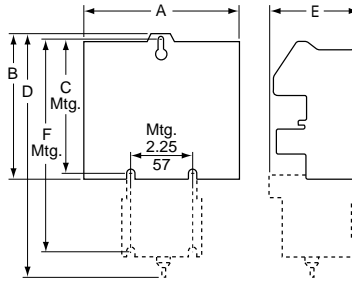

Open Type L and LX

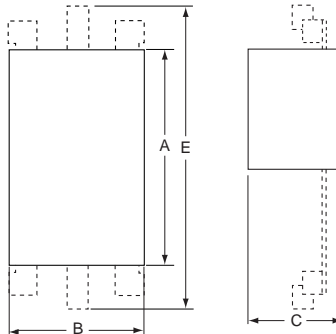

Open Type S

**NOTE:** These dimensions are for reference only. If you need precise measurements, contact the Customer Care Center at 1-888-778-2733.

[47] 5-Pole, electrically held only.



**NEMA 1**

**Table 16.222: NEMA 1 Non-Combination Lighting Contactors, Electrically Held (EH) and Mechanically Held (MH)**

Rating (A)	Type	No. of Poles	Form(s)	Fig.	Dimensions, in. (mm)													
					A	B	C	D	E	F	G	H	I	J	K	L		
30	LG, LXG	Any	Standard, A3, A12, C, C6, F, P, R6, Y48	A	7.81 (198)	12.69 (322)	6.03 (153)	—	1.09 (28)	10.50 (267)	1.09 (28)	1.09 (28)	5.63 (143)	5.75 (146)	1.09 (28)	5.63 (143)		
			P, T	B	11.88 (302)	11.88 (302)	7.44 (189)	9.75 (248)	1.06 (27)	1.06 (27)	9.75 (248)	1.06 (27)	1.06 (27)	1.06 (27)	0.31 (8)	—		
			K14, K141, K142	A	16.00 (406)	22.00 (559)	7.38 (188)	8.00 (203)	1.00 (25)	20.00 (508)	1.00 (25)	1.00 (25)	14.00 (356)	7.38 (188)	1.00 (25)	7.00 (178)		
30	SMG	2-5	EH Standard, A12, C, C6, P, X	A	6.00 (152)	10.00 (254)	5.28 (134)	3.00 (76)	0.88 (22)	8.13 (206)	1.00 (25)	0.94 (24)	4.13 (105)	5.00 (127)	—	—		
			MH Standard, X															
			EH T	A	6.34 (161)	15.88 (403)	5.19 (132)	14.38 (365)	4.66 (118)	0.28 (7)	0.75 (19)	0.84 (21)	—	—	—	—		
			MH N															
			MH T, N, R6	B	14.88 (378)	14.12 (359)	7.56 (192)	12.75 (324)	1.06 (27)	1.06 (27)	12.00 (305)	1.06 (27)	1.06 (27)	1.06 (27)	0.31 (8)	—	—	
A3, C, C6, P																		
60	SPG	2-3	EH Standard, A12, C, C6, P, X	A	7.81 (198)	12.69 (322)	6.03 (153)	—	1.09 (28)	10.50 (267)	1.09 (28)	1.09 (28)	5.63 (143)	5.75 (146)	1.09 (28)	5.63 (143)		
			EH Standard, A12, C, C6, P, X	B	8.12 (206)	14.12 (359)	9.73 (247)	6.00 (152)	1.06 (27)	1.06 (27)	12.00 (305)	1.06 (27)	1.06 (27)	0.31 (8)	—			
			EH, MH T, N, R6	B	14.88 (378)	14.12 (359)	7.56 (192)	12.75 (324)	1.06 (27)	1.06 (27)	12.00 (305)	1.06 (27)	1.06 (27)	0.31 (8)	—			
			MH Standard, A3, C, C6, P, X	B	8.12 (206)	14.12 (359)	9.73 (247)	6.00 (152)	1.06 (27)	1.06 (27)	12.00 (305)	1.06 (27)	1.06 (27)	0.31 (8)	—			
			100	SQG	2, 3 [48]	EH Standard, A12, C, C6, F, P, X, T	B	11.25 (286)	25.15 (639)	8.99 (228)	8.60 (218)	1.25 (32)	1.25 (32)	22.32 (567)	1.42 (36)	1.42 (36)	0.44 (11)	—
MH Standard, F, X, T																		
2, 3	EH N, R6, T, T10-T13 [49]	B			18.15 (461)	29.15 (740)	9.24 (234)	15.50 (394)	9.24 (234)	1.33 (34)	1.33 (34)	26.50 (673)	1.33 (34)	1.33 (34)	0.44 (11)	—	—	
	MH A3, C, C6, N, R6, T, T10-T13 [49]																	
4, 5	EH Standard, A12, C, C6, F, P, X	B			11.25 (286)	25.15 (639)	8.99 (228)	8.60 (218)	1.25 (32)	1.25 (32)	22.32 (567)	1.42 (36)	1.42 (36)	1.42 (36)	0.44 (11)	—	—	
	MH Standard, F, X																	
	EH [49]																	
MH A3, C, C6 [49]	B	18.15 (461)	29.15 (740)	9.24 (234)	15.50 (394)	9.24 (234)	1.33 (34)	1.33 (34)	26.50 (673)	1.33 (34)	1.33 (34)	0.44 (11)	—	—				
EH, MH N, R6, T, T10-T13	B	22.15 (563)	39.15 (994)	10.24 (260)	19.50 (495)	1.33 (34)	1.33 (34)	36.50 (927)	1.33 (34)	1.33 (34)	0.44 (11)	—	—					
200	SVG	All	EH, MH Standard and All Forms	B	22.15 (563)	39.15 (994)	10.24 (260)	19.50 (495)	1.33 (34)	1.33 (34)	36.50 (927)	1.33 (34)	1.33 (34)	0.44 (11)	—	—		
			300	SXG	All	EH, MH Standard and All Forms	B	17.21 (437)	44.21 (1123)	12.83 (325)	13.00 (330)	2.11 (54)	2.11 (54)	40.00 (1016)	2.11 (54)	2.11 (54)	0.56 (14)	—
400, 600	SYG, SZG	All				EH, MH Standard and All Forms	B	20.21 (513)	65.75 (1670)	13.10 (333)	11.00 (972)	4.61 (117)	4.61 (117)	64.50 (1638)	0.63 (16)	0.63 (16)	0.69 (18)	—
			800	SJG	2-3	With or Without Any Forms	C	34.50 (876)	93.00 (2362)	23.50 (597)	Floor Mounting							

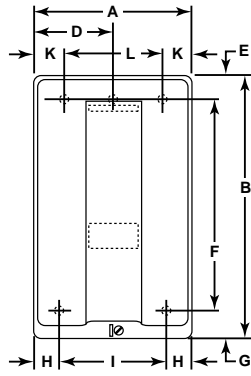

Figure A

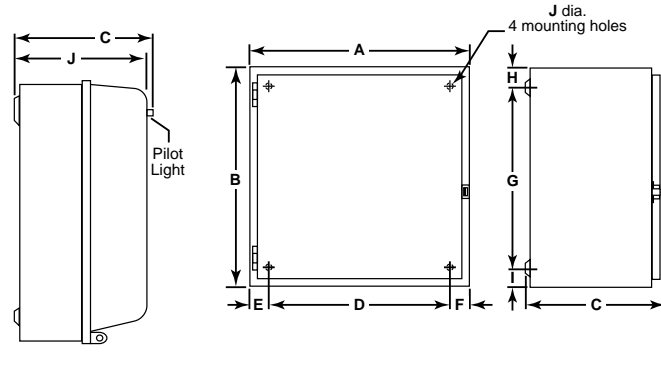

Figure B

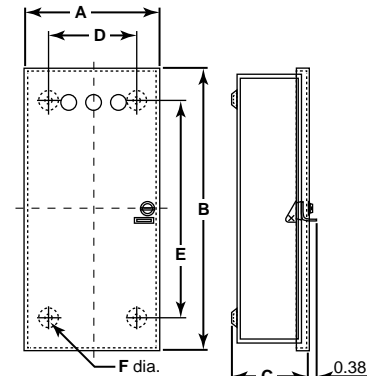

Figure C

[48] Factory transformer only.  
[49] All Type K Forms.

NEMA 1 Flush Mounting

Table 16.223: NEMA 1 Flush Mounted Enclosures

Rating (A)	Type	Form(s)	Dimensions						
			A	B	C	D	E	F	G
30	LF	Standard, F, Y48, R6	15.19 386	8.94 227	7.63 194	12.88 327	5.44 138	10.94 278	5.13 130
	LXF	A3, A12, C, C6, T, P	24.00 610	17.50 445	15.00 381	19.25 489	7.12 181	—	—
30	SMF	EH Std., A12, C, C6, P, X	13.44 341	7.19 183	5.88 149	11.13 283	4.75 121	9.19 233	4.50 114
		MH Std., X							
		EH T, N	24.00 610	17.50 445	15.00 381	19.25 489	5.75 146	—	—
		MH A3, C, C6, T, N, P, R6							
60	SPF	EH Std., A12, C, C6, P, X	15.19 386	8.94 227	7.63 194	12.88 327	5.44 138	10.94 278	5.13 130
		MH Std., X							
		EH T, N	24.00 610	17.50 445	15.00 381	19.25 489	5.75 146	—	—
		MH A3, C, C6, T, N, P, R6							
100	SQF	With or without any Forms	31.00 787	16.75 425	14.25 362	26.25 667	8.00 203	—	—

EH = Electrically Held. MH = Mechanically Held.

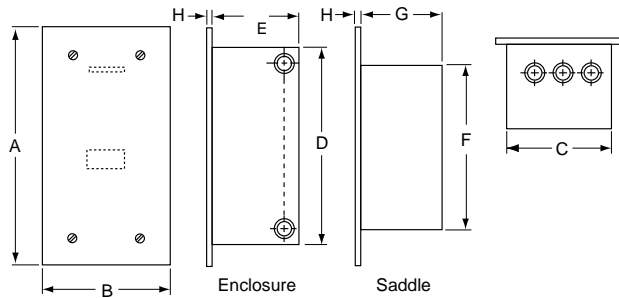

Figure 16.19: NEMA 1 Flush Mounted

Dimensions: in.  
mm

16 NEMA AND DEFINITE PURPOSE CONTACTORS AND STARTERS

**NEMA 3R, 4, and 4X**

**NOTE:** These dimensions are for reference only. If you need precise measurements, contact the Customer Care Center at 1-888-778-2733.

**Table 16.224: NEMA 3R Enclosures**

Rating (A)	Type	No. of Poles	A	B	C	D1	D2	E	F	G1	G2	H1	H2	J	K	L	M	N	P	K.O. X	K.O. Y
30	SMH	All	8.83 224	12.30 312	7.12 181	1.39 35	1.44 37	6.00 152	7.50 191	2.64 67	2.16 55	2.08 53	2.62 66	14.28 363	1.37 35	1.37 35	1.88 48	4.38 111	1.83 46	0.5 0.75 1	0.5 0.75 1
30	LH	All	9.83 250	16.30 414	8.62 219	1.39 35	1.44 37	7.00 178	11.50 292	2.64 67	2.16 55	2.08 53	2.62 66	16.78 426	1.31 33	1.75 44	2.13 54	4.88 124	1.83 46	1 1.25	0.5
60	SPH																			1.5	0.75
100	SQH	All	12.83 326	25.30 643	8.62 219	1.39 35	1.44 37	10.00 254	20.50 521	2.64 67	2.16 55	2.08 53	2.62 66	19.78 502	1.31 33	1.94 49	2.44 62	6.38 162	1.83 46	1 1.25 2 2.5	0.5 0.75
200	SVH	All	12.83 326	40.30 1024	9.12 232	1.39 35	1.44 37	10.00 254	35.50 902	2.64 67	2.16 55	2.08 53	2.62 66	20.28 515	1.31 33	2.31 59	2.69 68	6.38 162	1.83 46	1 1.25 2 2.5	0.5 0.75

**Table 16.225: NEMA 4 and 4X Stainless Steel Only Enclosures [50]**

Rating (A)	Type	No. of Poles	Forms	Dimensions for Stainless Steel Enclosures													Bottom Hub Only	Top & Bottom Hub		
				A	B	C	D	E	F	G	H	I	J	K	L	W			X	
30	LW LXW	Any	Standard, F, R6, Y48	8.13 206	7.88 200	16.19 411	1.56 40	5.00 127	15.00 381	0.60 15	1.94 49	14.75 375	2.00 51	2.63 67	0.31 8	0.75	1.5			
			A3, A12, C, C6, P, T	12.62 321	7.81 198	14.69 373	2.56 65	7.50 191	13.50 343	0.63 16	3.38 86	18.44 468	1.69 43	2.31 59	0.31 8	0.75	1			
30	SMW	2-5	EH Std., A12, C, C6, P, X	6.38 162	7.13 181	13.19 335	1.56 40	3.25 83	12.00 305	0.63 16	1.19 30	11.81 300	1.63 41	2.31 59	0.31 8	0.75	1			
			MH Std., F, X	12.63 321	7.11 181	14.69 373	2.56 65	7.50 191	13.50 343	0.63 16	3.19 81	18.50 470	1.64 42	2.31 59	0.31 8	0.75	1			
			EH T	14.88 378	7.25 184	16.31 414	2.56 65	9.75 248	15.00 381	0.63 16	3.19 81	20.88 530	2.06 52	2.63 67	0.31 8	0.75	1.5			
			MH A3, C, C6, T, N, P, R6	8.13 206	7.88 200	16.19 411	1.56 40	5.00 127	15.00 381	0.60 15	1.94 49	14.75 375	2.00 51	2.63 67	0.31 8	0.75	1.5			
60	SPW	2-5	EH Std., A12, C, C6, P, X	8.13 206	7.88 200	16.19 411	1.56 40	5.00 127	15.00 381	0.60 15	1.94 49	14.75 375	2.00 51	2.63 67	0.31 8	0.75	1.5			
			MH Std., A3, C, C6, P, X	14.88 378	7.25 184	16.31 414	2.56 65	9.75 248	15.00 381	0.63 16	3.19 81	20.88 530	2.06 52	2.63 67	0.31 8	0.75	1.5			
			EH T, N, R6	18.15 461	8.77 223	32.21 818	3.08 78	12.00 305	30.50 775	0.61 15	3.67 93	26.71 678	2.58 66	3.19 81	0.44 11	0.75	2.5			
100	SQW	2-3	MH Std., A3, C, C6, F, N, P, R6, T, T10-13, X	18.15 461	8.77 223	32.21 818	3.08 78	12.00 305	30.50 775	0.61 15	3.67 93	26.71 678	2.58 66	3.19 81	0.44 11	0.75	2.5			
			EH Std., A12, C, C6, F, P [51]	18.15 461	8.77 223	32.21 818	3.08 78	12.00 305	30.50 775	0.61 15	3.67 93	26.71 678	2.58 66	3.19 81	0.44 11	0.75	2.5			
		4-5	MH Std., A3, C, C6, P [51]	22.15 563	9.77 248	42.21 1072	3.08 78	16.00 406	40.50 1029	0.61 15	3.67 93	31.71 805	2.33 59	2.88 73	0.44 11	0.75	2.5			
			EH N, R6, T, T10-13	22.15 563	9.77 248	42.21 1072	3.08 78	16.00 406	40.50 1029	0.61 15	3.67 93	31.71 805	2.33 59	2.88 73	0.44 11	0.75	2.5			
200	SVW	All	EH, MH Standard and All Forms	22.15 563	9.77 248	42.21 1072	3.08 78	16.00 406	40.50 1029	0.61 15	3.67 93	31.71 805	2.33 59	2.88 73	0.44 11	0.75	2.5			
300	SXW	All	EH, MH Standard and All Forms	17.21 437	12.63 321	47.21 1199	4.11 104	9.00 229	46.00 1168	0.61 15	4.59 117	28.32 719	3.11 79	5.75 146	0.56 14	0.75	3.5			
400, 600	SYW SZW	All	EH, MH Standard and All Forms	20.21 513	12.13 308	65.21 1656	4.11 104	12.00 305	64.00 1626	0.61 15	4.59 117	30.82 783	2.67 68	4.50 114	0.56 14	0.75 [52]	Two 3 [52]			
800	SJW	2-3	With or without any Forms	34.50 876	23.50 597	101.00 2565											Floor Mounting			

EH = Electrically Held. MH = Mechanically Held.

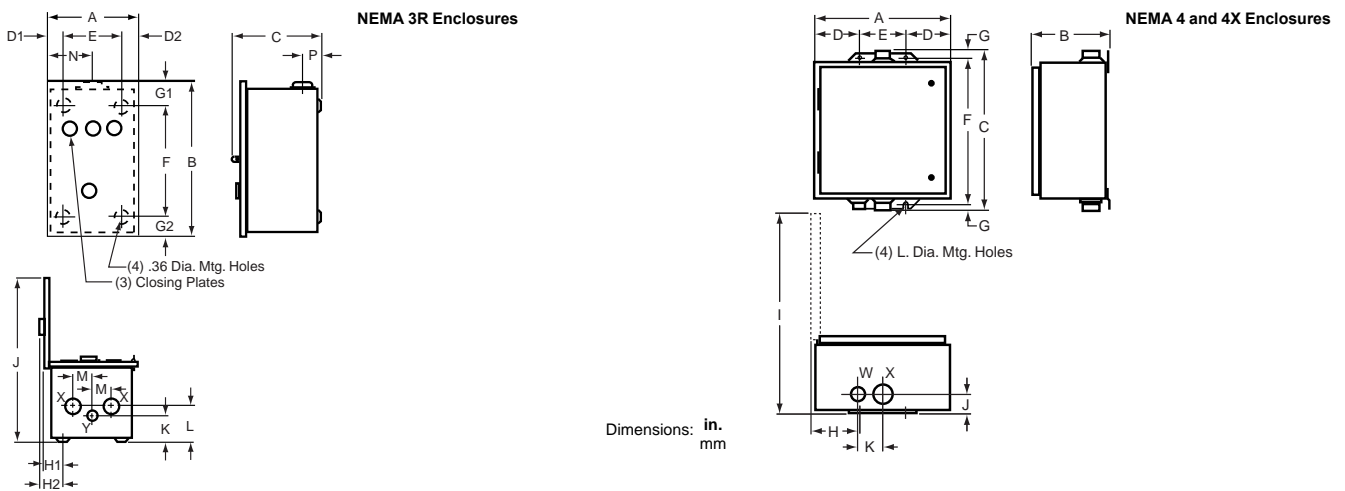

Dimensions: in.  
mm

[50] For glass polyester enclosures (through 100 A), see Table 16.106.

[51] All Type K Forms.

[52] X hub is 1/4" left of center. W hub shown is another X hub. K dimension is distance between two X hubs. Actual W hub is located 3-3/16" to the right of X hub shown.

**NEMA 12/3R and Night-Master™, NEMA 3R**

**Table 16.226: See Figures: NEMA 12/3R (30–600 A) and NEMA 12/3R (800 A) (EH = Electrically Held; MH = Mechanically Held)**

Ampere Rating	Type	Number of Poles	Form(s)	Dimensions									
				A	B	C	D	E	F	G	H	I	J
30	LA LXA	Any	Standard, F, R6, Y48	8.13 206	8.50 216	15.75 400	1.56 40	5.00 127	15.00 381	0.31 8	2.13 54	14.75 375	0.31 8
			A3, A12, C, C6, P, T	14.88 378	7.88 200	16.00 406	2.56 65	9.75 248	15.00 381	0.5 13	3.66 93	21.25 540	0.31 8
30	SMA	2-5	EH Std., A12, C, C6, P, X	6.38 162	8.53 217	12.75 324	1.56 40	3.25 83	12.00 305	0.38 10	3.56 90	12.50 318	0.31 8
			MH Std., F, P, X										
			EH T	11.88 302	7.75 197	13.50 343	2.56 65	6.75 171	12.75 324	0.38 10	3.66 93	18.12 460	0.31 8
			EH N, R6	14.88 378	7.88 200	16.00 406	2.56 65	9.75 248	15.00 381	0.50 13	3.66 93	21.25 540	0.31 8
			MH A3, C, C6, T, N, P, R6										
			MH Std., A12, C, C6, P, X	8.13 206	9.28 236	16.00 406	1.56 40	5.00 127	15.00 381	0.50 13	3.66 93	15.38 391	0.31 8
60	SPA	2-5	EH Std., A12, C, C6, P, X	8.13 206	9.28 236	16.00 406	1.56 40	5.00 127	15.00 381	0.50 13	3.66 93	15.38 391	0.31 8
			MH Std., A3, C, C6, P, X										
			EH T, N, R6	14.88 378	7.88 200	15.75 400	2.56 65	9.75 248	15.00 381	0.38 10	3.66 93	21.25 540	0.31 8
			MH A3, C, C6, T, N, P, R6										
			EH Std., A12, C, C6, F, N, R6, P, T, T10-13, X	18.15 461	9.24 235	31.50 800	3.08 78	12.00 305	30.50 775	0.50 13	3.67 93	26.71 678	0.44 11
			MH Std., A3, C, C6, P, [53]										
100	SQA	2, 3	EH N, R6, T, T10-13, [53]	22.15 563	10.24 260	41.50 1054	3.08 78	16.00 406	40.50 1029	0.50 13	3.67 93	31.71 805	0.44 11
			MH N, R6, T, T10-13, [53]										
			MH N, R6, T, T10-13, [53]										
		4, 5	EH Std., A12, C, C6, F, N, P, [53]										
			MH Std., A3, C, C6, P, [53]										
			MH N, R6, T, T10-13, [53]										
200	SVA	All	EH and MH Standard and All Forms	22.15 563	10.24 260	41.50 1054	3.08 78	16.00 406	40.50 1029	0.50 13	3.67 93	31.71 805	0.44 11
			EH and MH Standard and All Forms	17.21 437	13.33 339	47.00 1194	4.11 104	9.00 229	46.00 1168	0.50 13	4.59 117	28.32 719	0.56 14
400, 600	SYA, SZA	All	EH and MH Standard and All Forms	20.21 513	13.00 330	65.00 1651	4.11 104	12.00 305	64.00 1626	0.50 13	5.31 135	30.87 784	0.69 18
			EH and MH Standard and All Forms										
800	SJA	2-3	With or without any Forms	EH and MH Standard and All Forms	93.00 2362	34.50 876	23.50 597						
				EH and MH Standard and All Forms									

16 NEMA AND DEFINITE PURPOSE CONTACTORS AND STARTERS

**Table 16.227: Night-Master™ Outdoor Lighting Contactors (Short Version)—NEMA 3R Enclosures (see Figure: Night-Master Style)**

Ampere Rating	Description	Type Number	A	B	C	D	E	F	G	H	J [54]	K	L	M	Knockouts		
															N	P	Q
30	Disconnect Switch and Circuit Breaker Types	SMC61, 62, 81	23.50	15.00	8.42	10.50	19.00	22.38	7.00	2.18	1.50	2.13	2.13	2.13	0.50–0.75	1–1.25	0.50–0.75
60		SPC61, 62, 81	597	381	214	267	483	568	178	55	38	54	54	54	0.75	1.50	0.75
100		SQC61, 62, 81	877	508	214	267	763	849	178	55	51	68	68	87	0.75	2–2.50	1.5–2.0
200	Disconnect Switch Type	SVC61, 62	48.37	19.00	9.12	10.53	44.00	47.25	7.00	2.18	2.50	2.68	2.68	3.44	0.50–0.75	1–1.25	1–1.25
	Circuit Breaker Type	SVC81	1229	483	232	267	1118	1200	178	55	64	68	68	87	0.75	2–2.50	1.5–2.0

**Table 16.228: Night-Master™ Outdoor Lighting Contactors (Long Version)—NEMA 3R Enclosures (see Figure: Night-Master Style)**

Ampere Rating	Description	Type Number	A	B	C	D	E	F	G	H	J [54]	K	L	M	Knockouts		
															N	P	Q
30	Disconnect Switch and Circuit Breaker Types	SMC63, 64, 83	38.88	15.00	8.42	10.42	34.38	37.76	7.00	2.18	1.50	2.13	2.13	2.13	0.50–0.75	1–1.25	0.50–0.75
60		SPC63, 64, 83	987	381	214	265	873	959	178	55	38	54	54	54	0.75	1.50	0.75
100		SQC63, 64, 83	1080	508	214	265	966	1052	178	55	51	68	68	87	0.75	2–2.50	1.5–2.0
200	Disconnect Switch Type	SVC63, 64	56.37	19.00	9.12	10.53	52.00	55.25	7.00	2.18	2.50	2.68	2.69	3.44	0.50–0.75	1–1.25	1–1.25
	Circuit Breaker Type	SVC83	1432	483	232	267	1321	1403	178	55	64	68	68	87	0.75	2–2.50	1.5–2.0

**NOTE:** These dimensions are for reference only. If you need precise measurements, contact the Customer Care Center at 1-888-778-2733.

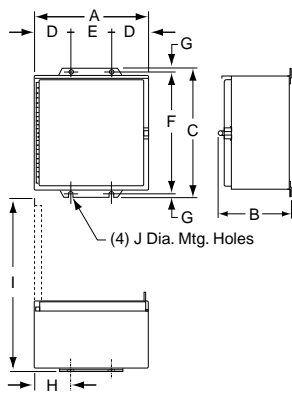

Figure 16.20: NEMA 12/3R (30–600 A)

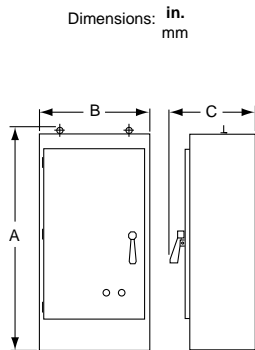

Figure 16.21: NEMA 12/3R (800 A)

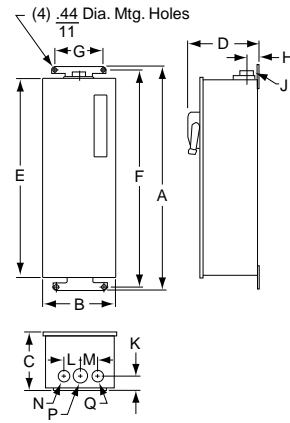

Figure 16.22: Night-Master Style

[53] All Type K Forms using Class 9001 Type K control units.

[54] Conduit size.

Combination Lighting Contactors

Table 16.229: See Figure: NEMA 1 Enclosure, Combination Devices

Ampere Rating	Type	Dimensions [55]															Top & Bot.		Sides
		A	B	C	D	E	F	G	H	I	J	K	L	M	N	O	W	X	Y
30	SMG6 SMG6_	9.50 241	22.50 572	8.37 213	6.38 162	20.50 521	14.68 373	1.81 46	1.69 43	3.37 86	3.38 86	1.06 27	3.25 83	2.18 55	1.25 32	0.87 22	0.50- 0.75	0.50- 0.75	.50
	SMG7_ , SMG9_	13.75 349	23.00 584	8.36 212	10.63 270	21.00 533	20.07 510	1.87 47	1.88 48	3.76 96	2.06 52	1.06 27	3.25 83	2.18 55	1.25 32	0.87 22	0.50-0.75- 1.0	0.50-0.75- 1.0	.50
60	SPG6_ , SPG8_	10.50 267	26.00 660	9.62 244	7.37 187	24.00 610	17.00 432	2.12 54	2.00 51	4.00 102	2.06 52	1.06 27	3.25 83	2.18 55	1.25 32	0.87 22	1.0- 1.25	0.50- 0.75	.50
	SPG7_ , SPG9_	15.00 381	28.75 730	9.62 244	11.62 295	26.25 667	21.50 546	2.18 55	2.00 51	4.00 102	2.56 65	1.31 33	3.25 83	2.18 55	1.25 32	0.87 22	1.0- 1.25	0.50- 0.75	.50

Table 16.230: See Figure: NEMA 1 Enclosure

Ampere Rating	Type	Dimensions [55]															Top & Bot.		Sides			
		A	B	C	D	E	F	G	H	I	J	K	L	M	N	O	W	X	Y			
100	SQG6 SQG7 SQG81, SQG91	15.25 387	39.50 1003	10.60 269	9.25 235	3.00 76	22.68 576	41.00 1041	2.69 68	5.38 137	2.83 72	3.74 95	5.00 127	—	1.21 31	0.90 23	1.-1.25 2.-2.50	0.50- 0.75	0.50			
200	SVG6_ , SVG7 SVG81, SVG91	16.00 406	50.00 1270	10.68 271	10.00 254	3.00 76	23.68 601	51.50 1308	2.69 68	5.38 137	2.83 72	3.74 95	5.00 127	—	1.21 31	0.90 23	2.50	0.50- 0.75	0.50			
300	SXG6_ , SXG7_	20.00 508	75.00 1905	14.37 365	12.00 305	4.00 102	29.43 748	77.00 1956	3.19 81	—	3.52 89	7.00 178	9.25 235	—	—	—	0.50- 0.75	3.00	—			
	SXG81, SXG91	20.00 508	63.00 1600	14.37 365	12.00 305	4.00 102	27.43 697	65.00 1651	3.19 81	—	3.52 89	7.00 178	5.00 127	—	—	—	0.50- 0.75	3.00	—			
400	SYG81, SYG91	36.00 914	90.00 2286	17.00 432	Floor Mounting Enclosure															—	—	—
600	SZG81, SZG91	36.00 914	90.00 2286	17.00 432	Floor Mounting Enclosure															—	—	—

NOTE: These dimensions are for reference only. If you need precise measurements, contact the Customer Care Center at 1-888-778-2733.

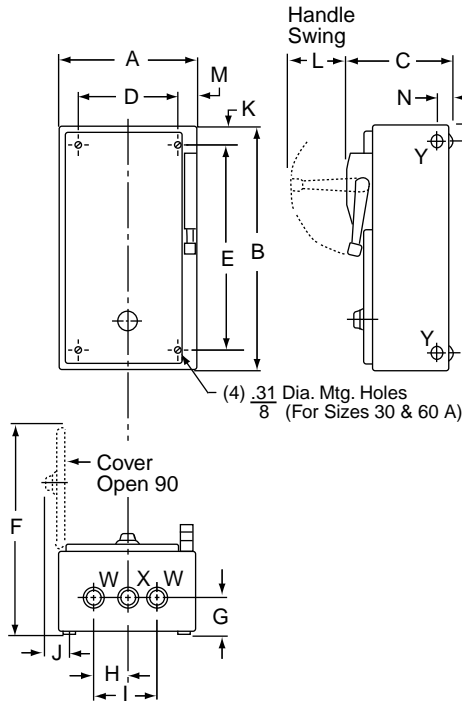

Figure 16.23: NEMA 1 Enclosure, Combination Devices

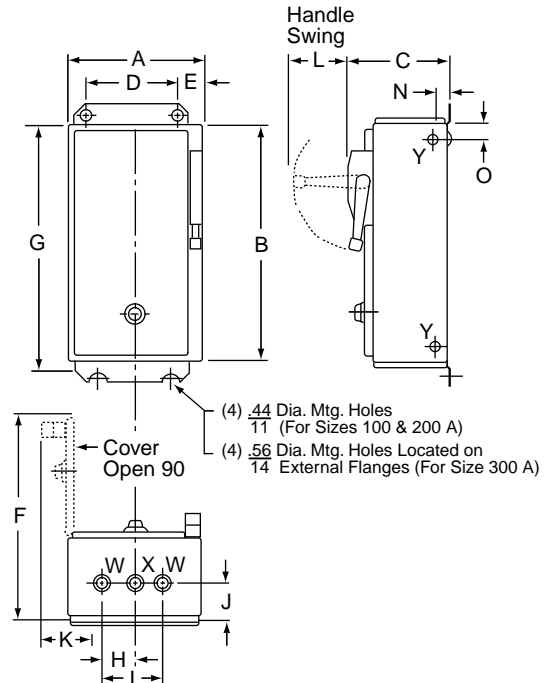

Figure 16.24: NEMA 1 Enclosure

[55] Dimensions are the same for Form FF4T (standard control transformer), Form FF4T11 (100 VA extra capacity) and Form FF4T12 (200 VA extra capacity).

Table 16.231: See Figure: NEMA 4, 4X Enclosure

Ampere Rating	Type	Dimensions [56]															
		A	B	C	D	E	F	G	H	I	J	K	L	W	X		
30	SMW6_, SMW8_	9.50 241	8.36 212	24.76 629	3.25 83	2.50 64	4.50 114	23.50 597	0.63 16	3.00 76	1.62 41	2.31 59	14.31 363	0.75 Hub	1.0 Hub		
	SMW7_, SMW9_	13.75 349	8.36 212	25.26 642	3.25 83	4.75 121	4.25 108	24.00 610	0.63 16	5.25 133	1.62 41	2.31 59	20.14 512	0.75 Hub	1.0 Hub		
60	SPW6_, SPW8_	10.50 267	9.61 244	28.26 718	3.25 83	2.50 64	5.50 140	27.00 686	0.63 16	3.00 76	2.00 51	2.63 67	16.56 421	0.75 Hub	1.50 Hub		
	SPW7_, SPW9_	15.00 381	9.61 244	31.01 788	3.25 83	5.38 137	4.25 108	29.75 756	0.63 16	5.88 149	2.00 51	2.63 67	21.06 535	0.75 Hub	1.50 Hub		
100	SQW6_, SQW7_ SQW8T, SQW9T	15.25 387	10.60 269	41.76 1061	5.00 127	2.50 64	10.25 260	40.50 1029	0.63 16	3.24 82	2.61 66	3.19 81	22.18 563	0.75 Hub	2.50 Hub		
200	SVW6_, SVW7_ SVW8T, SVW9T	16.00 406	10.56 268	52.26 1329	5.00 127	2.50 64	11.00 279	51.00 1295	0.63 16	3.24 82	2.61 66	3.19 81	23.00 584	0.75 Hub	2.50 Hub		
300	SXW6_, SXW7_	20.00 508	14.21 361	78.12 1984	9.25 235	4.00 102	12.00 305	77.00 1956	0.56 14	4.77 121	2.96 75	3.50 89	29.43 748	0.75 Hub	3.50 Hub		
	SXW81, SXW91	20.00 508	14.21 361	66.12 1679	5.00 127	4.00 102	12.00 305	65.00 1651	0.56 14	4.77 121	2.96 75	3.50 89	27.43 697	0.75 Hub	3.50 Hub		
400	SYW81, SYW91	36.00 914	17.71 450	98.00 2489	Floor Mounting Enclosure										—	—	
600	SZW81, SZW91	Floor Mounting Enclosure														—	—

Table 16.232: See Figure: NEMA 12/3R Enclosure

Ampere Rating	Type	Dimensions [56]												
		A	B	C	D	E	F	G	H	I	J			
30	SMA6_, SMA8_	9.50 241	8.36 212	24.26 616	3.25 83	2.50 64	4.50 114	23.50 597	0.38 10	3.25 83	14.31 363			
	SMA7_, SMA9_	13.75 349	10.10 257	24.76 629	3.25 83	4.75 121	4.25 108	24.00 610	0.38 10	5.50 140	22.00 559			
60	SPA6_, SPA8_	10.50 267	9.61 244	27.76 705	3.25 83	2.50 64	5.50 140	27.00 686	0.38 10	3.25 83	16.56 421			
	SPA7_, SPA9_	15.00 381	10.98 279	30.51 775	3.25 83	5.38 137	4.25 108	29.75 756	0.38 10	6.13 156	23.43 595			
100	SQA6_, SQA7_ SQA8T, SQA9T	15.25 387	10.59 269	42.00 1067	5.00 127	3.00 76	9.25 235	41.00 1041	0.50 13	3.75 95	22.31 567			
200	SVA6_, SVA7_ SVA8T, SVA9T	16.00 406	10.52 267	52.50 1334	5.00 127	3.00 76	10.00 254	51.50 1308	0.50 13	3.75 95	23.00 584			
300	SXA6_, SXA7_	20.00 508	14.21 361	78.00 1981	9.25 235	4.00 102	12.00 305	77.00 1956	0.50 13	7.75 197	29.43 748			
	SXA81, SXA91	20.00 508	14.21 361	66.00 1676	5.00 127	4.00 102	12.00 305	65.00 1651	0.50 13	7.75 197	27.43 697			
400	SYA81, SYA91	36.00 914	17.71 450	90.00 2286	Floor Mounting Enclosure							—	—	
600	SZA81, SZA91	Floor Mounting Enclosure											—	—

NOTE: These dimensions are for reference only. If you need precise measurements, contact the Customer Care Center at 1-888-778-2733.

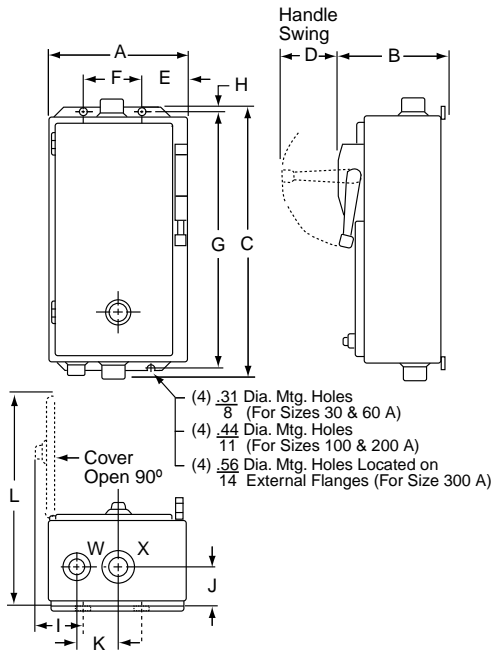

Figure 16.25: NEMA 4, 4X Enclosure

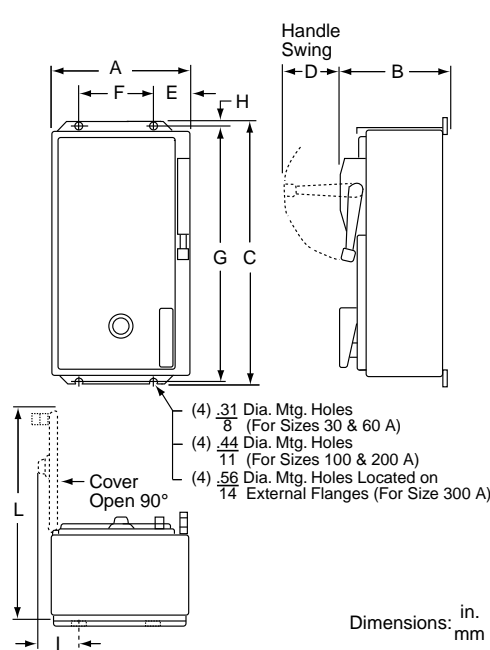

Figure 16.26: NEMA 12/3R Enclosure

Dimensions: in.  
mm

[56] Dimensions are the same for Form FF4T (standard control transformer), Form FF4T11 (100 VA extra capacity) and Form FF4T12 (200 VA extra capacity).



8910DP22V09  
Definite Purpose Contactor



8910DP42V14  
Definite Purpose Contactor



8910DPA33V04  
Definite Purpose Contactor

Definite purpose contactors are ideal for heating, air conditioning, refrigeration, data processing, and food service equipment. New compact 1 and 2-Pole contactors are available along with standard size 2, 3, and 4-Pole devices.

They feature quick connect terminals and binder head screws for easy wiring. Box lugs are standard on 40 A contactors and larger. An exclusive DIN track mounting option may reduce installation costs. Coils can be changed on the Type DPA contactors (50 to 90 A) quickly without a tool. Auxiliary contact modules snap on either side of the Type DPA contactors.

- Compact Design
- Industry Standard Mounting
- Double Break Contacts
- Low Coil VA
- Straight-Through Wiring
- Low Cost

**Table 16.234: Compact 1-Pole Contactors—600 Vac Maximum**  
(replace ●●● with the voltage code)

Full Load Amperes	Locked Rotor Amperes			Resistive Load Amperes	N.O. Poles	Type [3]
	277 V	460 V	575 V			
20	120	100	80	30	1	DP11●●●
25	150	125	100	35	1	DP21●●●
30	150	125	100	40	1	DP31●●●
40	240	200	160	50 (277 V max.) 40 (above 277 V)	1	DP41●●●

**Table 16.235: Compact 2-Pole Contactors—600 Vac Maximum**  
(above 240 V, all lines must be switched) (replace ●●● with the voltage code)

Full Load Amperes	Locked Rotor Amperes			Resistive Load Amperes	N.O. Poles	Type [3]
	277 V	460 V	575 V			
20	120	100	80	30	2	DP12●●●
25	150	125	100	35	2	DP22●●●
30	150	125	100	40	2	DP32●●●
40	240	200	160	50	2	DP42●●●

**Table 16.236: 2, 3, and 4-Pole Contactors—600 Vac Maximum**  
(above 240 V, all lines must be switched) (replace ●●● with the voltage code)

Full Load Amperes	Locked Rotor Amperes			Resistive Load Amperes	Horsepower Ratings				N.O. Poles	Type [3]	
	230 V	460 V	575 V		115 V	230 V	230 V	460/575 V			
					1Ø	1Ø	3Ø	3Ø			
20	120	100	80	30	1.5	3	7-1/2	7-1/2	2	DPA12●●●	
								4		3	DPA13●●●
										4	4
25	150	125	100	35	2	5	10	15/20	2	DPA22●●●	
								4		3	DPA23●●●
										4	4
30	180	150	120	40	2	5	10	15/20	2	DPA32●●●	
								4		3	DPA33●●●
										4	4
40	240	200	160	50	3	7-1/2	10	20/25	2	DPA42●●●	
								4		3	DPA43●●●
										4	4
50	300	250	200	65	3	10	15	30	2	DPA52●●●	
								3		3	DPA53●●●
										3	3
60	360	300	240	75	5	10	25	30	2	DPA62●●●	
								3		3	DPA63●●●
										3	3
75	450	375	300	94	5	15	25	40	2	DPA72●●●	
								3		3	DPA73●●●
										3	3
90	540	450	360	120	7-1/2	20	30	50	2	DPA92●●●	
								3		3	DPA93●●●
										3	3

**Table 16.233: Coil Voltage Codes**

Voltage		Code Type DP, DPA
60 Hz	50 Hz	
24	24	V14
24	—	—
120	110	V02
208	—	—
208-240	220	V09
230-240	220	—
277	—	V04
480	440	V06 [1]
600	550	V07 [2]

[1] Not available for Type DP11 through DP31 single-pole devices.

[2] Not available for Type DP one- and two-pole devices.

[3] Replace the three bullets (●●●) in the catalog number with the coil voltage code. Refer to the standard voltage codes listed in Table 16.233.

**Table 16.237: 2 Normally Open & 2 Normally Closed 4-Pole Contactors—600 Vac Maximum (replace ●●● with the voltage code)**

Full Load (A)	Resistive Load (A)	N.O. Poles	N.C. Poles [4]	Class 8910	
				Type [5]	Form
20	25	2	2	DPA14●●●	Y392
25	35	2	2	DPA24●●●	Y392
30	40	2	2	DPA34●●●	Y392

**NOTE:** N.C. poles on outside. N.C. poles open before N.O. poles close.

**Table 16.238: Auxiliary Contacts, 5 A, 600 Vac Rated**

For Use with Class 8910, Type	Contact Arrangement	Class 9999 Type 20–90 A
DPA	1 N.O.	D10
	1 N.C.	D01
	1 N.O. & 1 N.C.	D11
	2 N.O.	D20

**Table 16.239: NEMA 1 General Purpose Enclosures**

for Type DP, DPA Contactors

Class 8910 Type	Full Load (A)	Poles	Class 9991 Type
DP	20–40	1 & 2	DPG1
DPA	20–40	2 & 3	DPG1
DPA	50	2 & 3	DPG2
DPA	20–40	4	DPG2
DPA	60–75	2 & 3	DPG3
DPA	90	2 & 3	DPG4

**Table 16.240: Terminals**

Full Load (A)	Power Terminals	
	Type of Lug [6]	Wire Range [7]
20–30 A	Binder Head	14–8
40 A	Box Lug or Ring	14–6
50–60 A	Tongue	14–2
75–90 A	Box Lug or Ring	14–2
	Tongue	14–1/0
	Box Lug or Ring	
	Tongue	

**Table 16.241: Miscellaneous Parts**

Description	Class 9999 Type
DIN mounting bracket attachment (Type DPA, 20–60 A)	DMB1
Type DP Series B Cover	DPC1

**Table 16.242: Factory Modifications**

Modification	Type	Form
Factory installed auxiliary contacts	—	[8]
Pressure wire connectors, 20–30 A	DPA	Y122
Box lugs, 20–30 A	DP DPA	Y124
DIN mounting bracket attached (35 mm style), 20–60 A	DP DPA	Y135
Contact cover for Type DP Series B	—	Y248
UL Listed label on device	DP	U1 [9]
Ring tongue terminals: 30–90 A 3 pole DPA contactors	DPA	RT

**Types DP, DPA Application Data Factory Modifications**

Auxiliary contacts can be factory installed along with a DIN mounting bracket option. Special terminations are also available.

**Table 16.243: Application Data**

Description	Specification
Mechanical Life (depending on the application)	500,000 operations
Electrical Life (depending on the application)	
Type DP	100,000 operations
Type DPA	200,000 operations
Duty Cycle	Continuous
Approvals:	
UL Component Recognized	
UL Listed (Form U1)	File E3190, CCN NLDX2
CSA Certified	File E3190, CCN NLDX
DPA is CE marked	File LR25490, Class 321104

**NOTE:** See page 16-124 for replacement contacts.

**Table 16.244: Type DPA Coil Voltage Codes**

Voltage, 60 Hz	Voltage, 50 Hz	Voltage Code
24	24	V14
120	110	V02
208–240	220	V09
277	—	V04
480	440	V06 [10]
600	550	V07 [10]

**Table 16.245: Coil Replacement**

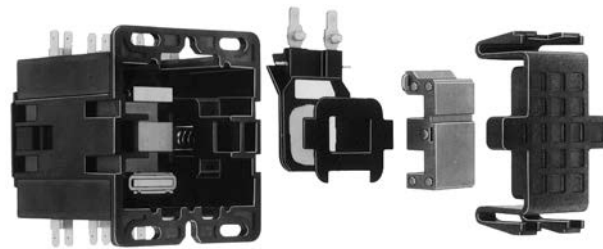

No tools required (DPA50–60A)

**Table 16.246: Class 8910 Type DPA Replacement Coils (replace ●●● with the voltage code)**

Full Load (A)	Poles	Class 9998 Type [11]	Volt-Amperes [12]	
			Inrush	Sealed
50–60 A	2 & 3	DA2●●●	109	10
75–90 A	2 & 3	DA3●●●	214	19

[4] Above 240 V, all lines must be switched.  
 [5] Replace the three bullets (●●●) in the catalog number with the coil voltage code. Refer to the standard voltage codes in Table 16.244.  
 [6] For Ring Tongue, add RT after coil voltage.  
 [7] Solid or stranded copper wire only.  
 [8] Contact your local Schneider Electric sales office.  
 [9] Form U1, Type DPA3\* and DPA4\* have lighting ratings per pole: Tungsten 250 V, 60 Hz, 30 A; and Ballast 277 V, 60 Hz, 40 A.  
 [10] Available for Type DPA contactors only.  
 [11] Append the voltage code from Table 16.244. Example: The coil for Class 8910 Type DPA53V02, 120 V, 60 Hz is Class 9998 Type DA2V02.  
 [12] For Types DP11 through DP32: Inrush 30 VA; Sealed 5 VA.



**Types DP, DPA Approximate Dimensions**

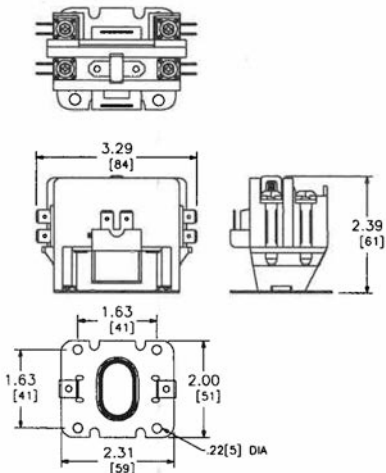

No Cover, No DIN

Type DP—1-Pole  
20 through 40 Full Load Amperes

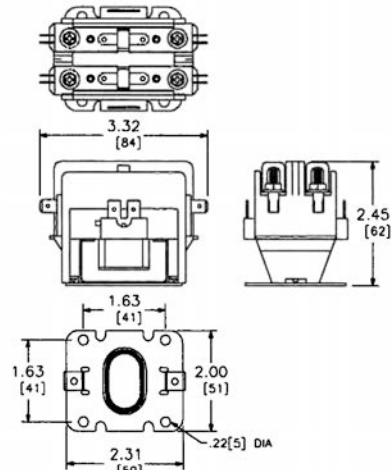

No Cover, No DIN

Type DP—2-Pole  
20 through 40 Full Load Amperes

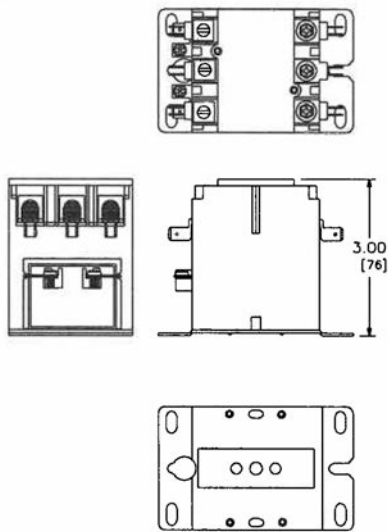

With Cover, No DIN

Type DPA—2 and 3-Pole  
20 through 40 Full Load Amperes

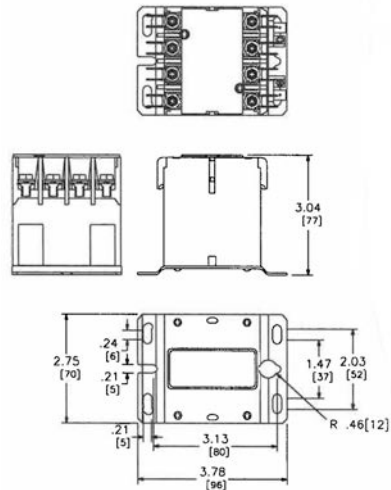

With Cover, No DIN

Type DPA—4-Pole  
20 through 40 Full Load Amperes

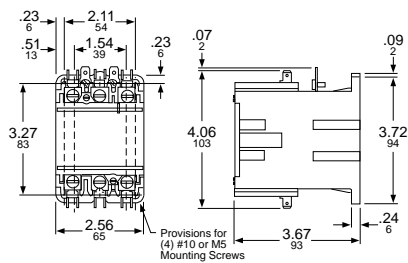

Type DPA—2 and 3-Pole  
50 and 60 Full Load Amperes

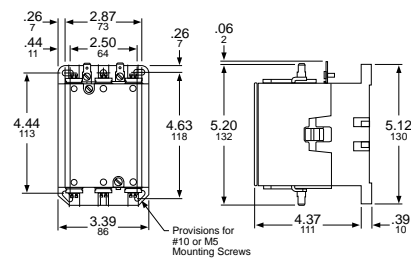

Type DPA—2 and 3-Pole  
75 and 90 Full Load Amperes

Dimensions: in.  
mm

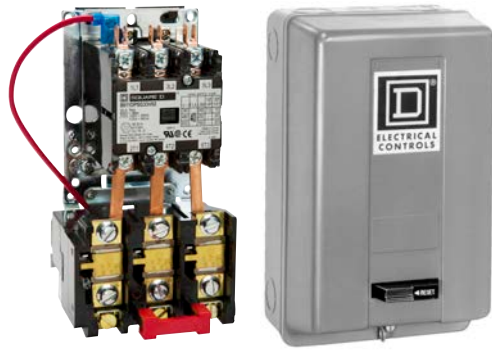

8911DPSO33V09 Definite Purpose Starter

Type DPSG23V02

**Types DPS and H through M**

Class 8911 definite purpose starters are inexpensive starters for applications with relatively low duty cycles. Typical applications include air compressors, agricultural equipment, pumps, and HVAC equipment. Definite purpose starters offer:

- Low cost
- Small size
- Melting alloy overload block
- Trip-free reset mechanism
- Open type or enclosed
- 500,000 mechanical operations

**Table 16.247: 2- and 3-Pole Starters—600 Vac Maximum**

No. of Poles	Full Load (A)	Horsepower Ratings				Open Type Type [2], [3]	NEMA 1 Enclosed Type[2], [3]	No. of Thermal Units [1]
		115 V 1Ø	230 V 1Ø	230 V 3Ø	460/575 V 3Ø			
2-Pole Single Phase	20	1.5	3	—	—	DPSO12●●●	DPSG12●●●	1
	25	2	5	—	—	DPSO22●●●	DPSG22●●●	
	30	2	5	—	—	DPSO32●●●	DPSG32●●●	
	40	3	7.5	—	—	DPSO42●●●	DPSG42●●●	
3-Pole Poly-Phase	50	3	10	—	—	DPSO52●●●	DPSG52●●●	3
	20	1.5	3	7.5	7.5	DPSO13●●●	DPSG13●●●	
	25	2	5	10	15/20	DPSO23●●●	DPSG23●●●	
	30	2	5	10	15/20	DPSO33●●●	DPSG33●●●	
	40	3	7.5	10	20/25	DPSO43●●●	DPSG43●●●	
50	3	10	15	30	DPSO53●●●	DPSG53●●●		

**Table 16.248: Cross Reference Existing/Replacement Class 8911**

Existing Device	Replacement Device
HO33	DPSO13
HG33	DPSG13
JO33	DPSO23
JG33	DPSG23
KO33	DPSO33
KG33	DPSG33
KO43	[4]
KG43	[4]
LO33	DPSO43
LG33	DPSG43
MO33	DPSO53
MG33	
MO43	DPSG53
MG43	[4]
	[4]

**Table 16.249: Miscellaneous Parts and Kits**

Description	Class & Type
Start-Stop push button kit[5]	8911DPB1
Hand-Off-Auto selector switch kit[6]	8911DSS1
Standard N.C. overload relay contact	9998SO1
N.C. and N.O. isolated overload relay alarm contacts	9999SO4
Overload relay jumper strap	9998SO31

**Table 16.250: Replacement Magnet Coil for Class 8911 Type DPS**

Full Load (A)	Poles	Class 9998 Type	Volt A	
			Inrush	Sealed
50 A	2 and 3	DA2[7]	109	10

See page 16-124 for replacement contacts for DPS devices.

**Table 16.251: Coil Voltage Codes**

Voltage, 60 Hz	Voltage, 50 Hz	Voltage Code
24	24	V14
120	110	V02
208-240	220	V09
277	—	V04
480	440	V06
600	550	V07

**Table 16.252: Auxiliary Contacts for Type DPS Starters**

Description	20-90 A
	Class 9999 Type
1 N.O.	D10
1 N.C.	D01
1 N.O./1 N.C.	D11
2 N.O.	D20

**NOTE:** Auxiliary contacts must be field installed.

**Table 16.253: Ratings—Overload Contacts and Auxiliary Contacts**

Device	Volts AC	Pilot Duty – AC Only (35% Power Factor)		Continuous Current Rating
		Make	Carry and Break	
9998 SO1	120 or Less	30 A	3 A	5 A
9999 SO4	120-600	3600 VA	360 VA	5 A
9999 R20 & R21				
9999 D10, D01, D11 & D20				

**Table 16.254: How to Order**

To Order Specify:	Catalog Number			
• Class Number	Class	Type	Coil Voltage Code	Form(s)
• Type Number				
• Voltage Code				
• Form(s)	8911	DPSG33	V02	

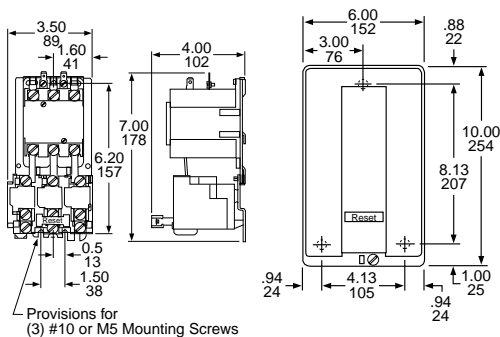

Type DPSO—2 and 3-Pole and DSO 20-50 Full Load Amperes

Type DPSG—2 and 3-Pole 20-40 Full Load Amperes

[1] See for selection information on standard trip thermal units.  
 [2] Holding circuit contacts are not provided as standard; refer to Table 16.252 for kit.  
 [3] Replace the three bullets (●●●) in the catalog number with the coil voltage code. Refer to the standard voltage codes listed in Table 16.251.  
 [4] Type DPS 4-pole starter not available. Suggest 3-pole device with auxiliary contact.  
 [5] Does not include holding circuit interlock—order auxiliary contact.  
 [6] Use for 20 to 40 A starters. For 50 A starters, use the 9999BLX bracket.  
 [7] Append the coil voltage code from Table 16.251.

**Class 8940 Type SS, XS Selection**

Class 8940 Type SS and XS panels in NEMA 3R enclosures are specifically designed for pumping applications. Extra space is provided for field installation of auxiliary equipment.

- Type S Contactor provided as standard
- Approved for submersible pump applications
- Motor Logic™ Class 10/20 (Selectable) SSOLR through 200 hp–480 V, 100 hp–240 V. Included in the catalog number for Type SS (the H30 suffix is required only for eMCP units). (Includes rubber boot.)
- All prices include a Start push button and a Hand-Off-Auto selector switch
- Adjustable trip current
- Phase failure sensitive
- Ambient temperature compensated overload
- All devices are UL Listed, and marked “Suitable For Use As Service Equipment”

**NOTE:** Motor Logic™ SSOLRs are designed to protect 50/60 Hz, three-phase AC motors from overload and phase loss conditions. Open Delta systems or grounded B-phase systems are difficult to balance and could cause the Motor Logic SSOLR to trip. For applications of this nature, it is recommended that bimetallic overload relays (Form B12) be used.

**Table 16.255: 3-Pole Polyphase—480 Vac Maximum (50–60 Hz)—Fusible or Thermal-Magnetic Circuit Breaker [1]**

Volts	Maximum Hp Polyphase	Coil Voltage	Fuse Clip (A) [2]	Type
240	3, 5, 7.5	240–60 220–50	30	SSC2007 [4][5]
	10, 15		60	SSD2015 [4][5]
	20, 25, 30		100	SSE2030 [4]
	40, 50		200	SSF2050 [4]
	75		LLS36400U31X [3]	XSG2075 [6]
	100		400	SSG2100 [4]
	100		LLS36600U31X [3]	XSG2100 [6]
	200		MJL36800 [3]	XSH2200 [6]
	250, 300		PLL34120 [3]	XSJ2300 [6]
	480		3, 5, 7-1/2, 10	480–60 440–50
15, 20, 25		60	SSD4025 [4][5]	
30		60	SSD4030 [4][5]	
40, 50		100	SSE4050 [4]	
60, 75, 100		200	SSF4100 [4]	
150		LLS36400U31X [3]	XSG4150 [6]	
200		400	SSG4200 [4]	
200		LLS36600U31X [3]	XSG4200 [6]	
300, 350, 400		MJL36800 [3]	XSH4400 [6]	
500, 600		PLL34120 [3]	XSJ4600 [6]	

**Table 16.256: 3-Pole Polyphase—480 Vac Maximum (50–60 Hz)—Electronic Motor Circuit Protector (MCP)**

Volts	Max. Hp Polyphase	Coil Voltage [6]	Circuit Breaker [7]	Type
240	30	240–60 220–50	HLL36100M73	XSE2030V03H30
	40		JLL36250M75	XSE2040V03H309 [8]
	50		JLL36250M75	XSF2050V03H30
480	40	480–60 440–50	HLL36100M73	XSE4040V06H30
	50		JLL36250M75	XSE4050V06H30
	75		JLL36250M75	XSE4075V06H309 [8]
	100		JLL36250M75	XSF4100V06H30

**Table 16.257: Class 8940—UL Listed Short Circuit Ratings**

NEMA Size	NEMA Fuse Class or Voltage	Enclosure	Available Amperes RMS Symmetrical
Fusible Type			
0–3	Class H or K	Standard	5,000
0–3	Class R	Standard	100,000
0–2	Class H or K	Standard	5,000
0–2	Class R	Standard	100,000
4–5	Class H or K	Standard	10,000
4–5	Class R	Standard	100,000
6	Class H or K	Standard	18,000
6	Class R	Standard	100,000
Thermal-Magnetic Circuit Breaker Type			
0-5	0-480 V	Standard	100,000
6, 7	0-480 V	Standard	65,000

**NOTE:** Standard enclosures include non-oversize NEMA 1, 4 & 4X Stainless, and 12.

For How to Order information, see page 16-28.

[1] To substitute an IEC ambient compensated bimetallic overload relay (up to size 5) for the Motor Logic SSOLR, request Form B12 and state motor hp (no charge). This applies to the above (SSx) devices only.  
 [2] Fuse clips are sized for use with dual-element time-delay fuses.  
 [3] Circuit breaker disconnect supplied. (See Section 7 for circuit breaker adjustment range.)  
 [4] A voltage code is not required for 240 V or 480 V common control with 8940SS controllers.  
 [5] To select a Motor Logic SSOLR with an FLA lower than the standard NEMA sizing, use the four-character Form H30. See the section “Solid-State Overload Relay Forms.”  
 [6] See Table 16.258 for coil voltage codes.  
 [7] See page 7-32 for circuit breaker adjustment range.  
 [8] FLA is 45–135.



Type WC3S2V06



Type XE3S2V02B12S

**Class 8940 Type W, X**

Class 8940 style S2 pumping plant panels in NEMA 3R enclosures are specifically designed for oil field applications. All panels are supplied with an electronic motor circuit protector (MCP) or a visible blade, fused, disconnect switch. This line of pumping plant panels features:

- Rugged spring latches for easy access without a tool
- Side mounted control units for convenient operation
- Door retainer available for windy areas
- Includes Hand-Off-Auto selector switch
- Motor Logic™ Class 10/20 (selectable) SSOLR included (the H30 suffix is required).
- UL Listed for use as service equipment for motors
- Extra panel space for additional electrical controls
- All devices are UL Listed, and marked "SUITABLE FOR USE AS SERVICE EQUIPMENT"

**NOTE:** Motor Logic™ SSOLRs are designed to protect 50/60 Hz, three-phase AC motors from overload and phase loss conditions. Open Delta systems or grounded B-Phase systems are difficult to balance and could cause the Motor Logic SSOLR to trip. For such applications, we recommend bimetallic overload relays (Form B12).

**Table 16.260: 3-Pole Polyphase—480 Vac Maximum (50–60 Hz)**

V	Max. Hp Poly-phase	Coil Voltage [12]	NEMA Size	Fusible Disconnect Type		Circuit Breaker Type	
				Fuse Clip (A) [13]	Type	Frame Size	Type
240	7-1/2	240–60 220–50	1	30	WC1S2V03H30 [14]	HLL36030M71	XC1S2V03H30 [14]
	10				WD1S2V03H30 [14]	HLL36050M72	XD1S2V03H30 [14]
	15		2	60	WE1S2V03H30	HLL36100M73	XD2S2V03H30 [14]
	30					HLL36100M73	XE1S2V03H30
	50					JLL36250M75	XF2S2V03H30
480	10	480–60 440–50	1	30	WC3S2V06H30	HLL36030M71	XC4S2V06H30
	15				HLL36030M71	XD3S2V06H30	
	25		2	60	WD3S2V06H30	HLL36050M72	XD4S2V06H30
	50				HLL36100M73	XE3S2V06H30	
	100		3	100	WE3S2V06H30	HLL36100M73	XE3S2V06H30
					WF3S2V06H30	JLL36250M75	XF4S2V06H30

**Table 16.261: Factory Modifications (Forms)**

Description	Form
Substitute Class 10 IEC overload relay – state motor hp (NEMA Sizes 0–4 only)	B12
Control transformer with fused primary, Types: <ul style="list-style-type: none"> <li>• NPD, NPE, NPF, SSC, WC, XC (50 VA)</li> <li>• NPG, SSD, XD, WD (100 VA)</li> <li>• NPJ, SSE, XE, WE (150 VA)</li> <li>• SSF, XF, WF (300 VA)</li> <li>• SG, NSG, XSG (50 VA and an interposing control relay)</li> </ul>	F4T
Factory-installed door wind latch assembly in a standard Class 8940 Type SSC, SSD, SSE, SSF, XSE, and XSF	G45
Elapsed time meter	G97
Substitute Class 10/20 (selectable) Motor Logic™ SSOLR [15]	H30
On Delay Timer	K25
Off Delay Timer	K26
Program timer with day omission feature	K141
Backspin timer (time delay upon energization)	K15
Start push button (S2 panels only)	A28
Slim panel (Types WC, WD, WE, XC, XD, XE only)	L8
Short panel (Types SSE, SSF, XE-S2 and XF-S2 only)	L9
Pilot light (specify lens color). Does not include auxiliary contact.	P [16]
Separate control	S
Auxiliary contacts (specify N.O. or N.C.)	X [17]
Special UL panel label for modified UL Listed devices on non-standard panels (requires approval by the manufacturing plant)	Y1
Lightning arrester	Y1532
Move control operators from the enclosure side to the door	Y45
Phase failure, phase reversal relay with time delay including under and over voltage protection	R44
Substitute standard trip melting alloy overload relays	Y61
Substitute quick-trip melting alloy overload relay (Sizes 1 and 2 only)—Not available on IEC style contactors	Y611
Substitution of Class R rejection fuse clips for standard fuse clip. (8940 RD, RE, RF, RG, MD, ME, MF, MG, SSC, SSD, SSE, SSF, SSG, WC, WD, WE and WF)	Y1071

**Table 16.258: Coil Voltage Codes**

Voltage		Code
60 Hz	50 Hz	
24 [9] [10]	—	V01
120 [9]	110 [9]	V02
208 [9]	—	V08
240	220	V03
—	380	V05
480	440	V06
600 [9]	550 [9]	V07
Specify	Specify	V99

**Table 16.259: Replacement Overload Relay for Square D Class 8940 Pump Panel with IEC Style Bimetallic Overload Relays Mounted on**

Ampere Range	Number of Poles	Form	Series	Type [11]
40–63 A	3	B12	B	9065TJF40
63–100 A	3	B12	B	9065TJF63
100–160 A	3	B12	B	9065TJF100
160–250 A	3	B12	B	9065TJF160

[9] Form S required for separate control.

[10] 24 V coils are not available on Size 4–7 starters. On Size 1–3 starters, 24 V coils are available using Form S.

[11] A retro-fit reset kit is required for pre-series B pump panels. See page 16-109 for selection.

[12] Coil voltage code must be supplied to order this product. See Table 16.258 for codes.

[13] Fuse clips are sized for use with dual-element time-delay fuses.

[14] To select a Motor Logic SSOLR with an FLA lower than the standard NEMA sizing, use the four-character Form H30•. See the section "Solid-State Overload Relay Forms."

[15] Motor Logic SSOLR are designed to protect 50/60 hertz three-phase AC motors from overload, phase unbalance and phase loss conditions. Open Delta systems or grounded B-phase systems are difficult to balance and could cause the Motor Logic SSOLR to trip. For applications of this nature, it is recommended that bi-metallic overload relays (Form B12) be used.

[16] Indicate pilot light color as Form P1 (red) or Form P2 (green). See page 16-117 for more selections.

[17] To determine the maximum number of auxiliary contacts which can be added to each Type S device and for the appropriate "X Form," refer to Table 16.85 (for non-reversing single-speed devices) or to Table 16.170 (for reversing or two-speed devices).

For How to Order Information, see page 16-28.

**Approximate Dimensions**

**NOTE:** These dimensions are for reference only. If you need precise measurements, contact the Customer Care Center at 1-888-778-2733.

**Table 16.262:**

Type	Fig.	A	B	C	D	E	F	G	H	J	K	L	M	Knockouts			V	
		in. mm	in. mm	in. mm	in. mm	in. mm	in. mm	in. mm	in. mm	in. mm	in. mm	Conduit	in. mm	R	S	T	in. mm	
NPD/E/F SSC SSD	1	39.05 992	13.73 349	6.67 169	9.70 246	33.05 839	37.93 963	7.00 178	2.41 61	3.00 76	3.00 76	2.5	2.41 61	0.5-0.75	1.25-1.5	0.5-0.75	1.41 36	
NPG/J SSE/F XSE/F	1	49.00 1245	19.15 486	8.81 224	10.37 263	44.07 1119	47.88 1216	7.00 178	2.17 55	2.69 68	3.44 87	2.5	2.57 65	0.5-0.75	1-1.25 1-2.5	1-1.25 1.5-2	1.41 36	
WC-S2 WD-S2 XC-S2 XD-S2	1	38.50 978	19.00 483	7.29 185	9.39 239	34.00 864	37.38 949	7.00 178	2.18 55	2.13 54	2.13 54	1.5	2.12 54	0.5-0.75	1-1.25 1.5	0.5-0.75	—	
WE-S2 WF-S2 XE-S2 XF-S2	1	56.50 1435	23.00 584	8.23 209	10.33 262	52.00 1321	55.38 1407	7.00 178	2.18 55	2.69 68	3.44 87	2	2.68 68	0.5-0.75	1-1.25 2-2.5	1-1.25 1.5-2	1.50 38	
SSG XSG	1	75.50 1892	22.00 559	13.80 351	17.55 446	73.00 1854	74.50 13	14.00 356	N/A	0.56 14	N/A	N/A	N/A	N/A	N/A	N/A	N/A	1.50 38
XSH	2	82.50 2096	36.00 914	20.00 508	23.25 591	80.00 2032	33.75 857	16.50 419	N/A	N/A	N/A	N/A	N/A	N/A	N/A	N/A	N/A	N/A
XSJ	2	92.50 2350	34.00 864	20.00 508	23.25 591	90.00 2286	31.75 806	16.50 419	N/A	N/A	N/A	N/A	N/A	N/A	N/A	N/A	N/A	N/A

**NOTE:** Illustrations may not represent the actual enclosure. They are intended for dimensional information only.

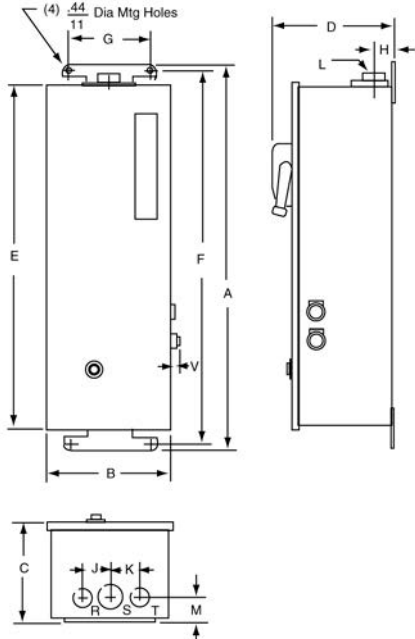

Figure 1

Dimensions: in.  
mm

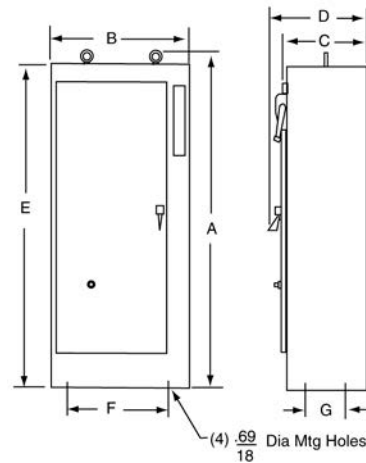

Figure 2



**Selection**

Duplex Motor Controllers are used to control two motors, and consist of two starters in a common enclosure. Two separate disconnect switches or circuit breakers with operators are included with all combination devices. Unless **Form Y68** is specified, an alternation circuit (a Class 8501 Type XO40 relay) is included, which alternately operates first one motor and then the other on each successive closing of a pilot device. Both motors will be energized should a second pilot device close. All devices incorporate a terminal block to simplify wiring of pilot devices A and B. Typical applications include pump motors where a second pump is required for peak demand periods yet alternation is desirable to equalize pump wear.

**Table 16.263: 3-Pole Polyphase—600 Vac Maximum (50–60 Hz) Non-Combination Type—Without Disconnect—With Electric Alternation (replace ●●● with the voltage code) (Devices require 6 thermal units. See Thermal Unit Selection, page 16-132.)**

NEMA Size	Maximum Rating Each Motor		NEMA 1 General Purpose Enclosure	NEMA 4/4X Watertight and Dusttight Enclosure Stainless Steel	NEMA 12 (NEMA 3 and 3R) [1] Dusttight and Driptight Industrial Use Enclosure	Open Type
	Voltage	Hp Polyphase	Type [2]	Type [2]	Type [2]	Type [2]
0	200–230	3	NBG10●●●	NBW10●●●	NBA10●●●	NBO10●●●
	460–575	5				
1	200–230	7.5	NCG20●●●	NCW20●●●	NCA20●●●	NCO20●●●
	460–575	10				
2	200	10	NDG30●●●	NDW30●●●	NDA30●●●	NDO30●●●
	230	15				
	460–575	25				
3	200	25	NEG40●●●	NEW40●●●	NEA40●●●	NEO40●●●
	230	30				
	460–575	50				
4	200	40	NFG50●●●	NFW50●●●	NFA50●●●	NFO50●●●
	230	50				
	460–575	100				

**Table 16.264: 3-Pole Polyphase—600 Vac Maximum (50–60 Hz) Combination Thermal Magnetic Circuit Breaker Type—With Electric Alternation (replace ●●● with the voltage code) (Devices require 6 thermal units. See Thermal Unit Selection, page 16-132.)**

Motor Starter Voltage	Max. Hp Polyphase	Coil Voltage	NEMA Size	Circuit Breaker		NEMA 1 General Purpose Enclosure	NEMA 4/4X Watertight and Dusttight Stainless Steel Enclosure	NEMA 12 (NEMA 3 and 3R) [1] Dusttight and Driptight Industrial Use Enclosure
				Frame Size	Ampere Rating	Type [2]	Type [2]	Type [2]
200 (208)	2	208–60	0	HLL36015	15	CBG06●●●	CBW06●●●	CBA06●●●
	3			HLL36020	20	CBG08●●●	CBW08●●●	CBA08●●●
	5		1	HLL36035	35	CCG12●●●	CCW12●●●	CCA12●●●
	7.5			HLL36050	50	CCG15●●●	CCW15●●●	CCA15●●●
	10		2	HLL36060	60	CDG22●●●	CDW22●●●	CDA22●●●
	15			3	HLL36100	100	CEG32●●●	CEW32●●●
	20		HLL36125		125	CEG36●●●	CEW36●●●	CEA36●●●
25	HLL36150	150	CEG38●●●		CEW38●●●	CEA38●●●		
30	4	JLL36200	200	CFG41●●●	CFW41●●●	CFA41●●●		
40		JLL36250	250	CFG44●●●	CFW44●●●	CFA44●●●		
230 (240)	2	240–60 220–50	0	HLL36015	15	CBG06●●●	CBW06●●●	CBA06●●●
	3			HLL36020	20	CBG08●●●	CBW08●●●	CBA08●●●
	5		1	HLL36035	35	CCG14●●●	CCW14●●●	CCA14●●●
	7.5			HLL36045	45	CCG16●●●	CCW16●●●	CCA16●●●
	10		2	HLL36060	60	CDG22●●●	CDW22●●●	CDA22●●●
	15			HLL36090	90	CDG24●●●	CDW24●●●	CDA24●●●
	25		3	HLL36150	150	CEG38●●●	CEW38●●●	CEA38●●●
30	4	JLL36225		225	CFG43●●●	CFW43●●●	CFA43●●●	
40		JLL36250	250	CFG44●●●	CFW44●●●	CFA44●●●		
460 (480)	5	480–60 440–50	0	HLL36015	15	CBG10●●●	CBW10●●●	CBA10●●●
	7.5			1	HLL36025	25	CCG18●●●	CCW18●●●
	10		HLL36030		30	CCG20●●●	CCW20●●●	CCA20●●●
	15		2	HLL36045	45	CDG26●●●	CDW26●●●	CDA26●●●
	20			HLL36060	60	CDG28●●●	CDW28●●●	CDA28●●●
	25		3	HLL36070	70	CDG30●●●	CDW30●●●	CDA30●●●
	30			HLL36080	80	CEG39●●●	CEW39●●●	CEA39●●●
50	4	HLL36150	150	CEG40●●●	CEW40●●●	CEA40●●●		
75		JLL36200	200	CFG45●●●	CFW45●●●	CFA45●●●		
100	JLL36250	250	CFG47●●●	CFW47●●●	CFA47●●●			

**NOTE:** For voltage codes used with control transformers, see page 16-118.  
For How to Order Information, see page 16-28.

[1] NEMA 12 enclosures can be field modified for outdoor applications. For details, refer to Class 9991 on page 16-112.  
[2] Replace the three bullets (●●●) in the catalog number with the coil voltage code. Refer to the standard voltage codes listed in Table 16.274.

**Table 16.265: 3-Pole Polyphase—600 Vac Maximum (50–60 Hz) Combination Disconnect Switch Type—With Electric Alternation (Devices require 6 thermal units. See Thermal Unit Selection, page 16-132.)**

Motor Voltage (Starter Voltage)	Max. Hp Poly-phase	Coil Voltage	NEMA Size	Fuse Clip Size (A) [3]	NEMA 1 General Purpose Enclosure	NEMA 4/4X Watertight and Dusttight Enclosure Stainless Steel	NEMA 12 (NEMA 3 and 3R) [4] Dusttight and Driptight Industrial Use Enclosure
					Type [5]	Type [5]	Type [5]
200 (208)	3	208-60	0	None 30	UBG10●●● DBG08●●●	UBW10●●● DBW08●●●	UBA10●●● DBA08●●●
	7.5		1	None 60	UCG20●●● DCG18●●●	UCW20●●● DCW18●●●	UCA20●●● DCA18●●●
	10		2	None 60	UDG30●●● DDG28●●●	UDW30●●● DDW28●●●	UDA30●●● DDA28●●●
230 (240)	3	240-60 220-50	0	None 30	UBG10●●● DBG08●●●	UBW10●●● DBW08●●●	UBA10●●● DBA08●●●
	7.5		1	None 60	UCG20●●● DCG18●●●	UCW20●●● DCW18●●●	UCA20●●● DCA18●●●
	15		2	None 60	UDG30●●● DDG28●●●	UDW30●●● DDW28●●●	UDA30●●● DDA28●●●
460 (480)	5	480-60 440-50 575 (600)	0	None 30	UBG10●●● DBG10●●●	UBW10●●● DBW10●●●	UBA10●●● DBA10●●●
	10		1	None 30	UCG20●●● DCG20●●●	UCW20●●● DCW20●●●	UCA20●●● DCA20●●●
	25		2	None 60	UDG30●●● DDG30●●●	UDW30●●● DDW30●●●	UDA30●●● DDA30●●●
	50		3	None 100	UEG40●●● DEG40●●●	UEW40●●● DEW40●●●	UEA40●●● DEA40●●●

**Factory Modifications (Forms)**

**Table 16.266: Factory Modifications (Forms)**

Description [6]	Enclosure Type	Form	NEMA Size			
			0-1	2	3	4
<b>Pilot Devices in Cover</b> [7] Start-Stop push buttons—one provided for each motor. (Form C or Form Y68 required.)	1, 4, 12	A	X	X	X	X
<b>Hand-Off-Auto selector switch</b> —one provided for each motor.	1, 4, 12	C	X	X	X	X
No. 1 Lead—No. 2 Lead selector switch for manual selection of lead pump. (Form Y68 required.)	Any	C13 P1	X X	X X	X X	X X
Red On pilot light—one provided for each motor.	1, 4, 12	P21	X	X	X	X
Push-to-test, red On pilot light—one provided for each motor. Non-standard markings for pilot devices. Test push button for each starter.	1, 4, 12 Any Any	G12 Y29	X X X	X X X	X X X	X X X
<b>Control Circuit Modifications</b> Fused control circuit without transformer	Any	F	X	X	X	X
One fuse	Any	F4	X	X	X	X
Two fuses	Any	F4T	X	X	X	X
Fused control circuit transformer, two fuses in primary, with 600, 480, 240 or 208 V primary and 120 V secondary—one provided for each starter.	Any	FF4T	X	X	X	X
Fused control circuit transformer, two fuses in primary, one fuse in secondary—one provided for each starter.	Any	FF4T11	X	X	X	X
100 VA additional capacity	Any	FF4T12	X	X	X	X
200 VA additional capacity	Any	FF4T12	X	X	X	X
Extra capacity control circuit transformer—two fuses in primary—one provided for each starter (see Table 16.267)	Any	F4T11	X	X	X	X
100 VA additional capacity	Any	F4T12	X	X	X	X
200 VA additional capacity	Any	G97	X	X	X	X
Elapsed time meter for each starter	Any	G97	X	X	X	X
Pressure switch for each starter (Square D pressure switch 9012GAW25)	Any	D	X	X	X	X
Addition of 2 relays to modify controller for operation with single pole pilot devices	Any	R7	X	X	X	X
Addition of 3 relays to modify controller for operation with single pole mercury float switches	Any	R8	X	X	X	X
Control circuit wired for separate 120 V source	Any	S	X	X	X	X
Addition of 1 N.O. unwired interlock per starter for use by customer (1 N.O. unwired interlock per starter is provided as standard.)	Any	X10	X	X	X	X
Addition of 1 N.C. unwired interlock per starter for customer use	Any	X01	X	X	X	X
Modified wiring for use with double pole mercury float switches	Any	Y24	X	X	X	X
<b>Deduct</b> for omission of electrical alternating circuit	Any	Y68	X	X	X	X
Additional Control circuit terminals—per wired terminal (5 point terminal block is standard)	Any	G56[10]	X	X	X	X
Unwired	Any	G50[10]	X	X	X	X

**Table 16.267: Capacity**

NEMA Size	Standard Capacity (Form F4T)	100 VA Additional Capacity (Form F4T11)	200 VA Additional Capacity (Form F4T12)
	Class 9070 Type	Class 9070 Type	Class 9070 Type
0, 1	TF100	TF200	TF300
2	TF100	TF200	TF300
3	TF150	TF300	TF500
4	TF300	TF500	TF500

For How to Order Information, see page 16-28.

[3] The hp rating applies only when dual element time delay fuses are used.

[4] NEMA 12 enclosures can be field modified for outdoor applications. For details, refer to Class 9991 on page 16-112.

[5] Replace the three bullets (●●●) in the catalog number with the coil voltage code. Refer to the standard voltage codes listed in Table 16.274.

[6] These Forms are most commonly used. Other Forms may be available. Consult the Customer Care Center at 1-888-778-2733 for additional information.

[7] Not available on open style devices.

[8] Single primary voltage must be specified.

[9] Not available on this size. Use Form FF4T●●.

[10] Addition of terminal block 9080CA or 9080GR6 only. A 5-point terminal block is provided as standard for custom connection. A wiring diagram must be provided for factory wiring.

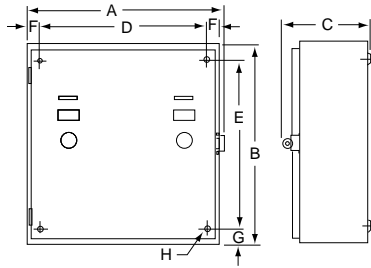

Figure 16.27: NEMA 1 Enclosure—Non-Combination

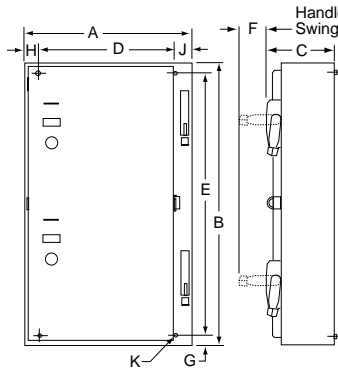

Figure 16.28: NEMA 1 Enclosure—Combination

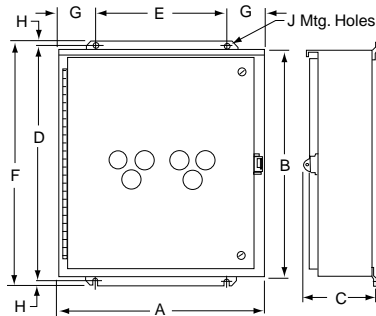

Figure 16.29: NEMA 4 and 12/3R Enclosure—Non-Combination

Table 16.274: Coil Voltage Codes

Voltage		Code
60 Hz	50 Hz	
24 [11]	—	V01
120 [12]	110	V02
208	—	V08
240	220	V03
—	380	V05
480	440	V06
600	550	V07
Specify	Specify	V99

Approximate Dimensions (in.)

NOTE: These dimensions are for reference only. If you need precise measurements, contact the Customer Care Center at 1-888-778-2733.

Table 16.268: NEMA 1 Enclosure—Non-Combination (Figure 1)

Starter Size	A	B	C	D	E	F	G	H
0, 1, or 2	20.5	24.13	8.69	17.88	21.5	1.31	1.31	0.31 Dia.
3 or 4	22.13	34	9.75	16	35.5	3.06	0.75	0.44 Dia.

Table 16.269: NEMA 1 Enclosure—Combination (Figure 2)

Starter Size	A	B	C	D	E	F	G	H	J	K
0, 1, or 2 (For Circuit Breaker and 30 A & 60 A Disconnect Switch)	20.38	35	9.63	17	32.5	3.31	1.25	1.25	1.25	0.44 Dia.
3 or 4 (For Circuit Breaker and 100 A Disconnect Switch)	32	44	10.75	24	46	4.88	1	2.5	2.5	0.56 Dia.

Table 16.270: NEMA 4 Enclosure—Non-Combination (Figure 3)

Starter Size	A	B	C	D	E	F	G	H	J
0, 1, or 2	20.5	24	8	25	15.38	26	2.56	0.5	0.31
3 or 4	22	34	9.13	35	17	36	2.5	0.5	0.56

Table 16.271: NEMA 4 Enclosure—Combination (Figure 4)

Starter Size	A	B	C	D	E	F	G	H	J	K
0, 1, or 2 (For Circuit Breaker and 30 A & 60 A Disconnect Switch)	20.5	35	9.56	36	15.38	37	2.56	0.5	0.31	3.31
3 or 4 (For Circuit Breaker and 100 A Disconnect Switch)	32	44	10.69	46	26	47	3	0.5	0.56	4.88

Table 16.272: NEMA 12/3R Enclosure—Non-Combination (Figure 3)

Starter Size	A	B	C	D	E	F	G	H	J
0, 1, or 2	20.5	24.25	8	25.5	14.38	26.5	3.06	0.5	0.44
3 or 4	22	34	9.13	35.5	16	36.5	3	0.5	0.44

Table 16.273: NEMA 12/3R Enclosure—Combination (Figure 4)

Starter Size	A	B	C	D	E	F	G	H	J	K
0, 1, or 2 (For Circuit Breaker and 30 A & 60 A Disconnect Switch)	20.5	35	9.56	36.5	14.38	37.5	3	0.5	0.44	3.31
3 or 4 (For Circuit Breaker and 100 A Disconnect Switch)	32.25	44.25	10.69	46	24	47	4.13	0.5	0.56	4.88

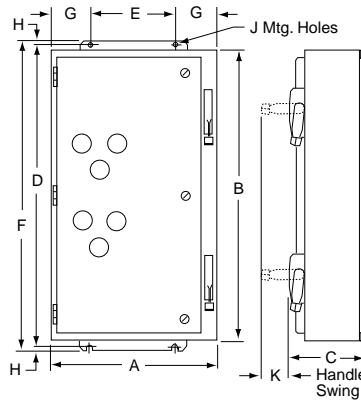

Figure 16.30: NEMA 4 and 12/3R Enclosure—Combination

NOTE: Illustrations may not represent the actual enclosure; they are intended for dimensional information only. Dimensions are in inches.

[11] 24 V coil is not available on Size 4. On Sizes 00–3, specify Form S (separate control).

[12] These voltage codes must include Form S (no additional charge).





8965DPR33V02 Hoist Contactor  
600 Vac, 25 A  
DPR, Angled

Class 8965 Type DPR reversing/hoist contactors are designed for the control of motors in hoists, overhead doors, small elevators, commercial laundry equipment, and other related products which use reversing motors. They are rated to perform in the short periods of jogging experienced in hoist service.

The coils are designed to operate on line voltages of 85–110% of rated voltage, and are for applications at 50 or 60 Hz only. Coils are easily replaced with external base removed.

Auxiliary contacts can easily be fieldadded to any Class 8965 reversing contactor. Type DPR contactors accept one auxiliary contact module with up to two isolated circuits per side (two modules per device). When auxiliary contacts are ordered separately, two modules are normally used for each device; one for forward, one for reverse.

**Table 16.275: Reversing/Hoist Contactors—600 Vac Maximum**  
(replace ●●● with the voltage code)

No. of Poles	Horsepower Ratings [1]				Open Type
	115 V 1Ø	230 V 1Ø	230 V 3Ø	460/575 V 3Ø	Type [2]
3-Pole Polyphase	1	2	5	7-1/2	DPR13●●●
	2	3	7-1/2	10	DPR23●●●
	2	5	10	15	DPR33●●●
	3	7-1/2	15	20	DPR43●●●
4-Pole Polyphase	1	2	5	7-1/2	DPR14●●●
	2	3	7-1/2	10	DPR24●●●
	2	5	10	15	DPR34●●●
	3	7-1/2	10	20	DPR44●●●

**Table 16.276: Auxiliary Contacts Separate Module**

Description	Class 9999 Type
1 N.O.	D10
1 N.C.	D01
1 N.O.–1 N.C.	D11
2 N.O.	D20

**Table 16.278: Coil Voltage Codes**

Volts, 60 Hz	Volts, 50 Hz	Voltage Code
24	24	V14
120	110	V02
208–240	220	V09
277	—	V04
480	440	V06
600	550	V07

**Table 16.277: Factory Installed**

Description	Form
1 N.O. Each Side	X1010
1 N.C. Each Side	X0101
1 N.O.–1 N.C. Each Side	X1111
2 N.O. Each Side	X2020

**Table 16.279: Approvals**

UL Component Recognized—File E42240, CCN NLDX  
CSA Certified—File LR25490, Class 3211 04

**Approximate Dimensions**

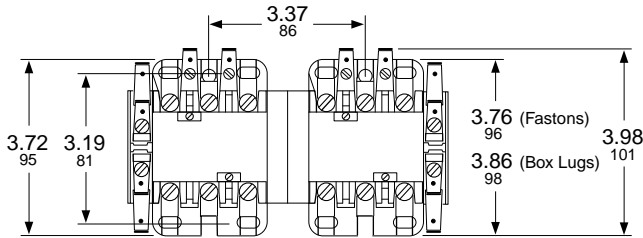

Type DPR13 through DPR43

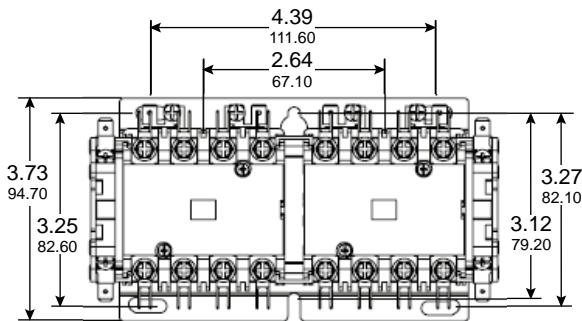
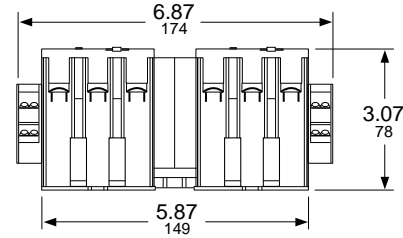

Type DPR14 through DPR44

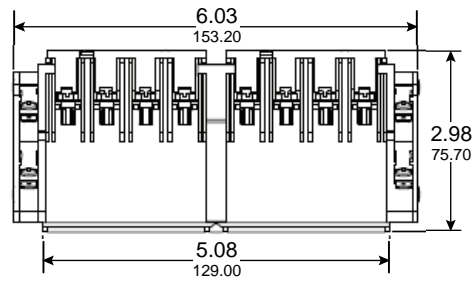

[1] For rapid operation (jogging duty), use the next larger size contactor.  
[2] Replace the three bullets (●●●) in the catalog number with the coil voltage code. Refer to the standard voltage codes listed in Table 16.278.  
[3] Order two modules for Type DPR, one for each side.



Type SEO5

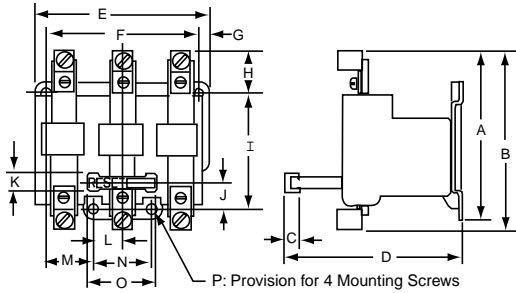

Type SEO Dimensions

### Melting Alloy Overload Relay Selection

NEMA style thermal overload relays feature:

- Exclusive one-piece thermal unit
- Inverse time delay trip
- Trip free reset mechanism
- Replaceable contact units

Note that these overload relays do not include thermal units, which must be ordered and field installed separately. Slow trip (Class 30) and quick trip (Class 10) melting alloy thermal units are available for all Size 1, 2, 5 and 6, and some Size 3 and 4 applications.

**Table 16.280: For Separate Mounting—Melting Alloy—600 V Maximum, AC or DC<sup>[1]</sup>**

NEMA Size	Maximum Full Load Current (A)	Open Type for Separate Panel Mounting Left and Right Hand Types	Open Type Relay and Bracket Kit for Terminal Block Channel Mounting
			Type
Three Pole Construction (One Common N.C. Contact on Type S Only)—3 Thermal Units Required			
00-1	25	9065SEO5	9065SM2
2	45	9065SEO8	9065SM2
3	86	9065SEO12	—
4	133	9065SEO15	—

**Table 16.281: Replacement Melting Alloy Overload Relays for Square D Class 8536 Starters**

Locate Class 8536 Starter in this Column				Order Class 9065 Overload Relay from this Column	
NEMA Size	Type	Series	Number of Poles	Type	Number of Thermal Units Required
00	SA	A & B	2	9065SDO4	1
			3	9065SDO5	3
0	SB	A	2	9065SDO4	1
			3-5	9065SDO5	3 [2]
1	SC	A	2	9065SDO4	1
			3-5	9065SDO5	3 [2]
1P	SC	A	2	9065SDO10	1
2	SD	A	2	9065SDO7	1
			3-5	9065SDO8	3 [2]
3	SE	A	2	9065SDO11	1
			3	9065SDO12	3
			4	9065SDO13	2
			5	9065SDO14	3
4	SF	A	3	9065SDO15	3
			4	9065SDO16	2
			5	9065SDO17	3
5	SG	A	3	Form Y500 and Series B, use 9065SEO5	3
6	SH	A & B	3	9065SEO5	3

**Table 16.282: Special Features for Melting Alloy Overload Relays**

Description	Form
Substitute 1-N.O. isolated alarm contact and 1-N.C. contact per relay. (Type S starters only) [3]	Y342
Substitute 2-N.C. contacts for standard N.C. contact per relay. (Type S starters only) [3]	Y344
Modify Type SDO12 relays to accept Type FB quick trip or SB slow trip thermal units. (Rejects Type CC standard trip units) [4]	Y81

**Table 16.283: Approximate Dimensions, NEMA Style Melting Alloy Overload Relays**

Type	Dimensions (in.)																Shipping Weight (lb)
	A	B	C	D	E	F	G	H	I	J	K	L	M	N	O	P	
SEO5	3.31	—	0.47	3.97	3.53	2.81	0.22	0.69	2.31	0.5	0.5	0.5	0.84	1	1.38	#10	1
SEO8	3.31	—	0.47	3.97	3.5	2.81	0.19	0.69	2.31	0.5	0.5	0.13	0.84	1	1.38	#10	1.25
SEO12	—	5.59	0.56	5.75	5.31	4.75	0.28	1.44	3.56	0.75	0.56	0.88	1.5	1.75	2	#1/4	3
SEO15	—	6.97	0.56	5.75	5.31	4.75	0.28	2.13	3.56	0.75	0.56	0.88	1.5	1.75	2	#1/4	4

**NOTE:** These dimensions are for reference only. If you need precise measurements, contact the Customer Care Center at 1-888-778-2733.

[1] The maximum power circuit rating for Type S separate-mounting overload relays is 600 Vac only. The maximum control circuit contact rating for Type S versions is 600 Vac only.  
 [2] For 4-pole starters used on two-phase systems, order two thermal units plus one Class 9998 Type SO31 jumper strap kit for every two starters. Each kit includes two jumper straps.  
 [3] Field modification possible. Order 9999S04 (for Form Y342) or 9999S05 (for Form Y344).  
 [4] This Form cannot be field modified.



**Motor Logic Solid-State Overload Relays**

Motor Logic solid-state overload relays (SSOLRs) feature: 3 to 1 adjustment for trip current; phase loss and unbalance protection; direct replacement for Type S melting alloy. They are ambient insensitive and self-powered. Switch selectable trip class; Class II ground fault detection; and direct replacement for Type S melting alloy. Electrical remote reset is also available.

**NOTE:** Motor Logic SSOLRs are designed to protect 50/60 Hz, three-phase AC motors from overload, phase unbalance, and phase loss conditions. Open Delta systems or grounded B-phase systems are difficult to balance and could cause the Motor Logic SSOLR to trip.

**Table 16.284: Class 10/20 (Selectable): For Separate Mounting Solid-State Overload Relay, 600 Vac Maximum**

NEMA Size <sup>[5]</sup> (3-Pole)	Full Load Current Range (A)	Open Type
		Trip Class 10/20
00B	1.5–4.5 <sup>[6]</sup>	SFB20
00C	3–9 <sup>[6]</sup>	SFC20
0	6–18 <sup>[6]</sup>	SF020
1	9–27 <sup>[6]</sup>	SF120
2	15–45	SF220
3	30–90	SF320
4	45–135	SF420

**Table 16.285: Class 10/20 (Selectable): Replacement SSOLR for Retrofit of Square D Type S Starter Solid-State Overload Relay 600 Vac Maximum**

Locate 8536 Starter in this column		Order Class 9065 Overload Relay from this column
NEMA Size <sup>[5]</sup>	Full Load Current Range (A)	Open Type
		Trip Class 10/20
00B <sup>[6]</sup>	1.5–4.5	SFB20
00C <sup>[6]</sup>	3–9	SFC20
0 <sup>[6]</sup>	6–18	SF020
1 <sup>[6]</sup>	9–27	SF120
2	15–45	ST220
3	30–90	ST320
4	45–135	ST420
5 <sup>[7]</sup>	90–270	ST520
5 <sup>[8]</sup>	90–270	SF520
6 <sup>[7]</sup>	180–540	ST620
7 <sup>[7]</sup>	270–810	ST720

<sup>[5]</sup> Size 00B and 00C are not actual NEMA sizes. These designations are used to differentiate the lower FLA of these devices from the NEMA Size 00 Motor Logic solid-state overload relay.  
<sup>[6]</sup> Size 00B, 00C, 0, and 1 come without lugs. Lower amperage loads can be protected by looping the power wires. Lugs are available. See Table 16.358.  
<sup>[7]</sup> Size 5, 6, and 7 replacement overload relays are only for existing NEMA style Type S starters with a Motor Logic overload relay. External CTs and additional components are not included.  
<sup>[8]</sup> Size 5 is a complete drop-in replacement for Square D Type S melting alloy, bimetallic, and Y500 overload relays only.

Approximate Dimensions

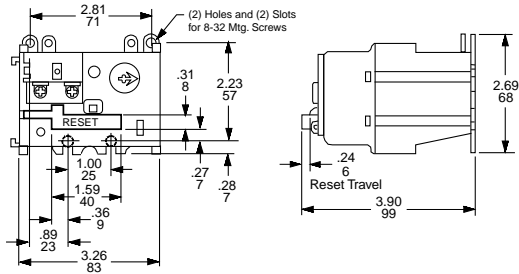

NEMA Size 00B, 00C, 0, and 1 Devices

**NOTE:** Sizes 00B and 00C are not actual NEMA sizes. These designations are used to differentiate the lower FLA of these devices from the NEMA Size 00 Motor Logic solid-state overload relay.

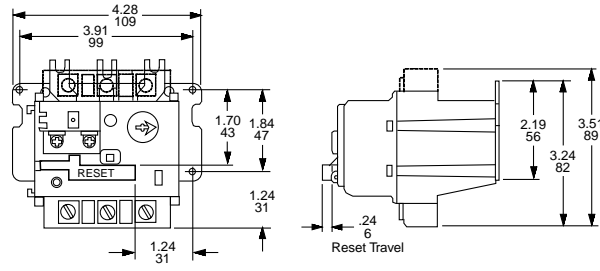

Size 2 Devices

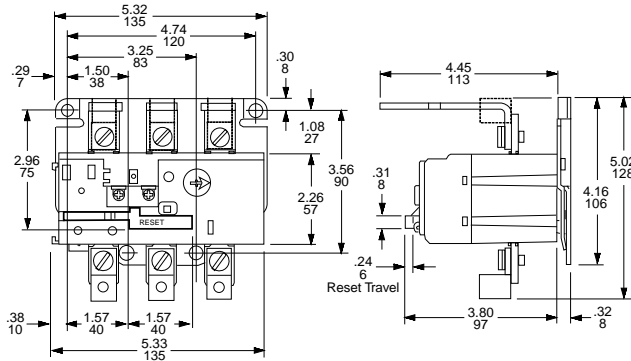

Size 3 Devices

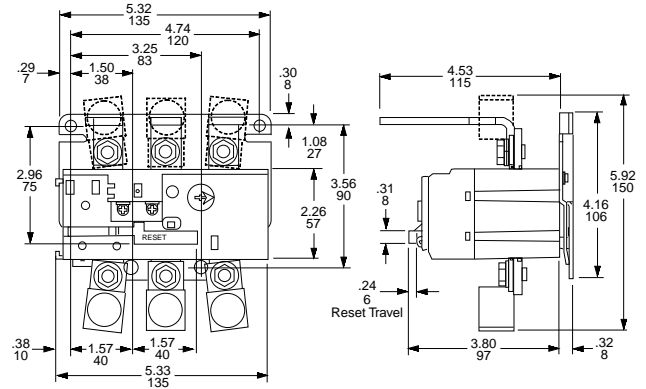

Size 4 Devices

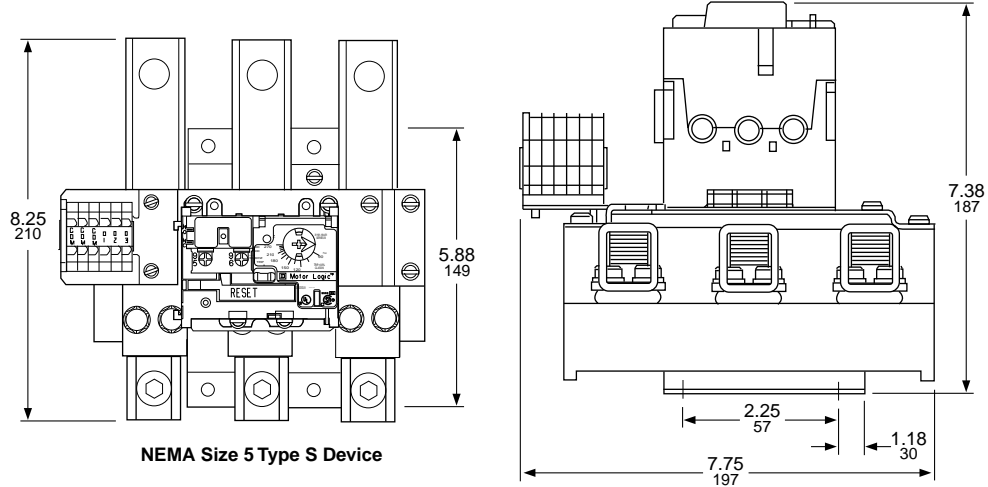

NEMA Size 5 Type S Device

**Note:** The dimensions are for reference only.

16 NEMA AND DEFINITE PURPOSE CONTACTORS AND STARTERS

*New!*

**Introduction**

TeSys T is a motor management system that provides full motor monitoring, control, and protection when used with short circuit protection and a contactor. TeSys T manages most critical processes while reducing downtime and increasing productivity.

TeSys T is a flexible system that integrates seamlessly into your automation system through five major communication protocols. TeSys T predicts what will happen in the process, as it accurately monitors current, voltage, and power over a wide range.

TeSys T is a green motor management system with unique power monitoring capabilities for better energy management. TeSys T carries all appropriate and necessary third party certifications.

To get detailed information about TeSys T, visit our website at [www.schneider-electric.us.com](http://www.schneider-electric.us.com).

**TeSys T detailed functionalities and possible configuration:**

**Communication:**

TeSys T is a flexible motor management system that supports six major communication protocols: Modbus™, CANopen, DeviceNet™, Profibus™, Ethernet/IP, and Modbus/TCP.

These communication protocols allow the TeSys T controller to integrate seamlessly into your automation systems.

Ethernet/IP and Modbus/TCP provide FDR to enable quick replacement of products and minimize maintenance time.

**Protection functions:**

- thermal overload
- phase imbalance and phase failure
- thermal motor protection via PTC probes
- phase reversal
- ground fault detection
- long starting times and motor stalling
- automatic load shedding and restarting
- load fluctuations (current, voltage, power)
- variations of Cos j (power factor)

**Metering functions:**

- Measurements (rms values):
  - current on the 3 phases
  - voltage on the 3 phases (shedding)
  - motor temperature
  - ground fault sensing
- Values calculated:
  - average current
  - frequency
  - Power factor, power, power consumption

**Motor control functions:**

A motor managed by a TeSys T controller can be controlled:

- locally, using the logic inputs present on the product, or via the human machine interface (HMI)
- remotely, via the network

**Motor control modes:**

- 10 predefined motor control modes are incorporated in the controller. Each listed mode is available as 2 or 3 wire control.
- overload mode: monitoring of motors whose control is not managed by the controller
  - independent mode: starting of full voltage non-reversing motors
  - reverser mode: starting of full voltage reversing motors
  - 2-step mode: 2-step starting of motors (star-delta, by autotransformer and by resistor)
  - 2-speed mode: 2-speed starting of motors (Dahlander, pole changer)

A custom mode is available to allow the user to create a specific motor control mode that is not predefined in the controller.

Custom Logic has the basic functions of a small programmable logic controller (PLC). Programming can be done in Structured Text mode or in Block Diagrams through SoMove V2.2 software. To ensure consistency, the same software used to commission the TeSys T controller is used for Custom Logic programming.

**Statistical and diagnostic functions:**

- history of the last five detected faults
- motor statistics
- controller operations
- warning of pending faults

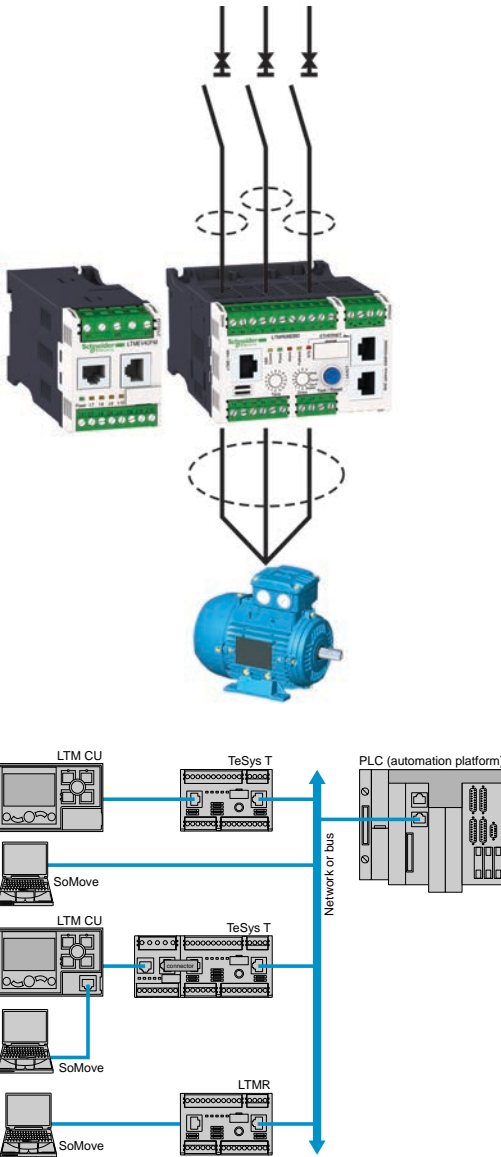

**Table 16.286: Standards and Certifications**

Product Type	LTMR Controllers	LTMEV40 Expansion Modules
Conforming to standards	IEC/EN 60947-4-1, UL 508, UL E164353 NKCR, CSA 22-2 n°14, CSA LR43364 Class 3211 03, IACS E10	
Product certifications	UL, CSA, BV, LROS, DNV, GL, RINA, ABS, RMRos, NOM, CCC, C-TiCk, ATEX, GOST, KERI	

**Possible Configurations:**

TeSys T controller is a flexible motor management system using SoMove V2.2 commissioning tool. PowerSuite is the configuration software for the TeSys T controllers. See [page 16-106](#) for details.

TeSys T is a motor management system that provides full motor monitoring, control, and protection when used with short circuit protection and a contactor. TeSys T manages most critical processes while reducing downtime and increasing productivity.

TeSys T is a flexible system that integrates seamlessly into your automation system through five major communication protocols. TeSys T predicts what will happen in the process, as it accurately monitors current, voltage, and power over a wide range.

TeSys T is a green motor management system with unique power monitoring capabilities for better energy management.

TeSys T carries all appropriate and necessary third party certifications.

To get detailed information about TeSys T, visit our website at [www.schneider-electric.us.com](http://www.schneider-electric.us.com).

New!

## LTMR Controller



LTMR27EBD

The controller is the central component in the motor management system. It manages the basic functions such as:

- measurement of 3-phase current via integral current transformers from 0.4 to 100 A (up to 810 A by external current transformers)
- measurement of ground current internally or external ground sensors
- measurement of motor temperature
- inputs and outputs for the various motor control modes, detected fault management, and other functions

### Characteristics

As standard, the controller manages the following:

### Control Modes

- overload mode
  - independent mode
  - reverser mode
  - 2-speed mode
  - 2-step mode
  - Custom mode
- ### Inputs/Outputs
- 6 discrete logic inputs
  - 3 relay logic outputs (1 N.O. contact each)
  - 1 relay output for detected fault signaling (1 N.O. + 1 N.C.) overload relay

### Measurements

- connection for a thermistor probe
- connections for a ground sensor

Table 16.287: Controllers

Setting Range (A)	Control Voltage (V)	Current Range (A)	Catalog Number
<b>Modbus™ Protocol</b>			
8	24 Vdc	0.4–8	<a href="#">LTMR08MBD</a>
	100–240 Vac	0.4–8	<a href="#">LTMR08MFM</a>
27	24 Vdc	1.35–27	<a href="#">LTMR27MBD</a>
	100–240 Vac	1.35–27	<a href="#">LTMR27MFM</a>
100	24 Vdc	5–100	<a href="#">LTMR100MBD</a>
	100–240 Vac	5–100	<a href="#">LTMR100MFM</a>
<b>Ethernet TCP/IP Communication (Protocols: Ethernet/IP and Modbus/TCP)</b>			
8	24 Vdc	0.4–8	<a href="#">LTMR08EBD</a>
	100–240 Vac	0.4–8	<a href="#">LTMR08EFM</a>
27	24 Vdc	1.35–27	<a href="#">LTMR27EBD</a>
	100–240 Vac	1.35–27	<a href="#">LTMR27EFM</a>
100	24 Vdc	5–100	<a href="#">LTMR100EBD</a>
	100–240 Vac	5–100	<a href="#">LTMR100EFM</a>
<b>CANopen Protocol</b>			
8	24 Vdc	0.4–8	<a href="#">LTMR08CBD</a>
	100–240 Vac	0.4–8	<a href="#">LTMR08CFM</a>
27	24 Vdc	1.35–27	<a href="#">LTMR27CBD</a>
	100–240 Vac	1.35–27	<a href="#">LTMR27CFM</a>
100	24 Vdc	5–100	<a href="#">LTMR100CBD</a>
	100–240 Vac	5–100	<a href="#">LTMR100CFM</a>
<b>DeviceNet™ Protocol</b>			
8	24 Vdc	0.4–8	<a href="#">LTMR08DBD</a>
	100–240 Vac	0.4–8	<a href="#">LTMR08DFM</a>
27	24 Vdc	1.35–27	<a href="#">LTMR27DBD</a>
	100–240 Vac	1.35–27	<a href="#">LTMR27DFM</a>
100	24 Vdc	5–100	<a href="#">LTMR100DBD</a>
	100–240 Vac	5–100	<a href="#">LTMR100DFM</a>
<b>Profibus™ DP Protocol</b>			
8	24 Vdc	0.4–8	<a href="#">LTMR08PBD</a>
	100–240 Vac	0.4–8	<a href="#">LTMR08PFM</a>
27	24 Vdc	1.35–27	<a href="#">LTMR27PBD</a>
	100–240 Vac	1.35–27	<a href="#">LTMR27PFM</a>
100	24 Vdc	5–100	<a href="#">LTMR100PBD</a>
	100–240 Vac	5–100	<a href="#">LTMR100PFM</a>



## Components



LTMEV40FM

Table 16.288: Expansion Module

Input Control Voltage	Number of Inputs	Supply to the Electronics	Catalog Number
24 Vdc	4	via the LTMR controller	LTMEV40BD
100–240 Vac	4		LTMEV40FM



LTM9KCU  
(Holder Only)



LTMTCU



Magelis Display

Table 16.289: HMI Modules and Software

Description	Supply Voltage	Catalog Number
Operator Control unit	via the LTMR controller	LTMTCU
Holder for LTMTCU (with magnetic back)	—	LTM9KCU
Magelis compact display	24 Vdc	XBTN410
Configuration software Windows 99, 2000, XP	—	VJDSNDTMSV13M

### LTME Expansion Module

The expansion module adds the following functionalities to the TeSys T controller:

- voltage measurement between phases up to 690 V nominal
- 4 additional inputs

#### Inputs

- 4 discrete logic inputs (isolated)
- 2 types of power for the inputs: 24 Vdc and 100 to 240 Vac
- A 24 Vdc LTMR controller can be assembled with a 240 Vac expansion module and vice versa

The LTMVE must be connected to the LTMR controller by a connecting cable.

### HMI—Human Machine Interface

Depending on the application, two types of HMI can be used with the motor management system.

- The LTMTCU operator control unit:
  - Control/monitoring of a 1 to 1 LTMR controller
- A Magelis XBTN410 terminal
  - Control/monitoring of 1 to 8 LTMR controllers

### LTMTCU Compact Display

- Configure the parameters
- Display information
- Monitor the alarms and detected faults
- Local control of the motor via the local control interface (keys can be customized)
- Three different languages can be loaded into the LTMTCU controller at the same time: English, French, Spanish are the defaults.

A language download utility (LangTool), together with all the other languages, are available on the website [www.schneider-electric.com](http://www.schneider-electric.com).

This tool allows the languages present in the LTMTCU control until to be adapted.

The LTMTCU HMI control unit has an additional front panel RJ45 port, protected by a flexible cover.

### Magelis™ Display

Two applications have been predefined for the TeSys T controller. Depending on the application loaded, the HMI terminal makes it possible to:

- Configure and monitor a motor starter (LTM\_1T1\_V1.dop)
- Monitor and modify certain parameters up to 8 motor starters (LTM\_1T8\_X\_V1.dop)

Vijeo Designer programming software is needed for loading applications into the XBT HMI terminal.

New!

Components

Table 16.290: Current Transformers

Current Transformer Ratio [1]	Catalog Number
100:1	LT6CT1001
200:1	LT6CT2001
400:1	LT6CT4001
800:1	LT6CT8001

Table 16.291: Ground Fault Sensors

Rated Operational Current Ie (A)	Internal Toroid Ø (mm)	Catalog Number
<b>Closed Toroids, Type A</b>		
65	30	50437
85	50	50438
160	80	50439
250	120	50440
400	200	50441
630	300	50442
<b>Split Toroids, Type QA</b>		
85	46	50485
250	110	50486

NOTE: Dimensional drawings are in catalog DIA1ED2061002EN-US.

Table 16.292: PTC Thermistor Probes [2]

Description	Nominal Operating Temperature (NOT) °C	Color	Catalog Number [3]
Triple Probes	90	Green/green	DA1TT090
	110	Brown/brown	DA1TT110
	120	Gray/gray	DA1TT120
	130	Blue/blue	DA1TT130
	140	White/blue	DA1TT140
	150	Black/black	DA1TT150
	160	Blue/red	DA1TT160
	170	White/green	DA1TT170

Configuration with SoMove Software

The TeSys T configurator is incorporated in the SoMove software application, versions 2.2 and higher.

SoMove software allows configuration, commissioning and maintenance of motor starters protected by a TeSys T controller.

A library containing predefined motor control mode functions is available in order to:

- allow standardization
- avoid errors
- reduce motor starter setup times

By using logic functions, a custom mode makes it possible to:

- easily adapt these predefined motor control mode functions to the specific needs of your applications
- create new functions

The functions thus defined can be saved and used to build your function library for future applications.

To create special functions, a logic editor is incorporated in the configurator and allows a choice of 2 programming languages:

- function block
- structured text

Table 16.293: Configuration Tools

Description	Composition	Catalog Number
Connection kit for PC serial port for Modbus™ PLC multidrop connection	1 x 3 m length cable with two RJ45 connectors	VW3A8106
	1 RS232/RS485 converter with one 9-pin female SUB-D connector and one RJ45 connector.	
USB serial port adapter [4] for connecting a TeSys T controller to your PC	1 USB / serial port adapter [4]	TSXCUSB485
USB serial port cable for connecting a TeSys T controller to your PC	1 USB / serial port cable	TCSMCNAM3M002P

TeSys T and SMS PowerLogic:

TeSys T is integrated in PowerLogic SMS Version 4.0. and will address energy management needs by fully utilizing the TeSys T power/energy management features. For more information on PowerLogic products, see Power Monitor Control Section 4.

16 NEMA AND DEFINITE PURPOSE CONTACTORS AND STARTERS



LT6CT4001



DA1TT●●

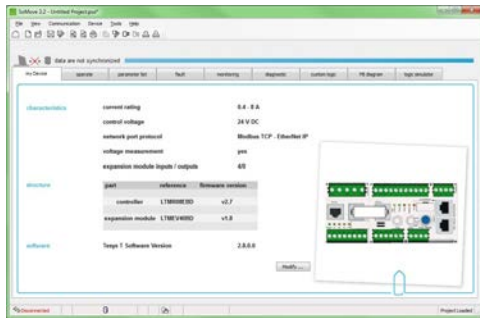

[1] For use with LTMR08●● controllers. Three current transformers are required for 3-phase applications.  
 [2] PTC: Positive Temperature Coefficient.  
 [3] Sold in lots of 10.  
 [4] Modbus RS-485 cable required, not included.



New!

## Accessories

Table 16.294: Connection Accessories

Description	Length m (ft)	Catalog Number	
<b>For Ethernet TCP/IP connection</b>			
Shielded twisted pair cables, UL and CA 22.1 approved			
Cables fitted with 2 x RJ45 connectors for connection to terminal equipment	Straight	2 (7)	490NTW00002U
		5 (16)	490NTW00005U
		12 (39)	490NTW00012U
		40 (131)	490NTW00040U
		80 (263)	490NTW00080U
<b>For Modbus PLC connection</b>			
Cables fitted with 2 x RJ45 connectors	0.3 (1)	VW3A8306R03	
	1 (3)	VW3A8306R10	
	3 (10)	VW3A8306R30	
T-junctions	0.3 (1)	VW3A8306TF03	
	1 (3)	VW3A8306TF10	
RS485 line terminator	—	VW3A8306R	
<b>For CANopen connection</b>			
Cables	50 (164)	TSXCANCA50	
	100 (328)	TSXCANCA100	
	300 (984)	TSXCANCA300	
IP20 connectors SUB-D 9-pin female Line end adapter switch	Elbowed (90°)	—	TSXCANKCDF90T
	Straight	—	TSXCANKCDF180T
	Elbowed (90°) SUB-D 9-pin connector for connection to PC or diagnostic tool	—	TSXCANKCDF90TP
	—	—	—
<b>For DeviceNet connection</b>			
Cables	50 (164)	TSXCANCA50	
	100 (328)	TSXCANCA100	
	300 (984)	TSXCANCA300	
<b>For Profibus DP connection</b>			
Cables	100 (328)	TSXPBSCA100	
	400 (1313)	TSXPBSCA400	
Connectors	With line terminator	—	490NAD91103
	Without line terminator	—	490NAD91104
	With line terminator and terminal port	—	490NAD91105



8536SCO3V02H626

Table 16.295: Connecting Cables

Description	Number and type of connectors	Length m (ft)	Catalog Number
LTMCU control unit	2 x RJ45	1 (3)	VW3A1104R10
		3 (10)	VW3A1104R30
		5 (16)	VW3A1104R50
XBTN410	SUB-D 25-pin female to RJ45	2.5 (8)	XBTZ938
LTME expansion module	2 x RJ45	0.04 (0.13)	LTMCC004
		0.3 (1)	LU9R03
		1 (3)	LU9R10
180 degree Ethernet external connector	1 x RJ45	—	LTM9CE180T

Table 16.296: Marking Accessories

Description	Composition	Sold in lots of	Catalog Number
Clip-in markers (maximum of 5 per unit)	Strips of 10 identical numbers (0 to 9)	25	AB1R• [5]
	Strips of 10 identical capital letters (A to Z)	25	AB1G• [5]

[5] When ordering, replace the • in the catalog number with the number or letter required.

Dimensions (mm)

Table 16.297: LTMR\*\* controllers

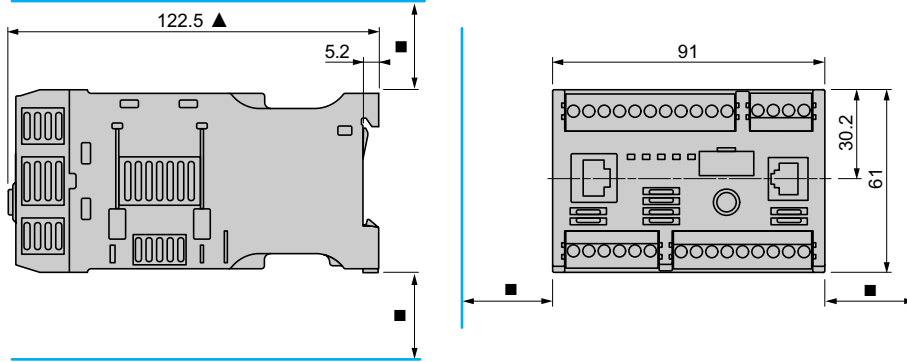
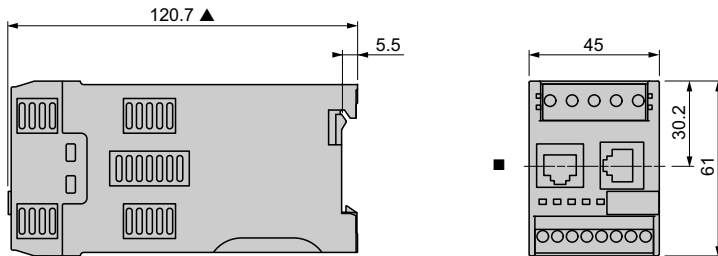
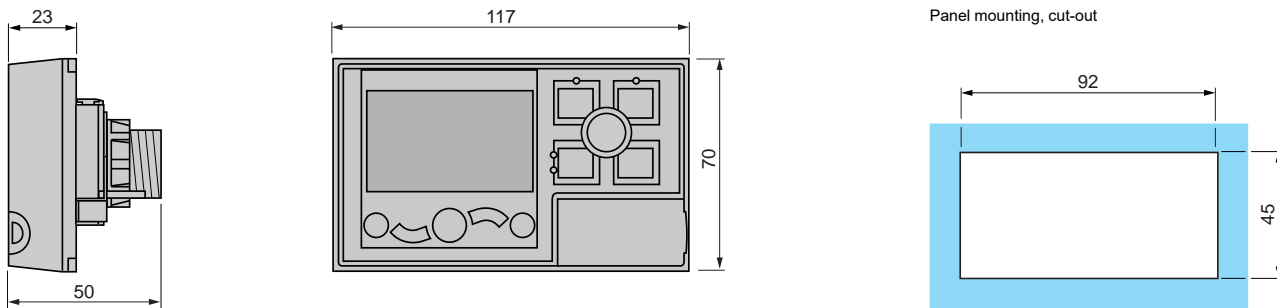

Table 16.298: LTMEV40\*\* expansion modules



- Leave a gap around the device of: 9 mm at 45 °C, 9–40 mm from 45–50 °C, 40 mm at 60 °C.
- ▲ 140 mm with an RJ45 connector for connection to an expansion module and a network; 166 mm with a Profibus DP/CANopen connector.

Table 16.299: LTMCU operator control unit



Current Transformers

LT6CT

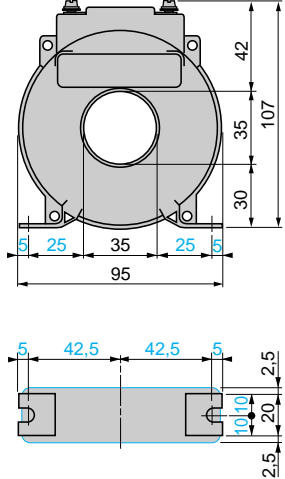

HMI Terminal

XBTN410

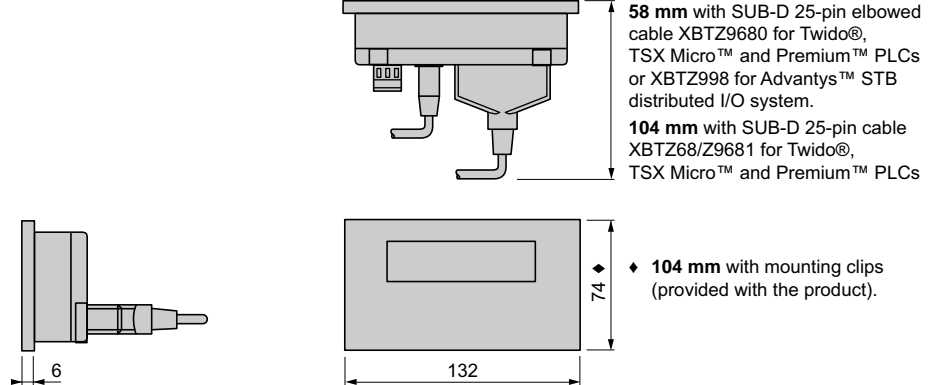

- 58 mm with SUB-D 25-pin elbowed cable XBTZ9680 for Twido®, TSX Micro™ and Premium™ PLCs or XBTZ998 for Advantys™ STB distributed I/O system.
- 104 mm with SUB-D 25-pin cable XBTZ68/Z9681 for Twido®, TSX Micro™ and Premium™ PLCs

- ◆ 104 mm with mounting clips (provided with the product).

New!

**Adapted Bimetallic or Solid-State Overload Relay Mounting Bracket Adapter (NEMA Sizes 00–1)**

New!

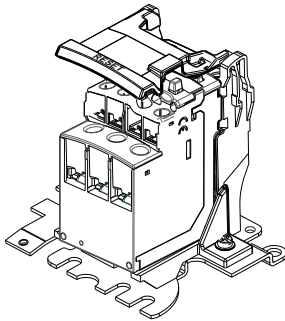

Stand-Alone Mounting Bracket (Mounted to the Overload Relay)

The adapted bimetallic Type S starter incorporates a mounting bracket for use with a self-contained adjustable bimetallic or solid state overload relay. A separately mounting version of the bracket is also available for use with contactors that do not offer the same terminal configurations as the Type S, or for applications with height restraints that demand mounting next to the contactor rather than directly below as is typical for most starter configurations.

The bimetallic thermal overload relays feature Class 10 or Class 20 protection with automatic and manual (hand) reset and a trip-free mechanism. These overload relays are ambient temperature compensated, and available with or without phase imbalance protection. The component is available as a replacement on a starter or as a separately mounted overload relay adapter. The overload relay (LRD or LR3D) can be purchased separately and field installed at a future date.

The solid-state overload relays feature Class 5, 10, 20 or 30 protection (dip switch selectable) with automatic and manual (hand) reset and a trip-free mechanism. These overload relays are ambient-temperature compensated and can be wired for single-phase applications (must use the three-pole unit). The component is available as a replacement on a starter or as a separately mounted overload relay adapter. The overload relay (LR9D) can be purchased separately and field installed at a future date. If using the LR9D with a single-phase motor, the three-pole adapter must be purchased to accommodate looping of the motor leads.

For more information, see Table 16.325.

**NOTE:** The LRD, LR3D, or LR9D overload relays must be purchased separately.

**Table 16.300: Replacement or Retrofit**

Description	Sizes	Maximum Full Load Current (A) of Overload Relay	Catalog Number
Two Pole	00, 0, 1	27	SADR751
Three Pole	00, 0, 1	27	SADR75

**Table 16.301: Stand Alone**

Description	Sizes	Maximum Full Load Current (A) of Overload Relay	Catalog Number
Two Pole	00, 0, 1	27	SAD751
Three Pole	00, 0, 1	27	SAD75

**External Reset Mechanisms, Class 9066**

**Type RA** kits provide a convenient external means for resetting overload relays mounted in control enclosures of almost any depth. Designed for use on NEMA 1, 4 or 12 enclosures, they can be used with any Square D open type magnetic starter or Class 9065 overload relay. All kits are individually packaged for easy stocking and include complete installation instructions.

Only a single mounting hole is required in the enclosure door. Each kit contains one or more threaded reset rods, grooved at intervals of 3/4" so they can be cut to the approximate length required without thread damage. Final adjustment is easily made after installation by rotating a plunger and tightening the lock nut. Mechanisms with more than one reset rod include a steel cross bar with mounting holes located at 1/2" intervals, providing a choice of rod locations to suit any application. All steel parts are electrically isolated from the enclosure and the operator.

**Type RB** kits make it possible to field install external reset mechanisms to Type S combination starters in NEMA 12 enclosures. They may also be used to replace external reset mechanisms on Type S combination starters in NEMA 1, 4 and 12 enclosures.



Type RB1



Type W1



Type RA2 Series B  
Type SC1

**Table 16.302: Class 9066 External Reset Mechanisms**

Where Used	Type of Enclosure	Reset Mechanism Kit Description	Type
OEM Kit for commercial enclosures	NEMA 1, 12	With 1 Rod With 2 Rods With 3 Rods	RA1 RA2 RA3
Replacement on 8538, 8539 starters	NEMA 1, 12	Size 0 and 1 Size 2	RB1 RB2
On commercial enclosures or Type S combination starters	NEMA 4	W1 is a boot only and must be used with RA or RB Kit listed above	W1
Replacement on Class 8536 Type S starters	NEMA 1 with slip-on covers	Size 00, 0 and 1 Size 2 Size 3	SC1 SD1 SE1
Retro-fit kit Class 8940 Pump Panel	NEMA 3R	Reset for use with 9065TJF Series B OLR	RTJF



Type SCW21  
NEMA 4X Enclosure



Type SCA11  
NEMA 12 Enclosure



Type SCW11  
NEMA 4 Enclosure



Type SCH2  
NEMA 3R Enclosure

**Separate Enclosures, Class 9991**

Separate enclosures can be used with open style devices for field assembly of enclosed controls. These enclosures, plus the open style components, are equivalent to a factory-assembled device. Separate enclosures are for use only with the following equipment:

- **NEMA 4 and 12** Class 9991 separate enclosures for Type S devices come standard with closing plates. See Table 16.304 for the specific number of closing plates. For applications requiring enclosures without closing plates, contact your nearest Schneider Electric sales office.
- **NEMA 3R** enclosures for field assembly of equipment for outdoor applications come with three closing plates, a reset mechanism, and a predrilled panel as standard. For a conduit connection to the top of these enclosures, select watertight hubs from the listing on Digest page 3-10 in accordance with applicable code requirements. Square D NEMA 12 enclosures can also be modified for outdoor use. For details, refer to the NEMA 12 enclosure modification information on page 16-112. **NOTE:** Not for use in high-corrosive outdoor locations or sea coast environments.
- **NEMA 4X** enclosures for Type S devices, Sizes 0–2 and 30–60 A, come standard without closing plates. Cover mounted control units for NEMA 4X separate enclosures are available as a factory modification only.

When closing plates are removed from NEMA 4, 12, and 3R enclosure covers, the openings can be used for easy installation of Class 9001 Type K or SK cover-mounted control units. Convenient Class 9999 modification kits containing Class 9001 Type K control kits can be found on page 16-126.

**Table 16.303: How to Order**

To Order Specify:	Catalog Number	
• Class Number	Class	Type
• Type Number	9991	SCW11

**Table 16.304: Selection, Class 9991**

For Use With		NEMA Size or Ampere Rating	Enclosure Classification					
			NEMA 4X Watertight, Dusttight and Corrosion-Resistant Glass-Polyester	NEMA 4 [1] Watertight and Dusttight Stainless Steel		NEMA 12/3R Dusttight and Driptight		NEMA 3R Rainproof, Sleet Resistant, Outdoor Use
Class	Types (All Pole Arrangements)		Type	Type	Number of Closing Plates	Type	Number of Closing Plates	Type
<b>Manual Starters</b>								
2510 [2]	MBO, MCO	MO, M1, M1P	MW1	MW11	—	MA1	—	—
<b>Magnetic Contactors</b>								
8502 [3]	SAO, SBO, SCO	00, 0, 1	SCW20	SCW11	2	SCA11 [4]	2	SCH2
	SDO	2	SDW20	SDW11	2	SDA11 [4]	2	SDH1
	SEO	3	—	SEW11	3	SEA11 [4]	3	SEH1
	SFO	4	—	SFW11	3	SFA11 [4]	3	SFH1
<b>Magnetic Starters</b>								
8536	SAO, SBO, SCO	00, 0, 1	SCW21	SCW11	2	SCA11 [4]	2	SCH2
	SDO	2	SDW21	SDW11	2	SDA11 [4]	2	SDH1
	SEO	3	—	SEW11 [5]	3	SEA11 [4]	3	SEH1
	SFO	4	—	SFW11 [5]	3	SFA11 [4]	3	SFH1
<b>Lighting Contactors, Non-Combination, Electrically and Mechanically Held</b>								
8903 [3]	LO, LXO	20 A	SDW20	SDW11	2	SDA11 [4]	2	SDH1
	SMO	30 A	SCW20 [6]	SCW11	2	SCA11 [4]	2	SCH2
	SPO	60 A	SCW20 [6]	SDW11	2	SDA11 [4]	2	SDH1
	SQO	100 A	—	SEW11 [5]	3	SEA11 [4]	3	SEH1
	SVO	200 A	—	—	—	—	—	SFH1
<b>Reversing and Two-Speed, Horizontally Arranged Contactors and Starters</b>								
8702 [3]	SBO, SCO	0, 1	—	SCW12	3	SCA12 [4]	3	—
8736	SDO	2	—	SDW12	3	SDA12 [4]	3	—
8810	SBO & SCO	0, 1	—	SCW13	3	SCA13 [4]	3	—

[1] The standard cabinet has a brushed finish.

[2] Type MBO. Size MO only.

[3] For contactors, replace the reset assembly with a proper closing plate: for NEMA 4, use Class 9001 Type K52; for NEMA 3R and 12, use Class 9001 Type K51. (Class 9991 Types SCW20 and SDW20 are designed for contactors only, so reset closing plates are not required.)

[4] NEMA 12 enclosures can be field modified for outdoor non-corrosive and non-service entrance rated applications. See page 16-112 for more information.

[5] This enclosure is suitable only for starters with a melting alloy, solid-state, or adapted bimetallic overload relay.

[6] For electrically held devices only.

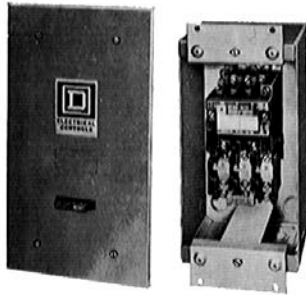

Flush Mounting Starter with Pull Box and Mounting Strap and Plaster Adjustment Feature



Type SCG8  
NEMA 1 Enclosure

**Flush Mounting, General Purpose Separate Enclosures**

Flush mounting, general purpose separate enclosures for Type S Sizes 0–2, 30–60 A are provided with knock-outs in the cover for field assembly of one Class 9999 push button or selector switch kit and one Class 9999 pilot light kit. (Refer to Class 9999 for selection.) For Type S Size 3, 100 A, three closing plates are provided for installation of Class 9001 Type K oiltight control units. For enclosure dimensions, refer to Table 16.309.

**Table 16.305: Flush Mounting Selection Table**

For Use With		NEMA Size or Ampere Rating	Flush Mounting General Purpose (Components)			
Class	Types (All Pole Arrangements)		Flush Plates		Mounting Strap	Pull Box
			Standard Type	Stainless Steel [7]		
2510	MBO, MCO	MO M1 M1P	MF1	(with pullbox and plaster adjustment)		
			MF2	(without pullbox but with mounting strap)		
<b>Magnetic Contactors</b>						
8502[8]	SBO, SCO	0, 1	SCF11	SCF12	SCF2	SCF1
	SDO	2	SDF11	SDF12	SDF2	SDF1
	SEO	3	SEF11	(Enclosure Complete)		
<b>Magnetic Starters</b>						
8536	SBO, SCO	0, 1	SCF11	SCF12	SCF2	SCF1
	SDO	2	SDF11	SDF12	SDF2	SDF1
<b>Lighting Contactors Non-Combination Electrically and Mechanically Held</b>						
8903[8]	LO, LXO	20 A	SDF13	—	SDF2	SDF1
	SMO 1–4	30 A	SCF11	—	SCF2	SCF1
	SMO 10–13	30 A	SCF13	—	SCF2	SCF1
	SPO 1–4	60 A	SDF11	—	SDF2	SDF1
	SPO 10–13	60 A	SDF13	—	SDF2	SDF1
	SQO 1–13	100 A	SEF11	(Enclosure Complete)		

**NEMA 1 General Purpose** separate enclosures in Table 16.306, when used with open style components, are equivalent to a standard factory assembled control device.

**Table 16.306: NEMA 1 Selection Table**

For Use With			NEMA 1 General Purpose Enclosure Class 9991
Class	Type	No. of Poles	Type
2510	F and K	All	EN1
	M–Sizes M0 and M1	All	MG1
	M–Size M1P	All	MG2
8501	CO	All	UE1
	XO	2–12, 2–4 with attachments	UE7
8502	XDO	2–8 without attachments	UE7
	SAO, SBO, SCO	2–4	SCG7
	SDO	2–4	SDG7
	SEO	2–4	SEG7
	SFO	2–4	SFG8
8536	SAO, SBO, SCO	2–4	SCG8
	SDO	2–4	SDG8
	SEO	2–4	SEG8 [8] [9]
	SFO	2–4	SFG8 [8] [9]
8702, 8736	SGO	3	SGG8 [10] [9]
	SAO, SBO, SCO	All	SCG9 [11]
8903	SDO	All	SDG9 [11]
	LO, LXO	All	LXG1 [12]
	SMO	All	SCG7 [13]
	SPO	All	SDG7 [13]
	SQO	All	SFG8
8910	SVO	All	SFG4
	DP	1–2	DPG1
	DPA12, 13, 22, 23, 32, 33, 42, 43	2–3	DPG1
	DPA14, 24, 34, 44, 52, 53	2–4	DPG2
	DPA62, 63	2–3	DPG3
	DPA72, 73, 92, 93	2–3	DPG4
8911	H, J, K, L & M	All	UE6
	DPSO13, 23, 33, 43	3	DPSG1
	DPSO53	3	DPSG2
9050	DPSO63, 73, 93	3	SEG8
	AO (Single Head)	All	UE6
9070	HO	All	UE6
	EO51, EO61, EO71, K750, K1000	—	SDG4
	EO2, EO3, EO4, EO15, EO16 EO18, EO19, T75, T100, T150, T200, T250, T300, T350, T500	—	LG1
	EO1, EO17, T50	—	UE7

[7] The standard cabinet has a brushed finish.

[8] For contactors, replace the reset assembly with a proper closing plate. For flush mounting, use Class 9999 Type SG2—except for Class 9991 Type SDF11 enclosures, which require a Class 9001 Type K51 or K11 closing plate. (Class 9991 Types SEF11 and LF1 are designed for contactors only, so reset closing plates are not required.)

[9] This enclosure is suitable only for starters with a **melting alloy, solid-state, or adapted bimetallic** overload relay.

[10] Series B starter enclosure.

[11] For horizontally arranged Class 8702 contactors, replace the reset assembly with a Class 9001 Type K51 closing plate.

[12] If cover mounted control units are required, select an oversized enclosure listed in Table 16.307.

[13] For electrically held contactors only. See Table 16.307 for mechanically held contactors.



Type SCW4  
NEMA 4 Enclosure



Type SCG1  
With Starter, Transformer and  
Fuse Block Installed



Type SCA11  
NEMA 12 Enclosure

### Enclosure Selection

#### NEMA 1, 4, and Oversized Enclosures For the Addition of a Control Circuit Transformer

The Class 9991 enclosures listed in Table 16.307 accept an open type Class 8502 or 8536 Type S, NEMA Size 0, 1, 1P, or 2 contactor or starter along with a fused control circuit transformer (Form F4T) to allow field assembly of enclosed controllers. In the cover of the Class 9991 Type SCG1 enclosure, knock-outs are provided for field addition of Class 9999 cover-mounted control units. All other Class 8502 & 8536 enclosures include a panel with space and drilling for an open-type device and a fused control circuit transformer. In addition, three closing plates are included in each cover for easy installation of Class 9001 Type K or SK control units.

Oversized enclosures for open type Class 8903 Type L & LX, 20 A and Type S, 30 and 60 A electrically and mechanically held lighting contactors include a panel with space and drilling for an open-type contactor and fused control circuit transformer (Form F4T) and/or an auxiliary relay for use with single pole pilot devices (Form R6). When an auxiliary relay is required, use a Class 8501 Type XO11 relay. Three closing plates are provided as standard for easy installation of Class 9001 Type K or SK control units.

**Note:** A Class 9991 Type SCG1 NEMA 1 separate enclosure can also be used for Class 8903 Type SMO, 30 A electrically held lighting contactor if Form F4T (control transformer), with or without cover control units is required.

#### NEMA 12/3R Enclosures Modified for Outdoor Applications (not to be used in salt air or corrosive environments)

**Field Modifications for NEMA 3** dusttight, raintight and sleet resistant outdoor applications are as follows: Watertight conduit hubs or equivalent provision for watertight connection at the conduit entrance shall be used.

**Field Modifications for NEMA 3R** rainproof and sleet resistant outdoor applications are as follows:

- Watertight conduit hubs or equivalent provision for watertight connection at the conduit entrance, when the conduit enters at a level higher than the lowest live part, shall be used.
- Drain holes of 1/8 inch diameter shall be added to the bottom of the enclosure.

Class 9001 Type K oiltight/watertight control units can be easily installed in NEMAs 4, 12, and oversized NEMA 1 separate enclosures provided with closing plates. When installing control units simply remove the closing plates and install the proper Class 9001 Type K components. Convenient control unit kits complete with assembled and pre-wired operators for quick installation are available as Class 9999 user modification kits. See Table 16.308 for contents of each control unit kit. Class 9001 Type SK NEMA 4X corrosion resistant control units may be used as an alternate.

Table 16.307: NEMA 1, 4, and 12 Enclosures

For Use With				Class 9991 Enclosure			Recommended Class 9070 [14] Transformer Selection					Fuse Block	
Class	Type	NEMA Size or Ampere Rating	No. of Poles	General Purpose NEMA 1	Watertight and Dusttight Stainless Steel NEMA 4 [15]	Dusttight and Driptight Industrial Use NEMA 12 [16]	Standard		Extra Capacity				
				Type	Type	Type	Type	VA	100 VA Type	150 VA Type	300 VA Type		
Magnetic Contactors and Starters [17]													Class 9999 Type SFR4
8502, 8536	SAO, SBO, SCO	00, 0, 1	1-3 4-5	SCG1	SCW4	SCA4	T50	50 VA	T100 [18]	T150 [18]	—		
	SDO	2	2-5	SDG4	SDW4	SDA4	T100	100 VA	—	T150	T300		
	Lighting Contactors, Non-Combination							T50	50 VA	—	—	—	
8903	LO, LXO	20 A	All	SDG3	SDW3	SDA3	T50	50 VA	T100 [18]	T150 [18]	—		
	SMO [19]	30 A	1-3 4-5				T100 [18]	100 VA	—	T150 [18]	—		
	SPO [19]	60 A	2-5				T100	100 VA	—	T150	T300		

Table 16.308: Control Unit Selection Table

Class 9999 Type	Control Function	Kit Contents Class and Type	Description
SA3	Start-Stop Push Button	1-9001 KR1B 1-9001 KR1R 1-9001 KN201 1-9001 KN202 2-9001 KA1	Start Operator Stop Operator Start Legend Plate Stop Legend Plate Contact Block
SC8	Hand-Off-Auto Selector Switch	1-9001 KS43B 1-9001 KN260 1-9001 KA1	Selector Operator Switch Hand-Off-Auto Legend Plate Contact Block
SP28R	Pilot Light (120 V)	1-9001 KP1R31	Red Pilot Light

[14] For complete description, see the Class 9070 section. **Note:** The Class 9991 Type SCG1 enclosure comes standard with a Class 9999 Type SF4 fuse block.

[15] The standard cabinet has a brushed finish.

[16] NEMA 12 modified for outdoor use (see NEMA 12/3R Enclosures Modified for Outdoor Applications).

[17] For contactors (Class 8502), a separate closing plate is provided with each enclosure to replace the reset mechanism—with the exception of Class 9991 Type SCG1, which requires a separate reset closing plate: Class 9999 Type SG2.

[18] To mount in an SCG1 enclosure, a Class 9991 Type S1 adapter bracket is also required.

[19] Mechanically held.

**NEMA 1 Enclosures**

**NOTE:** These dimensions are for reference only. If you need precise measurements, contact the Customer Care Center at 1-888-778-2733.

**Table 16.309: NEMA 1—General Purpose Enclosures (Standard)**

Class 9991 Type	For Use With				Dimensions (inches/millimeters)														Weight (lb)	
	Class	Type	Size	No. of Poles	Fig. No.	Mounting Screws (in.)	A	B	C	D	E	F	G	H	I	J	K	L		
LXG1	8903	LO, LXO	20 A	2-12	1	—	7.81 198	12.69 322	6.03 153	—	1.09 28	10.50 267	1.09 28	1.09 28	5.63 143	5.75 146	1.09 28	5.63 143	8	
DPG1	8910	DP	20-40	1-2	1	(4) #10	4.85	8.5	4.03	2.42	.109	5.75	.531	.92	3.00	3.75	—	—	2	
		DPA	A	1-3			123	216	102	62	3	146	13	23	76	95				
SCG7	8903	SMO (E.H.)	30 A	All	1	(3) #10	6.00 152	10.00 254	5.28	3.00	.88	8.13 206	1.00 25	.94	4.13 105	5.00 127	—	—	4	
		SAO	.00	5.28																
		SBO SCO	0 1	134																
SCG8	8536	SAO	.00	2-3	1	(3) #10	6.00 152	10.00 254	5.56	3.00	.88	8.13 206	1.00 25	.94	4.13 105	5.00 127	—	—	4	
		SBO SCO	0 1	141																
DPG2	8910	DPA	—	—	—	—	—	—	—	—	—	—	—	—	—	—	—	—	—	—
DPSG1	8911	DPS	—	—	—	—	—	—	—	—	—	—	—	—	—	—	—	—	—	—
SDG7	8903	SPO (E.H.)	60 A	2-12	1	(4) 1/4	7.81 198	12.69 322	6.03	—	1.09	10.50 267	1.09 28	1.09 28	5.63 143	5.75 146	1.09 28	5.63 143	8	
		SDO	2	153																
SDG8	8536	SDO	2	All	1	(4) 1/4	7.81 198	12.69 322	6.31	—	1.09	10.50	1.09	1.09	5.63	5.75	1.09	5.63	8	
DPG3	8910	DPA	—	—	—	—	—	—	—	—	—	—	—	—	—	—	—	—	—	—
DPSG2	8911	DPS	—	—	—	—	—	—	—	—	—	—	—	—	—	—	—	—	—	—
SEG7	8502	SEO	3	All	1	(4) 3/8	11.44 291	21.81 554	8.00	—	1.53	18.75 476	1.53 39	1.53 39	8.38 213	7.75 197	1.53 39	8.38 213	23	
		SEO	3	203																
SEG8	8911	DPSG63 to 93	—	All	1	(4) 3/8	11.44 291	21.81 554	8.38	—	1.53	18.75	1.53	1.53	8.38	7.75	1.53	8.38	23	
DPG4	8910	DPA	—	—	2	(4) 7/16	11.25 286	25.15 639	8.99	8.60 218	1.25 32	1.25 32	22.31 567	1.42 36	.44 11	—	—	—	—	34
		SFO	4	228																
		SFO	4	228																
SFG8	8903	SQO (E.H. & M.H.)	100 A	All	2	(4) 7/16	11.25 286	25.15 639	8.99 228	8.60 218	1.25 32	1.25 32	22.31 567	1.42 36	.44 11	—	—	—	—	34
		SBO, SCO	0 & 1	All	2	(4) 5/16	11.88 302	11.88 302	7.41 188	9.75 248	1.06 27	1.06 27	9.75 248	1.06 27	.31 8	—	—	—	—	16
SDG9	8922	ETBC20, ETBC36	—	—	2	(4) 5/16	14.88 378	14.13 359	7.56 192	12.75 324	1.06 27	1.06 27	12.00 305	1.06 27	.31 8	—	—	—	—	24

**Table 16.310: NEMA 1—General Purpose Enclosures (Oversize)**

Class 9991 Type	For Use With				Fig. No.	Mounting Screws (in.)	A	B	C	D	E	F	G	H	I	Weight (lb)
	Class	Type	Size	No. of Poles												
SDG3	8903	LO, LXO, SMO (M.H.), SPO (Form F4T)	20 A, 30 A, 60 A	All	2	(4) 5/16	14.88 378	14.13 359	7.56	12.75 324	1.06 27	1.06 27	12.00 305	1.06 27	.31 8	15
		SDO (Form F4T)	2	All					192							
SDG4	8536	SDO (Form F4T)	2	All	2	(4) 5/16	14.88 378	14.13 359	7.66	12.75 324	1.06 27	1.06 27	12.00 305	1.06 27	.31 8	21
		EO51, EO61, EO71, T750, T1000	—	—					194							
SCG1	8903	SBO, SCO (Form F4T)	0, 1	All	3	(4) 9/32	6.34 161	15.88 403	5.19	4.66 118	.84 21	14.38 365	.75 19	.28 7	.35 9	8
		SBO, SCO (Form F4T)	0, 1	All					132							
		SMO (E.H.) (Form F4T)	30 A	All					132							

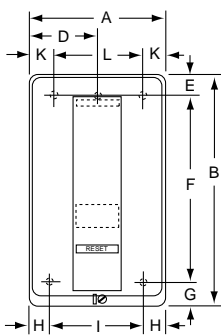

Figure 1  
Dimensions: in.  
mm

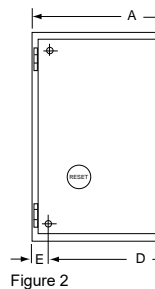
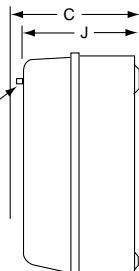

Figure 2

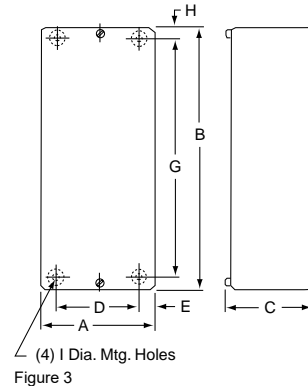

Figure 3

[20] The standard enclosure has space for a fused control transformer, **Form FF4T**, on Sizes 0-2.

**NEMA 1 and 3R Enclosures**

**NOTE:** These dimensions are for reference only. If you need precise measurements, contact the Customer Care Center at 1-888-778-2733.

**Table 16.311: NEMA 1—General Purpose Enclosures**

Class 9991 Type	For Use With			Dimensions (See Figure 4)										Weight (lb)
	Class	Type	No. of Poles	A	B	C	D	E	F	G	H	J	L	
UE1	8501	CO	All	3.63 92	5.28 134	3.31 84	1.88 48	3.63 92	1.06 27	1.50 38	1/4 in. [21]	1/2–3/4 in.		2
UE6	8910	H, J, K L & M	All	4.91 125	5.75 146	5.53 140	3.50 89	4.38 111	1.56 40	2.00 51	9/32 in.	1/2–3/4 in. 1–1-1/4 in.	1/2–3/4 in.	2
	9050	AO (Single Head) HO	All											
UE7	8501	XO	2–12, 2–4 w/ Attachments	4.87 124	7.79 198	7.53 191	3.50 89	6.38 162	1.31 33	1.88 48	#10	1/2–3/4 in.	4	
	9070	XDO	2–8											
LG1	9070	EO2, EO3, EO4, EO15, EO16, EO18, EO19, T75, T100, T150, T200, T250, T300, T350, & T500	—	7.53 191	9.78 248	5.91 150	6.13 156	8.38 213	1.31 33	1.88 48	9/32 in.	1/2–3/4–1 in. [22]		10

**Table 16.312: NEMA 3R—Rainproof and Sleet-Resistant Enclosures**

Class 9991 Type	For Use With				Dimensions (see Figure 5)																		
	Class	Type	Size	No. of Poles	A	B	C	D1	D2	E	F	G1	G2	H1	H2	J	K	L	M	N	P	K.O. X	K.O. Y
SCH2	8502 8536	SBO SCO	0, 1	All	8.83 224	12.30 312	7.12 181	1.39 35	1.44 37	6.00 152	7.50 191	2.61 66	2.19 56	2.08 53	2.62 66	14.28 363	1.37 35	1.37 35	1.88 48	4.38 111	1.83 46	1/2 3/4	1/2 3/4
	8903	SMO	30 A		8.83 224	12.30 312	7.12 181	1.39 35	1.44 37	6.00 152	7.50 191	2.61 66	2.19 56	2.08 53	2.62 66	14.28 363	1.37 35	1.37 35	1.88 48	4.38 111	1.83 46	1/2 3/4	1/2 3/4
SDH1	8502 8536	SDO	2	All	9.83 250	16.30 414	8.62 219	1.39 35	1.44 37	7.00 178	11.50 292	2.61 66	2.19 56	2.08 53	2.62 66	16.78 426	1.31 33	1.75 44	2.13 54	4.88 124	1.83 46	1 1-1/4 1-1/2	1/2 3/4
	8903	LO LXO	20 A		9.83 250	16.30 414	8.62 219	1.39 35	1.44 37	7.00 178	11.50 292	2.61 66	2.19 56	2.08 53	2.62 66	16.78 426	1.31 33	1.75 44	2.13 54	4.88 124	1.83 46	1 1-1/4 1-1/2	1/2 3/4
	8903	SPO	60 A		9.83 250	16.30 414	8.62 219	1.39 35	1.44 37	7.00 178	11.50 292	2.61 66	2.19 56	2.08 53	2.62 66	16.78 426	1.31 33	1.75 44	2.13 54	4.88 124	1.83 46	1 1-1/4 1-1/2	1/2 3/4
SEH1	8502 8536	SEO	3	All	12.63 321	25.30 643	8.62 219	1.39 35	1.44 37	10.00 254	20.60 523	2.61 66	2.19 56	2.08 53	2.62 66	19.78 502	1.31 33	2.31 59	2.69 68	6.38 162	1.83 46	1 1-1/4 2 2-1/2	1/2 3/4
	8903	SQO	100 A		12.63 321	25.30 643	8.62 219	1.39 35	1.44 37	10.00 254	20.60 523	2.61 66	2.19 56	2.08 53	2.62 66	19.78 502	1.31 33	2.31 59	2.69 68	6.38 162	1.83 46	1 1-1/4 2 2-1/2	1/2 3/4
SFH1	8502 8536	SFO	4	All	12.63 321	40.30 1024	9.12 232	1.39 35	1.44 37	10.00 254	35.50 902	2.61 66	2.19 56	2.08 53	2.62 66	20.28 515	1.31 33	2.31 59	2.69 68	6.38 162	1.83 46	1 1-1/4 2 2-1/2	1/2 3/4
	8903	SVO	200 A		12.63 321	40.30 1024	9.12 232	1.39 35	1.44 37	10.00 254	35.50 902	2.61 66	2.19 56	2.08 53	2.62 66	20.28 515	1.31 33	2.31 59	2.69 68	6.38 162	1.83 46	1 1-1/4 2 2-1/2	1/2 3/4

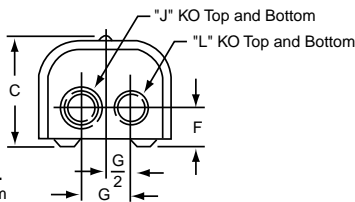
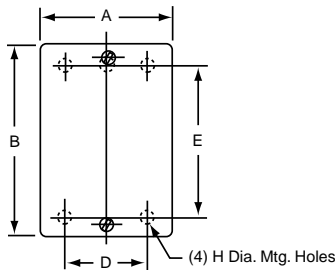

Dimensions: in.  
mm  
Figure 4

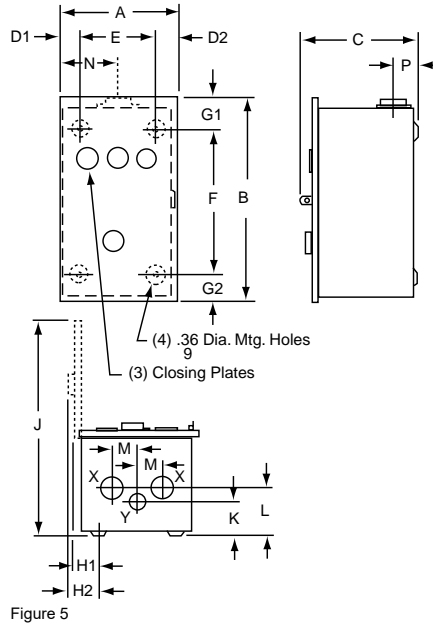

Figure 5

[21] Class 9991 Type UE1 has only 3 of the H diameter mounting holes: 2 in the bottom as shown, and 1 centered at the top.  
[22] Class 9999 Type LG1 has 3 knockouts, top and bottom.



**NEMA 4 and 4X Enclosures**

**NOTE:** These dimensions are for reference only. If you need precise measurements, contact the Customer Care Center at 1-888-778-2733.

**Table 16.313: NEMA 4X—Watertight and Corrosion Resistant Enclosures**

Class 9991 Type	For Use With				Dimensions (see Figure 6)													Hub Dia.		Weight (lb)
	Class	Type	Size	No. of Poles	A	B	C	D	E	F	G	H	I	J	K	L	Bot. Only W	Top & Bot. X		
SCW20	8903	SMO (E.H.)	30 A	All	6.50 165	6.44 164	12.13 308	.75 19	5.00 127	8.25 210	1.69 43	3.34 85	10.06 256	1.31 33	2.13 54	.31 8	3/4 in.	1 in.	7	
	8502	SBO, SCO	0, 1	All																
SCW21	8536	SBO, SCO	0, 1	All																
SDW20	8903	LO, LXO	20 A	All	8.50 216	7.06 179	13.88 352	.75 19	7.00 178	10.50 267	1.69 43	3.91 99	11.94 303	1.63 41	2.38 60	.31 8	3/4 in.	1-1/2 in.	13	
	8903	SPO (E.H.)	60 A	All																
SDW21	8502	SDO	2	All																
	8536	SDO	2	All																

**Table 16.314: NEMA 4—Watertight Enclosures (Standard)**

Class 9991 Type	For Use With				Dimensions (see Figure 6)													Hub Dia.		Weight (lb)	
	Class	Type	Size	No. of Poles	A	B	C	D	E	F	G	H	I	J	K	L	Bot. Only W	Top & Bot. X			
SCW11	8903	SMO	30 A	All	6.38 162	7.13 181	13.19 335	1.56 40	3.25 83	12.00 305	.59 15	1.88 48	11.78 299	1.63 41	2.31 59	.31 8	3/4 in.	1 in.	12		
	8502	SBO, SCO	0, 1	All																	
	8536	SBO, SCO	0, 1	All	6.38 162	7.81 198	13.19 335	1.56 40	3.25 83	12.00 305	.59 15	1.88 48	11.78 299	1.63 41	2.31 59	.31 8					
SDW11	8903	LO, LXO	20 A	All	8.13 206	7.88 200	16.19 411	1.56 40	5.00 127	15.00 381	1.09 28	1.94 49	14.75 375	2.00 51	2.63 67	.31 8	3/4 in.	1-1/2 in.	18		
	8903	SPO	60 A	All																	
	8502	SDO	2	All																	
	8536	SDO	2	All																	
SEW11	8903	SQO	100 A	All	18.15 461	8.77 223	32.21 818	3.08 78	12.00 305	30.50 775	.86 22	3.67 93	26.71 678	2.58 66	3.19 81	.44 11	3/4 in.	2-1/2 in.	51		
	8502	SEO	3	All																	
	8536	SEO	3	All																	
	8536	SFO	4	All																	
SFW11	8502	SFO	4	All	18.15 461	8.77 223	32.21 818	3.08 78	12.00 305	30.50 775	.86 22	3.67 93	26.71 678	2.58 66	3.19 81	.44 11					

**Table 16.315: NEMA 4—Watertight Enclosures (Oversize)**

Class 9991 Type	For Use With				Dimensions (see Figure 7)													Hub Dia.		Weight (lb)	
	Class	Type	Size	No. of Poles	A	B	C	D	E	F	G	H	I	J	K	L	Bot. Only W	Top & Bot. X			
SCW2	8702 8736	SCO	1	All													3/4 in.	1 in.	23		
SCW3	8810	SBO SCO	0 1	All	12.63 321	7.81 198	14.69 373	2.56 65	7.50 191	13.50 343	.59 15	3.88 98	18.41 468	1.66 42	2.31 59	.31 8					19
SCW4	8502 8536	SBO, SCO (Form F4T)	0, 1	All																	24
SDW2	8702 8736	SDO	2	All													3/4 in.	1-1/2 in.	25		
SDW3	8903	LO, LXO SMO, SPO (Form F4T)	20 A 30 A 60 A	All	14.88 378	7.25 184	16.19 411	2.56 65	9.75 248	15.00 381	.38 10	3.88 98	20.88 530	1.72 44	2.63 67	.31 8					29
SDW4	8502 8536	SDO (Form F4T)	2	All																	28

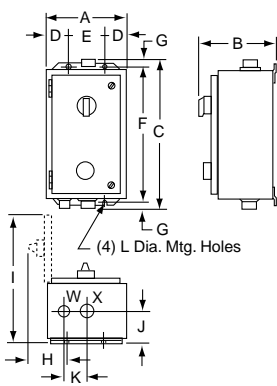

Figure 6

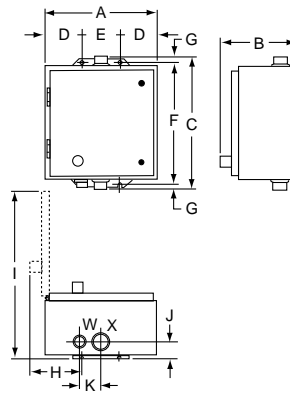

Figure 7

Dimensions: in.  
mm

**NEMA 12/3R and Flush Mounting General Purpose Enclosures**

**NOTE:** These dimensions are for reference only. If you need precise measurements, contact the Customer Care Center at 1-888-778-2733.

**Table 16.316: See Figure: NEMA 12/3R—Dusttight and Driptight Enclosures (Standard)**

Class 9991 Type	For Use With				Dimensions											Weight (lb)
	Class	Type	Size	No. of Poles	A	B	C	D	E	F	G	H	I	J		
SCA11	8502	SBO, SCO	0, 1	All	6.38 162	8.53 217	12.75 324	1.56 40	3.25 83	12.00 305	.38 10	3.56 90	12.50 318	.31 8	10	
	8536	SBO, SCO	0, 1	All												
	8903	SMO	30 A	All												
SDA11	8502	SDO	2	All	8.13 206	9.28 236	16.00 406	1.56 40	5.00 127	15.00 381	.50 13	3.56 90	15.38 391	.31 8	15	
	8536	SDO	2	All												
	8903	LO, LXO	20 A	All												
	8903	SPO	60 A	All												
SEA11	8903	SQO	100 A	All	18.15 461	9.24 235	31.50 800	3.08 78	12.0 305	30.50 775	.50 13	3.67 93	26.71 678	.44 11	51	
	8502	SEO	3	All												
	8536	SEO	3	All												
SFA11	8536	SFO	4	All	18.15 461	9.58 243	31.50 800	3.08 78	12.0 305	30.50 775	.50 13	4.48 114	26.71 678	.44 11	51	
	8502	SFO	4	All												

**Table 16.317: See Figure: NEMA 12/3R—Dusttight and Driptight Enclosures (Oversized)**

Class 9991 Type	For Use With				Dimensions											Weight (lb)
	Class	Type	Size	No. of Poles	A	B	C	D	E	F	G	H	I	J		
SCA2	8702 8736	SCO	1	All	11.88 302	7.75 197	13.5 343	2.56 65	6.75 171	12.75 324	.38 10	3.66 93	18.13 460	.31 8	17	
SCA3	8810	SBO SCO	0 1	All											18	
SCA4	8502 8536	SBO, SCO (Form F4T)	0, 1	All											19	
SDA2	8702 8736	SDO	2	All											24	
SDA3	8903	LO, LXO SMO, SPO (Form F4T)	20 A 30 A 60 A	All	14.88 378	7.88 200	16.00 406	2.56 65	9.75 248	15.00 381	.50 13	3.66 93	21.25 540	.31 8	27	
SDA4	8502 8536	SDO (Form F4T)	2	All											27	

**Table 16.318: See Figure: Flush Mounting General Purpose Enclosures**

Class 9991 Type	For Use With				Dimensions									Weight (lb)
	Class	Type	Size	No. of Poles	A	B	C	D	E	F	G	H		
SDF13 (w/SDF1 & SDF2)	8903	LO, LXO	20 A	All	15.19 386	8.94 227	7.63 194	12.88 327	5.44 138	10.94 278	5.13 130	.38 10	17	
SCF11 (w/SDF1 & SDF2)	8502	SBO, SCO	0, 1	All	13.44 341	7.19 183	5.88 149	11.13 283	4.75 121	9.19 233	4.50 114	.38 10	10	
	8536	SBO, SCO	0, 1	All										
	8903	SMO (E.H.)	30 A	All										
SDF11 (w/SDF1 & SDF2)	8502	SDO	2	All	15.19 386	8.94 227	7.63 194	12.88 327	5.44 138	10.94 278	5.13 130	.38 10	17	
	8536	SDO	2	All										
	8903	SPO (E.H.)	60 A	All										
SEF11	8502	SEO	3	All	31.00 787	16.75 425	14.25 362	26.25 667	8.00 203	—	—	.18 5	48	
	8903	SQO	100 A	All										

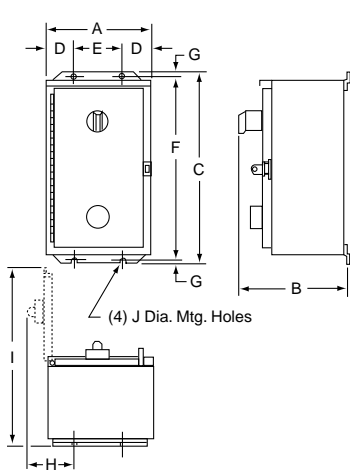

**Figure 16.31: NEMA 12/3R—Dusttight and Driptight Enclosures (Standard)**

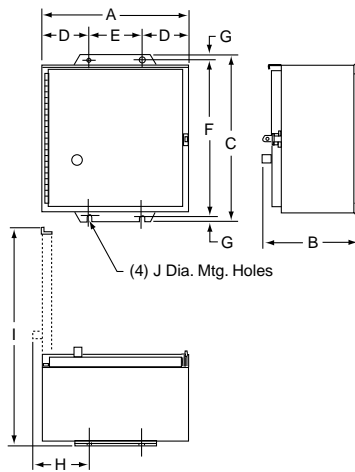

**Figure 16.32: NEMA 12/3R—Dusttight and Driptight Enclosures (Oversized)**

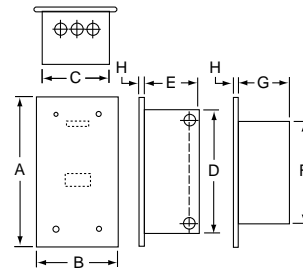

**Figure 16.33: Flush Mounting General Purpose Enclosures**

**Full Voltage Starters**

Factory installed modifications are available for the classes of control equipment listed in the respective tables. Kits are also available for many field modifications and normal parts replacement on most control items. Refer to Classes 9998 and 9999 for complete listings.

**NOTES**

- Standard equipment dimensions and enclosure construction may not apply when certain special features are added. Such cases should be referred to the factory, with complete description, when precise dimensions are required.
- If a UL label is required, consult the Customer Care Center at 1-888-778-2733. Some Forms are not UL Listed.

**Table 16.319: Full Voltage Starters**

	Factory Modifications	Enclosure Type	Form	
Pilot Devices in Cover Full Voltage Non-Reversing Controllers Only Classes 8502 8536 8538 8539	<b>Push Buttons [1]</b>			
	Start-Stop	1 [2], 3R, 4, 4X, 12, 7, & 9	A	
	Start-Stop (maintained contact) [3] [4]	1 [2], 3R, 4, 4X, 12	A16	
	Start-Stop push button and Hand-Off-Auto selector switch [4]	1 [2], 3R, 4, 4X, 12	AC	
	On-Off [4]	1 [2], 3R, 4, 4X, 12	A3	
	Single oiltight push button (specify marking) [4]	1, 3R, 4, 4X, 12	A11	
	<b>Selector Switches</b>			
	Hand-Off-Auto	1 [2], 3R, 4, 4X, 12, 7, & 9	C	
	On-Off [4]	1 [2], 3R, 4, 4X, 12, 7, & 9	C6	
	NON-STANDARD markings for Pilot Devices [4]	1, 3R, 4, 12	G12 [5]	
	Addition of padlock attachment to Class 9001 operators [4]	1, 3R, 4, 12	G122	
	Pilot Lights (specify color/type) [6] See Table 16.320.			
	With Operating Interlock: Add price of each interlock per light	1, 3R, 4, 4X, 12	X [7]	
	Pilot Devices in Cover Full Voltage Reversing and Multi-Speed Controllers Only Classes 8702 8736 8738 8739 8810 8811 8812	<b>Push Buttons [1]</b>		
		Forward-Reverse-Stop [4]	1, 4, 4X, 12, 7, 9	A1
		High-Low-Stop [4]	1, 4, 12	A2
Fast-Off-Slow [4]		1, 4, 12	A9	
High-Low push button and Hand-Off-Auto selector [4]		1, 4, 12	A10C	
Single oiltight push button (specify marking) [4]		1, 4, 4X, 12	A11	
<b>Selector Switches</b>				
Hand-Off-Auto		1 [2], 4, 4X, 12, 7, & 9	C	
On-Off [4]		1 [2], 4, 4X, 7, & 9	C6	
High-Off-Low		1, 4, 12	C7	
Forward-Off-Reverse [4]		1, 4, 4X, 12, 7, & 9	C14	
High-Low and Hand-Off-Auto [4]		1, 4, 12	CC17	
Slow-Fast [4]		1, 4, 4X, 12	C19	
Forward-Reverse [4]		1, 4, 4X, 12	C20	
High-Low-Off-Auto [4]		1, 4, 12	C25	
Non-Standard Markings for Pilot Devices [4]		Any	G12 [5]	
Pilot Lights [6]		1, 4, 4X, 12	X [7]	
Available with Operating Interlock				

**Table 16.320: Pilot Light Forms**

	Standard	Push-to-Test	LED	LED-Push-to-Test
	Form	Form	Form	Form
Red ON	P1 [8]	P21	P51	P42
Red OFF	P71	P81	P91	P43
Red Unwired	P38	P28	P58	P44
Green ON	P72	P82	P92	P45
Green OFF	P2 [8]	P22	P52	P46
Green Unwired	P39	P29	P59	P47
Amber	P3	P23	P53	P63
Clear	P4	P24	P54	P64
Yellow	P35	P25	P55	P48
Blue	P36	P26	P56	P66
White	P37	P27	P57	P67
Red LOW—Green HI	P73	P83	P93	P77
Green LOW—Red HI	P74	P84	P94	P78
Red OFF—Green FWD/REV	P75	P85	P95	P79
Green OFF—Red FWD/REV	P76	P86	P96	P80

[1] All push buttons are momentary contact unless specified otherwise.  
 [2] Selection of various Form combinations may force the use of a larger enclosure.  
 [3] Specify the appropriate Class 9001 Type K or SK operator required.  
 [4] Not available for Size 00.  
 [5] Specify the marking and/or the required Class 9001 Type KN or SKN legend plate.  
 [6] Indicate the pilot light color as **Form P1** (red), **Form P2** (green), and so forth, as shown in Table 16.320. Unless otherwise requested, standard practice is to wire a red pilot light to indicate that the device is energized. No additional auxiliary contact is required. Also, standard practice is to wire a green pilot light to indicate that the device is de-energized. An additional normally closed auxiliary contact is supplied. A wiring diagram must be provided for other pilot light colors or arrangements.  
 [7] To determine the maximum number of auxiliary contacts that can be added to each Type S device, and for the appropriate X Form, refer to Table 16.85 (for non-reversing single-speed devices) or Table 16.170 (for reversing or two-speed devices). For Class 8600 reduced voltage controllers, consult the Customer Care Center at 1-888-778-2733.  
 [8] Only for pilot light. Available for Size 00.

Full Voltage Contactors and Starters

Table 16.321: Control Circuit, Full Voltage and Multi-Speed Controllers Only

Classes	Factory Modifications	Enclosure Type	Form	NEMA SIZE											
				00	0	1	2	3	4	5	6	7			
8502 8536 8538 8539 8702 8736 8738 8739 8810 8811 8812	Separate Control Circuit—(specify voltage and frequency)	Any	S [9]	X	X	X	X	X	X	X	X	X	X		
	Fused Control Circuit (without control transformer)														
	One fuse [10]	1, 3R, 4, 4X, 12	F	X	X	X	X	X	X	X	X	—	—		
	Two fuses [10]	1, 3R, 4, 4X, 7, 9, 12	F4	X	X	X	X	X	X	X	X	—	—		
	Control Circuit Transformers [11]—Standard capacity (50 or 60 Hz) Note: All orders requesting Form FT will be supplied as Form F4T.														
	FUSES														
		Primary	Secondary												
		2	1	1, 4, 4X, 12	FF4T	X	X	X	X	X	X	X	X [12]	X	X
		2	1	7 & 9	FF4T	X	X	X	X	X	X	X	X [12]	X	X
		2	2	1, 4, 4X, 12 [10]	F4F10T	X	X	X	X	X	X	X	X [12]	—	—
	Additional Capacity (50 or 60 Hz)														
	Two fuses in primary and one fuse in secondary														
		100 VA additional capacity	1, 4, 4X, 12	FF4T11	X	X	X	X	X	X	X	X [12]	X [12]	X	X
		100 VA additional capacity [10]	7 & 9	FF4T11	X	X	X	X	X	X	X	X [12]	X [12]	—	—
		200 VA additional capacity	1, 4, 4X, 12	FF4T12	X	X	X	X	X	X [12]	X [12]	X [12]	X [12]	X	X
	300 VA additional capacity	1, 4, 4X, 12	FF4T13	X	X [12]	X [12]	X [12]	X [12]	X [12]	X [12]	X [12]	X [12]	X	X	
	400 VA additional capacity	1, 4, 4X, 12	FF4T14	X	X [12]	X [12]	X [12]	X [12]	X [12]	X [12]	X [12]	X [12]	X [12]	X [12]	
	500 VA additional capacity	1, 4, 4X, 12	FF4T15	X	X [12]	X [12]	X [12]	X [12]	X [12]	X [12]	X [12]	X [12]	X [12]	X [12]	

Table 16.322: Marine Control

Class	Factory Modification	Enclosure Type	Form
8502 8536 8538 8539 8702 8736 8738 8739 8810 8941	Modification of standard device for use as marine control in accordance with UL508 [13]	12/3R 4/4X (stainless steel only)	M10

Table 16.323: Control Circuit Transformer Codes

AC-Operated Devices With Control Transformers	
Voltage	Code
60 Hz (Primary-Secondary)	
120-12 [14]	V88
120-24 [14]	V89
208-120	V84
240-24 [14]	V82
240-120	V80
277-120	V85
480-24 [14]	V83
480-120	V81
480-240	V87
600-120	V86
Specify	V99

Selection of Control Circuit Transformers

The standard primary/secondary voltages for control circuit transformers are indicated in .

To order, select the desired device with the appropriate transformer Form designation. Then convert the previously selected voltage code (V●●) to reflect the desired primary/secondary voltage for the transformer. The secondary voltage should equal the previously selected coil voltage of the device.

Example:

You have selected 8536SDG1V02S. V02S means that you need a coil voltage of 120-60/110-50 wired for separate control. You would like to add Form FF4T, with transformer voltages of 480 V primary, 120 V secondary, and solid-state overload relay protection with selectable Class 10/20 trip class—Form H30. (The Form designations needed are FF4, H30, and T.)

The new and complete Class, Type, voltage code, and Form number will be:

Class	Type	Voltage Code	Form [15]
8536	SDG1	V81	FF4H30T

[9] All combination style devices—such as Class 8538, 8539, 8738, and 8739—that use Form S should also use Form Y74 (auxiliary contact installed on the disconnect switch) in accordance with NEC Article 430-74.

[10] Not available for Sizes 6 and 7.

[11] See .

[12] Single primary voltage must be specified.

[13] Not available for NEMA Sizes 0, 00, or 7. NEMA Sizes 00 and 0 cannot be used with marine controls.

[14] 12 V coils are not available on Sizes 3-7. 24 V coils are not available on Sizes 4-7.

[15] Specify Form numbers in alphabetical order. Each letter indicates the beginning of a new Form and may be followed by one or more numbers.

**Solid-State Overload Relay Forms**

The solid-state overload relay (SSOLR) is available on NEMA Size 00–7. For Class 8536, 8538, 8539, 8736, 8738, 8739 and 8810 devices.

**Form Description**

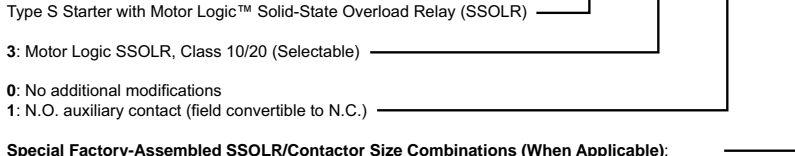

Type S Starter with Motor Logic™ Solid-State Overload Relay (SSOLR)  
 3: Motor Logic SSOLR, Class 10/20 (Selectable)  
 0: No additional modifications  
 1: N.O. auxiliary contact (field convertible to N.C.)

**Special Factory-Assembled SSOLR/Contactor Size Combinations (When Applicable):**  
 (must be specified on Size 00 starter orders)

- Blank: Overload relay matched to the starter size (for example, Size 1 contactor and 9-27 A overload relay)
- 0: 6–18 A overload relay on the starter size indicated by the starter catalog number
  - 1: 9–27 A overload relay on the starter size indicated by the starter catalog number
  - 2: 15–45 A overload relay on the starter size indicated by the starter catalog number
  - 3: 30–90 A overload relay on the starter size indicated by the starter catalog number
  - 4: 45–135 A overload relay on the starter size indicated by the starter catalog number
  - 8: 1.5–4.5 A overload relay on the starter size indicated by the starter catalog number (only offered on Feature Units)
  - 9: 3–9 A overload relay on the starter size indicated by the starter catalog number

**NOTE:** Size 7 comes standard with the Motor Logic SSOLR, Class 10/20 (Selectable). No Form designation is required.

**Special note** for Class 8810 devices:

You **must** specify two separate Form numbers to get Motor Logic overload relays on two-speed starters.

- The catalog number will be alphanumeric. Example:
- Open style, Size 4 two speed starter with Motor Logic SSOLRs
  - Single winding, 460 V, constant or variable torque
  - High speed FLA = 96 A
  - Low speed FLA = 27 A (use Size 2 overload relay)
- Catalog number to order: **8810SF01V02H30H302S**  
 Where:
- Form H30 is a Size 4 contactor with a 45–135 A Motor Logic SSOLR for high speed
  - Form H302 is a 15–45 A Motor Logic SSOLR on the low speed contactor.

**Table 16.324: Special Factory-Assembled Starter Combinations with Motor Logic SSOLR Protection**

NEMA Contactor Size	SSOLR Size						
	00 1.5–4.5 A	0 3–9 A	0 6–18 A	1 9–27 A	2 15–45 A	3 30–90 A	4 45–135 A
00	H308	H30	—	—	—	—	—
0	H308	H309	H30	—	—	—	—
1	H308	H309	H300	H30	—	—	—
2	—	H309	H300	H301	H30	—	—
3	—	—	—	—	—	H30	—
4	—	—	—	—	—	—	H30

**Adapted Bimetallic Overload Relay Forms**

*New!*

**Table 16.325: Adapted Bimetallic Overload Relay for NEMA Type S Starter**

This bimetallic overload relay is available on NEMA Sizes 00, 0 & 1 for Class 8536, 8538, 8539, 8736, 8738 and 8739 devices. To order a starter with the **adapter**, add Form E to the catalog number (8536SBG2V02ES). When ordering with the adapter and bimetallic overload relay installed, use [Table 16.326](#) as a guide.

**Form Description**

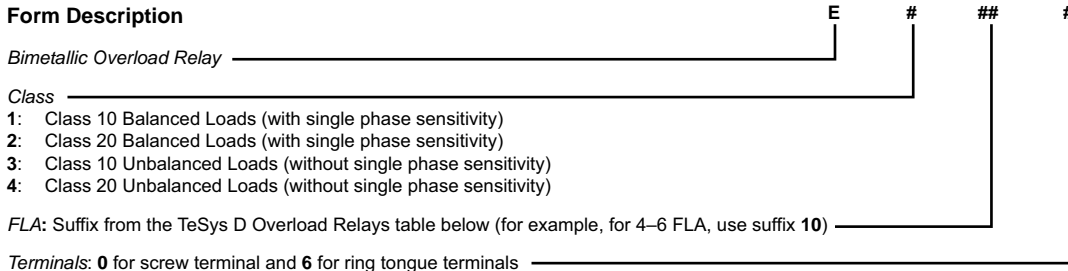

Bimetallic Overload Relay  
 Class  
 1: Class 10 Balanced Loads (with single phase sensitivity)  
 2: Class 20 Balanced Loads (with single phase sensitivity)  
 3: Class 10 Unbalanced Loads (without single phase sensitivity)  
 4: Class 20 Unbalanced Loads (without single phase sensitivity)

FLA: Suffix from the TeSys D Overload Relays table below (for example, for 4–6 FLA, use suffix **10**)

Terminals: **0** for screw terminal and **6** for ring tongue terminals

Sample catalog number: **8536SCO3V02E2160S**

NEMA Size 1 starter controlling a 7.5 hp motor (11 FLA)—Bimetallic overload relay is LRD16L (9–13 FLA)

**Table 16.326: TeSys D Overload Relays for Sizes 00–1 Type S Starters, Non-Reversing and Reversing, Classes 8536, 8538, 8539, 8736, 8738, and 8739**

Current Setting Range Amperes	Class 20 with Single Phase Sensitivity	Class 20 without Single Phase Sensitivity	Class 20 with Single Phase Sensitivity	Class 20 without Single Phase Sensitivity	Factory Installed—Catalog Number Suffix (CP1 List)
	Screw Termination	Screw Termination	Ring Tongue Connector	Ring Tongue Connector	
0.40 to 0.63	LRD04L	LR3D04L	LRD04L6	LR3D04L6	04
0.63 to 1	LRD05L	LR3D05L	LRD05L6	LR3D05L6	05
1 to 1.6	LRD06L	LR3D06L	LRD06L6	LR3D06L6	06
1.6 to 2.5	LRD07L	LR3D07L	LRD07L6	LR3D07L6	07
2.5 to 4	LRD08L	LR3D08L	LRD08L6	LR3D08L6	08
4 to 6	LRD10L	LR3D10L	LRD10L6	LR3D10L6	10
5.5 to 8	LRD12L	LR3D12L	LRD12L6	LR3D12L6	12
7 to 10	LRD14L	LR3D14L	LRD14L6	LR3D14L6	14
9 to 13	LRD16L	LR3D16L	LRD16L6	LR3D16L6	16
12 to 18	LRD21L	LR3D21L	LRD21L6	LR3D21L6	21
17 to 24	LRD22L	LR3D22L	LRD22L6	LR3D22L6	22
23 to 32	LRD32L	LR3D32L	LRD32L6	LR3D32L6	32

**Solid-State TeSys D Overload Relays for Type S Starters**  
**Sizes 00–1, Non-Reversing (Classes 8536, 8538, 8539) and Reversing (Classes 8736, 8738 and 8739)**

**NOTE:**

- **Field installed only:** The LR9D Overload Relay cannot be factory installed—it must be purchased separately and field installed.
- **Single-phase motor applications:** When using the LR9D with a single-phase motor, you must purchase the three-pole starter to accommodate looping of the motor leads.

Current Setting	Overload Relay Catalog Number (sold separately)
Range Amperes	Trip Class 5/10/20/30 Dip Switch Selectable
0.1–0.5 A	LR9D01
0.4–2 A	LR9D02
1.6–8 A	LR9D08
6.4–32 A	LR9D32

**TeSys T Factory Modifications (Forms)**

**Table 16.328: TeSys T Motor Management System Modifications H6xx or H7xx for use with Class 8536 and 8736 (Open Starters)**

Used on Size	Range	Form Control Voltage	
		100–240 Vac	24 Vdc
1	0.4–8 A	H61X [16]	H71X [16]
1	1.35–27 A	H62X [16]	H72X [16]
2, 3	5.0–100 A	H63X [16]	H73X [16]
4	8–160 (CT 300:5 3 turns)	H65X [16]	H75X [16]
5	24–480 A (CT 300:5 1 turn)	H66X [16]	H76X [16]
6	48–960 A (CT 600:5 1 turn)	H67X [16]	H77X [16]

**NOTES:**

- The product configurator must be used to order TeSys T open starters.
- The auxiliary contact for the control of the starter coil has a maximum rating of 240 Vac.

**Table 16.327: Communication Codes**

Communication Network	Code
Modbus	2
Profibus	3
CANopen	4
DeviceNet	5
Ethernet TCP/IP (communication protocols: Ethernet/IP and Modbus/TCP)	6

**Table 16.329: Full Voltage Controllers Only**

Classes 8502, 8536, 8538, 8539, 8702, 8736, 8738, 8739, 8810, 8811 and 8812												
Factory Modifications		Enclosure Type	Form	NEMA Size								
				00	0	1	2	3	4	5	6	7
Power Poles (addition of one)	NEMA Size 1, 30 A, single pole, N.O.	Any	Y428	—	X	X	X [17]	X	X	X	X	X
	NEMA Size 1, 30 A, single pole, N.C.	Any	Y429	—	X	X	X [17]	X	X	X	X	X
	NEMA Size 1, 30 A, double pole, N.O./N.O.	Any	Y430	—	X	X	X [17]	X	X	X	X	X
	NEMA Size 1, 30 A, double pole, N.C./N.C.	Any	Y434	—	X	X	X [17]	X	X	X	X	X
	NEMA Size 1, 30 A, double pole, N.O./N.C.	Any	Y435	—	X	X	X [17]	X	X	X	X	X
	NEMA Size 2, single pole, N.O.	Any	Y436	—	—	—	X [17]	X	X	X	X	X
	NEMA Size 2, single pole, N.C.	Any	Y437	—	—	—	X [17]	X	X	X	X	X
	NEMA Size 2, double pole, N.O./N.O.	Any	Y438	—	—	—	X [17]	X	X	X	X	X
	NEMA Size 2, double pole, N.C./N.C.	Any	Y439	—	—	—	X [17]	X	X	X	X	X
NEMA Size 2, double pole, N.O./N.C.	Any	Y440	—	—	—	X [17]	X	X	X	X	X	
Miscellaneous	Coil transient suppressor (120 V only), per coil.	Any	Y145	X	X	X	X	X	X	X	X	X
	Addition of terminal blocks (specify wired or unwired).		G56 [18]	—	X	X	X	X	X	X	X	X
	Wired, per terminal, each	1, 4, 12	G50 [18]	—	X	X	X	X	X	X	X	X
	Unwired, per terminal, each	1, 4, 12		—	X	X	X	X	X	X	X	X

[16] Where X is the communication option according to Table 16.327 at right (for example, H612).

[17] When adding a power pole to a Size 2 device, also specify **Form Y118** (stronger coil, Size 2 only).

[18] Addition of terminal block Type 9080CA or 9080GR6 only. The number of circuits is the same as the ending of the Form number (example: G505 is a 5–circuit unwired terminal block). Available in groups of 5 only.

**Type S Contactor and Starter Forms**

**Table 16.330: Full Voltage Controllers [19]**

Classes 8502, 8536, 8538, 8539, 8702, 8736, 8738, 8739, and 8810												
Factory Modifications	Enclosure Type	Form	NEMA Size									
			0	1 PW 1 YD	2 PW 2 YD	3 PW 3 YD	4 PW 4 YD	5 PW 5 YD	6 PW 6 YD	7 PW 7 YD		
Control relay (4 and 8 poles)	1, 12	R174	X	X	X	X	X	X	X	X	X	
	4, 4X [20]	R174	X	X	X	X	X	X	X	X	X	
	7, 9	R174	X	X	X	X	X	X	—	—	—	
	1, 12	R178	X	X	X	X	X	X	X	X	X	
	4, 4X [20]	R178	X	X	X	X	X	X	X	X	X	
7, 9	R178	X	X	X	X	X	X	X	—	—		
Pneumatic Timing Relay – specify Class 9050 Type A or B												
0.1 seconds to 1.0 minute—On delay	1	K25	X	X	X	X	X	X	X	X	X	
	4, 4X [20], 12, 3R	K25	X	X	X	X	X	X	X	X	X	
	7, 9	K25	X	X	X	X	X	X	—	—	—	
0.1 seconds to 1.0 minute—Off delay	1	K26	X	X	X	X	X	X	X	X	X	
	4, 4X [20], 12, 3R	K26	X	X	X	X	X	X	X	X	X	
	7, 9	K26	X	X	X	X	X	X	—	—	—	
1.0 to 3.0 minute—On delay	1, 4, 12, 3R	K37	X	X	X	X	X	X	X	X	X	
	4X [20], 7, 9	K37	X	X	X	X	X	X	—	—	—	
1.0 to 3.0 minute—Off delay	1, 4, 12, 3R	K38	X	X	X	X	X	X	X	X	X	
	4X [20], 7, 9	K38	X	X	X	X	X	X	—	—	—	
Solid-state timing relay (specify timing range) and timer (120 V control required)	1, 4, 4X, 7, 9, 12	K1070	X	X	X	X	X	X	X	X	X	
Motor-driven timing relay [21] [22]	1, 4, 12	K5	X	X	X	X	X	X	X	X	X	
Phase failure and phase reversal relay with time delay option including under and over voltage protection.	1, 4, 4X, 7/9, 12, 3R	R44	X	X	X	X	X	X	X	X	X	
Addition of a protective relay with options of phase failure with time delay, phase reversal and under/over voltage protection (RM3TR1). Both motor voltage and control voltage (V8-voltage code) must be specified with device even if Form S is specified. Form replaces Forms Y444, Y445, Y447, Y448 and Y449.												
For multispeed controllers: Compelling relay (requires motor to be started in low speed)	1, 4, 7, 9, 12	R1	X	X	X	X	X	X	X	X	X	
Accelerating relay (provides timed acceleration to selected speed):												
For Class 8810	1, 4, 7, 9, 12	R2	X	X	X	X	X	X	X	X	X	
For Class 8811	1, 4, 7, 9, 12	R2	X	X	X	X	X	X	X	X	X	
For Class 8812	1, 4, 7, 9, 12	R2	X	X	X	X	X	X	X	X	X	
Decelerating relay (imposes a timing delay during transfer from a higher to a lower speed):												
For Class 8810	1, 4, 7, 9, 12	R3	X	X	X	X	X	X	X	X	X	
For Class 8811	1, 4, 7, 9, 12	R3	X	X	X	X	X	X	X	X	X	
For Class 8812	1, 4, 7, 9, 12	R3	X	X	X	X	X	X	X	X	X	
Antiplugging timers and relays	1, 4, 7, 9, 12	R10	X	X	X	X	X	X	X	X	X	
Meters and Metering [23]	Ammeter in cover (includes current transformer if required)	1	G91	X	X	X	X	X	X	X	X	
	Ammeter and switch with two current transformers	1	G92	—	X	X	X	X	X	X	X	
	Ammeter and switch with three current transformers	1	G93	—	X	X	X	X	X	X	X	
	Voltmeter mounted	1	G94	—	X	X	X	X	X	X	X	
	Voltmeter and switch mounted	1	G95	—	X	X	X	X	X	X	X	
	Elapsed time meter	1, 12	G97	X	X	X	X	X	X	X	X	
	Operation counter	1, 12	G99	X	X	X	X	X	X	X	X	
Auxiliary Contacts	Additional starter (contactor) auxiliary contacts (Specify number of additional N.O. or N.C. contacts required per contactor.) Each will be X●● (for example, X01).	Any	X	X	X	X	X	X	X	X	X	
	To determine the maximum number of auxiliary contacts that can be added to each Type S device, and for the appropriate X Form, refer to the tables in the Class 8536 section on page 16-30 (for non-reversing single-speed devices) or the Class 8736 section on page 16-61 (for reversing or two-speed devices). For Class 8600 Reduced Voltage controllers, consult Customer Care Center at 1-888-778-2733.											
	Auxiliary contacts installed on disconnect switch or circuit breaker operating mechanism.											
	SPDT	1, 4, 4X, 12	Y74	X	X	X	X	X	X	X	X	X
	DPDT	1, 4, 4X, 12	Y75	X	X	X	X	X	X	X	X	X
<b>(Note: The above contacts do not switch with the automatic tripping of the circuit breaker. If such operation is required, consult your nearest Schneider Electric sales office.)</b>												
Enclosures	Space heater with N.C. auxiliary contact	1, 4, 4X, 12	G51	X	X	X	X	X	X	X	X	
	Function identification plate, with marking as specified	Any	G11	X	X	X	X	X	X	X	X	
	Drain and breather installed	7 and 9 [24]	Y41	X	X	X	X	X	X	X	—	
	Cover gaskets added to NEMA 1 enclosures:											
	For Classes 8538 and 8539	1	Y47	X	X	Std.	Std.	Std.	Std.	—	—	
	For Classes 8738 and 8739	1	Y47	Std.	Std.	Std.	Std.	Std.	Std.	—	—	
	For other full voltage controllers	1	Y47	X	X	X	X	X	X	X	X	
	For reduced voltage controllers	1	Y47	X	X	X	X	X	X	X	X	
Brushed stainless steel watertight device												
Class 8606	—	Y56	—	—	X	X	X	X	X	X		
Classes 8630 and 8640	—	Y56	—	—	Std.	Std.	Std.	Std.	X	X		

16 NEMA AND DEFINITE PURPOSE CONTACTORS AND STARTERS

[19] NEMA 7 and 9 enclosures are available only with Class 2510, 8502, and 8702 devices.  
 [20] This adder, used with a NEMA 4X enclosure, applies only to Classes 8538, 8539, 8738, 8739, and 8810 non-reversing.  
 [21] If the controller has a control transformer, price that transformer with additional capacity for the relay provided.  
 [22] Specify the control and line voltage.  
 [23] The motor hp and voltage must be specified when placing an order. Meters are panel-mounted in NEMA 12 enclosures.  
 [24] Available only on Spin Top™ and cast aluminum NEMA 7 and 9 enclosures.

Replacement AC Magnetic Coils

Table 16.331: Replacement AC Magnet Coils for Magnetic Contactors and Starters

Equipment To Be Serviced				Coil Prefix, or Class and Type	Hz	Suffix Number (Complete Coil Number Consists of the Prefix or the Class and Type, Followed by the Suffix)										Coil VA				
Device	Size	Type	Poles			24 V	110-115 V	120 V	208 V	220 V	240 V	277 V	380 V	440 V	480 V	550 V	600 V	In-rush	Sealed	
Coils for Present Design Magnetic Contactors and Starters Classes 8502, 8536, 8538, 8539, 8606, 8630, 8640, 8647, 8650, 8651, 8702, 8736, 8738, 8739, 8810, 8811, 8812, 8903, 8910 [1] and 8940 (except NP)	30 A	L	2-6	9998L	60 50	23 24	— 44	44 45	50 52	[2] 53	53 54	55 —	— 60	— 62	62 63	— 65	65 66	150 140	30 30	
			8-12	9998LH	60 50	23 24	— 44	44 45	50 52	[2] 53	53 54	55 —	— 60	— 62	62 63	— 65	65 66	180 170	35 35	
		LX (Latch)	2-4	9998L	60 50	23 24	— 44	44 45	50 52	— 53	53 54	55 —	— 60	— 62	62 63	— 65	65 66	150 140	— —	
			6-12	9998LH	60 50	23 24	— 44	44 45	50 52	— 53	53 54	55 —	— 60	— 62	62 63	— 65	65 66	180 170	— —	
	00	SA [3] (Series B)	All	9998SAC	60 50	23 —	[2] 45	— —	45 —	52 —	[2] 54	54 —	55 —	— 60	62 —	62 —	[2] 65	65 —	165 —	33 —
	00, 0, 1, 1-P, & 30 A	SA (Series A) SB, SC, & SM	All	31041400	60 50	20 22	[2] 42	42 43	48 —	[2] 51	51 53	52 —	56 57	58 60	60 [2]	61 62	62 64	245 232	27 26	
	2 & 60 A	SD & SP	2 & 3	31063409	60 50	16 17	[2] 38	38 39	44 —	[2] 47	47 48	49 —	53 54	[2] 57	57 —	[2] 60	60 61	311 296	37 36	
			4 & 5	31063400	60 50	16 17	[2] 38	38 39	44 —	[2] 47	47 48	49 —	53 54	[2] 57	57 —	[2] 60	60 61	438 429	38 37	
	3 & 100 A	DPA12 <sub>1</sub> , SE, SQ, & SYD138	2 & 3	31074400	60 50	16 17	[2] 38	38 39	44 —	[2] 47	47 48	49 —	53 54	[2] 57	57 —	[2] 60	60 61	700 678	46 47	
			4 & 5	31091400	60 50	— 38	[2] 39	38 39	44 —	[2] 47	47 48	49 —	53 54	[2] 57	57 58	[2] 60	60 61	1185 1260	85 89	
	4 & 200 A	SF, SV, & SYD230	All	31091400	60 50	— 38	[2] 39	38 39	44 —	[2] 47	47 48	49 —	53 54	[2] 57	57 58	[2] 60	60 61	1185 1260	85 89	
			5 & 300 A	SG, SX, & SYD368 Series A [4]	All	31096400	60 50	— 09	[2] 09	09 10	15 —	[2] 18	18 —	19 —	21 22	[2] 24	24 —	[2] 29	29 30	2970 2970
	6 & 7	SH & SJ			2-3	31104418	60 50	— 09	[2] 09	09 —	15 —	[2] 18	18 —	19 —	— 24	[2] 24	24 —	[2] 29	29 —	1780
			1960	59																
	400, 600 & 800 A	SY, SZ, SJ (Elect. Held)	2-3	31104418	60 50	— 09	[2] 09	09 —	15 —	[2] 18	18 —	19 —	— 24	[2] 24	24 —	[2] 29	29 —	1530	—	
																		1250	—	

NOTE: Refer to Table 16.333 for mechanically held unlatch coils.

Table 16.332: Size 5 Coil Modification Kits

Catalog Number	Voltage
9998SG120	120 V
9998SG208	208 V
9998SG240	240 V
9998SG277	277 V
9998SG380	380 V
9998SG480	480 V

NEMA Size 5, Type S, E-Coil Modification Kit for Series A Devices

Applies to Classes 8502, 8536, 8538, 8539, 8606, 8630, 8640, 8647, 8650, 8651, 8702, 8736, 8738, 8739, 8810, 8811, 8812, 8910 and 8903. Consists of:

- E-coil (31096320\*\* from Table 16.331).
- Armature
- 15 A, 600 V fuse and holder (Class 9999SFR)
- Bottom magnet
- Instruction material

NOTE: No 600 V coil nor mechanically held lighting contactor.

[1] For 8910DPA1 to DPA9, see page 16-90.

[2] Use a 60 Hz coil of the next higher voltage.

[3] Use on Type S Series B devices only.

[4] Size 5 Series A devices should use these only as replacements for the exact part number. Another option is to use the coil modification kits in Table 16.332 for the Series B coil.



Relays, Timers, and Contactors

Table 16.333: Replacement AC Magnet Coils for Relays, Timers, and Contactors

Equipment To Be Serviced			Coil Prefix or Class and Type	Hz	Suffix Number (Complete Coil Number Consists of Prefix or Class and Type Followed by Suffix Number)												Coil VA	
Device	Type	Poles			24 V	110-115 V	120 V	208 V	220 V	240 V	277 V	380 V	440 V	480 V	550 V	600 V	In-rush	Sealed
Classes 8501 and 9050																		
8501 (Relays)	X	All	9998X [5]	60 50	23 24	— 44	44 —	51 52	52 53	53 —	55 —	— 62	62 —	— 65	65 —	148 143	23 25	
9050 (Timer)	A	All	2959-S49-	60 50	W25A W25B	W31B W32A	W32A W32B	W34A W34B	W34B W35A	W35A W35B	W35B W36A	— W37B	W38A W38B	W38B W39A	W39A W39B	74 68	17 17	
	B [6]	All	31017-400-	60 50	33 34	— —	54 55	61 —	61 63	63 64	65 —	— 70	72 73	73 75	75 76	165 155	27 27	
Mechanically Held Unlatch Coils—Classes 8508 and 8903																		
NOTE: A latch coil is also used with mechanically held devices. For selection, see Table 16.331.																		
8903 (Lighting Contactors)	LX	All	9998LX	60 50	23 —	— 44	44 —	51 —	— 53	53 —	55 —	— 62	62 —	— 65	65 —	25 —	— —	
	SM, SP	All	2959-S13	60 50	W23B W24B	W30B W30B	W33A W31B	— W33B	W33B W34B	W34A —	— W36A	W36B W36B	W37B W37B	W37B —	80 —	— —	— —	
	SQ, SV, SX, SY, SZ	All	31096-416	60 50	03 —	[7] 09	09 —	15 —	[7] 18	18 —	20 —	— 22	[7] 24	24 —	[7] 28	28 —	550 —	— —
	SJ	All	31123-403	60 50	03 —	[7] 09	09 —	15 —	[7] 18	18 —	20 —	— 22	[7] 24	24 —	[7] 28	28 —	2100 —	— —

Table 16.334: Replacement DC Magnet Coils for Magnetic Relays and Timers

Equipment To Be Serviced			Coil Prefix or Class and Type	Suffix Number (Complete Coil Number Consists of Prefix or Class and Type Followed by Suffix Number.)												Coil Burden Watts	
Class	Type	Poles		6 V	12 V	18 V	24 V	32 V	48 V	64 V	72 V	90 V	110 V	115/125 V	220 V		230/250 V
8501 (Relays)	XD	All	9998XD	19	28	34	37	40	46	49	52	55	—	58	—	67	18
	XDL	—	9998XDL	19	28	34B	37B	40B	46B	49B	52B	55B	—	58B	—	67B	50
	XUD	All	9998XUD	19	28	—	37	—	46	—	—	—	—	58 [8]	—	67 [8]	16
9050 (Timers)	C	—	31018-400-	22	31	—	40	—	49	—	—	—	—	61	—	70	14
	H	—	4491S1	W21	W24	—	W27	—	W30	—	—	—	—	W34	—	W37	14

Table 16.335: Replacement Coil for 8903 Panel Board Lighting Contactors

Class	Type	Replacement Solenoid	Catalog Number
8903	PB	120 V	9998PBV02
		208 V	9998PBV08
		240/277 V	9998PBV39
		480 V	9998PBV28

[5] To order an unlatch coil, add L to the Type number and B to the suffix. Example: For a 120 V 60 Hz unlatch coil, order 9998XL44B.  
 [6] Series C (double pole) and Series E (single pole).  
 [7] Use a 60 Hz coil of the next higher voltage.  
 [8] Not dual rated. 125 Vdc or 250 Vdc only.

**Contactor and Starter Replacement Part Kits**

Class 9998 replacement parts kits are available for servicing Square D relays, contactors, and starters as well as pressure, vacuum, and float switches. Each kit contains the necessary movable and stationary contacts, contact springs (when required)—NEMA Size 3 and above do not include contact springs, and springs are not available), and additional hardware required to service the devices listed below. When servicing devices having more poles than contained in the corresponding kit, it may be necessary to order an additional kit.

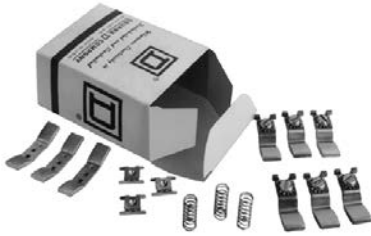

**Table 16.336: Magnetic Contactor and Starter Contact Kits for Present Designs**

Equipment To Be Serviced			No. of Poles in Kit	Class 9998 Parts Kit Type No.	
Class	Type	NEMA Size or Ampere Rating			
8502 8536 8538 8539 8547 8549 8606 8630 8640 8647 8702 8736 8738 8739 8810 8811 8812 8940	SA- (Series B)	00	3	SL1	
	SB-	0	3	SL2	
	SB-, SC-(Power Pole Adder)	0 & 1	4	SL12	
	SC-	1 & 1P	1	3	SL22
		1	4	SL3	
		1	4	SL13	
	SD-	2	3	SL4	
		2	4	SL14	
	SD-(Power Pole Adder)	2	1	SL24	
	SE-	3	2	SL6	
		3	2	SL7	
	SF-	4	2	SL8	
		4	3	SL9	
	SG-	5	2	SL10	
	5	3	SL11		
SH-	6	2	SL25		
	6	3	SL26		
SJ-	7	2	SL30		
	7	3	SL31		
8903	L (Series C) & LX (Series B)	30 A	4	RA5B	
	SM-	30 A	3	SL3	
		30 A	4	SL13	
	SP-	60 A	3	SL4	
		60 A	4	SL14	
	SQ-	100 A	2	SL6	
		100 A	3	SL7	
	SV-	200 A	2	SL8	
		200 A	3	SL9	
	SX-	300 A	2	SL10	
		300 A	3	SL11	
	SY-	400 A	2	SL25	
		400 A	3	SL26	
	SZ-	600 A	2	SL32	
		600 A	3	SL33	
SJ-	800 A	2	SL30		
	800 A	3	SL31		
PBM, PBP	30, 60 A	2	PB2		
PBN, PBQ	75, 100 A				
PBM, PBP	30, 60 A	3	PB3		
PBN, PBQ	75, 100 A				
PBR, PBV, PBW	150, 200, 225 A	2	PB14		
PBR, PBV, PBW	150, 200, 225 A	3	PB15		

**Table 16.341: Magnetic Contactor and Starter Contact Kits for Obsolete Designs**

Equipment To Be Serviced			No. of Poles in Kit	Class 9998 Parts Kit Type No.
Class	Type	NEMA Size		
8502 & 8536[2]	SA-, (Series A)	00	3	SL2
			4	SL12
8903	LL, L (Series A, B) & LX (Series A)	20 A	4	RA5

**Table 16.337: Class 8965 Replacement Contact Kits**

Device Type	Device Series	Class 9998 Kit Type	Device Series	Class 9998 Kit Type
DPR53	A	DRC5 [1]	—	—
DPR63	A	DRC6 [1]	—	—
RO10	A & B	RA10	C	RA14
RO11	A & B	RA11	C	RA15
RO12	A & B	RA12	C	RA16
RO13	A & B	RA13	C	RA17

**Table 16.338: Manual Starter Contact Kits**

Equipment To Be Serviced			No. of Poles in Kit	Class 9998 Parts Kit Type No.
Class	Type	NEMA Size		
2510 Manual Starters	M-, T-	M-0	3	ML1
		M-1 & M-1P	3	ML2

**Table 16.339: Replacement Control Transformers (150 VA) Class 8502, 8536 Type S Size 6**

Voltage		Part Number
60 Hz	50 Hz	
240/480-120	220/440-110	3110451250
208-120	—	3110451252
277-120	—	3110451253
—	380-110	3110451254
600-120	550-110	3110451251
120-120	110-110	3110451255
240-120	220-110	3110451256

**Table 16.340: Replacement Control Transformers (200 VA) Class 8502, 8536 Type S Size 7**

Voltage		Part Number
60 Hz	50 Hz	
240/480-120	220/440-110	3112350150
208-120	—	3112350152
277-120	—	3112350153
—	380-110	3112350154
600-120	550-110	3112350151
120-120	110-110	3112350155
240-120	220-110	3112350156

**Table 16.342: Class 8910, 8911 & 8965 Replacement Contact Kits**

Device To Be Serviced			Class 9998	
Class 8910 Type	Class 8911 Type	Series	1-Pole Type	3-Pole Type
SYD138	—	—	—	SL27
SYD230	—	—	—	SL28
SYD368	—	—	—	SL29
DPA_50A	DPSO5_	A, B	DRC5	—
DPA_60A	—	A, B	DRC6	—
DPA_75A	—	A	DRC7	—
DPA_90A	—	A	DRC9	—

**Table 16.343: How to Order**

To Order Specify:	Catalog Number	
• Class Number	Class	Type
• Type Number	9998	SL6

[1] Single-pole kits.

[2] Includes reversing, two-speed, and similar devices. Select the coil based on the NEMA size of the basic starter or contactor.



Class 9998 Type SO1

**Contact Units for Melting Alloy Overload Relays**

One normally closed contact, Class 9998 Type SO1, is provided in each overload relay block on Type S starters Sizes 00-6. The Class 9998 Type SO1 contact unit listed in Table 16.344 is provided as standard in each Class 9065 melting alloy overload relay. Contact modules can be easily replaced and are identified in Table 16.344. Isolated overload relay alarm circuit contacts are available as an optional feature. A pilot light or alarm bell can be wired in series with this contact to indicate that the overload relay has tripped. For further information on isolated alarm contacts refer to Class 9999 Types SO4 and SO5, page 16-129.

**Table 16.344: Class 9998 Type SO1 Contact Units for Melting Alloy Overload Relays**

Magnetic Starter			Description [3]	Parts Kit Number
NEMA Size	Type	Series		
00-4 and 6	SA-SF SH	A & B	Standard N.C. contact unit	Class 9998 Type SO1[4]

**Class 9998 Type UB Universal Baseplate**

A universal baseplate may be used to retrofit a Square D Type S NEMA starter into an application which is currently using a competitive NEMA starter. The universal baseplate is a metal plate which attaches to the panel in the location of the starter to be replaced. The Type S starter then mounts to the baseplate. It is available for NEMA Sizes 00 through 4, and mounting screws are provided with each plate.

The universal baseplate adapter allows the Type S starter to replace the competitive starters in Table 16.345:

**Table 16.345: Competitive Starter Replacement**

Competitor Starter	NEMA Size	Base-plate	NEMA Size	Base-plate	NEMA Size	Base-plate	NEMA Size	Base-plate
Allen Bradley 509	0, 1	UB01	2	UB02	3	UB03	4	UB04
Allen Bradley 709	1		2		3		4	
Cutler Hammer Freedom Series	00, 0, 1		2		3		4	
Furnas ESP100	0, 1		2		3		4	
Furnas INNOVA	0, 1		2		3		4	
General Electric CR306	00, 0, 1		2		3		4	
Telemecanique "A" Line and Pre-type "S"	0, 1	UB11	2	UB12	3	UB13	4	UB14

**Melting Alloy Overload Relay Jumper Strap Kits**

Jumper strap kits are for use on three-phase manual or magnetic starters with melting alloy overload relays only, where a three-phase starter is used to control a single-phase motor. These kits will include two jumper straps, a wiring diagram showing how to wire a three-phase starter to control a single-phase motor, and single-phase (one thermal unit) selection tables.

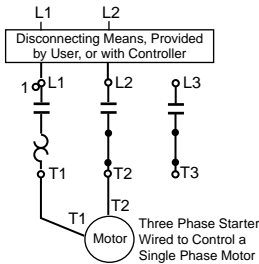

**Table 16.346: Melting Alloy Overload Relay Jumper Strap Kits**

Class	For Starter		Class 9998 Kit Type [5]
	Size	Type	
ALL	00, 0, 1, 2 and M0 & M1	SA, SB, SC, SD and M & T (Manual)	SO31
	3,4	SE, SF	SO32
	5	SG	None Available

**Table 16.347: How to Order**

To Order Specify:	Catalog Number	
• Class Number	Class	Type
• Type Number	9998	UB01

[3] Refer to page Table 16.351 for contact ratings.  
 [4] The Type SO1 is also the replacement contact unit for Class 9065 Type M melting alloy overload relays.  
 [5] CP1 discount schedule.

**Cover-Mounted Control Unit Selection**

Class 9999 push button, selector switch and pilot light cover-mounted control unit kits can be easily field installed in a NEMA 1, 3R, 4 or 12 Type S contactor or starter enclosure cover. Knockouts or removable closing plates are furnished with many enclosure covers for convenient field installation of control units. Kits are supplied with leads and clearly illustrated instructions. The Class 9999 cover mounted control unit kits are identical to the units which are factory installed.

**Table 16.348: Cover-Mounted Control Unit Selection**

For Use With					NEMA 1 Kit 8538, 8539, and 8903 Pre-Series K				NEMA 1 and 12/3R Kit 8538, 8539, and 8903 Series K and Later [1]			NEMA 4/4X Kit (Stainless)[1]							
Class	Type	NEMA Size or Ampere Rating	No. of Poles	V	Red or Green Pilot Light[2]		Push Button		Selector Switch		Red or Green Pilot Light	Push Button	Selector Switch	Red or Green Pilot Light	Push Button	Selector Switch			
					With Control Transformer (Form F4T)	Standard	Start-Stop	On-Off	Hand-Off-Auto	On-Off	120 V 60 Hz	Start-Stop or On-Off	Hand-Off-Auto	120 V 60 Hz	Start-Stop or On-Off	Hand-Off-Auto			
					Type	Type	Type	Type	Type	Type	Type	Type	Type	Type	Type	Type			
8502 & 8536	SA, SB, SC	00, 0, 1, 1P	All	6-60 V 50-60 Hz	SP28R [3]	SP2R	SA2	SA10	SC2	SC22	SP28R [2] [3] (incandescent)	SA3[4]	SC8	SP29R [2] [3] (incandescent)	SA13	SC9			
	SD	2	All		SP28R [3]	SP3R													
	SE	3	2-3		SP28R [3]	SP4R													
			4-5		SP28R [3]	SP5R													
	SF	4	All		SP28R [3]	SP28R [3]	SA3	SA3	SC8	—							SPL28R (LED-Red)	SPL29R (LED-Red)	SPL29G (LED-Green)
SG-SJ	5-7	All	SP28R [3]		SP28R [3]	SA3	SA3	SC8	—										
8538 & 8539	SB, SC	0, 1	All		SP12R	SP12R	SA2	SA10	SC2	SC22				SPL28G (LED-Green)	SA3[4]	SC8	SPL29G (LED-Green)	SA13	SC9
	SD	2	All		SP13R	SP13R													
	SE	3	All		SP14R	SP14R													
	SF	4	All		SP15R	SP15R													
	SG-SJ	5-7	All		SP28R [3]	SP28R [3]	SA3	SA3	SC8	—									
8702 & 8736	L	20 A	All		SP28R [3]	—	—	SA10 [6]	—	SC22 [6]									
	SM	30 A	All		SP28R [3]	SP2R	SA2 [4]	SA10 [4]	SC2	SC22									
	SP	60 A	All		SP28R [3]	SP3R	SA3 [4]	SA3 [4]	SC8	—									
	SQ	100 A	All		SP28R [3]	SP28R [3]	SA3 [4]	SA3 [4]	SC8	—									
	SJ, SV, SX, SY, SZ	200-800 A	All	SP28R [3]	SP28R [3]	SA3 [4]	SA3 [4]	SC8	—										

**NOTE:** Field modification kits are **not** available for the polyester enclosures.

**Table 16.349: NEMA 1 Enclosure Closing Plates**

For Use With				
Class	Type	NEMA Size or Ampere Rating	Description	Type
8502, 8536, 8903	SA-SE or SM-SP	00-3 or 30-60A	For Pilot Light or Reset—Slip-on Cover NEMA 1 Enclosure	SG2
			For Push Button or Selector Switch—Slip-on Cover NEMA 1 Enclosure	SG3
8538 & 8539 Pre-series "K"	SB-SF	0-4	For Push Button or Selector Switch—Hinged Cover NEMA 1 Enclosure	SG1
			For Pilot Light—Hinged Cover NEMA 1 Enclosure	SG2
8538, 8539 Series J and later	SB-SF	0-4	Push Button or Pilot Light NEMA Combination Starter	9001K51
8903	SM-SV	30-400 A	Combination Lighting Contactor	9001K51

**Table 16.350: How to Order**

To Order Specify:	Catalog Number	
• Class Number	Class	Type
• Type Number	9999	SP29R



[1] User-made openings are required in order to field install these modification kits on standard Class 8502 and 8536 Type S Sizes 0-2, and Class 8903 Sizes 30-60 A, NEMA 4 and 12 enclosures.  
 [2] Each pilot light kit contains one red and one green lens cap.  
 [3] The coil voltage must be the same as the pilot lighting rating. The kit contains one 60 Hz red pilot light control unit, Class 9001 Type KP1R31120V. For other voltages, refer to Class 9001 Type KP.  
 [4] Also requires an N.O. auxiliary contact for the holding circuit contact when used on Class 8903 electrically held lighting contactors.  
 [5] For control unit kits for Class 8903 mechanically held contactors, refer to Mechanically Held, page 16-81.  
 [6] To mount a control unit in a NEMA 1 enclosure, a Class 9999 Type BLX bracket is also required.

## Auxiliary Contacts for Manual and Magnetic Contactors and Starters

### Internal Contacts



Internal Auxiliary

Class 9999 Type SX11 internal contact kit is a replacement unit for the N.O. holding circuit contact supplied as standard on Type S Sizes 00–2 three phase starters and contactors. The Class 9999 Type SX12 is a replacement unit for the N.C. electrical contact which is furnished as standard on Type S, Sizes 00–2 mechanically interlocked devices (e.g., Class 8736 reversing starters). Internal contacts are also used on Class 2510 Types M & T manual starters. The internal contacts can be used for other applications as long as the electrical rating is not exceeded. See Table 16.351 for electrical ratings.



External Single-Circuit Auxiliary Contact

### External Contacts

Class 9999 Type SX6 external auxiliary contact is supplied as standard for the N.O. holding circuit contact on Type S Sizes 3–7 starters and contactors. Additional auxiliary contacts can be added to Type S contactors, starters and lighting contactors. These contacts mount on either side of the basic contactor and are available with convertible or non-convertible contacts. The contacts of the convertible version can be changed from N.O. to N.C. or vice versa in the field. The non-convertible version has fixed contacts, either N.O. or N.C.

To determine the number of auxiliary contacts that can be added to each Type S contactor or starter, refer to the Class 8536 or Class 8736 section.

See Table 16.351 for electrical ratings.

**Table 16.351: Maximum Ratings for Type S Auxiliary Contacts and Timers**

Class 9999 Type	Contact Ratings				Class 9999 Type	Contact Ratings			
	Volts AC	AC Only (35% Power Factor)		Continuous		Volts AC	AC Only (35% Power Factor)		Continuous
		Make	Break				Make	Break	
SX11, SX12	120 or Less	30 A	3 A	3 A	SX6-SX10 SX13-SX17	120 or Less	60 A	6 A	10 A
	120-600	3600 VA	360 VA	3 A		120-600	7200 VA	720 VA	10 A

**Table 16.352: Class 8502, 8536 and 8903 Type S**

For Use With		Kit Description	Ordering Information
Type	NEMA Size		Class 9999 Type
<b>External—Field Convertible</b>			
SA-SJ	00–7	1-N.O. Contact	SX6
		1-N.C. Contact	SX7
		1-N.O. and 1-N.C. Isolated Contacts	SX8
		1-N.O. Overlapping Contact	SX9 [7]
		1-N.C. Overlapping Contact	SX10 [7]
<b>External—Non-Convertible</b>			
SA-SJ	00–7	1-N.O. Contact	SX13
		1-N.C. Contact	SX14
		1-N.O. & 1 N.C. Isolated Contacts	SX15
		1-N.O. Overlapping Contact	SX16 [7]
		1-N.C. Overlapping Contact	SX17 [7]
<b>Internal—Non-Convertible</b>			
SA-SD	00–2	1-N.O. Contact	SX11 [8]
		1-N.C. Contact	SX12 [8]

**Table 16.353: Class 8965 Reversing/Hoist Contactors—Auxiliary Contacts**

Device To Be Serviced	Auxiliary Contact Kit		
Class 8965 Type	Contact Arrangement	Type of Connector	Class 9999 Type
DPR	1 N.O.	Screw/ Quick-Connect	D10
	1 N.C.		D01
	1 N.O./1 N.C.		D11
	2 N.O.		D20
RO2 & RG2 RO10 Form X1 RO11 Form X1	1 N.O. each side	Slip-on	R10
RO3 & RG3 RO10 Form X2 RO11 Form X2	1 N.C. each side		R11
RO5 & RG5 RO12 Form X1 RO13 Form X1	1 N.O. each side	Screw	R12
RO6 & RG6 RO12 Form X2 RO13 Form X2	1 N.C. each side		R13

**Table 16.354: Class 8910 and 8911 Definite Purpose Contactors and Starters—Auxiliary Contacts**

Device To Be Serviced	Auxiliary Contact Kit		
	Contact Arrangement	Class 9999	
		Series B (20-90 A)	Series C (20-40 A)
DPA DPS	1 N.O.	D10	DD10
	1 N.C.	D01	DD01
	1 N.O./1 N.C.	D11	DD11
	2 N.O.	D20	DD20

**Table 16.355: How to Order**

To Order Specify:	Catalog Number	
• Class Number	Class	Type
• Type Number	9999	SX6

[7] Types SX9 and SX10 or Types SX16 and SX17 must be used together and mounted on the same side of the contactor. They are suitable for applications where it is necessary for a normally open contact to overlap a normally closed contact.

[8] Types SX11 and SX12 are not for use on NEMA Sizes 3 or larger. Internal contacts can also be used on Class 2510 Types M and T manual starters.

**Table 16.356: Isolated Auxiliary Contacts for Motor Logic Overload Relays**

For Use With		Parts Kit Description	Class 9999 Type
Class & Type	NEMA Size [9]		
8536 SA-SJ	00B through 7	N.O. or N.C. Auxiliary Contact (Field Convertible)	AC04
9065 SS, SR, SF, ST	00B through 7		

**Table 16.357: DIN Adapter**

For Use With		Parts Kit Description	Class 9999 Type
Class & Type	NEMA Size [9]		
9065 SS or SF	00B, 00C, 0, and 1	DIN Adapter	DA01

**Table 16.358: Lug-Lug and Lug-Extender Kits**

For Use With		Parts Kit Description	Class 9999 Type
Class & Type	NEMA Size [9]		
9065 SS or SF	00B, 00C, 0, and 1	Lug-Lug Kit for separate mounting	LL0
9065 SS or SF	00B, 00C, 0, and 1	Lug-Extender Kit for retrofitting existing NEMA S starters	LB0

**Motor Logic—Class 9999**

**Isolated Auxiliary Contacts for Motor Logic Overload Relays**

Overload relay auxiliary contacts are available factory installed or in kit form for field installation on Motor Logic overload relays. These contacts may be used for isolated alarm contact applications.

**DIN Adapter**

The DIN adapter provides a method to mount the Motor Logic overload relay to a 35 mm DIN rail.

**Lug-Lug and Lug-Extender Kits**

A Class 9999 LL0 Lug-Lug Kit can be field installed on separately mounted overload relays. The standard Size 00B, 00C, 0, and 1 Class 9065 Type SS and SF overload relays are supplied without lugs. A Class 9999 LB0 Lug-Extender Kit is designed for Size 00B, 00C, 0, and 1 Retrofit Starter Applications. This kit allows the lugs to be in the same location as the Class 9065 melting alloy overload relay, eliminating the need for additional wire length.

**Remote Reset Module**

The Remote Reset Module can be easily field installed on solid-state overload relays. This module will allow the overload relay to be reset from a remote location.

**Table 16.359: Remote Reset Module**

For Use With		Parts Kit Description	Class 9999 Type
Class and Type	NEMA Size [9]		
536 SA-SJ	00B through 7	Remote Reset Module	RR04 [10]
9065 SS, SR, SF, ST	00B through 7		
8536 SE-SF	3 and 4	Top Mounting Bracket	RB34 [10] [11]
9065 SS, SR, SF, ST	3 and 4		

**Power Pole Adders**

One single- or double-circuit power pole kit can be field added to a basic two- or three-pole Type S contactor or starter Sizes 0, 1 and 2, or lighting contactors 30–60 A. See Table 16.360 for selection. The ratings for these power pole adders correspond to the NEMA contact ratings found on page 16-122. A two- or three-pole contactor or starter accepts only one single- or double-circuit unit. A power pole cannot be used on four- or five-pole devices, or on devices that are mechanically interlocked.

When adding a power pole to a Size 0 or 1 device, remove the return springs according to the instructions that come with the device.

When adding a power pole to a Size 2 or 60 A device, a coil change is required. Select a four- or five-pole coil from page 16-122, or specify Form Y118 as noted in the footnote below.

When adding Size 0–2 power pole kits to a Size 3–7 or 100–800 A device, an adapter bracket (9999 SBT1) is required. The Class 9999 Types SB6–SB15 power pole kits are suitable for copper wire only. Types SB21–SB25 come with lugs suitable for copper or aluminum wire.

**Table 16.360: Power Pole Adders—Selection**

For Use With		Power Pole Adder Kit	
Type	Size	Description	Class 9999 Type
SB, SC, and SM	0, 1, and 30 A	One N.O. power pole adder	SB6
SD	2		SB11 [12]
SP	60 A		SB21 [12]
SB, SC, and SM	0, 1, and 30 A	One N.C. power pole adder	SB7
SD	2		SB12 [12]
SP	60 A		SB22 [12]
SB, SC, and SM	0, 1, and 30 A	One N.O. and one N.C. power pole adder	SB8
SD	2		SB13 [12]
SP	60 A		SB23 [12]
SB, SC, and SM	0, 1, and 30 A	Two N.O. power pole adders	SB9
SD	2		SB14 [12]
SP	60 A		SB24 [12]
SB, SC, and SM	0, 1, and 30 A	Two N.C. power pole adders	SB10
SD	2		SB15 [12]
SP	60 A		SB25 [12]
SE-SJ and SQ-SZ and SJ	3–7 and 100–800 A	Adapter bracket	SBT1



Class 9999 Type SB6 Single Power Pole Adder



Class 9999 Type SB9 Double Power Pole Adder

[9] Size 00B and 00C are not actual NEMA sizes. These designations are used to differentiate the lower FLA of these devices from the NEMA Size 00 Motor Logic solid-state overload relay.

[10] 120 Vac power required.

[11] For mounting the remote reset module on the top of the overload relay.

[12] To order a Size 2 or 60 A power pole kit complete with a new starter coil, specify Form Y118, the voltage, and the frequency (for example, Class 9999 Type SB11 Y118, 120 V, 60 Hz).



Class 9999 Type SF4 Fuse Kit

**Control Circuit Fuse Holder**

The control circuit fuse holder is designed to be used on Type S contactors and starters, Sizes 00–7, when either one or two control circuit fuses, 600 V maximum, are required. The Type SF3 and SF4 fuse holders will accept standard 600 V Bussmann Type KTK or equivalent fuses (13/32" x 1-1/2"); 6 A maximum. The SFR3 and SFR4 will accept Class CC 600 V Bussmann Type KTK-R or equivalent fuses only.

**Table 16.361: Control Circuit Fuse Holder—Selection**

Description (fuses not included)	Class 9999
	Type
Single Fuse Unit	SF3
Single Fuse Unit for Class CC Fuse	SFR3
Two Fuse Unit	SF4
Two Fuse Unit for Class CC Fuses	SFR4



Class 9999 Type ST1 Transient Suppression Module

**Transient Suppression Module**

The transient suppression module is designed to be used where the transient voltage, generated when opening the coil circuit, interferes with the proper operation of nearby integrated or solid-state control circuits. The module consists of an RC circuit and is designed to suppress the coil voltage transients to approximately 200% of peak coil supply voltage. The module is wired across the coil for Type S, Sizes 00–5 and is designed for coil voltages of 120 V only.

**Table 16.363: Transient Suppression Module—Selection**

Description	Class 9999
	Type
For Sizes 00–2	ST1
For Sizes 3–5	ST2

**Table 16.362: How to Order**

To Order Specify:	Catalog Number	
• Class Number	Class	Type
• Type Number	9999	SM1



Type SO4

**Isolated Alarm Contacts For Melting Alloy Overload Relays**

Isolated overload relay alarm contacts are available factory-installed or in kit form for field installation in NEMA Size 00–6 Type S [13] starters, and Class 9065 Type SE melting alloy overload relays. NEMA Size 7 Type S devices use a solidstate overload relay which has isolated alarm contacts as a standard feature. The alarm contacts allow the starter to be used in applications that require isolated contacts, such as inputs to a computer.

Class 9999 Types SO4 and SO5 modules are interchangeable with the standard module (Class 9998 Type SO1) and can be installed on starters already in service. The case is made of clear plastic (polycarbonate) to allow for visual inspection of contacts.

**Table 16.364: Contact Unit for Melting Alloy Overload Relays**

Magnetic Starter		Parts Kit Description	Class 9999 Type
NEMA Size	Type		
00-6 [13]	SA-SH	N.O. Isolated Alarm Contact Plus Standard N.C. Overload Contact	SO4
		N.C. Isolated Alarm Contact Plus Standard N.C. Overload Contact	SO5

**Solid Neutral**

The Class 9999 Type SN kit can be used on Class 8903 Type S lighting contactors and other controllers where field addition of a solid neutral is required. Each kit has lugs suitable for both copper and aluminum wire, and mounts with two screws.

**Table 16.365: Solid Neutral Selection**

Number of Lugs	Wire Capacity Per Lug (Cu/Al)	Class 9999
		Type
4	14–2/0	SN1
3	one 4–600 MCM or two 1/0–250 MCM	SN2
3 (Dual)	two 2–600 MCM	SN3
2 (Dual)	two 6–350 MCM	SN4

**Tie Point Terminal Block**

The tie point terminal block provides easy wiring of a Hand-Off-Auto selector switch or Start-Stop push buttons with separate control. The T7 terminal block requires no panel space. It simply snaps on Sizes 00–4 Type S contactors and starters by two tabs and is secured to the left hand coil terminal.

**Table 16.367: Tie Point Terminal Block Selection**

Magnetic Contactor or Starter		Class 9999 Type
NEMA Size	Type	
00–4	SA-SF	T7



Tie Point Terminal Block

**Table 16.366: How to Order**

To Order Specify:	Catalog Number	
• Class Number	Class	Type
• Type Number	9999	SO4

[13] Isolated alarm contacts **cannot** be added in the field to the Size 5 Type S starter. Current transers and a Size 1 overload block must be used. For factory installation specify **Form Y342**.



Type SM1



Type SM12

### Mechanical Interlock

**General:** Type S contactors or starters can be mechanically interlocked so that only one device is energized at a time. The mechanical interlock is an interference (non-jamming) type, locking at the beginning of the stroke of any starter or contactor.

**Type S Sizes 00, 0, 1, and 2—**The mechanical interlock is mounted on the underside of the reversing baseplate. Two pins extend from the mechanical interlock through openings in the baseplate and engage the contact carrier of each contactor. Two styles of mechanical interlocks are used: one version for three pole contactors, a different version for four or five pole contactors. *When adding a power pole to the left side of an existing Size 0, 1, or 2 three-pole reversing contactor, a new mechanical interlock must also be installed. When added to the right side only, the power pole is not mechanically interlocked with the left-hand contactor.*

**Type S Sizes 3 and 4—**The mechanical interlock is separate from the mounting pan on Sizes 3 and 4. Cams on the mechanical interlocks are operated by the contact carrier of each contactor. The mechanical interlock is attached to the underside of the two contactor baseplates on Sizes 3 and 4.

**NOTE:** The mechanical interlock kits in Table 16.368 can be used to interlock 2–5 pole contactors. Mechanical interlocks for horizontal and vertical arrangement are listed in various pole arrangements. Mechanical interlock Types SM1 through SM10 for Sizes 00-2 devices use overload relay mounting brackets to support the overload relay portion of the starter. See Table 16.369.

Table 16.368: Mechanical Interlock for Two Contactors

		Contactor NEMA Size	Class 9999 Type	
<p>Horizontal Type SM1 for Size 00–1 Type SM6 for Size 2 Type SM12 for Sizes 3 &amp; 4</p>	<p>Horizontal Type SM2 for Size 0 or 1<sup>[14]</sup> Type SM7 for Size 2 Type SM12 for Sizes 3 &amp; 4</p>	00, 0, 1	SM1	
		0, 1	SM2	
		0, 1	SM3	
		0, 1	SM4	
		0, 1	SM5	
<p>Horizontal Type SM3 for Size 0 or 1 Type SM8 for Size 2 Type SM12 for Sizes 3 &amp; 4</p>	<p>Vertical Type SM4 for Size 0 or 1 Type SM9 for Size 2 Type SM11 for Size 3 Type SM13 for Size 4</p>	<p>Vertical Type SM5 for Size 0 or 1 Type SM11 for Size 3 Type SM13 for Size 4</p>	2	SM6
			2	SM7
			2	SM8
			2	SM9
			2	SM10
			3	SM11
			3, 4	SM12
			4	SM13



Overload Relay Mounting Bracket

Table 16.369: Overload Relay Mounting Bracket

Kit Description	Class 9999 Type
Bracket for one overload relay used with horizontal mechanical interlocks, Types SM1 through SM10	SO11
Bracket for two overload relays used with vertical mechanical interlocks, Types SM2, SM4, SM5, SM9 and SM10	SO12

Table 16.370: How to Order

To Order Specify:	Catalog Number	
	Class	Type
<ul style="list-style-type: none"> <li>Class Number</li> <li>Type Number</li> </ul>	9999	SM1

[14] The Type SM2 interlock is factory assembled for horizontal mounting, but can easily be converted to vertical mounting. Conversion instructions are included.



**Fuse Block Replacement Parts Kits**

Class 8538 (Series D and newer), Class 8738 (Series E and newer), and Class 8903 (Series C and newer) Type S non-fusible combination starters and lighting contactors (sizes 0–2, 30 to 60 A) can be converted to the fusible type by installing a Class 9422 Fuse Clip Kit. Both fusible and non-fusible combination devices have the same size enclosure in NEMAs 1, 4, and 12 construction, which permits this conversion. The 9422 Fuse Clip Kits contain line and load fuse clips, load base, and fuse pullers.



Class 9422 TC33 Fuse Block



Class 9999 Type TC10

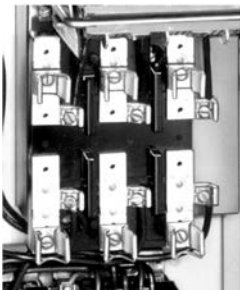

Class 9999 Type S2 Interchangeable Fuse Clips

**Table 16.371: Class 9422 Replacement Fuse Clip Kits**

Device Used on	Disconnect Ampere Rating	NEMA Class H, K, J, R Fuses		Class and Type	Class R Fuse Clip Kits
		Fuse Clip Ratings (A)			
Size or Ampere Rating		250 V Max.	600 V Max.		
0, 1, and 30 A	30	0–30	—	9422TC30 [15]	RFK03 [16]
0, 1, and 30 A	30	31–60	0–30	9422TC33 [15]	RFK06 [16]
2 and 60 A	60	31–60	0–30	9422TC33	RFK06 [16]
2 and 60 A	60	—	31–60	9422TD63	RFK06H [16]

**Table 16.372: Class 9999 Replacement Fuse Clip Kits (8538 Pre-Series D, 8738 Pre-Series E)**

Device Used on	Disconnect Ampere Rating	NEMA Class H Fuses			NEMA Class R Fuses			NEMA Class J Fuses	
		Fuse Clip Ratings (A)		Type	Fuse Clip Ratings (A)		Type	Fuse Clip Ratings (A) 600 V Max.	Type
Size or Ampere Rating	250 V Max.	600 V Max.	250 V Max.		600 V Max.				
0, 1, and 30 A	30	0–30	—	S1	0–30	—	SR1	—	—
		—	0–30	S2	—	0–30	SR2	0–30	SJ2
		31–60	0–30	S2	31–60	0–30	SR2	0–30	SJ2
2 and 60 A	60	31–60	0–30	S2	31–60	0–30	SR2	0–30	SJ2
		—	31–60	S3	—	31–60	SR3	31–60	SJ3
		61–100	—	S4 [17]	61–100	—	SR4 [18]	61–100	SJ4
3 and 100 A	100	101–200	—	S5 [17]	101–200	—	SR4 [18]	—	—
		—	101–200	S5 [17]	—	101–200	SR4 [18]	—	—
4 and 200 A	200	101–200	101–200	S5 [17]	101–200	101–200	SR4 [18]	—	—
5 and 300 A	400	—	—	—	201–400	201–400	SR5 [18]	—	—
6 and 400, 600 A	600	—	—	—	401–600	401–600	SR5 [18]	—	—

**Table 16.373: Class 9999 Auxiliary Contact Kits for Disconnect Switches and Circuit Breakers**

Class	Type	SPDT	DPDT	Class	Type	SPDT	DPDT
		Type	Type			Type	Type
8538, 8738	SB, SC (Series C)	R45	R46	Disconnect Switches			
8539, 8739	SB, SC, SD, SE, SF, SG	R26	R27	9422	BTCF, BTCN, BTDF, BTEF, BTEN	TC11	TC21
8538	SBA, SCA, SBG, SCG (Series K)	TC11	TC21	9422	TCF, TCN, TDF, TDN, TEF, TEN	TC10	TC11
8738	SBA, SCA, SBG, SCG (Series K)	TC10	TC20	9422	TF	R8	R9
8538	SB[19], SC[19], SD[19] (Series B)	R6	R7	Circuit Breaker Operating Mechanisms			
8538	SBAS8, SCAS8, SBGS8, SCGS8, (Series K)	TC10	TC20	9421	LF, LK, LL, LM, LN, LP, LR, LT, LW	R47	R48
8538, 8738	SD (Series C)	R43	R44	9422	RM, RN, RP, RQ, RR, RT	R26	R27
8538	SDA, SDA[19], SDG, SDG[19] (Series K)	TC10	TC20	9422	CFA, CKA, CLA, CSF, CMP	R26	R27
8738	SDA, SDG (Series K)	TC10	TC20				
8538, 8738	SE (Series B and C)	R41	R42				
8538, 8738	SE, SF (Series A)	R8	R9				
8538, 8738	SF (Series B and C)	R39	R40				
8538, 8738	SG	R35	R36				

**Table 16.374: How to Order**

To Order Specify:	Catalog Number	
• Class Number	Class	Type
• Type Number	9999	R6

[15] When using with a 9422FTCN or FTCTF disconnect switch in Class 8538 or 8738 combination starters, remove and discard the metal base plate.

[16] No Class number required. Discount schedule DE1.

[17] Cannot be used in Series B or newer 8538 devices.

[18] Fuse clips are not provided in the Type SR4 and SR5 kits. On new installations, Class 9999 Type S fuse clips must also be purchased. Three non-removable pins are included and can be installed only in the latest production devices, which have a hole in the lower fuse clips.

[19] Class 8538 Type numbers ending in suffix S8.

**General**

All tables are based on the operation of the motor and controller in the same ambient temperature, 40 °C (104 °F) or less. Always be certain the correct thermal units are installed in the starter before operating the motor. Each thermal unit shall be installed such that its catalog number is visible. See page 16-136 for information on installing thermal units. On melting alloy thermal units the ratchet wheel must engage the pawl assembly.

**Selection Procedure**

1. Determine motor data:
  - a. Full load current rating
  - b. Service factor  
**NOTE:** If motor full load current (FLC) is not known, a tentative thermal unit selection could be made, based on horsepower and voltage. Refer to page 16-136.
2. Motor and controller in *same ambient temperature*:
  - a. All starter classes, except Class 8198:
    1. For 1.15 to 1.25 service factor motors use 100% of motor FLC for thermal unit selection.
    2. For 1.0 service factor motors use 90% of motor FLC for thermal unit selection.
  - b. Class 8198 only:
    1. For 1.0 service factor motors use 100% of motor FLC for thermal unit selection.
    2. For 1.15 to 1.25 service factor motors use 110% of motor FLC for thermal unit selection.
3. Motor and controller in *different ambient temperatures*:
  - a. Multiply motor FLC by the multiplier in [Selection of Thermal Units for Special Applications](#), page 16-132. Use the resultant full load current for thermal unit selection.
4. Locate the proper selection table from the index, pages [page 16-133](#) and [page 16-134](#).
  - a. The proper thermal unit number will be found adjacent, to the right of the range of full load currents in which the motor FLC or resultant full load current falls.
5. See [page 16-135](#) for calculation of trip current rating.

**Slow Trip Thermal Unit Selection**

To select Type SB slow trip thermal units, the selection table for a standard Type B thermal unit may be used with the following modifications: For continuous rated motors having service factors of 1.15 to 1.25, select thermal units from the standard Type B table using 93% (102% for Class 8198) of the full load current shown on the motor nameplate and then substitute an SB for the B in the thermal unit type number.

Example: A motor with a full load current of 12 A controlled by an 8536SCG3 would require B22 thermal units for standard trip applications and SB19.5 thermal units for slow trip applications. The SB is selected by multiplying 12 A times 93% for 11.16 A and using this value to select B19.5. Then add the S prefix to arrive at SB19.5.

For continuous rated motors having a service factor of 1.0, select thermal units in the same manner using 84% (93% for Class 8198) of full load current shown on the motor nameplate.

**NOTE:** SB thermal units are used on Size 0, 1, 2, and only some Size 3 applications. Check thermal unit tables for current ranges.

**Table 16.375: Thermal Unit Trip Types**

Melting Alloy	
Type of Trip	Thermal Unit Type
Standard	A
	B
	C
	CC
	DD
Quick	FB
Slow	SB

**Table 16.376: Selection of Thermal Units for Special Applications**

Class of Controller	Continuous Duty Motor Service Factor	Melting Alloy		
		Ambient Temperature of Motor		
		Same as Controller Ambient	Constant 10 °C (18 °F) Higher Than Controller Ambient	Constant 10 °C (18 °F) Lower Than Controller Ambient
			Full Load Current Multiplier	
All Classes, Except 8198	1.15 to 1.25	1.0	0.9	1.05
	1.0	0.9	0.8	0.95
Class 8198	1.15 to 1.25	1.1	1.0	1.15
	1.0	1.0	0.9	1.05

**Thermal Unit Selection**

**NOTE:** For thermal unit selection tables for other devices including obsolete devices, consult the Customer Care Center at 1-888-778-2733.

**Table 16.377: Thermal Unit Selection**

Controller					Thermal Unit Selection Table Number		
Starter Type	Class	Type	Series <sup>[1]</sup>	Size	Hand Reset Melting Alloy		
					Standard Trip (20)	Quick Trip (10)	Slow Trip (30)
Manual Starters FHP	2510 2512 8908	F	A	FHP	43 <sup>[2]</sup>	—	—
Manual Starters (Small Enclosure)	2510	M, T	A	M-0 M-1 M-1P	1 1 1	72 72 72	<sup>[3]</sup> <sup>[3]</sup> <sup>[3]</sup>
Manual Starters (Large Enclosure)	2510 2511 2512 8925	M, T	A	M-0 M-1 M-1P	2 2 2	73 73 73	<sup>[3]</sup> <sup>[3]</sup> <sup>[3]</sup>
DC Magnetic Starters EC & M Crane Control Product	7135	C, D	—	1, 2	65	—	<sup>[3]</sup>
	7136	E	—	3	9	—	—
	7735	F	—	4	10	—	—
	7736	G	—	5	12	—	—
AC Magnetic Starters (Small Enclosure)	8536 8904 <sup>[4]</sup> (Starter In Own Enclosure) 8933 8998 8999 (Model 3 Control Center) I-LINE® and QMB Motor Starter Centers	A (8536 only)	B, C	00	17 <sup>[2]</sup>	—	—
		SA	A, B	00	13	—	<sup>[3]</sup>
		SB	A	0	13	74	<sup>[3]</sup>
		SC	A	1	13	74	<sup>[3]</sup>
			1P	41	—	<sup>[3]</sup>	
		SD	A	2	56	75	<sup>[3]</sup>
		SE	A	3	18	76 <sup>[5]</sup>	134 <sup>[3][5]</sup>
		SF	A	4	54	—	—
		SG	A	5	49	—	—
			B <sup>[6]</sup>	5	59	83	—
	SH	A, B	6	21	—	—	
	8998 8999 (Model 4 Control Center)	SC	A	1 Fusible	66	74	—
			1 Circuit Breaker	15	74	—	
		SD	A	2 Fusible	67	75	—
			2 Circuit Breaker	58 <sup>[7]</sup>	75	—	
		SE	A	3 Small Enclosure	16	76 <sup>[5]</sup>	134 <sup>[3][5]</sup>
			3 Large Enclosure	68 <sup>[7]</sup>	76 <sup>[5]</sup>	133 <sup>[3][5]</sup>	
		SF	A	4	61	—	—
		SG	A	5	24	—	—
		SH	A	6	20	—	—
8998 (Model 5 and Model 6 MCCs)		SC <sup>[8]</sup>	A	1	109	—	—
	1 COMPAC 6		104	—	—		
	SD <sup>[8]</sup>	A	2	110	—	—	
	SE <sup>[8]</sup>	A	3	111	—	—	
	SF <sup>[8]</sup>	A	4	112	—	—	
		A	5	113	—	—	
	SG <sup>[8]</sup>	B	5 CT	103	—	—	
SH <sup>[8]</sup>	A	6	114	—	—		
8911	DPSG	C	20-30 A	135	—	—	
			40 A	145	—	—	
		A	50 A	146	—	—	

(table continued on the next page)

**NOTE:** For thermal unit selection tables for other devices, including obsolete devices, consult the Customer Care Center at 1-888-778-2733.

[1] Series letters listed refer to the marking on the nameplate of the basic openstyle starter. When the starter comes in a controller containing other devices, the controller may have a different series letter marked on the enclosure nameplate.  
 [2] Type A thermal units for full-load currents lower than those listed in this table are available. For complete information, consult Customer Care Center at 1-888-778-2733.  
 [3] This device will accept Type SB slow trip (Class 30) thermal units. For selection, see page 16-132.  
 [4] Small enclosure tables apply for Class 8904 non-combination and non-reversing starters. For combination and reversing Class 8904 starters, refer to the large enclosure selections, index above.  
 [5] Form Y81 must be specified to use quick trip (Class 10) or slow trip (Class 30) thermal units on Size 3 starters.  
 [6] Divide the motor FLC by 60, and use this quotient to select the appropriate thermal units.  
 [7] Use for autotransformer starters (fusible and circuit breaker).  
 [8] Refers to the Type number of the starter in the MCC, not the Type number of the MCC.

Thermal Unit Selection

Table 16.378: Thermal Unit Selection

Starter Type	Class	Controller			Thermal Unit Selection Table Number					
		Type	Series <sup>[9]</sup>	Size	Hand Reset Melting Alloy					
					Standard Trip (20)	Quick Trip (10)	Slow Trip (30)			
AC Magnetic Starters (Large Enclosure)	8198	G, S	—	—	5	—	[10]			
	8536 (Starter Used in Multi-Motor Panel)	A (8536 only)	B, C	00	14 [11]	—	—			
	8538 8904 <sup>[12]</sup>	SA	A, B	00	53	—	[10]			
	8539 8906	SB, NB	A	0	15	78	[10]			
	8606 8907	SC, NC	A	1	15	78	[10]			
	8630 [13]	8920	SD, ND	A	2	58	79	[10]		
	8640 [14]	8922	SE, NE	A	3	16	80 [15]	133 [15][10]		
	9089 8924	SF, NF	A	4	61	—	—			
	8647 8925	SG	A	5	24	—	—			
	8650 8930		B [16]	5	59	83	—			
	8736 8738 8739	8941	SH	A, B	6	20	—	[10]		
	AC Magnetic Starters (Large Enclosure)	8810 8811 8812	CB, DB, SB, UB	A	0	15	78	[10]		
			CC, DC, SC, UC	A	1	15	78	[10]		
			CD, DD, SD, UD	A	2	58	79	[10]		
			CE, DE, SE, UE	A	3	16	80 [15]	133 [15][10]		
			CF, DF, SF, UF	A	4	61	—	—		
			CG, DG, SG, UG	A	5	24	—	—		
		8940 WELL-GUARD™ Control	WD, XD, MD, RD, VD	A	1	13	78	—		
				A	2	56	79	—		
				A	3	18	80 [15]	—		
			PF, WF, XF, MF, RF, VF, PE	A	4	54	—	—		
				8911	DPSO	C	20–30 A	136	—	—
						A	40 A	147	—	—
	AC Magnetic Part-Winding	8998 (Model 5 and Model 6 MCCs)	SC [17]	A	1	127	—	—		
			SD [17]	A	2	128	—	—		
			SE [17]	A	3	129	—	—		
			SF	A	4	105	—	—		
			SG	A	5	115	—	—		
B [16]				5 CT	116	—	—			
Separately Mounted Overload Relays			9065	C	A	1 (25 A)	44	82	[10]	
				F	B	4 (133 A)	19	—	—	
				G	A	5 (266 A)	22	—	—	
				MEO	A	(32 A)	86	—	—	
	S	A		1 (26 A)	59	83	[10]			
				2 (45 A)	69	84	[10]			
				3 (86 A)	34	—	—			
				4 (133 A)	28	—	—			
	T	A		2 (45 A)	31	—	[10]			
	U	—		—	3 (86 A)	40	—	—		

NOTE: For thermal unit selection tables for other devices including obsolete devices, consult the Customer Care Center at 1-888-778-2733.

[9] Series letters listed refer to the marking on the nameplate of the basic openstyle starter. When the starter comes in a controller containing other devices, the controller may have a different series letter marked on the enclosure nameplate.

[10] This device will accept Type SB slow trip (Class 30) thermal units. For selection, see page 16-132.

[11] Type A thermal units for full-load currents lower than those listed in this table are available. For complete information, consult Customer Care Center at 1-888-778-2733.

[12] Large enclosure tables apply for Class 8904 combination and reversing starters. For non-combination and non-reversing Class 8904 starters refer to small enclosure selections, page 16-133.

[13] For Class 8630 starters, divide the delta-connected motor full-load current by 1.73, and use this quotient to select thermal units.

[14] For Class 8640 and Class 8940 starters (MD, PD, ME, PE, MF, PF, MG and PG), use the full-load current of each motor winding as a basis for thermal unit selection—normally one-half the total motor current.

[15] Form Y81 must be specified to use quick trip (Class 10) or slow trip (Class 30) thermal units on Size 3 starters.

[16] Divide the motor FLC by 60, and use this quotient to select the appropriate thermal units.

[17] Refers to the Type number of the starter in the MCC, not the Type number of the MCC.

16 NEMA AND DEFINITE PURPOSE CONTACTORS AND STARTERS

**Calculation of the Trip Current Rating**

**Trip Current Rating**—The trip current rating is a nominal value that approximates the minimum current to trip an overload relay in an ambient temperature, outside of the enclosure, of 40 °C (104 °F). In all selection tables except Class 8198, the trip current rating is 1.25 times the minimum full load current shown for the thermal unit selected. For Class 8198, the trip current rating is 1.15 times the minimum full load current. This applies to bimetallic overload relays with the trip adjustment set at 100 percent.

**Calculation Procedure**

1. Use the selection table for the specific controller involved.
2. Find the minimum motor full load current listed for the thermal unit in question.
3. Multiply that current by 1.25 (1.15 for Class 8198). The result is the trip current rating.

**Example 1:** Determine the thermal unit selection and trip current rating for thermal units in a Class 8536 Type SCG3 Size 1 magnetic starter used to control a three-phase, 1.15 service factor motor with a full load current of 17.0 Amperes, where the motor and controller are both located in a 40°C (104°F) ambient temperature.

1. From Table 13 the proper selection is B32.
2. The minimum motor full load current is 16.0 Amperes.
3. Trip current rating is 16.0 x 1.25= 20.0 Amperes.

**Protection Level** is the relationship between trip current rating and full load current. Protection level, in percent, is the trip current rating divided by the motor full load current times 100. In Example 1 the protection level for the B32 thermal unit is: 20.0/17.0 x 100= 118%.

National Electrical Code, Section 430-32, allows a maximum protection level of 125% for the motor in the above example.

**Minimum Trip Current** (also called ultimate current) may vary from the trip current rating value, since ratings are established under standardized test conditions. Factors which influence variations include: the number of thermal units installed, enclosure size, proximity to heat producing devices, size of conductors installed, ambient (room) temperature, and others.

Except for ambient temperature-compensated overload relays, an ambient temperature higher than 40°C would lower the trip current, and a lower temperature would increase it. This variation is not a factor in selecting thermal units for the average application, since most motor ratings are based on an ambient temperature of 40 °C, and motor capacity varies with temperature in about the same proportion as the change in trip current. Temperature-compensated relays maintain a nearly constant trip current over a wide range of ambient temperature, and are intended for use where the relay, because of its location, cannot sense changes in the motor ambient temperature.

**Calculation of the Trip Current for Ambient Temperatures Other Than 40 °C**

For a controller ambient temperature other than 40 °C (104 °F) trip current can be calculated by applying a correction factor from the curve in Figure 1. The approximate trip current for a particular ambient temperature is the product of (1) the multiplier M corresponding to the temperature and (2) the 40 °C trip current rating.

**NOTE:** Ambient temperature is the temperature surrounding the starter enclosure. Normal temperature rise inside the enclosure has been taken into account in preparing the thermal unit selection tables.

**Example 2:** Determine the trip current for the motor and controller in Example 1, except the controller is in a 30 °C (86 °F) ambient temperature. From the curve in Figure 1 the multiplier M is 1.1 at 30 °C. The approximate trip current is 16.0 x 1.25 x 1.1 = 22 A.

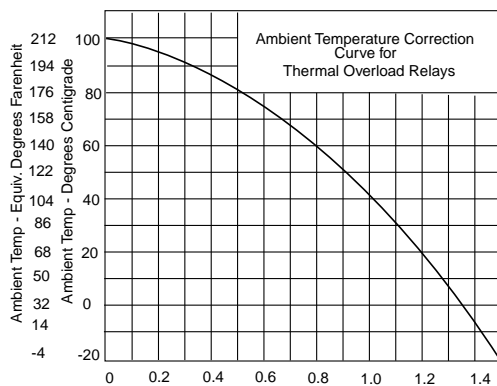

### Approximate Thermal Unit Selection Based On Horsepower and Voltage

**General**—Thermal units selected using approximate full-load currents from Table 16.379 will provide a trip current between 101% and 125% of full-load current for many 4-pole, single speed, normal torque, 60 Hz motors. Since full-load current rating of different makes and types of motors vary so widely, these selections may not be suitable.

Thermal units should be selected on the basis of motor nameplate full-load current and service factor. Thermal unit sizes originally selected on an approximate basis should always be rechecked and corrected at the time of installation if required.

**How to use Table 16.379:**

- Locate the motor horsepower and voltage.
- Determine the approximate full-load current from Table 16.379.
- Use the approximate full-load current in place of actual nameplate full-load current and follow the Selection Procedure on page 16-132.

**Table 16.379: Use This Table Only When the Motor Full-Load Current Is Not Known**

Motor Horsepower	Motor Full-Load Current					
	Three Ø				Single Ø	
	200 V	230 V	460 V	575 V	115 V	230 V
1/6	—	—	—	—	4.4	2.2
1/4	—	—	—	—	5.8	2.9
1/3	—	—	—	—	7.2	3.6
1/2	2.5	2.2	1.1	0.9	9.8	4.9
3/4	3.7	3.2	1.6	1.3	13.8	6.9
1	4.8	4.2	2.1	1.7	16	8
1-1/2	6.9	6.0	3.0	2.4	20	10
2	7.8	6.8	3.4	2.7	24	12
3	11.0	9.6	4.8	3.9	34	17
5	17.5	15.2	7.6	6.1	56	28
7-1/2	25.3	22	11	9	80	40
10	32.2	28	14	11	—	50
15	48.3	42	21	17	—	—
20	62.1	54	27	22	—	—
25	78.2	68	34	27	—	—
30	92	80	40	32	—	—
40	120	104	52	41	—	—
50	150	130	65	52	—	—
60	177	154	77	62	—	—
75	221	192	96	77	—	—
100	285	248	124	99	—	—
125	359	312	156	125	—	—
150	414	360	180	144	—	—
200	552	480	240	192	—	—

**NOTE:** These currents should not be used for selection of fuses, circuit breakers or wire sizes. See NEC tables 430-248 through 430-250. For motors rated 208-220 volts, use 230 V column. For motors rated 440 to 550 volts, use 460 and 575 V columns, respectively.

### Mounting of the Thermal Units

Always be certain the correct thermal units are installed in the starter before operating the motor. Thermal units should always be mounted so that their type designation can be read from the front of the starter (see Figure 1). Melting alloy thermal units should be mounted so that the tooth of the pawl assembly can engage the teeth of the ratchet wheel when the reset button is pushed.

Mounting surfaces of starter and thermal units should be clean and care should be taken to insure that thermal unit mounting screws are fastened securely.



Figure 1

**Thermal Unit Selection Tables**

**Thermal Unit Table 1**

(index and instructions: [page 16-132](#) to [page 16-136](#))

Motor FLC (A)		Thermal Unit Number
1 T.U.	3 T.U.	
0.33-0.36	0.29-0.32	B 0.44
0.37-0.40	0.33-0.36	B 0.51
0.41-0.45	0.37-0.39	B 0.57
0.46-0.52	0.40-0.47	B 0.63
0.53-0.59	0.48-0.56	B 0.71
0.60-0.66	0.57-0.63	B 0.81
0.67-0.73	0.64-0.69	B 0.92
0.74-0.81	0.70-0.77	B 1.03
0.82-0.91	0.78-0.86	B 1.16
0.92-1.02	0.87-0.96	B 1.30
1.03-1.14	0.97-1.11	B 1.45
1.15-1.29	1.12-1.23	B 1.67
1.20-1.42	1.24-1.37	B 1.88
1.43-1.64	1.38-1.55	B 2.10
1.65-1.80	1.56-1.75	B 2.40
1.81-2.10	1.76-1.92	B 2.65
2.11-2.30	1.93-2.16	B 3.00
2.31-2.61	2.17-2.50	B 3.30
2.62-2.99	2.51-2.81	B 3.70
3.00-3.37	2.82-3.16	B 4.15
3.38-3.94	3.17-3.40	B 4.85
3.95-4.24	3.41-3.76	B 5.50
4.25-4.54	3.77-4.00	B 6.25
4.55-5.29	4.01-4.68	B 6.90
5.30-5.73	4.69-5.18	B 7.70
5.74-6.35	5.19-5.51	B 8.20
6.36-7.08	5.52-6.19	B 9.10
7.09-7.83	6.20-7.12	B 10.2
7.84-8.47	7.13-8.15	B 11.5
8.48-9.83	8.16-8.60	B 12.8
9.84-10.5	8.61-9.21	B 14.0
10.6-11.4	9.22-10.1	B 15.5
11.5-12.8	10.2-11.2	B 17.5
12.9-13.9	11.3-12.0	B 19.5
14.0-16.1	—	B 22.0
16.2-18.0	—	B 25.0
Following Selections for Size M-1 & M-1P Only.		
—	11.3-12.1	B 19.5
—	12.2-13.6	B 22.0
16.2-17.6	13.7-15.3	B 25.0
17.7-20.6	15.4-17.3	B 28.0
20.7-23.1	17.4-19.1	B 32.0
23.2-26.0	19.2-21.7	B 36.0
—	21.8-24.2	B 40.0
—	24.3-26.0	B 45.0
Following Selections for Size M-1P Only		
23.2-27.1	—	B 36.0
27.2-29.2	—	B 40.0
29.3-33.0	—	B 45.0
33.1-36.0	—	B 50.0

**Thermal Unit Table 2**

(index and instructions: [page 16-132](#) to [page 16-136](#))

Motor FLC (A)		Thermal Unit Number
1 T.U.	3 T.U.	
0.35-0.38	0.30-0.32	B 0.44
0.39-0.43	0.33-0.37	B 0.51
0.44-0.48	0.38-0.39	B 0.57
0.49-0.56	0.40-0.48	B 0.63
0.57-0.63	0.49-0.57	B 0.71
0.64-0.71	0.58-0.64	B 0.81
0.72-0.78	0.65-0.70	B 0.92
0.79-0.88	0.71-0.78	B 1.03
0.89-0.99	0.79-0.87	B 1.16
1.00-1.15	0.88-0.98	B 1.30
1.16-1.23	0.99-1.13	B 1.45
1.24-1.43	1.14-1.25	B 1.67
1.44-1.51	1.26-1.40	B 1.88
1.52-1.75	1.41-1.58	B 2.10
1.76-1.93	1.59-1.79	B 2.40
1.94-2.25	1.80-1.91	B 2.65
2.26-2.47	1.92-2.20	B 3.00
2.48-2.81	2.21-2.55	B 3.30
2.82-3.20	2.56-2.87	B 3.70
3.21-3.63	2.88-3.24	B 4.15
3.64-4.19	3.25-3.48	B 4.85
4.20-4.53	3.49-3.85	B 5.50
4.54-4.89	3.86-4.10	B 6.25
4.90-5.68	4.11-4.79	B 6.90
5.69-6.27	4.80-5.31	B 7.70
6.28-6.85	5.32-5.65	B 8.20
6.86-7.73	5.66-6.35	B 9.10
7.74-8.50	6.36-7.31	B 10.2
8.51-9.29	7.32-8.34	B 11.5
9.30-10.4	8.35-8.84	B 12.8
10.5-11.3	8.85-9.47	B 14.0
11.4-12.3	9.48-10.4	B 15.5
12.4-13.9	10.5-11.5	B 17.5
14.0-15.0	11.6-12.0	B 19.5
15.1-18.0	—	B 22.0
Following Selections for Size M-1 & M-1P Only.		
—	11.6-12.4	B 19.5
15.1-17.4	12.5-14.0	B 22.0
17.5-19.2	14.1-15.8	B 25.0
19.3-22.0	15.9-17.8	B 28.0
22.1-24.6	17.9-19.7	B 32.0
24.7-26.0	19.8-22.4	B 36.0
—	22.5-25.1	B 40.0
—	25.1-26.0	B 45.0
Following Selections for Size M-1P Only.		
24.7-29.1	—	B 36.0
29.2-31.7	—	B 40.0
31.8-36.0	—	B 45.0

**Thermal Unit Table 3**  
(index and instructions: [page 16-132](#) to [page 16-136](#))

Motor FLC (A)		Thermal Unit Number
1 T.U.	3 T.U.	
0.29-0.31	0.28-0.29	B 0.44
0.32-0.36	0.30-0.33	B 0.51
0.37-0.39	0.34-0.36	B 0.57
0.40-0.47	0.37-0.44	B 0.63
0.48-0.56	0.45-0.52	B 0.71
0.57-0.63	0.53-0.59	B 0.81
0.64-0.69	0.60-0.64	B 0.92
0.70-0.77	0.65-0.71	B 1.03
0.78-0.86	0.72-0.80	B 1.16
0.87-0.97	0.81-0.90	B 1.30
0.98-1.12	0.91-1.03	B 1.45
1.13-1.24	1.04-1.14	B 1.67
1.25-1.39	1.15-1.27	B 1.88
1.40-1.57	1.28-1.44	B 2.10
1.58-1.78	1.45-1.63	B 2.40
1.79-1.96	1.64-1.79	B 2.65
1.97-2.20	1.80-2.01	B 3.00
2.21-2.41	2.02-2.19	B 3.30
2.42-2.75	2.20-2.52	B 3.70
2.76-3.25	2.53-2.95	B 4.15
3.26-3.50	2.96-3.17	B 4.85
3.51-3.87	3.18-3.50	B 5.50
3.88-4.13	3.51-3.73	B 6.25
4.14-4.69	3.74-4.22	B 6.90
4.70-5.20	4.23-4.68	B 7.70
5.21-5.53	4.69-4.98	B 8.20
5.54-6.23	4.99-5.59	B 9.10
6.24-7.18	5.60-6.43	B 10.2
7.19-8.20	6.44-7.41	B 11.5
8.21-8.98	7.42-8.02	B 12.8
8.99-9.63	8.03-8.59	B 14.0
9.64-10.6	8.60-9.52	B 15.5
10.7-11.8	9.53-10.5	B 17.5
11.9-12.7	10.6-11.2	B 19.5
12.8-14.3	11.3-12.0	B 22.0
14.4-16.1	—	B 25.0
16.2-18.0	—	B 28.0
Following Selections for Size M-1 & M-1P Only.		
—	11.3-12.7	B 22.0
—	12.8-14.3	B 25.0
16.2-18.3	14.4-16.1	B 28.0
18.4-20.2	16.2-17.8	B 32.0
20.3-23.0	17.9-20.1	B 36.0
23.1-26.0	20.2-22.6	B 40.0
—	22.7-25.5	B 45.0
—	25.6-26.0	B 50.0
Following Selections for Size M-1P Only		
25.9-29.0	—	B 45.0
29.1-30.8	—	B 50.0
30.9-32.7	—	B 56.0
32.8-36.0	—	B 62.0

**Thermal Unit Table 4**  
(index and instructions: [page 16-132](#) to [page 16-136](#))

Motor FLC (A)		Thermal Unit Number
1 T.U.	3 T.U.	
0.32-0.33	0.29-0.30	B 0.44
0.34-0.38	0.31-0.35	B 0.51
0.39-0.41	0.36-0.37	B 0.57
0.42-0.50	0.38-0.45	B 0.63
0.51-0.61	0.46-0.54	B 0.71
0.62-0.68	0.55-0.61	B 0.81
0.69-0.74	0.62-0.66	B 0.92
0.75-0.83	0.67-0.74	B 1.03
0.84-0.93	0.75-0.83	B 1.16
0.94-1.05	0.84-0.93	B 1.30
1.06-1.21	0.94-1.07	B 1.45
1.22-1.34	1.08-1.19	B 1.67
1.35-1.50	1.20-1.33	B 1.88
1.51-1.70	1.34-1.51	B 2.10
1.71-1.93	1.52-1.70	B 2.40
1.94-2.12	1.71-1.87	B 2.65
2.13-2.38	1.88-2.10	B 3.00
2.39-2.61	2.11-2.29	B 3.30
2.62-2.99	2.30-2.63	B 3.70
3.00-3.53	2.64-3.09	B 4.15
3.54-3.80	3.10-3.32	B 4.85
3.81-4.21	3.33-3.67	B 5.50
4.22-4.49	3.68-3.91	B 6.25
4.50-5.10	3.92-4.43	B 6.90
5.11-5.66	4.44-4.91	B 7.70
5.67-6.03	4.92-5.23	B 8.20
6.04-6.79	5.24-5.88	B 9.10
6.80-7.84	5.89-6.77	B 10.2
7.85-8.96	6.78-7.90	B 11.5
8.97-9.82	7.91-8.44	B 12.8
9.83-10.4	8.45-9.05	B 14.0
10.5-11.6	9.06-9.99	B 15.5
11.7-12.9	10.0-11.0	B 17.5
13.0-13.9	11.1-11.9	B 19.5
14.0-15.7	12.0-12.0	B 22.0
15.8-18.0	—	B 25.0
Following Selections for Size M-1 & M-1P Only.		
—	12.0-13.4	B 22.0
—	13.5-15.1	B 25.0
17.8-20.1	15.2-17.0	B 28.0
20.2-22.2	17.1-18.9	B 32.0
22.3-25.3	19.0-21.4	B 36.0
25.4-26.0	21.5-24.0	B 40.0
—	24.1-26.0	B 45.0
Following Selections for Size M-1P Only.		
25.4-28.4	—	B 40.0
28.5-33.1	—	B 45.0
33.2-36.0	—	B 50.0

**Thermal Unit Table 5**  
(index and instructions: [page 16-132](#) to [page 16-136](#))

Current Transformer Ratio										Thermal Unit Number
25/5	50/5	75/5	100/5	150/5	200/5	250/5	300/5	400/5	500/5	
Motor FLC										
10.6-11.7	21.1-23.6	31.7-35.4	42.3-47.2	63.4-70.9	84.5-94.6	106-117.	127-141.	169-188.	211-236.	B 3.00
11.8-13.2	23.7-26.5	35.5-39.8	47.3-53.1	71.0-79.7	94.7-105.	118-132.	142-159.	189-212.	237-265.	B 3.30
13.3-14.8	26.6-29.6	39.9-44.5	53.2-59.4	79.8-89.1	106-118.	133-148.	160-177.	213-237.	266-296.	B 3.70
14.9-17.2	29.7-34.5	44.6-51.8	59.5-69.2	89.2-103.	119-138.	149-172.	178-207.	238-276.	297-345.	B 4.15
17.3-19.6	34.6-39.2	51.9-58.9	69.3-78.6	104-117.	139-156.	173-196.	208-235.	277-314.	346-360.	B 4.85
19.7-22.3	39.3-44.6	59.0-67.0	78.7-89.3	118-133.	157-178.	197-223.	236-267.	315-357.	—	B 5.50

**Thermal Unit Table 9**  
(index and instructions: [page 16-132](#) to [page 16-136](#))

Motor FLC (A)	Thermal Unit Number
15.3-16.7	C 20.0
16.8-19.8	C 22.0
19.9-22.8	C 26.0
22.9-25.8	C 30.0
25.9-30.4	C 34.0
30.5-31.9	C 40.0
32.0-34.2	C 42.0
34.3-38.8	C 45.0
38.9-44.2	C 51.0
44.3-50.2	C 58.0
50.3-57.1	C 66.0
57.2-63.2	C 75.0
63.3-68.6	C 83.0
68.7-78.6	C 90.0
78.7-86.9	C 103.0
87.0-100.0	C 114.0

**Thermal Unit Table 10**  
(index and instructions: [page 16-132](#) to [page 16-136](#))

Motor FLC (A)	Thermal Unit Number
43.6-47.3	CC 54.5
47.4-51.3	CC 59.4
51.4-54.6	CC 64.3
54.7-59.7	CC 68.5
59.8-65.1	CC 74.6
65.2-70.1	CC 81.5
70.2-75.1	CC 87.7
75.2-82.2	CC 94.0
82.3-89.2	CC 103.0
89.3-96.5	CC 112.0
96.6-104.	CC 121.0
105-113.	CC 132.0
114-123.	CC 143.0
124-132.	CC 156.0
133-150.	CC 167.0



**Thermal Unit Table 12**

(index and instructions: [page 16-132](#) to [page 16-136](#))

Motor FLC (A)	Thermal Unit Number
92-100.	DD 112.0
101-109.	DD 121.0
110-119.	DD 128.0
120-131.	DD 140.0
132-139.	DD 150.0
140-156.	DD 160.0
157-166.	DD 185.0
167-180.	DD 213.0
181-189.	DD 220.0
190-209.	DD 230.0
210-225.	DD 250.0
226-238.	DD 265.0
239-263.	DD 280.0
264-300.	DD 300.0

**Thermal Unit Table 13**

(index and instructions: [page 16-132](#) to [page 16-136](#))

Motor FLC (A)			Thermal Unit Number
1 T.U.	2 T.U.	3 T.U.	
0.29-0.31	0.29-0.31	0.28-0.30	B 0.44
0.32-0.34	0.32-0.34	0.31-0.34	B 0.51
0.35-0.38	0.35-0.38	0.35-0.37	B 0.57
0.39-0.45	0.39-0.45	0.38-0.44	B 0.63
0.46-0.54	0.46-0.54	0.45-0.53	B 0.71
0.55-0.61	0.55-0.61	0.54-0.59	B 0.81
0.62-0.66	0.62-0.66	0.60-0.64	B 0.92
0.67-0.73	0.67-0.73	0.65-0.72	B 1.03
0.74-0.81	0.74-0.81	0.73-0.80	B 1.16
0.82-0.94	0.82-0.94	0.81-0.90	B 1.30
0.95-1.05	0.95-1.05	0.91-1.03	B 1.45
1.06-1.22	1.06-1.22	1.04-1.14	B 1.67
1.23-1.34	1.23-1.34	1.15-1.27	B 1.88
1.35-1.51	1.35-1.51	1.28-1.43	B 2.10
1.52-1.71	1.52-1.71	1.44-1.62	B 2.40
1.72-1.93	1.72-1.93	1.63-1.77	B 2.65
1.94-2.14	1.94-2.14	1.78-1.97	B 3.00
2.15-2.40	2.15-2.40	1.98-2.32	B 3.30
2.41-2.72	2.41-2.72	2.33-2.51	B 3.70
2.73-3.15	2.73-3.15	2.52-2.99	B 4.15
3.16-3.55	3.16-3.55	3.00-3.42	B 4.85
3.56-4.00	3.56-4.00	3.43-3.75	B 5.50
4.01-4.40	4.01-4.40	3.76-3.98	B 6.25
4.41-4.88	4.41-4.88	3.99-4.48	B 6.90
4.89-5.19	4.89-5.19	4.49-4.93	B 7.70
5.20-5.73	5.20-5.73	4.94-5.21	B 8.20
5.74-6.39	5.74-6.39	5.22-5.84	B 9.10
6.40-7.13	6.40-7.13	5.85-6.67	B 10.2
7.14-7.90	7.14-7.90	6.68-7.54	B 11.5
7.91-8.55	7.91-8.55	7.55-8.14	B 12.8
8.56-9.53	8.56-9.53	8.15-8.72	B 14.0
9.54-10.6	9.54-10.6	8.73-9.66	B 15.5
10.7-11.8	10.7-11.8	9.67-10.5	B 17.5
11.9-13.2	11.9-12.0	10.6-11.3	B 19.5
13.3-14.9	—	11.4-12.0	B 22.0
15.0-16.6	—	—	B 25.0
16.7-18.0	—	—	B 28.0
Following Selections for Size 1 Only			
—	11.9-13.2	—	B 19.5
—	13.3-14.9	11.4-12.7	B 22.0
—	15.0-16.6	12.8-14.1	B 25.0
16.7-18.9	16.7-18.9	14.2-15.9	B 28.0
19.0-21.2	19.0-21.2	16.0-17.5	B 32.0
21.3-23.0	21.3-23.0	17.6-19.7	B 36.0
23.1-25.5	23.1-25.5	19.8-21.9	B 40.0
25.6-26.0	25.6-26.0	22.0-24.4	B 45.0
—	—	24.5-26.0	B 50.0

**Thermal Unit Table 14**

(index and instructions: [page 16-132](#) to [page 16-136](#))

Motor FLC (A)			Thermal Unit Number
1 T.U.	2 T.U.	3 T.U.	
0.43-0.47	0.41-0.45	0.40-0.41	A 49
0.48-0.51	0.46-0.50	0.42-0.46	A 54
0.52-0.56	0.51-0.55	0.47-0.51	A 59
0.57-0.64	0.56-0.62	0.52-0.57	A 65
0.65-0.69	0.63-0.67	0.58-0.62	A 71
0.70-0.76	0.68-0.72	0.63-0.67	A 78
0.77-0.84	0.73-0.81	0.68-0.75	A 86
0.85-0.91	0.82-0.88	0.76-0.80	A 95
0.92-1.01	0.89-0.97	0.81-0.89	A 1.02
1.02-1.15	0.98-1.08	0.90-1.02	A 1.16
1.16-1.23	1.09-1.18	1.03-1.09	A 1.25
1.24-1.37	1.19-1.32	1.10-1.21	A 1.39
1.38-1.45	1.33-1.40	1.22-1.29	A 1.54
1.46-1.56	1.41-1.48	1.30-1.37	A 1.63
1.57-1.67	1.49-1.60	1.38-1.48	A 1.75
1.68-1.77	1.61-1.72	1.49-1.58	A 1.86
1.78-1.92	1.73-1.84	1.59-1.72	A 1.99
1.93-2.09	1.85-2.00	1.73-1.85	A 2.15
2.10-2.31	2.01-2.22	1.86-2.05	A 2.31
2.32-2.56	2.23-2.45	2.06-2.29	A 2.57
2.57-2.92	2.46-2.82	2.30-2.62	A 2.81
2.93-3.16	2.83-3.08	2.63-2.84	A 3.61
3.17-3.48	3.09-3.39	2.85-3.10	A 3.95
3.49-3.83	3.40-3.75	3.11-3.46	A 4.32
3.84-4.24	3.76-4.16	3.47-3.85	A 4.79
4.25-4.62	4.17-4.51	3.86-4.16	A 5.30
4.63-4.92	4.52-4.83	4.17-4.46	A 5.78
4.93-5.61	4.84-5.49	4.47-5.08	A 6.20
5.62-5.85	5.50-5.67	5.09-5.35	A 6.99
5.86-6.36	5.68-6.16	5.36-5.82	A 7.65
6.37-6.99	6.17-6.75	5.83-6.34	A 8.38
7.00-7.67	6.76-7.00	6.35-6.95	A 9.25
7.68-8.15	—	6.96-7.00	A 9.85
8.16-9.00	—	—	A 11.0

**Thermal Unit Table 15**

(index and instructions: [page 16-132](#) to [page 16-136](#))

Motor FLC (A)			Thermal Unit Number
1 T.U.	2 T.U.	3 T.U.	
0.31-0.33	0.31-0.33	0.29-0.31	B 0.44
0.34-0.36	0.34-0.36	0.32-0.36	B 0.51
0.37-0.40	0.37-0.40	0.37-0.38	B 0.57
0.41-0.48	0.41-0.48	0.39-0.46	B 0.63
0.49-0.57	0.49-0.57	0.47-0.55	B 0.71
0.58-0.64	0.58-0.64	0.56-0.61	B 0.81
0.65-0.70	0.65-0.70	0.62-0.66	B 0.92
0.71-0.77	0.71-0.77	0.67-0.75	B 1.03
0.78-0.85	0.78-0.85	0.76-0.83	B 1.16
0.86-0.99	0.86-0.99	0.84-0.93	B 1.30
1.00-1.10	1.00-1.10	0.94-1.06	B 1.45
1.11-1.28	1.11-1.28	1.07-1.18	B 1.67
1.29-1.41	1.29-1.41	1.19-1.31	B 1.88
1.42-1.58	1.42-1.58	1.32-1.47	B 2.10
1.59-1.80	1.59-1.80	1.48-1.67	B 2.40
1.81-2.03	1.81-2.03	1.68-1.83	B 2.65
2.04-2.25	2.04-2.25	1.84-2.04	B 3.00
2.26-2.51	2.26-2.51	2.05-2.38	B 3.30
2.52-2.83	2.52-2.83	2.39-2.60	B 3.70
2.84-3.29	2.84-3.29	2.61-3.13	B 4.15
3.30-3.75	3.30-3.75	3.14-3.59	B 4.85
3.76-4.22	3.76-4.22	3.60-3.94	B 5.50
4.23-4.65	4.23-4.65	3.95-4.19	B 6.25
4.66-5.16	4.66-5.16	4.20-4.72	B 6.90
5.17-5.53	5.17-5.53	4.73-5.21	B 7.70
5.54-6.09	5.54-6.09	5.22-5.51	B 8.20
6.10-6.80	6.10-6.80	5.52-6.17	B 9.10
6.81-7.60	6.81-7.60	6.18-7.07	B 10.2
7.61-8.35	7.61-8.35	7.08-8.05	B 11.5
8.36-9.04	8.36-9.04	8.06-8.69	B 12.8
9.05-9.99	9.05-9.99	8.70-9.32	B 14.0
10.0-11.1	10.0-11.1	9.33-10.2	B 15.5
11.2-12.3	11.2-12.0	10.3-11.3	B 17.5
12.4-13.7	—	11.4-12.0	B 19.5
13.8-15.4	—	—	B 22.0
15.5-18.0	—	—	B 25.0
Following Selections for Size 1 Only			
—	11.2-12.3	—	B 17.5
—	12.4-13.7	11.4-12.1	B 19.5
—	13.8-15.4	12.2-13.7	B 22.0
15.5-17.2	15.5-17.2	13.8-15.2	B 25.0
17.3-19.4	17.3-19.4	15.3-17.2	B 28.0
19.5-21.7	19.5-21.7	17.3-18.9	B 32.0
21.8-23.9	21.8-23.9	19.0-21.4	B 36.0
24.0-26.0	24.0-26.0	21.5-23.7	B 40.0
—	—	23.8-26.0	B 45.0

16 NEMA AND DEFINITE PURPOSE CONTACTORS AND STARTERS

Thermal Unit Table 16

(index and instructions: [page 16-132](#) to [page 16-136](#))

Motor FLC (A)			Thermal Unit Number
1 T.U.	2 T.U.	3 T.U.	
16.2-17.5	15.1-16.2	14.3-15.4	CC 20.9
17.6-18.8	16.3-17.3	15.5-16.4	CC 22.8
18.9-20.5	17.4-19.5	16.5-18.5	CC 24.6
20.6-22.2	19.6-20.7	18.6-19.6	CC 26.3
22.3-23.7	20.8-22.3	19.7-21.1	CC 28.8
23.8-25.4	22.4-24.0	21.2-22.7	CC 31.0
25.5-27.3	24.1-25.7	22.8-24.4	CC 33.3
27.4-29.3	25.8-27.5	24.5-26.1	CC 36.4
29.4-31.5	27.6-29.6	26.2-28.1	CC 39.6
31.6-33.9	29.7-31.7	28.2-30.0	CC 42.7
34.0-36.2	31.8-33.9	30.1-32.1	CC 46.6
36.3-39.3	34.0-36.6	32.2-34.7	CC 50.1
39.4-42.3	36.7-39.3	34.8-37.3	CC 54.5
42.4-45.3	39.4-42.3	37.4-40.1	CC 59.4
45.4-48.3	42.4-44.9	40.2-42.6	CC 64.3
48.4-52.0	45.0-48.3	42.7-45.8	CC 68.5
52.1-54.9	48.4-50.9	45.9-48.3	CC 74.6
55.0-59.7	51.0-55.5	48.4-52.6	CC 81.5
59.8-65.4	55.6-59.9	52.7-56.8	CC 87.7
65.5-69.6	60.0-64.2	56.9-60.9	CC 94.0
69.7-74.8	64.3-68.7	61.0-65.1	CC 103.0
74.9-79.7	68.8-71.4	65.2-67.7	CC 112.0
79.8-83.1	71.5-74.8	67.8-70.9	CC 121.0
83.2-86.0	74.9-78.0	71.0-73.9	CC 132.0
—	78.1-80.7	74.0-76.5	CC 143.0
—	80.8-86.0	76.6-80.2	CC 156.0
—	—	80.3-83.1	CC 167.0
—	—	83.2-86.0	CC 180.0

Thermal Unit Table 17

(index and instructions: [page 16-132](#) to [page 16-136](#))

Motor FLC (A)			Thermal Unit Number
1 T.U.	2 T.U.	3 T.U.	
0.42-0.46	0.39-0.43	0.38-0.40	A .49
0.47-0.50	0.44-0.47	0.41-0.44	A .54
0.51-0.55	0.48-0.52	0.45-0.49	A .59
0.56-0.62	0.53-0.58	0.50-0.55	A .65
0.63-0.67	0.59-0.64	0.56-0.60	A .71
0.68-0.73	0.65-0.68	0.61-0.65	A .78
0.74-0.81	0.69-0.77	0.66-0.72	A .86
0.82-0.89	0.78-0.84	0.73-0.79	A .95
0.90-0.98	0.85-0.93	0.80-0.88	A 1.02
0.99-1.12	0.94-1.05	0.89-0.98	A 1.16
1.13-1.20	1.06-1.13	0.99-1.07	A 1.25
1.21-1.34	1.14-1.25	1.08-1.17	A 1.39
1.35-1.41	1.26-1.33	1.18-1.25	A 1.54
1.42-1.51	1.34-1.42	1.26-1.33	A 1.63
1.52-1.62	1.43-1.52	1.34-1.44	A 1.75
1.63-1.73	1.53-1.63	1.45-1.53	A 1.86
1.74-1.86	1.64-1.75	1.54-1.65	A 1.99
1.87-2.02	1.76-1.90	1.66-1.79	A 2.15
2.03-2.25	1.91-2.13	1.80-1.99	A 2.31
2.26-2.46	2.14-2.33	2.00-2.18	A 2.57
2.47-2.77	2.34-2.73	2.19-2.45	A 2.81
2.78-2.99	2.74-2.86	2.46-2.65	A 3.61
3.00-3.26	2.87-3.14	2.66-2.90	A 3.95
3.27-3.59	3.15-3.47	2.91-3.19	A 4.32
3.60-3.99	3.48-3.83	3.20-3.56	A 4.79
4.00-4.42	3.84-4.16	3.57-3.83	A 5.30
4.43-4.61	4.17-4.43	3.84-4.08	A 5.78
4.62-5.23	4.44-5.00	4.09-4.64	A 6.20
5.24-5.39	5.01-5.16	4.65-5.00	A 6.99
5.40-5.88	5.17-5.56	5.01-5.36	A 7.65
5.89-6.56	5.57-6.22	5.37-5.87	A 8.38
6.57-7.18	6.23-6.89	5.88-6.43	A 9.25
7.19-7.80	6.90-7.00	6.44-6.79	A 9.85
7.81-9.00	—	6.80-7.00	A 11.0

Thermal Unit Table 18

(index and instructions: [page 16-132](#) to [page 16-136](#))

Motor FLC (A)			Thermal Unit Number
1 T.U.	2 T.U.	3 T.U.	
15.5-16.4	14.4-15.3	13.6-14.5	CC 20.9
16.5-17.6	15.4-16.4	14.6-15.5	CC 22.8
17.7-19.1	16.5-18.4	15.6-17.4	CC 24.6
19.2-20.4	18.5-19.6	17.5-18.5	CC 26.3
20.5-22.1	19.7-21.0	18.6-19.9	CC 28.8
22.2-23.4	21.1-22.7	20.0-21.5	CC 31.0
23.5-25.6	22.8-24.2	21.6-22.9	CC 33.3
25.7-27.3	24.3-25.9	23.0-24.5	CC 36.4
27.4-29.4	26.0-27.8	24.6-26.3	CC 39.6
29.5-31.5	27.9-29.8	26.4-28.2	CC 42.7
31.6-33.7	29.9-31.7	28.3-30.0	CC 46.6
33.8-36.5	31.8-34.2	30.1-32.3	CC 50.1
36.6-39.1	34.3-36.9	32.4-34.9	CC 54.5
39.2-41.7	37.0-39.8	35.0-37.6	CC 59.4
41.8-44.8	39.9-42.3	37.7-40.0	CC 64.3
44.9-48.0	42.4-45.3	40.1-42.8	CC 68.5
48.1-50.7	45.4-47.9	42.9-45.3	CC 74.6
50.8-54.9	48.0-51.9	45.4-49.1	CC 81.5
55.0-59.9	52.0-56.5	49.2-53.4	CC 87.7
60.0-63.3	56.6-60.7	53.5-57.4	CC 94.0
63.4-67.2	60.8-64.8	57.5-61.3	CC 103.0
67.3-72.4	64.9-67.1	61.4-63.5	CC 112.0
72.5-74.9	67.2-70.1	63.6-66.3	CC 121.0
75.0-77.4	70.2-72.9	66.4-69.0	CC 132.0
77.5-80.7	73.0-74.9	69.1-70.9	CC 143.0
80.8-83.1	75.0-77.9	71.0-73.7	CC 156.0
83.2-86.0	78.0-80.9	73.8-76.5	CC 167.0
—	81.0-82.9	76.6-78.4	CC 180.0
—	83.0-86.0	78.5-86.0	CC 196.0

Thermal Unit Table 19

(index and instructions: [page 16-132](#) to [page 16-136](#))

Motor FLC (A)	Thermal Unit Number
43.6-47.3	CC 54.5
47.4-51.3	CC 59.4
51.4-54.6	CC 64.3
54.7-59.7	CC 68.5
59.8-65.1	CC 74.6
65.2-70.1	CC 81.5
70.2-75.1	CC 87.7
75.2-82.2	CC 94.0
82.3-89.2	CC 103.0
89.3-96.5	CC 112.0
96.6-104.	CC 121.0
105-113.	CC 132.0
114-123.	CC 143.0
124-133.	CC 156.0

Thermal Unit Table 20

(index and instructions: [page 16-132](#) to [page 16-136](#))

Motor FLC (A)	Thermal Unit Number
133-148.	B 1.30
149-174.	B 1.45
175-195.	B 1.67
196-219.	B 1.88
220-239.	B 2.10
240-271.	B 2.40
272-308.	B 2.65
309-348.	B 3.00
349-397.	B 3.30
398-429.	B 3.70
430-495.	B 4.15
496-520.	B 4.85

Thermal Unit Table 21

(index and instructions: [page 16-132](#) to [page 16-136](#))

Motor FLC (A)	Thermal Unit Load
128-140.	B 1.30
141-163.	B 1.45
164-179.	B 1.67
180-201.	B 1.88
202-227.	B 2.10
228-251.	B 2.40
252-278.	B 2.65
279-308.	B 3.00
309-346.	B 3.30
347-380.	B 3.70
381-426.	B 4.15
427-454.	B 4.85
455-489.	B 5.50
490-520.	B 6.25

**Thermal Unit Table 22**

(index and instructions: [page 16-132 to page 16-136](#))

Motor FLC (A)	Thermal Unit Number
92.0–100.	DD 112.0
101.–109.	DD 121.0
110.–119.	DD 128.0
120.–131.	DD 140.0
132.–139.	DD 150.0
140.–156.	DD 160.0
157.–166.	DD 185.0
167.–180.	DD 213.0
181.–189.	DD 220.0
190.–209.	DD 230.0
210.–225.	DD 250.0
226.–238.	DD 265.0
239.–266.	DD 280.0

**Thermal Unit Table 26**

(index and instructions: [page 16-132 to page 16-136](#))

Size 7 Type J		Size 8 Type K		Thermal Unit Number
Current Transformer Ratio		Current Transformer Ratio		
120/5	2000/5	120/5	2000/5	
Motor FLC				
166–187.	277–312.			B 1.03
188–211.	313–352.			B 1.16
212–232.	353–388.			B 1.30
233–267.	389–445.			B 1.45
268–301.	446–503.			B 1.67
302–336.	504–561.			B 1.88
337–383.	562–640.			B 2.10
384–425.	641–708.			B 2.40
426–466.	709–777.			B 2.65
467–522.	778–870.			B 3.00
523–587.	871–978.			B 3.30
588–656.	979–1093.			B 3.70
657–764.	1094–1215.			B 4.15

**Thermal Unit Table 31**

(index and instructions: [page 16-132 to page 16-136](#))

Motor FLC (A)	Thermal Unit Number
0.31–0.35	B 0.44
0.36–0.39	B 0.51
0.40–0.44	B 0.57
0.45–0.50	B 0.63
0.51–0.61	B 0.71
0.62–0.68	B 0.81
0.69–0.73	B 0.92
0.74–0.82	B 1.03
0.83–0.92	B 1.16
0.93–1.03	B 1.30
1.04–1.19	B 1.45
1.20–1.34	B 1.67
1.35–1.50	B 1.88
1.51–1.74	B 2.10
1.75–1.97	B 2.40
1.98–2.14	B 2.65
2.15–2.47	B 3.00
2.48–2.91	B 3.30
2.92–3.31	B 3.70
3.32–3.75	B 4.15
3.76–4.05	B 4.85
4.06–4.94	B 6.25
4.95–5.52	B 6.90
5.53–6.11	B 7.70
6.12–6.52	B 8.20
6.53–7.31	B 9.10
7.32–8.43	B 10.2
8.44–9.83	B 11.5
9.84–10.7	B 12.8
10.8–11.6	B 14.0
11.7–12.9	B 15.5
13.0–14.3	B 17.5
14.4–15.7	B 19.5
15.8–17.8	B 22.0
17.9–20.3	B 25.0
20.4–23.3	B 28.0
23.4–26.6	B 32.0
26.7–30.3	B 36.0
30.4–35.3	B 40.0
35.4–41.5	B 45.0
41.6–45	B 50.0

**Thermal Unit Table 24**

(index and instructions: [page 16-132 to page 16-136](#))

Motor FLC (A)	Thermal Unit Number
88.2–95.1	DD 112.0
95.2–101.	DD 121.0
102.–111.	DD 128.0
112.–119.	DD 140.0
120.–131.	DD 150.0
132.–149.	DD 160.0
150.–170.	DD 185.0
171.–180.	DD 220.0
181.–197.	DD 240.0
198.–204.	DD 250.0
205.–213.	DD 265.0
214.–237.	DD 280.0
238.–243.	DD 300.0
244.–266.	DD 320.0

**Thermal Unit Table 28**

(index and instructions: [page 16-132 to page 16-136](#))

Motor FLC (A)		Thermal Unit Number
2 or 3 T.U.		
Large Enclosure	Small Enclosure	
45.3–48.2	40.3–42.8	CC 64.3
48.3–52.4	42.9–46.2	CC 68.5
52.5–56.4	46.3–49.8	CC 74.6
56.5–61.2	49.9–54.9	CC 81.5
61.3–66.1	55.0–57.9	CC 87.7
66.2–71.4	58.0–62.5	CC 94.0
71.5–77.0	62.6–67.3	CC 103.0
77.1–80.7	67.4–73.4	CC 112.0
80.8–87.7	73.5–78.9	CC 121.0
87.8–94.9	79.0–84.9	CC 132.0
95.0–102.	85.0–91.0	CC 143.0
103.–110.	91.1–97.2	CC 156.0
111.–117.	97.3–104.	CC 167.0
118.–133.	105.–121.	CC 180.0
—	122.–133.	CC 196.0

**Thermal Unit Table 34**

(index and instructions: [page 16-132 to page 16-136](#))

Motor FLC (A)	Thermal Unit Number
15.1–16.2	CC 20.9
16.3–17.5	CC 22.8
17.6–19.1	CC 24.6
19.2–20.7	CC 26.3
20.8–22.2	CC 28.8
22.3–24.0	CC 31.0
24.1–25.7	CC 33.3
25.8–27.8	CC 36.4
27.9–30.1	CC 39.6
30.2–32.5	CC 42.7
32.6–35.1	CC 46.6
35.2–38.0	CC 50.1
38.1–41.1	CC 54.5
41.2–44.0	CC 59.4
44.1–47.2	CC 64.3
47.3–51.1	CC 68.5
51.2–55.8	CC 74.6
55.9–59.5	CC 81.5
59.6–64.5	CC 87.7
64.6–69.5	CC 94.0
69.6–75.0	CC 103.0
75.1–78.1	CC 112.0
78.2–82.3	CC 121.0
82.4–86.0	CC 132.0

**Thermal Unit Table 40**

(index and instructions: [page 16-132 to page 16-136](#))

Motor FLC (A)	Thermal Unit Number
15.3–16.7	C 20.0
16.8–19.8	C 22.0
19.9–22.8	C 26.0
22.9–25.8	C 30.0
25.9–30.4	C 34.0
30.5–31.9	C 40.0
32.0–34.2	C 42.0
34.3–38.8	C 45.0
38.9–44.2	C 51.0
44.3–50.2	C 58.0
50.3–57.1	C 66.0
57.2–63.2	C 75.0
63.3–68.6	C 83.0
68.7–78.6	C 90.0
78.7–86.0	C 103.0

**Thermal Unit Table 41**  
(index and instructions: [page 16-132](#) to [page 16-136](#))

Motor FLC (A)	Thermal Unit Number
0.81-0.92	B 1.16
0.93-1.07	B 1.30
1.08-1.14	B 1.45
1.15-1.26	B 1.67
1.27-1.49	B 1.88
1.50-1.73	B 2.10
1.74-1.89	B 2.40
1.90-2.16	B 2.65
2.17-2.37	B 3.00
2.38-2.66	B 3.30
2.67-2.99	B 3.70
3.00-3.40	B 4.15
3.41-3.94	B 4.85
3.95-4.15	B 5.50
4.16-4.49	B 6.25
4.50-5.15	B 6.90
5.16-5.77	B 7.70
5.78-6.61	B 8.20
6.62-7.14	B 9.10
7.15-7.97	B 10.2
7.98-8.15	B 11.5
8.16-9.32	B 12.8
9.33-9.97	B 14.0
9.98-10.7	B 15.5
10.8-12.0	B 17.5
12.1-13.9	B 19.5
14.0-15.7	B 22.0
15.8-18.4	B 25.0
18.5-21.6	B 28.0
21.7-24.0	B 32.0
24.1-28.6	B 36.0
28.7-30.7	B 40.0
30.8-33.5	B 45.0
33.6-36.0	B 50.0

**Thermal Unit Table 43**  
(index and instructions: [page 16-132](#) to [page 16-136](#))

Motor FLC (A)	Thermal Unit Number
0.41-0.44	A .49
0.45-0.49	A .54
0.50-0.53	A .59
0.54-0.58	A .65
0.59-0.65	A .71
0.66-0.71	A .78
0.72-0.78	A .86
0.79-0.85	A .95
0.86-0.96	A 1.02
0.97-1.04	A 1.16
1.05-1.16	A 1.25
1.17-1.29	A 1.39
1.30-1.37	A 1.54
1.38-1.47	A 1.63
1.48-1.56	A 1.75
1.57-1.65	A 1.86
1.66-1.79	A 1.99
1.80-1.95	A 2.15
1.96-2.15	A 2.31
2.16-2.38	A 2.57
2.39-2.75	A 2.81
2.76-2.84	A 3.61
2.85-3.06	A 3.95
3.07-3.45	A 4.32
3.46-3.70	A 4.79
3.71-4.07	A 5.30
4.08-4.32	A 5.78
4.33-4.90	A 6.20
4.91-5.35	A 6.99
5.36-5.85	A 7.65
5.86-6.41	A 8.38
6.42-6.79	A 9.25
6.80-7.57	A 9.85
7.58-8.15	A 11.0
8.16-8.98	A 11.9
8.99-9.67	A 13.2
9.68-9.95	A 14.1
9.96-10.8	A 14.8
10.9-12.1	A 16.2
12.2-13.1	A 17.9
13.2-13.9	A 19.8
14.0-15.0	A 21.3
15.1-16.0	A 25.2

**Thermal Unit Table 44**  
(index and instructions: [page 16-132](#) to [page 16-136](#))

Motor FLC (A)	Thermal Unit Number
0.34-0.38	B 0.44
0.39-0.43	B 0.51
0.44-0.48	B 0.57
0.49-0.53	B 0.65
0.54-0.62	B 0.71
0.63-0.69	B 0.81
0.70-0.78	B 0.92
0.79-0.88	B 1.03
0.89-0.99	B 1.16
1.00-1.10	B 1.30
1.11-1.26	B 1.45
1.27-1.43	B 1.67
1.44-1.59	B 1.88
1.60-1.81	B 2.10
1.82-2.00	B 2.40
2.01-2.28	B 2.65
2.29-2.52	B 3.00
2.53-2.87	B 3.30
2.88-3.28	B 3.70
3.29-3.75	B 4.15
3.76-4.27	B 4.85
4.28-4.77	B 5.50
4.78-5.27	B 6.25
5.28-5.91	B 6.90
5.92-6.25	B 7.70
6.26-6.83	B 8.20
6.84-7.65	B 9.10
7.66-8.55	B 10.2
8.56-9.56	B 11.5
9.57-10.3	B 12.8
10.4-11.3	B 14.0
11.4-12.4	B 15.5
12.5-14.1	B 17.5
14.2-15.7	B 19.5
15.8-17.9	B 22.0
18.0-20.1	B 25.0
20.2-22.5	B 28.0
22.6-25.0	B 32.0

**Thermal Unit Table 49**  
(index and instructions: [page 16-132](#) to [page 16-136](#))

Motor FLC (A)	Thermal Unit Number
82.5-88.2	DD 112.0
88.3-95.9	DD 121.0
96.0-102.	DD 128.0
103.-109.	DD 140.0
110.-121.	DD 150.0
122.-139.	DD 160.0
140.-154.	DD 185.0
155.-163.	DD 220.0
164.-175.	DD 240.0
176.-184.	DD 250.0
185.-195.	DD 265.0
196.-215.	DD 280.0
216.-224.	DD 300.0
225.-243.	DD 320.0
244.-266.	DD 340.0

**Thermal Unit Table 53**

(index and instructions: [page 16-132 to page 16-136](#))

Motor FLC (A)		Thermal Unit Number
1 T. U.	3 T. U.	
0.31-0.33	0.29-0.31	B 0.44
0.34-0.36	0.32-0.36	B 0.51
0.37-0.40	0.37-0.38	B 0.57
0.41-0.48	0.39-0.46	B 0.63
0.49-0.57	0.47-0.55	B 0.71
0.58-0.64	0.56-0.61	B 0.81
0.65-0.70	0.62-0.66	B 0.92
0.71-0.77	0.67-0.75	B 1.03
0.78-0.85	0.76-0.83	B 1.16
0.86-0.99	0.84-0.93	B 1.30
1.00-1.10	0.94-1.06	B 1.45
1.11-1.28	1.07-1.18	B 1.67
1.29-1.41	1.19-1.31	B 1.88
1.42-1.58	1.32-1.47	B 2.10
1.59-1.80	1.48-1.67	B 2.40
1.81-2.03	1.68-1.83	B 2.65
2.04-2.25	1.84-2.04	B 3.00
2.26-2.51	2.05-2.38	B 3.30
2.52-2.83	2.39-2.60	B 3.70
2.84-3.29	2.61-3.13	B 4.15
3.30-3.75	3.14-3.59	B 4.85
3.76-4.22	3.60-3.94	B 5.50
4.23-4.65	3.95-4.19	B 6.25
4.66-5.16	4.20-4.72	B 6.90
5.17-5.53	4.73-5.21	B 7.70
5.54-6.09	5.22-5.51	B 8.20
6.10-6.80	5.52-6.17	B 9.10
6.81-7.60	6.18-7.00	B 10.2
7.61-8.35	—	B 11.5
8.36-9.00	—	B 12.8

**Thermal Unit Table 56**

(index and instructions: [page 16-132 to page 16-136](#))

Motor FLC (A)		Thermal Unit Number
1 or 2 T. U.	3 T. U.	
3.29-3.74	3.18-3.40	B 4.85
3.75-4.23	3.41-3.76	B 5.50
4.24-4.68	3.77-4.00	B 6.25
4.69-5.22	4.01-4.57	B 6.90
5.23-5.67	4.58-5.03	B 7.70
5.68-6.13	5.04-5.32	B 8.20
6.14-6.91	5.33-5.97	B 9.10
6.92-7.70	5.98-6.88	B 10.2
7.71-8.56	6.89-7.82	B 11.5
8.57-9.39	7.83-8.47	B 12.8
9.40-10.4	8.48-9.15	B 14.0
10.5-11.6	9.16-10.1	B 15.5
11.7-12.9	10.2-11.2	B 17.5
13.0-14.6	11.3-12.0	B 19.5
14.7-16.5	12.1-13.6	B 22.0
16.6-18.5	13.7-15.2	B 25.0
18.6-21.0	15.3-17.1	B 28.0
21.1-23.6	17.2-19.0	B 32.0
23.7-26.3	19.1-21.5	B 36.0
26.4-29.3	21.6-24.1	B 40.0
29.4-35.1	24.2-27.0	B 45.0
35.2-36.1	27.1-28.7	B 50.0
36.2-39.1	28.8-30.4	B 56.0
39.2-41.5	30.5-32.2	B 62.0
41.6-45.0	32.3-35.4	B 70.0
—	35.5-38.2	B 79.0
—	38.3-45.0	B 88.0

**Thermal Unit Table 54**

(index and instructions: [page 16-132 to page 16-136](#))

Motor FLC (A)		Thermal Unit Number
2 T. U.	3 T. U.	
43.6-45.5	41.1-43.5	CC 64.3
45.6-49.6	43.6-46.8	CC 68.5
49.7-53.1	46.9-50.0	CC 74.6
53.2-57.6	50.1-54.9	CC 81.5
57.7-62.4	55.0-57.5	CC 87.7
62.5-67.5	57.6-61.8	CC 94.0
67.6-71.1	61.9-66.2	CC 103.0
71.2-75.9	66.3-72.4	CC 112.0
76.0-81.9	72.5-78.1	CC 121.0
82.0-84.6	78.2-80.7	CC 132.0
84.7-90.7	80.8-86.5	CC 143.0
90.8-98.4	86.6-93.9	CC 156.0
98.5-105.	94.0-100.	CC 167.0
106.-117.	101.-112.	CC 180.0
118.-123.	113.-117.	CC 196.0
124.-133.	118.-123.	CC 208.0
—	124.-133.	CC 219.0

**Thermal Unit Table 58**

(index and instructions: [page 16-132 to page 16-136](#))

Motor FLC (A)		Thermal Unit Number
1 or 2 T. U.	3 T. U.	
3.37-3.82	3.28-3.51	B 4.85
3.83-4.33	3.52-3.89	B 5.50
4.34-4.79	3.90-4.14	B 6.25
4.80-5.33	4.15-4.73	B 6.90
5.34-5.79	4.74-5.22	B 7.70
5.80-6.27	5.23-5.53	B 8.20
6.28-7.03	5.54-6.21	B 9.10
7.04-7.88	6.22-7.17	B 10.2
7.89-8.73	7.18-8.19	B 11.5
8.74-9.55	8.20-8.90	B 12.8
9.56-10.6	8.91-9.57	B 14.0
10.7-11.8	9.58-10.6	B 15.5
11.9-13.1	10.7-11.8	B 17.5
13.2-14.9	11.9-12.7	B 19.5
15.0-16.9	12.8-14.4	B 22.0
17.0-18.8	14.5-16.1	B 25.0
18.9-21.5	16.2-18.2	B 28.0
21.6-24.1	18.3-20.2	B 32.0
24.2-26.8	20.3-22.8	B 36.0
26.9-29.9	22.9-25.6	B 40.0
30.0-35.5	25.7-28.8	B 45.0
35.6-36.5	28.9-30.6	B 50.0
36.6-39.6	30.7-32.4	B 56.0
39.7-41.5	32.5-34.6	B 62.0
41.6-45.0	34.7-38.6	B 70.0
—	38.7-45.0	B 79.0

**Thermal Unit Table 59**  
(index and instructions: [page 16-132](#) to [page 16-136](#))

Motor FLC (A)		Thermal Unit Number
1 or 2 T. U.	3 T. U.	
0.34-0.38	0.29-0.31	B 0.44
0.39-0.43	0.32-0.35	B 0.51
0.44-0.47	0.36-0.38	B 0.57
0.48-0.53	0.39-0.46	B 0.63
0.54-0.60	0.47-0.55	B 0.71
0.61-0.68	0.56-0.62	B 0.81
0.69-0.76	0.63-0.67	B 0.92
0.77-0.86	0.68-0.75	B 1.03
0.87-0.97	0.76-0.84	B 1.16
0.98-1.07	0.85-0.95	B 1.30
1.08-1.23	0.96-1.09	B 1.45
1.24-1.39	1.10-1.21	B 1.67
1.40-1.55	1.22-1.35	B 1.88
1.56-1.77	1.36-1.53	B 2.10
1.78-1.96	1.54-1.73	B 2.40
1.97-2.15	1.74-1.90	B 2.65
2.16-2.41	1.91-2.14	B 3.00
2.42-2.71	2.15-2.34	B 3.30
2.72-3.03	2.35-2.67	B 3.70
3.04-3.53	2.68-3.22	B 4.15
3.54-4.01	3.23-3.48	B 4.85
4.02-4.56	3.49-3.87	B 5.50
4.57-5.03	3.88-4.14	B 6.25
5.04-5.59	4.15-4.73	B 6.90
5.60-5.95	4.74-5.28	B 7.70
5.96-6.58	5.29-5.64	B 8.20
6.59-7.31	5.65-6.39	B 9.10
7.32-8.15	6.40-7.43	B 10.2
8.16-9.13	7.44-8.55	B 11.5
9.14-9.91	8.56-9.40	B 12.8
9.92-10.7	9.41-10.0	B 14.0
10.8-12.1	10.1-11.2	B 15.5
12.2-13.5	11.3-12.5	B 17.5
13.6-15.1	12.6-13.5	B 19.5
15.2-17.0	13.6-15.4	B 22.0
17.1-18.9	15.5-17.5	B 25.0
19.0-21.5	17.6-19.9	B 28.0
21.6-24.0	20.0-22.2	B 32.0
24.1-26.0	22.3-25.5	B 36.0
—	25.6-26.0	B 40.0

**Thermal Unit Table 65**  
(index and instructions: [page 16-132](#) to [page 16-136](#))

Motor FLC (A)	Thermal Unit Number
0.31-0.35	B 0.44
0.36-0.39	B 0.51
0.40-0.44	B 0.57
0.45-0.50	B 0.63
0.51-0.58	B 0.71
0.59-0.65	B 0.81
0.66-0.73	B 0.92
0.74-0.82	B 1.03
0.83-0.92	B 1.16
0.93-1.03	B 1.30
1.04-1.19	B 1.45
1.20-1.34	B 1.67
1.35-1.50	B 1.88
1.51-1.67	B 2.10
1.68-1.89	B 2.40
1.90-2.14	B 2.65
2.15-2.36	B 3.00
2.37-2.65	B 3.30
2.66-2.97	B 3.70
2.98-3.47	B 4.15
3.48-3.94	B 4.85
3.95-4.44	B 5.50
4.45-4.94	B 6.25
4.95-5.52	B 6.90
5.53-5.88	B 7.70
5.89-6.52	B 8.20
6.53-7.31	B 9.10
7.32-8.21	B 10.2
8.22-9.18	B 11.5
9.19-9.90	B 12.8
10.0-11.0	B 14.0
11.1-12.4	B 15.5
12.5-13.9	B 17.5
14.0-15.7	B 19.5
15.8-17.8	B 22.0
17.9-20.0	B 25.0
20.1-22.9	B 28.0
23.0-25.0	B 32.0
Following Selections for Size 2 Only.	
23.0-25.7	B 32.0
25.8-28.6	B 36.0
28.7-32.2	B 40.0
32.3-35.8	B 45.0
35.9-40.1	B 50.0
40.2-44.4	B 56.0
44.5-50.0	B 62.0

**Thermal Unit Table 61**  
(index and instructions: [page 16-132](#) to [page 16-136](#))

Motor FLC (A)		Thermal Unit Number
2 T. U.	3 T. U.	
46.8-50.0	45.3-48.2	CC 64.3
50.1-54.2	48.3-52.4	CC 68.5
54.3-58.3	52.5-56.4	CC 74.6
58.4-63.6	56.5-61.2	CC 81.5
63.7-68.5	61.3-66.1	CC 87.7
68.6-74.0	66.2-71.4	CC 94.0
74.1-79.8	71.5-77.0	CC 103.0
79.9-83.0	77.1-79.0	CC 112.0
83.1-88.9	79.1-84.7	CC 121.0
89.0-95.6	84.8-91.1	CC 132.0
95.7-102.	91.2-98.1	CC 143.0
103.-109.	98.2-104.	CC 156.0
110.-119.	105.-113.	CC 167.0
120.-133.	114.-123.	CC 180.0
—	124.-133.	CC 196.0

**Thermal Unit Table 66**  
(index and instructions: [page 16-132](#) to [page 16-136](#))

Motor FLC (A)	Thermal Unit Number
0.31-0.32	B 0.44
0.33-0.36	B 0.51
0.37-0.41	B 0.57
0.42-0.49	B 0.63
0.50-0.54	B 0.71
0.55-0.61	B 0.81
0.62-0.67	B 0.92
0.68-0.76	B 1.03
0.77-0.87	B 1.16
0.88-0.98	B 1.30
0.99-1.05	B 1.45
1.06-1.25	B 1.67
1.26-1.33	B 1.88
1.34-1.56	B 2.10
1.57-1.71	B 2.40
1.72-1.97	B 2.65
1.98-2.15	B 3.00
2.16-2.42	B 3.30
2.43-2.78	B 3.70
2.79-3.28	B 4.15
3.29-3.88	B 4.85
3.89-4.13	B 5.5
4.14-4.43	B 6.25
4.44-4.96	B 6.90
4.97-5.35	B 7.70
5.36-5.91	B 8.20
5.92-6.79	B 9.10
6.80-7.56	B 10.2
7.57-7.83	B 11.5
7.84-8.09	B 12.8
8.10-9.51	B 14.0
9.52-10.1	B 15.5
10.2-11.3	B 17.5
11.4-13.1	B 19.5
13.2-14.9	B 22.0
15.0-16.1	B 25.0
16.2-17.8	B 28.0
17.9-19.1	B 32.0
19.2-22.4	B 36.0
22.5-23.5	B 40.0
23.6-26.0	B 45.0

**Thermal Unit Table 67**

(index and instructions: [page 16-132](#) to [page 16-136](#))

Motor FLC (A)	Thermal Unit Number
3.79-4.14	B 5.50
4.15-4.44	B 6.25
4.45-5.22	B 6.90
5.23-5.29	B 7.70
5.30-5.99	B 8.20
6.00-6.82	B 9.10
6.83-7.68	B 10.2
7.69-7.92	B 11.5
7.93-8.47	B 12.8
8.48-9.99	B 14.0
10.0-10.8	B 15.5
10.9-12.3	B 17.5
12.4-12.9	B 19.5
13.0-15.1	B 22.0
15.2-16.7	B 25.0
16.8-17.9	B 28.0
18.0-20.1	B 32.0
20.2-23.8	B 36.0
23.9-25.8	B 40.0
25.9-28.3	B 45.0
28.4-29.6	B 50.0
29.7-32.1	B 56.0
32.2-34.4	B 62.0
34.5-38.3	B 70.0
38.4-39.9	B 79.0
40.0-45.0	B 88.0

**Thermal Unit Table 69**

(index and instructions: [page 16-132](#) to [page 16-136](#))

Motor FLC (A)		Thermal Unit Number
1 or 2 T. U.	3 T. U.	
3.46-3.90	3.38-3.65	B 4.85
3.91-4.44	3.66-4.07	B 5.50
4.45-4.91	4.08-4.36	B 6.25
4.92-5.51	4.37-5.19	B 6.90
5.52-5.84	5.20-5.59	B 7.70
5.85-6.54	5.60-5.98	B 8.20
6.55-7.33	5.99-6.78	B 9.10
7.34-8.31	6.79-7.91	B 10.2
8.32-9.22	7.92-9.12	B 11.5
9.23-10.0	9.13-10.0	B 12.8
10.1-11.2	10.1-10.7	B 14.0
11.3-12.5	10.8-12.0	B 15.5
12.6-14.2	12.1-13.5	B 17.5
14.3-16.1	13.6-14.6	B 19.5
16.2-18.4	14.7-16.7	B 22.0
18.5-20.5	16.8-18.9	B 25.0
20.6-23.2	19.0-21.6	B 28.0
23.3-26.6	21.7-24.1	B 32.0
26.7-29.6	24.2-27.6	B 36.0
29.7-33.5	27.7-31.2	B 40.0
33.6-37.2	31.3-35.5	B 45.0
37.3-41.5	35.6-37.8	B 50.0
41.6-45.0	37.9-41.5	B 56.0
—	41.6-45.0	B 62.0

**Thermal Unit Table 68**

(index and instructions: [page 16-132](#) to [page 16-136](#))

Motor FLC (A)	Thermal Unit Number
14.9-16.1	CC 20.9
16.2-17.3	CC 22.8
17.4-19.5	CC 24.6
19.6-20.7	CC 26.3
20.8-22.4	CC 28.8
22.5-23.9	CC 31.0
24.0-25.8	CC 33.3
25.9-27.6	CC 36.4
27.7-29.7	CC 39.6
29.8-31.8	CC 42.7
31.9-34.2	CC 46.6
34.3-37.0	CC 50.1
37.1-39.6	CC 54.5
39.7-42.5	CC 59.4
42.6-45.0	CC 64.3
45.1-48.6	CC 68.5
48.7-51.2	CC 74.6
51.3-56.0	CC 81.5
56.1-60.1	CC 87.7
60.2-64.3	CC 94.0
64.4-68.9	CC 103.0
69.0-71.9	CC 112.0
72.0-75.4	CC 121.0
75.5-78.9	CC 132.0
79.0-82.1	CC 143.0
82.2-86.0	CC 156.0

Thermal Unit Table 72

(index and instructions: page 16-132 to page 16-136)

Motor FLC (A)		Thermal Unit Number
1 T. U.	3 T. U.	
2.38-2.62	2.38-2.62	FB 3.33
2.63-2.94	2.63-2.94	FB 3.71
2.95-3.31	2.95-3.31	FB 4.1
3.32-3.43	3.32-3.43	FB 4.5
3.44-3.81	3.44-3.81	FB 4.75
3.82-4.32	3.82-4.32	FB 5.3
4.33-4.75	4.33-4.75	FB 6.1
4.76-5.38	4.76-5.38	FB 6.75
5.39-5.75	5.39-5.75	FB 7.45
5.76-5.97	5.76-5.97	FB 7.8
5.98-6.30	5.98-6.30	FB 8.21
6.31-6.55	6.31-6.55	FB 8.6
6.56-6.89	6.56-6.89	FB 9.0
6.90-7.14	6.90-7.14	FB 9.5
7.15-7.36	7.15-7.36	FB 10.0
7.37-8.30	7.37-8.30	FB 10.6
8.31-8.59	8.31-8.59	FB 11.2
8.60-9.01	8.60-9.01	FB 12.1
9.02-9.68	9.02-9.68	FB 13.1
9.69-9.99	9.69-9.99	FB 13.9
10.0-10.9	10.0-10.9	FB 14.8
11.0-11.3	11.0-11.3	FB 15.6
11.4-12.4	11.4-12.0	FB 16.4
12.5-12.9	—	FB 17.6
13.0-14.0	—	FB 18.4
14.1-14.5	—	FB 19.4
14.6-15.7	—	FB 21.1
15.8-16.6	—	FB 22.6
16.7-18.0	—	FB 23.6
Following Selections for Size M-1 & M-1P Only.		
—	11.4-12.4	FB 16.4
—	12.5-12.9	FB 17.6
—	13.0-14.0	FB 18.4
—	14.1-14.5	FB 19.4
—	14.6-15.7	FB 21.1
—	15.8-16.6	FB 22.6
16.7-17.6	16.7-17.6	FB 23.6
17.7-18.3	17.7-18.3	FB 24.8
18.4-19.4	18.4-19.4	FB 26.7
19.5-20.5	19.5-20.5	FB 28.3
20.6-21.7	20.6-21.7	FB 29.6
21.8-22.8	21.8-22.8	FB 30.5
22.9-24.3	22.9-24.3	FB 32.5
24.4-24.7	24.4-24.7	FB 34.1
24.8-25.4	24.8-25.4	FB 35.0
25.5-26.0	25.5-26.0	FB 36.6
Following Selections for Size M-1P Only.		
26.1-27.7	—	FB 38.3
27.8-28.9	—	FB 40.2
29.0-30.6	—	FB 42.0
30.7-32.5	—	FB 44.0
32.6-36.0	—	FB 46.0

Thermal Unit Table 73

(index and instructions: page 16-132 to page 16-136)

Motor FLC (A)		Thermal Unit Number
1 T. U.	3 T. U.	
2.42-2.67	2.42-2.67	FB 3.33
2.68-3.00	2.68-3.00	FB 3.71
3.01-3.36	3.01-3.36	FB 4.1
3.37-3.53	3.37-3.53	FB 4.5
3.54-3.91	3.54-3.91	FB 4.75
3.92-4.41	3.92-4.41	FB 5.3
4.42-4.83	4.42-4.83	FB 6.1
4.84-5.45	4.84-5.45	FB 6.75
5.46-5.89	5.46-5.89	FB 7.45
5.90-6.04	5.90-6.04	FB 7.8
6.05-6.55	6.05-6.55	FB 8.21
6.56-6.72	6.56-6.72	FB 8.6
6.73-7.00	6.73-7.00	FB 9.0
7.01-7.39	7.01-7.39	FB 9.5
7.40-7.54	7.40-7.54	FB 10.0
7.55-8.41	7.55-8.41	FB 10.6
8.42-8.91	8.42-8.91	FB 11.2
8.92-9.16	8.92-9.16	FB 12.1
9.17-10.0	9.17-10.0	FB 13.1
10.1-10.3	10.1-10.3	FB 13.9
10.4-11.4	10.4-11.4	FB 14.8
11.5-11.8	11.5-11.8	FB 15.6
11.9-12.9	11.9-12.9	FB 16.4
13.0-13.4	—	FB 17.6
13.5-14.2	—	FB 18.4
14.3-15.1	—	FB 19.4
15.2-18.0	—	FB 21.1
Following Selections for Size M-1 & M-1P Only.		
—	11.5-11.8	FB 15.6
—	11.9-12.9	FB 16.4
—	13.0-13.4	FB 17.6
—	13.5-14.2	FB 18.4
—	14.3-15.1	FB 19.4
15.2-17.1	15.2-17.1	FB 21.1
17.2-18.0	17.2-18.0	FB 22.6
18.1-18.9	18.1-18.9	FB 23.6
19.0-19.7	19.0-19.7	FB 24.8
19.8-20.9	19.8-20.9	FB 26.7
21.0-21.9	21.0-21.9	FB 28.3
22.0-23.1	22.0-23.1	FB 29.6
23.2-24.3	23.2-24.3	FB 30.5
24.4-25.5	24.4-25.5	FB 32.6
25.6-26.0	25.6-26.0	FB 34.1
Following Selections for Size M-1P Only.		
26.1-26.8	—	FB 35.0
26.9-27.3	—	FB 36.6
27.4-28.7	—	FB 38.3
28.8-30.2	—	FB 40.2
30.3-31.9	—	FB 42.0
32.0-36.0	—	FB 44.0

16 NEMA AND DEFINITE PURPOSE CONTACTORS AND STARTERS



**Thermal Unit Table 74**

(index and instructions: [page 16-132 to page 16-136](#))

Motor FLC (A)		Thermal Unit Number
1 T. U.	3 T. U.	
2.23-2.47	2.23-2.47	FB 3.33
2.48-2.76	2.48-2.76	FB 3.71
2.77-3.04	2.77-3.04	FB 4.1
3.05-3.24	3.05-3.24	FB 4.5
3.25-3.61	3.25-3.61	FB 4.75
3.62-4.19	3.62-4.19	FB 5.3
4.20-4.62	4.20-4.62	FB 6.1
4.63-5.14	4.63-5.14	FB 6.75
5.15-5.39	5.15-5.39	FB 7.45
5.40-5.69	5.40-5.69	FB 7.8
5.70-5.99	5.70-5.99	FB 8.21
6.00-6.29	6.00-6.29	FB 8.6
6.30-6.64	6.30-6.64	FB 9.0
6.65-6.99	6.65-6.99	FB 9.5
7.00-7.39	7.00-7.39	FB 10.0
7.40-7.79	7.40-7.79	FB 10.6
7.80-7.94	7.80-7.94	FB 11.2
7.95-8.49	7.95-8.49	FB 12.1
8.50-8.99	8.50-8.99	FB 13.1
9.00-9.59	9.00-9.59	FB 13.9
9.60-10.1	9.60-10.1	FB 14.8
10.2-10.6	10.2-10.6	FB 15.6
10.7-11.3	10.7-11.3	FB 16.4
11.4-12.0	11.4-12.0	FB 17.6
12.0-12.6	—	FB 18.4
12.7-13.8	—	FB 19.4
13.9-14.7	—	FB 21.1
14.8-15.2	—	FB 22.6
15.3-16.2	—	FB 23.6
16.3-18.0	—	FB 24.8
Following Selections for Size 1 Only.		
—	12.0-12.6	FB 18.4
—	12.7-13.8	FB 19.4
13.9-14.7	13.9-14.7	FB 21.1
14.8-15.2	14.8-15.2	FB 22.6
15.3-16.2	15.3-16.2	FB 23.6
16.3-17.4	16.3-17.4	FB 24.8
17.5-18.5	17.5-18.5	FB 26.7
18.6-19.6	18.6-19.6	FB 28.3
19.7-20.2	19.7-20.2	FB 29.6
20.3-21.5	20.3-21.5	FB 30.5
21.6-22.4	21.6-22.4	FB 32.6
22.5-23.2	22.5-23.2	FB 34.1
23.3-24.3	23.3-24.3	FB 35.0
24.4-25.4	24.4-25.4	FB 36.6
25.5-26.0	25.5-26.0	FB 38.3

**Thermal Unit Table 76**

(index and instructions: [page 16-132 to page 16-136](#))

Motor FLC (A)	Thermal Unit Number
19.9-20.8	FB 26.7
20.9-22.2	FB 28.3
22.3-23.8	FB 29.6
23.9-25.4	FB 30.5
25.5-27.2	FB 32.6
27.3-29.2	FB 34.1
29.3-31.9	FB 38.3
32.0-33.8	FB 40.2
33.9-36.1	FB 42.0
36.2-38.5	FB 44.0
38.6-41.4	FB 46.0
41.5-43.6	FB 48.0
43.7-45.9	FB 50.5
46.0-48.2	FB 52.5
48.3-50.7	FB 55.5
50.8-53.9	FB 58.0
54.0-56.7	FB 60.0
56.8-60.8	FB 63.5
60.9-67.6	FB 69.0
67.7-73.6	FB 77.0
73.7-82.9	FB 84.0
83.0-86.0	FB 92.0

**Thermal Unit Table 75**

(index and instructions: [page 16-132 to page 16-136](#))

Motor FLC (A)	Thermal Unit Number
3.22-3.57	FB 4.75
3.58-4.14	FB 5.3
4.15-4.56	FB 6.1
4.57-5.10	FB 6.75
5.11-5.39	FB 7.45
5.40-5.64	FB 7.8
5.65-5.96	FB 8.21
5.97-6.25	FB 8.6
6.26-6.58	FB 9.0
6.59-6.91	FB 9.5
6.92-7.41	FB 10.0
7.42-7.82	FB 10.6
7.83-8.32	FB 11.2
8.33-8.89	FB 12.1
8.90-9.47	FB 13.1
9.48-10.0	FB 13.9
10.1-10.5	FB 14.8
10.6-11.1	FB 15.6
11.2-12.0	FB 16.4
12.1-12.7	FB 17.6
12.8-13.5	FB 18.4
13.6-14.6	FB 19.4
14.7-15.7	FB 21.1
15.8-16.5	FB 22.6
16.6-17.4	FB 23.6
17.5-18.8	FB 24.8
18.9-20.1	FB 26.7
20.2-21.0	FB 28.3
21.1-21.6	FB 29.6
21.7-23.3	FB 30.5
23.4-24.3	FB 32.6
24.4-25.0	FB 34.1
25.1-26.3	FB 35.0
26.4-27.6	FB 36.6
27.7-29.1	FB 38.3
29.2-30.4	FB 40.2
30.5-32.0	FB 42.0
32.1-33.3	FB 44.0
33.4-35.2	FB 46.0
35.3-37.0	FB 48.0
37.1-38.5	FB 50.5
38.6-40.7	FB 52.5
40.8-45.0	FB 55.5

**Thermal Unit Table 77**

(index and instructions: [page 16-132 to page 16-136](#))

Motor FLC (A)	Thermal Unit Number
48.0-50.9	FB 50.5
51.0-53.7	FB 52.5
53.8-57.0	FB 55.5
57.1-60.4	FB 58.0
60.5-64.0	FB 60.0
64.1-71.9	FB 63.5
72.0-83.9	FB 69.0
84.0-93.1	FB 77.0
93.2-104	FB 84.0
105-109	FB 92.0
110-123	FB 105.0
124-133	FB 115.0

**Thermal Unit Table 78**  
(index and instructions: [page 16-132](#) to [page 16-136](#))

Motor FLC (A)		Thermal Unit Number
1 T. U.	2 T. U. or 3 T. U.	
2.26-2.51	2.26-2.51	FB 3.33
2.52-2.82	2.52-2.82	FB 3.71
2.83-3.09	2.83-3.09	FB 4.1
3.10-3.30	3.10-3.30	FB 4.5
3.31-3.69	3.31-3.69	FB 4.75
3.70-4.27	3.70-4.27	FB 5.3
4.28-4.72	4.28-4.72	FB 6.1
4.73-5.25	4.73-5.25	FB 6.75
5.26-5.53	5.26-5.53	FB 7.45
5.54-5.81	5.54-5.81	FB 7.8
5.82-6.14	5.82-6.14	FB 8.21
6.15-6.44	6.15-6.44	FB 8.6
6.45-6.81	6.45-6.81	FB 9.0
6.82-7.19	6.82-7.19	FB 9.5
7.20-7.59	7.20-7.59	FB 10.0
7.60-7.99	7.60-7.99	FB 10.6
8.00-8.17	8.00-8.17	FB 11.2
8.18-8.74	8.18-8.74	FB 12.1
8.75-9.31	8.75-9.31	FB 13.1
9.32-9.94	9.32-9.94	FB 13.9
9.95-10.5	9.95-10.5	FB 14.8
10.6-11.1	10.6-11.1	FB 15.6
11.2-11.9	11.2-12.0	FB 16.4
12.0-12.4	—	FB 17.6
12.5-13.1	—	FB 18.4
13.2-14.3	—	FB 19.4
14.4-15.3	—	FB 21.1
15.4-15.9	—	FB 22.6
16.0-16.9	—	FB 23.6
Following Selections for Size 1 Only.		
—	12.0-12.4	FB 17.6
—	12.5-13.1	FB 18.4
—	13.2-14.3	FB 19.4
14.4-15.3	14.4-15.3	FB 21.1
15.4-15.9	15.4-15.9	FB 22.6
16.0-16.9	16.0-16.9	FB 23.6
17.0-18.3	17.0-18.3	FB 24.8
18.4-19.5	18.4-19.5	FB 26.7
19.6-20.5	19.6-20.5	FB 28.3
20.6-21.1	20.6-21.1	FB 29.6
21.2-22.6	21.2-22.6	FB 30.5
22.7-23.7	22.7-23.7	FB 32.6
23.8-24.3	23.8-24.3	FB 35.0
24.4-26.0	24.4-26.0	FB 35.0

**Thermal Unit Table 80**  
(index and instructions: [page 16-132](#) to [page 16-136](#))

Motor FLC (A)	Thermal Unit Number
20.5-21.7	FB 26.7
21.8-23.1	FB 28.3
23.2-24.8	FB 29.6
24.9-26.5	FB 30.5
26.6-28.4	FB 32.6
28.5-30.4	FB 34.1
30.5-32.8	FB 38.3
32.9-34.9	FB 40.2
35.0-37.3	FB 42.0
37.4-39.8	FB 44.0
39.9-42.5	FB 46.0
42.6-45.8	FB 48.0
45.9-48.2	FB 50.5
48.3-50.6	FB 52.5
50.7-53.1	FB 55.5
53.2-56.5	FB 58.0
56.6-59.4	FB 60.0
59.5-63.4	FB 63.5
63.5-71.0	FB 69.0
71.1-78.8	FB 77.0
78.9-86.0	FB 84.0

**Thermal Unit Table 79**  
(index and instructions: [page 16-132](#) to [page 16-136](#))

Motor FLC (A)	Thermal Unit Number
3.31-3.67	FB 4.75
3.68-4.23	FB 5.3
4.24-4.69	FB 6.1
4.70-5.21	FB 6.75
5.22-5.49	FB 7.45
5.50-5.74	FB 7.8
5.75-6.07	FB 8.21
6.08-6.35	FB 8.6
6.36-6.71	FB 9.0
6.72-7.03	FB 9.5
7.04-7.53	FB 10.0
7.54-7.91	FB 10.6
7.92-8.53	FB 11.2
8.54-9.14	FB 12.1
9.15-9.71	FB 13.1
9.72-10.2	FB 13.9
10.3-10.8	FB 14.8
10.9-11.5	FB 15.6
11.6-12.3	FB 16.4
12.4-13.0	FB 17.6
13.1-13.9	FB 18.4
14.0-15.1	FB 19.4
15.2-16.1	FB 21.1
16.2-16.9	FB 22.6
17.0-17.9	FB 23.6
18.0-19.4	FB 24.8
19.5-20.7	FB 26.7
20.8-21.7	FB 28.3
21.8-22.3	FB 29.6
22.4-23.9	FB 30.5
24.0-25.1	FB 32.6
25.2-25.9	FB 34.1
26.0-27.1	FB 35.0
27.2-28.6	FB 36.6
28.7-30.1	FB 38.3
30.2-31.7	FB 40.2
31.8-33.3	FB 42.0
33.4-34.5	FB 44.0
34.6-36.5	FB 46.0
36.6-38.5	FB 48.0
38.6-39.9	FB 50.5
40.0-45.0	FB 52.5

**Thermal Unit Table 81**  
(index and instructions: [page 16-132](#) to [page 16-136](#))

Motor FLC (A)	Thermal Unit Number
52.2-55.6	FB 50.5
55.7-58.8	FB 52.5
58.9-62.5	FB 55.5
62.6-66.0	FB 58.0
66.1-70.1	FB 60.0
70.2-78.6	FB 63.5
78.7-92.0	FB 69.0
92.1-102	FB 77.0
103-114	FB 84.0
115-123	FB 92.0
124-133	FB 105.0

**Thermal Unit Table 82**  
(index and instructions: [page 16-132](#) to [page 16-136](#))

Motor FLC (A)	Thermal Unit Number
2.36-2.63	FB 3.33
2.64-2.96	FB 3.71
2.97-3.23	FB 4.1
3.24-3.45	FB 4.5
3.46-3.86	FB 4.75
3.87-4.44	FB 5.3
4.45-4.95	FB 6.1
4.96-5.47	FB 6.75
5.48-5.75	FB 7.45
5.76-6.09	FB 7.8
6.10-6.42	FB 8.21
6.43-6.75	FB 8.6
6.76-7.16	FB 9.0
7.17-7.43	FB 9.5
7.44-7.99	FB 10.0
8.00-8.46	FB 10.6
8.47-9.19	FB 11.2
9.20-9.74	FB 12.1
9.75-10.3	FB 13.1
10.4-10.8	FB 13.9
10.9-11.6	FB 14.8
11.7-12.2	FB 15.6
12.3-13.1	FB 16.4
13.2-13.7	FB 17.6
13.8-14.3	FB 18.4
14.4-15.5	FB 19.4
15.6-16.7	FB 21.1
16.8-17.6	FB 22.6
17.7-18.6	FB 23.6
18.7-19.9	FB 24.8
20.0-21.1	FB 26.7
21.2-25.0	FB 105.0

**Thermal Unit Table 84**  
(index and instructions: [page 16-132](#) to [page 16-136](#))

Motor FLC (A)	Thermal Unit Number
3.38-3.78	FB 4.75
3.79-4.37	FB 5.3
4.38-4.87	FB 6.1
4.88-5.51	FB 6.75
5.52-5.73	FB 7.45
5.74-6.09	FB 7.8
6.10-6.44	FB 8.21
6.45-6.75	FB 8.6
6.76-7.15	FB 9.0
7.16-7.57	FB 9.5
7.58-8.07	FB 10.0
8.08-8.47	FB 10.6
8.48-8.81	FB 11.2
8.82-9.46	FB 12.1
9.47-10.1	FB 13.1
10.2-10.8	FB 13.9
10.9-11.4	FB 14.8
11.5-12.1	FB 15.6
12.2-13.1	FB 16.4
13.2-13.8	FB 17.6
13.9-14.8	FB 18.4
14.9-16.1	FB 19.4
16.2-17.4	FB 21.1
17.5-18.3	FB 22.6
18.4-19.5	FB 23.6
19.6-21.0	FB 24.8
21.1-22.5	FB 26.7
22.6-23.7	FB 28.3
23.8-24.5	FB 29.6
24.6-26.4	FB 30.5
26.5-27.7	FB 32.6
27.8-28.7	FB 34.1
28.8-29.9	FB 35.0
30.0-31.8	FB 36.6
31.9-33.5	FB 38.3
33.6-35.1	FB 40.2
35.2-37.1	FB 42.0
37.2-38.8	FB 44.0
38.9-41.1	FB 46.0
41.2-45.0	FB 48.0

**Thermal Unit Table 83**  
(index and instructions: [page 16-132](#) to [page 16-136](#))

Motor FLC (A)	Thermal Unit Number
2.30-2.60	FB 3.33
2.61-2.87	FB 3.71
2.88-3.17	FB 4.1
3.18-3.37	FB 4.5
3.38-3.76	FB 4.75
3.77-4.29	FB 5.3
4.30-4.75	FB 6.1
4.76-5.26	FB 6.75
5.27-5.51	FB 7.45
5.52-5.78	FB 7.8
5.79-6.13	FB 8.21
6.14-6.41	FB 8.6
6.42-6.75	FB 9.0
6.76-7.09	FB 9.5
7.10-7.57	FB 10.0
7.58-7.90	FB 10.6
7.91-8.81	FB 11.2
8.82-9.47	FB 12.1
9.48-10.0	FB 13.1
10.1-10.7	FB 13.9
10.8-11.4	FB 14.8
11.5-12.1	FB 15.6
12.2-13.1	FB 16.4
13.2-13.7	FB 17.6
13.8-14.7	FB 18.4
14.8-16.0	FB 19.4
16.1-17.3	FB 21.1
17.4-18.2	FB 22.6
18.3-19.4	FB 23.6
19.5-20.7	FB 24.8
20.8-22.3	FB 26.7
22.4-23.5	FB 28.3
23.6-24.2	FB 29.6
24.3-26.0	FB 30.5

**Thermal Unit Table 85**  
(index and instructions: [page 16-132](#) to [page 16-136](#))

Motor FLC (A)	Thermal Unit Number
42.9-45.4	FB 44.0
45.6-48.3	FB 46.0
48.4-52.4	FB 48.0
52.5-55.9	FB 50.5
56.0-59.8	FB 52.5
59.9-63.8	FB 55.5
63.9-67.9	FB 58.0
68.0-72.6	FB 60.0
72.7-83.2	FB 63.5
83.3-94.7	FB 69.0
94.8-105	FB 77.0
106-116	FB 84.0
117-121	FB 92.0
122-133	FB 105.0

**Thermal Unit Table 86**  
(index and instructions: [page 16-132](#) to [page 16-136](#))

Motor FLC (A)	Thermal Unit Number
0.43-0.44	A 49
0.45-0.47	A 54
0.48-0.53	A 59
0.54-0.61	A 65
0.62-0.65	A 71
0.66-0.71	A 78
0.72-0.79	A 86
0.80-0.86	A 95
0.87-0.96	A 1.02
0.97-1.04	A 1.16
1.05-1.17	A 1.25
1.18-1.31	A 1.39
1.32-1.38	A 1.54
1.39-1.47	A 1.63
1.48-1.57	A 1.75
1.58-1.65	A 1.86
1.66-1.77	A 1.99
1.78-1.93	A 2.15
1.94-2.18	A 2.31
2.19-2.46	A 2.57
2.47-2.68	A 2.81
2.69-2.87	A 3.61
2.88-3.07	A 3.95
3.08-3.59	A 4.32
3.60-3.79	A 4.79
3.80-4.27	A 5.30
4.28-4.59	A 5.78
4.60-4.90	A 6.20
4.91-5.06	A 6.99
5.07-5.44	A 7.65
5.45-6.24	A 8.38
6.25-7.21	A 9.25
7.22-7.69	A 9.85
7.70-8.24	A 11.0
8.25-8.81	A 11.9
8.82-9.32	A 13.2
9.33-9.99	A 14.1
10.0-10.5	A 14.8
10.6-11.5	A 16.2
11.6-12.2	A 17.9
12.3-13.3	A 21.3
13.4-15.8	A 25.2
15.9-18.4	A 27.1
18.5-20.5	A 29.5
20.6-21.5	A 31.9
21.6-23.9	A 33.8
24.0-26.8	A 35.9
26.9-28.2	A 40.0
28.3-29.8	A 42.3
29.9-32.0	A 44.7

**Thermal Unit Table 88**  
(index and instructions: [page 16-132](#) to [page 16-136](#))

Motor FLC (A)	Thermal Unit Number
0.39-0.40	A 49
0.41-0.44	A 54
0.45-0.49	A 59
0.50-0.57	A 65
0.58-0.61	A 71
0.62-0.66	A 78
0.67-0.73	A 86
0.74-0.80	A 95
0.81-0.90	A 1.02
0.91-0.97	A 1.16
0.98-1.09	A 1.25
1.10-1.23	A 1.39
1.24-1.57	A 1.86
1.58-1.66	A 1.99
1.67-1.79	A 2.15
1.80-1.99	A 2.31
2.00-2.31	A 2.57
2.32-2.50	A 2.81
2.51-2.66	A 3.61
2.67-2.85	A 3.95
2.86-3.26	A 4.32
3.27-3.49	A 4.79
3.50-3.92	A 5.30
3.93-4.20	A 5.78
4.21-4.49	A 6.20
4.50-4.64	A 6.99
4.65-4.94	A 7.65
4.95-5.62	A 8.38
5.63-6.39	A 9.25
6.40-6.82	A 9.85
6.83-7.27	A 11.0
7.28-7.71	A 11.9
7.72-8.13	A 13.2
8.14-8.64	A 14.1
8.65-9.15	A 14.8
9.16-9.97	A 16.2
9.98-11.0	A 17.9

**Thermal Unit Table 87**  
(index and instructions: [page 16-132](#) to [page 16-136](#))

Motor FLC (A)	Thermal Unit Number
0.40-0.41	A 49
0.42-0.45	A 54
0.46-0.51	A 59
0.52-0.58	A 65
0.59-0.63	A 71
0.64-0.68	A 78
0.69-0.76	A 86
0.77-0.83	A 95
0.84-0.93	A 1.02
0.94-1.01	A 1.16
1.02-1.14	A 1.25
1.15-1.28	A 1.39
1.29-1.34	A 1.54
1.35-1.44	A 1.63
1.45-1.55	A 1.75
1.56-1.61	A 1.86
1.62-1.71	A 1.99
1.72-1.85	A 2.15
1.86-2.04	A 2.31
2.05-2.38	A 2.57
2.39-2.60	A 2.81
2.61-2.77	A 3.61
2.78-2.98	A 3.95
2.99-3.40	A 4.32
3.41-3.64	A 4.79
3.65-4.08	A 5.30
4.09-4.38	A 5.78
4.39-4.68	A 6.20
4.69-4.79	A 6.99
4.80-5.11	A 7.65
5.12-5.84	A 8.38
5.85-6.70	A 9.25
6.71-7.18	A 9.85
7.19-7.70	A 11.0
7.71-8.14	A 11.9
8.15-8.56	A 13.2
8.57-9.15	A 14.1
9.16-9.80	A 14.8
9.81-10.6	A 16.2
10.7-11.0	A 17.9

**Thermal Unit Table 89**  
(index and instructions: [page 16-132](#) to [page 16-136](#))

Motor FLC (A)	Thermal Unit Number
10.0-11.1	B 17.5
11.2-12.0	B 19.5
12.1-13.3	B 22.0
13.4-15.1	B 25.0
15.2-17.1	B 28.0
17.2-18.6	B 32.0
18.7-21.4	B 36.0
21.5-25.7	B 40.0
25.8-28.2	B 45.0
28.3-29.7	B 50.0
29.8-31.2	B 56.0
31.3-32.1	B 62.0
32.2-35.7	B 70.0
35.8-40.7	B 79.0
40.8-48.0	B 88.0

**Thermal Unit Table 90**  
(index and instructions: [page 16-132](#) to [page 16-136](#))

Motor FLC (A)	Thermal Unit Number
4.88-5.13	A 7.65
5.14-5.85	A 8.38
5.86-6.67	A 9.25
6.68-7.09	A 9.85
7.10-7.62	A 11.0
7.63-8.04	A 11.9
8.05-8.46	A 13.2
8.47-9.11	A 14.1
9.12-9.69	A 14.8
9.70-10.5	A 16.2
10.6-11.6	A 17.9
11.7-12.3	A 21.3
12.4-14.6	A 25.2
14.7-16.8	A 27.1
16.9-17.9	A 29.5
18.0-18.7	A 31.9
18.8-19.8	A 33.8
19.9-21.4	A 35.9
21.5-22.8	A 40.0
22.9-23.8	A 42.3
23.9-26.0	A 44.7

**Thermal Unit Table 91**

(index and instructions: [page 16-132](#) to [page 16-136](#))

Motor FLC (A)	Thermal Unit Number
4.80-5.07	A 7.65
5.08-5.73	A 8.38
5.74-6.48	A 9.25
6.49-6.90	A 9.85
6.91-7.25	A 11.0
7.26-7.81	A 11.9
7.82-8.29	A 13.2
8.30-8.81	A 14.1
8.82-9.40	A 14.8
9.41-10.0	A 16.2
10.1-11.1	A 17.9
11.2-11.7	A 21.3
11.8-13.7	A 25.2
13.8-16.0	A 27.1
16.1-16.9	A 29.5
17.0-17.7	A 31.9
17.8-18.7	A 33.8
18.8-20.2	A 35.9
20.3-21.4	A 40.0
21.5-22.5	A 42.3
22.6-23.8	A 44.7
23.9-26.0	A 48.0

**Thermal Unit Table 93**

(index and instructions: [page 16-132](#) to [page 16-136](#))

Motor FLC (A)	Thermal Unit Number
23.8-25.2	CC 36.4
25.3-26.8	CC 39.6
26.9-28.4	CC 42.7
28.5-30.3	CC 46.6
30.4-32.1	CC 50.1
32.2-34.2	CC 54.5
34.3-36.3	CC 59.4
36.4-40.2	CC 64.3
40.3-43.1	CC 68.5
43.2-45.9	CC 74.6
46.0-49.2	CC 81.5
49.3-51.6	CC 87.7
51.7-54.2	CC 94.0
54.3-55.7	CC 103.0
55.8-60.3	CC 112.0
60.4-63.5	CC 121.0
63.6-67.1	CC 132.0
67.2-70.3	CC 143.0
70.4-74.1	CC 156.0
74.2-78.3	CC 167.0
78.4-83.3	CC 180.0
83.4-86.0	CC 196.0

**Thermal Unit Table 95**

(index and instructions: [page 16-132](#) to [page 16-136](#))

Motor FLC (A)	Thermal Unit Number
42.5-44.7	CC 64.3
44.8-47.9	CC 68.5
48.0-51.2	CC 74.6
51.3-55.2	CC 81.5
55.3-59.4	CC 87.7
59.5-63.8	CC 94.0
63.9-68.8	CC 103.0
68.9-73.8	CC 112.0
73.9-77.7	CC 121.0
77.8-82.5	CC 132.0
82.6-86.6	CC 143.0
86.7-91.9	CC 156.0
92.0-97.2	CC 167.0
97.3-104	CC 180.0
105-114	CC 196.0
115-123	CC 208.0
124-150	CC 219.0

**Thermal Unit Table 92**

(index and instructions: [page 16-132](#) to [page 16-136](#))

Motor FLC (A)	Thermal Unit Number
10.5-11.7	B 17.5
11.8-12.5	B 19.5
12.6-14.0	B 22.0
14.1-15.8	B 25.0
15.9-18.0	B 28.0
18.1-19.6	B 32.0
19.7-23.5	B 36.0
23.6-27.4	B 40.0
27.5-30.5	B 45.0
30.6-32.2	B 50.0
32.3-34.0	B 56.0
34.1-35.2	B 62.0
35.3-39.5	B 70.0
39.6-43.9	B 79.0
44.0-48.0	B 88.0

**Thermal Unit Table 94**

(index and instructions: [page 16-132](#) to [page 16-136](#))

Motor FLC (A)	Thermal Unit Number
25.8-27.5	CC 36.4
27.6-29.4	CC 39.6
29.5-31.4	CC 42.7
31.5-33.2	CC 46.6
33.3-36.2	CC 50.1
36.3-38.8	CC 54.5
38.9-41.6	CC 59.4
41.7-44.7	CC 64.3
44.8-47.9	CC 68.5
48.0-50.9	CC 74.6
51.0-54.4	CC 81.5
54.5-57.4	CC 87.7
57.5-60.6	CC 94.0
60.7-63.9	CC 103.0
64.0-68.4	CC 112.0
68.5-73.4	CC 121.0
73.5-78.7	CC 132.0
78.8-83.8	CC 143.0
83.9-86.0	CC 156.0

**Thermal Unit Table 96**

(index and instructions: [page 16-132](#) to [page 16-136](#))

Motor FLC (A)	Thermal Unit Number
49.5-52.0	CC 64.3
52.1-54.8	CC 68.5
54.9-58.7	CC 74.6
58.8-63.3	CC 81.5
63.4-68.3	CC 87.7
68.4-73.6	CC 94.0
73.7-79.4	CC 103.0
79.5-85.5	CC 112.0
85.6-89.7	CC 121.0
89.8-94.8	CC 132.0
94.9-99.9	CC 143.0
100-105	CC 156.0
106-111	CC 167.0
112-126	CC 180.0
127-131	CC 196.0
132-141	CC 208.0
142-150	CC 219.0

Thermal Unit Table 103

(index and instructions: [page 16-132 to page 16-136](#))

Motor FLC (A)	Thermal Unit Number
40.8-45.5	B 1.03
45.6-49.9	B 1.16
51.0-57.5	B 1.30
57.6-65.9	B 1.45
66.0-73.1	B 1.67
73.2-81.5	B 1.88
81.6-92.3	B 2.10
92.4-104	B 2.40
105-114	B 2.65
115-128	B 3.00
129-140	B 3.30
141-160	B 3.70
161-193	B 4.15
194-209	B 4.85
210-232	B 5.50
233-248	B 6.25
249-266	B 6.90

Thermal Unit Table 104

(index and instructions: [page 16-132 to page 16-136](#))

Motor FLC (A)	Thermal Unit Number	Max. Fuse Rating (A)	
0.65-0.73	B 1.03	1.50	
0.74-0.82	B 1.16	1.50	
0.93-0.91	B 1.30	1.60	
0.92-1.04	B 1.45	2.00	
1.05-1.16	B 1.67	2.00	
1.17-1.26	B 1.88	2.25	
1.27-1.47	B 2.10	2.60	
1.48-1.65	B 2.40	3.00	
1.66-1.89	B 2.65	3.50	
1.90-2.17	B 3.00	4.00	
2.18-2.49	B 3.30	4.50	
2.50-2.79	B 3.70	5.00	
2.80-3.13	B 4.15	5.60	
3.14-3.36	B 4.85	6.00	
3.37-3.69	B 5.50	7.00	
3.70-3.92	B 6.25	7.00	
3.93-4.42	B 6.90	8.00	
4.43-4.99	B 7.70	9.00	
5.00-5.27	B 8.20	10.0	
5.28-5.84	B 9.10	12.0	
5.85-6.61	B 10.2	12.0	
6.62-7.42	B 11.5	15.0	
7.43-8.02	B 12.8	15.0	
8.03-8.53	B 14.0	15.0	
8.54-9.34	B 15.5	17.5	
9.35-10.1	B 17.5	17.5	
10.2-10.8	B 19.5	20.0	
10.9-12.0	B 22.0	25.0	
12.1-13.0	B 25.0	25.0	
13.1-15.5	B 28.0	30.0	
		600 V Max.	250 V Max.
15.6-17.9	B 32.0	30	30
18.0-21.4	B 36.0	30	40
21.5-25.1	B 40.0	30	40
25.2-27.0	B 45.0	30	40

Thermal Unit Table 105

(index and instructions: [page 16-132 to page 16-136](#))

Motor FLC (A)	Thermal Unit Number
105-112	CC 74.6
113-122	CC 81.5
123-131	CC 87.7
132-142	CC 94.0
143-153	CC 103.0
154-157	CC 112.0
158-169	CC 121.0
170-181	CC 132.0
182-195	CC 143.0
196-209	CC 156.0
210-227	CC 167.0
228-247	CC 180.0
248-266	CC 196.0

Thermal Unit Table 109

(index and instructions: [page 16-132 to page 16-136](#))

Motor FLC (A)	Thermal Unit Number
0.56-0.63	B 0.81
0.64-0.68	B 0.92
0.69-0.77	B 1.03
0.78-0.85	B 1.16
0.86-0.97	B 1.30
0.98-1.09	B 1.45
1.10-1.21	B 1.67
1.22-1.33	B 1.88
1.34-1.53	B 2.10
1.54-1.73	B 2.40
1.74-1.89	B 2.65
1.90-2.17	B 3.00
2.18-2.53	B 3.30
2.54-2.87	B 3.70
2.88-3.22	B 4.15
3.23-3.49	B 4.85
3.50-3.85	B 5.50
3.86-4.11	B 6.25
4.12-4.70	B 6.90
4.71-5.21	B 7.70
5.22-5.53	B 8.20
5.54-6.17	B 9.10
6.18-7.02	B 10.2
7.03-7.92	B 11.5
7.93-8.61	B 12.8
8.62-9.17	B 14.0
9.18-10.0	B 15.5
10.1-11.0	B 17.5
11.1-11.8	B 19.5
11.9-13.5	B 22.0
13.6-15.3	B 25.0
15.4-17.4	B 28.0
17.5-19.4	B 32.0
19.5-22.2	B 36.0
22.3-25.1	B 40.0
25.2-27.0	B 45.0

**Thermal Unit Table 110**

(index and instructions: [page 16-132 to page 16-136](#))

Motor FLC (A)	Thermal Unit Number
3.94–4.45	B 6.90
4.46–4.97	B 7.70
4.98–5.28	B 8.20
5.29–5.97	B 9.10
5.98–6.89	B 10.2
6.90–7.92	B 11.5
7.93–8.71	B 12.8
8.72–9.27	B 14.0
9.28–10.2	B 15.5
10.3–11.4	B 17.5
11.5–12.3	B 19.5
12.4–13.9	B 22.0
14.0–15.8	B 25.0
15.9–17.9	B 28.0
18.0–19.9	B 32.0
20.0–22.8	B 36.0
22.9–25.4	B 40.0
25.5–28.9	B 45.0
29.0–30.8	B 50.0
30.9–32.5	B 56.0
32.6–34.9	B 62.0
35.0–39.7	B 70.0
39.8–44.7	B 79.0

**Thermal Unit Table 112**

(index and instructions: [page 16-132 to page 16-136](#))

Motor FLC (A)	Thermal Unit Number
44.0–46.8	CC 64.3
46.9–50.6	CC 68.5
50.7–54.5	CC 74.6
54.6–58.4	CC 81.5
58.5–62.9	CC 87.7
63.0–67.7	CC 94.0
67.8–72.9	CC 103.0
73.0–78.1	CC 112.0
78.2–83.9	CC 121.0
84.0–91.1	CC 132.0
91.2–97.5	CC 143.0
97.6–104	CC 156.0
105–113	CC 167.0
114–133	CC 180.0

**Thermal Unit Table 114**

(index and instructions: [page 16-132 to page 16-136](#))

Motor FLC (A)	Thermal Unit Number
133–148	B 1.30
149–174	B 1.45
175–195	B 1.67
196–219	B 1.88
220–239	B 2.10
240–271	B 2.40
272–308	B 2.65
309–348	B 3.00
349–397	B 3.30
398–429	B 3.70
430–495	B 4.15
496–520	B 4.85

**Thermal Unit Table 116**

(index and instructions: [page 16-132 to page 16-136](#))

Motor FLC (A)	Thermal Unit Number
81.6–91.1	B 1.03
91.2–101	B 1.16
102–115	B 1.30
116–131	B 1.45
132–146	B 1.67
147–163	B 1.88
164–184	B 2.10
185–209	B 2.40
210–229	B 2.65
230–257	B 3.00
258–281	B 3.30
282–321	B 3.70
322–387	B 4.15
388–419	B 4.35
420–465	B 5.60
466–497	B 6.25
498–532	B 6.90

**Thermal Unit Table 111**

(index and instructions: [page 16-132 to page 16-136](#))

Motor FLC (A)	Thermal Unit Number
14.0–14.9	CC 20.9
15.0–16.2	CC 22.8
16.3–17.2	CC 24.6
17.3–18.7	CC 26.3
18.8–20.2	CC 28.8
20.3–21.7	CC 31.0
21.8–23.3	CC 33.3
23.4–25.2	CC 36.4
25.3–27.1	CC 39.6
27.2–29.4	CC 42.7
29.5–31.6	CC 46.6
31.7–34.0	CC 50.1
34.1–36.8	CC 54.5
36.9–39.8	CC 59.4
39.9–42.3	CC 64.3
42.4–45.7	CC 68.5
45.8–49.2	CC 74.6
49.3–52.8	CC 81.5
52.9–56.8	CC 87.7
56.9–61.2	CC 94.0
61.3–66.1	CC 103.0
66.2–71.2	CC 112.0
71.3–76.7	CC 121.0
76.8–82.9	CC 132.0
83.0–90.0	CC 143.0

**Thermal Unit Table 113**

(index and instructions: [page 16-132 to page 16-136](#))

Motor FLC (A)	Thermal Unit Number
88.2–95.1	DD 112.0
95.2–101	DD 121.0
102–111	DD 128.0
112–119	DD 140.0
120–131	DD 150.0
132–149	DD 160.0
150–170	DD 185.0
171–180	DD 220.0
181–197	DD 240.0
198–204	DD 250.0
205–213	DD 265.0
214–237	DD 280.0
238–243	DD 300.0
244–266	DD 320.0

**Thermal Unit Table 115**

(index and instructions: [page 16-132 to page 16-136](#))

Motor FLC (A)	Thermal Unit Number
176–190	DD 112.0
191–203	DD 121.0
203–223	DD 128.0
224–239	DD 140.0
240–253	DD 150.0
254–299	DD 160.0
300–341	DD 185.0
342–361	DD 220.0
362–395	DD 240.0
396–409	DD 250.0
410–427	DD 265.0
428–475	DD 289.0
476–487	DD 300.0
488–532	DD 320.0

Thermal Unit Table 127

(index and instructions: [page 16-132 to page 16-136](#))

Motor FLC (A)	Thermal Unit Number
1.12-1.27	B 0.81
1.28-1.37	B 0.92
1.38-1.55	B 1.03
1.56-1.71	B 1.16
1.72-1.95	B 1.30
1.96-2.19	B 1.45
2.20-2.43	B 1.67
2.44-2.67	B 1.88
2.68-3.07	B 2.10
3.08-3.47	B 2.40
3.48-3.79	B 2.65
3.80-4.35	B 3.00
4.36-5.07	B 3.30
5.08-5.75	B 3.70
5.76-6.45	B 4.15
6.46-6.99	B 4.85
7.00-7.71	B 5.50
7.72-8.23	B 6.25
8.24-9.41	B 6.90
9.42-10.43	B 7.70
10.44-11.07	B 8.20
11.08-12.35	B 9.10
12.36-14.05	B 10.2
14.06-15.85	B 11.5
15.86-17.23	B 12.8
17.24-18.35	B 14.0
18.36-20.1	B 15.5
20.2-22.1	B 17.5
22.2-23.7	B 19.5
23.8-27.1	B 22.0
27.2-30.7	B 25.0
30.8-34.9	B 28.0
35.0-38.9	B 32.0
39.0-44.5	B 36.0
44.6-50.3	B 40.0
50.4-54.0	B 45.0

Thermal Unit Table 129

(index and instructions: [page 16-132 to page 16-136](#))

Motor FLC (A)	Thermal Unit Number
28.0-29.9	CC 20.9
30.0-32.5	CC 22.8
32.6-34.5	CC 24.6
34.6-37.5	CC 26.3
37.6-40.5	CC 28.8
40.6-43.5	CC 31.0
43.6-46.7	CC 33.3
46.8-50.5	CC 36.4
50.6-54.3	CC 39.6
54.4-58.9	CC 42.7
59.0-63.3	CC 46.6
63.4-68.1	CC 50.1
68.2-73.7	CC 54.5
73.8-79.7	CC 59.4
79.8-84.7	CC 64.5
84.8-91.5	CC 68.5
91.6-98.5	CC 74.6
98.6-105.7	CC 81.5
105.8-113.7	CC 87.7
113.8-122.5	CC 94.0
122.6-132.3	CC 103.0
132.4-142.5	CC 112.0
142.6-153.5	CC 121.0
153.6-165.9	CC 132.0
166.0-180.0	CC 143.0

Thermal Unit Table 134

(index and instructions: [page 16-132 to page 16-136](#))

Motor FLC (A)	Thermal Unit Number
4.30-4.98	B 6.90
4.99-5.57	B 7.70
5.58-5.94	B 8.20
5.95-6.71	B 9.10
6.72-7.79	B 10.2
7.80-8.93	B 11.5
8.94-9.77	B 12.8
9.78-10.5	B 14.0
10.6-11.7	B 15.5
11.8-13.0	B 17.5
13.1-14.0	B 19.5
14.1-15.0	B 22.0
15.1-17.2	B 25.0
17.3-19.9	B 28.0
20.0-22.3	B 32.0
22.4-26.0	B 36.0
26.1-29.8	B 40.0
29.9-34.0	B 45.0
34.1-36.7	B 50.0
36.8-39.5	B 56.0
39.6-42.1	B 62.0
42.2-46.6	B 70.0
46.7-51.5	B 79.0
51.6-54.0	B 88.0

Thermal Unit Table 128

(index and instructions: [page 16-132 to page 16-136](#))

Motor FLC (A)	Thermal Unit Number
7.88-8.91	B 6.90
8.92-9.95	B 7.70
9.96-10.57	B 8.20
10.58-11.95	B 9.10
11.96-13.79	B 10.2
13.80-15.85	B 11.5
15.86-17.43	B 12.8
17.44-18.55	B 14.0
18.56-20.5	B 15.5
20.6-22.9	B 17.5
23.0-24.7	B 19.5
24.8-27.9	B 22.0
28.0-31.7	B 25.0
31.8-35.9	B 28.0
36.0-39.9	B 32.0
40.0-45.7	B 36.0
45.8-50.9	B 40.0
51.0-61.7	B 45.0
61.8-65.1	B 50.0
65.2-69.9	B 56.0
70.0-79.5	B 62.0
79.6-89.4	B 70.0

Thermal Unit Table 133

(index and instructions: [page 16-132 to page 16-136](#))

Motor FLC (A)	Thermal Unit Number
4.60-5.23	B 6.90
5.24-5.86	B 7.70
5.87-6.25	B 8.20
6.26-7.09	B 9.10
7.10-8.25	B 10.2
8.26-9.49	B 11.5
9.50-10.3	B 12.8
10.4-11.2	B 14.0
11.3-12.5	B 15.5
12.6-13.8	B 17.5
13.9-15.0	B 19.5
15.1-16.9	B 22.0
17.0-19.1	B 25.0
19.2-22.0	B 28.0
22.1-24.4	B 32.0
24.5-28.0	B 36.0
28.1-31.8	B 40.0
31.9-36.0	B 45.0
36.1-38.5	B 50.0
38.6-41.2	B 56.0
41.3-44.4	B 62.0
44.5-50.3	B 70.0
50.4-56.9	B 79.0
57.0-59.0	B 88.0



**Thermal Unit Table 135**

(index and instructions: [page 16-132 to page 16-136](#))

Motor FLC (A)		Thermal Unit Number
1 T.U.	3 T.U.	
0.77-0.88	0.85-0.95	B 1.30
0.89-1.02	0.96-1.09	B 1.45
1.03-1.19	1.10-1.21	B 1.67
1.20-1.37	1.22-1.35	B 1.88
1.38-1.62	1.36-1.56	B 2.10
1.63-1.90	1.57-1.76	B 2.40
1.91-2.12	1.77-1.94	B 2.65
2.13-2.46	1.95-2.22	B 3.00
2.47-2.83	2.23-2.57	B 3.30
2.84-3.19	2.58-2.87	B 3.70
3.20-3.61	2.88-3.21	B 4.15
3.62-3.89	3.22-3.50	B 4.85
3.90-4.32	3.51-3.79	B 5.50
4.33-4.57	3.80-4.04	B 6.25
4.58-5.19	4.05-4.53	B 6.90
5.20-5.79	4.54-5.03	B 7.70
5.80-6.16	5.04-5.36	B 8.20
6.17-6.94	5.37-5.97	B 9.10
6.95-7.99	5.98-6.89	B 10.2
7.80-8.99	6.90-7.79	B 11.5
9.00-9.98	7.80-8.53	B 12.8
9.99-10.6	8.54-9.09	B 14.0
10.7-11.6	9.10-9.99	B 15.5
11.7-13.1	10.0-10.9	B 17.5
13.2-14.2	11.0-11.7	B 19.5
14.3-15.4	11.8-13.4	B 22.0
15.5-17.6	13.5-15.4	B 25.0
17.7-20.0	15.5-17.9	B 28.0
-	18.0-20.0	B 32.0
For Type DPSG12 & DPSG13, 20 A Starter. Select Thermal Units from above.		
20.1-22.7	18.0-20.2	B 32.0
22.8-25.0	20.3-23.2	B 36.0
-	23.3-25.0	B 40.0
For Type DPSG22 & DPSG23, 25 A Starter. Select any of the Thermal Units from above.		
22.8-26.1	-	B 36.0
26.2-29.6	23.3-25.8	B 40.0
29.7-30.0	25.9-28.6	B 45.0
For Type DPSG32 & DPSG33, 30 A Starter. Select any of the Thermal Units from above.		

**Thermal Unit Table 145**

(index and instructions: [page 16-132 to page 16-136](#))

Motor FLC (A)		Thermal Unit Number
1 T.U.	3 T.U.	
1.00-1.11	0.91-1.02	B1.30
1.12-1.27	1.03-1.15	B1.45
1.28-1.36	1.16-1.27	B1.67
1.37-1.53	1.28-1.39	B1.88
1.54-1.78	1.40-1.61	B2.10
1.79-2.02	1.62-1.84	B2.40
2.03-2.20	1.85-2.03	B2.65
2.21-2.52	2.04-2.34	B3.00
2.53-2.94	2.35-2.69	B3.30
2.95-3.30	2.70-3.02	B3.70
3.31-3.70	3.03-3.39	B4.15
3.71-4.02	3.40-3.65	B4.85
4.03-4.46	3.66-4.04	B5.50
4.47-4.69	4.05-4.28	B6.25
4.70-5.37	4.29-4.85	B6.90
5.38-5.94	4.86-5.38	B7.70
5.95-6.34	5.39-5.71	B8.20
6.35-7.09	5.72-6.39	B9.10
7.10-8.46	6.40-7.53	B10.2
8.47-9.32	7.54-8.34	B11.5
9.33-10.2	8.35-9.14	B12.8
10.3-10.9	9.15-9.74	B14.0
11.0-12.1	9.75-10.7	B15.5
12.2-13.4	10.8-11.8	B17.5
13.5-14.2	11.9-12.2	B19.5
14.3-16.0	12.3-14.4	B22.0
16.1-18.1	14.5-16.4	B25.0
18.2-20.5	16.5-18.9	B28.0
20.6-23.5	19.0-21.3	B32.0
23.6-27.2	21.4-23.3	B36.0
27.3-30.8	23.4-27.9	B40.0
30.9-35.0	28.0-31.4	B45.0
35.1-37.2	-	B50.0
37.3-40.0	-	B56.0
For Type DPSG42 & DPSG43, 40 A Starter. Select any of the Thermal Units from above.		

**Thermal Unit Table 136**

(index and instructions: [page 16-132 to page 16-136](#))

Motor FLC (A)		Thermal Unit Number
1 T.U.	3 T.U.	
0.98-1.09	0.88-0.98	B 1.30
1.10-1.24	0.99-1.13	B 1.45
1.25-1.41	1.14-1.26	B 1.67
1.42-1.59	1.27-1.38	B 1.88
1.60-1.81	1.39-1.62	B 2.10
1.82-2.04	1.63-1.82	B 2.40
2.05-2.19	1.83-2.04	B 2.65
2.20-2.52	2.05-2.36	B 3.00
2.53-2.90	2.37-2.72	B 3.30
2.91-3.29	2.73-3.07	B 3.70
3.30-3.69	3.08-3.44	B 4.15
3.70-3.99	3.45-3.69	B 4.85
4.00-4.42	3.70-4.11	B 5.50
4.43-4.69	4.12-4.34	B 6.25
4.70-5.37	4.35-4.89	B 6.90
5.38-5.94	4.90-5.44	B 7.70
5.95-6.34	5.45-5.80	B 8.20
6.35-7.05	5.81-6.47	B 9.10
7.06-8.14	6.48-7.45	B 10.2
8.15-9.39	7.46-8.49	B 11.5
9.40-10.3	8.50-9.29	B 12.8
10.4-11.1	9.30-9.99	B 14.0
11.2-12.2	10.0-10.8	B 15.5
12.3-13.5	10.9-12.1	B 17.5
13.6-14.7	12.2-13.1	B 19.5
14.8-16.1	13.2-14.6	B 22.0
16.2-18.3	14.7-16.4	B 25.0
18.4-20.0	16.5-18.9	B 28.0
-	19.0-20.0	B 32.0
For Type DPSO12 & DPSO13, 20 A Starter. Select Thermal Units from above.		
18.4-20.9	-	B 28.0
21.0-23.6	19.0-20.9	B 32.0
23.7-25.0	21.0-24.1	B 36.0
-	24.2-25.0	B 40.0
For Type DPSO22 & DPSO23, 25 A Starter. Select any of the Thermal Units from above.		
23.7-27.2	-	B 36.0
27.3-30.0	24.2-27.2	B 40.0
-	27.3-30.0	B 45.0
For Type DPSO32 & DPSO33, 30 A Starter. Select any of the Thermal Units from above.		

**Thermal Unit Table 146**

(index and instructions: [page 16-132 to page 16-136](#))

Motor FLC (A)		Thermal Unit Number
1 T.U.	3 T.U.	
3.90-4.22	3.60-3.89	B5.50
4.23-4.49	3.90-4.15	B6.25
4.50-5.14	4.16-4.76	B6.90
5.15-5.78	4.77-5.30	B7.70
5.79-6.23	5.31-5.70	B8.20
6.24-7.03	5.71-6.46	B9.10
7.04-8.23	6.47-7.65	B10.2
8.24-9.31	7.66-8.55	B11.5
9.32-10.1	8.56-9.36	B12.8
10.2-10.7	9.37-9.9	B14.0
10.8-11.9	10.0-10.9	B15.5
12.0-13.1	11.0-12.0	B17.5
13.2-13.9	12.1-12.8	B19.5
14.0-15.9	12.9-14.2	B22.0
16.0-18.0	14.3-16.0	B25.0
18.1-20.8	16.1-18.5	B28.0
20.9-23.1	18.6-21.2	B32.0
23.2-26.9	21.3-24.9	B36.0
27.0-31.4	25.0-28.0	B40.0
31.5-36.0	28.1-31.7	B45.0
36.1-38.8	31.8-34.6	B50.0
38.9-41.7	34.7-37.4	B56.0
41.8-46.3	37.5-40.0	B62.0
46.4-50.0	40.1-46.4	B70.0
-	46.5-50.0	B79.0
For Type DPSG52 & DPSG53, 50 A Starter. Select any of the Thermal Units from above.		

**Thermal Unit Table 147**  
(index and instructions: [page 16-132](#) to [page 16-136](#))

Motor FLC (A)		Thermal Unit Number
1 T.U.	3 T.U.	
1.04-1.14	0.93-1.04	B1.30
1.15-1.29	1.05-1.18	B1.45
1.30-1.43	1.19-1.33	B1.67
1.44-1.56	1.34-1.43	B1.88
1.57-1.79	1.44-1.67	B2.10
1.80-2.03	1.68-1.88	B2.40
2.04-2.26	1.89-2.09	B2.65
2.27-2.51	2.10-2.41	B3.00
2.52-3.03	2.42-2.79	B3.30
3.04-3.31	2.80-3.15	B3.70
3.32-3.73	3.16-3.54	B4.15
3.74-4.07	3.55-3.75	B4.85
4.08-4.49	3.76-4.22	B5.50
4.50-4.76	4.23-4.46	B5.25
4.77-5.44	4.47-5.09	B6.90
5.45-6.04	5.10-5.61	B7.70
6.05-6.46	5.62-5.99	B8.20
6.47-7.24	6.00-6.70	B9.10
7.25-8.64	6.71-8.19	B10.20
8.65-9.59	8.20-8.79	B11.5
9.60-10.5	8.80-9.66	B12.8
10.6-11.3	9.67-10.2	B14.0
11.4-12.6	10.3-11.4	B15.5
12.7-13.9	11.5-12.6	B17.5
14.0-14.9	12.7-13.5	B19.5
15.0-16.5	13.6-15.1	B22.0
16.6-18.9	15.2-17.2	B25.0
19.0-22.2	17.3-19.9	B28.0
22.3-24.6	20.0-22.5	B32.0
24.7-28.6	22.6-26.2	B36.0
28.7-32.4	26.3-29.9	B40.0
32.5-37.3		B45.0
37.4-39.5		B50.0
39.6-40.0		B56.0
For Type DPSO42 & DPSO43, 40 A Starter. Select any of the Thermal Units from above.		

**Thermal Unit Table 148**  
(index and instructions: [page 16-132](#) to [page 16-136](#))

Motor FLC (A)		Thermal Unit Number
1 T.U.	3 T.U.	
4.14-4.45	3.70-4.09	B5.50
4.46-4.88	4.10-4.35	B6.25
4.89-5.44	4.36-5.07	B6.90
5.45-6.08	5.08-5.79	B7.70
6.09-6.42	5.80-6.27	B8.20
6.43-7.28	6.28-7.16	B9.10
7.29-8.42	7.17-8.58	B10.2
8.43-9.64	8.59-9.55	B11.5
9.65-10.4	9.56-10.2	B12.8
10.5-11.2	10.3-10.9	B14.0
11.3-12.3	11.0-11.9	B15.5
12.4-13.7	12.0-13.1	B17.5
13.8-14.8	13.2-14.0	B19.5
14.9-16.5	14.1-14.8	B22.0
16.6-18.7	14.9-17.0	B25.0
18.8-21.4	17.1-19.6	B28.0
21.5-24.3	19.7-22.1	B32.0
24.4-28.0	22.2-26.0	B36.0
28.1-33.3	26.1-29.4	B40.0
33.4-37.6	29.5-34.0	B45.0
37.7-41.1	34.1-36.4	B50.0
41.2-44.1	36.5-39.2	B56.0
44.2-47.8	39.3-42.4	B62.0
47.9-50.0	42.5-49.3	B70.0
—	49.4-50.0	B79.0
For Type DPSO52 & DPSO53, 50 A Starter. Select any of the Thermal Units from above.		

# Section 17

## Motor Control Centers



Model 6 Unit



Model 6 Motor Control Center

<b>Structure and Unit Features</b>	<b>17-2</b>
Features, Merchandised Units	17-2
Model 6 Structure Features	17-2
Model 6 Arc Resistant	17-2
Model 6 ArcBlok	17-2
Model 6 Unit Features	17-3
Intelligent Motor Control Center—Model 6 iMCC	17-3
Merchandised Units (shipment in as low as 3 days)	17-4
Combination Starter Units Catalog Numbering System	17-4
<b>MCC Units</b>	<b>17-5</b>
Combination Starter Units	17-5
Combination Starters Units with Motor Circuit Protector	
Disconnects	17-5
Combination Starter Units with Fusible Switch Disconnects	17-6
Compac™ 6 Combination Starter Units with Motor Circuit Protector	
Disconnects	17-7
Compac™ 6 Combination Starter Units with Fusible Switch	
Disconnects	17-7
Branch Feeder Units	17-8
Circuit Breaker Branch Feeder Units	17-8
Fusible Branch Feeder Units	17-8
Model 6 Blank Doors	17-8

### Overview

Designed and manufactured to tackle the toughest power and process control challenges, the Model 6 Motor Control Center features industry-finest innovations that provide unmatched performance, high reliability, and low maintenance. The Model 6 Motor Control Center has integrated industry-leading components into the smallest and most flexible footprint possible to meet your power, control, and automation needs. The Model 6 offers superior quality, increased uptime, and features that improve the protection of your personnel and facility from electrical safety hazards.



Model 6 Motor Control Center

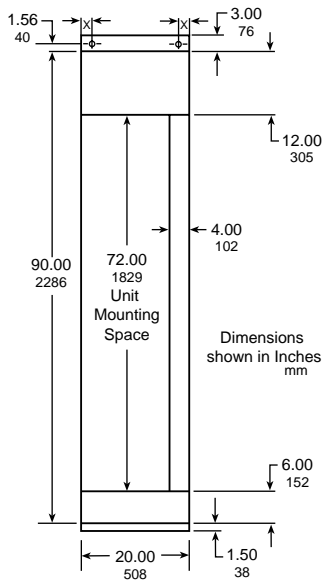

20-in. (508 mm)-wide Section with Standard Vertical Wireway



**Model 6 Structure Features**

- Horizontal main bus uses captive splice bar assembly; allows splicing without removing units
- Horizontal bus is located at the top of the structure for easy installation, inspection and maintenance
- Available ampacity 600 A, 800 A, 1200 A, 2000 A, 2500 A, and 3200 A
- Sliding non-conductive horizontal bus barrier
- 300 A, 600 A, and 1200 A vertical bus
- Vertical bus openings on 3-inch centers
- Optional automatic vertical bus shutters are available
- Base mounting channel includes lever notches for ease of alignment
- Full depth vertical wireway available, either 4-inch or 9-inch width
- Vertical ground bus is standard

**Model 6 Arc Resistant**

The Model 6 Arc Resistant Enclosure provides reliable arc flash containment through passive technology and design and has been witnessed and verified by UL for design and performance to the ANSI/IEEE C37.20.7 standard. Most of the standard offer configurations and units are available, making the Model 6 Arc Resistant MCC the industry's most complete offer.

**Certification and Validation:**

- Tested and certified performance to the industry's Arc Resistant Standard (ANSI/IEEE C37.20.7)
- Internal arc testing validated and witnessed by UL
- Industry's highest MCC arc duration rating of 100 milliseconds (6 Cycles)

**Technical Specifications and Highlights:**

- Up to 65 kA at 600 VAC Rated
- Accessibility Type 2A
- Main bus up to 2000 A amps
- Optional insulated bus (Epoxy or Heat Shrink)
- Optional automatic bus shutters
- Optional exhaust plenums
- Reinforced enclosure: 12 gage steel doors and covers, additional fasteners and hinges
- Reinforced frame with additional internal supports
- Pathways inside the enclosure manage arc by-products and pressure
- iMCC remote monitoring and controlling
- MasterPact type LF (designed to limit arc energy) circuit breakers are available in upstream gear

**Model 6 ArcBlok**

The Square D™ brand Model 6 Low Voltage Motor Control Center (MCC) with ArcBlok™ by Schneider Electric™ is a game changer in electrical equipment protection and safety-related work practices. With ArcBlok arc isolation, the line side conductors are fully enclosed inside a cable vault, which has been tested for the ANSI/IEEE C37.20.7 requirements for arc containment. Not just a barrier, ArcBlok reduces the chance that an arc flash could occur and reduces and contains the arc energy if it does. Sensors inside the compartment continuously take thermal readings and communicate those to a mobile device, while maintenance personnel stand outside the arc flash zone to review.

**Build features include:**

- Steel barriers
- Lifting handles
- Bolts face outward for easy alignment
- Interior barriers separate phases
- Thermal sensors communicate data
- Absence of voltage tester
- Vents direct arc flash energy to minimize impact

**Technical Details**

- ArcBlok MCC: 100 kA at 208, 240 and 480 Vac; 50 kA at 600 Vac, up to 1200 A
- Line side testing was UL® witnessed in accordance with ANSI/IEEE C37.20.7-2017
- Model 6 MCCs are Listed to UL845 Standard and Certified to Canadian Standard C22.2 No. 254 and Mexican Standard NOM-003-SCFI-2014 (NMX-J-515-ANCE)
- PowerPact™ P Molded Case Circuit Breakers with ArcBlok Technology are Listed to the UL489 Standard and Certified to Canadian Standard C22.2 No. 5



Model 6

**Model 6 Unit Features**

- Metal operator handle, color coded for clear indication of disconnect position (including “Tripped”)
- Twin-handle cam mechanism standard on all plug-on units (except Compac™ 6)
- Rugged unit construction features solid rear sides and hinged bottom plates
- Forward tilted pull-apart control terminal blocks standard with NEMA Type B or C wiring
- Starter units available with Class 8536 Type S NEMA or D-Line IEC
- Available overload relays on starter include: melting alloy, Motor Logic™, and TeSys™ T
- Control station plate for pilot devices is mounted on front of unit
- Easily accessible control transformer
- Starter mounted on right-hand side of unit, adjacent to wireway, for ease of cable termination

**Table 17.1: Available units include:**

- |   |   |                                  |
|---|---|----------------------------------|
| • Automation equipment                        | • Reduced voltage starters                  | • Full voltage non-reversing     |
| • Altivar™ AC drives                          | • Distribution transformers and panelboards | • Full voltage reversing         |
| • Altistart™ soft starts                      | • 3–inch accessory units                    | • Circuit breaker branch feeders |
| • Surge Protection Device (SPD) units         | • Empty mounting units                      | • Fusible switch branch feeders  |
| • PowerLogic™ circuit monitor and power meter | • MasterPact™ drawout main circuit breakers | • Full voltage 2-speed           |
| • Compac 6 starters and branch feeders        | • Master terminal compartments              | • Programmable logic controllers |
|   | • Automatic transfer switches               | • Incoming devices               |
|   |   | • Tie breakers                   |

**Intelligent Motor Control Center—Model 6 iMCC**

Maximize customer value with the industry’s most comprehensive energy and asset management capabilities.

**Standard Architectures**

**SIMPLE**, standardized network designs create consistency and familiarity, reduce changes, accelerate startup and commissioning, and ultimately drive efficiency in existing operations and future expansions.

**Reduced Lead Times**

**FASTER** quotations, drawings, pricing, submittals, and manufacturing allow for shorter cycle times and increased flexibility to make changes later in the project as designs mature and requirements change.

**Ethernet Communications**

**OPEN** protocols in Modbus™ TCP and EtherNet/IP eliminate expensive proprietary software, hardware, and services. Both protocols provide the speed, reliability, and network services to easily and efficiently manage the entire network. Ethernet-based networks easily integrate with business systems for management across the enterprise.

**Integrated Wonderware Solution**

**COMPLETE** Wonderware solution allows the end user to perform comprehensive asset and energy management through simple, organized, and role-based screens. Power and process data can be viewed in real time or in trended report, which increases user awareness and delivers actionable data. Local or remote configuration, monitoring, and control provides optimal flexibility. Maximizing uptime, slashing troubleshooting, and delivering true predictive maintenance strategies become a reality with all the right information at the right time. Seamless integration into enterprise-level Invensys-based SCADA/DCS systems will save countless hours of unnecessary programming, engineering, and troubleshooting during both startup and operation.

**Merchandised Units (shipment in as low as 3 days)**

Model 6 Industrial Package units (white) are available for ordering by catalog number. A listing of types available by quick shipment may be found on the following pages. This limited offering includes popular combinations of types and options. Catalog numbers consist of class number (8998), disconnect and device types, horsepower or ampacity ratings and options (for example, 8998SBA001XFTMA). See table below. All units are UL Listed.

**Combination Starter Units Catalog Numbering System**

Units rated as follows:

- Model 6 Industrial Package, 480 V, 60 Hz, NEMA 12 enclosure
- Type 1B wiring, 100,000 AIR rating, 1 N.O./1 N.C. auxiliary interlock on each contactor

**Table 17.2: Numbering System [1]**

First	Second	Third	Fourth	Fifth	Sixth	Seventh	Eighth
8998	S	B	A	005	A	FT	MA
Class	Type	Disconnect	Device	Motor Hp	Pilot Device Function	Control Power	Overload Relay
8998	S- Standard Size H- High Density (Compac 6) [2]	B- Circuit Breaker (PowerPact™ MCP) F- Fusible (Class R except Compac 6 Class J)	A-FVNR C-FVR [3]	001=1 hp 002=2 hp 003=3 hp 005=5 hp 007=7.5 hp 010=10 hp 015=15 hp [3] 025=25 hp [3] 040=40 hp [3] 050=50 hp [3] 060=60 hp [3] 075=75 hp [3] 100=100 hp [3]	X=None A=Start-Stop PB, On/Off Lights [4] C=HOA Sel.Switch, On/Off Lights [2]	FT- 480-120 V CPT [5] FS- 120 V Fused Separate Ctl w/intlk	MA-Melting Alloy (Thermal Units not Included) SS-Motor Logic SSOL

**NOTE:** For more information, contact your nearest Schneider Electric sales office.

[1] Complete Model 6 Motor Control Centers are available from the factory.  
 [2] Not available with FVR  
 [3] Not available with Compac 6  
 [4] Includes forward, reverse and stop push-buttons; and forward and reverse pilot lights with FVR starters  
 [5] Includes extra 50 VA CPT on Sz 1 FVNR (T1)

**Combination Starters Units with Motor Circuit Protector Disconnects**

Model 6 NEMA-rated FVNR combination starter units use PowerPact™ Motor Circuit Protectors.

Ratings: 480 V, NEMA 12, Type 1B-D wiring, 100,000 AIR. Units include 1 N.O./1 N.C. auxiliary contacts. Units with pilot devices use 22 mm type. Units without pilot devices include a station plate with knockouts for five 22 mm devices.

Thermal units are not included with melting alloy overloads.

**Table 17.3: FVNR Combination Starter Units with Motor Circuit Protector Disconnects**

Ratings			Control Transformer			Fused Separate Control		
			No Pilot Devices	Start-Stop PB, Red On/Green Off Lights	HOA Red On/Green Off Lights	No Pilot Devices	Start-Stop PB, Red On/Green Off Lights	HOA Red On/Green Off Lights
NEMA Size	Hp	Space (IN)	Catalog Number	Catalog Number	Catalog Number	Catalog Number	Catalog Number	Catalog Number
<b>Full Voltage Non-Reversing (FVNR) Starters With Motor Circuit Protector Disconnect and Melting Alloy Overload Relay</b>								
1	1	12	SBA001XFTMA	SBA001AFTMA	SBA001CFTMA	SBA001XFSSMA	SBA001AFSSMA	SBA001CFSSMA
	2		SBA002XFTMA	SBA002AFTMA	SBA002CFTMA	SBA002XFSSMA	SBA002AFSSMA	SBA002CFSSMA
	3		SBA003XFTMA	SBA003AFTMA	SBA003CFTMA	SBA003XFSSMA	SBA003AFSSMA	SBA003CFSSMA
	5		SBA005XFTMA	SBA005AFTMA	SBA005CFTMA	SBA005XFSSMA	SBA005AFSSMA	SBA005CFSSMA
	7.5		SBA007XFTMA	SBA007AFTMA	SBA007CFTMA	SBA007XFSSMA	SBA007AFSSMA	SBA007CFSSMA
2	10	12	SBA010XFTMA	SBA010AFTMA	SBA010CFTMA	SBA010XFSSMA	SBA010AFSSMA	SBA010CFSSMA
	15		SBA015XFTMA	SBA015AFTMA	SBA015CFTMA	SBA015XFSSMA	SBA015AFSSMA	SBA015CFSSMA
	25		SBA025XFTMA	SBA025AFTMA	SBA025CFTMA	SBA025XFSSMA	SBA025AFSSMA	SBA025CFSSMA
3	40	18	SBA040XFTMA	SBA040AFTMA	SBA040CFTMA	SBA040XFSSMA	SBA040AFSSMA	SBA040CFSSMA
	50		SBA050XFTMA	SBA050AFTMA	SBA050CFTMA	SBA050XFSSMA	SBA050AFSSMA	SBA050CFSSMA
4	60	21	SBA060XFTMA	SBA060AFTMA	SBA060CFTMA	SBA060XFSSMA	SBA060AFSSMA	SBA060CFSSMA
	75		SBA075XFTMA	SBA075AFTMA	SBA075CFTMA	SBA075XFSSMA	SBA075AFSSMA	SBA075CFSSMA
	100		SBA100XFTMA	SBA100AFTMA	SBA100CFTMA	SBA100XFSSMA	SBA100AFSSMA	SBA100CFSSMA
<b>Full Voltage Non-Reversing (FVNR) Starters With Motor Circuit Protector Disconnect and Solid State Overload Relay (Motor Logic™)</b>								
1	1	12	SBA001XFTSS	SBA001AFTSS	SBA001CFTSS	SBA001XFSSS	SBA001AFSSS	SBA001CFSSS
	2		SBA002XFTSS	SBA002AFTSS	SBA002CFTSS	SBA002XFSSS	SBA002AFSSS	SBA002CFSSS
	3		SBA003XFTSS	SBA003AFTSS	SBA003CFTSS	SBA003XFSSS	SBA003AFSSS	SBA003CFSSS
	5		SBA005XFTSS	SBA005AFTSS	SBA005CFTSS	SBA005XFSSS	SBA005AFSSS	SBA005CFSSS
	7.5		SBA007XFTSS	SBA007AFTSS	SBA007CFTSS	SBA007XFSSS	SBA007AFSSS	SBA007CFSSS
2	10	12	SBA010XFTSS	SBA010AFTSS	SBA010CFTSS	SBA010XFSSS	SBA010AFSSS	SBA010CFSSS
	15		SBA015XFTSS	SBA015AFTSS	SBA015CFTSS	SBA015XFSSS	SBA015AFSSS	SBA015CFSSS
	25		SBA025XFTSS	SBA025AFTSS	SBA025CFTSS	SBA025XFSSS	SBA025AFSSS	SBA025CFSSS
3	40	18	SBA040XFTSS	SBA040AFTSS	SBA040CFTSS	SBA040XFSSS	SBA040AFSSS	SBA040CFSSS
	50		SBA050XFTSS	SBA050AFTSS	SBA050CFTSS	SBA050XFSSS	SBA050AFSSS	SBA050CFSSS
4	60	21	SBA060XFTSS	SBA060AFTSS	SBA060CFTSS	SBA060XFSSS	SBA060AFSSS	SBA060CFSSS
	75		SBA075XFTSS	SBA075AFTSS	SBA075CFTSS	SBA075XFSSS	SBA075AFSSS	SBA075CFSSS
	100		SBA100XFTSS	SBA100AFTSS	SBA100CFTSS	SBA100XFSSS	SBA100AFSSS	SBA100CFSSS

MOTOR CONTROL CENTERS 17

**Table 17.4: FVR Combination Starter Units with Motor Circuit Protector Disconnects**

Ratings			Control Transformer		Fused Separate Control	
			No Pilot Devices	Forward-Rev.-Stop PB, Forward/Reverse Lights	No Pilot Devices	Forward-Rev.-Stop PB, Forward/Reverse Lights
NEMA Size	Hp	Space (IN)	Catalog Number	Catalog Number	Catalog Number	Catalog Number
<b>Full Voltage Reversing (FVR) Starters With Motor Circuit Protector Disconnect and Melting Alloy Overload Relay</b>						
1	1	18	SBC001XFTMA	SBC001AFTMA	SBC001XFSSMA	SBC001AFSSMA
	2		SBC002XFTMA	SBC002AFTMA	SBC002XFSSMA	SBC002AFSSMA
	3		SBC003XFTMA	SBC003AFTMA	SBC003XFSSMA	SBC003AFSSMA
	5		SBC005XFTMA	SBC005AFTMA	SBC005XFSSMA	SBC005AFSSMA
	7.5		SBC007XFTMA	SBC007AFTMA	SBC007XFSSMA	SBC007AFSSMA
2	10	18	SBC010XFTMA	SBC010AFTMA	SBC010XFSSMA	SBC010AFSSMA
	15		SBC015XFTMA	SBC015AFTMA	SBC015XFSSMA	SBC015AFSSMA
3	25	27	SBC025XFTMA	SBC025AFTMA	SBC025XFSSMA	SBC025AFSSMA
	40		SBC040XFTMA	SBC040AFTMA	SBC040XFSSMA	SBC040AFSSMA
4	50	33	SBC050XFTMA	SBC050AFTMA	SBC050XFSSMA	SBC050AFSSMA
	60		SBC060XFTMA	SBC060AFTMA	SBC060XFSSMA	SBC060AFSSMA
4	75	33	SBC075XFTMA	SBC075AFTMA	SBC075XFSSMA	SBC075AFSSMA
	100		SBC100XFTMA	SBC100AFTMA	SBC100XFSSMA	SBC100AFSSMA
	<b>Full Voltage Reversing (FVR) Starters With Motor Circuit Protector Disconnect and Solid State Overload Relay (Motor Logic™)</b>					
1	1	18	SBC001XFTSS	SBC001AFTSS	SBC001XFSSS	SBC001AFSSS
	2		SBC002XFTSS	SBC002AFTSS	SBC002XFSSS	SBC002AFSSS
	3		SBC003XFTSS	SBC003AFTSS	SBC003XFSSS	SBC003AFSSS
	5		SBC005XFTSS	SBC005AFTSS	SBC005XFSSS	SBC005AFSSS
	7.5		SBC007XFTSS	SBC007AFTSS	SBC007XFSSS	SBC007AFSSS
2	10	18	SBC010XFTSS	SBC010AFTSS	SBC010XFSSS	SBC010AFSSS
	15		SBC015XFTSS	SBC015AFTSS	SBC015XFSSS	SBC015AFSSS
	25		SBC025XFTSS	SBC025AFTSS	SBC025XFSSS	SBC025AFSSS
3	40	27	SBC040XFTSS	SBC040AFTSS	SBC040XFSSS	SBC040AFSSS
	50		SBC050XFTSS	SBC050AFTSS	SBC050XFSSS	SBC050AFSSS
4	60	33	SBC060XFTSS	SBC060AFTSS	SBC060XFSSS	SBC060AFSSS
	75		SBC075XFTSS	SBC075AFTSS	SBC075XFSSS	SBC075AFSSS
	100		SBC100XFTSS	SBC100AFTSS	SBC100XFSSS	SBC100AFSSS

### Combination Starter Units with Fusible Switch Disconnects

Model 6 NEMA-rated FVNR combination starter units listed below use fusible switches with Class R fuse clips (fuses not included).

Ratings: 480 V, NEMA 12, Type 1B-D wiring, 100,000 AIR. Units include 1 N.O./1 N.C. auxiliary contacts. Units with pilot devices use 22 mm type. Units without pilot devices include a station plate with knockouts for five 22 mm devices.

Thermal units are not included with melting alloy overloads.

**Table 17.5: FVNR Combination Starter Units with Fusible Switch Disconnects**

Ratings			Control Transformer			Fused Separate Control		
NEMA Size	Hp	Space (IN)	No Pilot Devices	Start-Stop PB, Red On/Green Off Lights	HOA Red On/Green Off Lights	No Pilot Devices	Start-Stop PB, Red On/Green Off Lights	HOA Red On/Green Off Lights
			Catalog No.	Catalog No.	Catalog No.	Catalog No.	Catalog No.	Catalog No.
<b>Full Voltage Non-Reversing (FVNR) Starters With Fusible Switch Disconnect and Melting Alloy Overload Relay</b>								
1	1	12	SFA001XF <sub>TMA</sub>	SFA001AF <sub>TMA</sub>	SFA001CF <sub>TMA</sub>	SFA001XF <sub>SMA</sub>	SFA001AF <sub>SMA</sub>	SFA001CF <sub>SMA</sub>
	2		SFA002XF <sub>TMA</sub>	SFA002AF <sub>TMA</sub>	SFA002CF <sub>TMA</sub>	SFA002XF <sub>SMA</sub>	SFA002AF <sub>SMA</sub>	SFA002CF <sub>SMA</sub>
	3		SFA003XF <sub>TMA</sub>	SFA003AF <sub>TMA</sub>	SFA003CF <sub>TMA</sub>	SFA003XF <sub>SMA</sub>	SFA003AF <sub>SMA</sub>	SFA003CF <sub>SMA</sub>
	5		SFA005XF <sub>TMA</sub>	SFA005AF <sub>TMA</sub>	SFA005CF <sub>TMA</sub>	SFA005XF <sub>SMA</sub>	SFA005AF <sub>SMA</sub>	SFA005CF <sub>SMA</sub>
	7.5		SFA007XF <sub>TMA</sub>	SFA007AF <sub>TMA</sub>	SFA007CF <sub>TMA</sub>	SFA007XF <sub>SMA</sub>	SFA007AF <sub>SMA</sub>	SFA007CF <sub>SMA</sub>
	10		SFA010XF <sub>TMA</sub>	SFA010AF <sub>TMA</sub>	SFA010CF <sub>TMA</sub>	SFA010XF <sub>SMA</sub>	SFA010AF <sub>SMA</sub>	SFA010CF <sub>SMA</sub>
2	15	12	SFA015XF <sub>TMA</sub>	SFA015AF <sub>TMA</sub>	SFA015CF <sub>TMA</sub>	SFA015XF <sub>SMA</sub>	SFA015AF <sub>SMA</sub>	SFA015CF <sub>SMA</sub>
	25		SFA025XF <sub>TMA</sub>	SFA025AF <sub>TMA</sub>	SFA025CF <sub>TMA</sub>	SFA025XF <sub>SMA</sub>	SFA025AF <sub>SMA</sub>	SFA025CF <sub>SMA</sub>
3	40	18	SFA040XF <sub>TMA</sub>	SFA040AF <sub>TMA</sub>	SFA040CF <sub>TMA</sub>	SFA040XF <sub>SMA</sub>	SFA040AF <sub>SMA</sub>	SFA040CF <sub>SMA</sub>
	50		SFA050XF <sub>TMA</sub>	SFA050AF <sub>TMA</sub>	SFA050CF <sub>TMA</sub>	SFA050XF <sub>SMA</sub>	SFA050AF <sub>SMA</sub>	SFA050CF <sub>SMA</sub>
4	60	30	SFA060XF <sub>TMA</sub>	SFA060AF <sub>TMA</sub>	SFA060CF <sub>TMA</sub>	SFA060XF <sub>SMA</sub>	SFA060AF <sub>SMA</sub>	SFA060CF <sub>SMA</sub>
	75		SFA075XF <sub>TMA</sub>	SFA075AF <sub>TMA</sub>	SFA075CF <sub>TMA</sub>	SFA075XF <sub>SMA</sub>	SFA075AF <sub>SMA</sub>	SFA075CF <sub>SMA</sub>
	100		SFA100XF <sub>TMA</sub>	SFA100AF <sub>TMA</sub>	SFA100CF <sub>TMA</sub>	SFA100XF <sub>SMA</sub>	SFA100AF <sub>SMA</sub>	SFA100CF <sub>SMA</sub>
<b>Full Voltage Non-Reversing (FVNR) Starters With Fusible Switch Disconnect and Solid State Overload Relay (Motor Logic™)</b>								
1	1	12	SFA001XF <sub>TSS</sub>	SFA001AF <sub>TSS</sub>	SFA001CF <sub>TSS</sub>	SFA001XF <sub>SSS</sub>	SFA001AF <sub>SSS</sub>	SFA001CF <sub>SSS</sub>
	2		SFA002XF <sub>TSS</sub>	SFA002AF <sub>TSS</sub>	SFA002CF <sub>TSS</sub>	SFA002XF <sub>SSS</sub>	SFA002AF <sub>SSS</sub>	SFA002CF <sub>SSS</sub>
	3		SFA003XF <sub>TSS</sub>	SFA003AF <sub>TSS</sub>	SFA003CF <sub>TSS</sub>	SFA003XF <sub>SSS</sub>	SFA003AF <sub>SSS</sub>	SFA003CF <sub>SSS</sub>
	5		SFA005XF <sub>TSS</sub>	SFA005AF <sub>TSS</sub>	SFA005CF <sub>TSS</sub>	SFA005XF <sub>SSS</sub>	SFA005AF <sub>SSS</sub>	SFA005CF <sub>SSS</sub>
	7.5		SFA007XF <sub>TSS</sub>	SFA007AF <sub>TSS</sub>	SFA007CF <sub>TSS</sub>	SFA007XF <sub>SSS</sub>	SFA007AF <sub>SSS</sub>	SFA007CF <sub>SSS</sub>
	10		SFA010XF <sub>TSS</sub>	SFA010AF <sub>TSS</sub>	SFA010CF <sub>TSS</sub>	SFA010XF <sub>SSS</sub>	SFA010AF <sub>SSS</sub>	SFA010CF <sub>SSS</sub>
2	15	12	SFA015XF <sub>TSS</sub>	SFA015AF <sub>TSS</sub>	SFA015CF <sub>TSS</sub>	SFA015XF <sub>SSS</sub>	SFA015AF <sub>SSS</sub>	SFA015CF <sub>SSS</sub>
	25		SFA025XF <sub>TSS</sub>	SFA025AF <sub>TSS</sub>	SFA025CF <sub>TSS</sub>	SFA025XF <sub>SSS</sub>	SFA025AF <sub>SSS</sub>	SFA025CF <sub>SSS</sub>
3	40	18	SFA040XF <sub>TSS</sub>	SFA040AF <sub>TSS</sub>	SFA040CF <sub>TSS</sub>	SFA040XF <sub>SSS</sub>	SFA040AF <sub>SSS</sub>	SFA040CF <sub>SSS</sub>
	50		SFA050XF <sub>TSS</sub>	SFA050AF <sub>TSS</sub>	SFA050CF <sub>TSS</sub>	SFA050XF <sub>SSS</sub>	SFA050AF <sub>SSS</sub>	SFA050CF <sub>SSS</sub>
4	60	30	SFA060XF <sub>TSS</sub>	SFA060AF <sub>TSS</sub>	SFA060CF <sub>TSS</sub>	SFA060XF <sub>SSS</sub>	SFA060AF <sub>SSS</sub>	SFA060CF <sub>SSS</sub>
	75		SFA075XF <sub>TSS</sub>	SFA075AF <sub>TSS</sub>	SFA075CF <sub>TSS</sub>	SFA075XF <sub>SSS</sub>	SFA075AF <sub>SSS</sub>	SFA075CF <sub>SSS</sub>
	100		SFA100XF <sub>TSS</sub>	SFA100AF <sub>TSS</sub>	SFA100CF <sub>TSS</sub>	SFA100XF <sub>SSS</sub>	SFA100AF <sub>SSS</sub>	SFA100CF <sub>SSS</sub>

**Table 17.6: FVR Combination Starter Units with Fusible Switch Disconnects**

Ratings			Control Transformer		Fused Separate Control	
NEMA Size	Hp	Space (IN)	No Pilot Devices	Forward-Rev.-Stop PB, Forward/Reverse Lights	No Pilot Devices	Forward-Rev.-Stop PB, Forward/Reverse Lights
			Catalog No.	Catalog No.	Catalog No.	Catalog No.
<b>Full Voltage Reversing (FVR) Starters With Fusible Switch Disconnect and Melting Alloy Overload Relay</b>						
1	1	18	SFC001XF <sub>TMA</sub>	SFC001AF <sub>TMA</sub>	SFC001XF <sub>SMA</sub>	SFC001AF <sub>SMA</sub>
	2		SFC002XF <sub>TMA</sub>	SFC002AF <sub>TMA</sub>	SFC002XF <sub>SMA</sub>	SFC002AF <sub>SMA</sub>
	3		SFC003XF <sub>TMA</sub>	SFC003AF <sub>TMA</sub>	SFC003XF <sub>SMA</sub>	SFC003AF <sub>SMA</sub>
	5		SFC005XF <sub>TMA</sub>	SFC005AF <sub>TMA</sub>	SFC005XF <sub>SMA</sub>	SFC005AF <sub>SMA</sub>
	7.5		SFC007XF <sub>TMA</sub>	SFC007AF <sub>TMA</sub>	SFC007XF <sub>SMA</sub>	SFC007AF <sub>SMA</sub>
	10		SFC010XF <sub>TMA</sub>	SFC010AF <sub>TMA</sub>	SFC010XF <sub>SMA</sub>	SFC010AF <sub>SMA</sub>
2	15	18	SFC015XF <sub>TMA</sub>	SFC015AF <sub>TMA</sub>	SFC015XF <sub>SMA</sub>	SFC015AF <sub>SMA</sub>
	25		SFC025XF <sub>TMA</sub>	SFC025AF <sub>TMA</sub>	SFC025XF <sub>SMA</sub>	SFC025AF <sub>SMA</sub>
3	40	27	SFC040XF <sub>TMA</sub>	SFC040AF <sub>TMA</sub>	SFC040XF <sub>SMA</sub>	SFC040AF <sub>SMA</sub>
	50		SFC050XF <sub>TMA</sub>	SFC050AF <sub>TMA</sub>	SFC050XF <sub>SMA</sub>	SFC050AF <sub>SMA</sub>
4	60	39	SFC060XF <sub>TMA</sub>	SFC060AF <sub>TMA</sub>	SFC060XF <sub>SMA</sub>	SFC060AF <sub>SMA</sub>
	75		SFC075XF <sub>TMA</sub>	SFC075AF <sub>TMA</sub>	SFC075XF <sub>SMA</sub>	SFC075AF <sub>SMA</sub>
	100		SFC100XF <sub>TMA</sub>	SFC100AF <sub>TMA</sub>	SFC100XF <sub>SMA</sub>	SFC100AF <sub>SMA</sub>
<b>Full Voltage Reversing (FVR) Starters with Fusible Switch Disconnect and Solid State Overload Relay (Motor Logic™)</b>						
1	1	18	SFC001XF <sub>TSS</sub>	SFC001AF <sub>TSS</sub>	SFC001XF <sub>SSS</sub>	SFC001AF <sub>SSS</sub>
	2		SFC002XF <sub>TSS</sub>	SFC002AF <sub>TSS</sub>	SFC002XF <sub>SSS</sub>	SFC002AF <sub>SSS</sub>
	3		SFC003XF <sub>TSS</sub>	SFC003AF <sub>TSS</sub>	SFC003XF <sub>SSS</sub>	SFC003AF <sub>SSS</sub>
	5		SFC005XF <sub>TSS</sub>	SFC005AF <sub>TSS</sub>	SFC005XF <sub>SSS</sub>	SFC005AF <sub>SSS</sub>
	7.5		SFC007XF <sub>TSS</sub>	SFC007AF <sub>TSS</sub>	SFC007XF <sub>SSS</sub>	SFC007AF <sub>SSS</sub>
	10		SFC010XF <sub>TSS</sub>	SFC010AF <sub>TSS</sub>	SFC010XF <sub>SSS</sub>	SFC010AF <sub>SSS</sub>
2	15	18	SFC015XF <sub>TSS</sub>	SFC015AF <sub>TSS</sub>	SFC015XF <sub>SSS</sub>	SFC015AF <sub>SSS</sub>
	25		SFC025XF <sub>TSS</sub>	SFC025AF <sub>TSS</sub>	SFC025XF <sub>SSS</sub>	SFC025AF <sub>SSS</sub>
3	40	27	SFC040XF <sub>TSS</sub>	SFC040AF <sub>TSS</sub>	SFC040XF <sub>SSS</sub>	SFC040AF <sub>SSS</sub>
	50		SFC050XF <sub>TSS</sub>	SFC050AF <sub>TSS</sub>	SFC050XF <sub>SSS</sub>	SFC050AF <sub>SSS</sub>
4	60	39	SFC060XF <sub>TSS</sub>	SFC060AF <sub>TSS</sub>	SFC060XF <sub>SSS</sub>	SFC060AF <sub>SSS</sub>
	75		SFC075XF <sub>TSS</sub>	SFC075AF <sub>TSS</sub>	SFC075XF <sub>SSS</sub>	SFC075AF <sub>SSS</sub>
	100		SFC100XF <sub>TSS</sub>	SFC100AF <sub>TSS</sub>	SFC100XF <sub>SSS</sub>	SFC100AF <sub>SSS</sub>

17 MOTOR CONTROL CENTERS



**Compac™ 6 Combination Starter Units with Motor Circuit Protector Disconnects**

NEMA-rated Compac 6, half-height FVNR combination starters use TeSys BV4 Motor Circuit Protectors.

Ratings: 480 V, NEMA 12, Type 1B-D wiring, 100,000 AIR. Units include 1 N.O./1 N.C. auxiliary contacts. Units with pilot devices use 22 mm type.

Units without pilot devices include a station plate with knockouts for four 22 mm devices. Thermal units are not included with melting alloy overloads.

**Table 17.7: Compac 6 Combination Starter Units with Motor Circuit Protector Disconnects**

Ratings			Control Transformer			Fused Separate Control		
NEMA Size	Hp	Space (IN)	No Pilot Devices	Start-Stop PB, Red On/Green Off Lights	HOA, Red On/Green Off Lights	No Pilot Devices	Start-Stop PB, Red On/Green Off Lights	HOA, Red On/Green Off Lights
			Catalog No.	Catalog No.	Catalog No.	Catalog No.	Catalog No.	Catalog No.
<b>Full Voltage Non-Reversing (FVNR) Starters With Motor Circuit Protector Disconnect and Melting Alloy Overload Relay</b>								
1	1	6	HBA001XFTMA	HBA001AFTMA	HBA001CFTMA	HBA001XF SMA	HBA001AF SMA	HBA001CF SMA
	2		HBA002XFTMA	HBA002AFTMA	HBA002CFTMA	HBA002XF SMA	HBA002AF SMA	HBA002CF SMA
	3		HBA003XFTMA	HBA003AFTMA	HBA003CFTMA	HBA003XF SMA	HBA003AF SMA	HBA003CF SMA
	5		HBA005XFTMA	HBA005AFTMA	HBA005CFTMA	HBA005XF SMA	HBA005AF SMA	HBA005CF SMA
	7.5		HBA007XFTMA	HBA007AFTMA	HBA007CFTMA	HBA007XF SMA	HBA007AF SMA	HBA007CF SMA
	10		HBA010XFTMA	HBA010AFTMA	HBA010CFTMA	HBA010XF SMA	HBA010AF SMA	HBA010CF SMA
<b>Full Voltage Non-Reversing (FVNR) Starters With Motor Circuit Protector Disconnect and Solid State Overload Relay (Motor Logic™)</b>								
1	1	6	HBA001XFTSS	HBA001AFTSS	HBA001CFTSS	HBA001XF SSS	HBA001AF SSS	HBA001CF SSS
	2		HBA002XFTSS	HBA002AFTSS	HBA002CFTSS	HBA002XF SSS	HBA002AF SSS	HBA002CF SSS
	3		HBA003XFTSS	HBA003AFTSS	HBA003CFTSS	HBA003XF SSS	HBA003AF SSS	HBA003CF SSS
	5		HBA005XFTSS	HBA005AFTSS	HBA005CFTSS	HBA005XF SSS	HBA005AF SSS	HBA005CF SSS
	7.5		HBA007XFTSS	HBA007AFTSS	HBA007CFTSS	HBA007XF SSS	HBA007AF SSS	HBA007CF SSS
	10		HBA010XFTSS	HBA010AFTSS	HBA010CFTSS	HBA010XF SSS	HBA010AF SSS	HBA010CF SSS

**Compac™ 6 Combination Starter Units with Fusible Switch Disconnects**

NEMA-rated Compac 6, half-height FVNR combination starters listed below use fusible switches with Class J fuse clips (fuses not included).

Ratings: 480 V, NEMA 12, Type 1B-D wiring, 100,000 AIR. Units include 1 N.O./1 N.C. auxiliary contacts.

Units with pilot devices use 22 mm type. Units without pilot devices include a station plate with knockouts for four 22 mm devices. Thermal units are not included with melting alloy overloads.

**Table 17.8: Compac 6 Combination Starter Units with Fusible Switch Disconnects**

Ratings			Control Transformer			Fused Separate Control		
NEMA Size	Hp	Space (IN)	No Pilot Devices	Start-Stop PB, Red On/Green Off Lights	HOA, Red On/Green Off Lights	No Pilot Devices	Start-Stop PB, Red On/Green Off Lights	HOA, Red On/Green Off Lights
			Catalog No.	Catalog No.	Catalog No.	Catalog No.	Catalog No.	Catalog No.
<b>Full Voltage Non-Reversing (FVNR) Starters with Fusible Switch Disconnect and Melting Alloy Overload Relay</b>								
1	1	6	HFA001XFTMA	HFA001AFTMA	HFA001CFTMA	HFA001XF SMA	HFA001AF SMA	HFA001CF SMA
	2		HFA002XFTMA	HFA002AFTMA	HFA002CFTMA	HFA002XF SMA	HFA002AF SMA	HFA002CF SMA
	3		HFA003XFTMA	HFA003AFTMA	HFA003CFTMA	HFA003XF SMA	HFA003AF SMA	HFA003CF SMA
	5		HFA005XFTMA	HFA005AFTMA	HFA005CFTMA	HFA005XF SMA	HFA005AF SMA	HFA005CF SMA
	7.5		HFA007XFTMA	HFA007AFTMA	HFA007CFTMA	HFA007XF SMA	HFA007AF SMA	HFA007CF SMA
	10		HFA010XFTMA	HFA010AFTMA	HFA010CFTMA	HFA010XF SMA	HFA010AF SMA	HFA010CF SMA
<b>Full Voltage Non-Reversing (FVNR) Starters With Fusible Switch Disconnect and Solid State Overload Relay (Motor Logic™)</b>								
1	1	6	HFA001XFTSS	HFA001AFTSS	HFA001CFTSS	HFA001XF SSS	HFA001AF SSS	HFA001CF SSS
	2		HFA002XFTSS	HFA002AFTSS	HFA002CFTSS	HFA002XF SSS	HFA002AF SSS	HFA002CF SSS
	3		HFA003XFTSS	HFA003AFTSS	HFA003CFTSS	HFA003XF SSS	HFA003AF SSS	HFA003CF SSS
	5		HFA005XFTSS	HFA005AFTSS	HFA005CFTSS	HFA005XF SSS	HFA005AF SSS	HFA005CF SSS
	7.5		HFA007XFTSS	HFA007AFTSS	HFA007CFTSS	HFA007XF SSS	HFA007AF SSS	HFA007CF SSS
	10		HFA010XFTSS	HFA010AFTSS	HFA010CFTSS	HFA010XF SSS	HFA010AF SSS	HFA010CF SSS

Units rated as follows:

- 480 V, 60 Hz, NEMA Type 12 Enclosure, Industrial Package
- Short Circuit rating: 100,000 AIR

**Circuit Breaker Branch Feeder Units**

**Table 17.9: Circuit Breaker Branch Feeder Units**

First Position	Second Position	Third Position	Fourth Position	Fifth Position	
8998	S	B	F	015	
Class	Type	Disconnect	Device	Feeder Amps	
8998	S- Standard Size H- Compac™ 6	B- Breaker (Thermal-Mag)	F- Feeder	015	080
				020	100
				030	125
				040	150
				050	200
				060	250
				070	
Amps	Breaker Frame	Space (IN)	Catalog No.		
15	HL	6	HBFF015		
20			HBFF020		
30			HBFF030		
40			HBFF040		
50			HBFF050		
60			HBFF060		
70			HBFF070		
80			HBFF080		
100			HBFF100		
125			HBFF125		
150	HBFF150				
200	JL		HBFF200		
250			HBFF250		
15	HL	12	SBF015		
20			SBF020		
30			SBF030		
40			SBF040		
50			SBF050		
60			SBF060		
70			SBF070		
80			SBF080		
100			SBF100		
125			SBF125		
150	SBF150				
200	JL	18	SBF200		
250			SBF250		

17 MOTOR CONTROL CENTERS

**Fusible Branch Feeder Units**

**Table 17.10: Fusible Branch Feeder Units**

First Position	Second Position	Third Position	Fourth Position	Fifth Position	
8998	S	F	F	015	
Class	Type	Disconnect	Device	Feeder Amps	
8998	S- Standard Size H- Compac 6	F- Fusible [1]	F- Feeder	030	
				060	
				100	
				200 [2]	
Amps	Fuse Clips	Space (IN)	Catalog No.		
30	Class J	6 (Compac 6)	HFF030		
60			HFF060		
100			HFF100		
30	Class R	12	SFF030		
60			SFF060		
100			SFF100		
200			SFF200		
		24			

**Model 6 Blank Doors**

These doors may be used to cover an unused space in the MCC. A blank door will be required when placing a new unit in an existing space that is larger than the new unit.

**Table 17.11: Model 6 Blank Doors**

Catalog Number	Description
8998CP03	3-Inch High Blank Cover Plate
8998CP06	6-Inch High Blank Door
8998CP09	9-Inch High Blank Door
8998CP12	12-Inch High Blank Door
8998CP15	15-Inch High Blank Door
8998CP18	18-Inch High Blank Door
8998CP24	24-Inch High Blank Door

[1] Class R except Compac 6, fuses not included. Compac 6 units accept Class J fuses.

[2] Not available with Compac 6.

# Section 18

## Contactors and Starters-IEC



TeSys island Load Management System



TeSys D Contactors



TeSys F Contactors



TeSys GV3P



TeSys GV2P



TeSys U



TeSys H



Scan here to access our online digital easy motor control selectors





<b>TeSys Selection Overview</b>	<b>18-2</b>
Solutions that enhance machine intelligence	18-2
Traditional Control Solutions	18-2
Two-Component Motor Circuit Solutions to 520 amps	18-4
<b>Digital Motor Control Solution</b>	<b>18-5</b>
TeSys island Load Management System	18-5
<b>Contactors and Overload Relays</b>	<b>18-8</b>
TeSys™ K Contactors and Overload Relays	18-8
TeSys™ K Non-Reversing Mini-Contactors	18-8
TeSys™ K Overload Relays	18-9
TeSys™ K Reversing Mini-Contactors	18-9
TeSys™ D Contactors and Overload Relays	18-11
TeSys™ D Non-Reversing Contactors	18-11
TeSys™ D Overload Relays	18-12
TeSys™ D Reversing Contactors	18-13
TeSys™ F Contactors and Overload Relays	18-13
TeSys™ F Non-Reversing Contactors	18-14
TeSys™ F Overload Relays	18-14
TeSys™ F Reversing Contactors	18-14
<b>Contactor Accessories</b>	<b>18-15</b>
TeSys™ K Contactors	18-15
TeSys™ D and F Contactors	18-17
TeSys™ D Contactors	18-19
TeSys™ F Contactors	18-22
<b>Overload Relay Accessories</b>	<b>18-23</b>
TeSys™ D and F Overload Relays	18-23
<b>Motor Starters and Protectors</b>	<b>18-25</b>
TeSys™ U Open Motor Starter	18-25
TeSys™ H Ultra Compact Starters	18-29
TeSys™ GV Manual Starters and Protectors	18-30
TeSys™ GV Accessories and Enclosures	18-32
TeSys™ D Enclosed Starters	18-36
TeSys™ LS1 Fuse Holders	18-38
<b>Soft Starter Module ATSU01</b>	<b>18-39</b>
ATSU01 Altistart™ and TeSys™ U	18-39
<b>Replacement Parts</b>	<b>18-40</b>
TeSys™ D AC Coils	18-40
TeSys™ F Contactors	18-41
<b>Wiring Systems</b>	<b>18-41</b>
TeSys™ AK5 Panel Busbar System	18-41
<b>Dimensions</b>	<b>18-42</b>

TeSys Control Solutions









TeSys offers solutions for a variety of common control applications, including small to large loads, motor and non-motor loads, in various forms to meet customers specific needs. Basic solutions offer traditional approaches that meet compact, cost-effective, and large HP applications. TeSys also equips OEMs and System Integrators with EcoStruxure Machine connected product solutions that are IoT ready offers to help enhance the intelligence of machinery and equipment, helping to recognize and address potential issues before stoppage and decrease unplanned downtime.

Traditional Control

Table 18.1: Solutions that enhance machine intelligence

	Solution 1 — TeSys island as group motor	Solution 2 — TeSys island with individual protection	Solution 3 — TeSys U (Type E self-protected) using Multi-function trip unit & communication module or using pre-trip alarm function module	Solution 4 — TeSys T overload relay	Solution 5 — TeSys GV4PB, GV5PB, GV6PB with SDx Module
					
Best Practice Scenario	Ideal for <b>panels with multiple loads</b> . Single bus coupler serves as connection to PLC, manages logic and configuration for starters.	Ideal for <b>panels with multiple loads</b> . Single bus coupler serves as connection to PLC, manages logic and configuration for starters.	Ideal for <b>panels with one or two motors</b> . Each starter communicates directly to PLC.	Ideal for <b>larger HP</b> . Each overload relay communicates directly to PLC.	Ideal for adding intelligence using a <b>simple NO/NC pre-trip alarm contact</b> — Use of PLC to receive/interpret data not required.
Benefits	See load, device and system performance. Set alarms to anticipate maintenance and optimize performance.	See load, device and system performance. Set alarms to anticipate maintenance and optimize performance.	See load performance. Set alarms to anticipate maintenance and optimize performance.	See load performance. Set alarms to anticipate maintenance and optimize performance.	Pre-trip alarm NO/NC contact alerts prior to trip, enabling proactive actions to minimize downtime or alert operators
Circuit Protection	Circuit breaker or fuse protection group	Circuit breaker or fuse	TeSys U (applied as Type E self protected), using advanced trip unit/function modules	Breaker or fuse	GV4PB, GV5PB, GV6PB
Motor Control	TeSys island load management system with or without TeSys GV	TeSys island load management system		TeSys D or F contactors	TeSys D or F
Motor Overload Protection				TeSys T overload relay	(included in GV*PB)
Load Types	Motor, resistive/non-inductive, isolation	Motor, resistive/non-inductive, isolation	Motor loads only	Motor loads only	Motor loads only
Max HP 480V	40 HP	40 HP	20 HP	500 HP (up to 810 amps)	450 HP (up to 520 amps)
SCCR	basic 5 kA up to high 50 kA (with GV)	high, to 100 kA	High, to 65 kA	Depends on configuration	Depends on configuration
Available data	Device status/performance Load performance including alarms Voltage, Energy & Power	Device status/performance Load performance including alarms Voltage, Energy & Power	Load performance including alarms	Load performance including alarms Voltage & Power	Pre-trip alarm (via NO/NC contact)
Communication	Ethernet IP, Modbus TCP, Profinet, Profibus	Ethernet IP, Modbus TCP, Profinet, Profibus	Modbus™, CANopen, DeviceNet™, Profibus™	Modbus™, CANopen, DeviceNet™, Profibus™, Ethernet/IP, and Modbus/TCP	None

**Table 18.2: Basic — Traditional motor control solution**

	Solution 1 — Two component solution (TeSys GV + D)		Solution 2 — Single component solution	Solution 3 — Group Motor solution	Solution 5 — Three component solution (Breaker/ fuse, contactor & overload relay)	Solution 6 — Type D solution (Motor circuit protector, contactor & overload relay)	Solution 7 — Non-motor load solution (Breaker/fuse + contactor)	
	Type F — up to 65 amps	Motor Protective Circuit Breakers + contactor - up to 520 amps	Type E — up to 32 amps	up to 65 amps				
								
Best Practice Scenario	Most cost effective, high SCCR solution		Most compact, also ideal for critical uptime applications (resetable after a short-circuit with no component replacement), high SCCR solution	Few components, 480V delta rated	3-component solution, ideal for higher HPs or high SCCR	ideal for pumping applications, includes adjustable motor inrush sensitivity	ideal for non-motor loads	
Benefits	Simple, 2-component solution, cost effective, fast power wiring using bus bars	Simple, 2-component solution, cost effective for larger HP motors	Single component solution, Type 2 rated (minimize downtime after short-circuit)	cost effective solution ideal for panels with many motor loads (single breaker for multiple starters)	basic solution, ideal for 480V delta applications, resetable after breaker trip	adjustable motor inrush sensitivity, ideal for pumping applications	ideal for non-motor loads	
Circuit Protection	TeSys GV2P, GV3P (applied as Type F with contactor)	TeSys GV4PB, GV5PB, GV6PB (UL 489)	TeSys U, with basic trip unit	PowerPact or Multi9 (UL 489) or fuses	PowerPact or Multi9 (UL 489) or TeSys DF, LS1 fuseholder, GS disconnect with fuses	TeSys BV4 (UL 489)	PowerPact or Multi9 (UL 489) or TeSys DF, LS1 fuseholder, GS disconnect with fuses	
Motor Control	Tesys D	TeSys D or F		TeSys D	TeSys D or F	TeSys D	TeSys D or F	
Motor Overload Protection	(included in GV)	(included in GV)		TeSys GV2ME	LR thermal or LR9 electronic	LR thermal or LR9 electronic	—	
Load Types	Motor loads only	Motor loads only	Motor loads only	Motor loads only	Motor loads only	Motor loads only	Resistive/non-inductive, isolation	

Refer to Catalog MKTED210011EN

Two-Component Motor Circuit Solutions to 520 Amps

Simplify design, panel space and installation with TeSys high SCCR solution that use only two components that make up an entire branch circuit up to 520 amps. These two-component solutions are UL compliant using either a Type F combination motor controller rating or a UL 489 rating. For additional solutions and ratings, see Motor Control Solutions for North America data bulletin 8536DB0901.



Table 18.3: Quick selection table for TeSys 2–component motor circuit solutions

200 V 3P		230 V 3P		460 V 3P		GV Ref	Overload Dial Range (A)	Contactor Ref/Contactor Ref <sup>[1]</sup>	Pre-assembled Ref/Contactor Ref <sup>[1]</sup>	SCCR 480Y as applied with specified protection
HP	FLA <sup>[2]</sup>	HP	FLA <sup>[2]</sup>	HP	FLA <sup>[2]</sup>					
—	—	—	—	1/2	1.1	GV2P06	1 to 1.6	LC1D09	GV2P06KD09	100 kA <sup>[3]</sup>
—	—	—	—	3/4	1.6	GV2P06	1 to 1.6	LC1D09	GV2P06KD09	100 kA <sup>[3]</sup>
1/2	2.5	1/2	2.2	1	2.1	GV2P07	1.6 to 2.5	LC1D09	GV2P07KD09	100 kA <sup>[3]</sup>
—	—	—	—	1 1/2	3	GV2P08	2.5 to 4	LC1D09	GV2P08KD09	100 kA <sup>[3]</sup>
3/4	3.7	3/4	3.2	2	3.4	GV2P08	2.5 to 4	LC1D09	GV2P08KD09	100 kA <sup>[3]</sup>
1	4.6	1	4.2	3	4.8	GV2P10	4 to 6.3	LC1D09	GV2P10KD09	100 kA <sup>[3]</sup>
—	—	1 1/2	6	—	—	GV2P10	4 to 6.3	LC1D09	GV2P10KD09	100 kA <sup>[3]</sup>
1 1/2	6.9	2	6.8	—	—	GV2P14	6 to 10	LC1D12	GV2P14KD09	100 kA <sup>[3]</sup>
2	7.8	—	—	5	7.6	GV2P14	6 to 10	LC1D12	GV2P14KD09	100 kA <sup>[3]</sup>
—	—	3	9.6	—	—	GV2P16	9 to 14	LC1D12	GV2P16KD25	50 kA <sup>[4]</sup>
3	11	—	—	7 1/2	11	GV2P16	9 to 14	LC1D18	GV2P16KD25	50 kA <sup>[4]</sup>
—	—	—	—	10	14	GV2P16	9 to 14	LC1D18	GV2P16KD25	50 kA <sup>[4]</sup>
5	17.5	5	15.2	—	—	GV2P20	13 to 18	LC1D18	GV2P20KD25	50 kA <sup>[4]</sup>
—	—	7 1/2	22	15	21	GV2P21	17 to 23	LC1D25	GV2P21KD25	50 kA <sup>[4]</sup>
7 1/2	25.3	—	—	—	—	GV2P22	20 to 25	LC1D25	GV2P22KD25	50 kA <sup>[4]</sup>
—	—	10	28	20	27	GV3P32	23 to 32	LC1D32	—	65 kA <sup>[5]</sup>
10	32.2	—	—	25	34	GV3P40	30 to 40	LC1D40A	—	65 kA <sup>[5]</sup>
—	—	15	42	30	40	GV3P50	37 to 50	LC1D50A	—	65 kA <sup>[5]</sup>
15	48	20	54	40	52	GV3P65	48 to 65	LC1D65A	—	65 kA <sup>[5]</sup>
20	62.1	25	68	50	65	GV4PB115S	65 to 115	LC1D80	—	65 kA
25	78.2	30	80	60	77	GV4PB115S	65 to 115	LC1D80	—	65 kA
30	92	—	—	—	—	GV4PB115S	65 to 115	LC1D115	—	65 kA
—	—	40	104	75	96	GV5PB150S	58 to 130	LC1D115	—	65 kA
40	120	—	—	—	—	GV5PB150S	58 to 130	LC1D150	—	65 kA
—	—	50	130	100	124	GV5PB250S	114 to 217	LC1D150	—	65 kA
50	150	60	154	125	156	GV5PB250S	114 to 217	LC1D185	—	65 kA <sup>[6]</sup>
60	177	75	192	150	180	GV5PB250S	114 to 217	LC1F265	—	10 kA <sup>[7]</sup>
75	221	100	248	200	240	GV6PB400S	190 to 348	LC1F330	—	10 kA <sup>[7]</sup>
100	285	125	312	250	302	GV6PB400S	190 to 348	LC1F400	—	18 kA
125	359	150	360	300	361	GV6PB600S	312 to 520	LC1F500	—	18 kA
150	414	200	480	400	477	GV6PB600S	312 to 520	LC1F500	—	18 kA
200	552	—	—	450	515	GV6PB600S	312 to 520	LC1F630	—	30 kA

18 CONTACTORS AND STARTERS-IEC

[1] Add coil suffix to complete reference part number (See Table 18.24 TeSys D Coil Voltage Codes , page 18-11 for LC1D and Table 18.30 TeSys F Coil Voltage Codes, page 18-14 for LC1F). For example, an LC1D09G7 includes a 120 Vac coil.  
 [2] Motor Full Load Amp Sizes are based on NEC Table 430.250.  
 [3] Requires use of GV1G09 or GV2GH7 line spacer for Type F rating. SCCR is 100 kA at 480Y with or without use of GV2G busbar links.  
 [4] Requires use of GV1G09 or GV2GH7 line spacer for Type F rating. SCCR is 42 kA at 480Y when using GV2G busbar links.  
 [5] Requires use of GV3G66 line spacer and GVAM11 short-circuit signaling contact for Type F rating.  
 [6] Max wire size of 3/0 AWG for 65kA 480 V SCCR.  
 [7] 100kA SCCR with fuses. See Motor Control Solutions for North America data bulletin 8536DB0901 for more information.

**Island Concept**

TeSys island is an innovative digital load management solution—providing data for higher machine efficiency and ease of servicing, and allowing faster time to market.

TeSys island is a modular, multifunctional system providing integrated functions inside an automation architecture, primarily for the direct control and management of low-voltage loads. TeSys island can switch, help protect, and manage motors and other electrical loads up to 40 hp, 80 A installed in an electrical control Panel.

This system is designed around the concept of TeSys™ avatars.

These avatars:

- are the functional object representing a logical function of the physical module with pre-defined logic
- determine the configuration of the island.

The logical aspects of the island are managed with software tools, covering all phases of product and application lifecycle: design, engineering, commissioning, operation, and maintenance.



1	Bus Coupler	5	Power interface module
2	Analog I/O module	6	Standard Starter
3	Digital I/O module	7	SIL Starter
4	Voltage interface module	9	SIL interface module

The physical island consists of a set of devices installed on a single DIN rail controlling loads, monitoring data, diagnostics information and connected together with a ribbon cable providing the internal communication between modules.

The external communication with the automation environment is made via a single coupler module, and the island is seen as a single node on the network. The other modules include starters, power interface modules, analog and digital I/O modules, voltage interface modules, and SIL interface modules, covering a wide range of operational functions.

**Product References**

The TeSys island load management system consists of a bus coupler along with other starters and modules as needed to build an “island” of load management, monitoring & control functions. It is recommended to use the online EcoStruxure Motor Control Configurator to ensure proper application and sizing.



Scan here to access our online EcoStruxure Motor Control Configurator

**Table 18.4: Bus Couplers**

Designation	Upstream PLC protocol	Service Port protocol	Product Reference	Weight (kg)
TeSys island Bus Coupler	EtherNet/IP–Modbus TCP	Ethernet TCP/IP	<a href="#">TPRBCEIP</a>	0.204
	PROFINET	Ethernet TCP/IP	<a href="#">TPRBCPFN</a>	0.204
	PROFIBUS	Ethernet TCP/IP	<a href="#">TPRBCPFB</a>	0.204

**Table 18.5: 3-Pole Starters**

Maximum Horsepower Ratings							Product Reference	Weight (kg)
Single-Phase		Three-Phase				Continu-ous Current Rating (A)		
115 V	230 V	200 V	230 V	460 V	575 V			
1/3	1	2	2	5	5	15	<a href="#">TPRST009</a>	0.656
2	3	7 1/2	7 1/2	15	20	30	<a href="#">TPRST025</a>	0.718
2	5	10	10	20	25	40	<a href="#">TPRST038</a>	0.718
5	10	20	20	40	50	80	<a href="#">TPRST065</a>	1.248
5	10	20	20	40	50	80	<a href="#">TPRST080</a>	1.248



TPRBCEIP



TPRST009





TPRS025



TPRSM001



TPRVM001



TPRDG4X2

Table 18.6: 3-Pole SIL Starters

Maximum Horsepower Ratings							Continu-ous Current Rating (A)	Product Reference	Weight (kg)
Single-Phase		Three-Phase							
115 V	230 V	200 V	230 V	460 V	575 V				
1/3	1	2	2	5	5	15	TPRSS009	0.656	
2	3	7 1/2	7 1/2	15	20	30	TPRSS025	0.718	
2	5	10	10	20	25	40	TPRSS038	0.718	
5	10	20	20	40	50	80	TPRSS065	1.248	
5	10	20	20	40	50	80	TPRSS080	1.248	

Table 18.7: 3-Pole PIM Starters

Maximum Horsepower Ratings							Continu-ous Current Rating (A)	Product Reference	Weight (kg)
Single-Phase		Three-Phase							
115 V	230 V	200 V	230 V	460 V	575 V				
1/3	1	2	2	5	5	15	TPRP-M009	0.255	
2	5	10	10	20	25	40	TPRP-M038	0.255	
5	10	20	20	40	50	80	TPRP-M080	0.425	

Table 18.8: SIL Interface Module

Designation	Voltage (Vdc)	Product Reference	Weight (kg)
TeSys island SIL interface module (SIM)	24	TPRSM001	0.159

Table 18.9: Voltage Interface Module (VIM)

Designation	Phase	Voltage (V)	Frequency (Hz)	Product Reference	Weight (kg)
TeSys island Voltage interface module (SIM)	1P/3P	100 to 690	50–60	TPRVM001	0.159

Table 18.10: Digital I/O Module

Designation	Input Vdc	Output A / Vdc	Frequency (Hz)	Product Reference	Weight (kg)
TeSys island DG—Digital 4I/2O Module	24	0.5 / 24	50–60	TPRDG4X2	0.136

Table 18.11: Analog I/O Module

Designation	Inputs		Output		Product Reference	Weight (kg)
	mA dc	Vdc	mA dc	Vdc		
	TeSys island—Analog 2I/2O Module	0–20	–10 to +10	0–20		
	40–20	0–10	4–20	0–10		

TeSys™ K Non-Reversing Mini-Contactors



LC1K09



LP4K09

Table 18.12: Mini-Contactors with AC Operating Coils

Maximum Horsepower Ratings						Maximum Current (A)		Continuous Current Rating (A)	Type of Connection	Auxiliary Contacts		Catalog Number [1][2]
Single-Phase		Three-Phase				Inductive AC3	Resistive AC1			N.O.	N.C.	
115 V	230 V	200 V	230 V	460 V	575 V							
0.5	1	1.5	1.5	3	3	6	20	10	Screw-clamp	1	—	LC1K0610
0.5	1.5	2	3	5	5	9	20	20	Screw-clamp	1	—	LC1K0601
0.5	1.5	2	3	5	5	9	20	20	Screw-clamp	—	1	LC1K0910
1	2	3	3	7.5	10	12	20	20	Screw-clamp	1	—	LC1K0901
1	2	3	3	7.5	10	12	20	20	Screw-clamp	—	1	LC1K1210
1	2	3	3	7.5	10	12	20	20	Screw-clamp	—	1	LC1K1201
<b>4-Pole Mini Contactor</b>												
1/2	1.5	2	3	5	5	9	20	20	Screw-clamp	4	—	LC1K09004
1	2	3	3	7.5	10	12	20	20	Screw-clamp	2	2	LC1K09008
1	2	3	3	7.5	10	12	20	20	Screw-clamp	4	—	LC1K12004
<b>4-Pole Mechanically Interlocked Contactors</b>												
1/2	1.5	2	3	5	5	9	20	20	Screw-clamp	4	—	LC2K09004
1	2	3	3	7.5	10	12	20	20	Screw-clamp	4	—	LC2K12004

Table 18.13: Coil Voltage Codes for AC Contactors

Vac 50/60 Hz	24	110	120	230/240
Code	B7	F7	G7	U7

Table 18.14: Mini-Contactors with 24 Vdc Operating Coils

Maximum Horsepower Ratings						Maximum Current (A)		Continuous Current Rating (A)	Type of Connection	Auxiliary Contacts		Catalog Number [2]
Single-Phase		Three-Phase				Inductive AC3	Resistive AC1			N.O.	N.C.	
115 V	230 V	200 V	230 V	460 V	575 V							
0.5	1	1.5	1.5	3	3	6	20	10	Screw-clamp	1	—	LP1K0610BD
0.5	1	1.5	1.5	3	3	6	20	10	Screw-clamp	—	1	LP1K0601BD
0.5	1.5	2	3	5	5	9	20	20	Screw-clamp	1	—	LP1K0910BD
0.5	1.5	2	3	5	5	9	20	20	Screw-clamp	—	1	LP1K0901BD
1	2	3	3	7.5	10	12	20	20	Screw-clamp	1	—	LP1K1210BD
1	2	3	3	7.5	10	12	20	20	Screw-clamp	—	1	LP1K1201BD
<b>4-Pole Mini Contactor</b>												
1/2	1.5	2	3	5	5	9	20	20	Screw-clamp	4	—	LP1K09004BD
1/2	1.5	2	3	5	5	9	20	20	Screw-clamp	2	2	LP1K09008BD
1	2	3	3	7.5	10	12	20	20	Screw-clamp	4	—	LP1K12004BD
<b>4-Pole Mechanically Interlocked Contactors</b>												
1/2	1.5	2	3	5	5	9	20	20	Screw-clamp	4	—	LP2K09004BD
1	2	3	3	7.5	10	12	20	20	Screw-clamp	4	—	LP2K129004BD

Table 18.15: Mini-Contactors with Low-Consumption 24 Vdc Operating Coil (includes built-in transient suppression) [3]

Maximum Horsepower Ratings						Maximum Current (A)		Continuous Current Rating (A)	Type of Connection	Auxiliary Contacts		Catalog Number [2]
Single-Phase		Three-Phase				Inductive AC3	Resistive AC1			N.O.	N.C.	
115 V	230 V	200 V	230 V	460 V	575 V							
0.5	1	1.5	1.5	3	3	6	20	10	Screw-clamp	1	—	LP4K0610BW3
0.5	1	1.5	1.5	3	3	6	20	10	Screw-clamp	—	1	LP4K0601BW3
0.5	1.5	2	3	5	5	9	20	20	Screw-clamp	1	—	LP4K0910BW3
0.5	1.5	2	3	5	5	9	20	20	Screw-clamp	—	1	LP4K0901BW3
1	2	3	3	7.5	10	12	20	20	Screw-clamp	1	—	LP4K1210BW3
1	2	3	3	7.5	10	12	20	20	Screw-clamp	—	1	LP4K1201BW3

[1] Complete the catalog number with the coil voltage from (for example LC1K0610G7).

[2] For additional terminal options and coil voltage/consumption options, see Catalog MKTED210011EN. Check with local sales office for availability.

[3] 1.8 W inrush.

**TeSys™ K Overload Relays**

**Table 18.16: Overload Relays for 3-Pole Contactors with Screw-Clamp Terminals**



LR2K0316

Current Setting Range (A)	Catalog Number
0.11 to 0.16	<a href="#">LR2K0301</a>
0.16 to 0.23	<a href="#">LR2K0302</a>
0.23 to 0.36	<a href="#">LR2K0303</a>
0.36 to 0.54	<a href="#">LR2K0304</a>
0.54 to 0.8	<a href="#">LR2K0305</a>
0.8 to 1.2	<a href="#">LR2K0306</a>
1.2 to 1.8	<a href="#">LR2K0307</a>
1.8 to 2.6	<a href="#">LR2K0308</a>
2.6 to 3.7	<a href="#">LR2K0310</a>
3.7 to 5.5	<a href="#">LR2K0312</a>
5.5 to 8	<a href="#">LR2K0314</a>
8 to 11.5	<a href="#">LR2K0316</a>
10 to 14	<a href="#">LR2K0321</a> [4]

**LR2K overload relays:**

- AC or DC protection
- Ambient compensated bimetallic
- Class 10
- Single phase sensitivity
- Manual or auto reset
- Full load current dial



E164862  
CCN NLDX  
(screw terminals)



E164862  
CCN NLDX2  
(slip-on and solder-pin terminals)



LR43364  
Class 3211 04



Accessories: [page 18-15](#)  
Dimensions: [page 18-56](#)

**TeSys™ K Reversing Mini-Contactors**

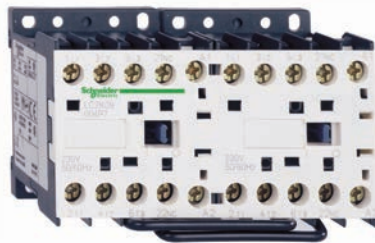

LC2K0910

**Table 18.17: AC Operating Coils**

Maximum Horsepower Ratings						Maximum Current (A)		Continuous Current Rating (A)	Type of Connection	Auxiliary Contacts		Catalog Number [5][6]
Single-Phase		Three-Phase				Inductive AC3	Resistive AC1			N.O.	N.C.	
115 V	230 V	200 V	230 V	460 V	575 V							
1/2	1	1.5	1.5	3	3	6	20	10	Screw-clamp	1	—	<a href="#">LC2K0610</a>
										—	1	<a href="#">LC2K0601</a>
1/2	1.5	2	3	5	5	9	20	20	Screw-clamp	1	—	<a href="#">LC2K0910</a>
										—	1	<a href="#">LC2K0901</a>
1	2	3	3	7.5	10	12	20	20	Screw-clamp	1	—	<a href="#">LC2K1210</a>
										—	1	<a href="#">LC2K1201</a>

**Table 18.18: Coil Voltage Codes for AC Contactors**

Vac 50/60 Hz	24	110	120	230/ 240
Code	B7	F7	G7	U7

[4] Not UL Listed.

[5] Complete the catalog number with the coil voltage code from [Table 18.18](#) (for example, [LC2K0610G7](#)).

[6] For additional terminal options and coil options, see Catalog [MKTED210011EN](#). Check with local sales office for availability.

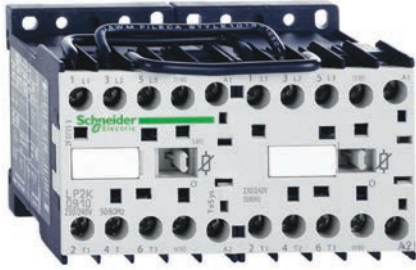

LP2K0910

**Table 18.19: DC Operating Coils**

Maximum Horsepower Ratings						Maximum Current (A)		Continuous Current Rating (A)	Type of Connection	Auxiliary Contacts		Catalog Number [7]
Single-Phase		Three-Phase				Inductive AC3	Resistive AC1			N.O.	N.C.	
115 V	230 V	200 V	230 V	460 V	575 V							
1/2	1	1.5	1.5	3	3	6	20	10	Screw-clamp	1	—	LP2K0610BD
										—	1	LP2K0601BD
1/2	1.5	2	3	5	5	9	20	20	Screw-clamp	1	—	LP2K0910BD
										—	1	LP2K0901BD
1	2	3	3	7.5	10	12	20	20	Screw-clamp	1	—	LP2K1210BD
										—	1	LP2K1201BD



LC2K090045

**Table 18.20: Coil Voltage Codes for DC Contactors**

Coil with integral suppression device available. Add 3 to the code required. Example: JD3 [8]

Vdc	12	20	24	36	48	60	72	100	110	125	200	220	230	240	250
Code	JD	ZD	BD	CD	ED	ND	SD	KD	FD	GD	LD	MD	MPD	MUD	UD

**Table 18.21: Coil Voltages for DC Contactors—Low Consumption [9]**

Vdc	12	24	48	72
Code	JW3	BW3	EW3	SW3

Overload Relays: [page 18-9](#)  
Accessories: [page 18-15](#)  
Dimensions: [page 18-56](#)

[7] For additional terminal options and coil options, see Catalog [MKTED210011EN](#). Check with local sales office for availability.

[8] 3 W inrush.

[9] 1.8 W inrush.

**TeSys™ D Non-Reversing Contactors**



LC1D09



LC1D40A

**Table 18.22: TeSys D Contactors—3 or 4 Pole, Screw Terminal Connections**

Maximum Horsepower Ratings						Maximum Current (A)		Continuous Current Rating (A)	No. of Poles		Instantaneous Auxiliary Contacts		Catalog Number [10][11]
Single-Phase		Three-Phase				Inductive AC3	Resistive AC1		N.O.	N.C.	N.O.	N.C.	
115 V	230 V	200 V	230 V	460 V	575 V								
1/3	1	2	2	5	7.5	9	20	25	3	0	1	1	LC1D09
—	—	—	—	—	—	—			4	2			LC1D120
—	—	—	—	—	—	—	25	25	2	2	1	1	LC1D098
1/2	2	3	3	7.5	10	12			3	0			LC1D12
—	—	—	—	—	—	—	32	32	4	2	1	1	LC1D125
—	—	—	—	—	—	—			2	2			LC1D128
1	3	5	5	10	15	18	40	40	3	0	1	1	LC1D18
—	—	—	—	—	—	—			4	2			LC1D132
—	—	—	—	—	—	—	50	50	2	2	1	1	LC1D188
2	3	7.5	7.5	15	20	25			3	0			LC1D25
—	—	—	—	—	—	—	60	60	4	2	1	1	LC1D258
—	—	—	—	—	—	—			3	0			LC1D32
2	5	10	10	20	25	32	80	80	3	0	1	1	LC1D32
2	5	10	10	20	25	38			3	0			LC1D38
3	5	10	10	30	30	40	125	110	3	0	1	1	LC1D40A
—	—	—	—	—	—	—			4	0			LC1D60A
3	7.5	15	15	40	40	50	200	160	2	2	0	0	LC1D50A
5	10	20	20	40	50	65			3	0			LC1D65A
—	—	—	—	—	—	—	200	160	4	0	0	0	LC1D80A
—	—	—	—	—	—	—			3	0			LC1D80
7.5	15	25	30	60	60	80	200	160	4	0	1	1	LC1D80004
—	—	—	—	—	—	—			2	2			LC1D80008
—	—	—	—	—	—	—	200	160	3	0	1	1	LC1D95
7.5	15	25	30	60	60	95			3	0			LC1D115
—	—	30	40	75	100	115	200	160	3	0	1	1	LC1D115
—	—	40	50	100	125	150			3	0			LC1D150
—	—	—	—	—	—	—	200	160	4	0	0	0	LC1D15004
—	—	—	—	—	—	—							

**Table 18.23: Definite Purpose Ratings, 3-Phase, Breaking All Lines, 100,000 Cycles (Hermetic Refrigeration Compressor)**

Device	FLA	LRA		
		240 V	480 V	600 V
LC1D09 (AC coil only)	9	54	45	36
LC1D12 (AC coil only)	12	72	60	48
LC1D18 (AC coil only)	18	108	90	72
LC1D25 (AC coil only)	25	150	125	100
LC1D32 (AC coil only)	32	192	160	128
LC1D40A	40	240	200	160
LC1D50A	50	300	250	200
LC1D65A	65	390	325	260
LC1D80	75	450	375	300
LC1D115	115	690	575	460
LC1D150	150	900	750	600

**Table 18.24: TeSys D Coil Voltage Codes**

Contactor	D09–D38	D40A–D65A	D80–D150
<b>AC 50/60 Hz</b>			
24 V	B7	B7	B7
110 V	F7	F7	F7
120 V	G7	G7 [12]	G7
240 V	U7	U7	U7
480 V	T7	T7	T7
<b>AC/DC</b>			
24–60 V	BNE	BNE	—
48–130 V	EHE	EHE	—
100–250 V	KUE	KUE	—
<b>DC</b>			
24 V	BL	BBE	BD

[10] Complete the catalog number by adding the coil voltage code from Table 18.24 for example, LC1D09G7).

[11] For additional terminal options and coil options, see Catalog MKTED210011EN. Check with local sales office for availability.

[12] 60 Hz only

TeSys™ D Overload Relays



LRD10



LR9D32

Table 18.25: TeSys D Overload Relays—Ambient Compensated, Bimetallic, Direct Mounting

Current Setting Range (A)	For Direct Mounting to LC1D/LC2D...	Class 10 with Single-Phase Sensitivity	Class 10 without Single-Phase Sensitivity	Class 20 with Single-Phase Sensitivity	Class 20 without Single-Phase Sensitivity	
0.10–0.16	D09–D38	LRD01	LR3D01	—	—	
0.16–0.25		LRD02	LR3D02	—	—	
0.25–0.40		LRD03	LR3D03	—	—	
0.40–0.63		LRD04	LR3D04	—	—	
0.63–1		LRD05	LR3D05	LRD05L	—	
1–1.6		LRD06	LR3D06	LRD06L	—	
1.6–2.5		LRD07	LR3D07	LRD07L	LR3D07L	
2.5–4		LRD08	LR3D08	LRD08L	LR3D08L	
4–6		LRD10	LR3D10	LRD10L	LR3D10L	
5.5–8		LRD12	LR3D12	LRD12L	LR3D12L	
7–10		LRD14	LR3D14	LRD14L	LR3D14L	
9–13		D12–D38	LRD16	LR3D16	LRD16L	LR3D21L
12–18		D18–D38	LRD21	LR3D21	LRD21L	LR3D21L
16–24			LRD22	LR3D22	—	—
17–24	—		—	LRD22L	LR3D22L	
23–32	D25–D38	LRD32	LR3D32	LRD32L	LR3D32L	
30–38	D32–D38	LRD35	LR3D35	—	—	
9–13	D40A–D65A	LRD313	LR3D313	LRD313L	—	
12–18	D40A–D65A	LRD318	LR3D318	LRD318L	—	
17–25	D40A–D65A	LRD325	LR3D325	LRD325L	—	
23–32	D40A–D65A	LRD332	LR3D332	LRD332L	—	
30–40	D40A–D65A	LRD340	LR3D340	LRD340L	—	
37–50	D40A–D65A	LRD350	LR3D350	LRD350L	—	
48–65	D40A–D65A	LRD365	LR3D365	LRD365L	—	
17–25	D40–D95	LRD3322	LR3D3322	LR2D3522	LR3D3522	
23–32	D40–D95 [13]	LRD3353	LR3D3353	LR2D3553	LR3D3553	
30–40	D40–D95 [13]	LRD3355	LR3D3355	LR2D3555	LR3D3555	
37–50	D50–D95 [13]	LRD3357	LR3D3357	LR2D3557	LR3D3557	
48–65	D50–D95 [13]	LRD3359	LR3D3359	LR2D3559	LR3D3559	
55–70	D65–D95	LRD3361	LR3D3361	LR2D3561	LR3D3561	
63–80	D65–D95	LRD3363	LR3D3363	LR2D3563	LR3D3563	
80–104	D95	LRD3365	—	—	—	
80–104	D115–D150	LRD4365	—	—	—	
95–120	D115–D150	LRD4367	—	—	—	
110–140	D150	LRD4369	—	—	—	

Table 18.26: TeSys LR9D Electronic Overload Relays <sup>New!</sup>

Current Setting Range (A)	For Direct Mounting Beneath Contactor LC1D/LC2D	Class 5/10/20/30 Selectable
0.1–0.5	D09–D38	LR9D01
0.4–2	D09–D38	LR9D02
1.6–8	D09–D38	LR9D08
6.4–32	D09–D38	LR9D32

Table 18.27: TeSys D Overload Relays—Solid State

Current Setting Range (A)	For Direct Mounting Beneath Contactor LC1	Class 10	Class 20	Class 10/20 Selectable
60–100	D115–D150	LR9D5367	LR9D5567	LR9D67
90–150	D115–D150	LR9D5369	LR9D5569	LR9D69

TeSys D contactor accessories: [page 18-17](#)  
 TeSys D overload relay accessories: [page 18-23](#)  
 TeSys D replacement coils: [page 18-40](#)  
 Dimensions: [page 18-42](#) to [page 18-52](#)

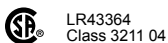
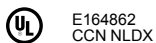

[13] Direct Mount to old D2 style D40 to D65 (no Everlink terminations) and to D80 and D95 only.

**TeSys™ D Reversing Contactors**

Each 3-pole device is prewired with line and load side power wiring for reversing applications. Each 4-pole device is prewired with load side power wiring.

**Table 18.28: TeSys D Mechanically-Interlocked Reversing Contactors**

	Maximum Horsepower Ratings						Maximum Current (A)		Continuous Current Rating (A)	No. of N.O. Power Poles	Built In Auxiliary Contacts (per contactor)		Catalog Number [14][15][16]
	Single-Phase		Three-Phase				Inductive AC3	Resistive AC1			N.O.	N.C.	
	115 V	230 V	200 V	230 V	460 V	575 V							
	1/3	1	2	2	5	7.5	9	20	25	3	1	1	LC2D09
	1/2	2	3	3	7.5	10	12	25	25	3	1	1	LC2D12
	1	3	5	5	10	15	18	32	32	3	1	1	LC2D18
	2	3	7.5	7.5	15	20	25	40	40	3	1	1	LC2D25
	2	5	10	10	20	25	32	50	50	3	1	1	LC2D32
	2	5	10	10	20	25	38			3	1	1	LC2D38
	3	5	10	10	30	30	40	60	60	3	1	1	LC2D40A
	3	7.5	15	15	40	40	50	80	70	3	1	1	LC2D50A
	5	10	20	20	40	50	65		80	3	1	1	LC2D65A
	7.5	15	25	30	60	60	80	125	110	3	1	1	LC2D80
	7.5	15	25	30	60	60	95			3	1	1	LC2D95
	—	—	30	40	75	100	115	200	160	3	1	1	LC2D115[17]
	—	—	40	50	100	125	150			3	1	1	LC2D150[17]

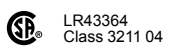

TeSys D contactor accessories: [page 18-17](#)  
TeSys D replacement coils: [page 18-40](#)  
TeSys D dimensions: [page 18-42](#) to [page 18-52](#)

[14] Includes mechanical interlock without electrical contacts. Installer to complete wiring for electronically interlocking contactor operating coils by using a N.C. auxiliary contact integrated in the contactor or optional LADN or LAD8N auxiliary contact block.  
[15] Complete the catalog number by adding the coil voltage code from [Table 18.24 TeSys D Coil Voltage Codes](#), [page 18-11](#) (for example, LC2D09KUE).  
[16] For additional terminal options and coil voltage/consumption options, see Catalog [MKTED210011EN](#). Check with local sales office for availability.  
[17] Includes mechanical interlock (LA9D11502) with prewired electrical contacts for interlocking contactor operating coils.

TeSys™ F Non-Reversing Contactors

Table 18.29: TeSys F Contactors—3 Pole

	Maximum Three-Phase Horsepower Ratings				Maximum Current (A)		Continuous Current Rating (A)	Number of Poles	Catalog Number [18] [19]
	200 V	230 V	460 V	575 V	Inductive AC-3	Resistive AC-1			
	30	40	75	100	115	200	175	3	LC1F115
	40	50	100	125	150	250	200	3	LC1F150
	50	60	125	150	185	275	200	3	LC1F185
	60	75	150	150	225	315	250	3	LC1F225
	60	75	150	200	265	350	285	3	LC1F265
	75	100	200	250	330	400	370	3	LC1F330
	100	125	250	300	400	500	420	3	LC1F400
	150	200	400	500	500	700	700	3	LC1F500
	250	300	600	800	630	1000	1000	3	LC1F630
	350	400	800	900	800	1000	1000	3	LC1F800
	350	400	900	—	1000	1000	1250	3	LC1F1000
	—	450	900	900	780	1600	1350	3	LC1F780
	Current Rated					1400	1400	3	LC1F1400
						1700	1700	3	LC1F1700
2100						2100	3	LC1F2100	

Table 18.30: TeSys F Coil Voltage Codes [19]

Contactor	F115–F150	F185–F225	F265–F330	F400	F500	F630	F780[20]	F800[21]	F1000	F1400–F2100
Coil Suffix Code AC 50/60 Hz										
120 V	G7	G7	G7	G7	G7	G7	G7	FW	G7	G7
Coil Part Number (Order Separately) AC 50/60 Hz										
120 V	LX9FF127	LX9FG127	LX1FH1272	LX1FJ127	LX1FK127	LX1FL110	LX1FX110	LX4F8FW	LX1FK065[22]	LX1FK070[22]
240 V	LX9FF220	LX9FG220	LX1FH2402	LX1FJ240	LX1FK240	LX1FL220	LX1FX220	LX4F8MW	LX1FK127[22]	LX1FK127[22]
480 V	LX9FF500	LX9FG500	LX1FH5002	LX1FJ500	LX1FK500	LX1FL415	LX1FX415	—	LX1FK240[22]	LX1FK240[22]
Coil Part Number (Order Separately) DC										
24 V	LX4FF024	LX4FG024	LX4FH024	—	—	—	—	—	—	—

TeSys™ F Overload Relays

Table 18.31: TeSys F 3-Phase Overload Relays—Solid State, Separate Mounting [23]

Current Setting Range A	For Direct Mounting to Contactor LC1••••	Class 10 Catalog Number	Class 20 Catalog Number	Class 10/20 Selectable Catalog Number
30–50	F115–F185	LR9F5357	LR9F5557	LR9F57
48–80	F115–F185	LR9F5363	LR9F5563	LR9F63
60–100	F115–F185	LR9F5367	LR9F5567	LR9F67
90–150	F115–F185	LR9F5369	LR9F5569	LR9F69
132–220	F185[24]–F400	LR9F5371	LR9F5571	LR9F71
200–330	F225–F500	LR9F7375	LR9F7575	LR9F75
300–500	F330–F500	LR9F7379	LR9F7579	LR9F79
380–630	F400–F630, F800	LR9F7381	LR9F7581	—

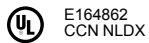

E164862  
CCN NLDX



LR43364  
Class 3211 04



TeSys F contactor accessories: page 18-18  
 TeSys F overload relay accessories: page 18-24  
 TeSys F replacement coils and parts: page 18-41, page 18-40, and page 18-40  
 TeSys F dimensions: page 18-45 and page 18-54

TeSys™ F Reversing Contactors

Components are available for customer assembly of TeSys F reversing contactors. For example, the following components must be ordered to build a reversing contactor, 75 hp @ 460 V, with a 120 V / 60 Hz coil:

Table 18.32: Example of Components

Description	Quantity	Catalog Number
Contactors	2	LC1F115G7
Lugs (page 18-22)	6	DZ2FF1
Auxiliary contacts	2	LADN11
Power connections	1	LA9FF976
Mechanical interlock	1	LA9FF970



LC1F265

[18] Complete the catalog number by adding the coil voltage code from Table 18.24 TeSys D Coil Voltage Codes, page 18-11 (for example, LC1F265G7), or order the contactor (without a coil) and the coil separately. All coils except F780 include 1 N.O. holding circuit interlock contact. The F780 uses two coils that must be wired in series.  
 [19] For additional pole options and coil voltage options, see Catalog MKTED210011EN. Check with local sales office for availability.  
 [20] LC1F780 contactors operate with 2 coils as a set. The LX1FX\* part number includes both coils.  
 [21] Also requires rectifier DR5TE4U for 110–240 V coils.  
 [22] Order 2 coils and connect them in series.  
 [23] When mounting overload relays LR9F5•57–LR9F5•71 and LR9F57–LR9F71 directly beneath the contactor, supporting the relays with a mounting plate is recommended. With overload relays LR9F7•–LR9F7•81 and LR9F75–LR9F81, use of a support mounting plate is mandatory. Refer to page 18-24  
 [24] Interconnection kit LA7F407 is required to mount an LR9F5•71 and LR9F71 to an LC1F185.



Table 18.33: 3-Pole Contactors

Maximum Three-Phase Horsepower Ratings				Maximum Current (A)		Continuous Current Rating (A)	Holding Circuit Contact Built Into Coil		Catalog Number [25]
200 V	230 V	460 V	575 V	Inductive AC3	Resistive AC1		N.O.	N.C.	
30	40	75	100	115	200	175	1	0	LC1F115
40	50	100	125	150	250	200	1	0	LC1F150
50	60	125	150	185	275	200	1	0	LC1F185
60	75	150	150	225	315	250	1	0	LC1F225
60	75	150	200	265	350	285	1	0	LC1F265
75	100	200	250	330	400	370	1	0	LC1F330
100	125	250	300	400	500	420	1	0	LC1F400
150	200	400	500	500	700	700	1	0	LC1F500
250	300	600	800	630	1000	1000	1	0	LC1F630
350	400	800	900	800	1000	1000	0	0	LC1F800
—	450	900	900	780	1600	1350	0	0	LC1F780

Table 18.34: Auxiliary Contact (Electrical Interlocking)—2 must be purchased

For use with	Number of Contacts	Maximum Number of Blocks Per Contactor	Contact Arrangement		Catalog Number
			N.O.	N.C.	
LC1F to be ordered separately	1	1	1	—	LADN10 [26]
			—	1	LADN01
	2	2	1	1	LADN11
			2	—	LADN20 [26]
	4	2	2	2	LADN22
			1	3	LADN13
			4	—	LADN40 [26]
			—	4	LADN04
			3	1	LADN31
			2	2	LADC22 [27]

Table 18.35: Accessories—For the Assembly of 3-Pole Reversing Contactors (Horizontal Mounting)

With 2 Identical Contactors [28]	Set of Power Connections Catalog Number	Horizontal Mounting Mechanical Interlock Kit Catalog Number
LC1F115	LA9FF976	LA9FF970
LC1F150	LA9F15076	LA9FF970
LC1F185	LA9FG976	LA9FG970
LC1F225	LA9F22576	LA9FG970
LC1F265	LA9FH976	LA9FJ970
LC1F330	LA9FJ976	LA9FJ970
LC1F400	LA9FJ976	LA9FJ970
LC1F500	LA9FK976	LA9FJ970
LC1F630, F800	LA9FL976	LA9FL970

TeSys F contactor accessories: page 18-18  
TeSys F overload relay accessories: page 18-24  
TeSys F replacement coils and parts: page 18-41, page 18-40, and page 18-40  
TeSys F dimensions: page 18-45



E164862  
CCN NLDX



LR43364  
Class 3211 04



TeSys™ K Contactors

Table 18.36: Instantaneous Auxiliary Contact Blocks[1]



Clip-on front mounting, 1 block per contactor and 2 blocks per pair of mechanically interlocked contactors			
Type of connection	Auxiliary Contacts		Catalog Number
	N.O.	N.C.	
Screw clamp	2	—	LA1KN20
	—	2	LA1KN02
	1	1	LA1KN11
	4	—	LA1KN40 [2]
	3	1	LA1KN31 [2]
	2	2	LA1KN22 [2]
	1	3	LA1KN13 [2]
	—	4	LA1KN04 [2]

Table 18.37: Electronic Time Delay Auxiliary Contact Blocks

Clip-on front mounting, 1 block per contactor and 2 blocks per pair of mechanically interlocked contactors				
Voltage (V)	Type	Timing Range (S)	Contacts	Catalog Number
24–48 Vac or Vdc	On-delay	1–30	SPDT	LA2KT2E
110–240 Vac	On-delay	1–30	SPDT	LA2KT2U

NOTE: Relay outputs, with single pole double throw, 240 Vac/Vdc, 2 A max.  
Maximum switching capacity 250 VA / 150 W  
Operating temperature: –10 to +60°C (14 to 140°F)  
Reset time: 1.5 s during time delay, 0.5 after time delay

[25] Complete the catalog number with the coil voltage code from and (for example, LC1F115G7). All coils except F780 include 1 N.O. holding circuit interlock contact. The F780 uses 2 coils that must be wired in series.  
[26] Cannot be used for interlocking.  
[27] Including 1 N.O. + 1 N.C. make-before-break overlapping contacts.  
[28] For two contactors of different size, refer to page 18-22.  
[1] For additional terminal options, see Catalog MKTED210011EN. Check with local sales office for availability.  
[2] Block of 4 contacts cannot be used with LP4K or LP5K contactors.



LA2KT2U



Table 18.38: Suppressor Module with Incorporated LED Indicator

Clip-on front mounting			
Voltage range	Type	Sold in lots of	Catalog Number
12–24 Vac/Vdc	Varistor	5	LA4KE1B [3]
32–48 Vac/Vdc	Varistor	5	LA4KE1E [3]
50–129 Vac/Vdc	Varistor	5	LA4KE1FC [3]
130–250 Vac/Vdc	Varistor	5	LA4KE1UG [3]
12–24 Vdc	Diode + Zener	5	LA4KC1B [4]
32–48 Vdc	Diode + Zener	5	LA4KC1E [4]
220–250 Vac	RC	5	LA4KA1U [5]

Table 18.39: Power Connectors

Description	Sold in lots of	Catalog Number
Set of 6 power connections for reversing contactors with screw-clamp terminals	100	LA9K0969

Table 18.40: Accessories for Overload Relays

Description	Type of Connection	Catalog Number
Terminal block for separate clip-on mounting of the overload relay onto 35 mm omega rail (AM1DP200)	Screw-clamp	LA7K0064

[3] Protection by limitation of the transient voltage to 2 Uc maximum. Maximum reduction of the transient voltage peaks. Slight time delay on drop-out (1.1–1.5 times normal).  
 [4] No overvoltage or oscillation frequency. Polarized component. Slight time delay on drop-out (1.1–1.5 times normal).  
 [5] Protection by limitation of the transient voltage to 3 Uc maximum and limitation of the oscillation frequency. Slight time delay on drop-out (1.2 times normal).



Front Mounted Auxiliary Blocks

**TeSys™ D and F Auxiliary Contacts, Time Delay, Mechanical Latch**

**Table 18.41: Standard, Instantaneous Auxiliary Contact Blocks**

Snap-On Mounting	Number of Contacts	Contact Arrangement		Catalog Number [6]
		N.O.	N.C.	
To the front of LC•DT20–D258 (4P), LC•D09–D150 [6] or To the right side of LC•F	4 [6]	2	2	LADN22 [7]
		1	3	LADN13 [7]
		4	0	LADN40 [7]
		0	4	LADN04 [7]
		3	1	LADN31 [7]
		2	2	LADC22 [7] [8]
To the front of LC•D80–D150 or To the left side of LC•F	2	1	1	LADN11 [7]
		2	0	LADN20 [7]
		0	2	LADN02 [7]
To the side of LC•D09 to D150 only (not for use on TeSys F)	1	1	0	LADN10 [9]
		0	1	LADN01 [9]
	2	1	1	LAD8N11 [10]
		2	0	LAD8N20 [10]

**Table 18.42: Instantaneous Blocks with Dust-Tight Auxiliary Contacts (IP54) NEMA 12**

Snap-On Mounting	Standard Contacts		Dust-Tight Contacts		Catalog Number
	N.O.	N.C.	N.O.	N.C.	
To the front of LP•D40–D80, LC•DT20–D258 (4P), LC•D09 to D95 or To the right side of LC•F	—	—	2	—	LA1DX20
	2	—	2	—	LA1DZ40
	1	1	2	—	LA1DZ31
	—	—	2	—	LA1DY20 [11]

**Table 18.43: Pneumatic Time Delay Contact Blocks**

Snap-On Mounting	Time Delay Contacts		Type	Range of Time Delay	Catalog Number [12]
	N.O.	N.C.			
To the front of LP•D40–D80, LC•DT20–D258 (4P), LC•D09 to D150 or To the right side of LC•F	1	1	On energization (on delay)	0.1 to 3 s [13]	LADT0
				0.1 to 30 s	LADT2
				10 to 180 s	LADT4
	1	1	On de-energization (off-delay)	1 to 30 s [14]	LADS2
				0.1 to 3 s [13]	LADR0
				0.1 to 30 s	LADR2
			10 to 180 s	LADR4	

**Table 18.44: Mechanical Latch Blocks with Manual or Electrical Unlatch (TeSys D only)**

Front snap-on mounting onto	Application	Catalog Number [15]
LC•D09 to D65A	For silent operation and energy conservation	LAD6K10 [16][17]
LC1D80 to D150, LP1D80	For silent operation and energy conservation	LA6DK20 [16]

**Table 18.45: Coil Voltage Codes for LAD6K/LA6DK Mechanical Latch Blocks**

Volts	24	110/ 127	220/ 240
AC or DC	B	F	M

TeSys D contactors: [page 18-11](#) and [page 18-13](#)  
TeSys D overload relay accessories: [page 18-23](#)  
TeSys D replacement coils: [page 18-40](#)  
TeSys D dimensions: [page 18-42](#) to [page 18-52](#)



[6] For low consumption coils (LC1D09–D38 only), only one front-mounted two-contact block allowed. No side-mounted contact blocks allowed.  
[7] For spring terminal versions of these blocks, add a 3 to the end of the catalog number (for example, LADN223). For slip-on versions, add 9 to the end of the catalog number (for example, LADN229).  
[8] Including 1 N.O. + 1 N.C. make-before break overlapping contacts.  
[9] This block cannot be added to the LC1D 09–D38 contactors; a maximum of 2 blocks can be mounted on the LC1D40A-LC1/LP1D80 contactors only.  
[10] 1 block may be added to the left side of LC1D09–D38, AC coils only; only 1 block may be added to either side of the LC1D40A-D80 contactors, AC coils only. Cannot be installed on TeSys D contactors with DC coils.  
[11] Device supplied with 4 ground terminal points.  
[12] For spring terminal versions of these blocks, add a 3 to the end of the catalog number (for example, LADT23).  
[13] Scale range is expanded between 0.1 and 0.6 seconds on the dial for more accurate settings at the lower end of the range.  
[14] Switching time between the opening of the N.C. contact and the closing of the N.O. contact: 40 ms ± 15 ms.  
[15] To complete the catalog number, add the coil voltage code from Table 18.45. For additional voltage options, see Catalog MKTED210011EN. Check with local sales office for availability.  
[16] Does not include internal coil clearing contact.  
[17] Low consumption DC contactors (and relays) (code coil •L) are not compatible with the LAD6K10• mechanical latching blocks.

TeSys™ D and F Accessories [18]

Table 18.46: For Power Pole or Control Connection

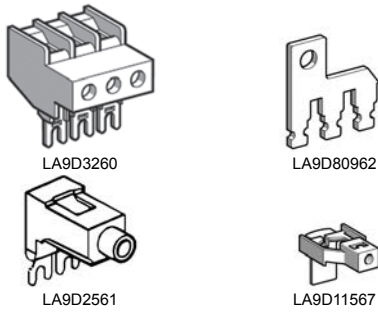

Description		For use with contactors LC1/LP1	Sold in lots of	Catalog Number
Connectors for larger cable sizes	3 poles #4 AWG (25 mm <sup>2</sup> )	D09–D38	1	LA9D3260
Everlink™ terminal block	3 poles	D40A–D65A	1	LAD96560
Links for the parallel connection of:	3 poles (wye-delta shorting strap)	D09–D38	10	LAD9P3
		D40A–D65A	1	LAD9P33
		D80, D95	1	LA9D80962
		F115	1	LA9FF601
		F150, F185	1	LA9FG601
		F225, F265, F330, F400	1	LA9FH601
		F500	1	LA9FK601
		Control circuit take-off from main pole	D80, D95	10
	D115, D150	10	LA9D11567	
Replacement power terminal block		D115, D150	1	LA9D115603
Plunger (fire pump accessory)		D09–150	—	LAD9FP3

Table 18.47: For Marking

Description		For use with contactors LC1/LP1	Sold in lots of	Catalog Number
Reference label holder	Snap-on, 8 x 22 mm	4-pole contactors D80–D115	100	LA9D92
	Snap-on, 8 x 18 mm, 3 poles	D09–D65A, DT20–DT80A, LADN, LADT, LADR	100	LAD90
Sheet of 300 labels self adhesive, 7 x 21 mm		For holder LA9D92	1	LA9D93

Table 18.48: For Mounting

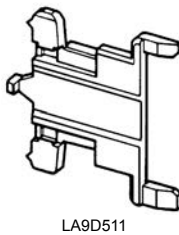

Description		For use with contactors LC1/LP1	Sold in lots of	Catalog Number
Set of shims for mounting LAD8N and LA8DN		D80–D95	1	LA9D511
Retrofit plate for replacing LC1D40–D65 with LC1D40A–D65A		D40A–D65A	1	LAD7X3
35 mm DIN Rail — 2 m		LC1D09–D80	10	AM1DP200

Table 18.49: Replacement Contacts

		For use with contactors		Catalog Number
Three-pole		LC1D115	3 poles	LA5D1158031
		LC1D150	3 poles	LA5D150803
Four-pole		LC1D115	4 poles	LA5D115804

Table 18.50: Arc Chambers

		For use with contactors		Catalog Number
Three-pole		LC1D115	3 poles	LA5D11550
		LC1D150	3 poles	LA5D15050
Four-pole		LC1D115	4 poles	LA5D115450

TeSys D contactors: [page 18-11](#) and [page 18-13](#)  
 TeSys D overload relay accessories: [page 18-23](#)  
 TeSys D contactor accessories: [page 18-17](#)  
 TeSys D replacement coils: [page 18-40](#)  
 TeSys D dimensions: [page 18-42](#) to [page 18-52](#)  
 TeSys F contactors: [page 18-14](#) and [page 18-14](#)  
 TeSys F replacement coils and parts: [page 18-41](#), [page 18-40](#), and [page 18-40](#)

[18] For additional accessory and replacement part options, see Catalog MKTED210011EN. Check with local sales office for availability.

## RC and Varistor Coil Suppressors

### RC Coil Suppressor



LA4DA1U

- Limitation of transient voltage to 300% of nominal voltage maximum.
- Oscillating frequency limited to 400 Hz maximum. Slight increase in drop-out time (1.2–2 times normal).

**Table 18.51: Resistor/Capacitor Circuit (RC) for Reduction of Electrical Noise in AC Contactor Coils**

Installed by	Mounting on	Operating Voltage 50/60 Hz	Catalog Number
Snapping into the cavity on the right side without tools [19]	LC•D09–D38 (3P), LC1DT20–DT40 (4P)	24–28 Vac	LAD4RCE
		50–127 Vac	LAD4RCG
		110–240 Vac	LAD4RCU
Snap-on mounting, and connection without tools to the contactor coil terminals	LC1D40A–65A (3P), LC1DT60A–DT80A (4P)	24–48 Vac	LAD4RC3E
		50–127 Vac	LAD4RC3G
		110–240 Vac	LAD4RC3U
		380–415 Vac	LAD4RC3N
Screw connection to the contactor coil terminals	LC•D80–D150 (3P), LC1D80–D115 (4P)	24–48 Vac	LA4DA2E
		50–127 Vac	LA4DA2G
		110–240 Vac	LA4DA2U
		380–415 Vac	LA4DA2N

### Varistor Coil Suppressor [20]

- Limitation of transient voltage value to 200% of nominal voltage maximum.
- Maximum reduction of transient voltage peaks. Slight increase in drop-out time (1.1–1.5 times normal).

**Table 18.52: Varistor (Peak Limiting) for Reduction of Electrical Noise in AC Contactor Coils**

Installed by	Mounting on	Operating Voltage	Catalog Number
Snapping into the cavity on the right side without tools [19]	LC•D09–D38 (3P), LC1DT20–DT40 (4P)	24–48 Vac	LAD4VE
		110–250 Vac	LAD4VU
Snap-on mounting, and connection without tools to the contactor coil terminals	LC1D40A–D65A (3P), LC1DT60A–DT80A (4P)	24–48 Vac/Vdc	LAD4V3E
		110–250 Vac/Vdc	LAD4V3U
Screw connection to the contactor coil terminals	LC•D80–D115 (3P), LC1D80–D115 (4P)	24–48 Vac	LA4DE2E
		110–250 Vac	LA4DE2U
Screw connection to the contactor coil terminals	LC•D80–D95 (3P), LC1D80 (4P)	24–48 Vdc	LA4DE3E
		110–250 Vdc	LA4DE3U

### Diode Coil Suppressor

- No overvoltage or oscillating frequency.
- Polarized component. Increased drop-out time (6–10 times normal).

**Table 18.53: Diode for Reduction of Electrical Noise in DC Contactor Coils**

Installed on the upper part by	Mounting on	Operating Voltage, DC	Catalog Number
Snap-on mounting and connection w/o tools to the contactor coil terminals	LC•D09 to D38 (3P), LC1DT20 to DT40 (4P)	24–250 Vdc	LAD4DDL
Clip-on front mounting	LC•D40A to D65A (3P), LC1DT60A to DT80A (4P)	24–250 Vdc	LAD4D3U
Screw connection of wire to the contactor coil terminals	LC•D80 to D95 (3P), LC1D80 (4P)	24–250 Vdc	LA4DC3U



LA4DC3U

[19] Installing the suppressor into the cavity makes the electrical connection. Overall width of the contactor remains the same.

[20] For additional accessory and replacement part options, see Catalog MKTED210011EN. Check with local sales office for availability.

**Bidirectional Diode Coil Suppressor**

- Protection provided by limiting the transient voltage to 2 Uc max.
- Maximum reduction of transient voltage peaks

**Table 18.54: Bidirectional Peak Limiting Diode<sup>[21]</sup>**

Installed by	Mounting on	Operating Voltage		Catalog Number
		Vac (50/60 Hz)	Vdc	
Snapping into the cavity on the right side of the contactor <sup>[22]</sup>	LC•D09–D38 (3P) <sup>[23]</sup>	24	—	LAD4TB
	LC1DT20–DT40 (4P)	—	24	LAD4TBDL
Clip-on front mounting and connection without tools to the contactor coil terminals <sup>[23]</sup>	LC•D40A–D65A (3P), LC1DT60A–DT80A (4P)	12–24	12–24	LAD4T3B
	LC•D80–D95 (3P), LC1D80 (4P)	—	24	LA4DB3B

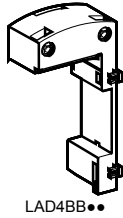

**Table 18.55: Cabling Accessories<sup>[21]</sup>**

Usage	Mounting on	Operating Voltage 50/60 Hz	Catalog Number
For adapting existing wiring to a new product or for use with top-mounting accessory.	LC1D09–D38	Without coil suppression	LAD4BB
		With coil suppression (varistor)	LAD4BBVE
For adapting existing wiring to a new product or for use with top-mounting accessory	LC1D40A–D65A	24–48 Vac	LAD4BBVVG
		50–127 Vac	LAD4BB3
For adapting existing wiring to a new product or for use with top-mounting accessory	LC1D40A–D65A	Without coil suppression	LAD4BB3

TeSys D contactors: page 18-11 and page 18-13  
 TeSys D contactor accessories: page 18-17  
 TeSys D overload relay accessories: page 18-23  
 TeSys D replacement coils: page 18-40  
 TeSys D dimensions: page 18-42 to page 18-52

**TeSys™ D Electronic Timers and Interface Modules**

The following accessories require use of cabling accessories (LAD4BB••) for proper mounting. See page 18-20 for illustration.

**Table 18.56: Electronic Serial Timer Modules**

Type	Operational Voltage <sup>[25]</sup>		Time Delay	Catalog Number
	24–250 Vac	100–250 Vac		
On-delay	LC1D09–D65A	LC1D80–D150	0.1–2 s	LA4DT0U
			1.5–30 s	LA4DT2U
			25–500 s	LA4DT4U



**Table 18.57: Interface Modules<sup>[21]</sup>**

Interface Type <sup>[26]</sup>	Operational Voltage		Input Voltage	Catalog Number
	24–250 Vac	100–250 Vac		
Relay	LC1D09–D150	—	24 Vdc	LA4DFB
Solid State	LC1D09–D65A	LC1D80–D115	24 Vdc	LA4DWB



**Table 18.58: TeSys Safety-Chain Identification System<sup>New!</sup>**

Description	Compatibility	Package Qty	Catalog Number
Red retrofit contactor safety cover	LC1D09–D65A, CAD32, CAD50	10	LAD9ET1S
	LC1D80	1	LAD9ET3S
	LC1D115–D150	1	LAD9ET4S
Red auxiliary contact block, 2 N.O. + 2 N.C.	LC1D09–D150, CAD32, CAD50	1	LADN22S
Red retrofit safety sticker	TeSys U	10	LU9ET1S

[21] For additional voltage and accessory options, see Catalog MKTED210011EN. Check with local sales office for availability.

[22] Installing the suppressor into the cavity makes the electrical connection. Overall width of the contactor remains the same.

[23] For LC•D09–LC•D65A with DC or low consumption DC coils, 3–pole contactors are fitted with built-in bidirectional diode suppression as standard.

[24] Mounting at the top of the contactor on coil terminals A1 and A2.

[25] For 24 V operation, the contactor must be fitted with a 21 V coil: coil voltage code Z5 for 50 Hz; Z6 for 60 Hz; and ZD for DC.

[26] Adapter required for D09–D65A, see .

**TeSys™ D Reversing Contactors**

**Table 18.59: Components and Kits for Reversing Assemblies<sup>[27]</sup>**

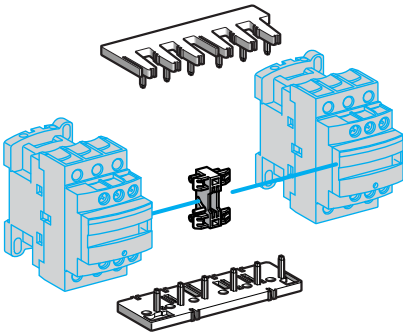
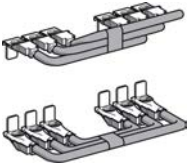
	Description		For contactor (2 identical contactors)	Part Number
<b>Kits for Assembly of Reversing Contactors</b>				
 <p>LAD 9R1</p>	Kit comprising of: <ul style="list-style-type: none"> <li>• Mechanical interlock</li> <li>• Electrical wiring links</li> <li>• Power wiring links</li> </ul>		LC1 D09 to D38	<a href="#">LAD9R1V</a>
			LC1 DT20 to DT40	
 <p>LA9 D8069</p>	Kit comprising of: <ul style="list-style-type: none"> <li>• Mechanical interlock</li> <li>• Power wiring links</li> </ul>		LC1 D09 to D38	<a href="#">LAD9R1</a>
			LC1 D40A to D65A	
	<b>For Contactor (2 Identical Contactors)</b>	<b>Mechanical Interlock</b>	<b>Mechanical Interlock with Integral Electrical Interlocking</b>	<b>Reversing Power Links (Parallel and Reverser)</b>
<b>Components for Assembly of Reversing Contactors</b>				
	LC1 D40A to D65A	<a href="#">LAD4CM</a>	—	<a href="#">LA9D65A69</a>
	LC1 D80 to D95 (AC coil)	<a href="#">LA9D50978</a>	<a href="#">LA9D4002</a>	<a href="#">LA9D8069</a>
	LC1 D80 to D95 (DC coil)	<a href="#">LA9D80978</a>	<a href="#">LA9D8002</a>	<a href="#">LA9D8069</a>
	LC1 D115 to LC1D 150	—	<a href="#">LA9D11502</a>	<a href="#">LA9D11569</a>

TeSys D contactors: [page 18-11](#) and [page 18-13](#)  
 TeSys D contactor accessories: [page 18-17](#)  
 TeSys D replacement coils: [page 18-40](#)  
 TeSys D dimensions: [page 18-42](#) to [page 18-52](#)

[27] For additional reversing accessory options, see Catalog [MKTED210011EN](#). Check with local sales office for availability.

TeSys™ F Reversing Contactors [28]

Table 18.60: Component Parts for the Assembly of F-Line 3-pole Reversing Contactors

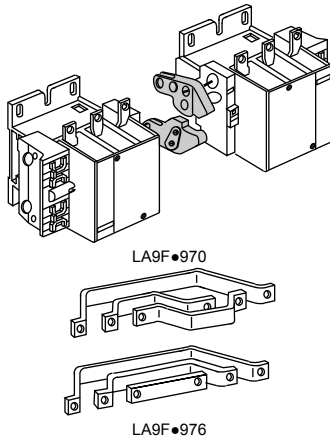

With 2 Identical Contactors	Set of Power Connections Cat. No.	Mechanical Interlock Kit Cat. No.
Horizontal Mounting		
LC1F115	LA9FF976	LA9FF970
LC1F150	LA9F15076	LA9FF970
LC1F185	LA9FG976	LA9FG970
LC1F225	LA9F22576	LA9FG970
LC1F265	LA9FH976	LA9FJ970
LC1F330	LA9FJ976	LA9FJ970
LC1F400	LA9FJ976	LA9FJ970
LC1F500	LA9FK976	LA9FJ970
LC1F630 or F800	LA9FL976	LA9FL970

TeSys™ F Contactors

Table 18.61: Suppressor Blocks

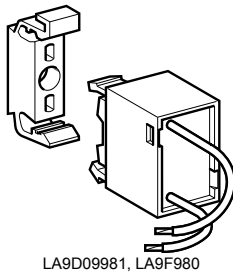

Operating limit: up to 220 V, 50/60 Hz coils		
Description	For Use with coils	Catalog Number
Suppressor block (clip-on mounting to coil)	LX1FH, F265, F330	LA9F980
	LX1FJ, FK, FL, FX, F400, F500, F630, F780, LX9FF, FG, FH, F115, F150, F185, F225, F265, F330	LA9D09980
Mounting bracket (for 35 mm DIN rail or panel mounting) for suppressor block		LA9D09981

Table 18.62: Lugs and Terminal Shrouds for TeSys F Contactors

Contactors Type LC1	Cable Size AWG Range	Lug Kit (Quantity of 6)	Individual Lug (Quantity of 1)
F115	14 to 2/0	DZ2FF6	DZ2FF1
F150, F185	6 to 3/0	DZ2FG6	DZ2FG1
F225, F265, F330	6 to 300 MCM	DZ2FH6	DZ2FH1
F400	4 to 500 MCM	DZ2FJ6	DZ2FJ1
F500	2 x 2 to 600 MCM	DZ2FK6	DZ2FK1
F630	3 x 2 to 600 MCM	DZ2FL6	DZ2FL [29]
F800	3 x 2 to 600 MCM	DZ2FL6	—
F780	4 x 1/0 to 750 MCM	DZ2FX6	—

Table 18.63: Lugs and Terminal Shrouds for TeSys F Contactor with TeSys F Overload Relay [30]

Contactors Type LC1	Overload Relay (Direct Mount to Contactor)	Contactors Line Side Lug (Qty)	Line Side Cable Size AWG Range	Overload Load Side Lug (Qty)	Load Side Cable Size AWG Range
F115	LR9F5•57–F5•69, LR9F57–F69	DZ2FF1 (3)	14 to 2/0	DZ2FG1 (3)	6 to 3/0
F150, F185	LR9F5•57–F5•71, LR9F57–F71	DZ2FG6 (1)	6 to 3/0	(included with line side lug kit)	6 to 3/0
F225, F265	LR9F5•71, LR9F71	DZ2FG6 (1)	6 to 300 MCM	(included with line side lug kit)	6 to 300 MCM
F265, F330	LR9F7•75–F7•79, LR9F75–F79	DZ2FH1 (3)	6 to 300 MCM	—	4 to 500 MCM
F400	LR9F7•75–F7•81, LR9F75–F81	DZ2FJ1 (3)	4 to 500 MCM	—	4 to 500 MCM
F500	LR9F7•75–F7•81, LR9F75–F81	DZ2FK1 (3)	2 X 2 to 600 MCM	—	4 to 500 MCM
F630	LR9F7•81, LR9F81	DZ2FL1 (1) DZ2FL2 (1) DZ2FL3 (1)	3 X 2 to 600 MCM	DZ2FR1 (1)	4 to 500 MCM

These clear plastic protective shrouds are an effective means to meet international touch-safe requirements for power terminals. They are designed to be used with power cables that have been bolted to the terminal.

**NOTE:** The protection shrouds do not attach to contactors or overloads using DZ2F lug kits.

[28] For additional reversing accessory options, see Catalog MKTED210011EN. Check with local sales office for availability.

[29] For 2-pole F630 contactors, order two DZ2FL1 (L1 and T2), and two DZ2FL3 (L2 and T1). For 4-pole F630, order two DZ2FL1 (L1 and T4), four DZ2FL2 (L2, T2, L3, T3) and two DZ2FL3 (L4 and T1).

[30] Lug kits ending in the number 6 include 6 identical lugs. In some cases the LR9F overload relay mounted directly on the load side of an LC1F contactor will require a different size lug for your choice of contactor and overload. If the two sizes are different, order 3 of each size lug. Mounting hardware (screws, washers, and nuts) are provided with the contactors and overload relays, not with the lugs.



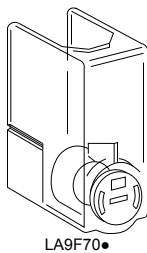

LA9F70•

Table 18.64: Power Terminal Protection Shrouds

For Use With 2-, 3-, And 4-pole Contactors	Number of Shrouds Per Set	Catalog Number
LC1F115	6	LA9F701
LC1F150, F185	6	LA9F702
LC1F225, F265, F330, F400 and F4002, F500 and F5002	6	LA9F703
LC1F630, F6302 and F800	6	LA9F704
LC1F1154	8	LA9F706
LC1F1504 and F1854	8	LA9F707
LC1F2254, F2654, F3304, F4004, F5004	8	LA9F708
LC1F6304	8	LA9F709

For contactors LC1F115, LC1F150, and LC1F185, an available touch-safe terminal block may be used in place of lugs for power connections.

Table 18.65: Insulated Terminal Blocks

For contactor type LC1	For overload relay LR9	Maximum Cable Size	Catalog Number
F115, F150, F185	F5•57, F5•63, F5•67, F5•69, F57, F63, F67, F69	300 MCM	LA9F103

TeSys F contactor accessories: [page 18-18](#)  
 TeSys F overload relay accessories: [page 18-24](#)  
 TeSys F replacement coils and parts: [page 18-41](#), [page 18-40](#), and [page 18-40](#)  
 TeSys F dimensions: [page 18-45](#), [page 18-54](#)

### TeSys D Overload Relay Accessories

Table 18.66: Mounting Kits and Plates<sup>[1]</sup>

Description	For use with overload relays:	Cat. No.
Separate mounting kits for mounting to 35 mm DIN rail or for panel mounting with screws	LRD01–35 and LR3D01–35	LAD7B10
	LRD01–35 and LRD01–35 for ring tongue terminals	LAD7B106
	LRD04L–32L, LR3D04L–32L, and LR9D01–32	LAD7B205
	LRD3•••, LR3D3•••, LR2D35••	LAD96560



LA7D901

Table 18.67: Accessories

Description	For use with	Standard Package	Catalog Number
Prewiring kit allows direct connection of the N.C. contact of relay LRD01–D32 or LR3D01–D32 to the contactor	LC1D09 to D18	10	LAD7C1
	LC1D25 to D38	10	LAD7C2
Remote stop/tripping or electrical reset <sup>[2]</sup>	LRD01–D32, LRD3, LR3D01–D32, LR3D3	1	LAD703 <sup>[3]</sup>
	All relays except LRD01–D32, LR3D01–D31	1	LA7D03 <sup>[3]</sup>
Reset by flexible cable 500 mm (19.6 in.)	LRD01–D32, LRD3, LR3D3	1	LAD7305

Table 18.68: Control Circuit Voltages for LA7D03 and LAD703

Volts	24	110
AC 50/60 Hz	B	F
DC	B	F



LA7D03

[1] When using mounting plates, separate mounting kits are also required.  
 [2] The time that the LA7D03 can remain energized depends on its rest time; 1 s pulse with 9 s rest time; 5 s pulse with 30 s rest time; 10 s pulse with 90 s rest time; maximum pulse duration of 20 s with rest time of 300 s. Consumption on inrush and sealed: < 100 VA  
 [3] Part number to be completed by adding coil voltage code, (for example, LAD703F).

TeSys F Overload Relay Accessories

Table 18.69: Mounting Plate for Overload Relay



For use with relays	Catalog Number
LR9F5•57, F5•63, F5•67, F5•69, F5•71, F57, F63, F67, F69, and F71	<a href="#">LA7F901</a>
LR9F7•75, F7•79, F5•81, F75, F79, and F81	<a href="#">LA7F902</a>

These clear plastic protective shrouds are an effective means to meet international finger-safe requirements for power terminals. They are designed to be used with power cables that have been bolted to the terminal.

**NOTE:** Protection shrouds do not attach to contactors/overloads using DZ2F lug kits.

Table 18.70: Power Terminal Protection Shrouds, Single-Pole

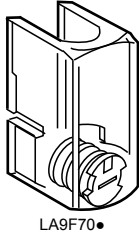

For use with relays	Catalog Number
LR9F5•57, F57	<a href="#">LA9F701</a>
LR9F5•63, F5•67, F5•69, F63, F67, F69	<a href="#">LA9F702</a>
LR9F5•71, F71	<a href="#">LA9F705</a>
LR9F7•75, F7•79, F7•81, F75, F79, F81	<a href="#">LA9F703</a>

Table 18.71: Power Terminal Protection Shrouds, 3-Pole



For use with relays	Catalog Number
LR9F5•57, F5•63, F5•67, F5•69, F57, F63, F67, F69	<a href="#">LA7F701</a>
LR9F5•71, F71	<a href="#">LA7F702</a>
LR9F7•75, F7•79, F7•81, F75, F79, F81	<a href="#">LA7F703</a>

Table 18.72: Connection Accessories (for Mounting Overload Relays Beneath Reversing Contactors)<sup>[4]</sup>

Application		Set of 3 Busbars Catalog Number
For relays	For contactor	
LR9F5•71, F71	LC1F185	<a href="#">LA7F407</a>
LR9F5•71, F71	LC1F225 and F265	<a href="#">LA7F403</a>
LR9F7•75, F5•79, F75, F79	LC1F225 to F400	<a href="#">LA7F404</a>
LR9F7•81, F81	LC1F400	<a href="#">LA7F404</a>
LR9F7•81, F81	LC1F630 and F800	<a href="#">LA7F406</a>

TeSys D dimensions: [page 18-50](#) and [page 18-52](#)  
 TeSys F dimensions: [page 18-45](#), [page 18-54](#)

[4] Mounting plate required.

### TeSys™ U Motor Starter

The TeSys U motor starter is integrated, making it simple to choose and install. It consists of a control unit snapped in a power base. TeSys U can be configured to fit specific applications as well. Optional accessories include a reverser, a current limiter, predictive maintenance options, and communication options. For detailed information about TeSys U, visit our website.

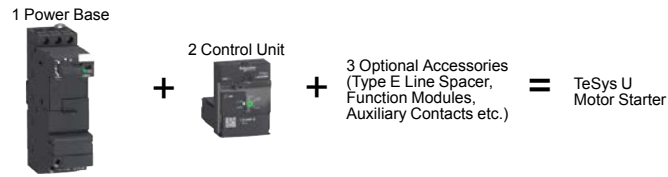

### Selecting TeSys U Motor Starters in Three Steps

**Table 18.73: Step 1. Select Power Base (Only two different bases up to 32 A)**



Control Connection	Max. Current (A)	Maximum Horsepower Ratings						Self-Protected Starter Base
		Three-Phase			Single-Phase			
		200 V	230 V	460 V	575 V	115 V	230 V	Catalog Number
With non-removable screw terminations	12	3	3	7.5	10	0.5	2	LUB12
	32	10	10	20	25	2	5	LUB32
Without screw terminations	12	3	3	7.5	10	0.5	2	LUB120 [1]
	32	10	10	20	25	2	5	LUB320 [1]

**Table 18.74: Step 2. Select Control Unit [2]**

Setting Range (A)	Standard 3-phase Class 10 trip [3]	Advanced 3-phase Class 10 trip [3]	Advanced single-phase Class 10 trip [3]	Advanced 3-phase Class 20 trip [3]
0.15–0.6	LUCAX6●●	LUCBX6●●	LUCX6●●	LUCDX6●●
0.3–1.4	LUCA1X●●	LUCB1X●●	LUCX1X●●	LUCD1X●●
1.25–5.0	LUCA05●●	LUCB05●●	LUCX05●●	LUCD05●●
3–12	LUCA12●●	LUCB12●●	LUCX12●●	LUCD12●●
4.5–18	LUCA18●●	LUCB18●●	LUCX18●●	LUCD18●●
8–32	LUCA32●●	LUCB32●●	LUCX32●●	LUCD32●●

**Table 18.75: Voltage Codes**

Volts	24	110–240
DC	BL [4]	—
AC	B	—
DC or AC	—	FU

**Table 18.76: Step 3. Select Auxiliary Contacts (optional)**

Terminals	Contact Indicates	Contact Normal Status	Contact State for Each Mode [5]							Catalog Number
			Off	Ready	Run	Short Circuit Trip	Overload Trip (Manual Reset)	Overload Trip (Remote/Auto Reset) [6]		
<b>Auxiliary Contact Blocks</b>										
Screw	Ready condition	N.O.	O	I	I	O	O	I		LUA1C11
	Fault condition	N.C.	I	I	I	O	O	I		
Screw	Ready condition	N.O.	O	I	I	O	O	I		LUA1C20
	Fault condition	N.O.	O	O	O	I	I	O		
<b>Auxiliary Contact Function Modules</b>										
Screw	Pole state	2 N.O.	O	O	I	O	O			LUFN20
Screw	Pole state	1 N.O. and 1 N.C.	O   I	O   I	I   O	O   I	O   I			LUFN11
Screw	Pole state	2 N.C.	1	I	O	I	I			LUFN02

**Table 18.77: Accessories**

Accessory	Quick Description	For details & selection, see:
Current limiter	Increases the breaking capacity to 130 kA @ 460 V and to 65 kA @ 575 V	page 18-27
Reverser	Stacked or side mounted (LU6MB0●●● only)	page 18-27
Line phase barrier	Required for use as a self-protected combination starter (UL 508 Type E)	page 18-27
Multifunction control unit	Has functions for monitoring and predictive maintenance	page 18-27
Function modules	Fault differentiation, thermal overload, motor load indication	page 18-27
Communication modules	Integrates into existing networks, major protocols are available	page 18-28
Soft starter + TeSys U	Use Altistart U01soft starter with TeSys U	page 18-39
Powerbus	Use TeSys U with a prewired system	page 18-28
Configuration and connection accessories	SoMove software, bus bar, external handle	page 18-28

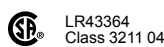
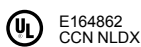

Accessories: page 18-26 to page 18-28  
Dimensions: page 18-57  
Overload Relays: page 18-9  
Accessories: page 18-15  
Dimensions: page 18-56

[1] For use with reversing modules or communication modules with prewired connector.  
[2] The control unit contains solid-state overload relay and control power source for TeSys U. For more details on the different control units, their functions, and placement on the power base, see page 18-26.  
[3] Complete the catalog number by adding appropriate code from Table 18.75 (for example, LUCAX6FU).  
[4] DC voltage with range of 0.90 to 1.10 of nominal.  
[5] I indicates closed contact; O indicates open contact.  
[6] Requires multifunction or advanced control unit plus fault differentiation module LUFDA10.

Control Units and Functions

Table 18.78: Control Units and Functions

Reference	Standard LUCA	LUCB	Advanced LUCC	LUCD	Multifunction LUCM
<b>Protection type</b>					
Class 10					
Class 20					
Class 5-30					
Single Phase: LUCC Class 10 only					
<b>Protection functions</b>					
Short circuit					
Over current					
Thermal overload					
Phase loss					
Phase imbalance					
Ground fault					
Underload, long start, jam					
<b>Control functions</b>					
Manual reset					
Automatic or local/remote reset					
Fault differentiation					
Thermal alarm					
Motor load display					
Fault history					
Alarm threshold adjustment					
Tripping test					

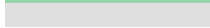
 = built-in the control unit  
 = works with the related function modules (see page 18-27)

Power Base and Plug-in Accessories

See below where to install accessories on the power base. Only one accessory can be installed in each location.

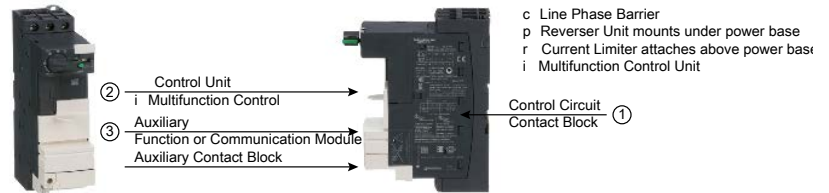

## TeSys™ Reversing Starters

Table 18.79: Power Base with Reversing Unit assembled under the base

Control Connection	Max. Current (A)	Maximum Horsepower Ratings						Self-Protected Starter Base Catalog Number
		Three-Phase			Single-Phase			
		200 V	230 V	460 V	575 V	115 V	230 V	
With screw terminations	12	3	3	7.5	10	1.5	2	LU2B12 [7]
	32	10	10	20	25	2	5	LU2B32[7]



Line Phase Barrier



Reverser Unit Assembled under the Power Base

Table 18.80: Select Control Unit Options [8][9]

Setting Range (A)	Standard Three-Phase Class 10 trip [10]	Advanced Three-Phase Class 10 trip [10]	Advanced Single-Phase Class 10 trip [10]	Advanced Three-Phase Class 20 trip [10]
0.15–0.6	LUCAX6●●	LUCBX6●●	LUCCX6●●	LUCDX6●●
0.3–1.4	LUCA1X●●	LUCB1X●●	LUCC1X●●	LUCD1X●●
1.25–5.0	LUCA05●●	LUCB05●●	LUCC05●●	LUCD05●●
3–12	LUCA12●●	LUCB12●●	LUCC12●●	LUCD12●●
4.5–18	LUCA18●●	LUCB18●●	LUCC18●●	LUCD18●●
8–32	LUCA32●●	LUCB32●●	LUCC32●●	LUCD32●●

Table 18.81: Voltage Codes

Volts	24	110–240
DC	BL [11][12]	—
AC	B	—
DC or AC	—	FU

Table 18.82: Reversing Modules for Field Addition

Mounting	Catalog No.	Wiring Adapter	
Beneath	LU2MB0	LU9MR1C	Note: For LU2MB0 and LU6MB0, voltage code required; must match control unit.
Beside	LU6MB0	LU9MR1	

## TeSys™ U Accessories

Table 18.83: Current Limiter [13][14]

Accessory	Application	Technical Data	Mounting	Cat. No.
Current limiter/isolator	Additional current limiting aspects for the starter	130 kA at 460 V 65 kA at 575 V	Direct mounting to LUB● and LU2B●	LUALB1
Limiter cartridge	Replacement cartridge for LUALB1	130 kA at 460 V 65 kA at 575 V	—	LUALF1

Table 18.84: Function Modules [13][15]

Module	Description	For use with:	Operation Requirements	Catalog Number
<b>Fault differentiation:</b> with manual reset (thermal overload) with auto reset	Provides indication between an overload trip and a short circuit trip.	Advanced control units only	24–250 Vac/Vdc (power from control unit)	LUFDA10
Thermal overload pre-alarm	Signals when the motor current reaches 1.05 of the full load setting on the control unit.	Advanced control units only	24–250 Vac/Vdc (power from control unit)	LUFW10
Motor load indication	Provides a signal proportional to the average currents in the three phases divided by the full load current setting of the control unit. The output corresponds to a load status of 0–2 times the full load setting of the control unit.	Advanced or multi-function control units	4–20 mA (requires separate 24 Vdc power supply)	LUFV2
Parallel wiring	Provides a convenient way to reduce control wiring and allow for connecting starters to a communications network by providing 24 Vdc for the starters.	Advanced or multi-function control units (24 Vdc only) and LU9BN11C or LU9MRC prewired connector	LU9G02 splitter box and PLC network	LUFC00



Alarm Differentiation



Parallel Wiring



Motor Load Indicator

[7] Voltage code required.

[8] The control unit contains solid-state overload relay and control power source for TeSys U. For more details on the different control units, their functions, and placement on the power base see page 18-26.

[9] Control units for 4.5–18 and 8–32 can be used **only** with 32 A rated power bases (LUB32, LUB320, and LU2B32).

[10] Complete the catalog number by adding the appropriate code from (for example LUCAX6FU).

[11] DC voltage with range of 0.90 to 1.10 of nominal.

[12] Voltage code to use for a power base with a communication module.

[13] See page 18-26 for placement on the power base.

[14] Increases the breaking capacity of the motor starter.

[15] Offers customization for specific application requirements.

Accessories

Table 18.85: Communication Modules [16][17]

Communication modules allow the TeSys U starter to be connected directly to the network. They are for use with advanced or multi-function control units (24 Vdc only) and require a separate 24 Vdc power supply.



Module	Prewired Connector	Catalog Number
Modbus™ Communication	LU9BN11C or LU9MRC	LULC033
CANopen Communication	LU9BN11L or LU9MRL	LULC08
Profibus Communication	LU9BN11L or LU9MRL	LULC07
DeviceNet™ Communication	LU9BN11L or LU9MRL	LULC09

Table 18.86: TeSys U Cabling Accessories—Power Bus Bars

Description	Application	Pitch	Standard Pack	Catalog Number
3-Pole, 63 A Bus Bar	For feeding 2 TeSys U controllers	45	1	GV2G245
		54	1	GV2G254
		72	1	GV2G272
	For feeding 3 TeSys U controllers	45	1	GV2G345
		54	1	GV2G354
	For feeding 4 TeSys U controllers	45	1	GV2G445
		54	1	GV2G454
		72	1	GV2G472
	For feeding 5 TeSys U controllers	54	1	GV2G554
	Terminal blocks	Top feed for use with bus bars	—	1

Table 18.87: Control Circuit Accessories [16]

Accessory	Application	Technical Data	Mounting	Catalog Number
Control circuit contact block	Switches control circuit power via LUB● handle (NEC430-74 compliance)	5 A at 600 Vac 5 A at 250 Vdc	Side mounting to LUB● and LU2B● only	LUA8E20
Through-the-door operating mechanism (without trip indication)	Use to enclose TeSys LUB● only.	NEMA 1, 12, 3R, 4, 4X Red/Yellow	Kit	LU9APN44
Control circuit filters	Use with electronic or triac output controllers	Up to 150 Vac max.	Directly to coil terminals	Non-reversing LUA4F11 Reversing LUA4F12
Pre-wired connector	Central control when using communication modules	See Table 18.85 for usage.	Lower power terminals to communication module.	Non-reversing LU9BN11C LU9BN11L Reversing LU9MRL

[16] See page 18-26 for placement on the power base.

[17] Communication capabilities can be integrated into existing automation architecture via a variety of protocols.

### TeSys H™ Ultra Compact Starters

TeSys H ultra compact motor starters are extremely compact motor starters for asynchronous motors (AC53a utilization category) and resistive loads (AC51 utilization category). With up to 75% space savings, the 22.5 mm wide starter maintains that width even for a reversing starter! An available safety version features embedded Safe Torque Off and is SIL3 according to IEC 61508-1 and Ple according to ISO 13849-1. TeSys H is ideal for industries such as food and beverage, logistics, and durable goods. For selection, see Catalog [MKTED210011EN](#). Check with local sales office for availability.



TeSys H™ Ultra Compact Starter

TeSys™ GV Family

The TeSys GV family of products provide efficient motor control and protection solutions up to 520 amps. There are a variety of UL approved applications that enable specified configurations for use as a manual starter, motor disconnect, independent branch short-circuit protection, motor overload protection, or for use with a motor controller such as a contactor to build a complete motor control circuit. Certain configurations are approved for group motor applications as well. Refer to the following selection tables for application information, as well as the Motor Control Solutions for the North American Market data bulletin (8536DB0901) for additional information.

The TeSys GV2P (up to 32 amps) and GV3P (up to 65 amps) is rated to UL 60947-4-1 as a motor starter, and also possess Type E ratings for manual switching applications. These devices can be combined with a specified TeSys D contactor as a Type F combination motor controller (with specified line side spacer/accessories), with SCCR up to 100kA.

The TeSys GV2ME (up to 32 amps) combined with a specified TeSys D contactor is ideal for group motor applications.

The TeSys island load management starters are approved for use with TeSys GV2P and GV3P devices as a group motor arrangement. See selection table for application specifics.

The TeSys GV4PB, GV5PB, and GV6PB are motor protective circuit breakers rated to UL 489, are approved as branch circuit protection (no line side spacer required) and include motor overload protection. A full motor branch circuit is completed with the addition of a contactor, providing a compact two-component solution up to 520 motor full load amps. Pre-trip alarm accessories can be applied to these units to help anticipate and resolve issues, minimizing operator or maintenance interaction.



GV2P



GV4PB

Table 18.88: GV2, GV3 Manual Motor Protectors (UL 60947-4-1)

	Thermal Setting (A)	Maximum Horsepower Ratings								GV2ME push button <sup>[18]</sup>	GV2/3P rotary handle		
		Single-Phase			Three-Phase							Catalog Number	Catalog Number
		115 V	200 V	230 V	115 V	200 V	230 V	460 V	575 V				
	0.10–0.16	—	—	—	—	—	—	—	—	—	GV2ME01	GV2P01	
	0.16–0.25	—	—	—	—	—	—	—	—	—	GV2ME02	GV2P02	
	0.25–0.40	—	—	—	—	—	—	—	—	—	GV2ME03	GV2P03	
	0.40–0.63	—	—	—	—	—	—	—	—	—	GV2ME04	GV2P04	
	0.63–1	—	—	—	—	—	—	—	—	1/2	GV2ME05	GV2P05	
	1–1.6	—	—	1/10	—	—	—	3/4	3/4	—	GV2ME06	GV2P06	
	1.6–2.5	—	1/6	1/6	—	1/2	1/2	1	1.5	—	GV2ME07	GV2P07	
	2.5–4	1/8	1/4	1/3	—	3/4	3/4	2	3	—	GV2ME08	GV2P08	
	4–6.3	1/4	1/2	1/2	3/4	1	1.5	3	5	—	GV2ME10	GV2P10	
	6–10	1/2	1	1.5	1	2	3	5	7.5	—	GV2ME14	GV2P14	
9–14	3/4	2	2	2	3	3	10	10	—	GV2ME16	GV2P16		
13–18	1	2	3	2	5	5	10	15	—	GV2ME20	GV2P20		
17–23	1.5	3	3	3	5	7.5	15	20	—	GV2ME21	GV2P21		
20–25	2	—	—	—	7.5	7.5	15	20	—	GV2ME22	GV2P22		
24–32	2	5	5	5	7.5	10	20	25	—	GV2ME32	GV2P32		
9–13	1/2	—	1.5	—	3	3	7.5	10	—	—	GV3P13		
12–18	3/4	—	2	—	3	5	7.5	10	—	—	GV3P18		
17–25	1.5	—	3	—	5	7.5	15	20	—	—	GV3P25		
23–32	2	—	3	—	7.5	7.5	20	25	—	—	GV3P32		
30–40	3	—	5	—	10	10	25	30	—	—	GV3P40		
37–50	3	—	7.5	—	10	10	30	40	—	—	GV3P50		
48–65	3	—	10	—	15	15	40	50	—	—	GV3P65		
													

[18] For spring terminals add 3 to the catalog number (for example, GV2ME013). GV2ME013 is not available with spring terminals. For ring terminals, add 6.





GV4PB



GV5PB



GV2P10 with LC1D09

Table 18.89: GV4, GV5, GV6 UL 489 Motor Protective Circuit Breakers

Motor FLA Dial Range	Interrupting Rating: 240 V ... 35 kA 480Y/277 V ... 18 kA 600Y/347 V ... 14 kA	Interrupting Rating: 240 V ... 65 kA 480Y/277 V ... 35 kA 600Y/347 V ... 18 kA	Interrupting Rating: 240 V ... 100 kA 480Y/277 V ... 65 kA 600Y/347 V ... 25 kA
0.8 ... 2	—	GV4PB02N	GV4PB02S
1.4 ... 3.5	—	GV4PB03N	GV4PB03S
2.9 ... 7	—	GV4PB07N	GV4PB07S
5 ... 12.5	—	GV4PB12N	GV4PB12S
10 ... 25	GV4PB25B	GV4PB25N	GV4PB25S
20 ... 50	GV4PB50B	GV4PB50N	GV4PB50S
40 ... 80	GV4PB80B	GV4PB80N	GV4PB80S
65 ... 115	GV4PB115B	GV4PB115N	GV4PB115S
58 ... 130	—	GV5PB150N	GV5PB150S
114 ... 217	—	GV5PB250N	GV5PB250S
190 ... 348	—	GV6PB400N	G65PB400S
312 ... 520	—	GV6PB600N	G65PB600S

GV2P + LC1D Pre-Assembled Kits

Simplify your life! These new **pre-assembled kits** come with a GV2P manual motor protector already connected to an LC1D contactor. Panel builders and end users can now save wiring time by purchasing the pre-assembled kits.

Table 18.90: Pre-Assembled Kits <sup>New!</sup>

Components (includes GV2AF3)	UL File E134347 SCCR Type F 480Y/277V		Group Motor Rating UL File E89451 SCCR 480 V	Kit Part No. [19]
	With GV2GH7 or GV1G09 Line Side Adapter	With GV1G09 Line Side Adapter and GV2G Busbar		
GV2P02 + LC1D09G7	100 kA	100 kA	22 kA	GV2P02KD09
GV2P03 + LC1D09G7	100 kA	100 kA	22 kA	GV2P03KD09
GV2P04 + LC1D09G7	100 kA	100 kA	22 kA	GV2P04KD09
GV2P05 + LC1D09G7	100 kA	100 kA	22 kA	GV2P05KD09
GV2P06 + LC1D09G7	100 kA	100 kA	22 kA	GV2P06KD09
GV2P07 + LC1D09G7	100 kA	100 kA	22 kA	GV2P07KD09
GV2P08 + LC1D09G7	100 kA	100 kA	22 kA	GV2P08KD09
GV2P10 + LC1D09G7	100 kA	100 kA	22 kA	GV2P10KD09
GV2P14 + LC1D09G7	100 kA	100 kA	22 kA	GV2P14KD09
GV2P16 + LC1D25G7	50 kA	42 kA	22 kA	GV2P16KD25
GV2P20 + LC1D25G7	50 kA	42 kA	22 kA	GV2P20KD25
GV2P21 + LC1D25G7	50 kA	42 kA	22 kA	GV2P21KD25
GV2P22 + LC1D25G7	50 kA	42 kA	22 kA	GV2P22KD25

Coil Voltage Suffix	
120 Vac	G7
24 Vac	B7
24 Vdc Low Consumption	BL

[19] Complete the catalog number with the coil voltage suffix (for example GV2P16KD25G7).

**TeSys BV4 Motor Circuit Protection Selection**

Providing UL508 type D combination ratings in accordance to current NEC installation requirements, the TeSys BV4 motor circuit protector allows for compact motor protection in conjunction with both the TeSys and Square D NEMA product families for motor control. The BV4 is a magnetic only, UL489 Listed circuit protector rated up to 100kA short-circuit protect with adjustable instantaneous trip points and can be installed directly to a panel or standard DIN rail.

Motor Circuit Protectors must be applied per a listed combination motor controller rating as required by NEC and UL 508A. See [UL.com/SCCR](http://UL.com/SCCR) for combination ratings or contact local support for a tested combination appendix.



**Table 18.91: TeSys BV4 Motor Circuit Breaker Selection**

Frame	MCP Ampacity (In)	Adjustable Instantaneous Trip (Ii)	Protection Level	
			Standard Fault Cat. No.	High Fault Cat. No.
BV4	2	12-28	BV4T002D	BV4T002J
	3.5	21-49	BV4T003D	BV4T003J
	7	42-98	BV4T007D	BV4T007J
	13	53-195	BV4T013D	BV4T013J
	25	110-360	BV4T025D	BV4T025J
	50	176-650	BV4T050D	BV4T050J
	80	320-1150	BV4T080D	BV4T080J
	115	600-1150	BV4T115D	BV4T115J

**TeSys™ GV2 Accessories and Enclosures**

**Table 18.92: Mounting Accessories for GV2 + LC1 D09 to D38<sup>[20]</sup>**

	Mount GV Directly on Single DIN Rail	Mount on Single DIN Rail (Using Mounting Hardware)	Mount GV and LC1D Contactor on Independent DIN Rails	Mount on 2 DIN Rails (Using Mounting Hardware)
Electrical Interconnect	GV2AF3	GK2AF01	GV1G02	GV2AF4
Mounting Hardware	—		—	LAD311

**Table 18.93: Mounting Accessories for GV2<sup>[20]</sup>**

Description	Application	Standard Pack <sup>[21]</sup>	Catalog Number
Adapter plate	For screw mounting of GV2M	10	GV2AF02
7.5 mm compensation plate	To allow mounting of GV2M and GV2P on a common bus bar	10	GV1F03

**Table 18.94: Bus Bar Accessories for GV2**

Description	Application	Pitch	Catalog Number
Incoming Terminal	Type E line spacer, for use with or without GV2G busbars	—	GV1G09
	Type E line spacer, not for use with or with GV2G busbars	—	GV2GH7
	Bottom Feed, for use with GV1L3 current limiter	—	GV1G05
3-Pole, 63 A Bus Bar	For feeding 2 GV2 starters	45	GV2G245
		54	GV2G254
		72	GV2G272
	For feeding 3 GV2 starters	45	GV2G345
		54	GV2G354
	For feeding 4 GV2 starters	45	GV2G445
		54	GV2G454
For feeding 5 GV2 starters	72	GV2G472	
Protective Cover	To cover unused bus bar outlets	—	GV1G10 <sup>[22]</sup>

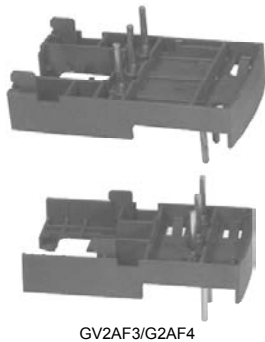

GV2AF3/GV2AF4

[20] Must order in multiples of 10.

[21] Orders must specify multiples of quantities listed.

[22] Must order in multiples of 5.

**Table 18.95: GV2 Other Accessories**

Description	Application	Standard Pack [23]	Catalog Number
Current limiter—GV2	Increases interrupt capacity when attached to GV2ME or GV2P	1	GV1L3
Through-the-door operating mechanism kits	NEMA 1, 12, Black with trip indication, for use with GV2P	1	GV2APN01
	NEMA 1, 12, Red/Yellow with trip indication, for use with GV2P	1	GV2APN02
	NEMA 3R, 4, 4X, Red/Yellow without trip indication, for use with GV2P	1	GV2APN04
Angle bracket	Operating mechanism support shaft for deep enclosures (≥ 250 mm), for use with GV2P	1	GVAPK11
Operating mechanism short shaft	One-piece short shaft for installing operating mechanisms in shallow enclosures, for use with GV2P, GV3P and TeSys U	1	GVAPA2
Laser tool	Laser tool for installing through-the-door kits	1	GVAPL01

**Table 18.96: GV2 Enclosures**

Description	Listing	Mounting	Enclosure Rating	Max. Side Mounting Aux. Contacts		Catalog Number
				Left Side	Right Side	
Enclosures for GV2ME with or without accessories	CSA Listed. Not UL Listed.	Surface mounting	NEMA 1, IP41	1	1	GV2MC01
			NEMA 12/4, IP55	1	1	GV2MC02
		Flush mounting	NEMA 1, IP41	1	1	GV2MP01
			NEMA 12/4, IP55	1	1	GV2MP02
		Flush mounting, front face reduced	NEMA 1, IP41	0	1	GV2MP03
			NEMA 12/4, IP55	0	1	GV2MP04

**Table 18.97: GV2 Enclosures Accessories**

Description	Type	Standard Pack [23]	Catalog Number	
Padlocking device for GV2M (when padlocked, starter is automatically in Off position)	—	1	GV2V01	
Mushroom head stop push button (40 mm, red) [24]	Spring return	1	GV2K011	
	Latching	Turn to Release	1	GV2K031
	Latching / Padlockable Turn to Release		1	GV2K04
Sealing kit	For enclosures GV2MC01 and GV2MP01	10	GV2E01	

[23] Orders must specify multiples of quantities listed.

[24] Supplied with IP55 sealing kit.

Voltage Trips

Table 18.98: Voltage Trips



GVAU116

Only one trip or fault signaling contact can be installed per GV2/GV3 device.				
Description	Characteristics	Voltage	Frequency	Cat. No. [25]
Voltage trips GV2 or GV3P	Undervoltage or Shunt trip (external mounting, 1 block right side only)	110–115 V	60 Hz	GVA●116
		220–240 V	60 Hz	GVA●226

Table 18.99: Voltage Trips—Technical Data (GV2AU, GV2AS)

Rated Voltage—660 Vac					
Model	Inrush	Sealed	Pick-Up Voltage	Drop-Out Voltage	Operating Time [26]
GVAU	12 VA / 8 W	3.5 VA / 1.1 W	0.8–1.1	0.35–0.7	10–15 ms
GVAS	14 VA / 10.5 W	5 VA / 1.6 W	0.7–1.1	0.2–0.75	10–15 ms

Table 18.100: Auxiliary Contact Blocks [27]



GVAE11

Description	Mounting Location	Max. No. of Blocks	Contact Type	Sold in lots of	Cat. No.
Instantaneous auxiliary contacts GV2 or GV3P	Front [28][29]	1	N.O. or N.C. [30]	1	GVAE1
			N.O. + N.C.	10	GVAE11
			N.O. + N.O.	1	GVAE20
	Left Hand Side	2	N.O. + N.C.	1	GVAN11
			N.O. + N.O.	1	GVAN20
Fault signaling contact + instantaneous auxiliary contact GV2 or GV3P	Left Hand Side [31]	1	N.O. (fault) + N.O.	1	GVAD1010
			N.O. (fault) + N.C.	1	GVAD1001
			N.C. (fault) + N.O.	1	GVAD0110
			N.C. (fault) + N.C.	1	GVAD0101
Short circuit signaling contact GV2 or GV3P	Left Hand Side	1	SPDT	1	GVAM11

Table 18.101: GV3P Accessories

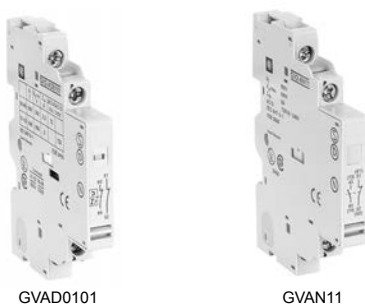

GVAD0101

GVAN11

Accessory	Application / Use With	Standard Pack	Cat. No.
Through-the-door operating mechanism kits	NEMA 1, 12, Black with trip indication, for use with GV3P	1	GV3APN01
	NEMA 1, 12, Red/Yellow, with trip indication, for use with GV3P	1	GV3APN02
	NEMA 3R, 4, 4X Red/Yellow without trip indication, for use with GV3P	1	GV3APN04
Angle bracket	Operating mechanism support shaft for deep enclosures (≥ 300 mm), for use with GV3P	1	GVAPK12
3-pole, 115 A busbar	For feeding 2 GV3P starters, 64 mm pitch	1	GV3G264
	For feeding 3 GV3P starters, 64 mm pitch	1	GV3G364
Incoming line spacer	Line spacer for GV3P when used in UL 508 Type E applications. One spacer required on line side.	1	GV3G66
IP 20 cover	IP20 protective cover for ring tongue versions of GV3P and 3-pole TeSys D Everlink contactors. Two covers required for line and load side.	1	LAD96570
Padlocking device	For use with up to 4 padlocks (not supplied), Ø 6 mm shank maximum	1	GV2V03
Operating mechanism short shaft	One-piece short shaft for installing operating mechanisms in shallow enclosures, for use with GV2P, GV3P and TeSys U	1	GVAPA2
Laser tool	Laser tool for installing through-the-door kits	1	GVAPL01
S-shaped busbar	For connecting GV3P starters and LC1D40A-65A contactors side by side without intrawiring	1	GV3S

[25] To order an undervoltage trip: replace the bullet (●) with a U (for example, GVAU025).

To order a shunt trip: replace the bullet (●) with an S (for example, GVAS025).

[26] From the loss of voltage at the trip terminals to the opening of the starter contacts.

[27] One trip or one fault signaling can be fitted per GV3.

[28] Cannot be used with GV2GH7 insulator.

[29] Mounting of a GVAE contact block or a GV2AK00 visible isolation block on GV2P.

[30] Choice of N.C. or N.O. contact operation, depending on which way the reversible block is mounted.

[31] The GVAD is always mounted next to the starter.

**Common Accessories for BV4, GV4, GV5 and GV6**

Common Accessories		BV4 Reference	GV4 Reference	GV5 Reference	GV6 Reference	
<b>Auxiliary contacts OF or SD</b>						
Open/Closed Status		GV4AE11	GV4AE11	GV7AE11	GV7AE11	
Trip Alarm		—	—	—	—	
Open/Closed Status — Low Level		—	—	GV7AB11	GV7AB11	
<b>Fault signalization modules</b>						
<p>For <b>GV4PB</b>, SDx module mounts externally on the right side, and provides pre-trip alarm and fault signalization</p> <ul style="list-style-type: none"> <li>SDT95% overload alarm: thermal image of the motor is greater than 95 % of the permissible temperature rise.</li> <li>SDTxxs overload alarm: circuit breaker will trip in xx seconds with the same load. xx is adjustable between 10 to 40 seconds (default 20 seconds) on the circuit breaker itself through NFC or a computer with EcoStruxure Power Commission software and an interface module (TRV00911).</li> <li>SDTAM overload alarm just before tripping: in the event of a phase unbalance, overload, or on a jam fault, this output is activated to open the contactor and avoid circuit breaker tripping. In that case, contact can be manually or automatically reseted after an adjustable cooling time from 1 to 15 minutes. If after a 400 ms delay the motor is not stopped, the circuit breaker will trip.</li> <li>SDT overload trip indication: circuit breaker has tripped due to an overload fault.</li> <li>SDJAM jam trip indication: circuit breaker has tripped due to a jam fault.</li> <li>SDUNB phase unbalance trip indication: circuit breaker has tripped due to an unbalance fault.</li> <li>SDLS long start trip indication: circuit breaker has tripped due to a long start fault.</li> <li>SDGF ground-fault trip indication: circuit breaker has tripped due to a ground-fault.</li> </ul> <p>For <b>GV5PB &amp; GV6PB</b>, SDx module mounts internally, and includes a pre-trip contact (400 ms prior to trip) that can be use to open the contactor, as well as a contact that indicates overload trip of the circuit-breaker.</p>		—	GV4ADM1111	LV429424 (1)	LV429424 (1)	
<b>Instantaneous voltage release</b>						
Undervoltage Release (Mn)	24 V 50/60 Hz	GV4AU027	GV4AU027	S29404	S29404	
	24 Vdc	—	—	—	—	
	48 V 50/60 Hz–48 Vdc	GV4AU057	GV4AU057	GV7AU055	GV7AU055	
	110–130 V 50/60 Hz–125 Vdc	GV4AU137	GV4AU137	GV7AU107	GV7AU107	
	208–240 V 50/60 Hz	GV4AU247	GV4AU247	GV7AU207	GV7AU207	
	277 V 60 Hz	GV4AU286	GV4AU286	—	—	
	380–415 V 50 Hz	GV4AU415	GV4AU415	GV7AU387	GV7AU387	
	440–480 V 60 Hz	GV4AU486	GV4AU486	—	—	
	525–600 V 60 Hz	—	—	S29409	S29409	
	Shunt Trip (Mx)	24 V 50/60 Hz	GV4AS027	GV4AS027	S29384	S29384
24 Vdc		—	—	—	—	
48 V 50/60 Hz–48 Vdc		GV4AS057	GV4AS057	GV7AS055	GV7AS055	
110–130 V 50/60 Hz–125 Vdc		GV4AS137	GV4AS137	GV7AS107	GV7AS107	
208–240 V 50/60 Hz		GV4AS287	GV4AS287	GV7AS207	GV7AS207	
277 V 60 Hz		—	—	—	—	
380–415 V 50 Hz–440–480 V 60 Hz		GV4AS487	GV4AS487	GV7AS387	GV7AS387	
525–600 V 60 Hz		—	—	S29389	S29389	
<b>Rotary handles</b>						
Direct		With black handle on black font	GV4ADN01	GV4ADN01	GV5AP03	GV6AP03
	With red handle on yellow font	GV4ADN02	GV4ADN02	GV7AP04	LV432599	
Front extended IP54	With black handle on black font	GV4APN01	GV4APN01	GV7AP01 (2)	LV432598 (2)	
	With red handle on yellow font	GV4APN02	GV4APN02	GV7AP02 (2)	LV432600 (2)	
Front extended IP65	With red handle on yellow font	GV4APN04	GV4APN04	—	—	
Lateral	With black handle on black font	LV426935	LV426935	—	—	
	With red handle on yellow font	LV426936	LV426936	—	—	
Open door shaft operator		LV426937	LV426937	—	—	
Laser alignment tool to aid in aligning hole on door with rotary mechanism		GVAPL01	GVAPL01	GVAPL01	GVAPL01	

Additional BV4 and GV4 Accessories

Accessory	BV4 Reference	GV4 Reference
<b>Cabling Accessories</b>		
EverLink Connector (replacement)	LAD96565	LAD96565
Large Spacing Cover for EverLink Connector (replacement)	GV4G66	—
Crimp Lug Connector + Screws	GV4LUG	GV4LUG
Transparent Terminal Shield for Crimped Lug Connector	LAD96590	LAD96590
Interphase Barriers	LV426920	LV426920
One Time Torque Limiters, Green—9 N.m (set of 6)	LV426990	LV426990
One Time Torque Limiters, Yellow—5 N.m (set of 6)	LV426992	LV426992
<b>Locking Accessories</b>		
Removable Toggle Locking Device for 1 to 3 Padlocks	29370	—
Bag of 6 Leads + 6 Sealing Accessories	LV429375	—
<b>Programming Tools</b>		
Pocket Battery—Allows changes to settings on the GV4PB when not powered by the line voltage	—	LV434206
GV4PB cord for USB Maintenance Interface	—	TRV00917
EcoStruxure Power Commission app	—	Free download

Additional GV5 and GV6 Accessories

Accessory	GV5PB150.. Reference	GV5PB250.. Reference	GV6PB.. Reference	
<b>Cabling Accessories</b>				
Mechanical lug kit (set of 3)	14–10 AWG (2.5–6mm <sup>2</sup> )—Al/Cu	AL150HD	—	
	14–2/0 AWG (2.5–70mm <sup>2</sup> )—Cu	CU150HD1	—	
	4–4/0 AWG (25–95mm <sup>2</sup> )—Al/Cu	—	AL175JD	
	3/0–350 kcmil AWG (95–185mm <sup>2</sup> )—Al/Cu	—	AL250JD	
	1/0 AWG–300 kcmil (50–185mm <sup>2</sup> )—Al/Cu	—	CU250JD1	
	2 AWG–500 kcmil (35–240mm <sup>2</sup> )—Al	—	—	
	2 AWG–600 kcmil (35–300mm <sup>2</sup> )—Cu	—	—	AL400L61K3
	2 AWG–600 kcmil (35–300mm <sup>2</sup> )—Cu	—	—	CU400L61K3
	2/0 AWG–500 kcmil (70–240 mm <sup>2</sup> )—Al/Cu	—	—	AL600LS52K3
	2/0 AWG–500 kcmil (70–240mm <sup>2</sup> )—Cu	—	—	CU600LS52K3
	3/0 AWG–500 kcmil (95–240)—Al/Cu	—	—	AL600LF52K3
	3/0 AWG–500 kcmil (95–240)—Cu	—	—	CU600LF52K3
Terminal Nut Insert kit/Bus Bar Connections	1/4–20 Tap (set of 3)	S37444	S37445	
	M10 x 25 terminal screws and washers for one side (set of 4)	—	—	S36967
Terminal Shield	Short Terminal Shield	S37447	S37448	LTSS3P
	Medium Terminal Shield	—	—	LTSM3P
	Long Terminal Shield	—	—	LTSL3P
Phase Barriers	Phase Barriers (set of 6)	S29329	S29329	32570
<b>Locking &amp; Other Accessories</b>				
Door Lock	Removable Door lock (lock off only)	S29370	S29370	S29370
	Fixed Door lock (on or off)	S29371	S29371	S32631
Toggle Extension	Fixed (set of 5)	S29313	S29313	S432553

**Enclosed TeSys™ D Starters**

TeSys D enclosed full-voltage starters are available in Type 1 and Type 12/3R enclosures. The enclosed TeSys D offer accepts standard TeSys D accessories and all Insta-Kits control units and control power transformer kits. For additional sizes, combinations and accessory options, see Catalog **8100CT1901**. Check with local sales office for availability.



LE1D093A62OB70

**Table 18.102: Insta-Kits for Enclosed Full Voltage Non-Reversing Starters<sup>[32]</sup>**

Max. Horsepower Ratings						Auxiliary Contacts On Each Contactor		Current Rating of Contactor	Catalog Number <sup>[33]</sup>	
Single-Phase		Three-Phase				N.O.	N.C.		Type 1	Type 12/3R
120 V	240 V	208 V	230 V	460 V	575 V					
1/3	1	2	2	5	7.5	1	1	9	LE1D093A62O****	LE1D093A72O****
1/2	2	3	3	7.5	10	1	1	12	LE1D123A62O****	LE1D123A72O****
1	3	5	5	10	15	1	1	18	LE1D183A62O****	LE1D183A72O****
2	3	5	7.5	15	20	1	1	25	LE1D253A62O****	LE1D253A72O****
2	5	7.5	10	20	25	1	1	32	LE1D323A62O****	LE1D323A72O****
3	5	10	10	30	30	1	1	40	LE1D403A62O****	LE1D403A72O****
3	7.5	15	15	40	40	1	1	50	LE1D503A62O****	LE1D503A72O****
5	10	20	20	40	50	1	1	65	LE1D653A62O****	LE1D653A72O****

**Table 18.103: Voltage Codes for Enclosed Starters**

Primary Voltage	120	208	240
Code	G7	L7	U7

TeSys D dimensions: [page 18-55](#)

**Insta-Kits Selection**

With the use of Insta-Kits, only one operator scheme is allowed. For additional accessory kits and options, see Catalog **8100CT1901**. Check with local sales office for availability.

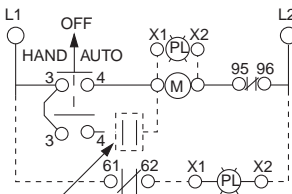
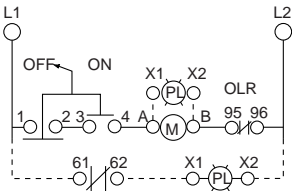
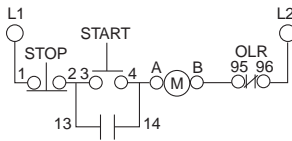

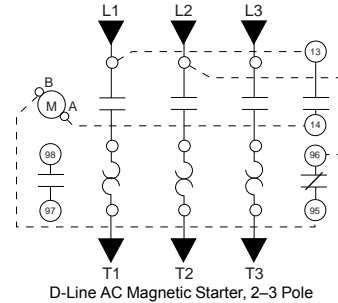

Remote by Customer Connection  
From top to bottom: Start/Stop, On - Off Selector Switch, HOA Selector Switch



<sup>[32]</sup> See Table 18.25 TeSys D Overload Relays—Ambient Compensated, Bimetallic, Direct Mounting, page 18-12 for field installable overload relays.

<sup>[33]</sup> To obtain a single phase non-reversing starter, change prefix LE1 to LES. (e.g., LE1D093A62O\*\*\*\* becomes LESD093A62O\*\*\*\*). Price remains unchanged.

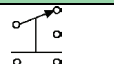
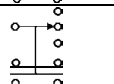
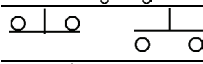
Table 18.104: Insta-Kit Accessories for Field Installation

Symbol	Description	Color	Nameplate	Suffix/Cat. No. [34]
				NEMA Type 1
<b>One operator on cover</b>				
	2 Position selector switch	Black	Off - On	LA9CA06DT
	3 Position selector switch	Black	Hand - Off - Auto	LA9CA06ET
	2 Push buttons	Green Red	Start Stop	LA9CA06GT
	3 Position selector switch, Pilot light (transformer type)	Black Red/Green	Hand - Off - Auto Power On	LA9CA06UT

TeSys™ LS1 Fuse Holders

- 45 mm wide (same dimensions as GV2ME)
- Mounts directly to LC1D09–D38 contactors (with use of GV2AF3 or GV2AF4)
- Meets application needs for fusible starter
- Uses GV2AE instantaneous contact blocks to open control circuits
- DIN rail mounted

Table 18.105: TeSys LS1 Fuse Holders

Description	Fuse Type	Dimensions		Catalog Number
		in.	mm	
Screw clamp terminals, 3-pole	CC, KTK-R	0.41 x 1.5	10.3 x 38	LS1D30



LS1D30

 E164862  
 CCN NLDX  
 LR43364  
 Class 3211 04  

[34] Catalog numbers beginning with LA9 are only for starters with a "2" before the voltage code. When using a factory option that does not have a corresponding customer kit, the 10th digit of the starter must change from a "2" to a "1".



**Altistart Drive and TeSys U Motor Starter**

**Table 18.106: Soft Start / Soft Stop Unit for 0.75 to 15 kW Motors (can be combined with the TeSys U starter)**

Motor		Starter	
Motor Power, hp <sup>[1]</sup>		Nominal Current, A	Catalog Number
230 V	460 V		
3-phase supply voltage: 200 to 480 V 50/60 Hz			
1	2	6	ATSU01N206LT
1.5	3		
2	5	9	ATSU01N209LT
3	7.5		
5	10	22	ATSU01N222LT
7.5	15		
10	20		

**Table 18.107: Accessories**

Description	Used for Starter	Catalog Number
Power connector between ATSU 01N2●●LT and TeSys U	ATSU01N2●●T	VW3G4104

**Table 18.108: TeSys U Starter and Soft Start Unit Combinations**

Motor Power, hp		Soft Starter	TeSys U	
Voltage			Power Base	Control Unit <sup>[2]</sup>
200 V	460 V			
1	2	ATSU01N206LT	LUB 12	LUC●05BL
1.5	3	ATSU01N206LT		LUC●12BL
2	5	ATSU01N209LT		LUC●12BL
3	—	ATSU01N212LT		LUC●12BL
—	7.5	ATSU01N212LT		LUC●18BL
5	10	ATSU01N222LT		LUC●18BL
7.5	15	ATSU01N222LT	LUB 32	LUC●32BL
10	20	ATSU01N232LT		LUC●32BL



ATSU01●●



E164862  
CCN NLDX



LR43364  
Class 3211 04



[1] Standard motor power ratings, HP power ratings indicated according to standard UL 508.

[2] Depending on the configuration of the chosen TeSys U starter, replace the ● with **A** for standard, **B** for advanced, and **M** for multifunction. See Table 18.74 for a complete list of available control units. Control voltage must be 24 Vdc.

TeSys™ D—AC Coils

Table 18.109: For LC1D09–D38, LC1DT20–DT40 Contactors and CAD Relays

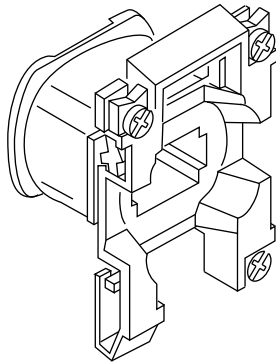

LX1D2

Rated Nominal Voltage	Catalog Number, 50/60 Hz
24	LXD1B7
120	LXD1G7
208	LXD1LE7
230/240	LXD1U7
277	LXD1W7
Specifications	50/60 Hz
Average consumption	
- Inrush (inductance 0.75)	70 VA
- Sealed (inductance 0.3)	7 VA
Operating range@ 60° C	80–110% of nominal @ 50 Hz, 85–110% of nominal @ 60 Hz

TeSys™ D—AC Coils

Table 18.110: For Old D2 Style LC1D40, D50, D65, D80, and D95; For TeSys D LC1D40A, D50A, D65A, DT60A, and DT80A; For TeSys D LC1D115 and D150

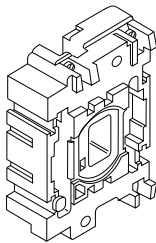

LX1D6

For TeSys D LC1D40A, D50A, D65A, DT60A, DT80A	
Rated Nominal Voltage, V	Catalog Number 50/60 Hz
<b>For TeSys D LC1D40A, D50A, D65A, DT60A, DT80A</b>	
24	LXD3B7
120	LXD3G7 <sup>[1]</sup>
208	LXD3LE7 <sup>[1]</sup>
240	LXD3U7
480	LXD3T7
Specification	50/60 Hz
Average consumption	
-inrush (inductance 0.3)	140 VA (Inductance: 0.9)
-sealed (inductance 0.3)	7.5 VA (Inductance: 0.9)
Operating range	
at $\theta \leq 55^\circ\text{C} / 131^\circ\text{F}$	80–115% of nominal voltage
<b>For TeSys D LC1D115, D150</b>	
24	LX1D8B7
120	LX1D8G7
208	LX1D8L7
240	LX1D8U7
277	LX1D8W7
480	LX1D8T7
Specification	50/60 Hz
Average consumption	
-inrush (inductance 0.8)	350 VA (Inductance: 0.9)
-sealed (inductance 0.3)	18 VA (Inductance: 0.9)
Operating range	
at $\theta \leq 55^\circ\text{C} / 131^\circ\text{F}$	80–115% of nominal voltage

Table 18.111: TeSys™ F—AC Coils (For LC1F115, F150, F185, F225, F265, F330, F400, F500, F630, F780, F800, and F1400–F2100)

Contactor	F115-F150	F185-F225	F265-F330	F400	F500	F630	F780 <sup>[2]</sup>	F800 <sup>[3]</sup>	F1400-F2100 <sup>[3]</sup>
<b>Coil Part Number AC 50/60 Hz</b>									
120 V	LX9FF127	LX9FG127	LX1FH1272	LX1FJ127	LX1FK127	LX1FL110	LX1FX110	LX4F8FW	LX1FK070 <sup>[4]</sup>
240 V	LX9FF220	LX9FG220	LX1FH2402	LX1FJ240	LX1FK240	LX1FL220	LX1FX220	LX4F8MW	LX1FK127
480 V	LX9FF500	LX9FG500	LX1FH5002	LX1FJ500	LX1FK500	LX1FL415	LX1FX415	—	LX1FK240
<b>Coil Part Number DC</b>									
24 V	LX4FF024	LX4FG024	LX4FH024	—	—	—	—	—	—

[1] 60 Hz only  
 [2] LC1F780 contactors operate with 2 coils as a set. The LX1FX\* part number includes both coils.  
 [3] Also requires rectifier DR5TE4U for 110–240 V coils.  
 [4] Order 2 coils and connect them in series.

**TeSys™ F Contact Kits, Arc Chambers**

**Table 18.112: Replacement Contact Sets [5]**

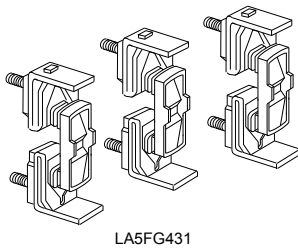

LA5FG431

	For use on contactors	Number of Poles	Catalog Number
Three-pole	LC1F115, F150	3 poles	LA5FF431
	LC1F185, F225	3 poles	LA5FG431
	LC1F265	3 poles	LA5FH431
	LC1F330, F400	3 poles	LA5F400803
	LC1F500	3 poles	LA5F500803
	LC1F630	3 poles	LA5F630803
	LC1F780	1 pole	LA5F780801 [6]
	LC1F800	3 poles	LA5F800803

TeSys F contactors: page 18-14 and page 18-14  
 TeSys F overload relay accessories: page 18-24  
 TeSys F replacement coils and parts: page 18-40, and page 18-40  
 TeSys F dimensions: page 18-45, page 18-54

**TeSys™ AK5 Panel Busbar System**

The AK5 pre-fabricated bus bar system provides a quick and easy method of mounting control devices. All components are finger safe, UL Listed, CSA approved and CE marked. Although the AK5 system can be screw mounted onto any type of support, it **must be mounted** on the AM1DL201 DIN rail when component mounting plates incorporating a tap-off are used. When using tap-offs, the nominal operating current of the bus bar (160 A @ 35°) must not be exceeded. Approvals include IEC 439, UL, CSA, DNV and LROS.



AK5JB busbar

**Table 18.113: 160 A, 3-Phase Busbar System**

Maximum number of mounting plates					Length		Catalog Number	
Tap-off		Standard Width Plate		Extension Plate		in.		mm
1.42 in.	36 mm	2.13 in.	54 mm	2.80 in.	71 mm			
15		10		5		26.05	668	AK5JB146
24		16		8		38.69	992	AK5JB149

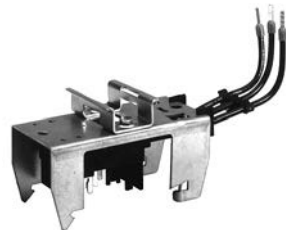

AK5PA231

**Table 18.114: Mounting Plate Tap-off (plugs into busbar mounted on AM1DL201 DIN rail)**

Width		Thermal Current Amperes	Application	Catalog Number
in.	mm			
2.13	54	25 A	GV2 with LUS or LUB 12 and 32 contactor	AK5PA231
2.13	54	25 A		AK5PA232

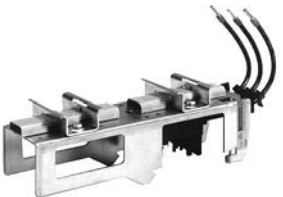

AK5PA232S

**Table 18.115: Bus Tap-off (plugs into busbar for wiring to a separately mounted device)**

Width		Thermal Current (A)	Length of Leads		Catalog Number
in.	mm		in.	mm	
1.42	36	32 A	9.84	250	AK5PC33
1.42	36	32 A	39.37	1000	AK5PC33L



AK5PC33

**Table 18.116: Mounting Rail (must be used for mounting plates with tap-offs)**

Description	Depth	Length	Catalog Number
	mm	mm	
75 mm Omega Rail	15	2000	AM1DL201



AM1DL201



File E161251  
CCN NMTR



File LR 89150  
Class 6228-01

[5] Supplied per pole are: 2 fixed contacts, 1 moving contact, 2 deflectors, 1 backplate, mounting screws and washers.

[6] Two identical components per pole are supplied.

TeSys™ island Load Management System Module Dimensions

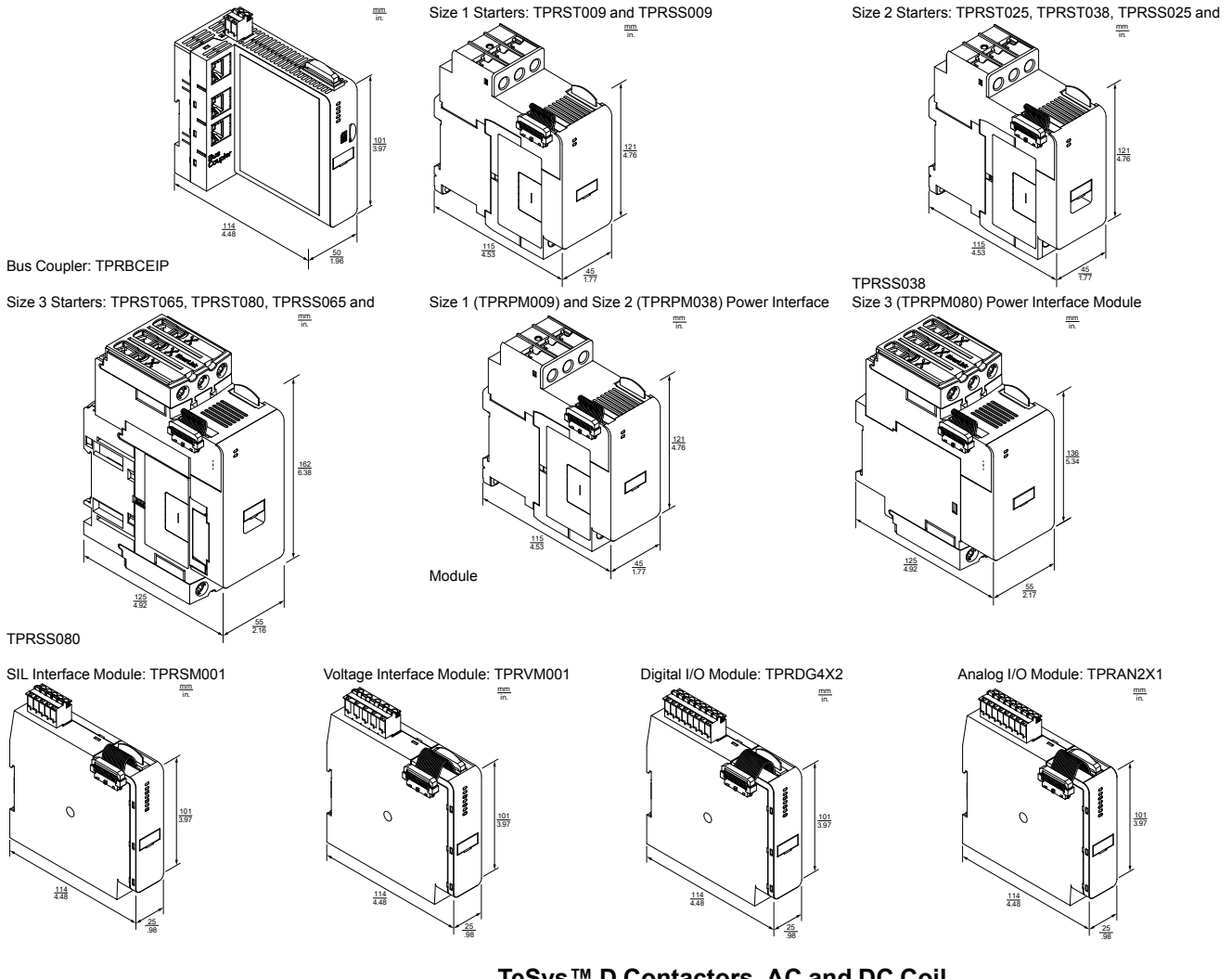

TeSys™ D Contactors, AC and DC Coil

Table 18.117: TeSys D 9 to 38 A Contactors, AC and DC Coils

LC1D09 to D18		LC1D25 to D38 (3-pole) and LC1DT20 to DT40 (4-pole)				
TeSys D contactors: LC1D		D09 to D18 in. (mm)	D25 to D38 in. (mm)	D098, D128, DT20, DT25 in. (mm)	DT32, DT40 in. (mm)	D188, D258 in. (mm)
b	AC coil, without add-on accessories	3.03 (77)	3.36 (85)	3.34 (85)	3.58 (91)	4.13 (105)
	DC coil	3.03 (77)	3.36 (85)	3.34 (85)	3.58 (91)	4.13 (105)
b1	AC coil, with LAD4BB	3.70 (94)	3.85 (98)	3.85 (98)	—	—
	AC coil, with LA4D*2	4.33 (110) [1]	4.48 (114) [1]	4.48 (114)	—	—
	AC coil, with LA4DF, DT	4.68 (119) [1]	4.84 (123) [1]	5.02 (129)	—	—
c	AC coil, with LA4DR, DW, DL	4.96 (126) [1]	5.11 (130) [1]	7.48 (190)	—	—
	AC coil, without cover or add-on blocks	3.30 (84)	3.54 (90)	3.54 (90)	3.85 (98)	3.85 (98)
	AC coil, with cover, without add-on blocks	3.38 (86)	3.62 (92)	3.62 (92)	3.93 (100)	3.93 (100)
	DC coil, without cover or add-on blocks	3.66 (93)	3.89 (99)	—	—	—
c1	DC coil, with cover, without add-on blocks	3.76 (95)	3.97 (101)	3.90 (99)	4.21 (107)	4.21 (107)
	AC coil, with LADN or C (two or four contacts)	4.60 (117)	4.84 (123)	4.84 (123)	5.15 (131)	5.15 (131)
c2	DC coil, with LADN or C (two or four contacts)	4.96 (126)	5.19 (132)	4.84 (123)	5.15 (131)	5.15 (131)
	AC coil, with LAD6K10	5.07 (129)	5.31 (135)	5.31 (135)	5.62 (143)	5.62 (143)

[1] Including LAD4BB.

**Table 18.117 TeSys D 9 to 38 A Contactors, AC and DC Coils (cont'd.)**

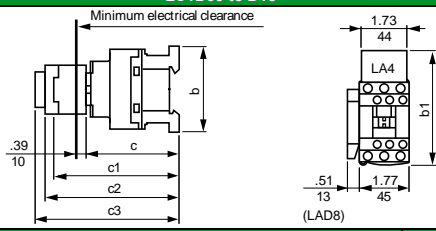
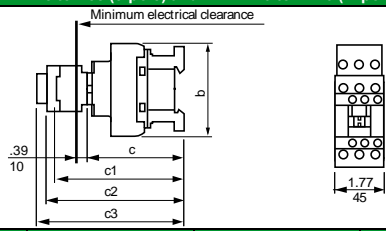
LC1D09 to D18		LC1D25 to D38 (3-pole) and LC1DT20 to DT40 (4-pole)				
						
TeSys D contactors: LC1D		D09 to D18 in. (mm)	D25 to D38 in. (mm)	D098, D128, DT20, DT25 in. (mm)	DT32, DT40 in. (mm)	D188, D258 in. (mm)
c3	DC coil, with LAD6K10	5.43 (138)	5.66 (144)	5.31 (135)	5.62 (143)	5.62 (143)
	AC coil, with LADT, R, S	5.39 (137)	5.62 (143)	5.62 (143)	5.94 (151)	5.94 (151)
	AC coil, with LADT, R, S and sealing cover	5.55 (141)	5.78 (147)	5.78 (147)	6.10 (155)	6.10 (155)
	DC coil with LADT, R, S	5.76 (146)	5.98 (152)	5.62 (143)	5.94 (151)	5.94 (151)
	DC coil with LADT, R, S and sealing cover	5.90 (150)	6.14 (156)	5.78 (147)	6.10 (155)	6.10 (155)

**Table 18.118: TeSys D 40 A to 65 A, AC and DC coil**

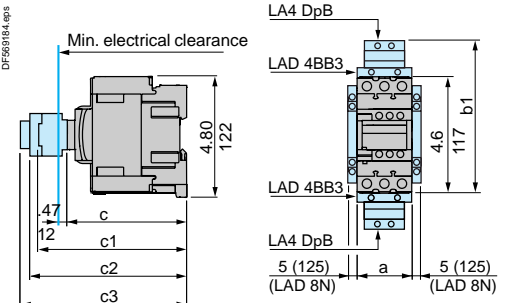
LC1 D40A–D65A (3P), LC1 DT60A–DT80A (4P) AC OR DC		LC1	D40A–D65A in. (mm)	DT60A–DT80A in. (mm)
	a	with LA4 D●2	2.17 (55)	2.76 (70)
	b1	with LA4 DB3 or LAD 4BB3	—	—
		with LA4 DF, DT	5.35 (136)	—
		with LA4 DM, DW, DL	6.18 (157)	—
	c	without cover or add-on blocks	6.54 (166)	—
		with cover, without add-on blocks	—	—
	c1	without cover or add-on blocks	4.65 (118)	4.65 (118)
		with cover, without add-on blocks	4.72 (120)	4.72 (120)
	c2	with LADN (1 contact)	—	—
		with LADN or C (2 or 4 contacts)	5.91 (150)	5.91 (150)
c3	with LAD 6K10 or LA6 DK	6.42 (163)	6.42 (163)	
	with LADT, R, S	6.73 (171)	6.73 (171)	
		with LADT, R, S and sealing cover	6.89 (175)	6.89 (175)

**Table 18.119: TeSys D80 and D95 AC Coil**

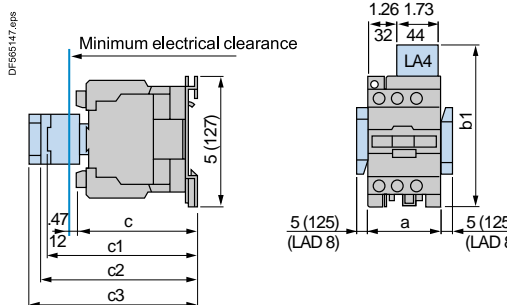
LC1D80 and D95 (3P), LP1 D80004 and D80008 (4P)		LC1	D80 in. (mm)	D95 in. (mm)	D80004 in. (mm)	D80008 in. (mm)
	a	with LA4 D●2	3.35 (85)	3.35 (85)	3.78 (96)	3.78 (96)
	b1	with LA4 DB3 or LAD 4BB3	5.31 (135)	—	—	—
		with LA4 DF, DT	5.31 (135)	—	—	—
		with LA4 DM, DW, DL	5.59 (142)	5.59 (142)	5.59 (142)	5.59 (142)
	c	without cover or add-on blocks	5.90 (150)	5.90 (150)	5.90 (150)	5.90 (150)
		with cover, without add-on blocks	4.92 (125)	4.92 (125)	4.92 (125)	5.51 (140)
	c1	with LADN (1 contact)	5.12 (130)	5.12 (130)	—	—
		with LADN or C (2 or 4 contacts)	5.90 (150)	5.90 (150)	5.90 (150)	5.90 (150)
	c2	with LADN (1 contact)	6.22 (158)	6.22 (158)	6.22 (158)	6.22 (158)
		with LAD 6K10 or LA6 DK	6.69 (170)	6.69 (170)	6.69 (170)	6.69 (170)
c3	with LADT, R, S	7 (178)	7 (178)	7 (178)	7 (178)	
	with LADT, R, S and sealing cover	7.16 (182)	7.16 (182)	7.16 (182)	7.16 (182)	

TeSys™ D Contactors, DC Coil

Table 18.120: DC Coil

LC1D80, D95 (3P), LP1D80004, D80008 (4P)	LC1	D80 and D95	D80004	D80008	
		in. (mm)	in. (mm)	in. (mm)	
<p>Minimum electrical clearance</p> <p>1.26 1.73 32 44 LA4</p> <p>5 (127)</p> <p>.47 12 c c1 c2 c3</p> <p>5 (125) (LAD 8)</p> <p>a</p> <p>b1</p> <p>5 (125) (LAD 8)</p>	a	3.35 (85)	3.78 (96)	3.78 (96)	
	b1	with LAD 4BB3	—	—	—
		with LA4 DF, DT	—	—	—
	c	without cover or add-on blocks	7.13 (181)	7.13 (181)	7.72 (196)
		with cover, without add-on blocks	7.32 (186)	—	—
	c1	with LAD N (1 contact)	8.03 (204)	8.03 (204)	8.03 (204)
		with LAD N or C (2 or 4 contacts)	8.27 (210)	8.27 (210)	8.27 (210)
	c2	with LA6 DK10	8.70 (221)	8.70 (221)	8.70 (221)
	c3	with LAD T, R, S	9.01 (229)	9.01 (229)	9.01 (229)
		with LAD T, R, S and sealing cover	9.17 (233)	9.17 (233)	9.17 (233)

LC1D115, D150 (3P), LC1D115004 (4P), AC and DC Coils Panel mounted with 1/4" screws	LC1	D115, D150	D115004	D1150046	
		in. (mm)	in. (mm)	in. (mm)	
<p>Min. electrical clearance</p> <p>.39 10 6.22 158</p> <p>LAD 8</p> <p>LA4</p> <p>b1</p> <p>a</p> <p>c c1 c2 c3</p> <p>With 2 or 4 contacts. + 4 mm with sealing cover.</p>	a	4.72 (120)	5.91 (150)	6.10 (155)	
	b1	with LA4DA2	6.85 (174)	6.85 (174)	6.85 (174)
		with LA4DF, DT	7.28 (185)	7.28 (185)	7.28 (185)
		with LA4DM, DL	7.40 (188)	7.40 (188)	7.40 (188)
	c	with LA4DW	5.20 (132)	5.20 (132)	4.53 (115)
		without cover or add-on blocks	5.35 (136)	—	—
	with cover, without add-on blocks	5.35 (136)	—	—	
	c1	with LAD N or C (2 or 4 contacts)	5.91 (150)	5.91 (150)	5.91 (150)
	c2	with LA6DK20	6.10 (155)	6.10 (155)	6.10 (155)
	c3	with LAD T, R, S	6.61 (168)	6.61 (168)	6.61 (168)
with LAD T, R, S and sealing cover		6.77 (172)	6.77 (172)	6.77 (172)	

**TeSys™ F Contactors, Dimensions**

All dimensions shown in mm.  
To convert to inches, divide by 25.4.

**LC1F115 to F330**

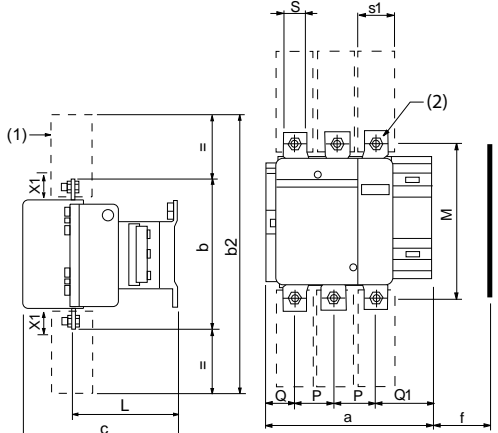

(1) Protective cover  
Type LA9F70•

(2) Optimal terminal shroud

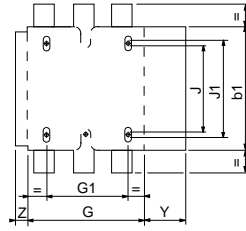

**Table 18.121: LC1F115–F330 Dimensions**

LC1	F115		F150		F185		F225		F265		F330	
	3-Pole	4-Pole	3-Pole	4-Pole	3-Pole	4-Pole	3-Pole	4-Pole	3-Pole	4-Pole	3-Pole	4-Pole
a	163.5	200.5	163.5	200.5	168.5	208.5	168.5	208.5	201.5	243.5	213	261
b	162	162	170	170	174	174	197	197	203	203	206	206
b1	137	137	137	137	137	137	137	137	145	145	145	145
b2	265	265	301	301	305	305	364	364	370	370	375	375
c	165 [2]	165 [2]	165 [2]	165 [2]	176	176	181	181	207	207	219	219
f	131	131	131	131	130	130	130	130	147	147	147	147
G	106	143	106	143	111	151	111	151	142	190	154.5	202.5
G1	80	80	80	80	80	80	80	80	96	96	96	96
J	106	106	106	106	106	106	106	106	106	106	106	106
J1	120	120	120	120	120	120	120	120	120	120	120	120
L	107	107	107	107	113.5	113.5	113.5	113.5	141	141	145	145
M	147	147	150	150	154	154	172	172	178	178	181	181
P	37	37	40	40	40	40	48	48	48	48	48	48
Q	29.5	29.5	26.5	26	29	29	21	17	39	34	43	43
Q1	60	60	57.5	55.5	59.5	59.5	51.5	47.5	66.5	66.5	74	74
S	15	15	20	20	20	20	25	25	25	25	25	25
S1	27	27	34	34	34	34	44.5	44.5	38	38	44.5	44.5
Y	44	44	44	44	44	44	44	44	38	38	38	38
Z	13.5	13.5	13.5	13.5	13.5	13.5	13.5	13.5	21.5	21.5	20.5	20.5

f = minimum distance required for coil removal.

**Table 18.122: LC1F115–F330 Voltage**

	200 to 500 V	600 to 1000 V
LC1F115, F150	10	15
LC1F185	10	15
LC1F225, F265	10	15
LC1F330	10	15

X1: Minimum clearance according to the operational voltage and the breaking capacity.

**LC1F400 to F500**

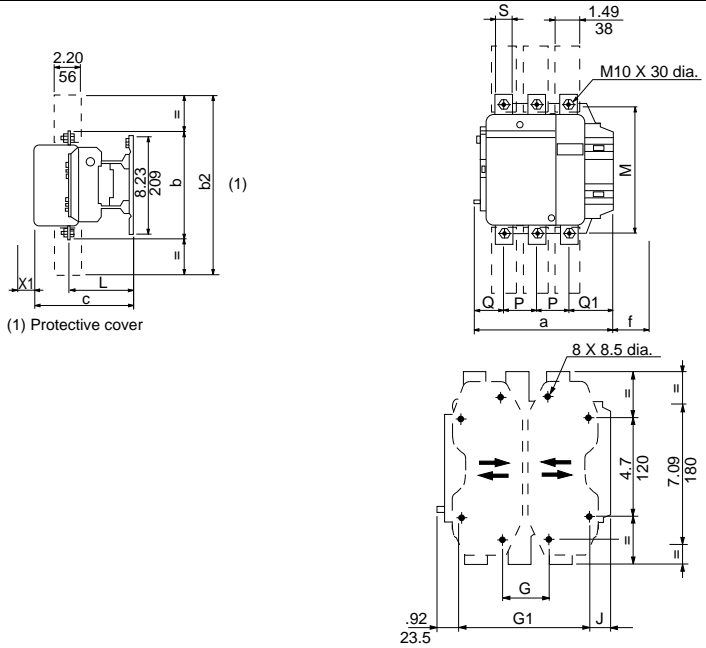

(1) Protective cover

**Table 18.123: LC1F400–F500 Dimensions**

LC1	F400			F500		
	2-Pole	3-Pole	4-Pole	2-Pole	3-Pole	4-Pole
a	213	213	261	233	233	288
b	206	206	206	238	238	238
b2	375	375	375	400	400	400
c	213	213	213	226	226	226
f	119	119	119	141	141	141
G [3]	80	80	80	80	80	140
G min.	66	66	66	66	66	66
G max.	102	102	150	120	120	175
G1 [3]	170	170	170	170	170	230
G1 min.	156	156	156	156	156	156
G1 max.	192	192	240	210	210	265
J	19.5	19.5	67.5	39.5	39.5	34.5
L	145	145	145	146	146	146
M	181	181	181	208	208	208
P	48	48	48	55	55	55
Q	69	43	43	76	46	46
Q1	96	74	74	102	77	77
S	25	25	25	30	30	30

f = Minimum distance required for coil removal.

**Table 18.124: LC1F400–F500 Voltage**

	200 to 500 V	600 to 1000 V
LC1F400	15	20
LC1F500	15	20

X1: Minimum clearance according to the operational voltage and the breaking capacity.

[2] +6 mm with time delay block (for F115 and F150).  
[3] Supplied.

Table 18.125: LC1F Dimensions

LC1F630 and LC1F800

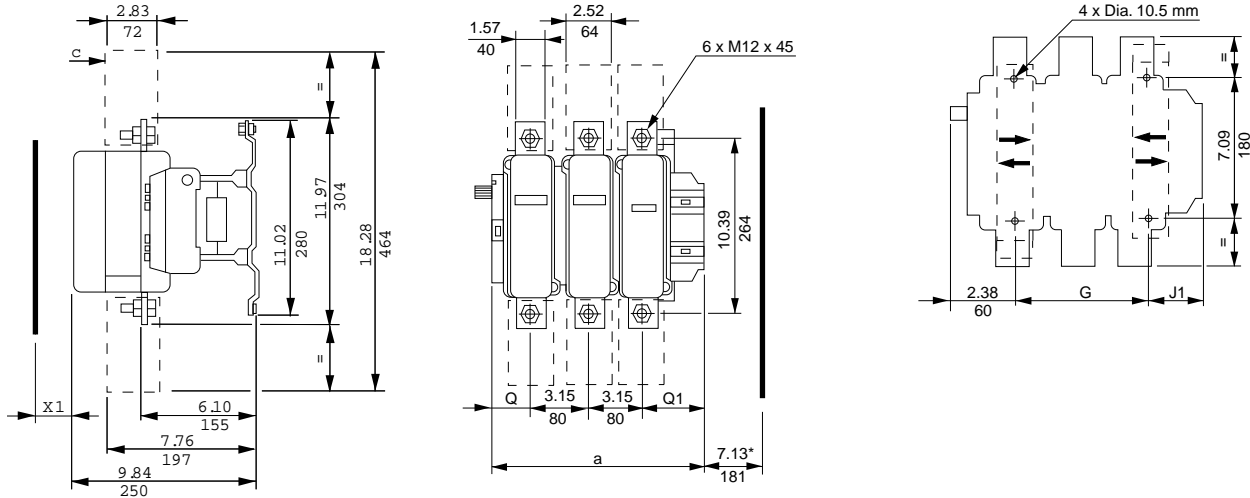

X1: Minimum clearance according to the operational voltage and the breaking capacity.

	LC1F630	a	G supplied	G min.	G max.	J1	Q	Q1							
* = minimum distance required for coil removal.	2 P	12.17	309	7.09	180	3.94	100	7.68	195	2.70	68.5	4.02	102	5.00	127
♦ Protective terminal cover.	3 P	12.17	309	7.09	180	3.94	100	7.68	195	2.70	68.5	2.36	60	3.50	89
	4 P	15.31	389	9.45	240	5.91	150	10.83	275	2.70	68.5	2.36	60	3.50	89

Voltage (V)	200–500 V	690–1000 V	200–690 V	1000 V
F630	20	30	—	—
F800	—	—	10	20

18 CONTACTORS AND STARTERS-IEC

LC1F780, F7804

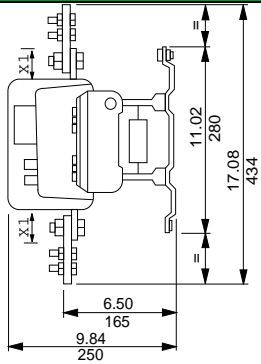

X1: Minimum clearance according to the operational voltage and the breaking capacity.

Voltage (V)	200–500 V	690–1000 V
X1 in mm	30	35

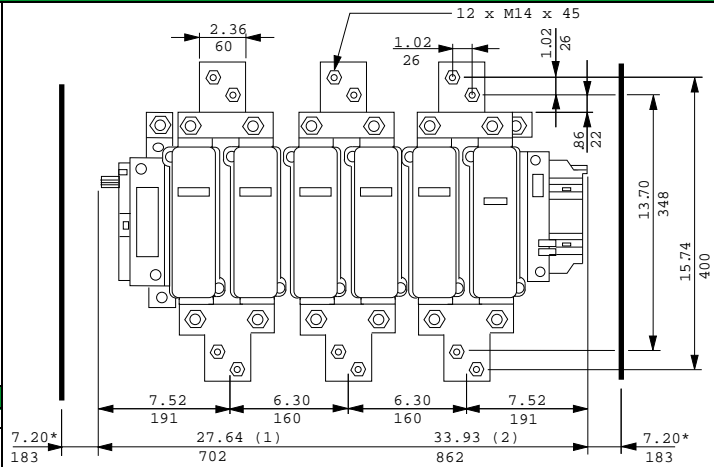

1) Overall length (3 poles).  
2) Overall length (4 poles).  
\* Minimum distance required for coil removal.

LC1F780 mounting

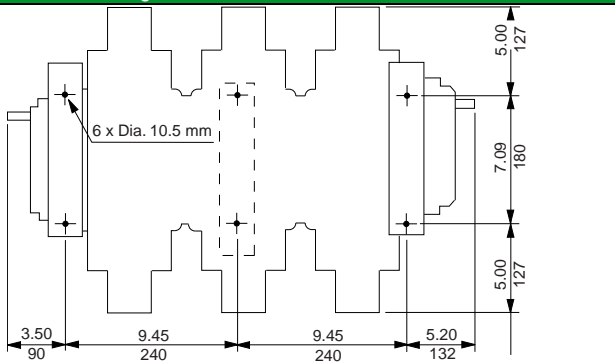

LC1F7804 mounting

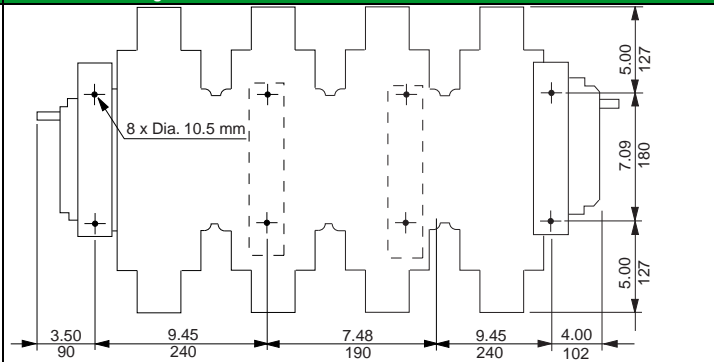



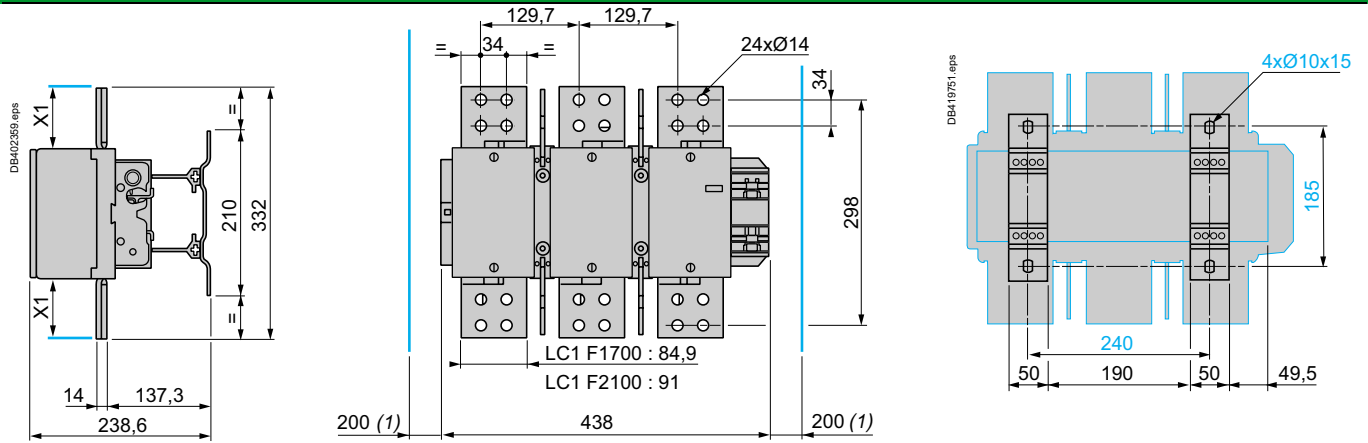

X1: Minimum clearance according to the operational voltage and the breaking capacity.  
1) Minimum distance required for coil removal.

Voltage (V)	200–500 V	690–1000 V
X1 in mm	90	100

TeSys™ D Reversing Contactor Dimensions

Table 18.126: Reversing Contactor Dimensions

LC2D09–D38  
2 x LC1D09 to D38

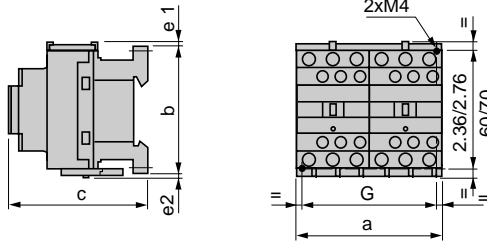

LC2 or 2 x LC1	a	b	c [4]	e1	e2	G
	in. (mm)	in. (mm)	in. (mm)	in. (mm)	in. (mm)	in. (mm)
D09 to D18 (AC Coil)	3.54 (90)	3.03 (77)	3.38 (86)	0.16 (4)	0.06 (1.5)	3.14 (80)
D093 to D123 (AC Coil)	3.54 (90)	3.9 (99)	3.38 (86)	—	—	3.14 (80)
D09 to D18 (DC Coil)	3.54 (90)	3.03 (77)	3.74 (95)	0.16 (4)	0.06 (1.5)	3.14 (80)
D093 to D123 (DC Coil)	3.54 (90)	3.9 (99)	3.74 (95)	—	—	3.14 (80)
D25 to D38 (AC Coil)	3.54 (90)	3.34 (85)	3.62 (92)	0.35 (9)	0.20 (5)	3.14 (80)
D183 to D383 (AC Coil)	3.54 (90)	3.9 (99)	3.62 (92)	—	—	3.14 (80)
D25 and D32 (DC Coil)	3.54 (90)	3.34 (85)	3.98 (101)	0.35 (9)	0.20 (5)	3.14 (80)
D183 to D383 (DC Coil)	3.54 (90)	3.9 (99)	3.98 (101)	—	—	3.14 (80)

e1 and e2: includes cabling

LC2DT20 to DT40  
2 x LC1 DT20 to DT40

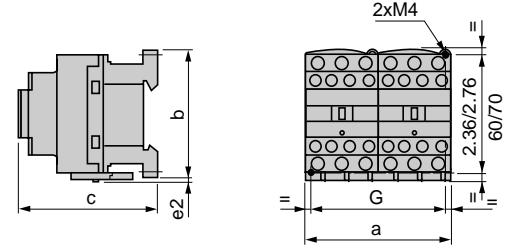

LC2 or 2 x LC1	a	b	c	G
	in. (mm)	in. (mm)	in. (mm)	in. (mm)
DT20 and DT25 (AC Coil)	3.54 (90)	3.34 (85)	3.62 (92)	3.14 (80)
DT32 and DT40 (AC Coil)	3.54 (90)	3.58 (91)	3.9 (99)	3.14 (80)
DT20 and DT25 (DC Coil)	3.54 (90)	3.34 (85)	4 (102)	3.14 (80)
DT32 and DT40 (DC Coil)	3.54 (90)	3.58 (91)	4.29 (109)	3.14 (80)

c, e: includes cabling

LC2D40A to D65A  
2 x LC1D40A to D65A

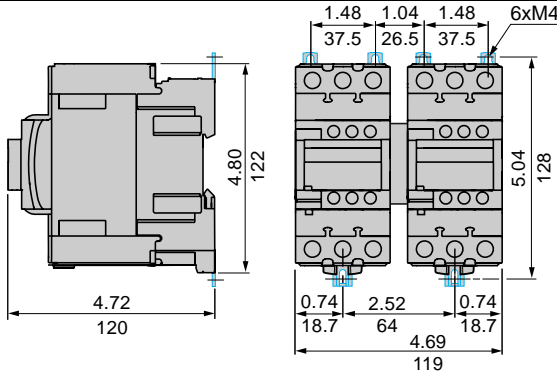

LC2D80 and D95  
2 x LC1D80 and D95 (AC Coil)

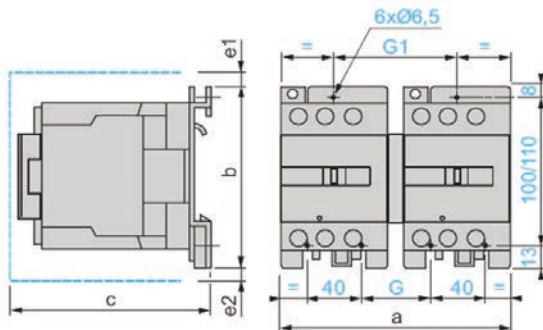

LC2 or 2 x LC1	a	b	c	e1	e2	G	G1
	in. (mm)	in. (mm)	in. (mm)	in. (mm)	in. (mm)	in. (mm)	in. (mm)
D80 and D95	7.17 (182)	5 (127)	6.22 (158)	0.51 (13)	—	2.24 (57)	3.78 (96)
D80004	8.15 (207)	5 (127)	6.22 (158)	—	0.79 (20)	2.8 (71)	4.37 (111)

c, e1, and e2: includes cabling

2 x LC1D80 and D95 (DC Coil)

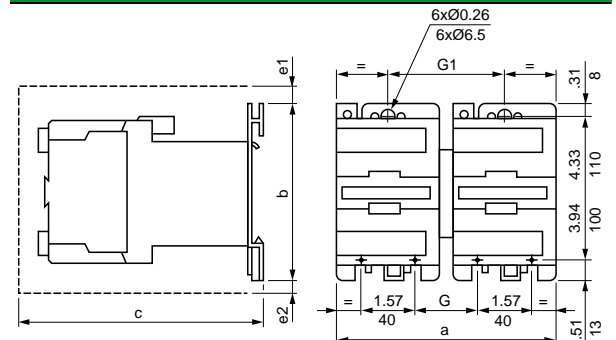

2 x LC1	a	b	c	e1	e2	G	G1
	in. (mm)	in. (mm)	in. (mm)	in. (mm)	in. (mm)	in. (mm)	in. (mm)
D80 and D95	8.15 (207)	5.0 (127)	8.46 (215)	0.51 (13)	0.79 (20)	3.78 (96)	4.37 (111)

c, e1 and e2: includes cabling.

[4] With safety cover, without add-on block.

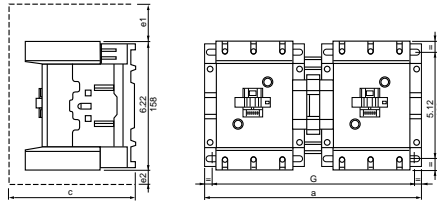

LC2 or 2 x LC1	a	c	e1	e2	G
	in. (mm)	in. (mm)	in. (mm)	in. (mm)	in. (mm)
D115, D150	10.47 (266)	5.83 (148)	2.2 (56)	0.71 (18)	9.53/10.08 (242/256)
D115004	13.15 (334)	5.83 (148)	—	2.36 (60)	12.2/12.76 (310/324)

c, e1 and e2 includes cabling

**NOTE:** For dimensions of TeSys F reversing contactors, please refer to catalog [MKTED210011EN](#).

TeSys™ D Open Starter Dimensions

Table 18.127: TeSys D Thermal Overload Relay Dimensions, in. (mm)

LRD01-35  
Direct mounting beneath contactors with screw clamp connections

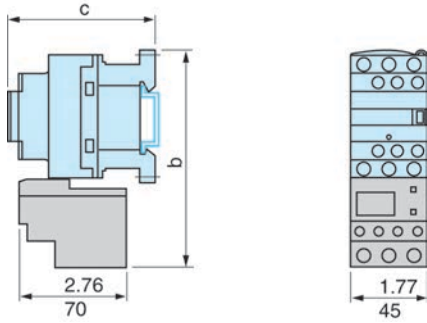

LC1•	D09–D18	D25–D38
b	4.84 (123)	5.39 (137)
c	See page 18-42	

LRD04L-32L  
Direct mounting beneath contactors with screw clamp connections

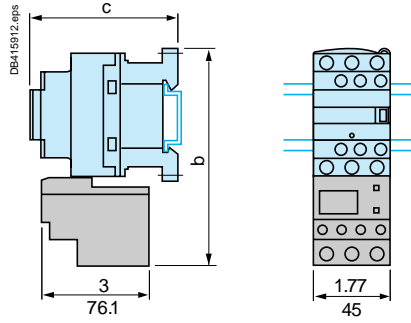

LC1•	D09–D18	D25–D38
b	4.84 (123)	5.39 (137)
c	See page 18-42	

LR9D01, 02, 08, and 32

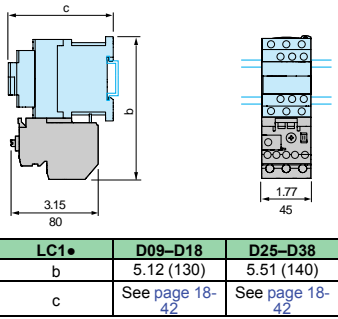

LC1•	D09–D18	D25–D38
b	5.12 (130)	5.51 (140)
c	See page 18-42	See page 18-42

LRD313–365  
Direct mounting beneath LC1D40A to D65A with screw clamp connectors or EverLink connectors

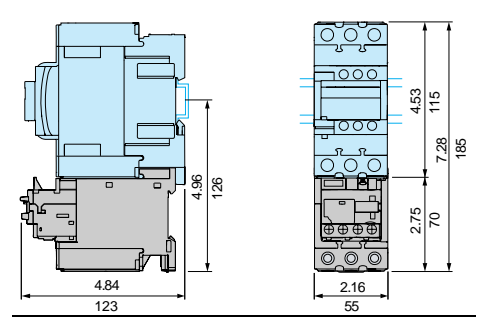

LRD33•••  
Direct mounting beneath contactors LC1D80 to D95

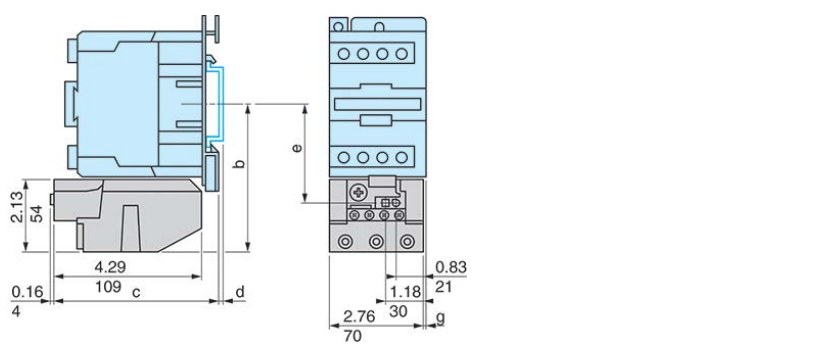

AM1•	DL201		DL200		
d	0.28 (7)		0.67 (17)		
	b	c	e	g (3P)	g (4P)
AC Control Circuit					
LC1D80	4.55 (115.5)	4.88 (124)	3.03 (76.9)	0.37 (9.5)	0.87 (22)
LC1D95	4.55 (115.5)	4.88 (124)	3.03 (76.9)	0.37 (9.5)	—
DC Control Circuit					
LP1D80	4.55 (115.5)	7.06 (179.4)	3.03 (76.9)	0.37 (9.5)	0.87 (22)

[www.se.com/us](http://www.se.com/us)

**LRD4...[5]**  
Direct mounting beneath contactors LC1D115 and D150

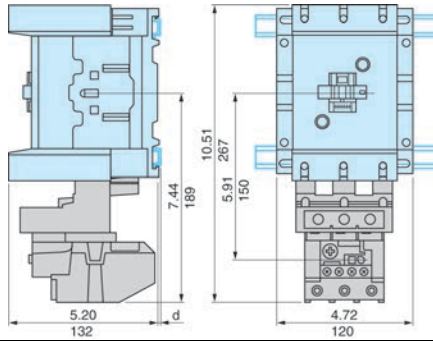

AM1	DL200 and DR200	DE200 and ED...[5]
d	0.10 (2.5)	0.41 (10.5)

**LR9D5...[5] and LR9D6...[5]**  
Direct mounting beneath contactors LC1D115 and D150

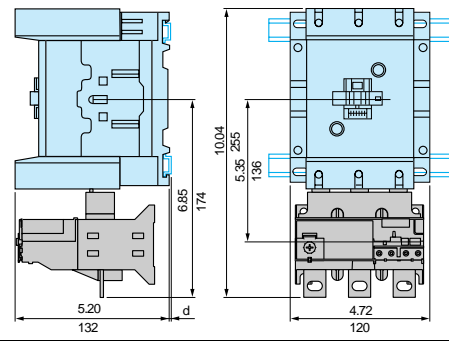

AM1	DP200 and DR200	DE200 and ED...[5]
d	0.10 (2.5)	0.41 (10.5)

[5] For additional specifications and selection information, see catalog [MKTED210011EN](#)

TeSys™ D Thermal Overload Relay Dimensions

LRD01-35  
Independent mounting on 1.97 in. (50 mm) centers or on rail AM1DP200 or DE200

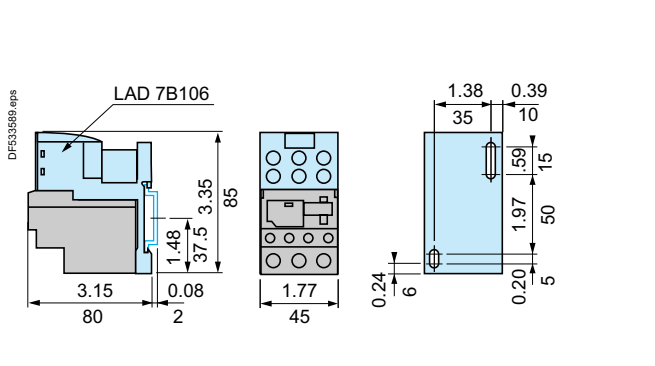

Independent mounting on 4.33 in. (110 mm) centers

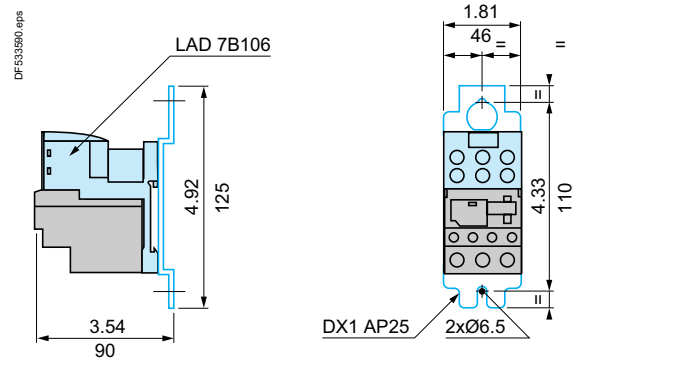

LRD04L-32L  
Independent mounting on 1.97 in. (50 mm) centers or on rail AM1DP200 or DE200

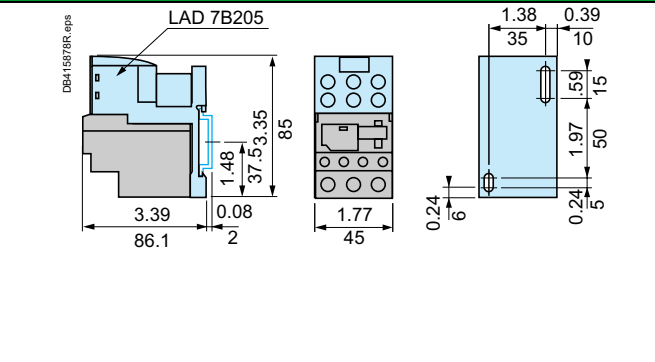

Independent mounting on 4.33 in. (110 mm) centers

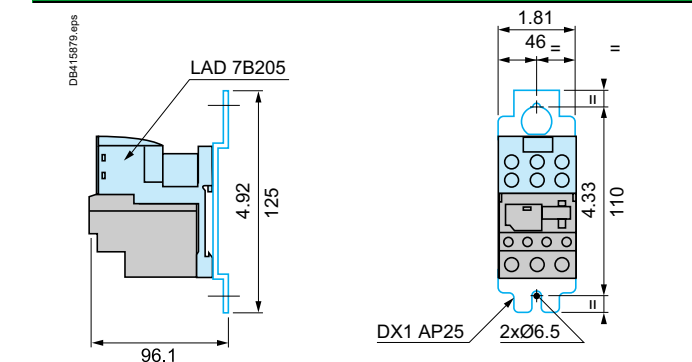

AM1	DP200	DE200
d	0.08 (2)	0.37 (9.5)

LRD313-365  
Mounting on rail AM1D•200 or ED200

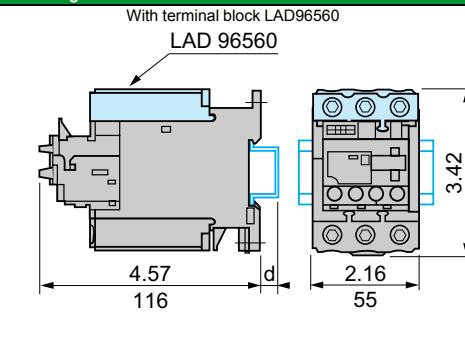

Panel mounting

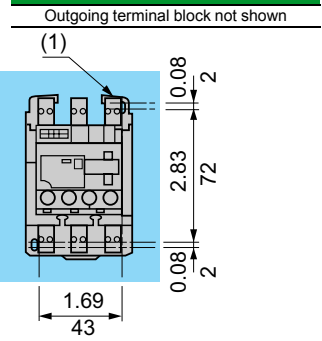

Mounted on plate AM1P

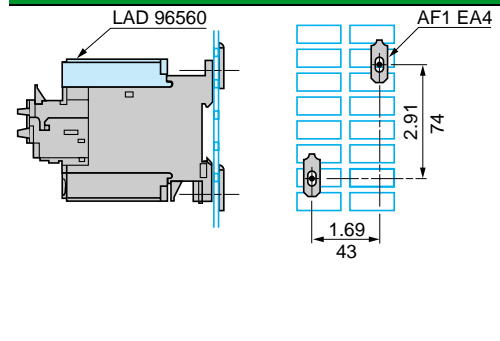

(1) 2 elongated holes Ø4.2 x 6.

AM1	DP200	DE200	ED200
d	0.08 (2)	0.37 (9.5)	0.37 (9.5)

LRD01-35 and LRD313-365  
Remote tripping or electrical reset

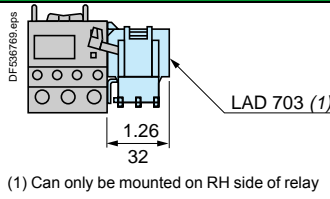

www.se.com/us

**LR9D01-D32**

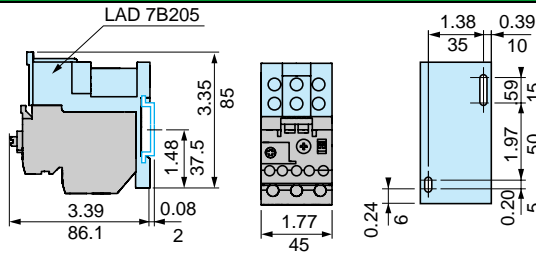

**LR9D110S**

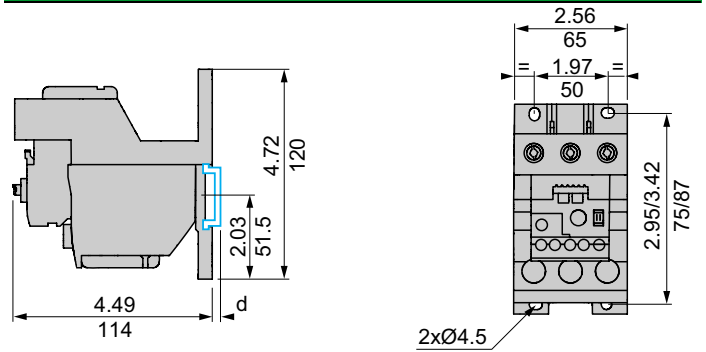

**LRD3... and LR2D35...**  
Independent mounting on 1.97 in. (50 mm) centers or on rail AM1DP200 or DE200

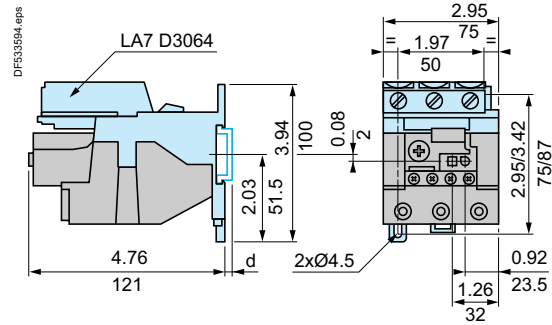

**LRD3..., LR2D35..., and LR9D5**  
Remote tripping or electrical reset

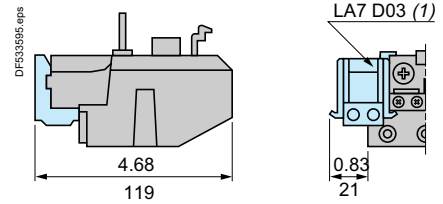

AM1	DP200	DE200
d	0.08 (2)	0.37 (9.5)

(1) Can be mounted on RH or LH side of relay LRD3..., LR2D35..., or LR9D

**LRD3...**  
Adapter for door-mounted operator

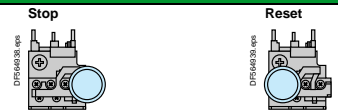
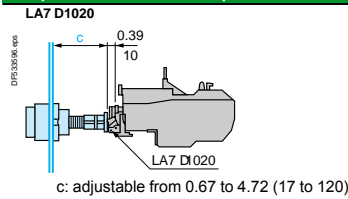

**LRD, LRD313-365, LRD04-32L, LR9D5, and LR9D6**  
"Reset" by flexible cable

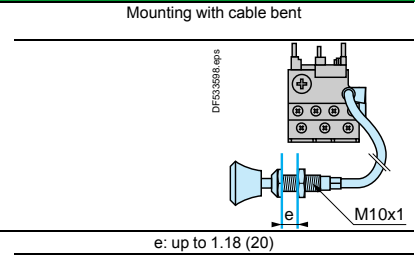
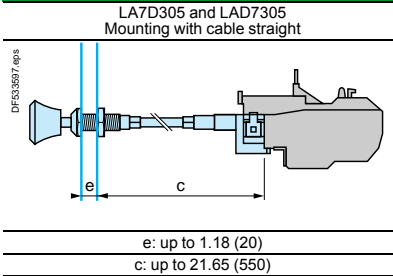

TeSys™ F Overload Relay Dimensions

All dimensions shown in mm.  
To convert to inches, divide by 25.4.

Table 18.128: TeSys F Overload Relay Dimensions

LR9F5•71, F71	LR9F5•57, F5•63, F5•67, F5•69, F57, F63, F67, F69
<p><b>Common side view</b></p> <p>1) Terminal shroud LA9F70•</p>	<p>2) 6.5 x 13.5 for LR9F5•57 and F57. 8.5 x 13.5 for LR9F5•63, F5•67, F5•69, F63, F67, F69.</p>

LR9F7•75, F7•79, F7•81, F75, F79, F81	LR9F7•81, F81									
<p><b>Common side view</b></p> <p>(1) Terminal shroud LA9-F70•</p> <table border="1"> <thead> <tr> <th></th> <th>P1</th> <th>P2</th> </tr> </thead> <tbody> <tr> <td>LR9F7•75, F75</td> <td>48</td> <td>48</td> </tr> <tr> <td>LR9F7•79, F7•81, F79, F81</td> <td>55</td> <td>55</td> </tr> </tbody> </table>		P1	P2	LR9F7•75, F75	48	48	LR9F7•79, F7•81, F79, F81	55	55	<p><b>LR9F7•81, F81</b> (for mounting beneath LC1F630 and LC1F800)</p>
	P1	P2								
LR9F7•75, F75	48	48								
LR9F7•79, F7•81, F79, F81	55	55								

Direct mounting beneath contactor LC1F	Direct mounting beneath reversing contactors or star-delta contactors
<p>(2) Relay mounting plate, see .</p>	<p>(1) Connection accessories, see . (2) Relay mounting plate, see .</p>

LC1 contactors	With LR9 relays	b	H1	H2	H3	LC1 contactors	With LR9 relays	b	H4	H2	H3
F115	F5•57, F5•63, F5•67, F5•69, F57, F63, F67, F69	240	30	76	120	F115	F5•57, F5•63, F5•67, F5•69, F57, F63, F67, F69	279	60	76	120
F150	F5•57, F5•63, F5•67, F5•69, F57, F63, F67, F69	246	30	76	120	F150	F5•57, F5•63, F5•67, F5•69, F57, F63, F67, F69	283	60	76	120
F185	F5•57, F5•63, F5•67, F5•69, F57, F63, F67, F69	250	30	76	120	F185	F5•57, F5•63, F5•67, F5•69, F57, F63, F67, F69	285	60	76	120
F225	F5•71, F71	273	40	76	120	F225	F5•71, F71	319	80	76	120
	F7•75, F7•79, F75, F79	308	50	108.8	120		F7•75, F7•79, F75, F79	360	100	108.8	120
F265	F5•71, F71	279	40	76	120	F265	F5•71, F71	332	90	76	120
	F7•75, F7•79, F75, F79	314	60	108.8	120		F7•75, F7•79, F75, F79	363	100	108.8	120
F330	F7•75, F7•79, F75, F79	317	60	108.8	120	F330	F7•75, F7•79, F75, F79	364	100	108.8	120
F400	F7•75, F7•79, F7•81, F75, F79, F81	317	60	108.8	180	F400	F7•75, F7•79, F7•81, F75, F79, F81	364	100	108.8	180
F500	F7•75, F7•79, F7•81, F75, F79, F81	346	70	108.8	180	F500	F7•75, F7•79, F7•81, F75, F79, F81	390	110	108.8	180
F630, F800	F7•81, F81	510	110	108.8	180	F630, F800	F7•81, F81	509	120	108.8	180



**TeSys™ D Combination Starter Dimensions**

**Table 18.129: Non-Combination Starter Dimensions [6]**

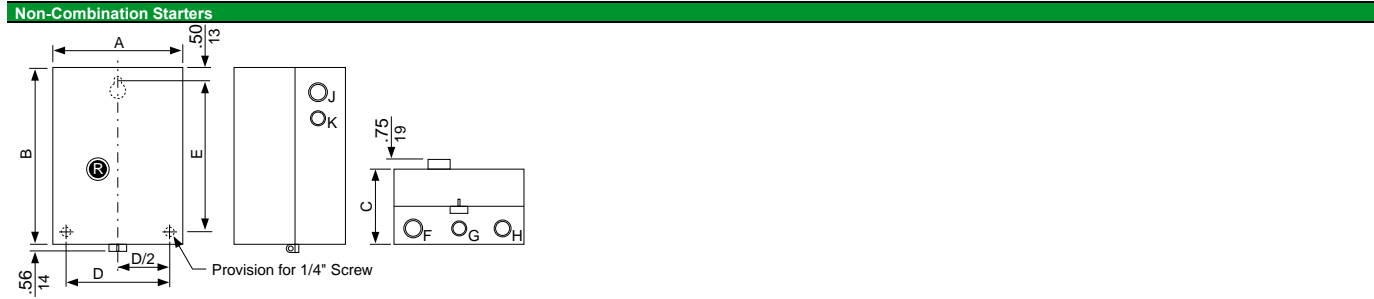

		Type 1										Type 12/3R	
Non-Reversing	Reversing	A	B	C	D	E	F	G	H	J	K	D	E
D09-32	—	6.77	10.04	6.25	5.38	9.00	1–1.25	0.5–0.75	—	1–0.25	0.5–0.75	5.38	11.37
D40-65	D09-32	8.66	10.83	7.21	7.25	9.75	1.25–1.5	0.5–0.75	1–1.25	1–0.25	0.5–0.75	5.38	12.15

[6] All dimensions in inches.

TeSys™ K Contactor Dimensions

Table 18.130: TeSys K Contactor Dimensions

<p><b>LR2K</b> Direct mounting under the contactor</p>	<p>Separate mounting with LA7-K0064 terminal block on 35 mm rail (AM1DP200 or AM1DE200)</p>
<p>Three-phase</p>	<p>Wiring Scheme</p>
<p><b>LC1, LP1, LP4K</b> Mini-contactors On baseplate</p>	<p><b>LC2, LC8, LP2, LP5K</b> Reversing mini-contactors On baseplate</p>
<p>On AM1DP200 or DE200 rail (35 mm)</p>	<p>On AM1DP200 or DE200 rail (35 mm)</p>
<p>On printed circuit board</p>	<p>On printed circuit board for reversing contactors or 2 mini-contactors side-by-side</p>
<p><b>LA2KT</b> Electronic time delay contact blocks</p>	<p>On mini-contactors or reversing mini-contactors</p>

**TeSys™ U Starter Dimensions**

**Table 18.131: TeSys U Starter Dimensions**

Starter Controllers		Non-Reversing [7]		Reversing	
Rail Mounting		Screw Mounting		Rail Mounting	

**NOTE:** Minimum electrical clearance:  
X1: 35 mm for Ue = 440 V; and 70 mm for Ue = 500 and 690 V  
X2: 0

**Reversing Block for Mounting Separately from Power Base**

	Rail Mounting	Screw Mounting

**Limiter Disconnecter LUALB1 [7]**

--

**Door interlock Mechanisms**

**LU9APN43 and LU9APN44**

--

[7] Maximum depth (with Modbus™ communication module)

Altistart U01 and TeSys U Soft Starters, Mounting

Table 18.132: Altistart U01 and TeSys U Soft Starters

TeSys U Combination (non-reversing power base) and ATSU01N212LT	TeSys U Combination (non-reversing power base) and ATSU01N222LT to ATSU01N232LT
Mounting on (35 mm) rail with VW3 G4104 connector	Mounting on (35 mm) rail with VW3G4104 connector

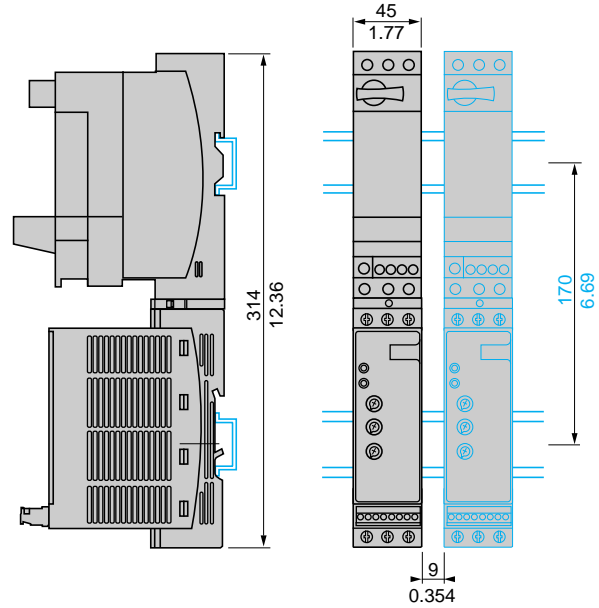
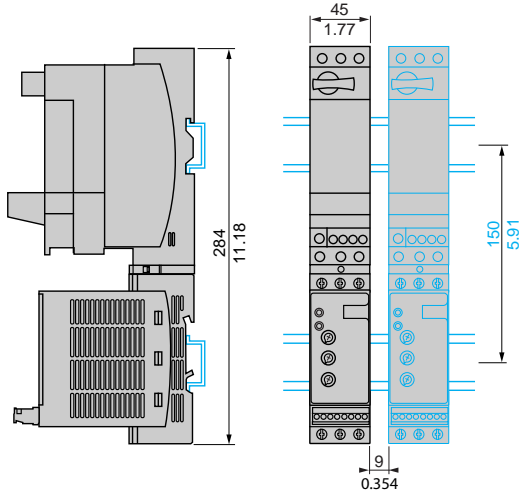

TeSys U Combination (non-reversing or reversing power base) and ATSU01N2206LT to ATSU01N212LT
Side-by-side mounting

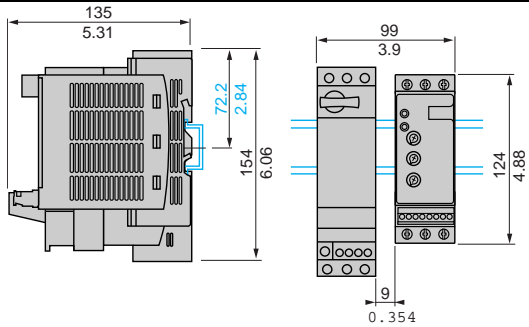

TeSys U Combination (non-reversing or reversing power base) and ATSU01N222LT to ATSU01N232LT
Side-by-side mounting

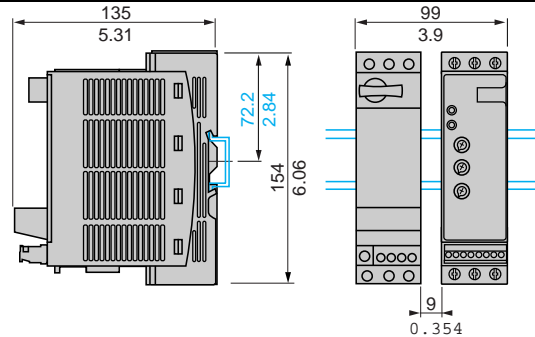

VW3G4104 Power Connector

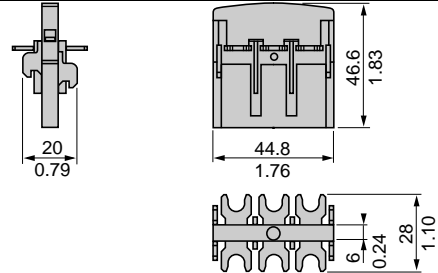

**TeSys GV2 and GV3 Manual Starter and Protector Dimensions**

**Table 18.133: TeSys GV2 and GV3 Manual Starter and Protector Dimensions**

GV2M		GV2AD, AM, AN, AU, AS, AX		GV2AE		Mounting of GV2M	
		Block GV2AD, AM, AN Block GV2AU, AS, AX 				On 35 mm L-r rail C = 78.5 mm (3.09") on AM1DP200 (35 x 7.5 mm) C = 86 mm (3.39") on AM1DE200, ED200 (35 x 15 mm) 	
GV2P		GV2AD, AM, AN, AU, AS, AX		GV2AK00		Mounting of GV2P	
		Block GV2AD, AM, AN Block GV2AU, AS, AX 				On 35 mm L-r rail C = 98.5 mm (3.88") on AM1DP200 (35 x 7.5 mm) C = 106 mm (4.17") on AM1DE200, ED200 (35 x 15 mm) 	
GV2AF4 + LAD31		GV2P + GV2GH7		GV2P + GV2GH7 + TeSys D contactor		GV2P + GV2GH7 + TeSys D contactor	
Combination GV2ME + TeSys D range contactor 		Combination GV2P + TeSys D range contactor 		for UL 508 Type E application 		for UL 508 Type E application 	
GV2ME +	LC2D09 to D18	LC2D25 and D32	GV2P +	LC2D09 to D18	LC2D25 and D32		
b	7.4 (188.6)	7.8 (199)	b	6.61 (168.1)	7.9 (199.5)		
c1	3.6 (92.7)	3.9 (99)	c1	4.6 (116.8)	4.6 (116.8)		
c	3.9 (98.2)	4.11 (104.5)	c	4.8 (122.3)	4.8 (122.3)		
d1	3.9 (98.3)	3.9 (98.3)	—	—	—		
d	4.1 (103.8)	1.4 (103.8)	—	—	—		
Surface mounting enclosure GV2MC0•				Flush mounting enclosure GV2MP0• (bracket cut-out)			
4 knock-outs for 16 mm plastic cable glands or no. 16 conduit.							

GV2	b		b1	
	in.	mm	in.	mm
MP01, MP02	5.51	140	5.00	127
MP03, MP04	5.24	133	4.61	117

Table 18.134: TeSys GV2 and GV3 Manual Starter and Protector Dimensions (cont'd)

GV2M with GK2AF01 and LC1K		GV2M with GV2AF01 and LC1K		GV2M with GV2AF01 and LC2K		Adapter Plate GK2AF01	
Dimensions (mm)							
79 3.11	152 6.0 45 1.77	152 6.0 90 3.54	152 6.0 90 3.54	55 2.17 45 1.77 24 .94 9.5 .37	5.31	35 1.38 45 1.77 54 2.13 105 ± 5 4.13 ± 2 5 0.2	35 1.38 5 0.2
Mounting external operator GV2AP0		Door cut-out		GV2M on panel with GV2AF02 adapter plate		7.5 mm height compensation plate GV1F03	
65 2.56 53 2.1 1.5...50.06...0.20 min.=150 5.91 max.=290 11.42	7 0.276 5.2 0.21	4xØ3.5 0.14 Ø43 1.7 54 2.13 54 2.13	54 2.13	4.2 .17 50/60 1.97/2.36 80 3.15 35 1.38		39 1.54 13 0.51 35 1.38	
Sets of bus bars, GV2G445, GV2G454, GV2G472 with terminal block GV2G05				Sets of bus bars with terminal block GV1G09		Sets of bus bars GV2G245, GV2G254, GV2G272	
	.12 3 63 2.5 1.8 45	l p	l p	1.2 30	l	l	l
GV2G445	0.16 x 1.8 in. (4 x 45 mm)	7.0 in. (179 mm)	1.8 in. (45 mm)	GV2G245	0.08 x 1.8 in. (2 x 45 mm)	3.5 in. (89 mm)	
GV2G454	0.16 x 2.1 in. (4 x 54 mm)	8.1 in. (206 mm)	2.1 in. (54 mm)	GV2G254	0.08 x 2.1 in. (2 x 54 mm)	3.9 in. (98 mm)	
GV2G472	0.16 x 1.8 in. (4 x 45 mm)	10.2 in. (260 mm)	2.8 in. (72 mm)	GV2G272	0.08 x 2.8 in. (2 x 72 mm)	4.6 in. (116 mm)	
				GV2G354	0.12 x 2.1 in. (3 x 54 mm)	6.0 in. (152 mm)	
GV3P							
Dimension				Mounting on rail AM1 DE200 or AM1 ED201			
X1 136 X1	68 64 132 55	(1) (2) 9 18	Blocks GV AN●●, GV AD●●, GV AM11 Block GV3 AU●● and GV3 AS●●	68 64 144			
X1 = Electrical clearance (ISC max) 40 mm for Ue < 500 V; 50 mm for Ue < 690 V							
Mounting on panel, using M4 screws		Mounting on pre-slotted mounting plate AM1PA					
136	3xØ4 137.5 37.5	136	AF1 EA4 18.7 18.7	136	18.7 18.7	183	16

NOTE: Leave a space of 9 mm between 2 manual motor protectors: either an empty space or side-mounting add-on contact blocks. Horizontal mounting is possible: please consult your regional sales office.

**TeSys GV7 Manual Starter and Protector Dimensions**

**BV4 With Toggle**

With EverLink Connector

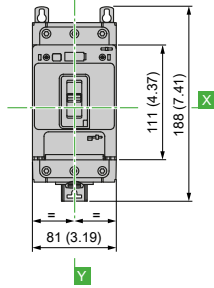
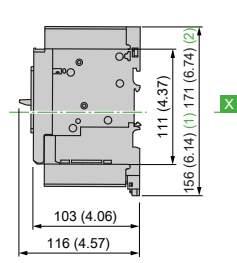

With Crimp Lug Connector

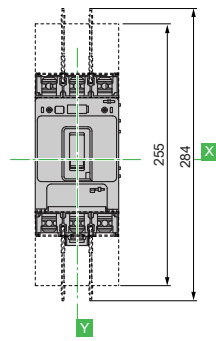
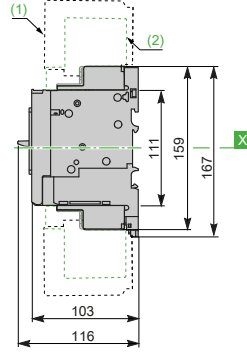

**GV4PB**

With EverLink Connector

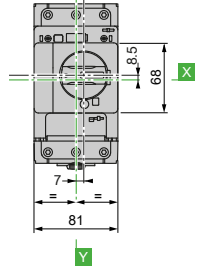
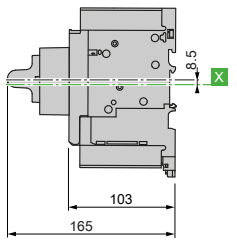

With Crimp Lug Connector

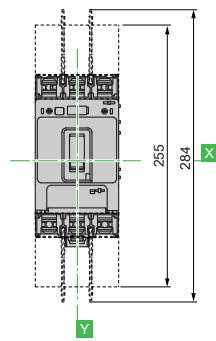
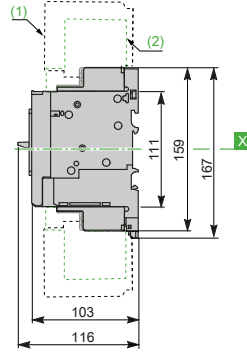

**SDx Module**

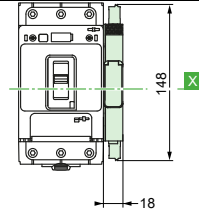

**BV4 and GV4PB With Extended Rotary Handle**

Front extended rotary handle GV4APN01, GV4APN02, GV4APN04

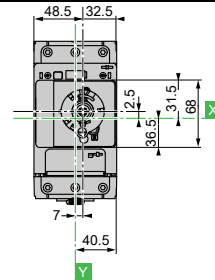
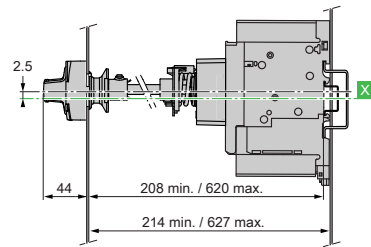

**Front and side extended rotary handle, door/side panel cut-out**

Front and side extended rotary handle

IP65, door panel cut-out

IP54, door/side panel cut-out

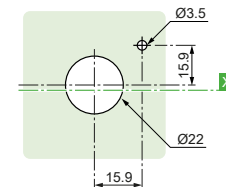
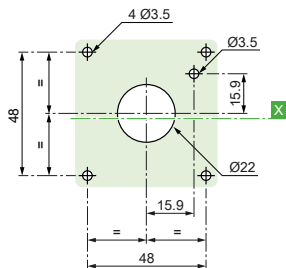
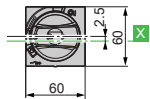
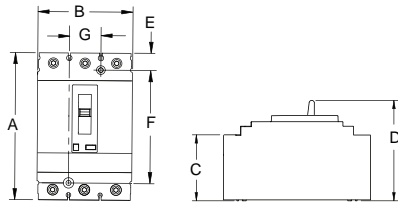

Table 18.135: GV5PB and GV6PB Motor Protective Circuit Breakers

Circuit Breaker Frame	Dimensions — Inches						
	A	B	C	D	E	F	G
GV5PB150	6.40	4.12	2.87	4.36	0.74	1.92	1.38
GV5PB250	7.52	4.12	2.87	5.00	1.30	4.92	1.38
GV6PB	13.38	5.51	3.75	6.61	2.22	7.87	1.77

GV5PB



GV6PB

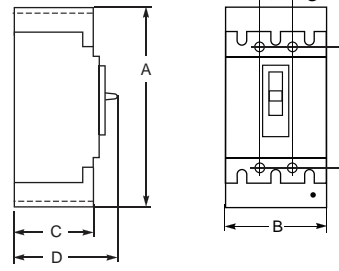



# Section 19

## Push Buttons and Operator Interface









<b>Selection Guide</b>	<b>19-2</b>
Push Buttons and Pilot Lights	19-2
Control Stations	19-4
Tower Lights and Beacons	19-5
Pendant Stations	19-7
<b>22 and 30 mm Most Common Complete Operators</b>	<b>19-8</b>
XB4–XB5 Common Operators, Complete with Contact Blocks	19-8
Type K, SK Common Operators, Complete with Contact Blocks	19-9
<b>Compact Pilot Lights</b>	<b>19-10</b>
Type XVL	19-10
Type J Compact Pilot Lights	19-11
<b>16 mm Push Buttons</b>	<b>19-12</b>
XB6 Complete Devices	19-12
XB6E Monolithic Push Buttons	19-21
<b>22 mm Push Buttons</b>	<b>19-24</b>
XB4 Complete Devices	19-24
XB5 Complete Devices	19-43
XB5R Plastic and XB4R Metal Wireless, Batteryless Push Buttons	19-63
Biometric Switches	19-66
XB7 Push Buttons	19-68
<b>30 mm Push Buttons</b>	<b>19-72</b>
<b>30 mm Push Buttons (Square)</b>	<b>19-102</b>
<b>Control Stations and Enclosures</b>	<b>19-107</b>
XAL 22 mm Control Stations	19-107
XAP 22 mm Enclosures and Accessories	19-108
9001B Standard Duty Control Stations	19-110
<b>30 mm Control Stations and Enclosures</b>	<b>19-111</b>
<b>30 mm Enclosures</b>	<b>19-112</b>
<b>Point of Purchase—PoP Products</b>	<b>19-114</b>
<b>Tower Lights and Beacons</b>	<b>19-115</b>
Signaling Units	19-120
<b>Pendant Stations</b>	<b>19-127</b>
Wireless Remote Control System	19-127
Type BW Pendant Stations	19-132
XAC Standard Duty Pistol Grips, Enclosures, Contact Blocks	19-133
Type XACA Worksheet	19-136
Application and Ordering Information	19-137
<b>Foot Switches</b>	<b>19-139</b>
<b>Rotary Cam Switches</b>	<b>19-141</b>

Push Button and Pilot Light Selection Guide

Family	XVL	Type J	XB6	XB6E
	 XVLA1**			
	 XVLA2**			
	 XVLA3**			
Type of Product	Mini Pilot Light	Compact Pilot Light	16 mm Push Button (plastic)	16mm Push Button (plastic)
Mounting Hole Diameter	8 mm / 12 mm	17.5 mm (0.68 in)	16.2 mm	16.2 mm
Approvals	UL Recognized File E164353, CCN NKCR CSA File LR44078, Class 3211-03	UL File E78403, CCN NKCR CSA File LR25490, Class 3211-03	UL File E164353, CCN NKCR CSA File LR44087, Class 3211-03	UL File E164353, CCN NKCR CSA File LR44087, Class 3211-03
Conforming to Standards	CE Marked RoHS Compliant IEC337-2 NF C 63-140 VDE 0660-200	CE Marked RoHS Compliant	CE Marked RoHS Compliant EN/IEC 60947-1, EN/IEC 60947-5-1, EN/IEC 60947-5-5 EN/IEC 60204-1 and EN/ISO 13850: 2006 (trigger action and mechanical latching Emergency Stop push buttons) JIS C 4520 and 853 UL 508 and CSA C22-2 no. 14 Gost CCC	CE Marked RoHS Compliant EN/IEC 60947-1, EN/IEC 60947-5-1, EN/IEC 60947-5-5 EN/IEC 60947-5-5 EN/IEC 60204-1 and EN/ISO 13850: 2006 (trigger action and mechanical latching Emergency Stop push buttons) UL 508 and CSA C22-2 no. 14 CCC
Degree of Protection	IP40 (IP65 with seal)	NEMA 4, 13	IP65 NEMA 1, 12	IP65 NEMA 13
Operating Temperature F° (C°)	-13 to 158 (-25 to 70)	104 (40) Max	-13 to 158 (-25 to 70)	14 to 151 (-10 to 55)
Storage Temperature F° (C°)	-40 to 158 (-40 to 70)		-40 to 158 (-40 to 70)	-40 to 158 (-40 to 70)
Electric Shock Protection	—	—	—	—
Electrical Consumption	—	—	—	—
LED	25 mA	—	6-30 Vac/Vdc: 15 mA 48-120 Vac: 20 mA	10 mA
Rated Operational Characteristics	—	—	AC-15; B300 Ue = 240 Vac and Ie = 1.5A Ue = 120 Vac and Ie = 3 A Continuous 5 A	AC-13; Ue = 240 Vac and Ie = 0.7A Ue = 120 Vac and Ie = 1A Continuous 5 A
	—	—	DC-13; R300 Ue = 250 Vdc and Ie = 0.1 A Ue = 125 Vdc and Ie = 0.22 A	DC-13; Ue = 125 Vdc and Ie = 0.15 A Ue = 24 Vdc and Ie = 0.7 A
Connection Type	XVLA1** and XVLA2** = 2.8mm x 0.5mm Faston XVLA3** = Screw Terminals	Screw Terminal —	Quick Connect/ Solder Tabs 0.11 x 0.02 in. (2.8 x 0.5 mm)	Quick Connect/ Solder Tabs 0.11 x 0.02 in. (2.8 x 0.5 mm)
Cable Size	1 x 1.5 mm <sup>2</sup> max.	2 x 14 AWG (copper only)	—	—
Digest Location	XVL , page 19-10	Type J, page 19-11	XB6, page 19-12	XB6E, page 19-21

**Push Button Selection Guide**

Family	XB4	XB5	XB7	9001K	9001SK	9001KX
						
Type of Product	*22 mm Push Button (metal)	**22 mm Push Button (plastic)	***22mm Push Button (plastic)	****30 mm Push Button (metal)	****30 mm Push Button (plastic)	****30 mm Push Button (metal, square)
Mounting Hole Diameter	22.5 mm	22.5 mm	22.5 mm	31 mm (1.22 in)	31 mm (1.22 in)	31 mm (1.22 in)
Approvals	UL Listed File E164353, CCN NKCR UL Recognized File E164353, CCN NKCR2	UL Listed File E164353, CCN NKCR UL Recognized File E164353, CCN NKCR2	UL File E164353, CCN NKCR	UL File E78403, CCN NKCR	UL File E78403, CCN NKCR	UL File E78403, CCN NKCR
	CSA File LR44087, Class 3211-03	CSA File LR44087, Class 3211-03	CSA File LR44087-122, Class 3211-03	CSA File LR25490, Class 3211-03	CSA File LR25490, Class 3211-03	CSA File LR25490, Class 3211-03
Conforming to Standards	CE Marked RoHS Compliant	CE Marked RoHS Compliant	CE Marked RoHS Compliant	CE Marked RoHS Compliant	CE Marked RoHS Compliant	CE Marked RoHS Compliant
	EN/IEC 60947-1, EN/IEC 60947-5-1, EN/IEC 60947-5-4, EN/IEC 60947-5-5	EN/IEC 60947-1, EN/IEC 60947-5-1, EN/IEC 60947-5-4, EN/IEC 60947-5-5	EN/IEC 60947-1, EN/IEC 60947-5-1 for push buttons, pilot lights, illuminated push buttons and selector switches EN/IEC 60947-1, EN/IEC 60947-5-1, EN/IEC 60947-5-5	EN/IEC 60947-1	EN/IEC 60947-1	EN/IEC 60947-1
	EN/IEC 60204-1 and EN/ISO 13850:2006 (trigger action and mechanical latching emergency stop push buttons)	EN/IEC 60204-1 and EN/ISO 13850:2006 (trigger action and mechanical latching emergency stop push button).	EN/IEC 60204-1 and EN/ISO 13850 for Emergency Stop trigger action push buttons	EN/IEC60947-5-1	EN/IEC60947-5-1	EN/IEC60947-5-1
	EN/IEC 60364-5-53 (emergency switching of mechanical latching push buttons)	EN/IEC 60364-5-53 (emergency switching of mechanical latching push buttons)		EN/IEC60947-5-4	EN/IEC60947-5-4	EN/IEC60947-5-4
	—	EN81-1 (emergency stop trigger action and mechanical latching push buttons with mechanical state indicator)				
	JIS C 4520	JIS C 4520		JIS C 4520 and 852	JIS C 4520 and 852	JIS C 4520 and 852
	UL 508	UL 508	UL 508	UL 508	UL 508	UL 508
	CSA C22.2 No.14	CSA C22.2 No.14	CSA C22.2 No.14	CSA C22.2 No.14	CSA C22.2 No.14	CSA C22.2 No.14
GOST	GOST					
CCC	CCC	CCC				
			GB 14048.5 for all XB7 range			
Degree of Protection	IP65, IP69, IP69K IP66 for booted	IP65, IP69, IP69K IP66 for booted	IP54, IP65	IP65	IP65	IP66
	NEMA 1, 2, 3, 4, 4X, 12, 13	NEMA 1, 2, 3, 3R, 4, 4X, 12, 13	NEMA 3, 4, 12	NEMA 1, 2, 3, 3R, 4, 12, 13	NEMA 1, 2, 3, 3R, 4, 4X, 12, 13	NEMA 1, 2, 3, 3R, 4, 12, 13
Operating Temperature F° (C°)	-40 to 158 (-40 to 70)	-40 to 158 (-40 to 70)	-13 to 158 (-25 to 70)	-22 to 140 (-30 to 60)	-22 to 140 (-30 to 60)	-22 to 140 (-30 to 60)
Storage Temperature F° (C°)	-40 to 158 (-40 to 70)	-40 to 158 (-40 to 70)	-40 to 158 (-40 to 70)	-40 to 158 (-40 to 70)	-40 to 158 (-40 to 70)	-40 to 158 (-40 to 70)
Electric Shock Protection	Class I	Class I	—	Class II	Class II	Class II
Electrical Consumption						
LED	24 Vac/Vdc: 18 mA 120 Vac: 14 mA	24 Vac/Vdc: 18 mA 120 Vac: 14 mA	Illuminated Push Buttons: 24V - 18mA 120V - 12mA 230V - 22mA Pilot Lights 24V - 20mA 120V - 18mA 230V - 16mA	Incandescent and LED bulbs. For ratings, see <a href="#">Standard Light Modules, page 19-91.</a>	Incandescent and LED bulbs. For ratings, see <a href="#">Standard Light Modules, page 19-91.</a>	Incandescent
	240 Vac: 14 mA	240 Vac: 14 mA				
Rated Operational Characteristics	AC-15; B600 Ue = 600 Vac and Ie = 1.2 A Ue = 240 Vac and Ie = 3 A Ue = 120 Vac and Ie = 6 A Continuous 10 A	AC-15; B600 Ue = 600 Vac and Ie = 1.2 A Ue = 240 Vac and Ie = 3 A Ue = 120 Vac and Ie = 6 A Continuous 10 A	AC-14; D300 Ue = 240 Vac and Ie = 0.3A Ue = 120 Vac and Ie = 0.6A Continuous 4 A	AC-15; A600 Continuous 10 A	AC-15; A600 Continuous 10 A	AC-15; A600 Continuous 10 A
	DC-13; Q600 Ue = 600 Vdc and Ie = 0.1 A Ue = 250 Vdc and Ie = 0.27 A Ue = 125 Vdc and Ie = 0.55 A	DC-13; Q600 Ue = 600 Vdc and Ie = 0.1 A Ue = 250Vdc and Ie = 0.27 A Ue = 125 Vdc and Ie = 0.55 A	DC-13; R300 Ue = 250 Vdc and Ie = 0.1A Ue = 125 Vdc and Ie = 0.22A	DC-13; Q600 Ue = 600 Vdc and Ie = 0.1 A Ue = 250 Vdc and Ie = 0.27 A Ue = 125 Vdc and Ie = 0.55 A	DC-13; Q600 Ue = 600 Vdc and Ie = 0.1 A Ue = 250 Vdc and Ie = 0.27 A Ue = 125 Vdc and Ie = 0.55 A	DC-13; Q600 Ue = 600 Vdc and Ie = 0.1 A Ue = 250 Vdc and Ie = 0.27 A Ue = 125 Vdc and Ie = 0.55 A
Connection Type	IP20 Fingersafe Screw or Spring Terminal		Screw and captive clamp terminal connections Faston clip connections (pilot lights)	IP20 Fingersafe Screw Terminal		
	Screw Terminal:	Spring Terminal:				
Cable Size	1 x 24 AWG (0.22 mm <sup>2</sup> ) min. 2 x 14 AWG (2.5 mm <sup>2</sup> ) max. 2 x 16 AWG (1.5 mm <sup>2</sup> ) max.			1 x 24 AWG (0.22 mm <sup>2</sup> ) min. 2 x 16 AWG (1.5 mm <sup>2</sup> ) max	1 x 24 AWG (0.22 mm <sup>2</sup> ) min. 2 x 16 AWG (1.5 mm <sup>2</sup> ) max	1 x 24 AWG (0.22mm <sup>2</sup> ) min. 2 x 16 AWG (1.5 mm <sup>2</sup> ) max
Digest Location	<a href="#">XB4, page 19-24</a>	<a href="#">XB5, page 19-43</a>	<a href="#">XB7, page 19-68</a>	<a href="#">Type K, page 19-72</a>	<a href="#">Type SK, page 19-82</a>	<a href="#">KX, page 19-102</a>

Control Station Selection Guide

Family	XAL	XAP	9001B	9001KY/SKY	Point of Purchase (PoP)
--------	-----	-----	-------	------------	-------------------------



XALD02



XAPA1100



XAPA1104



NEMA 1  
Surface Mounting  
9001BG\*\*



NEMA 1  
Flush Mounting  
9001BF\*\*



9001KYSS3



9001KY3



NEMA 4  
9001BW\*\*



NEMA 7 and 9  
9001BR\*\*



9001KYAF3



9001SKY2



Type of Product/ Material	XALD—Polycarbonate XALK—Polycarbonate	XAPA—glass filled polyester XAPG—die cast zinc XAPE—anodized aluminum	9001BG—plastic cover 9001BF—stainless steel 9001BW—die cast zinc 9001BR—cast aluminum	9001KYAF—sheet steel 9001KYSS—stainless steel 9001KY—die cast zinc 9001KZ—die cast zinc 9001SKY—Polyester	Push Buttons, Pendants, Tower lights, Relays
Number of holes	1 to 3	0 to 16	1 to 3	1 to 6	
Type of Operators	XB5 (22mm)	XB5 (22mm)	Built in	9001K/SK (30mm)	
Available without Operators	Yes	Yes	No	Yes	
Available with Operators	Yes	No	Yes	Yes	
Approvals	UL File E164353 CCN NKCR CSA File LR 44087 Class 3211-03	UL File E164353 CCN NKCR CSA File LR 44087 Class 3211-03	UL File E78403 CCN NKCR CSA File LR 25490 Class 3211-03	UL File E78403 CCN NKCR CSA File LR 25490 Class 3211-03	UL, CSA, CE, ROHS
Conforming to Standards	CE Marked	CE Marked	CE Marked	CE Marked	
	EN/IEC 60947-1, EN/IEC 60947-5-1, EN/IEC 60947-5-4,	EN/IEC 60947-1, EN/IEC 60947-5-1, EN/IEC 60947-5-4,	EN/IEC 60947-1, EN/IEC 60947-5-1, EN/IEC 60947-5-4,	EN/IEC 60947-1, EN/IEC 60947-5-1, EN/IEC 60947-5-4,	
	JIS C 4520	JIS C 4520	JIS C 4520	JIS C 4520	
	UL 508	UL 508	UL 508	UL 508	
Degree of Protection	1, 4, 4X, 13 IP65 IP66 - Booted	XAPA - 4, 4X, 12, IP65 XAPG - 4, 12, IP65 XAPE - 4, 4X, 12, IP65	9001BG - 1 9001BF - 1 9001BW - 4 9001BR - 7, 9	9001KYAF - 3, 13 9001KYSS - 3, 4, 4X, 13 9001KY - 3, 4, 13 9001KZ - 3, 13 9001SKY - 3, 4, 4X, 13	
	Operating Temperature F° (C°)	-13 to 158 (-25 to 70)	-13 to 158 (-25 to 70)		
Storage Temperature F° (C°)	-40 to 158 (-10 to 70)	-40 to 158 (-10 to 70)			
Cable Entry	No. 13 knock out	XAPA—undrilled XAPG—Tapped 3/4NPT XAPE—flush mount (n/a)	9001BG—1/2 & 3/4 knockout 9001BF—N/A 9001BW—1/2-14NPT 9001BR—1/2-14NPT	9001KYAF—customer provided 9001KYSS—G conduit hub 9001KY—customer provided 9001KZ—1/2 & 3/4 knockout 9001SKY—G conduit hub	
Digest Location	XAL, page 19-107	XAP, page 19-107	9001B, page 19-110	KY/SKY, page 19-112	PoP Products , page 19-114

**Tower Lights and Beacons Selection Guide (1 of 2)**

Family	XVB L	XVB C
--------	-------	-------



Type of Product	Beacon	Tower Light
Diameter	70mm	70mm
Features	Product for Customer Configuration	Product for Customer Configuration
Approvals	UL File E164353 CCN NKCR CSA File LR 44087 Class 3211 03	UL File E164353 CCN NKCR CSA File LR 44087 Class 3211 03
Conforming to Standards	CE Marked IEC/EN 60947-5-1 UL 508 CSA 22.2 No 14	CE Marked IEC/EN 60947-5-1 UL 508 CSA 22.2 No 14
Degree of Protection	IP65	IP65
Operating Temperature F° (C°)	-13 to 122 (-25 to 50)	-13 to 122 (-25 to 50)
Storage Temperature F° (C°)	-40 to 158 (-40 to 70)	-40 to 158 (-40 to 70)
Light Source	LED / Incandescent	LED / Incandescent
<b>Electrical Consumption</b>		
LED Steady	24 Vac/dc: < 30 mA 120-230 Vac: < 30 mA	24 Vac/dc: < 30 mA 120-230 Vac: < 30 mA
LED Flashing with Buzzer	24 Vac/dc: < 40 mA 120-230 Vac: < 15mA 1 Hz (1 flash per second)	24 Vac/dc: < 40 mA 120-230 Vac: < 15mA 1 Hz (1 flash per second)
Strobe (Energized)	24 Vdc: 5 Joules unit: < 430 mA; 10 J unit: < 850 mA 120 Vac: 5 Joules unit: < 130 mA; 10 J unit: < 260 mA 230 Vac: 5 Joules unit: < 105 mA; 10 J unit: < 210 mA 1 Hz (1 flash per second)	24 Vdc: 5 Joules unit: < 430 mA; 10 J unit: < 850 mA 120 Vac: 5 Joules unit: < 130 mA; 10 J unit: < 260 mA 230 Vac: 5 Joules unit: < 105 mA; 10 J unit: < 210 mA 1 Hz (1 flash per second)
Audible Sounders	12-48 Vac/dc: < 20 mA 120-230 Vac: < 50 mA 90 decibels at 1 meter	12-48 Vac/dc: < 20 mA 120-230 Vac: < 50 mA 90 decibels at 1 meter
Connection Type	Screw Clamp	Screw Clamp
Cable Size	1 x 16 AWG (1.5 mm <sup>2</sup> ) With Cable End	1 x 16 AWG (1.5 mm <sup>2</sup> ) With Cable End
Digest Location	XVB 70 mm Beacons, page 19-115	XVB 70 mm Components, page 19-116

Tower Lights and Beacons Selection Guide (2 of 2)



Family	XVC 4	XVC 6	XVC 1	XVU	XVGU	XVR	XVS
<b>Type of Product</b>	*Tower Light	*Tower Light	*Tower Light	**Tower Light	**Tower Light	***Rotating Mirror Beacon	***Siren and Electronic Alarm
<b>Diameter</b>	40 mm	60 mm	100 mm	60mm	60mm	84/106/120/130 mm	—
<b>Features</b>	All devices are pre-assembled and pre-wired			Programmable LED module with multiple colors, flashing, blinking, and rotating	Programmable with Magelis through USB	All devices are pre-assembled and pre-wired. XVR12***S includes buzzer: 70 to 90 decibels	Adjustable Tones XVS14BMW, 0 to 105 decibels, 43 tones XVS72BM**, 0 to 90 decibels, 16 tones
<b>Approvals</b>	UL Recognized E164353 CNN NKCR	UL Recognized E164353 CNN NKCR	UL Recognized E164353 CNN NKCR	UL file: E164353 CCN : NKCR	UL File E164353 CCN NKCR	UL Recognized E164353 CNN NKCR	UL Recognized E164353 GNN UCST
<b>Conforming to Standards</b>	CSA LR44087 Class 3211-03	CSA LR44087 Class 3211-03	CSA LR44087 Class 3211-03	CSA File : 225619 CLASS : 3211-07	cUL File: E164353 CCN: NKCR7	CSA LR44087 Class 3211-03	CSA LR44087 Class 3211-03
	CE Marked	CE Marked	CE Marked	CE Marked	CE Marked	CE Marked	CE Marked
	EN61000-6-2	EN61000-6-2	EN61000-6-2	EN 60947-1	EN 61000-6-2	EN61000-6-2	—
	EN61000-6-3	EN61000-6-3	EN61000-6-3	EN 60947-5-1	—	EN61000-6-4	—
	—	EN61000-6-4	EN61000-6-4	—	EN 61000-6-2	—	—
UL 508	UL 508	UL 508	UL508	UL508	UL 508	UL 508	
CSA 22.2 No. 14	CSA 22.2 No. 14	CSA 22.2 No. 14	CSA C22.2 No.14	CSA C22.2 No.14	CSA 22.2 No. 14	CSA 22.2 No. 14	
<b>Degree of Protection</b>	IP54	IP54	IP54	IP65	IP42	IP23 / IP65 / IP66	IP53 / IP54
<b>Operating Temperature F° (C°)</b>	-13 to 122 (-25 to 50)	-13 to 122 (-25 to 50)	-13 to 122 (-25 to 50)	-13 to 122 (-25 to 50)	32 to 131 (0 to 55)	-14 to 122 (-10 to 50)	-4 to 122 (-20 to 50)
<b>Storage Temperature F° (C°)</b>	-40 to 158 (-40 to 70)	-40 to 158 (-40 to 70)	-40 to 158 (-40 to 70)	-13 to 150 (-25 to 65)	-31 to 158 (-35 to 70)	-31 to 158 (-35 to 70)	-31 to 158 (-35 to 70)
<b>Light Source</b>	LED	LED	LED	LED	LED	LED	—
<b>Electrical Consumption</b>				Body unit ≤ 400mA	400mA		
<b>LED Steady</b>	24 V: 1 unit = 40mA; 2 unit = 80mA; 3 unit = 120mA; 4 unit = 160mA; 5 unit = 200mA		24 V: 1 unit = 100mA; 2 unit = 200mA; 3 unit = 300mA; 4 unit = 400mA; 5 unit = 500mA	LED Units ≤ 50 mA	Programmable with Magelis through USB	XVR08, XVR10, XVR12, and XVR13 (without buzzer) 12 Vac/dc: 360mA 24 Vac/dc: 180mA	—
<b>LED Flashing ** with Buzzer</b>	**24 V: 1 unit = 90 mA; 2 unit = 130 mA; 3 unit = 170 mA; 4 unit = 210 mA; 5 unit = 250 mA 0.7 to 3 Hz (1 flash per 0.7 to 3 sec)		24 V: 1 unit = 150mA; 2 unit = 250mA; 3 unit = 350mA; 4 unit = 450mA; 5 unit = 550mA 3 to 3.5 Hz (1 flash per 3 to 3.5 sec)	Buzzer ≤ 70 mA Flasher and multi-color ≤ 70 mA	Programmable with Magelis through USB	XVR12 with buzzer: 12 Vac/dc: 400 mA 24 Vac/dc: 230 mA 3 Hz (1 flash per 3 sec)	—
<b>Strobe (Energized)</b>	—	—	—	—	—	—	—
<b>Audible Sounders</b>	70 to 85 decibels at 1 meter	70 to 85 decibels at 1 meter	60 to 85 decibels at 1 meter	—	—	—	XVS14BMW 12 Vdc: 350mA 24 Vdc: 400 mA 105 decibels at 1 m  XVS72BM 12 Vdc: 280 mA 24 Vdc: 190 mA 90 decibels at 1 m
<b>Connection Type</b>	Pre-Wired, Color-Coded Wires <b>cable length:</b> 600mm XVC4** 900mm XVC4**K 500mm XVC4**5S	Pre-Wired, Color-Coded Wires <b>cable length:</b> 600mm XVC6** 850mm XVC6**K 550mm XVC6**5S 850mm XVC6**5SK	Pre-Wired, Color-Coded Wires <b>cable length:</b> 500mm XVC1**K 500mm XVC1**SK 550mm XVC6**5S 850mm XVC6**5SK	Screw Clamp	USB power cable: - 300 mm/ 11.81 in. for tube mounting - 400 mm/ 15.75 in. for direct mounting	Pre-Wired cable length: 500mm XVR08** 400mm XVR10** 400mm XVR12** 400mm XVR13**	XVS14BMW Pre-Wired, Color-Coded Wires <b>cable length:</b> 500mm XVS14  XVS72BM** Not Pre-Wired
<b>Cable Size</b>	22 AWG (0.33 mm <sup>2</sup> )	22 AWG (0.33 mm <sup>2</sup> )	22 AWG (0.33 mm <sup>2</sup> )	22 - 16 AWG	—	18 AWG (0.75 mm <sup>2</sup> )	—
<b>Digest Location</b>	XVC, page 19-118	XVC, page 19-118	XVC, page 19-118	XVU, page	XVGU, page 19-124	XVR, page 19-125	XVS, page 19-126

For Tower Lights catalog numbers:  
● first dot denotes voltage selection  
○ second dot denotes color selection

**Pendant Station Selection Guide**

Family	XAR eXL Hoist	9001BW	XACA2	XACA0	9001SKYP
--------	---------------	--------	-------	-------	----------







Type of Product	*Wireless Pendant	**2-Button Pendant	**2-Button Pistol Grip Pendant	**General Purpose Pendant	**Heavy Duty Pendant
Number of operators	6	2	2	2, 3, 4, 6, 8, 12	2, 4, 6, 8, 10
Approvals	UL File E164353, CCN NKCR/NKR7 (cULus) CSA File LR44087 Class 3211-07	UL File E78403 CNN NKCR CSA File LR25490 Class 3211-03	UL File E164353 CNN NKCR CSA File LR 44087 Class 3211-03	UL File E164353 CNN NKCR CSA File LR 44087 Class 3211-03	UL File E78403 CNN NKCR CSA File LR25490 Class 3211-03
Conforming to Standards	EN/IEC 60947-5-1, EN/IEC 60204-32, UL 508, CSA 22-2 No. 14 and EN/ISO 13849-1, EN/IEC 62061, EN/IEC 61508, EN/ISO 13850 EN 13557, EN 15011 UL, CSA, CE, CCC RoHS Compliant	CE Marked	EN/IEC 60947-5-1, EN/IEC 60204-32, EN/IEC 60947-5-5, and EN/ISO 13850 (for versions with trigger action emergency stop) UL 508 CSA C22-2 No. 14 RoHS compliant	EN/IEC 60947-5-1, EN/IEC 60204-32, EN/IEC 60947-5-5, and EN/ISO 13850 (for versions with trigger action emergency stop) UL 508 CSA C22-2 No. 14 RoHS compliant	CE Marked
Degree of Protection	IP65, NEMA 4	NEMA 1, 3, 3R, 4, 4X	NEMA 1, 4, 4X, 5 IP65 IK08	NEMA 1, 4, 4X, 5 IP65 IK08	NEMA 1, 2, 3, 4, 4X, 12, 13
Operating Temperature F° (C°)	-4 to 140 (-20 to 60)	-13 to 140 (-25 to 60)	-13 to 140 (-25 to 60)	-13 to 140 (-25 to 60)	-13 to 140 (-25 to 60)
Storage Temperature F° (C°)	-4 to 140 (-20 to 60)	-40 to 158 (-40 to 70)	-40 to 158 (-40 to 70)	-40 to 158 (-40 to 70)	-40 to 158 (-40 to 70)
Housing Material	Polycarbonate (PBT)	Polycarbonate / PET Polyester Blend	Yellow Polypropylene	Yellow Polypropylene	Yellow Polycarbonate
Rated Operational Characteristics [1]	ZBRH●H AC - C300 ZBRH●W AC - B300 DC - R300	AC - B600  DC - P600	AC-15: A600 or Ue = 600V, Ie = 1.2A or Ue = 240V, Ie = 3A  DC-13: Q600 or Ue = 600V, Ie = 0.1A or Ue = 250V, Ie = 0.27A	AC-15: A600 or Ue = 600V, Ie = 1.2A or Ue = 240V, Ie = 3A  DC-13: Q600 or Ue = 600V, Ie = 0.1A or Ue = 250V, Ie = 0.27A	SKRU2-SKRU5 AC - B300 DC - P600  SKRU1, 10, 11 AC - A600 DC - P600
Thermal Current	ZBRH●H - 4A ZBRH●W - 6A	Continuous 5A	Continuous 10A	Continuous 10A	—
Connection Type	—	1/2 in. NPT screw clamp terminals	8–26 mm cable entry screw clamp terminals	8–26 mm cable entry screw clamp terminals	NPT threaded conduit entry screw clamp terminals
Cable Size	None: Wireless	—	1 x 0.5 mm <sup>2</sup> (20AWG) min. 2 x 1.5 mm <sup>2</sup> (16AWG) max. 1 x 2.5 mm <sup>2</sup> (14AWG) max.	1 x 14 AWG (copper only)	—
Digest Location	XAR, page	Type BW, page 19-132	XAC, page 19-133	XAC, page 19-133	SKYP, page 19-136





[1] OSHA Section 1910.179, *Overhead and Gantry Cranes*, limits voltage at pendant push buttons to 150 Vac or 300 Vdc max.

**XB4–XB5 Common Operators**





**Table 19.1: BLACK—Start Push Buttons (flush head)**

Operator Style	Description	Contact Block	Type	Legend Plate
XB4 Die Cast Chrome		 1 N.O.	XB4BA21	ZBY2303
XB5 Double Insulated		 1 N.O.	XB5AA21	ZBY2303





**Table 19.2: RED—Stop Push Buttons (extended head)**

Operator Style	Description	Contact Block	Type	Legend Plate
XB4 Die Cast Chrome		 1 N.C.	XB4BL42	ZBY2304
XB5 Double Insulated		 1 N.C.	XB5AL42	ZBY2304



**Table 19.3: BLACK—Off-On Selector Switch**

Operator Style	Description	Contact Block	Type	Legend Plate
XB4 Die Cast Chrome		 1 N.O.	XB4BD21	ZBY2367
XB5 Double Insulated		 1 N.O.	XB5AD21	ZBY2367



**Table 19.4: Hand-Off-Auto Selector Switch**

Operator Style	Description	Contact Block	Type	Legend Plate
XB4 Die Cast Chrome		 2 N.O.	XB4BD33	ZBY2387
XB5 Double Insulated		 2 N.O.	XB5AD33	ZBY2387





**Table 19.5: RED—120 Vac LED—On Pilot Light**

Operator Style	Description	Contact Block	Type	Legend Plate
XB4 Die Cast Chrome		120 Vac Red LED	XB4BVG4	ZBY2311
XB5 Double Insulated		120 Vac Red LED	XB5AVG4	ZBY2311





**Table 19.6: GREEN—120 Vac LED—Off Pilot Light**

Operator Style	Description	Contact Block	Type	Legend Plate
XB4 Die Cast Chrome		120 Vac Green LED	XB4BVG3	ZBY2312
XB5 Double Insulated		120 Vac Green LED	XB5AVG3	ZBY2312

**Table 19.7: RED—40 mm Mushroom Stop (Push-Pull)**

Operator Style	Description	Contact Block	Type	Legend Plate
XB4 Die Cast Chrome		 1 N.C.	XB4BT42	ZBY9320
XB5 Double Insulated		 1 N.C.	XB5AT42	ZBY9320

**Table 19.8: RED—40 mm Mushroom Emergency Stop (Trigger Action, Turn-to-Release)**

Operator Style	Description	Contact Block	Type	Legend Plate 60 mm Round
XB4 Die Cast Chrome		 1 N.O. / 1 N.C.	XB4BS8445	ZBY9320
XB5 Double Insulated		 1 N.O. / 1 N.C.	XB5AS8445	ZBY9320





**When ordering, please specify:**

Quantity  
Type or Catalog Number







**Type K and SK Common Operators**



**Table 19.9: BLACK—Start Push Buttons**

Operator Style	Description	Contact Block	Type [1]	Legend Plate [1]
30 mm Industrial (Metal)			KR1BH13	KN201
30 mm Corrosion Resistant (Non-Metallic)			SKR1BH13	KN101SP



**Table 19.10: RED—Stop Push Buttons**

Operator Style	Description	Contact Block	Type [1]	Legend Plate [1]
30 mm Industrial (Metal)			KR1RH13	KN202
30 mm Corrosion Resistant (Non-Metallic)			SKR1RH13	KN102RP



**Table 19.11: BLACK—Off-On Selector Switch**

Operator Style	Description	Contact Sequence (Contact Block Included)	Type [1]	Legend Plate [1]
30 mm Industrial (Metal)			KS11BH13	KN244
30 mm Corrosion Resistant (Non-Metallic)			SKS11BH13	KN144SP

**Table 19.12: BLACK—Hand-Off-Auto Selector Switch**

Operator Style	Description	Contact Sequence (Contact Block Included)	Type [1]	Legend Plate [1]
30 mm Industrial (Metal)			KS43BH13	KN260
30 mm Corrosion Resistant (Non-Metallic)			SKS43BH13	KN160SP



**Table 19.13: RED—120 Vac—On Pilot Light**

Operator Style	Description	Type [1]	Legend Plate [1]
30 mm Industrial (Metal)		KP1R31	KN203
30 mm Corrosion Resistant (Non-Metallic)		SKP1R31	KN103SP



**Table 19.14: GREEN—120 Vac—Off Pilot Light**

Operator Style	Description	Type [1]	Legend Plate [1]
30 mm Industrial (Metal)		KP1G31	KN204
30 mm Corrosion Resistant (Non-Metallic)		SKP1G31	KN104SP

**Table 19.15: RED—120 Vac—On Push-To-Test Pilot Light**

Operator Style	Description	Type [1]	Legend Plate [1]
30 mm Industrial (Metal)		KT1R31	KN203
30 mm Corrosion Resistant (Non-Metallic)		SKT1R31	KN103SP

**Table 19.16: GREEN—120 Vac—Off Push-To-Test Pilot Light**

Operator Style	Description	Type [1]	Legend Plate [1]
30 mm Industrial (Metal)		KT1G31	KN204
30 mm Corrosion Resistant (Non-Metallic)		SKT1G31	KN104RP

**When ordering, please specify:**

Quantity  
Class Number (if appropriate)  
Type or Catalog Number

[1] When ordering, add prefix 9001 to the catalog number.

**XVL Miniature LED**

**Table 19.17: Specifications**

Conforming to standards	IEC 337-2, NF C 63-140, VDE 0660-200
Degree of protection	IP40 (IP65 with seal) conforming to IEC 529 and NF C 20-010
Current consumption	25 mA
Cabling	XVLA1●●, XVLA2●●: tags for 2.8 x 0.5 mm Faston connectors, also for soldered connections. XVLA3●●: threaded connectors, clamping, capacity: min. 1 x 0.2 mm <sup>2</sup> , max. 1 x 1.5 mm <sup>2</sup>



XVLA1●●



XVLA2●●



XVLA3●●

**Table 19.18: With Black Bezel, Raised LED**

Description	Supply Voltage DC	Color	Catalog Number
Ø 8 mm [1] with integral ballast resistor and reverse polarity protection diode Degree of protection IP40 LED pilot lights Ø 8 mm, with black bezel, visible LED XVLA1●●	12 V	Green	XVLA123
		Red	XVLA124
		Amber	XVLA125
	24 V	Green	XVLA133
		Red	XVLA134
		Amber	XVLA135

**Table 19.19: With Integral Lens Cap, Covered LED**

Description	Supply Voltage DC	Color	Catalog Number
Ø 8 mm [1] with integral ballast resistor and reverse polarity protection diode Degree of protection IP40 Ø 8 mm, with lens incorporated, LED XVLA2	12 V	Green	XVLA223
		Red	XVLA224
		Amber	XVLA225
	24 V	Green	XVLA233
		Red	XVLA234
		Amber	XVLA235
Ø 12 mm [2] with integral ballast resistor and reverse polarity protection diode Degree of protection IP40 Ø 12 mm, with lens incorporated, LED XVLA3	12 V	Green	XVLA323
		Red	XVLA324
		Amber	XVLA325
	24 V	Green	XVLA333
		Red	XVLA334
		Amber	XVLA335

**Table 19.20: Accessories**

Description	Catalog Number	
Tightening tools (Sold singly)	For Ø 8 mm pilot lights	XVLX08
	For Ø 12 mm pilot lights	XVLX12
Seals (IP65) (Sold in lots of 10)	For Ø 8 mm pilot lights	XVLZ911
	For Ø 12 mm pilot lights	XVLZ912

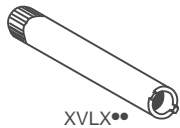

XVLX●●



XVLZ91●

[1] Quick connects (2.8 x 0.5 mm).

[2] Screw termination.



Type JP1R29

### Standard, Push-To-Test, and Remote Test Pilot Lights

Class 9001 Type J compact pilot lights are designed to be mounted in a 0.69 in. (11/16 in. or 17.5 mm) diameter mounting hole. Each terminal accepts up to two 14 AWG wires (CU only). Type J compact pilot lights meet NEMA 4 (watertight) and NEMA 13 (oiltight). Type JT push-to-test pilot lights have contacts built into the encapsulated body. Type JTR remote test pilot lights have dual inputs for one push remote testing—all you need is a push button with a current rating equal to or greater than the total lamp draw. Type JTR remote test pilot lights can also be energized from two separate input signals of the same voltage and polarity. This is done by wiring the Test terminal to the second input signal.

Table 19.21: Standard Pilot Light [3]

Style/Voltage	Color Cap[4]				Lamp	Replacement Lamp
	None	Red	Green	Yellow		
Transformer, 110–120 V, 50–60 Hz	JP1	JP1R29	JP1G29	JP1Y29	6.3 V, 0.15 A	2550101020
Incandescent, 120 Vac/Vdc	JP38	JP38R29	JP38G29	JP38Y29	120 V, 0.015 A	2550101040
Incandescent, 24–28 Vac/Vdc	JP35	JP35R29	JP35G29	JP35Y29	28 V, 0.040 A	2550101024
LED, 24–28 Vac	—	JP35LRR29	JP35LGG29	JP35LYY29	28 V, 0.03 A	—
LED, 24–28 Vdc	—	JP35DRR29	JP35DGG29	JP35DYY29	28 V, 0.03 A	—
LED, 120 Vac	—	JP38LRR29	JP38LGG29	JP38LYY29	28 V, 0.03 A	—
Replacement LED, 120 Vac	Red	—	—	—	—	6508805207
	Yellow	—	—	—	—	6508805208
	Green	—	—	—	—	6508805209



Table 19.22: Push-To-Test Pilot Light [3]

Style/Voltage	Color Cap[4]				Lamp	Replacement Lamp
	None	Red	Green	Yellow		
Transformer, 110–120 V, 50–60 Hz	JT1	JT1R29	JT1G29	JT1Y29	6.3 V, 0.15 A	2550101020
Incandescent, 120 Vac/Vdc	JT38	JT38R29	JT38G29	JT38Y29	120 V, 0.015 A	2550101040
Incandescent, 24–28 Vac/Vdc	JT35	JT35R29	JT35G29	JT35Y29	28 V, 0.040 A	2550101024
LED, 24–28 Vac	—	JT35LRR29	JT35LGG29	JT35LYY29	28 V, 0.03 A	—
LED, 24–28 Vdc	—	JT35DRR29	JT35DGG29	JT35DYY29	28 V, 0.03 A	—
LED, 120 Vac	—	JT38LRR29	JT38LGG29	JT38LYY29	28 V, 0.03 A	—
Replacement LED, 120 Vac	Red	—	—	—	—	6508805207
	Yellow	—	—	—	—	6508805208
	Green	—	—	—	—	6508805209

Table 19.23: Color Caps, Class 9001 Type J

Color	Replacement Color Caps
	Plastic[4]
Red	R29
Green	G29
Amber	A29
Blue	L29
White	W29
Yellow	Y29

Table 19.24: Legend Plates

Description	Maximum Number of Lines	Maximum Number of Characters	Catalog Number[4]
	Blank	Black Field Red Field	JN100 JN100R
	Special Marking (Specify Marking)	Black Field Red Field	JN199 JN199R
	Blank	Aluminum Field	JN700
	Special Marking (Specify Marking)	Aluminum Field	JN799

[3] Other voltages are available. Refer to Catalog 9001CT0001.

[4] When ordering, add prefix 9001 to the catalog number.

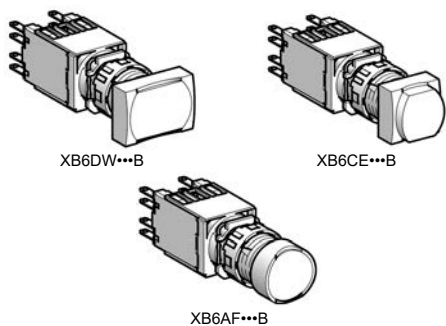

**XB6 Complete Devices**

**Table 19.25: Illuminated Push Buttons (12–24 Vac/Vdc LED included)**  
Complete Units with Quick Connectors/Solder Tabs

Type of Operator	Type of Contact		Color	Rectangular	Square	Round
	N.O.	N.C.		Catalog Number		
Flush, spring return	1	—	White	XB6DW1B1B	XB6CW1B1B	XB6AW1B1B
			Green	XB6DW3B1B	XB6CW3B1B	XB6AW3B1B
			Yellow	XB6DW5B1B	XB6CW5B1B	XB6AW5B1B
			Blue	XB6DW6B1B	XB6CW6B1B	XB6AW6B1B
	—	1	Red	XB6DW4B2B	XB6CW4B2B	XB6AW4B2B
			White	XB6DW1B5B	XB6CW1B5B	XB6AW1B5B
			Green	XB6DW3B5B	XB6CW3B5B	XB6AW3B5B
			Red	XB6DW4B5B	XB6CW4B5B	XB6AW4B5B
	1	1	Yellow	XB6DW5B5B	XB6CW5B5B	XB6AW5B5B
			Blue	XB6DW6B5B	XB6CW6B5B	XB6AW6B5B
			White	XB6DF1B1B	XB6CF1B1B	XB6AF1B1B
			Green	XB6DF3B1B	XB6CF3B1B	XB6AF3B1B
Flush, maintained	1	—	Yellow	XB6DF5B1B	XB6CF5B1B	XB6AF5B1B
			Blue	XB6DF6B1B	XB6CF6B1B	XB6AF6B1B
			Red	XB6DF4B2B	XB6CF4B2B	XB6AF4B2B
			White	XB6DF1B5B	XB6CF1B5B	XB6AF1B5B
	—	1	Green	XB6DF3B5B	XB6CF3B5B	XB6AF3B5B
			Red	XB6DF4B5B	XB6CF4B5B	XB6AF4B5B
			Yellow	XB6DF5B5B	XB6CF5B5B	XB6AF5B5B
			Blue	XB6DF6B5B	XB6CF6B5B	XB6AF6B5B
	1	1	White	XB6DE1B1B	XB6CE1B1B	XB6AE1B1B
			Green	XB6DE3B1B	XB6CE3B1B	XB6AE3B1B
			Yellow	XB6DE5B1B	XB6CE5B1B	XB6AE5B1B
			Blue	XB6DE6B1B	XB6CE6B1B	XB6AE6B1B
—	1	Red	XB6DE4B2B	XB6CE4B2B	XB6AE4B2B	
		White	XB6DE1B5B	XB6CE1B5B	XB6AE1B5B	
		Green	XB6DE3B5B	XB6CE3B5B	XB6AE3B5B	
		Red	XB6DE4B5B	XB6CE4B5B	XB6AE4B5B	
1	1	Yellow	XB6DE5B5B	XB6CE5B5B	XB6AE5B5B	
		Blue	XB6DE6B5B	XB6CE6B5B	XB6AE6B5B	

**Table 19.26: Illuminated Push Buttons (120 Vac LED included)**  
Complete Units with Quick Connectors/Solder Tabs

Type of Operator	Type of Contact		Color	Rectangular	Square	Round
	N.O.	N.C.		Catalog Number		
Flush, spring return	1	—	White	XB6DW1G1B	XB6CW1G1B	XB6AW1G1B
			Green	XB6DW3G1B	XB6CW3G1B	XB6AW3G1B
			Yellow	XB6DW5G1B	XB6CW5G1B	XB6AW5G1B
			Blue	XB6DW6G1B	XB6CW6G1B	XB6AW6G1B
	—	1	Red	XB6DW4G2B	XB6CW4G2B	XB6AW4G2B
			White	XB6DW1G5B	XB6CW1G5B	XB6AW1G5B
			Green	XB6DW3G5B	XB6CW3G5B	XB6AW3G5B
			Red	XB6DW4G5B	XB6CW4G5B	XB6AW4G5B
	1	1	Yellow	XB6DW5G5B	XB6CW5G5B	XB6AW5G5B
			Blue	XB6DW6G5B	XB6CW6G5B	XB6AW6G5B
			White	XB6DF1G1B	XB6CF1G1B	XB6AF1G1B
			Green	XB6DF3G1B	XB6CF3G1B	XB6AF3G1B
Flush, maintained	1	—	Yellow	XB6DF5G1B	XB6CF5G1B	XB6AF5G1B
			Blue	XB6DF6G1B	XB6CF6G1B	XB6AF6G1B
			Red	XB6DF4G2B	XB6CF4G2B	XB6AF4G2B
			White	XB6DF1G5B	XB6CF1G5B	XB6AF1G5B
	—	1	Green	XB6DF3G5B	XB6CF3G5B	XB6AF3G5B
			Red	XB6DF4G5B	XB6CF4G5B	XB6AF4G5B
			Yellow	XB6DF5G5B	XB6CF5G5B	XB6AF5G5B
			Blue	XB6DF6G5B	XB6CF6G5B	XB6AF6G5B
	1	1	White	XB6DE1G1B	XB6CE1G1B	XB6AE1G1B
			Green	XB6DE3G1B	XB6CE3G1B	XB6AE3G1B
			Yellow	XB6DE5G1B	XB6CE5G1B	XB6AE5G1B
			Blue	XB6DE6G1B	XB6CE6G1B	XB6AE6G1B
—	1	Red	XB6DE4G2B	XB6CE4G2B	XB6AE4G2B	
		White	XB6DE1G5B	XB6CE1G5B	XB6AE1G5B	
		Green	XB6DE3G5B	XB6CE3G5B	XB6AE3G5B	
		Red	XB6DE4G5B	XB6CE4G5B	XB6AE4G5B	
1	1	Yellow	XB6DE5G5B	XB6CE5G5B	XB6AE5G5B	
		Blue	XB6DE6G5B	XB6CE6G5B	XB6AE6G5B	

For Legends, see [XB6 Legend Plates and Legends](#), page 19-20

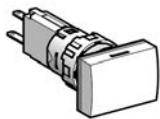

XB6DV\*\*B

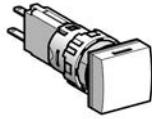

XB6CV\*\*B

**Table 19.27: Pilot Lights (12–24 Vac/Vdc LED included)**  
**Complete Units with Quick Connectors/Solder Tabs**

Color	Rectangular	Square	Round
	Catalog Number		
White	XB6DV1BB	XB6CV1BB	XB6AV1BB
Green	XB6DV3BB	XB6CV3BB	XB6AV3BB
Red	XB6DV4BB	XB6CV4BB	XB6AV4BB
Yellow	XB6DV5BB	XB6CV5BB	XB6AV5BB
Blue	XB6DV6BB	XB6CV6BB	XB6AV6BB

**Table 19.28: Pilot Lights (120 Vac LED)**  
**Complete Units with Quick Connectors/Solder Tabs**

Color	Rectangular	Square	Round
	Catalog Number		
White	XB6DV1GB	XB6CV1GB	XB6AV1GB
Green	XB6DV3GB	XB6CV3GB	XB6AV3GB
Red	XB6DV4GB	XB6CV4GB	XB6AV4GB
Yellow	XB6DV5GB	XB6CV5GB	XB6AV5GB
Blue	XB6DV6GB	XB6CV6GB	XB6AV6GB



XB6AV\*\*B

**Table 19.29: Push Buttons (Non-Illuminated)**  
**Complete Units with Quick Connectors/Solder Tabs**

Type of Push	Type of Contact		Color	Rectangular	Square	Round
	N.O.	N.C.		Catalog Number		
Flush, spring return	1	—	White	XB6DA11B	XB6CA11B	XB6AA11B
			Black	XB6DA21B	XB6CA21B	XB6AA21B
			Green	XB6DA31B	XB6CA31B	XB6AA31B
			Yellow	XB6DA51B	XB6CA51B	XB6AA51B
			Blue	XB6DA61B	XB6CA61B	XB6AA61B
			Black	XB6DA22B	XB6CA22B	XB6AA22B
	—	1	Red	XB6DA42B	XB6CA42B	XB6AA42B
			White	XB6DA15B	XB6CA15B	XB6AA15B
			Black	XB6DA25B	XB6CA25B	XB6AA25B
			Green	XB6DA35B	XB6CA35B	XB6AA35B
			Red	XB6DA45B	XB6CA45B	XB6AA45B
			Yellow	XB6DA55B	XB6CA55B	XB6AA55B
1	1	Blue	XB6DA65B	XB6CA65B	XB6AA65B	

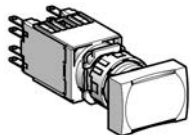

XB6DA\*\*B

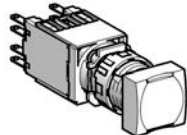

XB6CA\*\*B

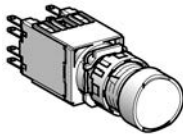

XB6AA\*\*B

**Table 19.30: Trigger Action Emergency Stop Mushroom Head Push Buttons (Color Red) [1]**

Shape of Head	Type of Push	Type of Contact		Diameter of Head (mm)	Catalog Number
		N.O.	N.C.		
Turn-to-release	—	—	1	30	XB6AS8342B
		1	1	30	XB6AS8345B
Key release	—	—	1	30	XB6AS9342B [2]
		1	1	30	XB6AS9345B [2]

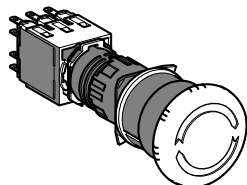

XB6AS8345B

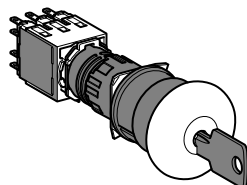

XB6AS9345B



ZB6Y7330

**Table 19.31: Circular Legends, 45 mm**

Description	Color	Text	Catalog Number
Circular legends, 45 mm	Yellow	Blank	ZB6Y7001
		Emergency stop	ZB6Y7330

For Legends, see [XB6 Legend Plates and Legends](#), page 19-20

[1] Complies with ISO 13850 standards for Emergency Stop push buttons when used with circular Legend Plate ZB6Y7330 (see [Table 19.31 Circular Legends, 45 mm](#), page 19-13)  
[2] Ronis 200 key

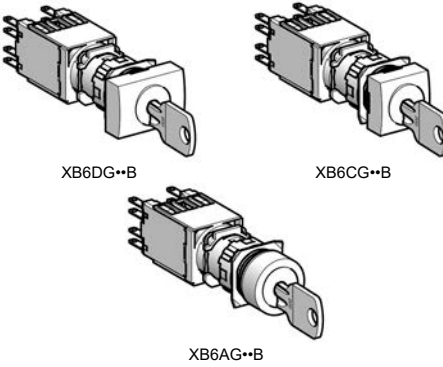
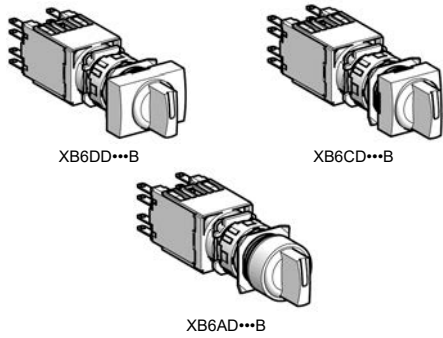

Table 19.32: Selector Switches (Switching Angle: Handle: 60°) Complete Units with Quick Connectors/Solder Tabs

Type of Operator	Type of Contact		Number and Type of Positions	Rectangular	Square	Round	
	N.O.	N.C.		Catalog Number			
Handle	1	—	2-maintained		XB6DD221B	XB6CD221B	XB6AD221B
	1	1	2-maintained		XB6DD225B	XB6CD225B	XB6AD225B
			3-maintained		XB6DD235B	XB6CD235B	XB6AD235B
	2	—	3-maintained		XB6DD233B	XB6CD233B	XB6AD233B

Table 19.33: Selector Switches (Switching Angle: Key: 70°) Complete Units with Quick Connectors/Solder Tabs

Type of Operator	Type of Contact		Number and Type of Positions	Rectangular	Square	Round	
	N.O.	N.C.		Catalog Number			
Key	1	1	2-maintained		XB6DGC5B	XB6CGC5B	XB6AGC5B
			2-maintained		XB6DGB5B	XB6CGB5B	XB6AGB5B
			3-maintained		XB6DGH5B	XB6CGH5B	XB6AGH5B
	2	—	3-maintained		XB6DGH3B	XB6CGH3B	XB6AGH3B

NOTE: The symbol indicates key withdrawal position(s).

Table 19.34: Selector Switch Sequence

2 Position Selector Switch			Contact block guide [3]
O	X		1 N.O. (left or right)
X	O		1 N.C. (left or right)
O	X		1 N.O.
			and
X	O		1 N.C.

3 Position Selector Switch			Contact block guide [3]
O	O	X	1 N.O. (left)
X	O	X	2 N.O. wired in parallel (side by side)
X	O	O	1 N.O. (right)
O	X	X	1 N.C. (right)
X	X	O	1 N.C. (left)
O	X	O	2 N.C. wired in series (side by side)

For Legends, see Legend Plates and Legends , page 19-20

[3] As viewed from the front of the panel.

**XB6 Electrical Components**

**Table 19.35: Contact Blocks and Light Modules for Illuminated Push Buttons [4]**

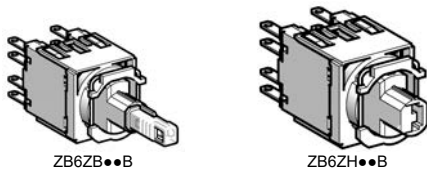

Description	Supply Voltage	Type of Contact		Color of Light Source	Catalog Number		
		N.O.	N.C.				
<b>Quick connectors/solder tabs</b>							
Integral LED [5]	12–24 Vac/Vdc	1	—	White	ZB6ZB11B		
				Green	ZB6ZB31B		
				Yellow	ZB6ZB51B		
				Blue	ZB6ZB61B		
				Red	ZB6ZB42B		
		—	1	—	Yellow	ZB6ZB52B	
					White	ZB6ZB15B	
					Green	ZB6ZB35B	
					Red	ZB6ZB45B	
					Yellow	ZB6ZB55B	
	120 Vac	1	—	Blue	ZB6ZB65B		
				White	ZB6ZG11B		
				Green	ZB6ZG31B		
				Yellow	ZB6ZG51B		
				Blue	ZB6ZG61B		
		—	1	—	Red	ZB6ZG42B	
					Yellow	ZB6ZG52B	
					White	ZB6ZG15B	
					Green	ZB6ZG35B	
					Red	ZB6ZG45B	
1	1	—	Yellow	ZB6ZG55B			
			Blue	ZB6ZG65B			
			—	—			
			—	—			
			—	—			
Direct for incandescent bulb (not included) [6]	< 24 Vac/Vdc	1	—	—	ZB6ZH01B		
				—	1	—	ZB6ZH02B
				1	1	—	ZB6ZH05B

**Table 19.36: Contact Blocks for Push Buttons and Selector Switches**

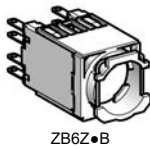

Description	Type of Contact		Catalog Number
	N.O.	N.C.	
<b>Quick connectors/solder tabs</b>			
Contact blocks with mounting base	1	—	ZB6Z1B
	—	1	ZB6Z2B
	2	—	ZB6Z3B
	—	2	ZB6Z4B
	1	1	ZB6Z5B

**Table 19.37: Light Modules for Pilot Lights**



Description	Supply Voltage	Color of Light Source	Catalog Number
<b>Quick connectors/solder tabs [7]</b>			
Integral LED [8]	12–24 Vac/Vdc	White	ZB6EB1B
		Green	ZB6EB3B
		Red	ZB6EB4B
		Yellow	ZB6EB5B
		Blue	ZB6EB6B
	120 Vac	White	ZB6EG1B
		Green	ZB6EG3B
		Red	ZB6EG4B
		Yellow	ZB6EG5B
		Blue	ZB6EG6B
With resistor for 95 V neon bulb (not included) [6] [9]	110 Vac	—	ZB6EG0B
	230 Vac	—	ZB6EM0B
Direct supply for 0.6 W max. incandescent bulb (not included) [6]	< 24 Vac/Vdc	—	ZB6EH0B

**Table 19.38: Separate Contact Blocks (Maximum of 3 contacts per mounting base.)**

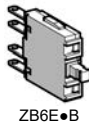

Contact Material	For use with mounting base	Type of Contact		Catalog Number
		N.O.	N.C.	
Silver alloy	Quick connectors/solder tabs	1	—	ZB6E1B
		—	1	ZB6E2B
Gold flashed	Quick connectors/solder tabs	1	—	ZB6E1E
		—	1	ZB6E2E

**Table 19.39: Accessories for Printed Circuit Board Installations**

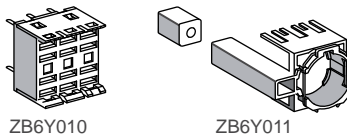

Description	for use with	Catalog Number
Plug-in Socket Adapter	contact blocks and light modules	ZB6Y010
Body Bracket	plug-in socket adapter	ZB6Y011

[4] Illuminated selector switches can be assembled by using a contact block/light module assembly in conjunction with a selector switch head, supplied without handle, and a transparent handle. See [XB6 Illuminated Operators](#), page 19-16.  
 [5] The LED must be the same color as the push button cap.  
 [6] Order bulbs separately. See [Additional XB6 Accessories](#), page 19-20.  
 [7] Electrical components with connection by printed circuit board pins are available. See [Additional XB6 Accessories](#), page 19-20.  
 [8] The LED must be the same color as the lens.  
 [9] Neon bulb can only be used with a red, yellow, or white cap.

**XB6 Illuminated Operators**

**Table 19.40: Heads for Illuminated Push Buttons [10]**

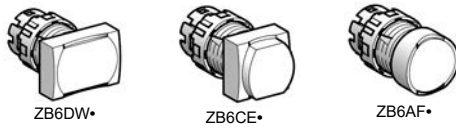

Type of Push	Color	Rectangular	Square	Round
		Catalog Number		
Flush, spring return	White	ZB6DW1	ZB6CW1	ZB6AW1
	Green	ZB6DW3	ZB6CW3	ZB6AW3
	Red	ZB6DW4	ZB6CW4	ZB6AW4
	Yellow	ZB6DW5	ZB6CW5	ZB6AW5
	Blue	ZB6DW6	ZB6CW6	ZB6AW6
	5 colors [11]	ZB6DW9	ZB6CW9	ZB6AW9
Flush, maintained	White	ZB6DF1	ZB6CF1	ZB6AF1
	Green	ZB6DF3	ZB6CF3	ZB6AF3
	Red	ZB6DF4	ZB6CF4	ZB6AF4
	Yellow	ZB6DF5	ZB6CF5	ZB6AF5
	Blue	ZB6DF6	ZB6CF6	ZB6AF6
	5 colors [11]	ZB6DF9	ZB6CF9	ZB6AF9
Extended, spring return	White	ZB6DE1	ZB6CE1	ZB6AE1
	Green	ZB6DE3	ZB6CE3	ZB6AE3
	Red	ZB6DE4	ZB6CE4	ZB6AE4
	Yellow	ZB6DE5	ZB6CE5	ZB6AE5
	Blue	ZB6DE6	ZB6CE6	ZB6AE6
	5 colors [11]	ZB6DE9	ZB6CE9	ZB6AE9

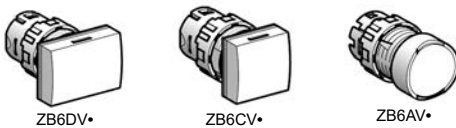

**Table 19.41: Heads for Pilot Lights [10]**

Color	Rectangular	Square	Round
	Catalog Number		
White	ZB6DV1	ZB6CV1	ZB6AV1
Green	ZB6DV3	ZB6CV3	ZB6AV3
Red	ZB6DV4	ZB6CV4	ZB6AV4
Yellow	ZB6DV5	ZB6CV5	ZB6AV5
Blue	ZB6DV6	ZB6CV6	ZB6AV6
5 colors [11]	ZB6DV9	ZB6CV9	ZB6AV9

For legends, see [Legend Plates and Legends](#), page 19-20

**XB6 Non-Illuminated Operators**

**Table 19.42: Heads for Push Buttons [12]**

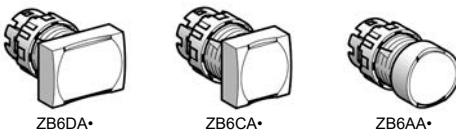

Type of Push	Color	Rectangular	Square	Round
		Catalog Number		
Flush, spring return	White	ZB6DA1	ZB6CA1	ZB6AA1
	Black	ZB6DA2	ZB6CA2	ZB6AA2
	Green	ZB6DA3	ZB6CA3	ZB6AA3
	Red	ZB6DA4	ZB6CA4	ZB6AA4
	Yellow	ZB6DA5	ZB6CA5	ZB6AA5
	Blue	ZB6DA6	ZB6CA6	ZB6AA6
	6 colors [11]	ZB6DA9	ZB6CA9	ZB6AA9

**Table 19.43: Mushroom Heads for Trigger Action Push Buttons (30 mm) [13]**



Shape of Head	Type of Push	Cap Color	Catalog Number
	Turn-to-release	Red	ZB6AS834
	Key release	Red	ZB6AS934 [14]

**Table 19.44: Circular Legends, 45 mm**



Description	Color	Text	Catalog Number
Circular legends, 45 mm	Yellow	Blank	ZB6Y7001
		Emergency stop	ZB6Y7330

[10] To combine with light modules, see XB6 Electrical Components.

[11] Six different color caps included with head (white, black, green, red, yellow, and blue).

[12] To combine with complete bodies and contact blocks, see XB6 Electrical Components, page 19-15

[13] Complies with ISO 13850 standards for Emergency Stop push buttons when used with circular Legend Plate ZB6Y7330



[14] Ronis 200 key

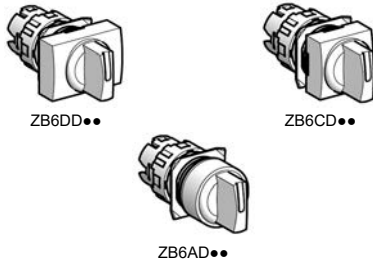



**XB6 Non-Illuminated Selector Switches**

**Table 19.45: Heads for Non-Illuminated Selector Switches**<sup>[15][16]</sup>  
(To combine with complete bodies and contact blocks, see [XB6 Electrical Components](#), page 19-15.)

Number and Type of Positions	Color of Handle				
		Rectangular	Square	Round	
Catalog Number					
Switching angle: maintained positions 60°, spring return positions 45°					
2-maintained	↙	Black	ZB6DD22	ZB6CD22	ZB6AD22
2-maintained	↘	Black	ZB6DD28 <sup>[17]</sup>	ZB6CD28 <sup>[17]</sup>	ZB6AD28 <sup>[17]</sup>
3-maintained	↙↘	Black	ZB6DD23	ZB6CD23	ZB6AD23
2-spring return to center	↕	Black	ZB6DD24	ZB6CD24	ZB6AD24
3-spring return to center	↕↙↘	Black	ZB6DD25	ZB6CD25	ZB6AD25
3-spring return from right to center	↙↘↕	Black	ZB6DD26	ZB6CD26	ZB6AD26
3-spring return from left to center	↙↘↕	Black	ZB6DD27	ZB6CD27	ZB6AD27

Legends: [Legend Plates and Legends](#), page 19-20

[15] For bodies with 2 contact blocks, maximum.  
 [16] For selector switch sequence charts, see [XB6 Keyed Selector Switches](#), page 19-18.  
 [17] Switching angle: maintained positions 90°.

XB6 Keyed Selector Switches

Table 19.46: Heads for Ronis Key Operated Selector Switches [18]  
 (To combine with complete bodies and contact blocks, see XB6 Electrical Components, page 19-15.)

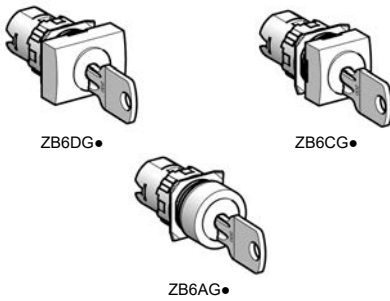

Number and Type of Positions	Key Withdrawal				
		Rectangular	Square	Round	
Catalog Number					
Switching angle: maintained positions 70°, spring return positions 45°					
2-maintained		Right-hand position	ZB6DGA	ZB6CGA	ZB6AGA
		Center position	ZB6DGB	ZB6CGB	ZB6AGB
		Both positions	ZB6DGC	ZB6CGC	ZB6AGC
2-spring return from right to center		Center position	ZB6DGL	ZB6CGL	ZB6AGL
3-maintained		Left-hand position	ZB6DGD	ZB6CGD	ZB6AGD
		Center position	ZB6DGE	ZB6CGE	ZB6AGE
		Left-hand and center positions	ZB6DGF	ZB6CGF	ZB6AGF
		Right-hand position	ZB6DGG	ZB6CGG	ZB6AGG
		All 3 positions	ZB6DGH	ZB6CGH	ZB6AGH
		Left-hand and right-hand positions	ZB6DGJ	ZB6CGJ	ZB6AGJ
		Right-hand and center positions	ZB6DGK	ZB6CGK	ZB6AGK
3-spring return from right to center		Left-hand position	ZB6DGQ	ZB6CGQ	ZB6AGQ
		Center position	ZB6DGR	ZB6CGR	ZB6AGR
		Left-hand and center positions	ZB6DGS	ZB6CGS	ZB6AGS
3-spring return to center		Center position	ZB6DGT	ZB6CGT	ZB6AGT

Indicates key withdrawal position.

Table 19.47: Selector Switch Sequence  
 (using contact block assemblies, see XB6 Electrical Components, page 19-15)

2 Position Selector Switch			Contact block guide [19]
O	X		1 N.O. (left or right)
X	O		1 N.C. (left or right)
O	X		1 N.O.
			and
X	O		1 N.C.

3 Position Selector Switch			Contact block guide [19]
O	O	X	1 N.O. (left)
X	O	X	2 N.O. wired in parallel (side by side)
X	O	O	1 N.O. (right)
O	X	X	1 N.C. (right)
X	X	O	1 N.C. (left)
O	X	O	2 N.C. wired in series (side by side)

For legends, see Legend Plates and Legends , page 19-20

[18] Ronis 200 key standard.  
 [19] As viewed from the front of the panel.

**XB6 Push Button Caps**

**Table 19.48: Push Button Caps—Marked**

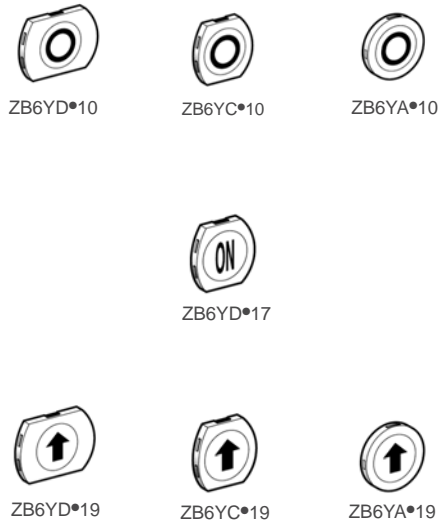

Ink Marking Color: White on colored cap Black on white cap	Color	Rectangular	Square	Round
		Catalog Number		
<b>For non-illuminated push buttons</b>				
0	White	ZB6YD100	ZB6YC100	ZB6YA100
	Black	ZB6YD200	ZB6YC200	ZB6YA200
1	White	ZB6YD101	ZB6YC101	ZB6YA101
	Black	ZB6YD201	ZB6YC201	ZB6YA201
2	White	ZB6YD102	ZB6YC102	ZB6YA102
	Black	ZB6YD202	ZB6YC202	ZB6YA202
3	White	ZB6YD103	ZB6YC103	ZB6YA103
	Black	ZB6YD203	ZB6YC203	ZB6YA203
4	White	ZB6YD104	ZB6YC104	ZB6YA104
	Black	ZB6YD204	ZB6YC204	ZB6YA204
5	White	ZB6YD105	ZB6YC105	ZB6YA105
	Black	ZB6YD205	ZB6YC205	ZB6YA205
6	White	ZB6YD106	ZB6YC106	ZB6YA106
	Black	ZB6YD206	ZB6YC206	ZB6YA206
7	White	ZB6YD107	ZB6YC107	ZB6YA107
	Black	ZB6YD207	ZB6YC207	ZB6YA207
8	White	ZB6YD108	ZB6YC108	ZB6YA108
	Black	ZB6YD208	ZB6YC208	ZB6YA208
9	White	ZB6YD109	ZB6YC109	ZB6YA109
	Black	ZB6YD209	ZB6YC209	ZB6YA209
ON	White	ZB6YD117	ZB6YC117	ZB6YA117
	Green	ZB6YD317	ZB6YC317	ZB6YA317
OFF	Black	ZB6YD224	ZB6YC224	ZB6YA224
	Red	ZB6YD424	ZB6YC424	ZB6YA424
I	White	ZB6YD111	ZB6YC111	ZB6YA111
	Green	ZB6YD311	ZB6YC311	ZB6YA311
O	Black	ZB6YD210	ZB6YC210	ZB6YA210
	Red	ZB6YD410	ZB6YC410	ZB6YA410
R	Black	ZB6YD226	ZB6YC226	ZB6YA226
	Blue	ZB6YD626	ZB6YC626	ZB6YA626
START	White	ZB6YD140	ZB6YC140	ZB6YA140
	Green	ZB6YD340	ZB6YC340	ZB6YA340
STOP	Black	ZB6YD241	ZB6YC241	ZB6YA241
	Red	ZB6YD441	ZB6YC441	ZB6YA441
II	White	ZB6YD112	ZB6YC112	ZB6YA112
	Black	ZB6YD212	ZB6YC212	ZB6YA212
III	White	ZB6YD113	ZB6YC113	ZB6YA113
	Black	ZB6YD213	ZB6YC213	ZB6YA213
+	White	ZB6YD114	ZB6YC114	ZB6YA114
	Black	ZB6YD214	ZB6YC214	ZB6YA214
-	White	ZB6YD115	ZB6YC115	ZB6YA115
	Black	ZB6YD215	ZB6YC215	ZB6YA215
UP	White	ZB6YD127	ZB6YC127	ZB6YA127
	Black	ZB6YD227	ZB6YC227	ZB6YA227
DOWN	White	ZB6YD128	ZB6YC128	ZB6YA128
	Black	ZB6YD228	ZB6YC228	ZB6YA228
CLOSE	White	ZB6YD132	ZB6YC132	ZB6YA132
	Black	ZB6YD232	ZB6YC232	ZB6YA232
↑	White	ZB6YD119	ZB6YC119	ZB6YA119
	Black	ZB6YD219	ZB6YC219	ZB6YA219
↓	White	ZB6YD120	ZB6YC120	ZB6YA120
	Black	ZB6YD220	ZB6YC220	ZB6YA220
→	White	ZB6YD121	ZB6YC121	ZB6YA121
	Black	ZB6YD221	ZB6YC221	ZB6YA221
←	White	ZB6YD122	ZB6YC122	ZB6YA122
	Black	ZB6YD222	ZB6YC222	ZB6YA222

**Additional XB6 Accessories**

**Table 19.49: Accessories**

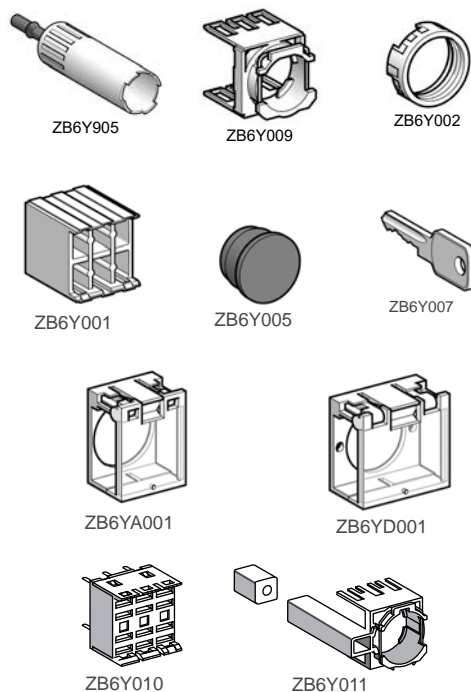

Description	Application	Catalog Number
Body	Fitting contact blocks	ZB6Y009
Bezel tightening tool + bulb extractor	Fixing the switch and changing bulbs	ZB6Y905
Three piece tool kit	—	ZB6Y019
Nut	Fixing head to panel	ZB6Y002
Adaptor	Flush mounting a circular head push button or pilot light in Ø 22 mm cut-out	ZB6YA002
Shroud	Protecting contacts against touching	ZB6Y001
Protective cover	Circular and square head push buttons and switches	ZB6YA001
	Rectangular head push buttons and switches	ZB6YD001
Female Quick connector/Solder tab	Sold in lots of 100 pieces	ZB6Y004
Blanking plug	Plugging an unused knockout	ZB6Y005
Ronis key, 2 pieces	Key operated selector switches and emergency stop mushroom	ZB6Y007
Incandescent bulbs, bayonet T1 1/4	6 V	ZB6YA006
	12 V	ZB6YJ012
	28 V <sup>[20]</sup>	ZB6YB028
Neon bulbs	110/230 V <sup>[21]</sup>	ZB6YG095

**Table 19.50: Accessories for Printed Circuit Board Installations**

Description	for use with	Catalog Number
Plug-in Socket Adaptor	contact blocks and light modules	ZB6Y010
Body Bracket	plug-in socket adaptor	ZB6Y011

**XB6 Legend Plates and Legends**

**Table 19.51: Standard Legend Plate (24 X 28 mm) for 8 X 21 mm Legend <sup>[22]</sup>**

Description	Background Color of Legend	Catalog Number
Without legend insert	—	ZB6YD20
With blank legend insert	White or yellow	ZB6YD21
	Black or red	ZB6YD22

**Table 19.52: 8 x 21 mm Marked Legends (for 24 x 28 mm legend holder ZB6YD20) <sup>[22]</sup>**

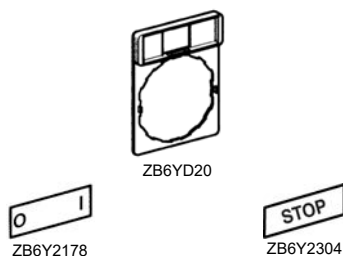

Color	Marking	Catalog Number	
White Text Red Background (Stop and Fault) Black Background (all others)	International	O-I	ZB6Y2178
		I-II	ZB6Y2179
		I-O-II	ZB6Y2186
		O	ZB6Y2190
	English	HAND-O-AUTO	ZB6Y2387
		CLOSE	ZB6Y2314
		DOWN	ZB6Y2308
		FORWARD	ZB6Y2305
		FAULT	ZB6Y2334
		LEFT	ZB6Y2310
		OFF	ZB6Y2312
		ON	ZB6Y2303
		OPEN	ZB6Y2313
		RESET	ZB6Y2323
		REVERSE	ZB6Y2306
RIGHT	ZB6Y2309		
RUN	ZB6Y2311		
STOP	ZB6Y2304		
UP	ZB6Y2307		

**Table 19.53: Circular Legends, 45 mm**

Description	Color	Text	Catalog Number
Circular legends, 45 mm	Yellow	Blank	ZB6Y7001
		Emergency stop	ZB6Y7330

[20] 28 V bulb supplied, for use on 24 V.

[21] 95 V bulb supplied, for use on 110/230 V.

[22] Additional legend plate sizes and markings are available in Catalog [9001CT1102](#).

*New!*

**XB6E Flush, Spring Return Push Buttons**

**Table 19.54: Push Buttons, Flush, Spring Return**



XB6EAA11P



XB6EAA12P



XB6EDA11P

Shape of head	Type of contacts	Color	Sold in lots of	Catalog Number
Circular	1	White	5	XB6EAA11P
		Black	5	XB6EAA21P
		Green	5	XB6EAA31P
		Red	5	XB6EAA41P
		Yellow	5	XB6EAA51P
		Blue	5	XB6EAA61P
	2	White	5	XB6EAA12P
		Black	5	XB6EAA22P
		Green	5	XB6EAA32P
		Red	5	XB6EAA42P
		Yellow	5	XB6EAA52P
		Blue	5	XB6EAA62P
Square	1	White	5	XB6ECA11P
		Black	5	XB6ECA21P
		Green	5	XB6ECA31P
		Red	5	XB6ECA41P
		Yellow	5	XB6ECA51P
		Blue	5	XB6ECA61P
	2	White	5	XB6ECA12P
		Black	5	XB6ECA22P
		Green	5	XB6ECA32P
		Red	5	XB6ECA42P
		Yellow	5	XB6ECA52P
		Blue	5	XB6ECA62P
Rectangular	1	White	5	XB6EDA11P
		Black	5	XB6EDA21P
		Green	5	XB6EDA31P
		Red	5	XB6EDA41P
		Yellow	5	XB6EDA51P
		Blue	5	XB6EDA61P
	2	White	5	XB6EDA12P
		Black	5	XB6EDA22P
		Green	5	XB6EDA32P
		Red	5	XB6EDA42P
		Yellow	5	XB6EDA52P
		Blue	5	XB6EDA62P

*New!*

**XB6E Pilot Lights**

**Table 19.55: XB6E Pilot Lights with 12 or 24 V Integral LED**



XB6EAV11P



XB6ECV11P



XB6EDV11P

Shape of head	Color	Sold in lots of	Catalog Number		
			With 12 V LED	With 24 V LED	
Circular	White	5	XB6EAV1JP	XB6EAV1BP	
	Green	5	XB6EAV3JP	XB6EAV3BP	
	Red	5	XB6EAV4JP	XB6EAV4BP	
	Yellow	5	XB6EAV5JP	XB6EAV5BP	
	Blue	5	XB6EAV6JP	XB6EAV6BP	
	Orange	5	XB6EAV8JP	XB6EAV8BP	
	Square	White	5	XB6ECV1JP	XB6ECV1BP
		Green	5	XB6ECV3JP	XB6ECV3BP
Red		5	XB6ECV4JP	XB6ECV4BP	
Yellow		5	XB6ECV5JP	XB6ECV5BP	
Blue		5	XB6ECV6JP	XB6ECV6BP	
Orange		5	XB6ECV8JP	XB6ECV8BP	
Rectangular		White	5	XB6EDV1JP	XB6EDV1BP
		Green	5	XB6EDV3JP	XB6EDV3BP
	Red	5	XB6EDV4JP	XB6EDV4BP	
	Yellow	5	XB6EDV5JP	XB6EDV5BP	
	Blue	5	XB6EDV6JP	XB6EDV6BP	
	Orange	5	XB6EDV8JP	XB6EDV8BP	

*New!*

**XB6E Illuminated Push Buttons, Spring Return**

**Table 19.56: Illuminated Push Buttons, Flush, Spring Return, with 12 or 24 V Integral LED**



XB6EAW11P



XB6ECW11P



XB6EDW11P

Shape of head	Type of contacts	Color	Sold in lots of	Catalog Number	
				With 12 V LED	With 24 V LED
Circular	1	White	5	XB6EAW1J1P	XB6EAW1B1P
		Green	5	XB6EAW3J1P	XB6EAW3B1P
		Red	5	XB6EAW4J1P	XB6EAW4B1P
		Yellow	5	XB6EAW5J1P	XB6EAW5B1P
		Blue	5	XB6EAW6J1P	XB6EAW6B1P
	2	Orange	5	XB6EAW8J1P	XB6EAW8B1P
		White	5	XB6EAW1J2P	XB6EAW1B2P
		Green	5	XB6EAW3J2P	XB6EAW3B2P
		Red	5	XB6EAW4J2P	XB6EAW4B2P
		Yellow	5	XB6EAW5J2P	XB6EAW5B2P
Square	1	Blue	5	XB6EAW6J2P	XB6EAW6B2P
		Orange	5	XB6EAW8J2P	XB6EAW8B2P
		White	5	XB6ECW1J1P	XB6ECW1B1P
		Green	5	XB6ECW3J1P	XB6ECW3B1P
		Red	5	XB6ECW4J1P	XB6ECW4B1P
	2	Yellow	5	XB6ECW5J1P	XB6ECW5B1P
		Blue	5	XB6ECW6J1P	XB6ECW6B1P
		Orange	5	XB6ECW8J1P	XB6ECW8B1P
		White	5	XB6ECW1J2P	XB6ECW1B2P
		Green	5	XB6ECW3J2P	XB6ECW3B2P
Rectangular	1	Red	5	XB6ECW4J2P	XB6ECW4B2P
		Yellow	5	XB6ECW5J2P	XB6ECW5B2P
		Blue	5	XB6ECW6J2P	XB6ECW6B2P
		Orange	5	XB6ECW8J2P	XB6ECW8B2P
		White	5	XB6EDW1J1P	XB6EDW1B1P
	2	Green	5	XB6EDW3J1P	XB6EDW3B1P
		Red	5	XB6EDW4J1P	XB6EDW4B1P
		Yellow	5	XB6EDW5J1P	XB6EDW5B1P
		Blue	5	XB6EDW6J1P	XB6EDW6B1P
		Orange	5	XB6EDW8J1P	XB6EDW8B1P
Rectangular	1	White	5	XB6EDW1J2P	XB6EDW1B2P
		Green	5	XB6EDW3J2P	XB6EDW3B2P
		Red	5	XB6EDW4J2P	XB6EDW4B2P
		Yellow	5	XB6EDW5J2P	XB6EDW5B2P
		Blue	5	XB6EDW6J2P	XB6EDW6B2P
	2	Orange	5	XB6EDW8J2P	XB6EDW8B2P
		White	5	XB6EDW1J1P	XB6EDW1B1P
		Green	5	XB6EDW3J1P	XB6EDW3B1P
		Red	5	XB6EDW4J1P	XB6EDW4B1P
		Yellow	5	XB6EDW5J1P	XB6EDW5B1P

*New!*

**XB6E Illuminated Push Buttons, Latching**

**Table 19.57: Illuminated Push Buttons, Flush, Latching, with 12 or 24 V Integral LED**



XB6EAF11P



XB6ECF11P



XB6EDF11P

Shape of Head	Type of Contacts	Color	Sold in lots of	Catalog Number	
				With 12 V LED	With 24 V LED
Circular	1	White	5	XB6EAF1J1P	XB6EAF1B1P
		Green	5	XB6EAF3J1P	XB6EAF3B1P
		Red	5	XB6EAF4J1P	XB6EAF4B1P
		Yellow	5	XB6EAF5J1P	XB6EAF5B1P
		Blue	5	XB6EAF6J1P	XB6EAF6B1P
	2	Orange	5	XB6EAF8J1P	XB6EAF8B1P
		White	5	XB6EAF1J2P	XB6EAF1B2P
		Green	5	XB6EAF3J2P	XB6EAF3B2P
		Red	5	XB6EAF4J2P	XB6EAF4B2P
		Yellow	5	XB6EAF5J2P	XB6EAF5B2P
Square	1	Blue	5	XB6EAF6J2P	XB6EAF6B2P
		Orange	5	XB6EAF8J2P	XB6EAF8B2P
		White	5	XB6ECF1J1P	XB6ECF1B1P
		Green	5	XB6ECF3J1P	XB6ECF3B1P
		Red	5	XB6ECF4J1P	XB6ECF4B1P
	2	Yellow	5	XB6ECF5J1P	XB6ECF5B1P
		Blue	5	XB6ECF6J1P	XB6ECF6B1P
		Orange	5	XB6ECF8J1P	XB6ECF8B1P
		White	5	XB6ECF1J2P	XB6ECF1B2P
		Green	5	XB6ECF3J2P	XB6ECF3B2P
Rectangular	1	Red	5	XB6ECF4J2P	XB6ECF4B2P
		Yellow	5	XB6ECF5J2P	XB6ECF5B2P
		Blue	5	XB6ECF6J2P	XB6ECF6B2P
		Orange	5	XB6ECF8J2P	XB6ECF8B2P
		White	5	XB6EDF1J1P	XB6EDF1B1P
	2	Green	5	XB6EDF3J1P	XB6EDF3B1P
		Red	5	XB6EDF4J1P	XB6EDF4B1P
		Yellow	5	XB6EDF5J1P	XB6EDF5B1P
		Blue	5	XB6EDF6J1P	XB6EDF6B1P
		Orange	5	XB6EDF8J1P	XB6EDF8B1P
Rectangular	1	White	5	XB6EDF1J2P	XB6EDF1B2P
		Green	5	XB6EDF3J2P	XB6EDF3B2P
		Red	5	XB6EDF4J2P	XB6EDF4B2P
		Yellow	5	XB6EDF5J2P	XB6EDF5B2P
		Blue	5	XB6EDF6J2P	XB6EDF6B2P
	2	Orange	5	XB6EDF8J2P	XB6EDF8B2P
		White	5	XB6EDF1J1P	XB6EDF1B1P
		Green	5	XB6EDF3J1P	XB6EDF3B1P
		Red	5	XB6EDF4J1P	XB6EDF4B1P
		Yellow	5	XB6EDF5J1P	XB6EDF5B1P



XB6ET522P

XB6ETN521P

New!

**Table 19.58: Emergency Stop Mushroom Head Push Button**

Shape of Head	Type of Push	Type of Contacts N. C.	Sold in lots of	Catalog Number	
				With 12 V LED	With 24 V LED
<b>Illuminated</b>					
Circular, Ø 32 mm / 1.260 in.	Trigger action, turn to release, pull to release	2	5	XB6ETI522P	XB6ETI523P
<b>Non-Illuminated</b>					
Circular, Ø 32 mm / 1.260 in.	Trigger action, turn to release, pull to release	2	5	XB6ETN521P	—

New!

**XB6E Selector Switches**

**Table 19.59: Selector Switches with Standard Handle or Key Switches**



XB6EAD522P

XB6EAG522P

XB6ECD522P

XB6ECG522P

XB6EDD522P

XB6EDG522P

Shape of Head	Type of push	Type of contacts		Number and type of positions	Sold in lots of	Catalog Number
		CO	NO			
Circular	Standard black handle	1	2-maintained	2	5	XB6EAD221P
		2	2-maintained	2	5	XB6EAD222P
		2	3-maintained	2	5	XB6EAD232P
	Key [23]	1	2-maintained	2	5	XB6EAG221P
		2	2-maintained	2	5	XB6EAG222P
		2	3-maintained	2	5	XB6EAG232P
Square	Standard black handle	1	2-maintained	2	5	XB6ECD221P
		2	2-maintained	2	5	XB6ECD222P
		2	3-maintained	2	5	XB6ECD232P
	Key [23]	1	2-maintained	2	5	XB6ECG221P
		2	2-maintained	2	5	XB6ECG222P
		2	3-maintained	2	5	XB6ECG232P
Rectangular	Standard black handle	1	2-maintained	2	5	XB6EDD221P
		2	2-maintained	2	5	XB6EDD222P
		2	3-maintained	2	5	XB6EDD232P
	Key [23]	1	2-maintained	2	5	XB6EDG221P
		2	2-maintained	2	5	XB6EDG222P
		2	3-maintained	2	5	XB6EDG232P

New!

**XB6E Accessories**

**Table 19.60: Fast Connector Sockets**

For use with	Type of Contacts CO	Sold in lots of	Catalog Number
Illuminated Push Button	1	10	ZB6YF01
Illuminated Push Button	2	10	ZB6YF02
Pilot Lights	—	10	ZB6YF03
Push Button and Selector Switches	1	10	ZB6YF04
Push Button and Selector Switches	2	10	ZB6YF05

**Table 19.61: Accessories for Push Buttons**

For use with	For use with	Sold in lots of	Catalog Number
Bezel Tightening tool + Bulb Extractor	Tightening and slackening the bezel changing	2	ZB6Y905
Protective Covers	Circle or square push buttons	1	ZB6YA001
	Rectangular push buttons	1	ZB6YD001
Blanking Plug	—	10	ZB6Y005

**Table 19.62: Legends for Emergency Stop Mushroom Head Push Buttons**

Shape	Color	Marking	Sold in lots of	Catalog Number
Circular	Yellow	EMERGENCY STOP	10	ZB6Y56



ZB6YF01

XB6E522 + ZB6YF01

ZB6YA001

ZB6YD001

ZB6Y005

[23] Key No. 132, withdrawal from all positions. 2 keys supplied with product.

**XB4 Complete Devices—Non-Illuminated**

**Table 19.63: Non-Illuminated Push Buttons, Momentary (screw clamp terminal connections)**



Shape of Head	Type of Push	Type of Contact		Marking	Cap Color	Catalog Number	Components
		N.O.	N.C.				
	Flush	1	—	—	Black	XB4BA21	(ZB4BZ101 + ZB4BA2)
					Green	XB4BA31	(ZB4BZ101 + ZB4BA3)
					Yellow	XB4BA51	(ZB4BZ101 + ZB4BA5)
					Blue	XB4BA61	(ZB4BZ101 + ZB4BA6)
		—	1	—	Red	XB4BA42	(ZB4BZ102 + ZB4BA4)
					Black	XB4BA25	(ZB4BZ105 + ZB4BA2)
					Green	XB4BA35	(ZB4BZ105 + ZB4BA3)
					Red	XB4BA45	(ZB4BZ105 + ZB4BA4)
1	1	—	Yellow	XB4BA55	(ZB4BZ105 + ZB4BA5)		
			Blue	XB4BA65	(ZB4BZ105 + ZB4BA6)		
	Flush	1	—	"I" (white)	Green	XB4BA3311	(ZB4BZ101 + ZB4BA331)
	Flush	—	1	"O" (white)	Red	XB4BA4322	(ZB4BZ102 + ZB4BA432)
	Flush with clear silicone boot (color of pusher unobscured)	1	—	—	Black	XB4BP21	(ZB4BZ101 + ZB4BP2)
					Green	XB4BP31	(ZB4BZ101 + ZB4BP3)
					Yellow	XB4BP51	(ZB4BZ101 + ZB4BP5)
					Blue	XB4BP61	(ZB4BZ101 + ZB4BP6)
—	1	—	Red	XB4BP42	(ZB4BZ102 + ZB4BP4)		
			Red	XB4BL42	(ZB4BZ102 + ZB4BL4)		
	Extended	1	1	—	Red	XB4BL45	(ZB4BZ105 + ZB4BL4)
					Red	XB4BL45	(ZB4BZ105 + ZB4BL4)
	Mushroom head Ø 40 mm	1	—	—	Black	XB4BC21	(ZB4BZ101 + ZB4BC2)

**Table 19.64: Two Button Push Buttons, Momentary (screw clamp terminal connections)**



XB4BL73415

Shape of Head	Type of Push	Type of Contact		Marking	Degree of Protection	Catalog Number	Components
		N.O.	N.C.				
	One flush green push* One extended red push**	1	1	**"I" (white) ***"O" (white)	IP66 IP69K	XB4BL73415	(ZB4BZ105 + ZB4BL7341)

**Table 19.65: Two Button Push Buttons, Momentary + one white central pilot light (screw clamp terminal connections)**



XB4BL73731•5

Shape of Head	Type of Push	Type of Contact		Marking	Degree of Protection	Pilot Light Voltage	Catalog Number
		N.O.	N.C.				
	One flush green push* One extended red push** One white central pilot light block	1	1	**"I" (white) ***"O" (white)	IP66 IP69K	24 120 240	XB4BW73731B5 XB4BW73731G5 XB4BW73731M5

**Table 19.66: Three Button Push Buttons, Momentary (screw clamp terminal connections)**



XB4BA731327

Shape of Head	Type of Push	Type of Contact		Degree of Protection	Marking and Cap Color	Catalog Number
		N.O.	N.C.			
	Two flush pushes + one central projecting red push*	2	1	IP66 IP69K	White "I" on green background White "II" on green background *White "Stop" on red background	XB4BA731327
					Black "—" on white background White "—" on black background *White "Stop" on red background	XB4BA711237

For Legends, refer to [XB4 Legend Holders](#), page 19-38, [XB4 Legend Inserts](#), page 19-39 and [XB4 Legend Sheets](#), page 19-39.

For Caps, refer to [XB4 Accessories](#), page 19-40.





XB4BT845



XB4BS9445



XB4BS542



XB4BG33



XB4BD33

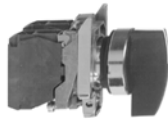

XB4BJ33

**Table 19.67: Non-Illuminated Trigger Action Emergency Stop Push Buttons, Ø 40 mm, Red (screw clamp terminal connections)**

Shape of Head	Type of Push	Type of Contact		Number of Positions	Catalog Number	Components
		N.O.	N.C.			
	Trigger action push-pull [1]	1	1		XB4BT845	(ZB4BZ105 + ZB4BT84)
	Trigger action turn-to-release [1]	1	1		XB4BS8445	(ZB4BZ105 + ZB4BS844)
		1	2		XB4BS84441	(ZB4BZ141 + ZB4BS844)
	Trigger action Key release [1] (No. 455)	1	1		XB4BS9445	(ZB4BZ105 + ZB4BS944)
	Trigger action Push-pull [1]	—	1		XB4BT842	(ZB4BZ102 + ZB4BT84)
	Trigger action Turn-to-release [1]	—	1		XB4BS8442	(ZB4BZ102 + ZB4BS844)
	Trigger action Key release [1] (No. 455)	—	1		XB4BS9442	(ZB4BZ102 + ZB4BS944)

**Table 19.68: Non-Illuminated Selector Switches and Key Switches (screw clamp terminal connections) [2]**

Shape of Head	Type of Operator	Type of Contact		Number and Type of Positions	Catalog Number	Components
		N.O.	N.C.			
	Standard lever, black	1	—	2-maintained		XB4BD21 (ZB4BZ101 + ZB4BD2)
		1	1	2-maintained		XB4BD25 (ZB4BZ105 + ZB4BD2)
		2	—	3-maintained		XB4BD33 (ZB4BZ103 + ZB4BD3)
	Extended lever, black	1	—	3-momentary to center		XB4BD53 (ZB4BZ103 + ZB4BD5)
		2	—	2-maintained		XB4BJ21 (ZB4BZ101 + ZB4BJ2)
				3-momentary to center		XB4BJ33 (ZB4BZ103 + ZB4BJ3)
	Key (No. 455)	1	—	2-maintained		XB4BG21 (ZB4BZ101 + ZB4BG2)
				2-momentary to left		XB4BG41 (ZB4BZ101 + ZB4BG4)
		2	—	3-maintained		XB4BG61 (ZB4BZ101 + ZB4BG6)
				3-maintained		XB4BG03 (ZB4BZ103 + ZB4BG0)
					XB4BG33 (ZB4BZ103 + ZB4BG3)	

**NOTE:** The symbol indicates key withdrawal position(s).

For Legends, refer to [XB4 Legend Holders](#), page 19-38, [XB4 Legend Inserts](#), page 19-39 and [XB4 Legend Sheets](#), page 19-39.

[1] Trigger action mushroom heads are tamper proof in that a change of contact state is not possible by teasing or floating the operator. For emergency stop applications, always use a trigger action push button (per EN/IEC 13850).  
[2] For contact configurations, see [Sequence of Contacts on Selector Switch Bodies](#), page 19-30.

**XB4 Complete Devices—Illuminated**

**Table 19.69: Pilot Lights with Protected LED™ (screw clamp terminal connections) [3]**



XB4BVB5

Shape of Head	Supply Voltage	Color	Catalog Number	Components
	24 Vac/Vdc	White	XB4BVB1	(ZB4BVB1 + ZB4BV013)
		Green	XB4BV B3	(ZB4BV B3 + ZB4BV033)
		Red	XB4BV B4	(ZB4BV B4 + ZB4BV043)
		Yellow	XB4BV B5	(ZB4BV B5 + ZB4BV053)
		Blue	XB4BV B6	(ZB4BV B6 + ZB4BV063)
		110–120 Vac	White	XB4BV G1
	Green	XB4BV G3	(ZB4BV G3 + ZB4BV033)	
	Red	XB4BV G4	(ZB4BV G4 + ZB4BV043)	
	Yellow	XB4BV G5	(ZB4BV G5 + ZB4BV053)	
	Blue	XB4BV G6	(ZB4BV G6 + ZB4BV063)	

**Table 19.70: Pilot Lights for BA9s Bulb (screw clamp terminal connections)**



XB4BV64



XB4BV33

Shape of Head	Supply Voltage	Color	Catalog Number	Components
<b>Direct supply, for BA9s (incandescent, LED, neon) V &lt; 250 V, 2.4 W bulb (bulb not included)</b>				
	< 250 Vac/Vdc	White	XB4BV61	(ZB4BV6 + ZB4BV01)
		Green	XB4BV63	(ZB4BV6 + ZB4BV03)
		Red	XB4BV64	(ZB4BV6 + ZB4BV04)
		Yellow	XB4BV65	(ZB4BV6 + ZB4BV05)
<b>Transformer type with 1.2 VA, 6 V secondary. BA9s incandescent bulb included</b>				
	110–120 Vac 50/60 Hz	White	XB4BV31	(ZB4BV3 + ZB4BV01)
		Green	XB4BV33	(ZB4BV3 + ZB4BV03)
		Red	XB4BV34	(ZB4BV3 + ZB4BV04)
		Yellow	XB4BV35	(ZB4BV3 + ZB4BV05)

**Table 19.71: Illuminated Push Buttons, Momentary (screw clamp terminal connections) [3]**



XB4BW33B5



XB4BW3465



XB4BW3545

Shape of Head	Description	Type of Contact		Supply Voltage	Color of Push	Catalog Number	Components	
		N.O.	N.C.					
<b>Flush</b>								
	Protected LED	1	1	24 Vac/Vdc	White	XB4BW31B5	(ZB4BW0B15 + ZB4BW313)	
					Green	XB4BW33B5	(ZB4BW0B35 + ZB4BW333)	
					Red	XB4BW34B5	(ZB4BW0B45 + ZB4BW343)	
					Yellow	XB4BW35B5	(ZB4BW0B55 + ZB4BW353)	
					Blue	XB4BW36B5	(ZB4BW0B65 + ZB4BW363)	
					110–120 Vac	White	XB4BW31G5	(ZB4BW0G15 + ZB4BW313)
						Green	XB4BW33G5	(ZB4BW0G35 + ZB4BW333)
						Red	XB4BW34G5	(ZB4BW0G45 + ZB4BW343)
				Yellow		XB4BW35G5	(ZB4BW0G55 + ZB4BW353)	
				Blue		XB4BW36G5	(ZB4BW0G65 + ZB4BW363)	
				< 250 Vac/Vdc		White	XB4BW3165	(ZB4BW065 + ZB4BW31)
						Green	XB4BW3365	(ZB4BW065 + ZB4BW33)
						Red	XB4BW3465	(ZB4BW065 + ZB4BW34)
					Yellow	XB4BW3565	(ZB4BW065 + ZB4BW35)	
					110–120 Vac 50/60 Hz	White	XB4BW3135	(ZB4BW035 + ZB4BW31)
						Green	XB4BW3335	(ZB4BW035 + ZB4BW33)
Red	XB4BW3435	(ZB4BW035 + ZB4BW34)						
Yellow	XB4BW3535	(ZB4BW035 + ZB4BW35)						
230–240 Vac 50/60 Hz	White	XB4BW3145	(ZB4BW045 + ZB4BW31)					
	Green	XB4BW3345	(ZB4BW045 + ZB4BW33)					
	Red	XB4BW3445	(ZB4BW045 + ZB4BW34)					
	Yellow	XB4BW3545	(ZB4BW045 + ZB4BW35)					
<b>Extended</b>								
	Protected LED	1	1	24 Vac/Vdc	White	XB4BW11B5	(ZB4BW0B15 + ZB4BW113)	
					Green	XB4BW13B5	(ZB4BW0B35 + ZB4BW133)	
					Red	XB4BW14B5	(ZB4BW0B45 + ZB4BW143)	
					Yellow	XB4BW15B5	(ZB4BW0B55 + ZB4BW153)	
					Blue	XB4BW16B5	(ZB4BW0B65 + ZB4BW163)	
					110–120 Vac	White	XB4BW11G5	(ZB4BW0G15 + ZB4BW113)
				Green		XB4BW13G5	(ZB4BW0G35 + ZB4BW133)	
				Red		XB4BW14G5	(ZB4BW0G45 + ZB4BW143)	
				Yellow		XB4BW15G5	(ZB4BW0G55 + ZB4BW153)	
				Blue		XB4BW16G5	(ZB4BW0G65 + ZB4BW163)	

For legends, refer to XB4 Legend Holders, page 19-38, XB4 Legend Inserts, page 19-39, and XB4 Legend Sheets, page 19-39.

[3] For 240 V LED, replace the last “B” or “G” in the catalog number with an “M”. For example, XB4BV B1 (24 V) becomes XB4BV M1 (240 V—AC only).

**XB4 Operators**

**Table 19.72: Non-Illuminated Operators, Momentary—Unmarked**



Shape of Head	Type of Push	Cap Color	Catalog Number
	Flush, without color cap [4]	—	ZB4BA0
	Flush, with set of 6 color caps	White Black Green Red Yellow Blue	ZB4BA9
	Flush	White Black Green Red Yellow Blue Gray	ZB4BA1 ZB4BA2 ZB4BA3 ZB4BA4 ZB4BA5 ZB4BA6 ZB4BA8
	Flush with transparent cap, for insertion of legend [5]	White Green Red Yellow Blue	ZB4BA18 ZB4BA38 ZB4BA48 ZB4BA58 ZB4BA68
	Booted Flush (clear silicone) Cap color unobscured	White Black Green Red Yellow Blue	ZB4BP1 ZB4BP2 ZB4BP3 ZB4BP4 ZB4BP5 ZB4BP6
	Booted Extended (clear silicone) Cap color unobscured	White Black Green Red Yellow Blue	ZB4BP1 ZB4BP2 ZB4BP3 ZB4BP4 ZB4BP5 ZB4BP6
	Booted (colored silicone) Cap color unobscured	White Black Green Red Yellow Blue	ZB4BP1S ZB4BP2S ZB4BP3S ZB4BP4S ZB4BP5S ZB4BP6S
	Booted (clear silicone) for insertion of legend [5] Cap color unobscured	White Green Red Yellow Blue	ZB4BP18 ZB4BP38 ZB4BP48 ZB4BP58 ZB4BP68
	Extended	White Black Green Red Yellow Blue	ZB4BL1 ZB4BL2 ZB4BL3 ZB4BL4 ZB4BL5 ZB4BL6
	Guarded Head	White Black Green Red Yellow Blue	ZB4BA16 ZB4BA26 ZB4BA36 ZB4BA46 ZB4BA56 ZB4BA66

**Table 19.73: Non-Illuminated Operators, Momentary—Premarked**



Shape of Head	Type of Push	Marking Text	Marking Color	Cap Color	Catalog Number	
	Flush	I	White	Green	ZB4BA331	
			Black	White	ZB4BA131	
		START	White	Green	ZB4BA333	
			Black	White	ZB4BA133	
		ON	White	Green	ZB4BA341	
			Black	White	ZB4BA141	
		RESET	White	Black	ZB4BA222	
		JOG	White	Black	ZB4BA245	
		O	White	Red	ZB4BA432	
		STOP	White	Black	Red	ZB4BA232
				Red	Black	ZB4BA434
		OFF	White	Red	Black	ZB4BA234
				Black	Red	ZB4BA435
		↑ [6]	White	Black	White	ZB4BA334
White	Black			ZB4BA335		
	Extended	O	White	Red	ZB4BL432	
			Black	Red	ZB4BL232	
		STOP	White	Red	Black	ZB4BL434
				Black	Red	ZB4BL234
		OFF	White	Red	ZB4BL435	
Black	Red	ZB4BL235				

For Legends, refer to XB4 Legend Holders, page 19-38, XB4 Legend Inserts, page 19-39, and XB4 Legend Sheets, page 19-39.

[4] Color cap to be ordered separately, see [XB4 Accessories](#), page 19-40.  
 [5] For legend ordering information, see [XB4 Legend Sheets](#), page 19-39.  
 [6] Cap supplied not clipped-in, allowing orientation of arrow in any one of 4 directions:



Table 19.74: Non-Illuminated Push-on/Push-off Operators

Shape of Head	Type of Push	Color of Push	Catalog Number
	Flush	White	ZB4BH01
		Black	ZB4BH02
		Green	ZB4BH03
		Red	ZB4BH04
		Yellow	ZB4BH05
		Blue	ZB4BH06
	Extended	White	ZB4BH1
		Black	ZB4BH2
		Green	ZB4BH3
		Red	ZB4BH4
		Yellow	ZB4BH5
		Blue	ZB4BH6

Table 19.75: Three Head Operators, Momentary



Shape of Head	Description	Marking	Cap Color	Degree of Protection	Catalog Number
<b>Premarked</b>					
	Two flush + one central projecting red push marked "Stop"	"I" (white) "II" (white)	Green Green	IP66 IP69K	ZB4BA73132
		"=" (white) "=" (white)	Green Green		ZB4BA73133
		"f" (white) "f" (white)	Green Green		ZB4BA73134
		"+" (white) "-" (white)	Green Green		ZB4BA73135
		"+" (black) "-" (black)	White White		ZB4BA71115
		"=" (black) "=" (white)	White Black		ZB4BA71123
		"f" (black) "f" (white)	White Black		ZB4BA71124
		"f" (white) "f" (white)	Black Black		ZB4BA72124
		<b>Without caps</b>			
	Two flush without caps	—	—	IP66 IP69K	ZB4BA791

Table 19.76: Two Head Operators, Momentary



Shape of Head	Description	Marking	Cap Color	Degree of Protection	Catalog Number
<b>No Marking</b>					
	Two flush	—	Green Red	IP66 IP69K	ZB4BA7340
		—	White Black		ZB4BA7120
	One flush One extended	—	Green Red		ZB4BL7340
<b>Premarked</b>					
	Two flush	"I" (white) "O" (white)	Green Red	IP66 IP69K	ZB4BA7341
		"I" (black) "O" (white)	White Black		ZB4BA7121
	One flush One extended	"I" (white) "O" (white)	Green Red		ZB4BL7341
<b>Without caps</b>					
	Two flush without caps	—	—	IP66 IP69K	ZB4BA79

For Legends, refer to XB4 Legend Holders, page 19-38, XB4 Legend Inserts, page 19-39, and XB4 Legend Sheets, page 19-39.

**XB4 Operators and Emergency Stop Operators**

**Table 19.77: Mushroom Heads, Momentary**



Shape of Head	Diameter of Head	Color of Head	Catalog Number
	30 mm	Black	ZB4BC24
		Green	ZB4BC34
		Red	ZB4BC44
		Yellow	ZB4BC54
		Blue	ZB4BC64
		Black	ZB4BC2
	40 mm	Green	ZB4BC3
		Red	ZB4BC4
		Yellow	ZB4BC5
		Blue	ZB4BC6
		Black	ZB4BR2
		Green	ZB4BR3
	60 mm	Red	ZB4BR4
		Yellow	ZB4BR5
		Blue	ZB4BR6

**Table 19.78: Mushroom Heads for Maintained Push Buttons**

Shape of Head	Type of Push	Diameter of Head	Color	Catalog Number
<b>For use in Emergency Stop applications</b>				
	Trigger action Push-pull [7]	40 mm	Red	ZB4BT84
		60 mm	Red	ZB4BX84
	Trigger action Turn-to-release [7]	30 mm	Red	ZB4BS834
		40 mm	Red	ZB4BS844
			Red marked "EMO"	ZB4BS84430
		60 mm	Red	ZB4BS864
	Trigger action Key release (No. 455) [7]	30 mm	Red	ZB4BS934
		40 mm	Red	ZB4BS944 [8]
		60 mm	Red	ZB4BS964
<b>For use in non-Emergency Stop applications</b>				
	Push-pull	40 mm	Black	ZB4BT2
		60 mm	Black	ZB4BX2
	Turn-to-release	30 mm	Black	ZB4BS42
		40 mm	Black	ZB4BS52
			Yellow	ZB4BS55
			Yellow marked "Robot Stop"	ZB4BS5550
	Key release (No. 455)	60 mm	Black	ZB4BS62
		30 mm	Black	ZB4BS72
		40 mm	Black	ZB4BS12
		60 mm	Black	ZB4BS22

**Table 19.79: Circular Legends for Emergency Stop Mushroom Heads (yellow background)**

Diameter	Text	Catalog Number
90 mm	Blank	ZBY8101
	EMERGENCY STOP	ZBY8330
60 mm Bezeled	Blank	ZBY9121
	Emergency Stop	ZBY9320
	Prada de Emergencia	ZBY9420
	Not Halt	ZBY9220

For Legends, refer to [XB4 Legend Holders](#), page 19-38, [XB4 Legend Inserts](#), page 19-39, and [XB4 Legend Sheets](#), page 19-39.

[7] Trigger action mushroom heads are tamper proof in that a change of contact state is not possible by teasing or floating the operator. For emergency stop applications, always use a trigger action push button (per EN/IEC 13850).

[8] Other key numbers:

- key no. 421E: add the suffix 12 to the catalog number.
- key no. 458A: add the suffix 10 to the catalog number.
- key no. 520E: add the suffix 14 to the catalog number.
- key no. 3131A: add the suffix 20 to the catalog number.

Example: The catalog number for a Ø 40 mm red mushroom head for a trigger action, maintained push button, with release by key no. 421E becomes: ZB5AS94412.

**XB4 Selector Switches**

**Table 19.80: Non-Illuminated Selector Switches [9]**



Color	Number and Type of Positions		Standard Lever [10]	Extended Lever
			Catalog Number	
Black	2-maintained		ZB4BD2	ZB4BJ2
Black	2-momentary from right to left		ZB4BD4	ZB4BJ4
Black	3-maintained		ZB4BD3	ZB4BJ3
Black	3-momentary to center		ZB4BD5	ZB4BJ5
Black	3-momentary from left to center		ZB4BD7	ZB4BJ7
Black	3-momentary from right to center		ZB4BD8	ZB4BJ8

**Table 19.81: Non-Illuminated Key Switches [9]**

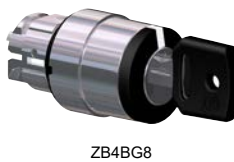

Type of Operator	Number and Type of Positions	Catalog Number		
	2-maintained		ZB4BG2	
			ZB4BG02	
			ZB4BG4	
	2-momentary from right to left		ZB4BG6	
			ZB4BG0	
<b>Key (No. 455)</b> <b>NOTE:</b> The symbol  indicates key withdrawal position(s). <b>Other key numbers:</b> —key no. 421E: add the suffix 12 to the catalog number. —key no. 458A: add the suffix 10 to the catalog number. —key no. 520E: add the suffix 14 to the catalog number. —key no. 3131A: add the suffix 20 to the catalog number. —key no. 8D1: add the suffix D to the catalog number.  <b>Example:</b> The catalog number for a head with key no. 421E for a 2 position maintained, lockable selector switch, with key withdrawal from the left-hand position, becomes: ZB5AG212	3-maintained		ZB4BG3	
			ZB4BG03	
			ZB4BG04	
			ZB4BG5	
			ZB4BG9	
			ZB4BG09	
		3-momentary from left to center		ZB4BG1
				ZB4BG01
		3-momentary to center		ZB4BG7
	ZB4BG8			
3-momentary from right to center		ZB4BG05		
		ZB4BG08		

**Table 19.82: Sequence of Contacts on Selector Switch Bodies**

Unit Type	Selector Switches															
	2-position						3-position									
	315°			45°			315°			0°			45°			
Operator Plunger Position	Up															
	Down															
Contact Block Location	L	C	R	L	C	R	L	C	R	L	C	R	L	C	R	
Contacts	N.O.	O	O	O	X	X	X	X	X	O	O	O	O	O	X	X
	N.C.	X	X	X	O	O	O	O	O	X	X	X	X	X	O	O

For Legends, refer to [XB4 Legend Holders](#), page 19-38, [XB4 Legend Inserts](#), page 19-39, and [XB4 Legend Sheets](#), page 19-39.

For Selector Switch Sequence, refer to [Sequence of Contacts on Illuminated Selector Switch Bodies](#), page 19-33.

[9] For contact configurations, see [Sequence of Contacts on Selector Switch Bodies](#), page 19-30.

[10] For colored lever, add the following code to the end of part number: 01–white, 03–green, 04–red, 05–yellow, 06–blue (Example: ZB4BD204).

**XB4 Specialty Operators**

**Table 19.83: Potentiometer Operator (with Mounting Collar)**

Shape of Head	Description	Application	Catalog Number
	For potentiometer with shaft length 1.73 to 1.97 in. (45 to 50 mm) (potentiometer not included)	For shaft Ø 1/4 in. (6.35 mm)	ZB4BD922
		For shaft Ø 0.24 in. (6 mm)	ZB4BD912



ZB4BD922



XB4BD912R1K



XD4PA12



ZB4BD28





XB4BA8•1

**Table 19.84: Complete Potentiometers**

Description	Resistance (k Ω)	Weight (kg/lb)	Catalog Number
+/- 10% linear mode precision complete potentiometer with screw terminals	1	0.095/0.209	XB4BD912R1K
	4.7	0.095/0.209	XB4BD912R4K7
	10	0.095/0.209	XB4BD912R10K
	47	0.095/0.209	XB4BD912R47K
	100	0.095/0.209	XB4BD912R100K
	470	0.095/0.209	XB4BD912R470K

**Table 19.85: Joysticks (54 mm, Extended Operating Shaft) [11]**

Description	Contact Operation	Action	Catalog Number
2 direction 	1 step 1 N.O. contact per direction	Maintained	XD4PA12
		Momentary	XD4PA22
4 direction 	1 step 1 N.O. contact per direction	Maintained	XD4PA14
		Momentary	XD4PA24





**Table 19.86: Legends for Joysticks**

Description	For use with	Color	Catalog Number
Legends 30 x 48 mm for customer engraving	2 direction	Black one side Red reverse	ZBG2201
		White one side Yellow reverse	ZBG2401
Legends 48 x 48 mm for customer engraving	4 direction	Black one side Red reverse	ZBG4201
		White one side Yellow reverse	ZBG4401

**Table 19.87: Two Position Toggle Switch**

Shape of Head	Color	Type of Positions	Catalog Number
	Black	Maintained	ZB4BD28
	Black	Momentary	ZB4BD48

**Table 19.88: Reset Operators, Flush, Adjustable Shaft**

Shape of Head	Travel		Actuation Distance		Color	Catalog Number
	in.	mm	in.	mm		
	0.39	10	0.24–0.63	6–16	Black	XB4BA821
					Red	XB4BA841
					Blue	XB4BA861
	0.55	14	0.63–1.02	16–26	Black	XB4BA822
					Red	XB4BA842
					Blue	XB4BA862
	0.55	14	1.18–5.12	30–130	Black	XB4BA921
					Red	XB4BA941
					Blue	XB4BA961
	0.55	14	5.12–10.12	130–257	Black	XB4BA922
					Red	XB4BA942
					Blue	XB4BA962

For Legends, refer to XB4 Legend Holders, page 19-38, XB4 Legend Inserts, page 19-39, and XB4 Legend Sheets, page 19-39.

[11] Do not use standard contact blocks ZBE10• (single) or ZBE20• (double).

XB4 Pilot Lights

Table 19.89: Pilot Light Heads



Shape of Head	For Use with Body Comprising Light Module Type	Color of Lens	Catalog Number
	Protected LED™ only	White Green Red Yellow Blue	ZB4BV013 ZB4BV033 ZB4BV043 ZB4BV053 ZB4BV063
	Protected LED only Fresnel (jeweled) lens [12]	White Green Red Amber Blue	ZB4BV013S ZB4BV033S ZB4BV043S ZB4BV053S ZB4BV063S
	For BA9s incandescent bulb, neon or LED only [13]	White Green Red Yellow Blue Clear	ZB4BV01 ZB4BV03 ZB4BV04 ZB4BV05 ZB4BV06 ZB4BV07
	For BA9s incandescent bulb, neon or LED Fresnel (jeweled) lens [13]	White Green Red Amber Blue Clear	ZB4BV01S ZB4BV03S ZB4BV04S ZB4BV05S ZB4BV06S ZB4BV07S

Table 19.90: Complete Bodies (Mounting Collar + Light Module for BA9s Incandescent Bulb, Neon or LED)



Description	Light Source	Supply Voltage (V)	Catalog Number
<b>Screw clamp terminal connections</b>			
Direct supply	BA9s bulb 2.4 W max. Not included [13]	<250	ZB4BV6
Direct supply	BA9s incandescent bulb included	24 v 2 Watt	ZB4BV624
Direct supply	BA9s incandescent bulb included	120 v 2.4 Watt	ZB4BV6120
<b>Transformer type 1.2 VA, 6 V secondary</b>	BA9s incandescent bulb included	110–120 Vac 50/60 Hz	ZB4BV3
		230–240 Vac 50/60 Hz	ZB4BV4
		400–50 Hz	ZB4BV5
		440–480 Vac 60 Hz	ZB4BV8
		550–600 Vac 60 Hz	ZB4BV9

Table 19.91: Complete Bodies (Mounting Collar + Light Module with Protected LED™) [14]

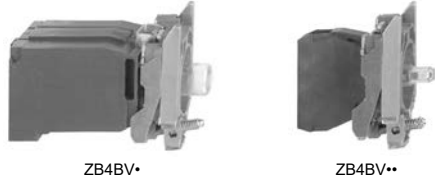

Light Source	Supply Voltage	Color of Light Source	Catalog Number
<b>Screw clamp terminal connections [15]</b>			
	12 Vac/Vdc	White Green Red Yellow Blue	ZB4BVJ1 ZB4BVJ3 ZB4BVJ4 ZB4BVJ5 ZB4BVJ6
	24 Vac/Vdc	White Green Red Yellow Blue	ZB4BV B1 ZB4BV B3 ZB4BV B4 ZB4BV B5 ZB4BV B6
	24–120 Vac/Vdc	White Green Red Yellow Blue	ZB4BV BG1 ZB4BV BG3 ZB4BV BG4 ZB4BV BG5 ZB4BV BG6
	110–120 Vac	White Green Red Yellow Blue	ZB4BV G1 ZB4BV G3 ZB4BV G4 ZB4BV G5 ZB4BV G6
	24 Vac/Vdc	White Green Red Yellow Blue	ZB4BV18B1 ZB4BV18B3 ZB4BV18B4 ZB4BV18B5 ZB4BV18B6
	110–120 Vac	White Green Red Yellow Blue	ZB4BV18G1 ZB4BV18G3 ZB4BV18G4 ZB4BV18G5 ZB4BV18G6

For Legends, refer to XB4 Legend Holders, page 19-38, XB4 Legend Inserts, page 19-39 and XB4 Legend Sheets, page 19-39.

[12] For use in bright ambient conditions, for example, in sunlight.

[13] Order bulb separately; see Table 19.119 BA9s Bulbs and Associated Accessories, page 19-41. For BA9 LED, see LED, BA9s Base, page 19-134.

[14] For 240 V LED, replace the last "B" or "G" in the catalog number with an "M". For example, ZB4BV B1 (24 V) becomes ZB4BV M1 (240 V).

[15] For Quick-Connect version, add "3" to the end of the catalog number Example: ZB4BV J13 (Quick-Connect size 1 x 1/40" or 2 x 0.110").





**XB4 Illuminated Operators**

**Table 19.92: Heads for Momentary Illuminated Push Buttons**

Shape of Head	Type of Push	Color	Catalog Number	
<b>Only use with Protected LED™ light modules</b>				
	Flush	White	ZB4BW313	
		Green	ZB4BW333	
		Red	ZB4BW343	
		Yellow	ZB4BW353	
	Flush with clear silicone boot	Blue	ZB4BW363	
		White	ZB4BW513	
		Green	ZB4BW533	
		Red	ZB4BW543	
	Flush for insertion of legend	Yellow	ZB4BW553	
		Blue	ZB4BW563	
		White	ZB4BA18	
		Green	ZB4BA38	
	Extended	Red	ZB4BA48	
		Yellow	ZB4BA58	
		Blue	ZB4BA68	
		White	ZB4BW113	
	Mushroom (40 mm)	Green	ZB4BW133	
		Red	ZB4BW143	
		Yellow	ZB4BW153	
		Blue	ZB4BW163	
	Mushroom (40 mm)	Clear	ZB4BW413	
		Green	ZB4BW433	
		Red	ZB4BW443	
		Yellow	ZB4BW453	
	Mushroom (40 mm)	Blue	ZB4BW463	
		<b>Only use with light modules for a BA9s incandescent bulb, neon or LED</b>		
		Flush	White	ZB4BW31
			Green	ZB4BW33
Red	ZB4BW34			
Yellow	ZB4BW35			
Extended	Blue	ZB4BW36		
	Clear	ZB4BW37		
	White	ZB4BW11		
	Green	ZB4BW13		
Extended	Extended	Red	ZB4BW14	
		Yellow	ZB4BW15	
		Blue	ZB4BW16	
		Clear	ZB4BW17	

**Table 19.93: Heads for Maintained Illuminated Push Buttons**

Shape of Head	Type of Push	Color of Lens	Catalog Number
<b>Only use with Protected LED light modules</b>			
	Push/Pull Mushroom (40 mm)	Clear	ZB4BW613
		Green	ZB4BW633
		Red	ZB4BW643
		Yellow	ZB4BW653
	Push/Pull Mushroom (40 mm)	Blue	ZB4BW663

**Table 19.94: Illuminated Push-On/Push-Off Operators**

Shape of Head	Type of Push	Color of Lens	Catalog Number
<b>Only use with Protected LED light modules</b>			
	Flush	White	ZB4BH013
		Green	ZB4BH033
		Red	ZB4BH043
		Yellow	ZB4BH053
	Extended	Blue	ZB4BH063
		White	ZB4BH13
		Green	ZB4BH33
		Red	ZB4BH43
	Extended	Yellow	ZB4BH53
		Blue	ZB4BH63

For Legends, refer to XB4 Legend Holders, page 19-38, XB4 Legend Inserts, page 19-39 and XB4 Legend Sheets, page 19-39.











ZB4BW7A3741



ZB4BW7A1721

**Table 19.95: Two Button with Clear Pilot Light, Momentary**

Shape of Head	Description	Marking	Cap Color	Degree of Protection	Catalog Number
<b>No Marking</b>					
	Two flush	—	Green Red	IP66 IP69K	ZB4BW7A3740
		—	White Black		ZB4BW7A1720
	One flush One extended	—	Green Red		ZB4BW7L3740
<b>Premarked</b>					
	Two flush	"I" (white) "O" (white)	Green Red	IP66 IP69K	ZB4BW7A3741
		"I" (black) "O" (white)	White Black		ZB4BW7A1721
	One flush One extended	"I" (white) "O" (white)	Green Red		ZB4BW7L3741
	Two flush	"+" (black) "-" (white)	White Black		ZB4BW7A1724
	Two flush	"+" (black) "-" (white)	White Black		ZB4BW7A1715
<b>Without caps</b>					
	Two flush without caps	—	—	IP66 IP69K	ZB4BW7A9













ZB4BK1343





**Table 19.96: Illuminated Selector Switches, Standard Lever**

Shape of Head	Number and Type of Positions	Catalog Number [16]
<b>Only use with Protected LED light modules</b>		
	2-maintained	ZB4BK12•3
	2-momentary from right to left	ZB4BK14•3
	3-maintained	ZB4BK13•3
	3-momentary to center	ZB4BK15•3
	3-momentary from right to center	ZB4BK18•3
	3-momentary from left to center	ZB4BK17•3

**Table 19.97: Sequence of Contacts on Illuminated Selector Switch Bodies**

Unit Type	Selector Switches									
	2-position				3-position					
	315°	45°	315°	0°	45°					
Operator Plunger Position	Up									
	Down									
Contact Block Location	L	R	L	R	L	R	L	R	L	R
	N.O.	O	O	X	X	X	O	O	O	X
Contacts	N.C.	X	X	O	O	O	X	X	X	O

**Note:** L=Left, R=Right, O=Open, X=Closed

2 Position Selector Switch			3 Position Selector Switch		
		Contact block guide			Contact block guide
O	X	1 N.O. (left or right)	O	O	1 N.O. (left)
X	O	1 N.C. (left or right)	X	O	2 N.O. wired in <b>parallel</b> (side by side)
O	X	1 N.O.	X	O	1 N.O. (right)
		and	O	X	1 N.C. (right)
X	O	1 N.C.	X	X	1 N.C. (left)
			O	X	2 N.C. wired in <b>series</b> (side by side)

For Legends, refer to [XB4 Legend Holders, page 19-38](#), [XB4 Legend Inserts, page 19-39](#), and [XB4 Legend Sheets, page 19-39](#).

For Caps, refer to [XB4 Accessories, page 19-40](#).

[16] • Designate color as follows: 1—white, 3—green, 4—red, 5—yellow, 6—blue.

**XB4 Electrical Components**

**Table 19.98: Contact Blocks (Mounting Collar with Contact Blocks)**



ZB4BZ101

Description	Type of Contact		Catalog Number
	N.O.	N.C.	
Screw clamp terminal connections	1	—	ZB4BZ101
	—	1	ZB4BZ102
	2	—	ZB4BZ103
	—	2	ZB4BZ104
	1	1	ZB4BZ105
	1	2	ZB4BZ141

For Quick-Connect version add "3" to the end of the catalog number Example: ZB4BZ1013 (Quick-Connect size 1 x 0.250" or 2 x 0.110").

For Ring Tongue compatible blocks add "9" to the end of the catalog number (Example: ZB4BZ1029).

Electrical components with connection by printed circuit board pins are available. Refer to Catalog 9001CT0001.

Electrical components with connection by plug-in connector are available. Refer to Catalog 9001CT0001.

**Table 19.99: Complete Bodies**

**(Mounting Collar + Single Contact Block + Light Module with Protected LED™)**



ZB4BW0••3



ZB4BW06•

Light Source	Type of Contact [17]		Color	Supply Voltage [18]	
	N.O.	N.C.		24 Vac/Vdc	110–120 Vac
<b>Screw clamp terminal connections</b>					
<b>Protected LED</b>	1	—	White	ZB4BW0B11	ZB4BW0G11
			Green	ZB4BW0B31	ZB4BW0G31
			Red	ZB4BW0B41	ZB4BW0G41
			Yellow	ZB4BW0B51	ZB4BW0G51
	—	1	Blue	ZB4BW0B61	ZB4BW0G61
			White	ZB4BW0B12	ZB4BW0G12
			Green	ZB4BW0B32	ZB4BW0G32
			Red	ZB4BW0B42	ZB4BW0G42
	2	—	Yellow	ZB4BW0B52	ZB4BW0G52
			Blue	ZB4BW0B62	ZB4BW0G62
			White	ZB4BW0B13	ZB4BW0G13
			Green	ZB4BW0B33	ZB4BW0G33
1	1	Red	ZB4BW0B43	ZB4BW0G43	
		Yellow	ZB4BW0B53	ZB4BW0G53	
		Blue	ZB4BW0B63	ZB4BW0G63	
		White	ZB4BW0B15	ZB4BW0G15	
			Green	ZB4BW0B35	ZB4BW0G35
			Red	ZB4BW0B45	ZB4BW0G45
			Yellow	ZB4BW0B55	ZB4BW0G55
			Blue	ZB4BW0B65	ZB4BW0G65

**Table 19.100: Mounting Collar, Contact Block and Light Module (with screw clamp terminal connections)**



ZB4BW0-5

Supply	Light Source	Supply Voltage	Type of Contact [19]		Color of Light Source	Catalog Number
			N.O.	N.C.		
<b>Screw clamp terminal connections</b>						
Direct supply	BA9s 2.4 W max. bulb Not included [20]	< 250 Vac/Vdc	1	—	—	ZB4BW061
			—	1	—	ZB4BW062
			2	—	—	ZB4BW063
Transformer type 1.2 VA, 6 V secondary	BA9s incandescent bulb included	110–120 Vac 50/60 Hz	1	1	—	ZB4BW031
			1	—	—	ZB4BW035
		230–240 Vac 50/60 Hz	1	—	—	ZB4BW041
			1	1	—	ZB4BW045
		440–480 Vac 60 Hz	1	—	—	ZB4BW081

[17] Can be fitted with additional contact blocks, see Table 19.102 Add-On Contact Block (with screw clamp terminal connections), page 19-36.

[18] For 240V LED, replace the "B" or "G" with "M". (Example: change "ZB4BW0B11 (24V)" to ZB4BW0M11 (240V))

[19] Can be fitted with additional contact blocks, see Table 19.102 Add-On Contact Block (with screw clamp terminal connections), page 19-36.

[20] Order bulb separately, see BA9s Bulbs and Associated Accessories.



Table 19.101: Body/Mounting Collar

For use with	Catalog Number
Electrical block (contact or light module)	ZB4BZ009

Table 19.102: Add-On Contact Block (with screw clamp terminal connections) [21]

Description	Type of Contact		Catalog Number
	N.O.	N.C.	
Standard <b>single</b> contact blocks [23][24]	1	—	ZBE101
	—	1	ZBE102
Standard <b>double</b> contact blocks [23][24]	2	—	ZBE203
	—	2	ZBE204
Special contact blocks for low power switching [25]	1	1	ZBE205
	1	—	ZBE1016
Low-power switching	—	1	ZBE1026
	1	—	ZBE1016P
Dusty environment [25] (IP5X, 50 µm dust)	—	1	ZBE1026P
	1	—	ZBE201
Staggered contacts	—	1	ZBE202
	1	1	ZB4BZ106
	—	2	ZB4BZ107
	1	1	ZB4BZ107



Table 19.103: Light Modules (with screw clamp terminal connections) [21][22]

Description	Supply Voltage	Color of Light Source	Catalog Number
Protected LED	12 Vac/Vdc	White	ZBVJ1
		Green	ZBVJ3
		Red	ZBVJ4
		Yellow	ZBVJ5
		Blue	ZBVJ6
		White	ZBVB1
	24 Vac/Vdc	Green	ZBVB3
		Red	ZBVB4
		Yellow	ZBVB5
		Blue	ZBVB6
		White	ZBVG1
		Green	ZBVG3
	110–120 Vac	Red	ZBVG4
		Yellow	ZBVG5
		Blue	ZBVG6
		White	ZBVG1
		Green	ZBVG3
		Red	ZBVG4
24–120 Vac/Vdc	Yellow	ZBVG5	
	Blue	ZBVG6	
	White	ZBVM1	
	Green	ZBVM3	
	Red	ZBVM4	
	Yellow	ZBVM5	
230–240 Vac	Blue	ZBVM6	
	White	ZBVM1	
	Green	ZBVM3	
	Red	ZBVM4	
Direct supply for BA9s 2.4 W max. bulb not included See Table 19.119 BA9s Bulbs and Associated Accessories, page 19-41	< 250 Vac/Vdc	Yellow	ZBVM5
		Blue	ZBVM6
		White	ZBVM1
		Green	ZBVM3

[21] Electrical components with connection by printed circuit board pins are available. Refer to Catalog 9001CT0001 for more details.  
 [22] Electrical components with connection by plug-in connector are available. Refer to Catalog 9001CT0001 for more details.  
 [23] For Quick-Connect version add "3" to the end of the catalog number Example: ZBE1013 (Quick-Connect size 1 x 0.250" or 2 x 0.110").  
 [24] For Ring Tongue compatible blocks add "9" to the end of the catalog number (Example: ZBE1029).  
 [25] Cannot stack additional contact blocks onto these blocks.



ZB4BZ009



ZBE1015





ZB4BZ1015

**Table 19.104: Body/Mounting Collar**

For use with	Catalog Number
Contact block or light module	ZB4BZ009

**Table 19.105: Contact Blocks [26]**

Spring Terminal Connections, Contacts for Standard Applications				
Description	Type of contact	 		Catalog Number
		N.O.	N.C.	
Contact blocks	Single	1	–	ZBE1015
		–	1	ZBE1025
	Single with body/mounting collar	1	–	ZB4BZ1015
		–	1	ZB4BZ1025
		2	–	ZB4BZ1035
		–	2	ZB4BZ1045
		1	1	ZB4BZ1045
		1	1	ZB4BZ1055

**Table 19.106: Light Modules [26]**

Spring Terminal Connections			
Description	Supply voltage	Color of light source	Catalog Number
Integral LED (to combine with heads for integral LED) 	12 Vac/Vdc	White	ZBVJ15
		Green	ZBVJ35
		Red	ZBVJ45
		Orange	ZBVJ55
		Blue	ZBVJ65
	24 Vac/Vdc	White	ZBVB15
		Green	ZBVB35
		Red	ZBVB45
		Orange	ZBVB55
		Blue	ZBVB65
	110–120 Vac	White	ZBVG15
		Green	ZBVG35
		Red	ZBVG45
		Orange	ZBVG55
		Blue	ZBVG65
	230–240 Vac	White	ZBVM15
		Green	ZBVM35
		Red	ZBVM45
		Orange	ZBVM55
		Blue	ZBVM65

[26] Additional blocks **cannot** be attached to the back of these contact blocks or light modules. However, spring terminal contact blocks can be mounted behind screw terminal contact blocks.

**XB4 Legend Holders**

**Table 19.107: Standard (30 x 40 mm) Legend Holders for 8 x 27 mm Legends**

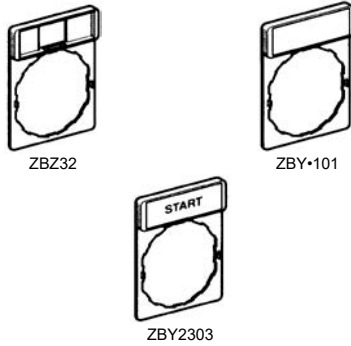

Description	Legend		Catalog Number
	Color	Text	
Without legend [27]	—	—	ZBZ32
With blank legend (for engraving)	Black or red background	—	ZBY2101
	White or yellow background	—	ZBY4101
Custom Legend (Specify Engraving) 2 lines of 11 characters (including spaces) maximum per line	Black background	White	ZBY2002
	Red background	White	ZBY2004
	White background	Black	ZBY4001
	Yellow background	Black	ZBY4005
With legend marked with international language	Black or red background [28]	O (black background)	ZBY2146
		O (red background)	ZBY2931
		I	ZBY2147
		II	ZBY2148
		O-I	ZBY2178
		I-II	ZBY2179
		I-O-II	ZBY2186
		AUTO	ZBY2115
		AUTO-HAND	ZBY2364
		AUTO-O-HAND	ZBY2385
With legend marked with English language	Black or red background[28]	CLOSE	ZBY2314
		DOWN	ZBY2308
		EMERGENCY STOP	ZBY2330
		FAST	ZBY2328
		FORWARD	ZBY2305
		FOR-REV	ZBY2371
		HAND	ZBY2316
		HAND-OFF-AUTO	ZBY2387
		INCH	ZBY2321
		JOG	ZBY2382
		LEFT	ZBY2310
		OFF	ZBY2312
		OFF-ON	ZBY2367
		ON	ZBY2311
		OPEN	ZBY2313
		POWER ON	ZBY2326
		RESET (red background)	ZBY2323
		RESET (black background)	ZBY2322
		REVERSE	ZBY2306
		RIGHT	ZBY2309
		RUN	ZBY2334
		SLOW	ZBY2327
		START	ZBY2303
		STOP	ZBY2304
		STOP-START	ZBY2366
		UP	ZBY2307

**Table 19.108: Large (30 x 50 mm) Legend Holders for 18 x 27 mm Legends**

Description [29]	Color	Catalog Number
Without legend insert	—	ZBZ33
With blank legend insert	Black or red background	ZBY6101
	White or yellow background	ZBY6102

**Table 19.109: 30 x 40 mm legend holder (flush mounting with bezel) for 8 x 27 mm legends**

Description [29]	Color	Catalog Number
Without legend	—	ZBZ34
With blank legend	Black or red background	ZBY2H101
	White or yellow background	ZBY4H101

**Table 19.110: 30 x 50 mm legend holder (flush mounting with bezel) for 18 x 27 mm legends**

Description [29]	Color	Catalog Number
Without legend	—	ZBZ35
With blank legend	Black or red background	ZBY6H101
	White or yellow background	ZBY6H102

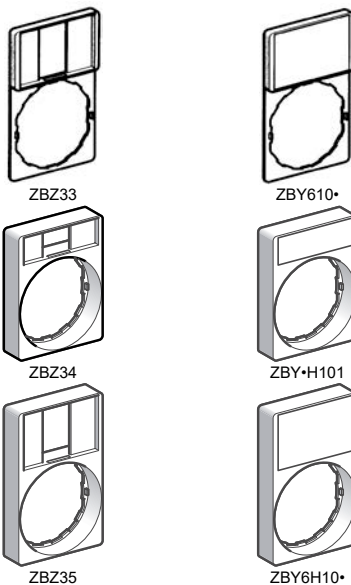

[27] For marked legends, see, Table 19.111 Marked Legends for 30 x 40 mm legend holders, page 19-39.

[28] Start functions: white letters on black background. Stop functions: white letters on red background (unless otherwise specified above).

[29] For custom Legends, see Table 19.112 Legends for Customer Engraving (inserts only), page 19-39 and Table 19.113 Legends for Factory Engraving (inserts only), page 19-39.

**XB4 Legend Inserts**

**Table 19.111: Marked Legends for 8 x 27 mm (for 30 x 40 mm legend holders ZBZ32)**



ZBY02178



ZBY02303

Color	Marking	Text	Catalog Number
Black or red background <i>[30]</i>	International	O (black background)	ZBY02146
		O (red background)	ZBY02931
		I	ZBY02147
		II	ZBY02148
		O-I	ZBY02178
		I-II	ZBY02179
	I-O-II	ZBY02186	
	English	AUTO	ZBY02115
		AUTO-HAND	ZBY02364
		AUTO-O-HAND	ZBY02385
		CLOSE	ZBY02314
		DOWN	ZBY02308
		EMERGENCY STOP	ZBY02330
		FAST	ZBY02328
		FORWARD	ZBY02305
		FOR-REV	ZBY02371
		HAND	ZBY02316
		HAND-OFF-AUTO	ZBY02387
		INCH	ZBY02321
		JOG	ZBY02382
		LEFT	ZBY02310
		OFF	ZBY02312
		OFF-ON	ZBY02367
		ON	ZBY02311
		OPEN	ZBY02313
		POWER ON	ZBY02326
		RESET (red background)	ZBY02323
		RESET (black background)	ZBY02322
		REVERSE	ZBY02306
		RIGHT	ZBY02309
		RUN	ZBY02334
		SLOW	ZBY02327
		START	ZBY02303
STOP		ZBY02304	
STOP-START	ZBY02366		
UP	ZBY02307		

**Table 19.112: Legends for Customer Engraving (inserts only)**

Description	For use with	Color	Text Color	Catalog Number
8 x 27 mm	30 x 40 mm legend holders	Black or red background	White	ZBY0101
		White or yellow background	Black	ZBY0102
18 x 27 mm	30 x 50 mm legend holders	Black or red background	White	ZBY5101
		White or yellow background	Black	ZBY5102

**Table 19.113: Legends for Factory Engraving (inserts only)**

Description	For use with	Color	Text Color	Catalog Number
8 x 27 mm Custom Legend/Insert Only (Specify Engraving) 2 lines of 11 characters (including spaces) maximum per line (Example: ZBY01002 marked "Robot")	30 x 40 mm legend holders	Black background	White	ZBY01002
		Red background	White	ZBY01004
		White background	Black	ZBY01001
		Yellow background	Black	ZBY01005
18 x 27 mm Custom Legend/Insert Only (Specify Engraving) 3 lines of 11 characters (including spaces) maximum per line (Example: ZBY05002 marked "Robot")	30 x 50 mm legend holders	Black background	White	ZBY05002
		Red background	White	ZBY05004
		White background	Black	ZBY05001
		Yellow background	Black	ZBY05005

**XB4 Legend Sheets**

**Table 19.114: Sheets of Legends for Push Buttons, Switches, and Pilot Lights**

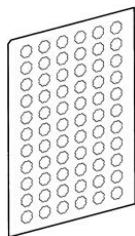

ZBY1101

Description	Marking	Text	Catalog Number
Sheets of 66 circular peel-off transparent self-adhesive legends	Blank		ZBY1101
	International	O	ZBY1146
		I	ZBY1147
		II	ZBY1148
		III	ZBY1149
		STOP	ZBY1304
		→	ZBY1912
	English	HAND	ZBY1316
		OFF	ZBY1312
		ON	ZBY1311
		START	ZBY1303

[30] Start functions: white letters on black background. Stop functions: white letters on red background (unless otherwise specified above).



XB4 Accessories

Table 19.115: Push Button Caps—Unmarked

For use with	Type of Push	Color	Catalog Number	
ZB4BA0 push button heads	Flush	White	ZBA1	
		Black	ZBA2	
		Green	ZBA3	
		Red	ZBA4	
		Yellow	ZBA5	
		Blue	ZBA6	
		6 colors [31]	ZBA9	
		Extended	White	ZBL1
			Black	ZBL2
	Green		ZBL3	
	Red		ZBL4	
	Yellow		ZBL5	
	Blue		ZBL6	
	6 colors [31]		ZBL9	

Table 19.116: Push Button Caps—Marked



For use with	Type of Push	Marking		Cap Color	Catalog Number
		Text [32]	Color		
ZB4BA0 push button heads	Flush	I [33]	White	Green	ZBA331
			Black	White	ZBA131
		START [33]	White	Green	ZBA333
			Black	White	ZBA133
		ON	White	Green	ZBA341
			Black	White	ZBA141
		UP [33]	Black	White	ZBA343
		DOWN [33]	White	Black	ZBA344
		⊕ [33]	White	Green	ZBA345
		⊖ [33]	White	Black	ZBA245
		⬇ [33]	White	Green	ZBA346
		↑	Black	White	ZBA334 [34]
			White	Black	ZBA335 [34]
		O [33]	White	Red	ZBA432
			Black	Black	ZBA232
		STOP [33]	White	Red	ZBA434
			Black	Black	ZBA234
		OFF	White	Red	ZBA435
			Black	Black	ZBA235
		R [34]	White	Blue	ZBA639

[31] Set of 6 different colored caps: white, black, green, red, yellow, blue.

[32] Start functions: white letters on black background. Stop functions: white letters on red background (unless otherwise specified).

[33] Double injection molded marking.

[34] Cap supplied not clipped-in, allowing orientation of arrow in any one of 4 directions: ↑, ↓, ←, or →





ZBA7235



ZBA7331



ZBA7432



ZBA79

**Table 19.117: Multiple-head and XB5R Push Button Caps<sup>[35]</sup>**

For use with	Type of Push	Marking	Cap Color	Catalog Number		
Double push button heads Tripe push button heads ZB4RZA0 ZB5RZA0	Flush	Unmarked	White	ZBA71		
		"I" black		ZBA7131		
		→ black		ZBA7134		
		"+" black		ZBA7138		
		Unmarked		ZBA72		
		"O" white	Black	ZBA7232		
		"+" white		ZBA7233		
		⇔ white		ZBA7235		
		"I" white		ZBA7237		
		Unmarked		ZBA73		
		"I" white	Green	ZBA7331		
		"+" white		ZBA7333		
		↑ white		ZBA7335		
		"I" white		ZBA7336		
		Unmarked		ZBA74		
		"O" white	Red	ZBA7432		
		Unmarked		ZBA75		
		Unmarked		ZBA76		
				Assorted	10 colors <sup>[36]</sup>	ZBA79

**Table 19.118: Accessories**

Description	Application	Color	Catalog Number
Padlocking kit Conforming to EN/ISO 13850 <sup>[37]</sup> (See legends below)	For Emergency Stop function only, with the following Ø 40 trigger-action push buttons: XB4BT8• XB4BS8• XB4BS9• ZB4BT8• ZB4BS8• ZB4BS9•	Yellow	ZBZ3605
Metal guards Padlockable	For Emergency Stop function only with the following Ø 40 mm trigger-action push buttons: XB4BT8• XB4BS8• XB4BS9• ZB4BT8• (except ZB5AT8643M) ZB4BS8• ZB4BS9•	Chrome Plated	ZBZ1600
		Black	ZBZ1602
		Red	ZBZ1604
		Yellow	ZBZ1605
	Blue	ZBZ1606	
Metal guard, padlockable	For Emergency Stop function with XB4 and XB5 E-Stop 30 mm and 40 mm operators	Chrome Plated	ZBZ1700
Metal guard	For XB4 illuminated push buttons	Chrome Plated	ZBZ1800
Plastic guards <sup>[38]</sup>	Round Guard for ZB4BS5430, 2.5" dia EMO Mushroom Operators	Yellow	ZB4BZ1905
	Narrow Flange Guard for ZB4BS5430 or ZB4BS84430 EMO Mushroom Operators <sup>[39]</sup>	Yellow	ZB4BZ2005
	Trigger Action Guard for ZB4BS84430, 3" dia EMO Mushroom Operators	Yellow	ZB4BZ2105
Padlockable flaps	For push buttons	Black	ZB4BZ62
		Red	ZB4BZ64
Mounting kits For push buttons with flush mounting bezel head and 30 mm mounting hole	Metal flush mounting kit (PB and PL)		ZB4BZ021
	Metal flush mounting kit (SS and IPB)		ZB4BZ022
	Plastic flush mounting kit (PB and PL)		ZB5AZ021
	Plastic flush mounting kit (SS and IPB)		ZB5AZ022
	Plastic flush mounting kit for legend 8 x 27 (PB and PL)		ZB5AZ023
Plastic flush mounting kit for legend 8 x 27 (SS and IPB)		ZB5AZ024	
Plastic flush mounting kit for legend 18 x 27 (PB and PL)		ZB5AZ025	
Plastic flush mounting kit for legend 18 x 27 (SS and IPB)		ZB5AZ026	
Metal blanking plug, round chrome plated <sup>[40]</sup>	For Ø 22 mm control and signalling units		ZB4SZ3
Plastic blanking plug, round black with mounting nut	For Ø 22 mm control and signalling units		ZB5SZ3
Ø 60 mm Legend for padlocking device ZBZ3605	Without	Yellow	ZBY9101T
	EMERGENCY STOP	Yellow	ZBY9330T

**Table 19.119: BA9s Bulbs and Associated Accessories**

Description	Characteristics	Catalog Number
Replacement bulbs (Type BA9s) Incandescent	6 V, 1.2 W	DL1CB006
	12 V, 2 W	DL1CE012
	24 V, 2 W	DL1CE024
	120–130 V, 2.4 W	DL1CE130
Neon bulbs	120–130 V, 1.8 mA	DL1CF110
	230–240 V, 1.8 mA	DL1CF220
Bulb extractor	—	XBFX13
Lens cap tightening tool	Illuminated push buttons with flush push	ZBZ8
Power driver bits for mounting and wiring (package of 5)	Cross headed screw (POZIDRIV type 1)	ZB4BZ905
Mounting Adapter	For mounting 22 mm push button in 30 mm KO	ZBZ41

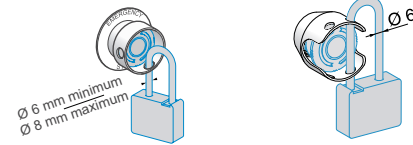

ZBZ3605

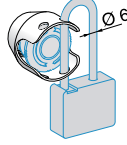

ZBZ160•



ZBZ1700



ZBZ1800

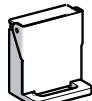

ZB4BZ6•

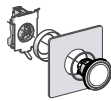

ZB4BZ011



DL1CE•••



DL1CF•••



XBFX13



ZBZ8

<sup>[35]</sup> Sold in lots of 10.

<sup>[36]</sup> Set of 10 different caps: white, black, green, red, yellow, blue, white "I" on green background, black "I" on white background, white "O" on red background, white "O" on black background.

<sup>[37]</sup> Standard circular legends are not compatible with this product. Use special legends ZBY••T listed above.

<sup>[38]</sup> For additional information, refer to publication 9001DB0601R6/06.

<sup>[39]</sup> Maximum panel thickness is 2.5 mm.

<sup>[40]</sup> Requires a ZB4BZ009 body/mounting collar for mounting, see [XB4 Electrical Components](#), page 19-35.

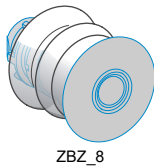

Table 19.120: Bellows Seals for Harsh Environments (IP 69K) [41]

Description	For use with	Color & Material	Sold in Lots of	Catalog Number
Bellows seals for harsh environments (Humidity, dust, high-pressure cleaning)	Any Harmony XB4 metal, mushroom head push button Ø 40 mm or Ø 60 mm (except ZB4BR*16)	Red Silicone	2	ZBZ48
		Black EPDM	2	ZBZ28
		Yellow EPDM	2	ZBZ58



Table 19.121: Boot for Standard Selector Switch Handle

Description	For use with	Catalog Number
Boot for standard handle	ZB4BD**	ZBD D2



Table 19.122: Replacement Keys

Description	Key Number	Catalog Number
Set of 2 keys	455	ZBG455
	421E	ZBG421E
	458A	ZBG458A
	520E	ZBG520E
	3131A	ZBG3131A
Set of 2 keys, One of which is supplied booted (rubber boot)	455	ZBG455P
	421E	ZBG421EP
	458A	ZBG458AP
	520E	ZBG520EP
	3131A	ZBG3131AP



Table 19.123: Clear Boots

Description	For use with	Material	Catalog Number
Single boots	Booted push buttons with circular head	Silicone	ZBPA
	Booted push buttons with circular head used in food industry applications		ZBP0A
Double boots	Double-headed push buttons, two flush		ZBA708
	Double-headed push buttons, one flush + one projecting		ZBA710
Triple boot	Triple-headed push buttons, two flush + one projecting	ZBA709	



Table 19.124: Lens Caps

For use with	Color	Catalog Number
<b>Lens caps for Protected LED™ light modules</b>		
Pilot lights	White	ZBV0113
	Green	ZBV0133
	Red	ZBV0143
	Yellow	ZBV0153
	Blue	ZBV0163
	White	ZBW9113
Illuminated push buttons with flush push	Green	ZBW9133
	Red	ZBW9143
	Yellow	ZBW9153
	Blue	ZBW9163
	White	ZBW9313
	Green	ZBW9333
Illuminated push buttons with extended push	Red	ZBW9343
	Yellow	ZBW9353
	Blue	ZBW9363
	White	ZBV011



<b>Lens caps for BA9 light modules</b>		
Pilot lights	Green	ZBV013
	Red	ZBV014
	Yellow	ZBV015
	Blue	ZBV016
	Clear	ZBV017
	White	ZBW911
Illuminated push buttons with flush push	Green	ZBW913
	Red	ZBW914
	Yellow	ZBW915
	Blue	ZBW916
	Clear	ZBW917
	White	ZBW931
Illuminated push buttons with extended push	Green	ZBW933
	Red	ZBW934
	Yellow	ZBW935
	Blue	ZBW936
	Clear	ZBW937
	White	ZBW931

[41] Only when mounted on control stations. Use special legends ZBY••T.

**XB5 Complete Devices**

**Table 19.125: Non-Illuminated Push Buttons, Momentary (screw clamp terminal connections)**



Shape of Head	Type of Push	Type of Contact		Marking	Cap Color	Catalog Number	Components		
		N.O.	N.C.						
	Flush	1	—	—	Black	XB5AA21	(ZB5AZ101 + ZB5AA2)		
					Green	XB5AA31	(ZB5AZ101 + ZB5AA3)		
					Yellow	XB5AA51	(ZB5AZ101 + ZB5AA5)		
					Blue	XB5AA61	(ZB5AZ101 + ZB5AA6)		
		1	1	1	1	—	Red	XB5AA42	(ZB5AZ102 + ZB5AA4)
							Black	XB5AA25	(ZB5AZ105 + ZB5AA2)
							Green	XB5AA35	(ZB5AZ105 + ZB5AA3)
							Red	XB5AA45	(ZB5AZ105 + ZB5AA4)
							Yellow	XB5AA55	(ZB5AZ105 + ZB5AA5)
							Blue	XB5AA65	(ZB5AZ105 + ZB5AA6)
	Flush	1	—	"I" (white)	Green	XB5AA3311	(ZB5AZ101 + ZB5AA331)		
	Flush	—	1	"O" (white)	Red	XB5AA4322	(ZB5AZ102 + ZB5AA432)		
	Flush with clear silicone boot (color of pusher unobscured)	1	—	—	Black	XB5AP21	(ZB5AZ101 + ZB5AP2)		
					Green	XB5AP31	(ZB5AZ101 + ZB5AP3)		
					Yellow	XB5AP51	(ZB5AZ101 + ZB5AP5)		
					Blue	XB5AP61	(ZB5AZ101 + ZB5AP6)		
	Extended	—	1	—	Red	XB5AL42	(ZB5AZ102 + ZB5AL4)		
		1	1	—	Red	XB5AL45	(ZB5AZ105 + ZB5AL4)		
	Mushroom head Ø 40 mm	1	—	—	Black	XB5AC21	(ZB5AZ101 + ZB5AC2)		

**Table 19.126: Two Button Push Buttons, Momentary (screw clamp terminal connections)**



Shape of Head	Type of Push	Type of Contact		Marking	Degree of Protection	Catalog Number	Components
		N.O.	N.C.				
	One flush green push* One extended red push**	1	1	**"I" ***"O" (white)	IP66 IP69K	XB5AL73415	(ZB5AZ105 + ZB5AL7341)

**Table 19.127: Two Button Push Buttons, Momentary + one white central pilot light (screw clamp terminal connections)**



Shape of Head	Type of Push	Type of Contact		Marking	Degree of Protection	Pilot Light Voltage	Catalog Number
		N.O.	N.C.				
	One flush green push* One extended red push** One white central pilot light block	1	1	**"I" (white) ***"O" (white)	IP66 IP69K	24	XB5AW73731B5
						120	XB5AW73731G5
						240	XB5AW73731M5

**Table 19.128: Three Button Push Buttons, Momentary (screw clamp terminal connections)**



Shape of Head	Type of Push	Type of Contact		Degree of Protection	Marking and Cap Color	Catalog Number
		N.O.	N.C.			
	Two flush pushes + one central projecting red push*	2	1	IP66 IP69K	White "I" on green background White "II" on green background *White "Stop" on red background	XB5AA71327
					Black "+" on white background White "≠" on black background *White "Stop" on red background	XB5AA711237

For Legends, see [XB5 Legend Holders](#), page 19-58 and [XB5 Legend Inserts](#), page 19-59.  
Caps, see [XB5 Accessories](#), page 19-60.



**Table 19.129: Non-Illuminated Trigger Action Emergency Stop Push Buttons, Ø 40 mm (Red) (screw clamp terminal connections)**

Shape of Head	Type of Push	Type of Contact		Catalog Number	Components
		N.O.	N.C.		
	Trigger action push-pull [42]	1	1	XB5AT845	(ZB5AZ105 + ZB5AT84)
	Trigger action turn-to-release [42]	1	1	XB5AS8445	(ZB5AZ105 + ZB5AS844)
		—	2	XB5AS8444	(ZB5AZ104 + ZB5AS844)
	Trigger action Key release (No. 455) [42]	1	1	XB5AS9445	(ZB5AZ105+ ZB5AS944)
	Trigger action Push-pull [42]	—	1	XB5AT842	(ZB5AZ102 + ZB5AT84)
	Trigger action Turn-to-release [42]	—	1	XB5AS8442	(ZB5AZ102 + ZB5AS844)
	Trigger action Key release (No. 455) [42]	—	1	XB5AS9442	(ZB5AZ102 + ZB5AS944)

**Table 19.130: Non-Illuminated Selector Switches and Key Switches (screw clamp terminal connections) [43]**

Shape of Head	Type of Operator	Type of Contact		Number and Type of Positions	Catalog Number	Components
		N.O.	N.C.			
	Standard lever, black	1	—	2-maintained		XB5AD21 (ZB5AZ101 + ZB5AD2)
		1	1	2-maintained		XB5AD25 (ZB5AZ105 + ZB5AD2)
		2	—	3-maintained		XB5AD33 (ZB5AZ103 + ZB5AD3)
3-momentary to center				XB5AD53 (ZB5AZ103 + ZB5AD5)		
	Extended lever, black	1	—	2-maintained		XB5AJ21 (ZB5AZ101 + ZB5AJ2)
		2	—	3-maintained		XB5AJ33 (ZB5AZ103 + ZB5AJ3)
				3-momentary to center		XB5AJ53 (ZB5AZ103 + ZB5AJ5)
	Key (No. 455)	1	—	2-maintained		XB5AG21 (ZB5AZ101 + ZB5AG2)
				2-momentary to left		XB5AG61 (ZB5AZ101 + ZB5AG6)
		2	—	3-maintained		XB5AG03 (ZB5AZ103 + ZB5AG0)
						XB5AG33 (ZB5AZ103 + ZB5AG3)

**NOTE:** The symbol indicates key withdrawal position(s).

For Legends, see [XB5 Legend Holders](#), page 19-58 and [XB5 Legend Inserts Only](#), page 19-59

[42] Trigger action mushroom heads are tamper proof in that a change of contact state is not possible by teasing or floating the operator. For emergency stop applications, always use a trigger action push button (per EN/IEC 13850).

[43] For contact configurations, see [Sequence of Contacts on Selector Switch Bodies](#), page 19-50.



XB5AVB1



XB5EVG1

**Table 19.131: Pilot Lights with Protected LED™ (screw clamp terminal connections) [44]**

Shape of Head	Supply Voltage	Color	Monolithic Units	Complete Units	Complete Unit Components
	24 Vac/Vdc	White	XB5EVB1	XB5AVB1	(ZB5AVB1 + ZB5AV013)
		Green	XB5EVB3	XB5AVB3	(ZB5AVB3 + ZB5AV033)
		Red	XB5EVB4	XB5AVB4	(ZB5AVB4 + ZB5AV043)
		Orange	XB5EVB5	XB5AVB5	(ZB5AVB5 + ZB5AV053)
		Blue	XB5EVB6	XB5AVB6	(ZB5AVB6 + ZB5AV063)
		Yellow	XB5EVB8	—	—
	110–120 Vac	White	XB5EVG1	XB5AVG1	(ZB5AVG1 + ZB5AV013)
		Green	XB5EVG3	XB5AVG3	(ZB5AVG3 + ZB5AV033)
		Red	XB5EVG4	XB5AVG4	(ZB5AVG4 + ZB5AV043)
		Orange	XB5EVG5	XB5AVG5	(ZB5AVG5 + ZB5AV053)
		Blue	XB5EVG6	XB5AVG6	(ZB5AVG6 + ZB5AV063)
		Yellow	XB5EVG8	—	—
	230–240 Vac	White	XB5EVM1	XB5AVM1	(ZB5AVM1 + ZB5AV013)
		Green	XB5EVM3	XB5AVM3	(ZB5AVM3 + ZB5AV033)
		Red	XB5EVM4	XB5AVM4	(ZB5AVM4 + ZB5AV043)
		Orange	XB5EVM5	XB5AVM5	(ZB5AVM5 + ZB5AV053)
		Blue	XB5EVM6	XB5AVM6	(ZB5AVM6 + ZB5AV063)
		Yellow	XB5EVM8	—	—

**Table 19.132: Pilot Lights for BA9s Bulb (screw clamp terminal connections)**

Shape of Head	Supply Voltage	Color	Catalog Number	Components
<b>Direct supply, for BA9s (incandescent, LED, neon) V &lt; 250 V, 2.4 W bulb (bulb not included) [45]</b>				
	< 250 Vac/Vdc	White	XB5AV61	(ZB5AV6 + ZB5AV01)
		Green	XB5AV63	(ZB5AV6 + ZB5AV03)
		Red	XB5AV64	(ZB5AV6 + ZB5AV04)
		Yellow	XB5AV65	(ZB5AV6 + ZB5AV05)
<b>Transformer type with 1.2 VA, 6 V secondary. BA9s incandescent bulb included</b>				
	110–120 Vac 50/60 Hz	White	XB5AV31	(ZB5AV3 + ZB5AV01)
		Green	XB5AV33	(ZB5AV3 + ZB5AV03)
		Red	XB5AV34	(ZB5AV3 + ZB5AV04)
		Yellow	XB5AV35	(ZB5AV3 + ZB5AV05)



XB5AV63



XB5AV34

**Table 19.133: Illuminated Push Buttons, Momentary (screw clamp terminal connections) [44]**

Shape of Head	Description	Type of Contact		Supply Voltage	Color of Push	Catalog Number	Components					
		N.O.	N.C.									
<b>Flush</b>												
	Protected LED	1	1	24 Vac/Vdc	White	XB5AW31B5	(ZB5AW0B15 + ZB5AW313)					
					Green	XB5AW33B5	(ZB5AW0B35 + ZB5AW333)					
					Red	XB5AW34B5	(ZB5AW0B45 + ZB5AW343)					
					Yellow	XB5AW35B5	(ZB5AW0B55 + ZB5AW353)					
					Blue	XB5AW36B5	(ZB5AW0B65 + ZB5AW363)					
					White	XB5AW31G5	(ZB5AW0G15 + ZB5AW313)					
		110–120 Vac	Green	XB5AW33G5	(ZB5AW0G35 + ZB5AW333)							
			Red	XB5AW34G5	(ZB5AW0G45 + ZB5AW343)							
			Yellow	XB5AW35G5	(ZB5AW0G55 + ZB5AW353)							
			Blue	XB5AW36G5	(ZB5AW0G65 + ZB5AW363)							
			White	XB5AW3165	(ZB5AW065 + ZB5AW31)							
			Green	XB5AW3365	(ZB5AW065 + ZB5AW33)							
Direct supply for BA9s 2.4 W max. bulb not included	1	1	< 250 Vac/Vdc	Red	XB5AW3465	(ZB5AW065 + ZB5AW34)						
				Yellow	XB5AW3565	(ZB5AW065 + ZB5AW35)						
				110–120 Vac 50/60 Hz	White	XB5AW3135	(ZB5AW035 + ZB5AW31)					
					Green	XB5AW3335	(ZB5AW035 + ZB5AW33)					
					Red	XB5AW3435	(ZB5AW035 + ZB5AW34)					
					Yellow	XB5AW3535	(ZB5AW035 + ZB5AW35)					
					230–240 Vac 50/60 Hz	White	XB5AW3145	(ZB5AW045 + ZB5AW31)				
						Green	XB5AW3345	(ZB5AW045 + ZB5AW33)				
				Red		XB5AW3445	(ZB5AW045 + ZB5AW34)					
				Yellow		XB5AW3545	(ZB5AW045 + ZB5AW35)					
				<b>Extended</b>								
						Protected LED	1	1	24 Vac/Vdc	White	XB5AW11B5	(ZB5AW0B15 + ZB5AW113)
Green	XB5AW13B5	(ZB5AW0B35 + ZB5AW133)										
Red	XB5AW14B5	(ZB5AW0B45 + ZB5AW143)										
Yellow	XB5AW15B5	(ZB5AW0B55 + ZB5AW153)										
Blue	XB5AW16B5	(ZB5AW0B65 + ZB5AW163)										
White	XB5AW11G5	(ZB5AW0G15 + ZB5AW113)										
110–120 Vac	Green	XB5AW13G5	(ZB5AW0G35 + ZB5AW133)									
	Red	XB5AW14G5	(ZB5AW0G45 + ZB5AW143)									
	Yellow	XB5AW15G5	(ZB5AW0G55 + ZB5AW153)									
	Blue	XB5AW16G5	(ZB5AW0G65 + ZB5AW163)									



XB5AW31B5



XB5AW3465



XB5AW3335

For legends, see [XB5 Legend Holders](#), page 19-58 and [XB5 Legend Inserts Only](#), page 19-59.  
For LEDs, see [LED, BA9s Base](#), page 19-134.

[44] For 240V LED, replace the "B" or "G" with "M". (Example: XB5APVB1 (24 V) to XB5APVM1 (240 Vac only))

[45] For bulb information, refer to [Table 19.184 BA9s Bulbs and Associated Accessories](#), page 19-61

**XB5 Non-Illuminated Operators**

**Table 19.134: Non-Illuminated Operators, Momentary—Unmarked**



Shape of Head	Type of Push	Cap Color	Catalog Number
	Flush, without color cap [46]	—	ZB5AA0
	Flush, with set of 6 color caps	6 colors [47]	ZB5AA9
	Flush	White	ZB5AA1
		Black	ZB5AA2
		Green	ZB5AA3
		Red	ZB5AA4
		Yellow	ZB5AA5
		Blue	ZB5AA6
	Flush with transparent cap, for insertion of legend [48]	Gray	ZB5AA8
		White	ZB5AA18
		Green	ZB5AA38
		Red	ZB5AA48
		Yellow	ZB5AA58
		Blue	ZB5AA68
	Extended	White	ZB5AL1
		Black	ZB5AL2
		Green	ZB5AL3
		Red	ZB5AL4
		Yellow	ZB5AL5
		Blue	ZB5AL6
	Booted Flush (clear) Cap color unobscured	White	ZB5APA1
		Black	ZB5APA2
		Green	ZB5APA3
		Red	ZB5APA4
		Yellow	ZB5APA5
		Blue	ZB5APA6
	Booted Extended (clear) Cap color unobscured	White	ZB5AP1
		Black	ZB5AP2
		Green	ZB5AP3
		Red	ZB5AP4
		Yellow	ZB5AP5
		Blue	ZB5AP6
	Booted (colored) Cap color unobscured	White	ZB5AP1S
		Black	ZB5AP2S
		Green	ZB5AP3S
		Red	ZB5AP4S
		Yellow	ZB5AP5S
		Blue	ZB5AP6S
	Booted (clear) for insertion of legend [48] Cap color unobscured	White	ZB5AP18
		Green	ZB5AP38
		Red	ZB5AP48
		Yellow	ZB5AP58
		Blue	ZB5AP68
		White	ZB5AA14
	Flush Plunger (with high guard)	Black	ZB5AA24
		Green	ZB5AA34
		Red	ZB5AA44
		Yellow	ZB5AA54
		Blue	ZB5AA64
		White	ZB5CA1
	Flush	Black	ZB5CA2
		Green	ZB5CA3
		Red	ZB5CA4
		Yellow	ZB5CA5
		Blue	ZB5CA6
		White	ZB5CL1
	Extended	Black	ZB5CL2
		Green	ZB5CL3
		Red	ZB5CL4
		Yellow	ZB5CL5
		Blue	ZB5CL6
		White	ZB5AA16
	Heads only Recessed (high guard)	Black	ZB5AA26
		Green	ZB5AA36
		Red	ZB5AA46
		Yellow	ZB5AA56
		Blue	ZB5AA66
		White	ZB5CA16
	Heads only Recessed (high guard)	Black	ZB5CA26
		Green	ZB5CA36
		Red	ZB5CA46
		Yellow	ZB5CA56
		Blue	ZB5CA66

For Legends, see [XB5 Legend Holders](#), page 19-58 and [XB5 Legend Inserts Only](#), page 19-59

[46] Order color cap separately, see [XB5 Accessories](#), page 19-60.  
 [47] Six colored caps included with head (white, black, green, red, yellow, blue).  
 [48] For legend ordering information see [XB5 Accessories](#), page 19-60.



**Table 19.135: Non-Illuminated Operators, Momentary—Premarked**

Shape of Head	Type of Push	Marking		Cap Color	Catalog Number	
		Text	Color			
	Flush	I	White	Green	ZB5AA331	
			Black	White	ZB5AA131	
		START	White	Green	ZB5AA333	
			Black	White	ZB5AA133	
		ON	White	Green	ZB5AA341	
			Black	White	ZB5AA141	
		T	White	Green	ZB5AA345	
		O	White	Black	Red	ZB5AA432
				Black	Black	ZB5AA232
		STOP	White	Red	ZB5AA434	
				Black	ZB5AA234	
		OFF	White	Red	ZB5AA435	
UP	Black	White	ZB5AA235			
DOWN	White	Black	Black	ZB5AA344		
		Black	White	ZB5AA334		
↑ [49]	White	Black	Black	ZB5AA335		
		Red	Black	ZB5AL432		
	Extended	O	White	Black	ZB5AL232	
				Red	ZB5AL434	
		STOP	White	Black	ZB5AL234	
OFF	White	Red	ZB5AL435			
		Black	ZB5AL235			
	Flush	I	White	Green	ZB5CA331	
				Red	ZB5CA432	

**Table 19.136: Mushroom Heads, Momentary**

Shape of Head	Diameter of Head	Color of Head	Catalog Number
	30 mm	Black	ZB5AC24
		Green	ZB5AC34
		Red	ZB5AC44
		Yellow	ZB5AC54
		Blue	ZB5AC64
		Black	ZB5AC2
	40 mm	Green	ZB5AC3
		Red	ZB5AC4
		Yellow	ZB5AC5
		Blue	ZB5AC6
		Black	ZB5AR2
		Green	ZB5AR3
	60 mm	Red	ZB5AR4
		Yellow	ZB5AR5
		Blue	ZB5AR6

For legends, see XB5 Legend Holders, page 19-58 and XB5 Legend Inserts Only, page 19-59

[49] Cap supplied not clipped-in, allowing orientation of arrow in any one of 4 directions:



ZB5AH04

**Table 19.137: Non-Illuminated Push-on/Push-off Operators**

Shape of Head	Type of Push	Color of Push	Catalog Number
	Flush	White	ZB5AH01
		Black	ZB5AH02
		Green	ZB5AH03
		Red	ZB5AH04
		Yellow	ZB5AH05
		Blue	ZB5AH06
	Extended	White	ZB5AH1
		Black	ZB5AH2
		Green	ZB5AH3
		Red	ZB5AH4
		Yellow	ZB5AH5
		Blue	ZB5AH6
	Flush	White	ZB5CH01
		Black	ZB5CH02
		Green	ZB5CH03
		Red	ZB5CH04
		Yellow	ZB5CH05
		Blue	ZB5CH06

**Table 19.138: Two Head Operators, Momentary**

Shape of Head	Description	Marking	Cap Color	Degree of Protection	Catalog Number
<b>No Marking</b>					
	Two flush	—	Green Red	IP66 IP69K	ZB5AA7340
		—	White Black		ZB5AA7120
	One flush One extended	—	Green Red	IP66 IP69K	ZB5AL7340
<b>Premarked</b>					
	Two flush	"I" (white) "O" (white)	Green Red	IP66 IP69K	ZB5AA7341
		"I" (black) "O" (white)	White Black		ZB5AA7121
	One flush One extended	"I" (white) "O" (white)	Green Red	IP66 IP69K	ZB5AL7341
<b>Without caps</b>					
	Two flush without caps	—	—	IP66 IP69K	ZB5AA79

**Table 19.139: Three Head Operators, Momentary**

Shape of Head	Description	Marking	Cap Color	Degree of Protection	Catalog Number
<b>Premarked</b>					
	Two flush + one central projecting red push marked "Stop"	"I" (white) "II" (white)	Green Green	IP66 IP69K	ZB5AA73132
		"←" (white) "→" (white)	Green Green		ZB5AA73133
		"↑" (white) "↓" (white)	Green Green		ZB5AA73134
		"+" (white) "-" (white)	Green Green		ZB5AA73135
		"+" (black) "-" (black)	White White		ZB5AA71115
		"↔" (black) "↔" (white)	White Black		ZB5AA71123
		"↑" (black) "↓" (white)	White Black		ZB5AA71124
		"I" (white) "I" (white)	Black Black		ZB5AA72124
<b>Without caps</b>					
	Two flush without caps	—	—	IP66 IP69K	ZB5AA791

For caps, see [XB5 Accessories](#), page 19-60



ZB5AL7341



ZB5AA7121



ZB5AA73133



ZB5AA71124



**XB5 Emergency Stop Operators**

**Table 19.140: Mushroom Heads for Maintained Push Buttons**



Shape of Head	Type of Push	Diameter of Head	Color	Catalog Number
<b>For use in Emergency Stop applications</b>				
	Trigger action Push-pull [50]	30 mm	Red	ZB5AT844
		40 mm	Red	ZB5AT84
		60 mm	Red	ZB5AX84
	Trigger action Turn-to-release [50]	30 mm	Red	ZB5AS834
		40 mm	Red	ZB5AS844
		60 mm	Red	ZB5AS864
	Trigger action Key release (No. 455) [50]	30 mm	Red	ZB5AS934
		40 mm	Red	ZB5AS944 [51]
		60 mm	Red	ZB5AS964
<b>For use in non-Emergency Stop applications</b>				
	Push-pull	30 mm	Black	ZB5AT24
		40 mm	Black	ZB5AT2
		60 mm	Black	ZB5AX2
	Turn-to-release	30 mm	Black	ZB5AS42
		40 mm	Black	ZB5AS52
		60 mm	Yellow	ZB5AS55
	Key release (No. 455)	30 mm	Black	ZB5AS62
		40 mm	Black	ZB5AS72
		60 mm	Black	ZB5AS12
	Key release (No. 455)	30 mm	Black	ZB5AS22
		40 mm	Black	ZB5AS12
		60 mm	Black	ZB5AS22



**Table 19.141: Circular Legends for Emergency Stop Mushroom Heads (yellow background)**

Diameter	Text	Catalog Number
90 mm	Blank	ZBY8101
	EMERGENCY STOP	ZBY8330
60 mm Bezeled	Blank	ZBY9121
	Emergency Stop	ZBY9320
	Prada de Emergencia	ZBY9420
	Not Halt	ZBY9220

For Legends, see XB5 Legend Holders, page 19-58 and XB5 Legend Inserts, page 19-59

[50] Trigger action mushroom heads are tamper proof in that a change of contact state is not possible by teasing or floating the operator. For emergency stop applications, always use a trigger action push button (per EN/IEC 13850).

[51] Other key numbers:

- key no. 421E: add the suffix 12 to the catalog number.
- key no. 458A: add the suffix 10 to the catalog number.
- key no. 520E: add the suffix 14 to the catalog number.
- key no. 3131A: add the suffix 20 to the catalog number.

Example: The catalog number for a Ø 40 mm red mushroom head for a trigger action, maintained push button, with release by key no. 421E becomes: ZB5AS94412.

**XB5 Selector Switches**

**Table 19.142: Non-Illuminated Selector Switches**

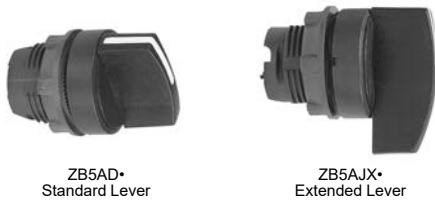

Color	Number and Type of Positions	Diagram	Standard Lever [52]	Extended Lever [52]
			Catalog Number	
Black	2-maintained		ZB5AD2	ZB5AJ2
Black	2-momentary from right to left		ZB5AD4	ZB5AJ4
Black	3-maintained		ZB5AD3	ZB5AJ3
Black	3-momentary to center		ZB5AD5	ZB5AJ5
Black	3-momentary from left to center		ZB5AD7	ZB5AJ7
Black	3-momentary from right to center		ZB5AD8	ZB5AJ8

**Table 19.143: Non-Illuminated Key Switches**



Type of Operator	Number and Type of Positions	Catalog Number [53]
2-maintained		ZB5AG2
		ZB5AG4
		ZB5AG02
2-momentary from right to left		ZB5AG6
	3-maintained	
		ZB5AG3
		ZB5AG5
		ZB5AG9
		ZB5AG09
		ZB5AG1
3-momentary from left to center		ZB5AG7
3-momentary to center		ZB5AG8
3-momentary from right to center		ZB5AG08
		ZB5AG05

Key (No. 455) [53]



NOTE: The symbol indicates key withdrawal position(s).

**Table 19.144: Sequence of Contacts on Selector Switch Bodies**

Unit Type	Selector Switches												
	2-position					3-position							
	315°	45°		315°	0°	45°							
Note: L=Left, C=Center, R=Right, O=Open, X=Closed													
Operator Plunger Position	Up												
	Down												
Contact Block Location	L	C	R	L	C	R	L	C	R	L	C	R	
Contacts	N.O.	O	O	O	X	X	X	X	O	O	O	X	X
	N.C.	X	X	X	O	O	O	O	X	X	X	X	O

For Selector Switch Sequence, see [Sequence of Contacts on Illuminated Selector Switch Bodies](#), page 19-33

[52] For colored lever, add the following code to the end of catalog number: 01—white, 03—green, 04—red, 05—yellow, 06—blue (Example: ZB5AD204).

[53] Other key numbers:

- key no. 421E: add the suffix 12 to the catalog number.
- key no. 458A: add the suffix 10 to the catalog number.
- key no. 520E: add the suffix 14 to the catalog number.
- key no. 3131A: add the suffix 20 to the catalog number.
- key no. 8D1: add the suffix D to the catalog number.

Example: The catalog number for a head with key no. 421E for a 2 position maintained, lockable selector switch, with key withdrawal from the left-hand position, becomes: ZB5AG212

**XB5 Specialty Operators**

**Table 19.145: Reset Operators**



XB5AA

Shape of Head	Actuation Distance		Text	Color	Catalog Number
	in	mm			
<b>Flush</b>	Adjustable Shaft Shaft only (short) is W40437632				
	0.67–4.72	17–120	Without	Green	XB5AA831
				Red	XB5AA841
				Blue	XB5AA861
			O	XB5AA84101	
			R	XB5AA86102	
	4.72–10.12	120–257	Without	Green	XB5AA832
				Red	XB5AA842
				Blue	XB5AA862
			O	XB5AA84201	
			R	XB5AA86202	
<b>Extended</b>					
	0.67–4.72	17–120	O	Red	XB5AL84101
	4.72–10.12	120–257	O	Red	XB5AL84201

**Table 19.146: Potentiometer Operator (with Mounting Collar)**



XB5AD912R1K

Shape of Head	Description	Application	Catalog Number
	For potentiometer with shaft length 1.73 to 1.97 in. (44 to 50 mm) (potentiometer not included)	For shaft Ø 0.25 in. (6.35 mm)	ZB5AD922
		For shaft Ø 0.24 in. (6 mm)	ZB5AD912

**Table 19.147: Complete Potentiometers**

Description	Resistance (k Ω)	Weight (kg/lb)	Catalog Number
+/- 10% linear mode precision complete potentiometer with screw terminals	1	0.048/0.106	XB5AD912R1K
	4.7	0.048/0.106	XB5AD912R4K7
	10	0.048/0.106	XB5AD912R10K
	47	0.048/0.106	XB5AD912R47K
	100	0.048/0.106	XB5AD912R100K
	470	0.048/0.106	XB5AD912R470K

**Table 19.148: Joystick, 54 mm, Extended Operating Shaft. Do not use standard contact blocks ZBE10• (single) or ZBE20• (double)**



XD5PA12

Description	Contact Operation	Action	Catalog Number
	1 step 1 N.O. contact per direction	Maintained	XD5PA12
		Momentary	XD5PA22
	1 step 1 N.O. contact per direction	Maintained	XD5PA14
		Momentary	XD5PA24

**Table 19.149: Legends for Joystick**

Description	For use with	Color	Catalog Number
Legends 30 x 48 mm for engraving	2 direction	Black one side Red reverse	ZBG2201
		White one side Yellow reverse	ZBG2401
Legends 48 x 48 mm for engraving	4 direction	Black one side Red reverse	ZBG4201
		White one side Yellow reverse	ZBG4401

**Table 19.150: Hour Counters (UR E191025, XHNR2 and XHNR8)**



XB5DS•

Characteristics	Supply Voltage	Catalog Number
Indication 0–9999.9 (IP40 NEMA 1)	12–24 Vdc or Vac, 50/60 Hz	XB5DSB
	120 Vac, 60 Hz	XB5DSG
	230–240 Vac, 50 Hz	XB5DSM

**Table 19.151: Buzzer (UR E191025, XHNR2 and XHNR8)**



XB5KS•

Characteristics	Supply Voltage	Catalog Number
85 db buzzer:4kHz, continuous or intermittent (IP40 NEMA 1)	24 Vdc or Vac, 50/60 Hz	XB5KSB
	120 Vac, 60 Hz	XB5KSG

**Table 19.152: Two Position Toggle Switch**



ZB5AD28

Shape of Head	Color	Type of Positions	Catalog Number
	Black	Maintained	ZB5AD28
	Black	Momentary	ZB5AD48

For legends, see XB5 Legend Holders, page 19-58, XB5 Legend Inserts, page 19-59, and Table 19.179 Sheets of Legends for Push Buttons, Switches, and Pilot Lights, page 19-60.

**XB5 Pilot Lights**

**Table 19.153: Pilot Light Heads**



Shape of Head	For use with Body Comprising Light Module Type	Color of Lens	Catalog Number
	Protected LED™ only	White Green Red Yellow Blue	ZB5AV013 ZB5AV033 ZB5AV043 ZB5AV053 ZB5AV063
	Protected LED only Fresnel (jeweled) lens [54]	White Green Red Amber Blue	ZB5AV013S ZB5AV033S ZB5AV043S ZB5AV053S ZB5AV063S
	For BA9s incandescent bulb, neon or LED only [55]	White Green Red Yellow Blue Clear	ZB5AV01 ZB5AV03 ZB5AV04 ZB5AV05 ZB5AV06 ZB5AV07
	For BA9s incandescent bulb, neon or LED Fresnel (jeweled) lens [55]	White Green Red Amber Blue Clear	ZB5AV01S ZB5AV03S ZB5AV04S ZB5AV05S ZB5AV06S ZB5AV07S
	Protected LED only	White Green Red Yellow Blue	ZB5CV013 ZB5CV033 ZB5CV043 ZB5CV053 ZB5CV063

For legends, refer to XB5 Legend Holders, page 19-58, XB5 Legend Inserts, page 19-59, and Table 19.179 Sheets of Legends for Push Buttons, Switches, and Pilot Lights, page 19-60

**Table 19.154: Complete Bodies (Mounting Collar + Light Module for BA9s Incandescent Bulb, Neon or LED)**



Description	Light Source	Supply Voltage (V)	Catalog Number
<b>Screw clamp terminal connections</b>			
Direct supply	BA9s bulb 2.4 W max. Not included [55]	<250	ZB5AV6
Direct supply	BA9s incandescent, bulb included	24 V 2 W	ZB5AV624
Direct supply	BA9s incandescent, bulb included	120 V 2.4 W	ZB5AV6120
Transformer type 1.2 VA, 6 V secondary	BA9s incandescent bulb included	110–120 Vac, 50/60 Hz	ZB5AV3
		230–240 Vac, 50/60 Hz	ZB5AV4
		400–50 Hz	ZB5AV5
		440–480 Vac, 60 Hz	ZB5AV8
		550–600 Vac, 60 Hz	ZB5AV9

**Table 19.155: Complete Bodies (Mounting Collar + Protected LED™ Light Module) [56][57]**



Light Source	Supply Voltage	Color of Light Source	Catalog Number	
<b>Screw clamp terminal connections</b>				
	12 Vac/Vdc	White	ZB5AVJ1	
		Green	ZB5AVJ3	
		Red	ZB5AVJ4	
		Yellow	ZB5AVJ5	
		Blue	ZB5AVJ6	
		White	ZB5AVB1	
	24 Vac/Vdc	Green	ZB5AVB3	
		Red	ZB5AVB4	
		Yellow	ZB5AVB5	
		Blue	ZB5AVB6	
		24–120 Vac/Vdc	White	ZB5AVBG1
			Green	ZB5AVBG3
Red	ZB5AVBG4			
Yellow	ZB5AVBG5			
Blue	ZB5AVBG6			
110–120 Vac	White		ZB5AVG1	
	Green	ZB5AVG3		
	Red	ZB5AVG4		
	Yellow	ZB5AVG5		
	Blue	ZB5AVG6		
		24 Vac/Vdc	White	ZB5AV18B1
Green			ZB5AV18B3	
Red			ZB5AV18B4	
Yellow			ZB5AV18B5	
Blue			ZB5AV18B6	
White			ZB5AV18G1	
110–120 Vac		Green	ZB5AV18G3	
		Red	ZB5AV18G4	
		Yellow	ZB5AV18G5	
		Blue	ZB5AV18G6	

[54] For use in bright ambient conditions (i.e., sunlight).

[55] Order bulb separately; see Table 19.184 BA9s Bulbs, page 19-61. For BA9 LED, see Lamps, BA9s Base, page 19-134.

[56] For Quick-Connect version, add "3" to the end of the catalog number Example: ZB5AVJ13 (Quick-Connect size 1 x 0.250" or 2 x 0.110").

[57] For 240 V LED, replace the "B" or "G" with "M". (Example: ZB5AVB1 (24V) to ZB5AVM1 (240V))



**XB5 Illuminated Operators**

**Table 19.156: Heads for Momentary Illuminated Push Buttons**

Shape of Head	Type of Push	Color	Catalog Number
<b>Only use with Protected LED™ light modules</b>			
	Flush	White	ZB5AW313
		Green	ZB5AW333
		Red	ZB5AW343
		Yellow	ZB5AW353
	Flush with clear boot	Blue	ZB5AW363
		White	ZB5AW513
		Green	ZB5AW533
		Red	ZB5AW543
	Flush for insertion of legend	Yellow	ZB5AW553
		Blue	ZB5AW563
		White	ZB5AA18
		Green	ZB5AA38
	Extended	Red	ZB5AA48
		Yellow	ZB5AA58
		Blue	ZB5AA68
		White	ZB5AW113
	Extended	Green	ZB5AW133
		Red	ZB5AW143
		Yellow	ZB5AW153
		Blue	ZB5AW163
	Flush for insertion of legend	White	ZB5CW313
		Green	ZB5CW333
		Red	ZB5CW343
		Yellow	ZB5CW353
	Extended	Blue	ZB5CW363
		White	ZB5CW113
		Green	ZB5CW133
		Red	ZB5CW143
	Extended	Yellow	ZB5CW153
		Blue	ZB5CW163
		White	ZB5AW31
		Green	ZB5AW33
	Flush	Red	ZB5AW34
		Yellow	ZB5AW35
		Blue	ZB5AW36
		Clear	ZB5AW37
	Extended	White	ZB5AW11
		Green	ZB5AW13
		Red	ZB5AW14
		Yellow	ZB5AW15
	Extended	Blue	ZB5AW16
		Clear	ZB5AW17

**Table 19.157: Illuminated Push-on/Push-off Operators**

Shape of Head	Type of Push	Color of Lens	Catalog Number
<b>Only use with Protected LED light modules</b>			
	Flush	White	ZB5AH013
		Green	ZB5AH033
		Red	ZB5AH043
		Yellow	ZB5AH053
	Extended	Blue	ZB5AH063
		White	ZB5AH13
		Green	ZB5AH33
		Red	ZB5AH43
	Extended	Yellow	ZB5AH53
		Blue	ZB5AH63

For legends, refer to XB5 Legend Holders, page 19-58, XB5 Legend Inserts, page 19-59, and Table 19.179 Sheets of Legends for Push Buttons, Switches, and Pilot Lights, page 19-60



ZB5AW33









ZB5AW7A3741



ZB5AW7A1721

**Table 19.158: Two Button with Clear Pilot Light, Momentary**

Shape of Head	Description	Marking	Cap Color	Degree of Protection	Catalog Number
<b>No Marking</b>					
	Two flush	—	Green Red	IP66 IP69K	ZB5AW7A3740
		—	White Black		ZB5AW7A1720
	One flush One extended	—	Green Red		ZB5AW7L3740
<b>Premarked</b>					
	Two flush	"I" (white) "O" (white)	Green Red	IP66 IP69K	ZB5AW7A3741
		"I" (black) "O" (white)	White Black		ZB5AW7A1721
	One flush One extended	"I" (white) "O" (white)	Green Red		ZB5AW7L3741
	Two flush	"i" (black) "I" (white)	White Black		ZB5AW7A1724
	Two flush	"+" (black) "-." (black)	White White		ZB5AW7A1715
<b>Without caps</b>					
Two flush without caps		—	—	IP66, IP69K	ZB5AW7A9

**Table 19.159: Heads for Maintained Illuminated Push Buttons**

Shape of Head	Type of Push	Color	Catalog Number
<b>Only use with Protected LED light modules</b>			
	Turn-to-Release Mushroom (40 mm)	White	ZB5AW713
		Green	ZB5AW733
		Red	ZB5AW743
		Yellow	ZB5AW753
		Blue	ZB5AW763

**Table 19.160: Emergency Stop, Trigger Action and Mech Latching Push Button with Mech State Indicator for Elevator Inspection Box Applications—Heads Only**

Shape of Head	Type of Reset	Color	Catalog Number
	Push-pull (40 mm)	Red	ZB5AT8643M

NOTE: ZB5AT8643M not to be used with ZBZ16\* guard.

**Table 19.161: Illuminated Selector Switches, Standard Lever**

Shape of Head	Number and Type of Positions	Catalog Number [58]
<b>Only use with Protected LED light modules</b>		
	2-maintained	ZB5AK12•3
	2-momentary from right to left	ZB5AK14•3
	3-maintained	ZB5AK13•3
	3-momentary to center	ZB5AK15•3
	3-momentary from right to center	ZB5AK18•3
	3-momentary from left to center	ZB5AK17•3

**Table 19.162: Sequence of Contacts on Selector Switch Bodies**

Unit Type	Selector Switches													
	2-position						3-position							
Operator Plunger Position	315°		45°		315°		0°		45°		45°			
	Up	[Diagram]		[Diagram]		[Diagram]		[Diagram]		[Diagram]		[Diagram]		
Down	[Diagram]		[Diagram]		[Diagram]		[Diagram]		[Diagram]		[Diagram]			
Contact Block Location	L	C	R	L	C	R	L	C	R	L	C	R		
Contacts	N.O.	O	O	O	X	X	X	X	O	O	O	X	X	
	N.C.	X	X	X	O	O	O	O	X	X	X	X	O	O

For legends, see XB5 Legend Holders, page 19-58, XB5 Legend Inserts, page 19-59, and Table 19.179 Sheets of Legends for Push Buttons, Switches, and Pilot Lights, page 19-60.  
For Caps, see Table 19.189 Lens Caps, page 19-62

[58] • Designate color as follows: 1—white, 3—green, 4—red, 5—yellow, 6—blue

**XB5 Electrical Components**

**NOTE:** For the Quick-Connect version, add the numeral **3** to the end of the number.  
Example: ZB5AZ1013 (Quick-Connect size 1 x 0.250" or 2 x 0.110").

**Table 19.163: Contact Blocks**  
(Mounting Collar with Contact Blocks) [59] [60] [61]



Description	Type of Contact		Catalog Number
	N.O.	N.C.	
Screw clamp terminal connections	1	—	ZB5AZ101
	—	1	ZB5AZ102
	2	—	ZB5AZ103
	—	2	ZB5AZ104
	1	1	ZB5AZ105
	1	2	ZB5AZ141

**Table 19.164: Complete Bodies**  
(Mounting Collar + Single Contact Block + Light Module with Protected LED™)



Light Source	Type of Contact [62]		Color	Supply Voltage [63]	
	N.O.	N.C.		24 Vac/Vdc	110–120 Vac
<b>Screw clamp terminal connections</b>					
<b>Protected LED</b>	1	—	White	ZB5AW0B11	ZB5AW0G11
			Green	ZB5AW0B31	ZB5AW0G31
			Red	ZB5AW0B41	ZB5AW0G41
			Yellow	ZB5AW0B51	ZB5AW0G51
			Blue	ZB5AW0B61	ZB5AW0G61
	—	1	White	ZB5AW0B12	ZB5AW0G12
			Green	ZB5AW0B32	ZB5AW0G32
			Red	ZB5AW0B42	ZB5AW0G42
			Yellow	ZB5AW0B52	ZB5AW0G52
			Blue	ZB5AW0B62	ZB5AW0G62
	2	—	White	ZB5AW0B13	ZB5AW0G13
			Green	ZB5AW0B33	ZB5AW0G33
			Red	ZB5AW0B43	ZB5AW0G43
			Yellow	ZB5AW0B53	ZB5AW0G53
			Blue	ZB5AW0B63	ZB5AW0G63
	1	1	White	ZB5AW0B15	ZB5AW0G15
			Green	ZB5AW0B35	ZB5AW0G35
			Red	ZB5AW0B45	ZB5AW0G45
			Yellow	ZB5AW0B55	ZB5AW0G55
			Blue	ZB5AW0B65	ZB5AW0G65

For LEDs, see [LED](#), [BA9s Base](#), page 19-134.

**Table 19.165: Mounting Collar, Contact Block and Light Module**  
(with screw clamp terminal connections)



Supply	Light Source	Supply Voltage	Type of Contact [62]		Color of Light Source	Catalog Number
			N.O.	N.C.		
<b>Screw clamp terminal connections</b>						
Direct supply	BA9s 2.4 W max. bulb Not included [64]	< 250 Vac/ Vdc	1	—	—	ZB5AW061
			—	1	—	ZB5AW062
			2	—	—	ZB5AW063
			1	1	—	ZB5AW065
Transformer type 1.2 VA, 6 V secondary	BA9s incandescent bulb included	110–120 Vac 50/60 Hz	1	—	—	ZB5AW031
			1	1	—	ZB5AW035
			1	—	—	ZB5AW041
			1	1	—	ZB5AW045

[59] For Ring Tongue compatible blocks add "9" to the end of the catalog number (Example: ZB5AZ1029).  
 [60] Electrical components with connection by printed circuit board pins are available. Refer to Catalog [9001CT0001](#) for more information.  
 [61] Electrical components with connection by plug-in connector are available. Refer to Catalog [9001CT0001](#) for more information.  
 [62] Can be fitted with additional contact blocks, see [Table 19.167 Add-On Contact Blocks](#), page 19-56.  
 [63] For 240V LED, replace the "B" or "G" with "M". (Example: change "ZB5AW0B11 (24 V) to ZB5AW0M11 (240 V))  
 [64] Order bulbs separately, see [Table 19.184 BA9s Bulbs and Associated Accessories](#), page 19-61



ZB5AZ009



ZBE101



ZBE203



ZBVB•



**Table 19.166: Body/Mounting Collar**

For use with	Catalog Number
Electrical block (contact or light module)	ZB5AZ009

**Table 19.167: Add-On Contact Block (with screw clamp terminal connections)** <sup>[65]</sup>  
<sup>[66]</sup>

Description	Type of Contact		Catalog Number
	N.O.	N.C.	
Standard <b>single</b> contact blocks <sup>[67][68]</sup>	1	—	ZBE101
	—	1	ZBE102
	2	—	ZBE203
Standard <b>double</b> contact blocks <sup>[67][68]</sup>	—	2	ZBE204
	1	1	ZBE205
	1	—	ZBE1016
Special contact blocks for low-power switching <sup>[69]</sup>	—	1	ZBE1026
	1	—	ZBE1016P
Low-power switching	Dusty environment <sup>[69]</sup> (IP5X, 50 µm dust)	—	ZBE1026P
	—	1	ZBE1026P
Staggered contacts	Early make N.O.	—	ZBE201
	Late break N.C.	1	ZBE202
	Overlapping N.O. + N.C.	1	ZB4BZ106
	Staggered N.O. + N.O.	—	ZB4BZ107

**Table 19.168: Light Modules (with screw clamp terminal connections)** <sup>[65][66]</sup>

Description	Supply Voltage	Color of Light Source	Catalog Number
	12 Vac/Vdc	White	ZBVJ1
		Green	ZBVJ3
		Red	ZBVJ4
		Yellow	ZBVJ5
		Blue	ZBVJ6
		White	ZBVB1
	24 Vac/Vdc	Green	ZBVB3
		Red	ZBVB4
		Yellow	ZBVB5
		Blue	ZBVB6
		White	ZBVG1
		Green	ZBVG3
	110–120 Vac	Red	ZBVG4
		Yellow	ZBVG5
		Blue	ZBVG6
		White	ZBVBG1
		Green	ZBVBG3
		Red	ZBVBG4
	24–120 Vac/Vdc	Yellow	ZBVBG5
		Blue	ZBVBG6
		White	ZBVM1
		Green	ZBVM3
		Red	ZBVM4
		Yellow	ZBVM5
	230–240 Vac	Blue	ZBVM6
		—	ZBV6
Direct supply for BA9s (2.4 W max. bulb not included—see Table 19.184 BA9s Bulbs and Associated Accessories, page 19-61)	< 250 Vac/Vdc	—	ZBV6

For LEDs, see LED, BA9s Base, page 19-134.

[65] Electrical components with connection by printed circuit board pins are available. Refer to Catalog [9001CT0001](#) for more details.

[66] Electrical components with connection by plug-in connector are available. Refer to Catalog [9001CT0001](#) for more details.

[67] For Quick-Connect version add "3" to the end of the catalog number (Example: ZBE1013) (Quick-Connect size 1 x 0.250" or 2 x 0.110").

[68] For Ring Tongue compatible blocks add "9" to the end of the catalog number (Example: ZBE1029).

[69] Cannot stack additional contact blocks onto these blocks.





ZB5AZ009



ZBE1015





ZB4BZ1015

**Table 19.169: Body/Mounting Collar**

For use with	Catalog Number
Contact block or light module	ZB5AZ009

**Table 19.170: Contact Blocks [70]**

Spring Terminal Connections, Contacts for Standard Applications				
Description	Type of contact	 		Catalog Number
		N.O.	N.C.	
Contact blocks	Single	1	–	ZBE1015
		–	1	ZBE1025
	Single with body/mounting collar	1	–	ZB4BZ1015
		–	1	ZB4BZ1025
		2	–	ZB4BZ1035
		–	2	ZB4BZ1045
		1	1	ZB4BZ1055
		–	–	

**Table 19.171: Light Modules [70]**

Spring Terminal Connections			
Description	Supply voltage	Color of light source	Catalog Number
<b>Integral LED</b> (to combine with heads for integral LED) 	12 Vac/Vdc	White	ZBVJ15
		Green	ZBVJ35
		Red	ZBVJ45
		Orange	ZBVJ55
		Blue	ZBVJ65
		White	ZBVB15
	24 Vac/Vdc	Green	ZBVB35
		Red	ZBVB45
		Orange	ZBVB55
		Blue	ZBVB65
		White	ZBVG15
		Green	ZBVG35
	110–120 Vac	Red	ZBVG45
		Orange	ZBVG55
		Blue	ZBVG65
		White	ZBVM15
	230–240 Vac	Green	ZBVM35
		Red	ZBVM45
		Orange	ZBVM55
		Blue	ZBVM65

[70] Additional blocks **cannot** be attached to the back of these contact blocks or light modules. However, spring terminal contact blocks can be mounted behind screw terminal contact blocks.

**XB5 Legend Holders**

**Table 19.172: Standard (30 x 40 mm) Legend Holders for 8 x 27 mm Legends**



Description	Legend		Catalog Number
	Color	Text	
Without legend [71]	—	—	ZBZ32
With blank legend (for engraving)	Black or red background	—	ZBY2101
	White or yellow background	—	ZBY4101
Custom Legend (Specify Engraving) 2 lines of 11 characters (including spaces) maximum per line	Black background	White	ZBY2002
	Red background	White	ZBY2004
	White background	Black	ZBY4001
	Yellow background	Black	ZBY4005
With legend marked with international language	Black or red background [72]	O (black background)	ZBY2146
		O (red background)	ZBY2931
		I	ZBY2147
		II	ZBY2148
		O-I	ZBY2178
		I-II	ZBY2179
		I-O-II	ZBY2186
		With legend marked with English language	Black or red background [72]
AUTO-HAND	ZBY2364		
AUTO-O-HAND	ZBY2385		
CLOSE	ZBY2314		
DOWN	ZBY2308		
EMERGENCY STOP	ZBY2330		
FAST	ZBY2328		
FORWARD	ZBY2305		
FOR-REV	ZBY2371		
HAND	ZBY2316		
HAND-OFF-AUTO	ZBY2387		
INCH	ZBY2321		
JOG	ZBY2382		
LEFT	ZBY2310		
OFF	ZBY2312		
OFF-ON	ZBY2367		
ON	ZBY2311		
OPEN	ZBY2313		
POWER ON	ZBY2326		
RESET (red background)	ZBY2323		
RESET (black background)	ZBY2322		
REVERSE	ZBY2306		
RIGHT	ZBY2309		
RUN	ZBY2334		
SLOW	ZBY2327		
START	ZBY2303		
STOP	ZBY2304		
STOP-START	ZBY2366		
UP	ZBY2307		

**Table 19.173: Large (30 x 50 mm) Legend Holders for 18 x 27 mm Legends**

Description [73]	Color	Catalog Number
Without legend insert	—	ZBZ33
With blank legend insert	Black or red background	ZBY6101
	White or yellow background	ZBY6102

**Table 19.174: 30 x 40 mm legend holder (flush mounting with bezel) for 8 x 27 mm legends**

Description [73]	Color	Catalog Number
Without legend	—	ZBZ34
With blank legend	Black or red background	ZBY2H101
	White or yellow background	ZBY4H101

**Table 19.175: 30 x 50 mm legend holder (flush mounting with bezel) for 18 x 27 mm legends**

Description [73]	Color	Catalog Number
Without legend	—	ZBZ35
With blank legend	Black or red background	ZBY6H101
	White or yellow background	ZBY6H102

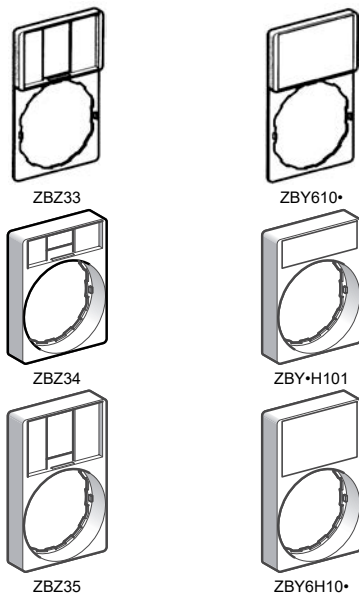

[71] For legends, see XB5 Legend Inserts Only, page 19-59.

[72] Start functions: white letters on black background. Stop functions: white letters on red background (unless otherwise specified above).

[73] For custom legends, see Table 19.179 Sheets of Legends for Push Buttons, Switches, and Pilot Lights, page 19-60

**XB5 Legend Inserts**

**Table 19.176: Marked Legends for 8 x 27 mm (for 30 x 40 mm legend holders ZBZ32)**



Color	Marking	Text	Catalog Number
Black or red background [74]	International	O (black background)	ZBY02146
		O (red background)	ZBY02931
		I	ZBY02147
		II	ZBY02148
		O-I	ZBY02178
		I-II	ZBY02179
	I-O-II	ZBY02186	
	English	AUTO	ZBY02115
		AUTO-HAND	ZBY02364
		AUTO-O-HAND	ZBY02385
		CLOSE	ZBY02314
		DOWN	ZBY02308
		EMERGENCY STOP	ZBY02330
		FAST	ZBY02328
		FORWARD	ZBY02305
		FOR-REV	ZBY02371
		HAND	ZBY02316
		HAND-OFF-AUTO	ZBY02387
		INCH	ZBY02321
		JOG	ZBY02382
		LEFT	ZBY02310
		OFF	ZBY02312
		OFF-ON	ZBY02367
		ON	ZBY02311
		OPEN	ZBY02313
		POWER ON	ZBY02326
		RESET (red background)	ZBY02323
		RESET (black background)	ZBY02322
		REVERSE	ZBY02306
		RIGHT	ZBY02309
		RUN	ZBY02334
		SLOW	ZBY02327
		START	ZBY02303
		STOP	ZBY02304
STOP-START		ZBY02366	
UP	ZBY02307		

**Table 19.177: Legends for Customer Engraving (inserts only)**

Description	For use with	Color	Text Color	Catalog Number
8 x 27 mm	30 x 40 mm legend holders	Black or red background	White	ZBY0101
		White or yellow background	Black	ZBY0102
18 x 27 mm	30 x 50 mm legend holders	Black or red background	White	ZBY5101
		White or yellow background	Black	ZBY5102

**Table 19.178: Legends for Factory Engraving (inserts only)**

Description	For use with	Color	Text Color	Catalog Number
8 x 27 mm Custom Legend/Insert Only (Specify Engraving) 2 lines of 11 characters (including spaces) maximum per line (Example: ZBY01002 marked "Robot")	30 x 40 mm legend holders	Black background	White	ZBY01002
		Red background	White	ZBY01004
		White background	Black	ZBY01001
		Yellow background	Black	ZBY01005
18 x 27 mm Custom Legend/Insert Only (Specify Engraving) 3 lines of 11 characters (including spaces) maximum per line (Example: ZBY05002 marked "Robot")	30 x 50 mm legend holders	Black background	White	ZBY05002
		Red background	White	ZBY05004
		White background	Black	ZBY05001
		Yellow background	Black	ZBY05005

[74] Start functions: white letters on black background. Stop functions: white letters on red background (unless otherwise specified above).

**XB5 Accessories**

**Table 19.179: Sheets of Legends for Push Buttons, Switches, and Pilot Lights**

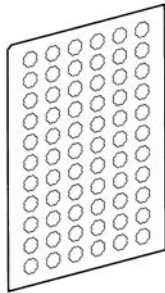

ZBY1101

Description	Marking	Text	Catalog Number	
Sheets of 66 circular peel-off transparent self-adhesive legends	Blank Round		ZBY1101	
	Blank-Square legends		ZBCY1101	
	International		O	ZBY1146
			I	ZBY1147
			II	ZBY1148
			III	ZBY1149
			STOP	ZBY1304
			→	ZBY1912
	English		HAND	ZBY1316
			OFF	ZBY1312
			ON	ZBY1311
			START	ZBY1303

**Table 19.180: Push Button Caps—Unmarked**

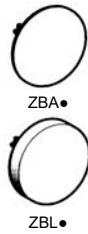

For use with	Type of Push	Color	Catalog Number
ZB4BA0 push button heads	Flush	White	ZBA1
		Black	ZBA2
		Green	ZBA3
		Red	ZBA4
		Yellow	ZBA5
		Blue	ZBA6
		6 colors [75]	ZBA9
	Extended	White	ZBL1
		Black	ZBL2
		Green	ZBL3
		Red	ZBL4
		Yellow	ZBL5
		Blue	ZBL6
			6 colors [75]

**Table 19.181: Push Button Caps—Marked**



ZBA•33

For use with	Type of Push	Marking		Cap Color	Catalog Number
		Text [76]	Color		
ZB4BA0 push button heads	Flush	I [77]	White	Green	ZBA331
			Black	White	ZBA131
		START [77]	White	Green	ZBA333
			Black	White	ZBA133
		ON	White	Green	ZBA341
			Black	White	ZBA141
		UP [77]	Black	White	ZBA343
		DOWN [77]	White	Black	ZBA344
		⊕ [77]	White	Green	ZBA345
		⊖ [77]	White	Black	ZBA245
		⬇ [77]	White	Green	ZBA346
		↑	Black	White	ZBA334 [78]
			White	Black	ZBA335 [78]
		O [77]	White	Red	ZBA432
				Black	ZBA232
		STOP [77]	White	Red	ZBA434
				Black	ZBA234
		OFF	White	Red	ZBA435
				Black	ZBA235
		R [77]	White	Blue	ZBA639

[75] Set of 6 different colored caps: white, black, green, red, yellow, blue.

[76] Start functions: white letters on black background. Stop functions: white letters on red background (unless otherwise specified).

[77] Double injection molded marking.

[78] Cap supplied not clipped-in, allowing orientation of arrow in any one of 4 directions: ↑, ↓, ←, or →

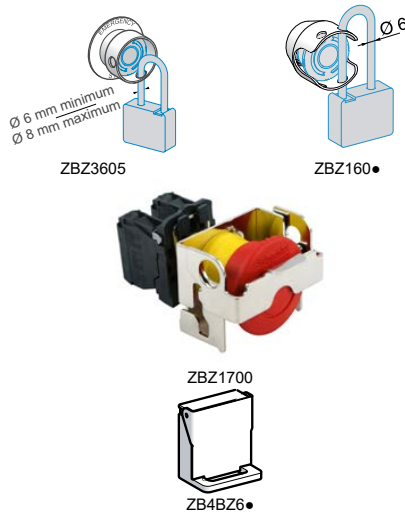

**Table 19.182: Multiple-head and XB5R Push Button Caps**<sup>[79]</sup>

For use with	Type of Push	Marking	Cap Color	Catalog Number
Double push button heads Tripe push button heads ZB4RZA0 ZB5RZA0	Flush	Unmarked	White	ZBA71
		"I" black		ZBA7131
		→ black		ZBA7134
		"+" black		ZBA7138
		Unmarked		ZBA72
		"O" white	Black	ZBA7232
		"+" white		ZBA7233
		⇔ white		ZBA7235
		"I" white		ZBA7237
		Unmarked		ZBA73
		"I" white	Green	ZBA7331
		"+" white		ZBA7333
		↑ white		ZBA7335
		"I" white		ZBA7336
		Unmarked		ZBA74
		"O" white	Red	ZBA7432
		Unmarked		ZBA75
		Unmarked	Yellow	ZBA76
		Unmarked	Blue	ZBA77
		Assorted	10 colors <sup>[80]</sup>	ZBA79

**Table 19.183: Accessories**

Description	Application	Color	Catalog Number
Padlocking kit Conforming to EN/ISO 13850 <sup>[81]</sup> (See legends below)	For Emergency Stop function only, with the following Ø 40 trigger-action push buttons: XB5AT8•, XB5AS8•, XB5AS9•, ZB5AT8•, ZB5AS8•, ZB5AS9•	Yellow	ZBZ3605
Metal guards Padlockable	For Emergency Stop function only with the following Ø 40 mm trigger-action push buttons: XB5AT8•, XB5AS8•, XB5AS9•, ZB5AT8• (except ZB5AT8643M), ZB5AS8•, ZB5AS9•	Chrome Plated	ZBZ1600
		Black	ZBZ1602
		Red	ZBZ1604
		Yellow	ZBZ1605
		Blue	ZBZ1606
Plastic guards <sup>[82]</sup>	For Emergency Stop function with XB4 and XB5 E-Stop 30 mm and 40 mm operators	Chrome plated	ZBZ1700
	Round Guard for ZB4BS5430, 2.5" dia EMO Mushroom Operators	Yellow	ZB4B21905
	Narrow Flange Guard for ZB4BS5430 or ZB4BS84430 EMO Mushroom Operators <sup>[83]</sup>	Yellow	ZB4B22005
Padlockable flaps	For push buttons	Black	ZB4BZ62
		Red	ZB4BZ64
		Black	ZB5SZ3
Plastic blanking plug, round <sup>[84]</sup>	For Ø 22 mm units with round heads	Black	ZB5SZ3
Plastic blanking plug, square <sup>[84]</sup>	For Ø 22 mm units with square heads	Black	ZB5SZ5
Square insert	To give square appearance to ZB5A round heads	Black	ZB5AZ31
Mounting nut	Operator	—	ZB5AZ901
Tool	For tightening mounting nut ZB5AZ901	—	ZB5AZ905
Plate	Anti-rotation of head	—	ZB5AZ902



**Table 19.184: BA9s Bulbs and Associated Accessories**

Description	Characteristics	Catalog Number
Replacement bulbs (Type BA9s) Incandescent	6 V, 1.2 W	DL1CB006
	12 V, 2 W	DL1CE012
	24 V, 2 W	DL1CE024
	120–130 V, 2.4 W	DL1CE130
	120–130 V, 1.8 mA	DL1CF110
Neon bulbs	230–240 V, 1.8 mA	DL1CF220
	—	XBFX13
Bulb extractor	—	ZBZ8
Lens cap tightening tool	Illuminated push buttons with flush push	ZBZ8
Power driver bits for mounting and wiring (package of 5)	Cross headed screw (POZIDRIV type 1)	ZB4BZ905
Mounting Adapter	For mounting 22 mm push button in 30 mm KO	ZBZ41

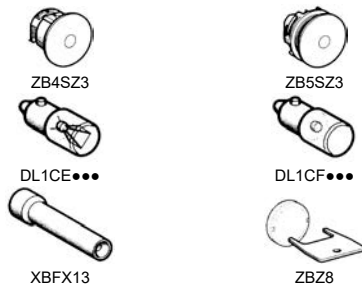

**Table 19.185: Bellows Seals for Harsh Environments** <sup>[85]</sup>

Description	For use with	Color & Material	Sold in Lots of	Catalog Number
Bellows seals for harsh environments (Humidity, dust, high-pressure cleaning)	Any Harmony XB4 metal, mushroom head push button Ø 40 mm or Ø 60 mm (except ZB4BR•16)	Red Silicone	2	ZBZ48
		Black EPDM	2	ZBZ28
		Black EPDM	2	ZBZ58

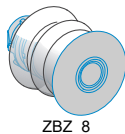

[79] Sold in lots of 10.  
 [80] Set of 10 different caps: white, black, green, red, yellow, blue, white "I" on green background, black "I" on white background, white "O" on red background, white "O" on black background.  
 [81] Standard circular legends are not compatible with this product. Use special legends ZBY•T listed above.  
 [82] For additional information, refer to publication 9001DB0601R6/06.  
 [83] Maximum panel thickness is 2.5 mm.  
 [84] Mounting nut included with blanking plug.  
 [85] Only when mounted on control stations. Use special legends ZBY••T.



ZBDD2



ZBG455



ZBG455P



ZBP0



ZBV01•3



ZBA709



ZBV01•

Table 19.186: Boot for Standard Selector Switch Handle

Description	For use with	Catalog Number
Boot for standard handle	ZB4BD••	ZBD D2

Table 19.187: Replacement Keys

Description	Key Number	Catalog Number
Set of 2 keys	455	ZBG455
	421E	ZBG421E
	458A	ZBG458A
	520E	ZBG520E
	3131A	ZBG3131A
Set of 2 keys, One of which is supplied booted (rubber boot)	455	ZBG455P
	421E	ZBG421EP
	458A	ZBG458AP
	520E	ZBG520EP
	3131A	ZBG3131AP

Table 19.188: Clear Boots

Description	For use with	Material	Catalog Number
Single boots	Booted push buttons with circular head	Silicone	ZBPA
	Booted push buttons with circular head used in food industry applications		ZBPOA
Double boots	Double-headed push buttons, two flush		ZBA708
	Double-headed push buttons, one flush + one projecting		ZBA710
Triple boot	Triple-headed push buttons, two flush + one projecting		ZBA709

Table 19.189: Lens Caps

For use with	Color	Catalog Number
<b>Lens caps for Protected LED™ light modules</b>		
Pilot lights	White	ZBV0113
	Green	ZBV0133
	Red	ZBV0143
	Yellow	ZBV0153
	Blue	ZBV0163
Illuminated push buttons with flush push	White	ZBW9113
	Green	ZBW9133
	Red	ZBW9143
	Yellow	ZBW9153
	Blue	ZBW9163
Illuminated push buttons with extended push	White	ZBW9313
	Green	ZBW9333
	Red	ZBW9343
	Yellow	ZBW9353
	Blue	ZBW9363
<b>Lens caps for BA9 light modules</b>		
Pilot lights	White	ZBV011
	Green	ZBV013
	Red	ZBV014
	Yellow	ZBV015
	Blue	ZBV016
	Clear	ZBV017
Illuminated push buttons with flush push	White	ZBW911
	Green	ZBW913
	Red	ZBW914
	Yellow	ZBW915
	Blue	ZBW916
	Clear	ZBW917
Illuminated push buttons with extended push	White	ZBW931
	Green	ZBW933
	Red	ZBW934
	Yellow	ZBW935
	Blue	ZBW936
	Clear	ZBW937
<b>Square lens caps for Protected LED light modules (ZB5C operators only)</b>		
Pilot lights	White	ZBCV0113
	Green	ZBCV0133
	Red	ZBCV0143
	Yellow	ZBCV0153
	Blue	ZBCV0163
Illuminated push buttons with flush push	White	ZBCW9113
	Green	ZBCW9133
	Red	ZBCW9143
	Yellow	ZBCW9153
	Blue	ZBCW9163
Illuminated push buttons with extended push	White	ZBCW9313
	Green	ZBCW9333
	Red	ZBCW9343
	Yellow	ZBCW9353
	Blue	ZBCW9363

New!

**XB5R Plastic and XB4R Metal Wireless, Batteryless Push Buttons**



XB5RFA02



**Table 19.190: Ready-to-use Packs [86]**

Description	Transmitter Type	Voltage Receiver V	Receiver Type	Catalog Number
Packs include: - 1 push button/transmitter - 1 receiver The push button and receiver are factory-paired [87]	Ø 22 mm plastic head + 1 set of 10 different colored caps	~ / --- 24 to 240	Programmable receiver with: - 2 relay outputs type RT 3A[88]	XB5RFA02
	Ø 22 mm metallic head + 1 set of 10 different colored caps	--- 24		XB4RFA02
Packs include: - 1 push button/transmitter in handy box [90] - 1 receiver The push button and receiver are factory-paired [87]	Ø 22 mm plastic head + 1 set of 10 different colored caps	~ / --- 24 to 240	Programmable receiver with: - 2 relay outputs type RT 3A[88]	XB5RMA04
	Ø 22 mm metallic head + 1 operator head	--- 24		XB5RMB03



ZBRT1



ZB4RZA0



ZB5RTA4

**Table 19.191: Transmitter Components for Wireless, Batteryless Push Buttons**

Description	Type of Push	Cap Color	Catalog Number
Transmitter for wireless, batteryless push buttons [91]	1 radio frame sent at the push of the button	—	ZBRT1
	Dual Action: 1 radio frame sent at the push of the button 1 radio frame sent at therelease of the button	—	ZBRT2
Spring return push button heads for transmitter ZBRT1	Plastic	Without cap [93]	ZB5RZA0
	Metal	Without cap [93]	ZB4RZA0
Wireless, batteryless push buttons including: - a transmitter fitted with mounting collar - a spring return push button head with clipped-in cap [94]	Plastic	White	ZB5RTA1
		Black	ZB5RTA2
		Green	ZB5RTA3
		Green with white "I"	ZB5RTA331
		Red	ZB5RTA4
		Red with white "O"	ZB5RTA432
	Metal	Yellow	ZB5RTA5
		Blue	ZB5RTA6
		White	ZB4RTA1
		Black	ZB4RTA2
		Green	ZB4RTA3
		Green with white "I"	ZB4RTA331
		Red	ZB4RTA4
		Red with white "O"	ZB4RTA432
Yellow	ZB4RTA5		
Blue	ZB4RTA6		

[86] Wireless and batteryless push button and receiver, factory-paired.  
 [87] For additional components, these devices can be field-paired.  
 [88] Supplied with output function set to momentary. Outputs programmable to maintained and Start-Stop.  
 [89] Non-programmable momentary output function.  
 [90] Supplied with a magnet.  
 [91] Mounting collar ZB5AZ009 (plastic) or ZB4BZ009 (metal) to be ordered separately.  
 [92] Only heads ZB4RZA0 and ZB5RZA0 are mechanically compatible.  
 [93] Cap to be ordered separately: see Caps for Harmony Push Button Heads ZB5RZA0 and ZB4RZA0.  
 [94] This cap is fitted by Schneider Electric and cannot be removed (risk of damage).

Refer to Catalog [DIA5ED21214EN](#)



ZBRRA



ZBA7235 ZBA7331



ZBA7432



ZBA79

**Table 19.192: Programmable Receivers**

Description	Output Type	Voltage Receiver V	Catalog Number
Programmable receivers equipped with: - 2 buttons ("Scroll-through", "Ok") - 6 indicating LEDs (power ON, outputs, signal strength)	4 PNP outputs, 200 mA / 24 V	--- 24	ZBRRC
	2 relay outputs type RT 3A [95]	~/--- 24 to 240	ZBRRD
	2 relay outputs type RT 3A [95]	~/--- 24 to 240	ZBRRA

**NOTE:** Also refer to Access Point for advanced features in programmable receivers.

**Table 19.193: Caps for Harmony Push Button Heads ZB5RZA0 and ZB4RZA0**

Description	Background Color	Marking	Sold in lots of	Catalog Number
Sets of 10 different colored caps with identical marking [96]	White	Without	10	ZBA71
		"I" (black)	10	ZBA7131
		"q" (black)	10	ZBA7134
		"+" (black)	10	ZBA7138
	Black	Without	10	ZBA72
		"O" (white)	10	ZBA7232
		"+" (white)	10	ZBA7233
		"0" (white)	10	ZBA7235
	Green	"I" (white)	10	ZBA7237
		Without	10	ZBA73
		"I" (white)	10	ZBA7331
		"+" (white)	10	ZBA7333
	Red	"q" white	10	ZBA7335
		"II" (white)	10	ZBA7336
		Without	10	ZBA74
	Yellow	"O" (white)	10	ZBA7432
		Without	10	ZBA75
		Without	10	ZBA76
	Blue	Without	10	ZBA76
	Set of 10 different colored caps with different markings [96]	White, black, green, red, yellow, blue, white "I" on green background, black "I" on white background, white "O" on red background, white "O" on black background		10

**Table 19.194: Boxes for Wireless, Batteryless Push Buttons**

Description	For use with:	Marking	Sold in lots of	Catalog Number
Mobile box, plastic, empty [97]	For mobile and fixed applications with wireless and batteryless push buttons	1 cut-out	1	ZBRM21
		2 cut-outs	1	ZBRM22
	Support for tube or wall specific for ZBRM21 and ZBRM22	—	1	ZBRACS
Empty plastic boxes for wireless and batteryless push buttons [98]	For fixed or on-board wireless and batteryless push buttons	1 cut-out	1	XALD01H7
		2 cut-outs	1	XALD02H7



ZBRM22



ZBRACS



XALD02H7

*New!*

**XB5R and XB4R Accessories**

**Table 19.195: Accessories**

Description	For use with:	Marking	Sold in lots of	Catalog Number
External antenna [99]	Between transmitter and receiver, used to increase the range and/or get around obstacles	~/--- 24 to 240 V - 5m cable - 1 power-ON LED - 2 LEDs reception/transmission	1	ZBRA1
Mounting collar	—	Plastic Metal	10 10	ZB5AZ009 ZB4BZ009
Legend plate, 27 x 8 mm, for engraving	For adhering to handy box ZBRM01	Self-adhesive, blank, black background	10	ZBY0101T
External antenna access point 2 m/6.56 ft cable with 1 RF connector	Access point (ZBRN1 or ZBRN2) Used to increase the distance of transmission			ZBRA2

**NOTE:** The ZBRN2 has embedded communication port for Modbus Serial Line, where as ZBRN1 must be plugged with a communication module to support different protocols.



ZBRA1



ZBRA2

[95] Supplied with output function set to momentary Outputs programmable to maintained and Start-Stop.

[96] Cap can be clipped-in at 90° steps, through 360°.

[97] Cannot be used for wired contacts (no cable gland outlet).

[98] Box equipped with cable gland outlets, compatible with Harmony ZB5 push button heads.

[99] Not wired to the receiver.



Refer to Catalog [DIA5ED2121214EN](#)

*New!*

**ZBRN1 and ZBRN2 Access Points**

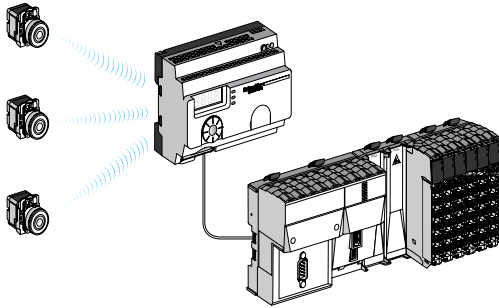

Radio transmission between 3 transmitters and 1 Access Point

The access point of Harmony wireless and batteryless range provides network connectivity openness by operating as an intermediate equipment between the transmitter and the PLC (Programmable Logic Controller). The access point receives radio signals from the transmitters and converts them to communication protocols. Based on the model, it is connected to the PLC using either RS485 Modbus Serial line or Modbus/TCP protocol.

The access point can be used with transmitters such as XB4R and XB5R wireless and batteryless push buttons, rope pull switch, mushroom head push button (1), and all PLCs that support Modbus Serial line over RS485 or Modbus/TCP protocols.

Depending on the application, an external or a relay antenna can be used to improve signal reception. An access point can support up to 60 radio transmitters



**Table 19.196: Configurable Access Points**

Description	Data Function	Output Type	Receiver Voltage (V)	Catalog Number
Configurable access points equipped with: - 7-segment display - jog dial - 8 indicating LEDs (power ON, functions mode, communication status, signal strength) - external antenna connector and protective plug	Monostable (adjustable from 100 ms to 1 s)	2 RS485 connectors that provides connectivity for Modbus RS485 Serial line	$\sim$ / --- 24 to 240	ZBRN2
	Monostable (adjustable from 100 ms to 1 s)	1 slot for communication module ZBRCETH (should be ordered separately)	$\sim$ / --- 24 to 240	ZBRN1

**Table 19.197: Communication Module**

Description	Characteristics	Communication Port	Catalog Number
Modbus/TCP network communication module	Modbus/TCP protocol with embedded Web pages in 5 languages for configuration, monitoring and diagnostics	2 RJ45 connectors that provides connectivity for daisy chain and daisy chain loop operation	ZBRCETH

Stand-alone biometric switch  
(XB5S1/XB5S2)Stand-alone USB biometric switch  
(XB5S3/XB5S4)USB biometric switch dedicated to Schneider HMI  
(XB5S5)

## Biometric Switches

The biometric switches of the Harmony® XB5S range are designed to control and secure access to systems and machines by checking users' authorization through fingerprint recognition.

The following types of biometric switches are available:

- Stand-alone biometric switches
  - type XB5S1, with 2 fixed states (bistable)
  - type XB5S2, with pulse control (monostable)
- Stand-alone USB biometric switches
  - type XB5S3, with 2 fixed states (bistable)
  - type XB5S4, with pulse control (monostable)
- USB biometric switches dedicated to Schneider HMI
  - type XB5S5, connected permanently with HMI

The biometric switches are aimed at 2 categories:

- Administrators, who decide and manage the list of users
  - the only people who can record the fingerprints in the device memory
- Users, who are authorized to use the biometric switch as a control unit
  - at least 1 of their fingerprints should be recorded in the device memory
  - access is granted when the finger is placed on the sensing screen

The USB switches communicate with the PC/HMI via the USB port to manage the user database. This database can be visualized, saved, and duplicated by PC/HMI with XB5SSoft application [100] [101]. The fingerprint records can also be erased in the absence of users.

The Schneider HMI [102] with VijeoDesigner software [103] enables the switches to authorize different access levels and trace HMI operations of each user.

The switch operates on 24 Vdc and provides protection against:

- Reverse polarity
- Overload and short-circuit (switching capacity  $\leq 200$  mA)

### Mounting

The product is of monolithic design (a single plastic housing) and is mounted by means of a nut (hand-tightened without need for tools) in a standard 22.5 mm/0.886 in. diameter hole. It can be installed on a flat, horizontal, or vertical surface.

A protective cover is available as an accessory to protect the active face of the sensing screen. This cover is mounted using a self-adhesive hinge.

A Female/Female USB extension cable makes it possible for the USB biometric switch to have the female USB port within a 22 mm/0.866 in. diameter hole on the control panel front.

### Environment

- Conformity to standards: UL, CSA, GOST, and CE
- Product certifications:
  - CSA C22-2 No. 14
  - UL 508
  - IEC 61000-6-2 and IEC 61000-6-4
- Degree of protection conforming to standard IEC 60529:
  - IP 65
  - NEMA 12
- Ambient air temperature:
  - For storage: -13 to 158°F (-25 to 70° C)
  - For operation: 23 to 122°F (-5 to 50° C)

[100] Compatible with all versions of Harmony XB5SSoft application. The XB5SSoft is a freeware application and can be downloaded from our website [www.schneider-electric.com](http://www.schneider-electric.com).

[101] The user database cannot be uploaded from USB biometric switch to the PC.

[102] Compatible with Magelis IPC, STU, OT, GXO, GT (except GT1000 series), GK, GH, and GTO models.

[103] Compatible with VijeoDesigner HMI editor software V6.1, Service pack 2.

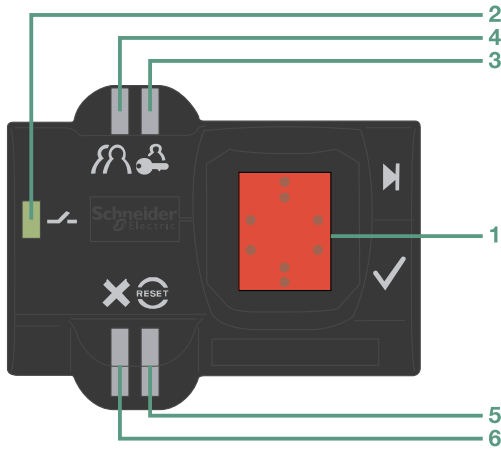

**Description**

- The stand-alone biometric switch (XB5S1/XB5S2) consists of a dark gray housing, with the following on its front face:
  - A sensing screen 1 that allows the registration and subsequent recognition of the registered fingerprints,
  - A green LED output state indicator 2 that illuminates when the output is activated (solid-state N.O. contact),
  - An orange LED 3, indicating an administrator’s “Registration” mode,
  - An orange LED 4, indicating an operator’s “Registration” mode,
  - A red “RESET” LED 5 which indicates, in “Delete” mode, that the administrator is deleting all or part of the memory,
  - A red LED 6 which flashes when the reader is presented with an “unrecognized” fingerprint or in the event of incorrect operation.
- The stand-alone USB biometric switch (XB5S3/XB5S4) consists of a dark gray housing with a sensing screen 1 for fingerprints, a green LED 2 for indicating the output state, and a red LED 6 for the unrecognized fingerprint on its front face.
- The USB biometric switch dedicated to Schneider HMI (XB5S5) consists of a dark gray housing with a sensing screen 1 for fingerprints on its front face.



XB5S1B●●●●



XB5S3B●●●●



ZB5SZ70



ZB5SZ72

**Table 19.198: Biometric Switch Catalog Numbers**

Description	Connection	Catalog Number
Bistable biometric switch 24 V DC PNP output	By 2 m/6.56 ft cable	XB5S1B2L2
	By M12 connector	XB5S1B2M12
Monostable biometric switch 24 V DC PNP output	By 2 m/6.56 ft cable	XB5S2B2L2
	By M12 connector	XB5S2B2M12
Bistable USB biometric switch 24 V DC PNP output	By 2 m/6.56 ft cable	XB5S3B2L2
	By M12 connector	XB5S3B2M12
Monostable USB biometric switch 24 V DC PNP output	By 2 m/6.56 ft cable	XB5S4B2L2
	By M12 connector	XB5S4B2M12
USB biometric switch dedicated to Schneider HMI 24 V DC	By 2 m/6.56 ft cable	XB5S5B2L2

**Table 19.199: Accessories**

Description	Function	Catalog Number
Protective cover, translucent and self-adhesive	Protection of sensing screen	ZB5SZ70
Mounting nut, Ø 22 mm/0.866 in.	Spare part	ZB5SZ71
Legend plate, 27 x 8 mm/ 1.06 x 0.32 in., self-adhesive, blank, black background, for engraving	—	ZBY0101T
Stainless-steel protective cover	Protects switch from outside elements and vandalism	ZB5SZ72

*New!*

**XB7 Push Buttons**

**Table 19.200: Push Buttons Without Marking**



Shape of Head	Type of Push Button	Type of Contact		Marking		Color of Push Button	Sold in Lots of	Catalog Number
		N.O.	N.C.	Text	Color			
<b>Spring return push button without marking</b>								
○	Flush	1	—	—	—	White	10	XB7NA11
		1	—	—	—	Black	10	XB7NA21
		1	—	—	—	Green	10	XB7NA31
		1	—	—	—	Yellow	10	XB7NA81
		1	1	—	—	White	10	XB7NA15
		1	1	—	—	Black	10	XB7NA25
		1	1	—	—	Green	10	XB7NA35
		1	1	—	—	Red	10	XB7NA45
		1	1	—	—	Blue	10	XB7NA65
		1	1	—	—	Yellow	10	XB7NA85
		—	1	—	—	Red	10	XB7NA42
		2	—	—	—	Black	10	XB7NA23
		2	—	—	—	Green	10	XB7NA33
		—	2	—	—	Red	10	XB7NA44
○	Projecting	—	1	—	—	Red	10	XB7NL42
		1	1	—	—	Red	10	XB7NL45
		—	2	—	—	Red	10	XB7NL44
<b>Latching push button without marking</b>								
○	Flush	1	—	—	—	Black	10	XB7NH21
		1	—	—	—	Green	10	XB7NH31
		1	1	—	—	Black	10	XB7NH25
		1	1	—	—	Green	10	XB7NH35
		1	—	—	—	Yellow	10	XB7NH81

**Table 19.201: Push Buttons With Marking**



Shape of Head	Type of Push Button	Type of Contact		Marking		Color of Push Button	Sold in Lots of	Catalog Number		
		N.O.	N.C.	Text	Color					
<b>Spring return push button with marking</b>										
○	Flush	1	—	I	White	Green	10	XB7NA3131		
		1	—	II	White	Green	10	XB7NA3136		
		1	—	START	White	Green	10	XB7NA3133		
		1	—	↑	Black	White	10	XB7NA11343		
		1	—	↑	Black	White	10	XB7NA11341		
		1	—	↓	White	Black	10	XB7NA21343		
		1	—	↓	White	Black	10	XB7NA21341		
		—	1	O	White	Red	10	XB7NA4232		
		—	1	STOP	White	Red	10	XB7NA4234		
		2	—	I	White	Green	10	XB7NA3331		
		2	—	II	White	Green	10	XB7NA3336		
		2	—	START	White	Green	10	XB7NA3333		
		1	1	O	White	Red	10	XB7NA4532		
		1	1	STOP	White	Red	10	XB7NA4534		
		1	1	↑	Black	White	10	XB7NA15343		
		1	1	↑	Black	White	10	XB7NA15341		
		1	1	↓	White	Black	10	XB7NA25343		
		1	1	↓	White	Black	10	XB7NA25341		
		○	Projecting	—	1	O	White	Red	10	XB7NL4232
				—	1	STOP	White	Red	10	XB7NL4234
				1	1	O	White	Red	10	XB7NL4532
				1	1	STOP	White	Red	10	XB7NL4534

New!

**XB7 Illuminated Push Buttons with Projecting Push**

**Table 19.202: With Integral LED**



XB7NW33•1

Shape of head	Type of push and contacts	Color of lens	Sold in lots of	Unit reference by supply voltage [104]		
				24 V ~/□	120 V ~	230 V ~
	Spring return push with N.O. and N.C. contacts [104]	Green	10	XB7NW33B1	XB7NW33G1	XB7NW33M1
		Red	10	XB7NW34B1	XB7NW34G1	XB7NW34M1
		Orange	10	XB7NW34B2	XB7NW34G2	XB7NW34M2
		Blue	10	XB7NW35B1	XB7NW35G1	XB7NW35M1
		Clear	10	XB7NW36B1	XB7NW36G1	XB7NW36M1
		Yellow	10	XB7NW37B1	XB7NW37G1	XB7NW37M1
	Latching push	Green	10	XB7NW38B1	XB7NW38G1	XB7NW38M1
		Red	10	XB7NJ03B1	XB7NJ03G1	XB7NJ03M1
		Orange	10	XB7NJ04B1	XB7NJ04G1	XB7NJ04M1
		Blue	10	XB7NJ04B2	XB7NJ04G2	XB7NJ04M2
		Clear	10	XB7NJ05B1	XB7NJ05G1	XB7NJ05M1
		Yellow	10	XB7NJ06B1	XB7NJ06G1	XB7NJ06M1
		Clear	10	XB7NJ07B1	XB7NJ07G1	XB7NJ07M1
		Yellow	10	XB7NJ08B1	XB7NJ08G1	XB7NJ08M1

**Table 19.203: With BA 9s Base Fitting [105]**



XB7NW3361

Shape of head	Type of push	Type of contact		Color of lights	Sold in lots of	Catalog Number 250 V ~
		N.O.	N.C.			
	Spring return	1	–	Green	10	XB7NW3361
		1	–	Red	10	XB7NW3461
		1	–	Orange	10	XB7NW3561
		1	–	Blue	10	XB7NW3661
		1	–	Clear	10	XB7NW3761
		1	–	Yellow	10	XB7NW3861
	Latching	1	–	Green	10	XB7NJ0361
		1	–	Red	10	XB7NJ0461
		1	–	Orange	10	XB7NJ0561
		1	–	Blue	10	XB7NJ0661
		1	–	Clear	10	XB7NJ0761
		1	–	Yellow	10	XB7NJ0861

New!

**XB7 Pilot Lights**

**Table 19.204: With Integral LED**



XB7EV08•P

Shape of head	Type of light source (included)	Color of lens	Sold in lots of	Catalog Number by supply voltage [106]		
				24 V ~/□	120 V ~	230 V ~
	Integral LED	Green	10	XB7EV03BP	XB7EV03GP	XB7EV03MP
		Red	10	XB7EV04BP	XB7EV04GP	XB7EV04MP
		Yellow	10	XB7EV05BP	XB7EV05GP	XB7EV05MP
		Blue	10	XB7EV06BP	XB7EV06GP	XB7EV06MP
		Clear	10	XB7EV07BP	XB7EV07GP	XB7EV07MP
		Orange	10	XB7EV08BP	XB7EV08GP	XB7EV08MP

**Table 19.205: With BA 9s base fitting**



XB7EV75P

Shape of head	Supply	Color of lens	Sold in lots of	Catalog Number [106]	
				With bulb	Without bulb
	With resistor, for 130 V, 2.6 W bulb Supply voltage: 230 V ~, 50-60 Hz	Green	10	XB7EV73P	XB7EV730P
		Red	10	XB7EV74P	XB7EV740P
		Yellow	10	XB7EV75P	XB7EV750P
		Blue	10	XB7EV76P	XB7EV760P
		Clear	10	XB7EV77P	XB7EV770P
		Orange	10	XB7EV78P	XB7EV780P
	Direct for BA 9s base fitting incandescent bulb Supply voltage: ≤ 250 V [107]	Green	10	–	XB7EV63P
		Red	10	–	XB7EV64P
		Yellow	10	–	XB7EV65P
		Blue	10	–	XB7EV66P
		Clear	10	–	XB7EV67P
		Orange	10	–	XB7EV68P

[104] All product references ending in "1" are for products with "NO" contacts (example: XB7NW34B1). All product references ending in "2" are for products with "NC" contacts (example: XB7NW34B2).

[105] Bulb, 1.2 W maximum, to be ordered separately

[106] For Faston connection version (1 x 6.35 mm and 2 x 2.8 mm), add the number "3" to the end of the reference. Example: XB7EV07BP becomes XB7EV07BP3.

[107] Bulb characteristics for direct supply pilot lights: 250 V, 2.6 W.

New!

**XB7 Selector Switches and Key Switches**

**Table 19.206: Title**



Shape of head	Type of operator	Type of contact		Number and type of positions	Sold in lots of	Catalog Number	
		N.O.	N.C.				
	Standard handle, black	1	—	2, maintained		10	XB7ND21
		1	1	2, maintained		10	XB7ND25
		2	—	3, maintained		10	XB7ND33
	Key (key No. 455)	1	—	2, key withdrawal in LH position		10	XB7NG21
		2	—	3, key withdrawal in center position		10	XB7NG33

NOTE: The symbol indicates key withdrawal position(s).

New!

**XB7 Mushroom Head Push Buttons**

**Table 19.207: Ø 40 mm Emergency Stop Trigger Action and Mechanically Latching Mushroom Head Pushbuttons**



Shape of head	Type of push	Standards	Type of contact		Color	Sold in lots of	Catalog Numbers
			N.O.	N.C.			
	Turn to release	EN/IEC 60204-1, EN/ISO 13850, EN/IEC 60947-5-5, Machinery directive 2006/42/EC and UL	—	1	Red	10	XB7NS8442
			1	1	Red	10	XB7NS8445
	Push-pull		—	2	Red	10	XB7NS8444
			—	1	Red	10	XB7NT842
	Key release (n° 455)		1	1	Red	10	XB7NT845
			—	2	Red	10	XB7NT844
	Key release (n° 455)		—	2	Red	10	XB7NS9444
			—	1	Red	10	XB7NS9445

**Table 19.208: Circular Legends, Yellow, For Mushroom Head Push Buttons**



Used for "Emergency Stop" function [108]			
Conforming to Standards	Diameter (mm)	Marking on Yellow Background	Catalog Number
EN/IEC 60204-1 and EN/ISO 13850 [108]	60	ARRET D'URGENCE	ZBY9130
		NOT-HALT	ZBY9230
		PARADA DE EMERGENCIA	ZBY9430
		ARRESTO DE EMERGENZA	ZBY9630
	90	ARRET D'URGENCE	ZBY8130
		EMERGENCY STOP	ZBY8330
		PARADA DE EMERGENCIA	ZBY8430
		ARRESTO DE EMERGENZA	ZBY8630

[108] For compliance with standard EN/ISO 13850, paragraph 4.4.6, the Emergency stop logo has been added.

*New!*

**XB7 Legend Holders and Legends**

**Table 19.209: Standard (30 x 40 mm) Legend Holders for 8 x 27 mm Legends**

Text	Sold in lots of	Catalog Number
Without legend	10	ZBZ32

**Table 19.210: Legend Holder, 30 x 40 mm with Legend (black or red background)**

Text	Sold in lots of	Catalog Number
<b>With blank legend</b>		
Without legend	10	ZBY2101
<b>With marked legend (sold singly)</b>		

Start functions: White characters on black background.  
Stop functions: White characters on red background.

Text	Catalog Number	Text	Catalog Number
Auto	ZBY2115	Reset	ZBY2323
Down	ZBY2308	Reverse	ZBY2306
Forward	ZBY2305	Right	ZBY2309
Hand	ZBY2316	Start	ZBY2303
Inch	ZBY2321	Stop	ZBY2304
Left	ZBY2310	Up	ZBY2307
Off	ZBY2312	O	ZBY2146
On	ZBY2311	I	ZBY2147
Power on	ZBY2326	O-I	ZBY2178

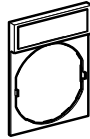

ZBY2101

**Table 19.211: Standard (30 x 50 mm) Legend Holders for 18 x 27 mm Legends**

Text	Sold in lots of	Catalog Number
Without legend	10	ZBZ33

*New!*

**XB7 Accessories**

**Table 19.212: XB7 Push Button Accessories**

Description	Color	Sold in lots of	Catalog Number
Anti-rotation plate	—	10	ZB5AZ902
Mounting nut	—	10	ZB5AZ901
Mounting nut tightening tool	—	1	ZB5AZ905
Grooved lenses for BA 9s pilot lights	White	10	ZB7EV01
	Green	10	ZB7EV03
	Red	10	ZB7EV04
	Yellow	10	ZB7EV05
	Blue	10	ZB7EV06
	Clear	10	ZB7EV07
	Orange	10	ZB7EV08
Plastic circular blanking plug (with mounting nut)	Black	10	ZB5SZ3

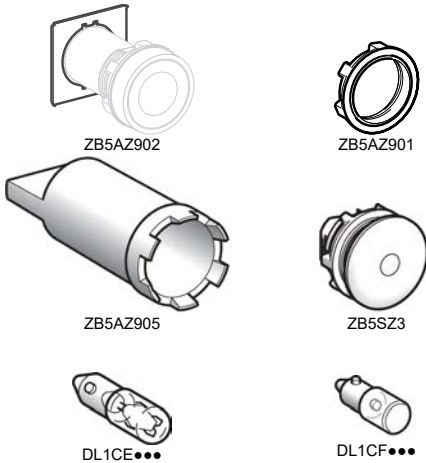





**Table 19.213: BA 9s Bulbs**

Description	Voltage (V)	Power (W)	Sold in lots of	Catalog Number
Incandescent bulbs, long life Ø 11 mm max. length 28 mm max.	6	1.2	10	DL1CB006
	24	2.0	10	DL1CE024
	130	2.6	10	DL1CE130
Neon bulbs	120–130	—	10	DL1CF110
	230–240	—	10	DL1CF220

Type K Heavy Duty Operators

Table 19.214: Non-Illuminated Momentary Push Button Operators

Description		Color	Operator with 1 N.O. and 1 N.C. Contact (KA1) [1]	Operator with 1 N.O. Contact (KA2) [1]	Operator with 1 N.C. Contact (KA3) [1]	Operator Only with No Contacts [1]
 9001KR1B	Full Guard	Black	KR1BH13	KR1BH5	KR1BH6	KR1B
		Red	KR1RH13	KR1RH5	KR1RH6	KR1R
		Green	KR1GH13	KR1GH5	KR1GH6	KR1G
		Universal [2]	KR1UH13	KR1UH5	KR1UH6	KR1U
		Other [3]	KR1H13	KR1H5	KR1H6	KR1
 9001KR3B	No Guard	Black	KR3BH13	KR3BH5	KR3BH6	KR3B
		Red	KR3RH13	KR3RH5	KR3RH6	KR3R
		Green	KR3GH13	KR3GH5	KR3GH6	KR3G
		Universal [2]	KR3UH13	KR3UH5	KR3UH6	KR3U
		Other [3]	KR3H13	KR3H5	KR3H6	KR3
 9001KR2B	Extended Guard	Black	KR2BH13	KR2BH5	KR2BH6	KR2B
		Red	KR2RH13	KR2RH5	KR2RH6	KR2R
		Green	KR2GH13	KR2GH5	KR2GH6	KR2G
		Universal [2]	KR2UH13	KR2UH5	KR2UH6	KR2U
		Other [3]	KR2H13	KR2H5	KR2H6	KR2
 9001KR4B	1-3/8 in. (35 mm) Diameter Mushroom Button	<b>Snap-In Plastic Mushroom Button</b>				
		Black	KR4BH13	KR4BH5	KR4BH6	KR4B
		Red	KR4RH13	KR4RH5	KR4RH6	KR4R
		Red [4]	KR4R05H13	KR4R05H5	KR4R05H6	KR4R05
		Green	KR4GH13	KR4GH5	KR4GH6	KR4G
		Other [3]	KR4H13	KR4H5	KR4H6	KR4
		<b>Screw-On Mushroom Button with Set Screw Security, Plastic Head</b>				
		Black	KR24BH13	KR24BH5	KR24BH6	KR24B
		Red	KR24RH13	KR24RH5	KR24RH6	KR24R
		Green	KR24GH13	KR24GH5	KR24GH6	KR24G
		Other [3]	KR24H13	KR24H5	KR24H6	KR24
		<b>Screw-On Metal Mushroom Button with Set Screw Security</b>				
		Black	—	—	—	9001KR24BM
		Red	—	—	—	9001KR24RM
Green	—	—	—	9001KR24GM		
 9001KR5B	2-1/4 in. (57 mm) Diameter Mushroom Button	<b>Snap-In Plastic Mushroom Button</b>				
		Black	KR5BH13	KR5BH5	KR5BH6	KR5B
		Red	KR5RH13	KR5RH5	KR5RH6	KR5R
		Red [4]	KR5R05H13 [4]	KR5R05H5 [4]	KR5R05H6 [4]	KR5R05 [4]
		Green	KR5GH13	KR5GH5	KR5GH6	KR5G
		Other [3]	KR5H13	KR5H5	KR5H6	KR5
		<b>Screw-On Mushroom Button with Set Screw Security, Plastic Head</b>				
		Black	KR25BH13	KR25BH5	KR25BH6	KR25B
		Red	KR25RH13	KR25RH5	KR25RH6	KR25R
		Green	KR25GH13	KR25GH5	KR25GH6	KR25G
		Other [3]	KR25H13	KR25H5	KR25H6	KR25
		<b>Screw-On Metal Mushroom Button with Set Screw Security</b>				
		Black	—	—	—	9001KR25BM
		Red	—	—	—	9001KR25RM
Green	—	—	—	9001KR25GM		

NOTE: To select contact blocks, light modules, and accessories, see Type KA Contact Blocks, page 19-90.

Table 19.215: Color Codes

Color	KR1, 2, 3 Place Color Code in Type Number	KR4, 5, 24, 25 Place Color Code in Type Number
Blue	L	L
Yellow	Y	Y
White	W	—
Orange	S	S
Gray	E	—

NOTE: For use in hazardous locations—See Square D Offering According to Class, Division, and Group, page 19-92. Contact blocks and legend plate not included unless otherwise noted.

[1] When ordering, add prefix 9001 to the catalog number.  
 [2] The universal push button operators contain one each of the following color inserts: black, red, green, yellow, orange, blue and white.  
 [3] Choose color code from Table 19.217 Color Codes for Type K Operators, page 19-73.  
 [4] Knob has the words "Emergency Stop" in raised letters highlighted in white for readability.



Table 19.216: 30 mm Multifunction Operators





Description [5]		Color	With 2 N.C. Contacts (1 KA3, 1 KA5) [6]	With 1 N.O. & 1 N.C. Contact (1 KA1) [6]	Without Contacts [6] [7]
<b>Non-Illuminated Push-Pull Mushroom Operators</b>					
 <b>KR9R94H13</b> Set Screw Style	3 Position, Plastic Head 1-5/8 in. (40 mm), Screw-On Momentary Pull Maintained Neutral Momentary Push [8]	Red Green Other [9]	KR8RH25 KR8GH25 KR8▼H25	— — —	KR8R KR8G KR8▼
	2 Position, Plastic Head 1-5/8 in. (40 mm), Screw-On Maintained Pull Maintained Push [10]	Red [11] Green Other [9]	— — —	KR9RH13 KR9GH13 KR9▼H13	KR9R KR9G KR9▼
	2 Position, Plastic Head 1-5/8 in. (40 mm), Screw-On Head with Set Screw Maintained Pull Maintained Push [10]	Red	—	KR9R94H13	KR9R94
 9001KR9RM94	2 Position, Metal Head 1-1/2 in. (40 mm) Diameter Maintained Pull Maintained Push	Black	—	—	9001KR9BM94
		Red	—		9001KR9RM94
 9001KR9RM95	2 Position, Metal Head 2-3/8 in. (60 mm) Diameter Maintained Pull Maintained Push	Green	—	—	9001KR9GM94
		Black	—		9001KR9BM95
		Red	—		9001KR9RM95
		Green	—		9001KR9GM95
Description		Color	With 1 N.O. & 1 N.C. Contact (KA1)	With 2 N.O. & 2 N.C. Contacts (KA2)	Without Contacts
<b>Non-Illuminated Turn-to-Release Mushroom Operators</b>					
 <b>9001KR16H2</b> Trigger Action	2 Position, Plastic Head Turn-to-Release Trigger Action	Red	KR16H13	KR16H2	KR16



Table 19.217: Color Codes for 30 mm Multifunction Operators ▼

Color	KR8, KR9
Black [15]	B
Red	R
Green	G
Blue	L
Yellow	Y
White	W
Orange [15]	S
Clear	C
Amber	A
Gray	—

Screw-On Plastic Illuminated Push-Pull Mushroom Operators [6] [12] [9]

Description [5]	Voltage	With Red Knob and 2 N.C. Contacts (1 KA3, 1 KA5)	With Other Color Knob and 2 N.C. Contacts (1 KA3, 1 KA5)	With Other Color Knob Without Contacts [7]
3 Position Illuminated Momentary Pull Maintained Neutral Momentary Push [8]	110-120 V, 50-60 Hz Other—Transformer, LED, Flashing [13] Other—Full Voltage, Resistor, Neon [14]	KR8P1RH25 KR8P▲RH25 KR8P▲RH25	KR8P1▼H25 KR8P▲▼H25 KR8P▲▼H25	KR8P1▼ KR8P▲▼ KR8P▲▼
Description [5]	Voltage	With Red [11] Knob & 1 N.O. & 1 N.C. Contact (KA1)	With Other Color Knob and 1 N.O. & 1 N.C. Contact (KA1)	With Other Color Knob Without Contacts
2 Position Illuminated Maintained Pull Maintained Push	110-120 V, 50-60 Hz Other—Transformer, LED, Flashing [13] Other—Full Voltage, Resistor, Neon [14]	KR9P1RH13 KR9P▲RH13 KR9P▲RH13	KR9P1▼H13 KR9P▲▼H13 KR9P▲▼H13	KR9P1▼ KR9P▲▼ KR9P▲▼

Table 19.218: Contact Sequences

9001 KR8RH1 or H13				
		Pull	Ctr	Push
(KA1)	KA3	X	O	O
	KA2	O	O	X
9001 KR8RH25				
	KA3	X	O	O
	KA5	X	X	O

NOTE: To select contact blocks, light modules, and accessories, see Type KA Contact Blocks, page 19-90.

[5] For 1-3/8 in. or 2-1/4 in. Dia. Knob:

- a) Order Type -20 or -21 knob from Additional Accessories for Type K and SK Operators, page 19-99.
- b) Order 9001K54 adapter—allows Type -20 or -21 knob to fit on push pull operators. Voids UL and NEMA 6 rating.
- c) Can order assembled operator by adding color code to Type -20 or -21. Example: 9001KR9R would be 9001KR9R20 or 9001KR9R21.

[6] When ordering, add prefix 9001 to the catalog number.

[7] These operators can be ordered complete with contact blocks. For maximum block usage, see "H" Codes, page 19-93. Add the chosen "H" number to the end of the operator.

[8] For contact sequences, see Table 19.218 Contact Sequences, page 19-73

[9] ▼ Choose one color from the Color Codes table here, and insert the color code in Type number. Example: KR9 with a yellow knob = KR9Y

[10] For color codes, see Color Codes for 30 mm Multifunction Operators, page 19-73.

[11] To obtain a red knob with "Push Emergency Stop" printed on the red knob—substitute "R05" in place of "R"





[12] ▲ Add the voltage assembly code as chosen from Table 19.273 Standard Light Modules for Types K, SK, and KX Control Units, page 19-91. Example: KR8P with a 277 V 50-60 Hz voltage = KR8P8.

[13] The knob must be the same color as the LED light module chosen, for example, for a green LED, use a green knob.

[14] On neon light modules, use clear knobs only.

[15] These colors are not available on illuminated push-pull operators.

Table 19.219: Illuminated Momentary Push Button Operators

Description		Voltage and Frequency	Style	With Red Color Cap and 1 N.O. and 1 N.C. Contact (KA1) [16]	With Green Color Cap and 1 N.O. and 1 N.C. Contact (KA1) [16]	With Other Color Cap Without Contact Block [17] [18] [16]
 9001K1L1	Full Guard Illuminated Push Button Clear Plastic Top	110–120 V, 50–60 Hz	Transformer	K1L1RH13	K1L1GH13	K1L1▼
		220–240 V, 50–60 Hz	Transformer	K1L7RH13	K1L7GH13	K1L7▼
		24–28 Vac/Vdc	Full Voltage	K1L35RH13	K1L35GH13	K1L35▼
		For other voltages [19]■	Transformer or Flashing	K1L■RH13	K1L■GH13	K1L■▼
			Full Voltage	K1L■RH13	K1L■GH13	K1L■ [18]
			Resistor or Neon [20]	K1L■RH13	K1L■GH13	K1L■▼
LED [21]	K1L■RH13	K1L■GH13	K1L■▼			
 9001K3L1	Full Guard Illuminated Push Button Metal Top	110–120 V, 50–60 Hz	Transformer	K3L1RH13	K3L1GH13	K3L1▼
		220–240 V, 50–60 Hz	Transformer	K3L7RH13	K3L7GH13	K3L7▼
		24–28 Vac/Vdc	Full Voltage	K3L35RH13	K3L35GH13	K3L35▼
		For other voltages [19]■	Transformer or Flashing	K3L■RH13	K3L■GH13	K3L■▼
			Full Voltage	K3L■RH13	K3L■GH13	K3L■ [18]
			Resistor or Neon [20]	K3L■RH13	K3L■GH13	K3L■▼
LED [21]	K3L■RH13	K3L■GH13	K3L■▼			
 9001K2L1	No Guard Illuminated Push Button	110–120 V, 50–60 Hz	Transformer	K2L1RH13	K2L1GH13	K2L1▼
		220–240 V, 50–60 Hz	Transformer	K2L7RH13	K2L7GH13	K2L7▼
		24–28 Vac/Vdc	Full Voltage	K2L35RH13	K2L35GH13	K2L35▼
		For other voltages [19]■	Transformer or Flashing	K2L■RH13	K2L■GH13	K2L■ [18]
			Full Voltage	K2L■RH13	K2L■GH13	K2L■▼
			Resistor or Neon [20]	K2L■RH13	K2L■GH13	K2L■▼
LED [21]	K2L■RH13	K2L■GH13	K2L■▼			
 9001K2LR20	1-3/8 in. (35 mm) Illuminated Mushroom, Screw-On Plastic Head	110–120 V, 50–60 Hz	Transformer	K2L1R20H13	K2L1G20H13	Order K2L■▼ Above [22]
		220–240 V, 50–60 Hz	Transformer	K2L7R20H13	K2L7G20H13	
		24–28 Vac/Vdc	Full Voltage	K2L35R20H13	K2L35G20H13	
		For other voltages [19]■	Transformer or Flashing	K2L■R20H13	K2L■G20H13	
			Full Voltage	K2L■R20H13	K2L■G20H13	
			Resistor or Neon [20]	K2L■R20H13	K2L■G20H13	
LED [21]	K2L■R20H13	K2L■G20H13				
 9001K2LR21	2-1/4 in. (57 mm) Illuminated Mushroom, Screw-On Plastic Head	110–120 V, 50–60 Hz	Transformer	K2L1R21H13	K2L1G21H13	Order K2L■▼ Above [22]
		220–240 V, 50–60 Hz	Transformer	K2L7R21H13	K2L7G21H13	
		24–28 Vac/Vdc	Full Voltage	K2L35R21H13	K2L35G21H13	
		For other voltages [19]■	Transformer or Flashing	K2L■R21H13	K2L■G21H13	
			Full Voltage	K2L■R21H13	K2L■G21H13	
			Resistor or Neon [20]	K2L■R21H13	K2L■G21H13	
LED [21]	K2L■R21H13	K2L■G21H13				

NOTE: To select contact blocks, light modules, and accessories, see Type KA Contact Blocks, page 19-90.

Table 19.220: Color Caps

Color	Color Codes ▼		
	K1L, K2L, K3L	1-3/8 in. Mushroom	2-1/4 in. Mushroom
Red	R	R20	R21
Green	G	G20	G21
Blue	L	L20	L21
Yellow	Y	Y20	Y21
White	W	W20	W21
Clear	C	C20	C21
Amber	A	A20	A21

NOTE: UL Types 4, 13/NEMA 4, 13 For use in hazardous locations—See Square D Offering According to Class, Division, and Group, page 19-92. Contact blocks and legend plate not included unless otherwise noted.

[16] When ordering, add prefix 9001 to the catalog number.

[17] These operators can be ordered complete with contact blocks. For maximum block usage, refer to bullets to the right of "H" Codes, page 19-93. Add the "H" number to the end of the operator type number. Additional "H" numbers are available.

[18] Add the color code as chosen from the color cap table. Example: K2L25 with a blue 1-3/8 in. mushroom button = K2L25L20.

[19] ■ Add the voltage assembly code as chosen from Standard and Shallow Depth Light Modules, page 19-91. Example: K2L with 240 Vac/Vdc = K2L25.

[20] On neon light modules, use clear color caps only.

[21] The cap must be the same color as the LED light module chosen, e.g., for red LED, use red color cap.

[22] The only difference between a no guard (K2L\_) operator and mushroom button operator is the color cap.

**9001K 2-Position Selector Switches**

**Table 19.221: 2-Position Selector Switches**

Contact Block Required				1 — Contact Closed 0 — Contact Open						
Contact Block Position	Quantity and Type KA1 or KA2 or KA3		Mount on Side KA1 or KA2 or KA3		Left Right		Left Right			
	<p><b>Top View</b></p>		or		KA1 #2	or		1	0	0
									0	1
		or		KA1 #1	or		1	0	0	1
									0	1
For cam, see Type K, KX, and SK Selector Switch Guide, page 19-78.							<b>E</b>	<b>D</b>		

Non-Illuminated Operators		Cat. No. [23]	Cat. No. [23]
<b>Manual Return [24], Operator Only (without contact blocks)</b>			
Without Knob		KS11	KS12
With Knob (select style and color from Table 19.222 Selector Switch Assembly Codes, page 19-75) [25]		KS11♦	KS12♦
Key Operated with E10 Key (Code 1,2,3) [25]		KS11K♦	KS12K♦
<b>Operator with Contact Blocks and Standard black knob</b>			
With 1 KA1 on Side #2		KS11BH13	—
With 1 KA1 on Side #1		KS11BH1	—
With 1 KA1 on Side #1 and 1 KA1 on side #2		KS11BH2	—
<b>Spring Return from Left [24], Operator Only (without contact blocks)</b>			
Without Knob		KS25	—
With Knob (select style and color from Table 19.222 Selector Switch Assembly Codes, page 19-75) [25]		KS25♦	—
Key Operated with E10 Key (Code 2 only) [26]		KS25K2	—
<b>Spring Return from Right [24], Operator Only (without contact blocks)</b>			
Without Knob		—	KS34
With Knob (select style and color from Table 19.222 Selector Switch Assembly Codes, page 19-75) [25]		—	KS34♦
Key Operated with E10 Key (Code 1 only)		—	KS34K1
<b>Illuminated Operators</b>		<b>Cat. No. [23]</b>	<b>Cat. No. [23]</b>
<b>Manual Return [24], Operator Only (without contact blocks)</b>			
Without Knob, 110-120V 50-60 Hz Transformer		K11J1	K12J1
With Standard Red Knob, 110-120V 50-60 Hz Transformer		K11J1R	K12J1R
With Other Color Knob and other voltage Light Module [27], [25]		K11J♦♦	K12J♦♦
<b>Spring Return from Left [24], Operator Only (without contact blocks)</b>			
Without Knob, 110-120V 50-60 Hz Transformer		K25J1	—
With Standard Red Knob, 110-120V 50-60 Hz Transformer		K25J1R	—
With Other Color Knob and other voltage Light Module [27], [25]		K25J♦♦	—
<b>Spring Return from Right [24], Operator Only (without contact blocks)</b>			
Without Knob, 110-120V 50-60 Hz Transformer		—	K34J1
With Standard Red Knob, 110-120V 50-60 Hz Transformer		—	K34J1R
With Other Color Knob and other voltage Light Module [27], [25]		—	K34J♦♦

**Table 19.222: Selector Switch Assembly Code and Knob Cat. No.**

Color	Standard Knob		Gloved Hand Knob	
	♦ Knob Code	Cat. No. [23]	♦ Knob Code	Cat. No. [23]
Black	B	B11	FB	B25
Red	R	R8	FR	R24
Green	G	G8	FG	G24
Yellow	Y	Y8	FY	Y24
Blue	L	L8	FL	L24
White	W	W8	FW	W24
Amber	A	A8	FA	A24
Clear	C	C8	FC	C24

**Table 19.223: Key Withdrawal Codes**

Code	Position
1	Left Only
2	Right Only
3	Left and Right

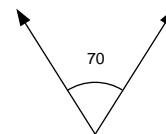

**2 Position**

**NOTE:** To select and order Contact Blocks, Light Modules, Knobs, and Accessories, see Type KA Contact Blocks, page 19-90 through Hermetically Sealed Power Reed Contact Blocks, page 19-92.

[23] When ordering, add prefix 9001 to the catalog number.

[24] These operators can be ordered complete with contact blocks. Add the "H code" from "H" Codes, page 19-93 as needed for your application.

[25] ♦ Add the knob color code from Table 19.222 Selector Switch Assembly Codes, page 19-75

[26] Add the key withdrawal code from Table 19.223 Key Withdrawal Codes, page 19-75

[27] ■ Add the voltage assembly code as chosen from Standard and Shallow Depth Light Modules, page 19-91. Example: K25J■ with 208Vac = K25J3

9001K 3-Position Selector Switches

Table 19.224: 3-Position Selector Switches

Contact Block Required				1 - Contact Closed 0 - Contact Open														
Contact Block Position	Quantity and Type	Mount on Side	Diagram	Left	Right	Left	Right	Left	Right	Left	Right	Left	Right	Left	Right	Left	Right	
				↖	↗	↖	↗	↖	↗	↖	↗	↖	↗	↖	↗	↖	↗	↖
<p>Top View</p>	KA1	or	KA3 #2	1	0	0	1	0	0	1	1	0	0	0	1	1	0	
			KA2 #2	0	1	1	0	0	1	0	1	0	0	0	1	1	0	0
	KA1	or	KA3 #1	0	0	1	1	0	0	1	1	0	0	1	1	0	0	1
			KA2 #1	1	1	0	0	0	1	0	1	0	0	0	1	1	0	0
For cam, see Type K, KX, and SK Selector Switch Guide, page 19-78.				B	C	D	E	F	G	J	L	M						
<b>Non-Illuminated Operators</b>				Cat. No.	Cat. No.	Cat. No.	Cat. No.	Cat. No.	Cat. No.	Cat. No.	Cat. No.	Cat. No.	Cat. No.					
<b>Manual Return, Operator Only (without contact blocks) [29]</b>																		
Without Knob				KS42	KS43	KS44	KS45	KS46	KS47	KS49	KS401	KS402						
With Knob [30]				KS42+	KS43+	KS44+	KS45+	KS46+	KS47+	KS49+	KS401+	KS402+						
Key Operated with E10 Key (Code 4 through 10) [31]				KS42K▼	KS43K▼	KS44K▼	KS45K▼	KS46K▼	KS47K▼	KS49K▼	KS401K▼	KS402K▼						
<b>Operator with Contact Blocks and Standard black knob [32]</b>																		
With 1 KA1 on Side #2 (H13)				KS42B-H13	KS43B-H13	KS44B-H13	KS45BH13	KS46BH13	KS47BH13	KS49BH13	KS401B-H13	KS402B-H13						
With 1 KA1 on Side #1 (H1)				KS42BH1	KS43BH1	KS44BH1	KS45BH1	KS46BH1	KS47BH1	KS49BH1	KS401BH1	KS402BH1						
With 1 KA1 on Side #1 and 1 KA1 on side #2 (H2)				KS42BH2	KS43BH2	KS44BH2	KS45BH2	KS46BH2	KS47BH2	KS49BH2	KS401BH2	KS402BH2						
<b>Spring Return from Left to Center, Operator Only (without contact blocks) [29]</b>																		
Without Knob				KS62	KS63	KS64	KS65	KS66	KS67	KS69	KS601	KS602						
With Knob [30]				KS62+	KS63+	KS64+	KS65+	KS66+	KS67+	KS69+	KS601+	KS602+						
Key Operated with E10 Key (Code 5, 6 or 9 only) [31]				KS62K▼	KS63K▼	KS64K▼	KS65K▼	KS66K▼	KS67K▼	KS69K▼	KS601K▼	KS602K▼						
<b>Spring Return from Right to Center, Operator Only (without contact blocks) [29]</b>																		
Without Knob				KS72	KS73	KS74	KS75	KS76	KS77	KS79	KS701	KS702						
With Knob [30]				KS72+	KS73+	KS74+	KS75+	KS76+	KS77+	KS79+	KS701+	KS702+						
Key Operated with E10 Key (Code 4, 5 or 7 only) [31]				KS72K▼	KS73K▼	KS74K▼	KS75K▼	KS76K▼	KS77K▼	KS79K▼	KS701K▼	KS702K▼						
<b>Spring Return from Both Sides to Center, Operator Only (without contact blocks) [29]</b>																		
Without Knob				KS52	KS53	KS54	KS55	KS56	KS57	KS59	KS501	KS502						
With Knob [30]				KS52+	KS53+	KS54+	KS55+	KS56+	KS57+	KS59+	KS501+	KS502+						
Key Operated with E10 Key (Code 4, 5 or 7 only) [31]				KS52K▼	KS53K▼	KS54K▼	KS55K▼	KS56K▼	KS57K▼	KS59K▼	KS501K▼	KS502K▼						
<b>Illuminated Operators</b>				Cat. No.	Cat. No.	Cat. No.	Cat. No.	Cat. No.	Cat. No.	Cat. No.	Cat. No.	Cat. No.	Cat. No.					
<b>Manual Return, Operator Only (without contact blocks) [29]</b>																		
Without Knob, 110-120V 50-60 Hz Transformer				K42J1	K43J1	K44J1	K45J1	K46J1	K47J1	K49J1	K401J1	K402J1						
With Standard Red Knob, 110-120V 50-60 Hz Transformer				K42J1R	K43J1R	K44J1R	K45J1R	K46J1R	K47J1R	K49J1R	K401J1R	K402J1R						
With Other Color Knob and other voltage Light Module [33] [30]				K42J+	K43J+	K44J+	K45J+	K46J+	K47J+	K49J+	K401J+	K402J+						
<b>Spring Return from Left to Center, Operator Only (without contact blocks) [29]</b>																		
Without Knob, 110-120V 50-60 Hz Transformer				K62J1	K63J1	K64J1	K65J1	K66J1	K67J1	K69J1	K601J1	K602J1						
With Standard Red Knob, 110-120V 50-60 Hz Transformer				K62J1R	K63J1R	K64J1R	K65J1R	K66J1R	K67J1R	K69J1R	K601J1R	K602J1R						
With Other Color Knob and other voltage Light Module [33] [30]				K62J+	K63J+	K64J+	K65J+	K66J+	K67J+	K69J+	K601J+	K602J+						
<b>Spring Return from Right to Center, Operator Only (without contact blocks) [29]</b>																		
Without Knob, 110-120V 50-60 Hz Transformer				K72J1	K73J1	K74J1	K75J1	K76J1	K77J1	K79J1	K701J1	K702J1						
With Standard Red Knob, 110-120V 50-60 Hz Transformer				K72J1R	K73J1R	K74J1R	K75J1R	K76J1R	K77J1R	K79J1R	K701J1R	K702J1R						
With Other Color Knob and other voltage Light Module [33] [30]				K72J+	K73J+	K74J+	K75J+	K76J+	K77J+	K79J+	K701J+	K702J+						
<b>Spring Return from Both Sides to Center, Operator Only (without contact blocks) [29]</b>																		
Without Knob, 110-120V 50-60 Hz Transformer				K52J1	K53J1	K54J1	K55J1	K56J1	K57J1	K59J1	K501J1	K502J1						
With Standard Red Knob, 110-120V 50-60 Hz Transformer				K52J1R	K53J1R	K54J1R	K55J1R	K56J1R	K57J1R	K59J1R	K501J1R	K502J1R						
With Other Color Knob and other voltage Light Module [33] [30]				K52J+	K53J+	K54J+	K55J+	K56J+	K57J+	K59J+	K501J+	K502J+						

Table 19.225: Selector Switch Assembly Code and Knob Cat. No. ♦

Color	Standard Knob		Gloved Hand Knob	
	[30] Knob Code	Cat. No. [28]	[30] Knob Code	Cat. No. [28]
Black	B	B11	FB	B25
Red	R	R8	FR	R24
Green	G	G8	FG	G24
Yellow	Y	Y8	FY	Y24
Blue	L	L8	FL	L24
White	W	W8	FW	W24
Amber	A	A8	FA	A24
Clear	C	C8	FC	C24

Table 19.226: Key Withdrawal Codes [34]

Code	Position
4	Left Only
5	Center Only
6	Right Only
7	Left and Center
8	Left and Right
9	Center and Right
10	Left, Center, and Right

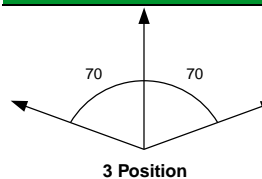

NOTE: To select and order Contact Blocks, Light Modules, Knobs, and Accessories, see Type KA Contact Blocks, page 19-90 through Hermetically Sealed Power Reed Contact Blocks, page 19-92.

[28] When ordering, add prefix 9001 to the catalog number.

[29] These operators can be ordered complete with contact blocks. Add the "H code" from "H Codes, page 19-93 as needed for your application.

[30] ♦ Add the knob color code from Table 19.225 Selector Switch Assembly Code, page 19-76. For LED, knob color must match LED.

[31] ▼ Add the key withdrawal code from Key Withdrawal Codes table. Example: KS43K with key withdrawal in the right position only = KS43K6.

[32] For other color knobs replace the B with knob color code from the Selector Switch Assembly Code table.

[33] ■ Add the voltage assembly code as chosen from page 19-86.

[34] Add the key withdrawal code from Key Withdrawal Codes table. Example: KS43K with key withdrawal in the right position only = KS43K6.

9001K 4-Position Selector Switches

Table 19.227: 4-Position Selector Switches

Contact Block Required							
Contact Block Position	Quantity and Type KA1 or KA2 or KA3		Mount on Side KA1 or KA2 or KA3		1—Contact Closed 0—Contact Open		
<p>Top View</p>	KA1 	or	KA3 	KA1 #2	or	KA3 #2 	1 0 0 0
							0 0 1 0
	KA1 	or	KA3 	KA1 #1	or	KA3 #1 	0 0 0 1
							0 1 0 0
H							

For cam, see Type K, KX, and SK Selector Switch Guide, page 19-78.

Non-Illuminated Operators	Cat. No. [35]
Manual Return [36], Operator Only (without contact blocks)	
Without Knob	KS88
With Knob♦[37]	KS88♦
Key Operated with E10 Key (Codes 11, 12, 13, 14, 15)	KS88K[38]
Illuminated Operators	Cat. No. [35]
Manual Return [36], Operator Only (without contact blocks)	
Without Knob, 110-120V 50-60 Hz Transformer	K88J1
With Standard Red Knob, 110-120V 50-60 Hz Transformer	K88J1R
With Other Color Knob and other voltage Light Module ■[39] ♦[37][40]	K88J■♦

Table 19.228: Selector Switch Assembly Code and Knob Cat. No.

Color	Standard Knob		Gloved Hand Knob	
	Knob Code	Cat. No.	Knob Code	Cat. No.
Black	B	B11	FB	B25
Red	R	R8	FR	R24
Green	G	G8	FG	G24
Yellow	Y	Y8	FY	Y24
Blue	L	L8	FL	L24
White	W	W8	FW	W24
Amber	A	A8	FA	A24
Clear	C	C8	FC	C24

Table 19.229: Key Withdrawl Codes

Code	Position
11	1 and 4
12	4 only
13	1 only
14	1, 2, 3 and 4
15	2, 3, and 4

4 Position

NOTE: To select and order Contact Blocks, Light Modules, Knobs, and Accessories, see Type KA Contact Blocks, page 19-90 through Hermetically Sealed Power Reed Contact Blocks, page 19-92.

Potentiometers with Dial Plate

Table 19.230: Potentiometers with Dial Plate (not UL listed)—Maximum Voltage 300 Vac



Power	Description	Ratings	Type
2 W	Operator Only, for Single Potentiometer	NEMA 4, 13	K20
	Operator with Single Potentiometer		K21

Table 19.231: Potentiometer Suffixes

Single Potentiometer			
Suffix [41]	Resistance	Suffix [41]	Resistance
01	50 Ω	07	5 kΩ
02	100 Ω	08	10 kΩ
04	500 Ω	09	25 kΩ
05	1 kΩ	13	500 kΩ
39	2 kΩ	37	750 kΩ
06	2.5 kΩ	14	1 MΩ
Tandem Potentiometer		Resistance	
Suffix [41]	Front	Rear	
82	1 kW	1 kW	

NOTE: Any potentiometer with a shaft 7/8" long and 1/4" diameter may be used with these operators.

[35] When ordering, add prefix 9001 to the catalog number.  
 [36] These operators can be ordered complete with contact blocks. Add the "H code" from "H" Codes, page 19-93 as needed for your application.  
 [37] ♦ Add the knob color code from the Selector Switch Assembly Code table. For LED, knob color must match LED.  
 [38] Add the key withdrawal code from the Key Withdrawal Codes table.  
 [39] ■ Add the key withdrawal code from Key Withdrawal Codes table. Example: KS43K with key withdrawal in the right position only = KS43K6.  
 [40] Add the knob color code from the Selector Switch Assembly Code table. For LED, knob color must match LED.  
 [41] For the complete part number, add the suffix from Table 19.231 Potentiometer Suffixes, page 19-77 to the catalog number. Example: 9001K2105.

Type K, KX, and SK Selector Switch Guide

Table 19.232: 2 Position Selector Switch

If you require contact sequence—		Use Cam Type	Use Contact Block Type	Mount on side no. [42]
↖	↗			
1	0	E	KA3	1 or 2
		D	KA2	1 or 2
0	1	E	KA2	1 or 2
		D	KA3	1 or 2

Selection

Shown below is a simplified method of selecting a selector switch to meet almost any combination of contact sequences.

Step No. 1

Determine the contact sequence(s) required. Set up a target table like the one shown for the example below.

Contact Sequence 0—contact open 1— contact closed	↖	↗	↘
A	1	0	0
B	0	1	0
C	0	0	1

Step No. 2

Look for a cam type common to all sequences in:  
Table 19.232 2 Position Selector Switch, page 19-78,  
Table 19.233 3 Position Selector Switch, page 19-78, or  
Table 19.234 4 Position Selector Switch, page 19-78.  
For the example above, Table 19.233 3 Position Selector Switch, page 19-78 would be used.  
For the contact sequences A (1 0 0), B (0 1 0) and C (0 0 1) of the example above, cam types F and L are common to all three sequences.

Step No. 3

Next, use the cam type common to all the sequences (if several cam types are common, choose one) to find the operator type number. Go to the proper reference topic as indicated in the table below:

Number of Positions	Push Button Line	Reference topics
2	Type K, Type SK, Type KX	Type K, page 19-75 Type SK, page 19-85 "H" Numbers, page 19-93 Type KX with Contacts, page 19-102 Type KX without Contacts, page 19-104
3	Type K, Type SK, Type KX	Type K, page 19-76 Type SK, page 19-86 "H" Numbers, page 19-93 Type KX with Contacts, page 19-102 Type KX without Contacts, page 19-104
4	Type K, Type SK, Type KX	Type K, page 19-77 Type SK, page 19-87 Type KX, page 19-102

If for the example above a manual return operator with a standard black knob is required and:

The F cam type is chosen, the operator type number is:

- Type K—Class 9001 Type KS46B, page 19-76
- Type SK—Class 9001 Type SKS46B, page 19-86
- Type KX—Class 9001 Type KXSDFB, page 19-104

The L cam type is chosen, the operator type number is:

- Type K—Class 9001 Type KS401B, page 19-76
- Type SK—Class 9001 Type SKS401B, page 19-86
- Type KX—Class 9001 Type KXSDLB, page 19-104

Step No. 4:

Determine the contact blocks required by using the same table in Step No. 2.

If, for the example above, the F cam type is chosen:

- Use a 9001KA3 mounted on side no. 2 for sequence A (1 0 0).
- Use a 9001KA3 mounted on side no. 1 for sequence B (0 1 0).
- Use a 9001KA2 mounted on side no. 1 or 2 for sequence C (0 0 1).

If, for the example above, the L cam type is chosen:

- Use a 9001KA2 mounted on side no. 2 for sequence A (1 0 0).
  - Use a 9001KA2 mounted on side no. 1 or a 9001KA3 mounted on side no. 2 for sequence B (0 1 0).
  - Use a 9001KA3 mounted on side no. 1 for sequence C (0 0 1).
- One Type KA1 double circuit block can be used in place of one Type KA2 single circuit block plus one Type KA3 single circuit block mounted on the same side.

Table 19.233: 3 Position Selector Switch

If you require contact sequence—			Use Cam Type	Use Contact Block Type	Mount on side no. [42]					
↖	↗	↘								
1	0	0		G	M	KA2	1			
					L		KA2	2		
			C	E			KA3	1		
			B	C	E	F	G	J	KA3	2
0	1	0				J	L	KA2	1	
				D	E				KA2	2
						F			KA3	1
								L	KA3	2
0	0	1		C		F		KA2	1 or 2	
			B	D		G	L	KA3	1	
				D					KA3	2
			B						KA5 [43]	1
1	1	0					M	KA2	2	
									KA2	1
			B						KA5 [43]	1 or 2
			C		F				KA3	2
0	1	1				G	J	KA2	2	
						G			KA5 [43]	1
								L	KA5 [43]	2
								M	KA3	1
1	0	1				J	L	KA3	1	
				D	E				KA5 [43]	1
				D	E				KA5 [43]	2

Table 19.234: 4 Position Selector Switch

If you require contact sequence—				Use Cam Type	Use Contact Block Type	Mount on side no. [42]
↖	↗	↘	↙			
1	0	0	0	H	(A) KA3	2
0	1	0	0	H	(B) KA2	1
0	0	1	0	H	(C) KA2	2
0	0	0	1	H	(D) KA3	1
1	0	0	1	H	A & D Wired in Parallel	
1	1	0	0	H	A & B Wired in Parallel	
0	1	1	0	H	B & C Wired in Parallel	
0	0	1	1	H	C & D Wired in Parallel	
1	1	1	0	H	A, B & C Wired in Parallel	
0	1	1	1	H	B, C & D Wired in Parallel	
1	0	1	0	H	A & C Wired in Parallel	
0	1	0	1	H	B & D Wired in Parallel	
1	1	0	1	H	KA5 [43]	2
1	0	1	1	H	KA5 [43]	1

NOTE: For Outline Dimensions see Catalog 9001CT1103

NOTE: When ordering, add prefix 9001 to the catalog number.

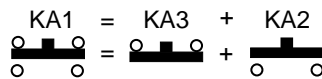

When ordering, please specify:

- Quantity
- Class Number
- Type or Catalog Number

For "H" Numbers, see Type K, SK, and KX Contact Block "H" Numbers, page 19-93



[42] See Type K, SK, and KX Contact Block "H" Numbers, page 19-93

[43] Type KA5 must be the last block on either side. If more than one KA5 is required on either side—contact your local Square D sales office.

**Type K Heavy Duty Pilot Lights**

When ordering, add prefix 9001 to the catalog number.

**Table 19.235: Pilot Lights—UL Types 4, 13/NEMA 4 & 13[44][45]**

Description	Voltage	Style	With Red Fresnel Color Cap [46]	With Green Fresnel Color Cap [46]	With Other Color Cap [46] [47]	Without Color Cap [46]
 Standard Pilot Light (Plastic Fresnel Color Cap Shown)	110–120 V, 50–60 Hz 220–240 V, 50–60 Hz 24–28 Vac/Vdc	Transformer Transformer Full Voltage	KP1R31 KP7R31 KP35R31	KP1G31 KP7G31 KP35G31	KP1■ KP7■ KP35■	KP1 KP7 KP35
	For other voltages see <a href="#">Standard and Shallow Depth Light Modules, page 19-91</a> .	Transformer, Flashing or LED [48] Full Voltage, Neon or Resistor [49]	KP▲R31 KP▲R31	KP▲G31 KP▲G31	KP▲■ KP▲■	KP▲ KP▲
 Push-To-Test Pilot Light (Glass Color Cap Shown)	110–120 V, 50–60 Hz 220–240 V, 50–60 Hz 24–28 Vac/Vdc	Transformer Transformer Full Voltage	KT1R31 KT7R31 KT35R31	KT1G31 KT7G31 KT35G31	KT1■ KT7■ KT35■	KT1 KT7 KT35
	For other voltages see <a href="#">Standard and Shallow Depth Light Modules, page 19-91</a> .	Transformer, Flashing or LED [48] Full Voltage, Neon or Resistor [49]	KT▲R31 KT▲R31	KT▲G31 KT▲G31	KT▲■ KT▲■	KT▲ KT▲
 Remote Test Pilot Light (Glass Color Cap Shown)	120 Vac Only 24–28 Vac Only for other voltages	Resistor [50] Full Voltage [50]	KTR38R31 KTR35R31	KTR38G31 KTR35G31	KTR38■ KTR35■	KTR38 KTR35
	See <a href="#">Standard and Shallow Depth Light Modules, page 19-91</a> . [50]	Full Voltage or Resistor [50]	KTR▲R31	KTR▲G31	KTR▲■	KTR▲

**Table 19.236: Color Caps**

Color	Plastic Fresnel	Plastic Domed	Glass
Amber	A31	A9	A6
Blue	L31	L9	L6
Clear	C31	C9	C6
Green	G31	G9	G6
Red	R31	R9	R6
White	W31	W9	W6
Yellow	Y31	Y9	Y6

**Typical Wiring Diagram**

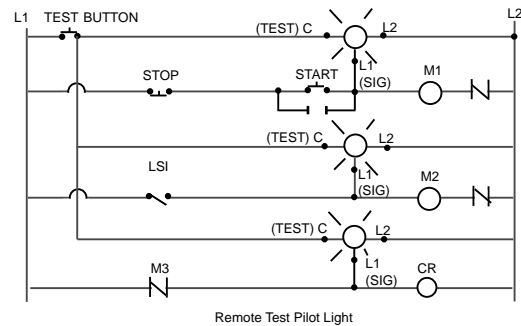
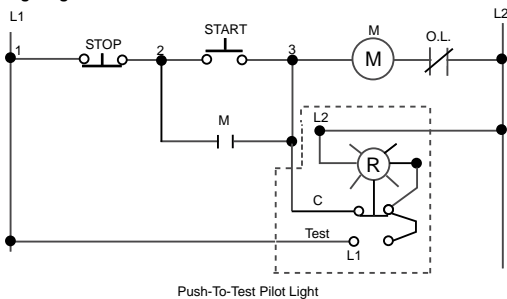

For Contact Blocks, see [Type KA Contact Blocks, page 19-90](#)  
 For Light Modules, see [Standard and Shallow Depth Light Modules, page 19-91](#)  
 For Accessories, see [Type K and SK Accessories, page 19-94](#)

[44] For use in hazardous locations, see [Square D Offering According to Class, Division, and Group, page 19-92](#)

[45] Legend plates not included.

[46] When ordering, add prefix 9001 to the catalog number.

[47] ■ Add the color code as chosen from [Table 19.236 Color Caps, page 19-79](#). **EXAMPLE: KP1 with a blue fresnel cap = KP1L31**

[48] The cap must be the same color as the LED light module chosen, e.g., for green LED, use green color cap.

[49] On neon light modules, use clear color caps only.

[50] On remote test pilot lights use only full voltage or resistor voltage assembly codes. Do not choose LED (exception - these LED codes are allowed: 38LG, 38LL, 38LR, 38LW, 38LY), neon or transformer codes. For AC use only.

Type K Heavy Duty Specialty Operators

Table 19.237: Joy Stick Operators—UL Types 4, 13/NEMA 4, 13 [51] [52]



Description			Operator With Contacts [53]	Operator Without Contacts [54] [53]
↕	3 Position—Center Off	Momentary Contact—Spring Return to Center	Without Latch K71H7	K71
		Maintained Contact	With Latch K70H7	K70
↔	3 Position—Center Off	Momentary Contact—Spring Return to Center	Without Latch K72H7	K72
		Maintained Contact	With Latch K31H8	K31
⬠	5 Position—Center Off	Momentary Contact—Spring Return to Center	Without Latch K30H8	K30
		Maintained Contact	With Latch K33H8	K33
⬠	5 Position—Center Off	Momentary Contact—Spring Return to Center	Without Latch K32H8	K32
		Maintained Contact	With Latch K35H2	K35
⬠	5 Position—Center Off	Momentary Contact—Spring Return to Center	Without Latch K34H2	K34
		Maintained Contact	With Latch K37H2	K37
⬠	5 Position—Center Off	Momentary Contact—Spring Return to Center	Without Latch K36H2	K36
		Maintained Contact	With Latch	K36

The joy stick operator is ideal for applications where only one circuit is to be energized at one time. The three position joy stick closes one circuit in each Up-Down or Right-Left position with all circuits open in center position. The five position operator closes one circuit in each Up, Down, Left and Right position with all circuits open in center position. Momentary contact operators are spring return to the center position. Maintained operators remain in position and must be returned manually. Operators with latch cannot be operated until the latch button in center of handle is pressed.

Table 19.238: Contact Arrangements

Operator Positions	Contact Block Type	Contact Block Location	Contact	Handle position (with reference to Nib)					
				1 ↑	2 →	OFF	3 ↓	4 ←	
↔	3	KA3	POS 1 (3)	A	—	1	0	—	0
		KA3	POS 2 (4)	A	—	0	0	—	1
↕	3	KA2	POS 1 (3)	B	1	—	0	0	—
		KA2	POS 2 (4)	B	0	—	0	1	—
⬠	5	KA1	POS 1 (3)	A	0	1	0	0	0
				B	1	0	0	0	0
		KA1	POS 2 (4)	A	0	0	0	0	1
				B	0	0	0	1	0

(1) Contact Closed (0) Contact Open

Table 19.239: Selector Push Button Operators—UL Types 4, 13/NEMA 4, 13



Selector Push Button 9001KQ

Inserts are field convertible. For colors not listed, order operator without insert, plus separate color insert from Additional Accessories for Type K and SK Operators, page 19-99. Up to two Type KA contact blocks can be mounted in tandem (total of four blocks). Selector push buttons cannot be illuminated.

Contact Block Required		Two Position Operators									
Quantity and Type	Mount on Side	0—Contact Open		1—Contact Closed		F—Free		D—Depressed		Left	Right
		Left	Right	Left	Right	Left	Right	Left	Right		
1 KA1	#2	0 0	1 0	0 0	1 0	0 0	1 1	1 1	1 0	1 0	0 0
		0 1	0 1	0 1	0 0	0 1	0 0	0 0	0 1	0 1	0 1
1 KA1	#1	0 0	1 1	0 0	1 0	1 1	0 0	1 0	1 1	1 1	0 0
		0 1	0 0	0 1	0 0	0 0	0 1	0 1	0 0	0 0	0 1
Cam [55]		P		R		S		T		Y	
Color Insert		Type		Type		Type		Type		Type	
Without Insert [56] Black		KQ11		KQ12		KQ13		KQ14		KQ15	
		KQ11B		KQ12B		KQ13B		KQ14B		KQ15B	

Order Contact Blocks From Type KA Contact Blocks, page 19-90

Key operated push buttons are used wherever unauthorized use of a push button is discouraged. Examples are locking a Start push button in the extended position or locking a Stop push button in the depressed position. The operator can also be locked in the flush position—holding all contacts open. Up to two Type KA contact blocks can be mounted in tandem (total of four blocks). ("X" = locked position) [57]

Table 19.240: Key Operated Push Button – UL Types 4, 13/NEMA 4, 13 [51] [52]



Key Operated Push Button 9001KR

Description	Lockable Positions			Type [53]
	Extended	Flush	De-pressed	
Push button operable only with key in lock. Key is removable in locked position only.	X — — X	— — — X	— — — X	KR131 KR132 KR133 KR137
Push button operable with or without key in lock. Push button can be locked with key only. Key removable in both locked or unlocked position.	X — — X	— X — X	— — X X	KR141 KR142 KR143 KR147
To lock the unit, rotate the key with the button in the extended position. Then, push the button to lock it in the position indicated at right. Key is removable only in this position.	— — —	X — —	— — X	KR152 KR153

[51] For use in hazardous locations—See Square D Offering According to Class, Division, and Group, page 19-92.

[52] Legend plate and contact block not included unless otherwise noted.

[53] When ordering, add prefix 9001 to the catalog number.

[54] These operators can be ordered complete with contact blocks—a total of four (4) contact blocks can be used. Add the "H" number chosen from "H" Codes, page 19-93 to the operator type number and add the cost of the "H" number to the operator cost.

[55] Cams are not interchangeable.

[56] Order color inserts from Additional Accessories for Type K and SK Operators, page 19-99.

[57] All key operated push buttons are furnished as standard with Square D no. E10 key change. See catalog 9001CT0001 for other key changes.





9001KR7U



9001KR11U



Emergency Break-Glass Operator  
9001K15



Rocker Arm Operating Lever  
9001K50



Push-on Push-off Module  
9001K85

**NOTE:** When mounted in top or bottom hole of a Type K enclosure, the Off Delay Push Button requires one additional space below or above operator. When mounted other than in top or bottom hole, device may require two additional spaces, one above and one below operator. Closing plates must be installed on unused holes.

**Table 19.241: Illuminated and Non-Illuminated Dual Operators** [58] [59] [60]

Description	Color	With 2 N.O. Contacts (2 KA2) [61]	With 1 N.O. & 1 N.C. Contact (KA2, KA3) [61]	Without Contacts [62] [61]
Momentary Dual Function	Universal [63] Green-Red Other [62]	KR6UH7 KR6GRH7 KR6H7	KR6UH37 KR6GRH37 KR6H37	KR6U KR6GR KR6■
Momentary Interlocked Dual Function	Universal [63] Green-Red Other [62]	KR67UH7 KR67GRH7 KR67H7	KR67UH37 KR67GRH37 KR67H37	KR67U KR67GR KR67■
Maintained Interlocked Dual Function	Universal [63] Green-Red Other [62]	KR7UH7 KR7GRH7 KR7H7	KR7UH37 KR7GRH37 KR7H37	KR7U KR7GR KR7■
Description	Color	Contacts (KA1)		Without Contacts [62]
Both Buttons Maintained Interlocked Assembly	Universal [64] Other [65]	—		KR11U KR11▲
One Button Momentary One Button Maintained Interlocked Assembly	Universal [64] Other [65]	—		KR12U KR12▲

**Table 19.242: Emergency Break-Glass Operator—UL 4, 13/NEMA 4, 13** [66]

Description	Type [61]
Operator is held in a depressed position by a glass disc. When the glass disc is broken with the hammer, button returns to a normal extended position. Package of 5 discs included with operator.	K15

**Table 19.243: 9001K15 Replacement Parts**

Description	Part Number
Yellow bumper	3105211101
Hammer and chain	3105206750
Lower ring nut	6512232801
Top ring nut	9001K40
Package of 5 replacement discs	9001K57
Clip to hold hammer	2540902240

**Table 19.244: Rocker Arm Operating Lever**

Description	Type [61]
Allows two standard push buttons to be operated independently of each other. Price does not include push buttons or legend plates. Order push buttons and legend plates from Table 19.214 Non-Illuminated Momentary Push Button Operators, page 19-72, and Legend Plates, page 19-94—specify which marking is to be inverted.	K50

**Table 19.245: Alternate Action—Push-on, Push-off Module**

Description	Type [61]
This module can be added to standard 9001 Type K, KX, SK or T momentary push button operators. Contact blocks mounted behind this module (maximum of 2) are held in the depressed position when the operator is pressed once, and released to their normal position when the operator is pressed again. For a N.C. circuit, use a 9001KA3 or the N.C. contact of either a 9001KA1 or 9001KA4. For a N.O. circuit, use the N.O. contact of either a 9001KA4 or 9001KA6.	K85

**Table 19.246: Off Delay Push Button—UL Types 4, 13/NEMA 4, 13**

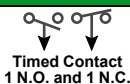
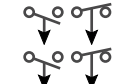
Description	Type (All Colors)		
	Full Guard [61]	Extended Guard [61]	No Guard [61]
 Timed Contact 1 N.O. and 1 N.C.	KRD1UH1	KRD2UH1	KRD3UH1
 Timed Contact 2 N.O. and 2 N.C.	KRD1UH2	KRD2UH2	KRD3UH2

Time Delay Push Button  
9001KRD

Timing period is adjustable from 0.1 second to 60 seconds and begins after button has been released. Devices include a pack of seven color inserts for color coding the push button. See Accessories, page 19-99 for Universal color insert. Contacts are quick make-quick break.

[58] Meets UL Type 13/NEMA 13 and UL Type 6/NEMA 6, which UL and NEMA consider an equivalent to UL Type 4/NEMA 4.

[59] For use in hazardous locations—See Square D Offering According to Class, Division, and Group, page 19-92.

[60] Legend plate and contact block not included unless otherwise noted.

[61] When ordering, add prefix 9001 to the catalog number.

[62] ■ Choose one color for each button. R = red, G = green, B = Black. Example: 9001KR6 with left red and right black = 9001KR6RB. See Color Codes for 30 mm Multifunction Operators, page 19-72.

[63] Universal for KR6, KR67, KR7 includes 2 inserts each of black, red and green.

[64] Universal for KR11, KR12 includes 2 each of black, red, green, yellow, orange, blue, white.

[65] ▲ Choose one color for each button. R = red, G = green, B = Black. Example: 9001KR6 with left red and right black = 9001KR6RB. See Color Codes, page 19-72.

[66] For enclosed versions see 9001KY and 9001SKY Control Stations, page 19-112.

30 mm Momentary Push Button Operators, UL Types 4, 4X, 13/  
NEMA 4, 4X, 13

Table 19.247: Non-Illuminated Momentary Push Button Operators<sup>[67]</sup>





Description	Color	Operator with 1 N.O. and 1 N.C. Contact (KA1)	Operator with 1 N.O. Contact (KA2)	Operator with 1 N.C. Contact (KA3)	Operator Only No Contacts <sup>[68]</sup>
 9001SKR1B Full Guard	Black	SKR1BH13	SKR1BH5	SKR1BH6	SKR1B
	Red	SKR1RH13	SKR1RH5	SKR1RH6	SKR1R
	Green	SKR1GH13	SKR1GH5	SKR1GH6	SKR1G
	Universal <sup>[69]</sup>	SKR1UH13	SKR1UH5	SKR1UH6	SKR1U
	Other <sup>[70]</sup>	SKR1■H13	SKR1■H5	SKR1■H6	SKR1■
 9001SKR3B No Guard	Black	SKR3BH13	SKR3BH5	SKR3BH6	SKR3B
	Red	SKR3RH13	SKR3RH5	SKR3RH6	SKR3R
	Green	SKR3GH13	SKR3GH5	SKR3GH6	SKR3G
	Universal <sup>[69]</sup>	SKR3UH13	SKR3UH5	SKR3UH6	SKR3U
	Other <sup>[70]</sup>	SKR3■H13	SKR3■H5	SKR3■H6	SKR3■
 9001SKR2B Extended Guard	Black	SKR2BH13	SKR2BH5	SKR2BH6	SKR2B
	Red	SKR2RH13	SKR2RH5	SKR2RH6	SKR2R
	Green	SKR2GH13	SKR2GH5	SKR2GH6	SKR2G
	Universal <sup>[69]</sup>	SKR2UH13	SKR2UH5	SKR2UH6	SKR2U
	Other <sup>[70]</sup>	SKR2■	SKR2■H5	SKR2■H6	SKR2■
 9001SKR4B 1-3/8 in. (35 mm) Mushroom Button	<b>Snap-In Mushroom Button</b>				
	Black	SKR4BH13	SKR4BH5	SKR4BH6	SKR4B
	Red	SKR4RH13	SKR4RH5	SKR4RH6	SKR4R
	Red <sup>[71]</sup>	SKR4R05H13	SKR4R05H5	SKR4R05H6	SKR4R05
	Green	SKR4GH13	SKR4GH5	SKR4GH6	SKR4G
	Other <sup>[72]</sup>	SKR4▲H13	SKR4▲H5	SKR4▲H6	SKR4▲
	<b>Screw-On Mushroom Button with Set Screw Security</b>				
Black	SKR24BH13	SKR24BH5	SKR24BH6	SKR24B	
Red	SKR24RH13	SKR24RH5	SKR24RH6	SKR24R	
Green	SKR24GH13	SKR24GH5	SKR24GH6	SKR24G	
Other <sup>[72]</sup>	SKR24▲H13	SKR24▲H5	SKR24▲H6	SKR24▲	
 9001SKR5 2-1/4 in. (57 mm) Mushroom Button	<b>Snap-In Mushroom Button, Plastic Head</b>				
	Black	SKR5BH13	SKR5BH5	SKR5BH6	SKR5B
	Red	SKR5RH13	SKR5RH5	SKR5RH6	SKR5R
	Red <sup>[71]</sup>	SKR5R05H13	SKR5R05H5	SKR5R05H6	SKR5R05
	Green	SKR5GH13	SKR5GH5	SKR5GH6	SKR5G
	Other <sup>[72]</sup>	SKR5▲H13	SKR5▲H5	SKR5▲H6	SKR5▲
	<b>Screw-On Mushroom Button with Set Screw Security, Plastic Head</b>				
	Black	SKR25BH13	SKR25BH5	SKR25BH6	SKR25B
	Red	SKR25RH13	SKR25RH5	SKR25RH6	SKR25R
	Green	SKR25GH13	SKR25GH5	SKR25GH6	SKR25G
Other <sup>[72]</sup>	SKR25▲H13	SKR25▲H5	SKR25▲H6	SKR25▲	

Table 19.248: Color Codes

Color	■ SKR1, 2, 3 Place Color Code in Type Number	▲ SKR4, 5, 24, 25 Place Color Code in Type Number
Blue	L	L
Yellow	Y	Y
White	W	—
Orange	S	S
Gray	E	—

**NOTE:** To select and order Contact Blocks, Light Modules, Knobs, and Accessories, see Type KA Contact Blocks, page 19-90 through Hermetically Sealed Power Reed Contact Blocks, page 19-92.

**NOTE:** For use in hazardous locations—See Square D Offering According to Class, Division, and Group, page 19-92. Contact blocks and legend plate not included unless otherwise noted.

[67] When ordering, add prefix 9001 to the catalog number.

[68] These operators can be ordered complete with contact blocks. For maximum block usage, see "H" Codes, page 19-93. Add the "H" number to the end of the operator type number.

[69] The universal push button operators include one each of the following color inserts: black, red, green, yellow, orange, blue and white.

[70] ■ See Table 19.248 Color Codes, page 19-82.

[71] Knob has the words "Emergency Stop" in raised letters highlighted in white for readability.

[72] ▲ See Table 19.248 Color Codes, page 19-82.

**30 mm Multifunction Operators UL Types 4, 4X, 13/NEMA 4, 4X, 13**

**Table 19.249: Non-Illuminated Push-Pull Screw-on Mushroom Operators, Plastic Head [73]**

 9001SKR9R Non-Illuminated 1-5/8 in. Diameter Knob Includes Type KN179WP Legend Plate Marked Pull To Start Push To Stop	Description	Color	With 2 N.C. Contacts (1 KA3, 1 KA5)	With 1 N.O. / 1 N.C. Contact (1 KA1)	Without Contacts [74]
	<b>3 Position</b>				
Momentary Pull-Maintained Neutral-Momentary Push [75]		Red	SKR8RH25	—	SKR8R
		Green	SKR8GH25	—	SKR8G
		Other [76]	SKR8▲H25	—	SKR8▲
<b>2 Position [77]</b>					
Maintained Pull-Maintained Push		Red	—	SKR9RH13	SKR9R
		Green	—	SKR9GH13	SKR9G
		Other [76]	—	SKR9▲H13	SKR9▲

**Table 19.250: Non-Illuminated Turn-to-Release Mushroom Operators [73]**

 9001SKR16H2	Description	Color	With 1 N.O. Contact (KA1)	With 2 N.O. / 2 N.C. Contacts (2 KA1)	Without Contacts
	2 Position, Plastic Head Turn-to-Release Trigger Action	Red	SKR16H13	SKR16H2	SKR16

**Table 19.251: Screw-On Plastic Illuminated Push-Pull Mushroom Operators [73]**

 9001SKR9P1 Illuminated 1-5/8 in. Diameter Knob Includes Type KN179WP Legend Plate Marked Pull to Start Push To Stop	Description	Voltage	With Red Knob and 2 N.C. Contacts (1 KA3, 1 KA5) [78]	With Other Color Knob and 2 N.C. Contacts [76] [78]	With Other Color Knob Without Contacts [74] [76] [78]
	<b>3 Position</b>				
Momentary Pull-Maintained Neutral-Momentary Push [79]		110–120 V, 50–60 Hz	SKR8P1RH25	SKR8P1▲H25	SKR8P1▲
		Other—Transformer, LED, Flashing [80]	SKR8P♦RH25	SKR8P♦▲H25	SKR8P♦▲
		Other—Full Voltage, Resistor, Neon [75]	SKR8P♦RH25	SKR8P♦▲H25	SKR8P♦▲
<b>2 Position</b>					
Maintained Pull-Maintained Push		110–120 V, 50–60 Hz	SKR9P1RH13	SKR9P1▲H13	SKR9P1▲
		Other—Transformer, L.E.D., Flashing [80]	SKR9P♦RH13	SKR9P♦▲H13	SKR9P♦▲
		Other—Full Voltage, Resistor, Neon [75]	SKR9P♦RH13	SKR9P♦▲H13	SKR9P♦▲

**Table 19.252: Color Codes**

Color	SKR11, SKR12	SKR8, SKR9
Black [81]	B	B
Red	R	R
Green	G	G
Blue	L	L
Yellow	Y	Y
White	W	W
Orange [81]	S	S
Clear	—	—
Amber	—	A
Gray	E	—

**Table 19.253: Positions for 9001SKR8RH1 or H13**

	9001SKR8RH1 or H13			
	KA3	PULL	CTR	PUSH
(KA1)	KA2	X	O	O
		O	O	X

**Table 19.254: Positions for 9001SKR8H25**

	9001SKR8H25			
	KA3	PULL	CTR	PUSH
	KA5	X	O	O
		X	X	O
	KA2	O	O	X

**NOTE:** To select and order Contact Blocks, Light Modules, Knobs, and Accessories, see [Type KA Contact Blocks, page 19-90](#) through [Hermetically Sealed Power Reed Contact Blocks, page 19-92](#).

[73] When ordering, add prefix 9001 to the catalog number.  
 [74] These operators can be ordered complete with contact blocks. For maximum block usage, see "H" Codes, page 19-93. Add the chosen "H" number to the end of the operator.  
 [75] On neon light modules, use clear knobs only.  
 [76] ▲ See [Table 19.252 Color Codes, page 19-83](#) and insert the color code in the Type number. Example: SKR9( ) with a yellow knob = SKR9Y  
 [77] To obtain a red knob with "Push Emergency Stop" printed on the red knob—substitute "R05" in place of "R"  
 [78] ♦ Add the voltage assembly code as chosen from [Standard and Shallow Depth Light Modules, page 19-91](#). Example: SKR8P♦ with 277 V 50–60 Hz = SKR8P8  
 [79] For positions, refer to [Table 19.253 Positions for 9001SKR8RH1 or H13, page 19-83](#) and [Table 19.254 Positions for 9001SKR8H25, page 19-83](#).  
 [80] The knob must be the same color as the LED light module chosen, for example, for a green LED, use a green knob.  
 [81] These colors are not available on illuminated push-pull operators.

Type SK Corrosion Resistant Illuminated Operators

Table 19.255: Illuminated Push Button Operators





Description	Voltage and Frequency	Style	With Red Color Cap and 1 N.O. and 1 N.C. Contact (KA1) [82]	With Green Color Cap and 1 N.O. and 1 N.C. Contact (KA1) [82]	With Other Color Cap Without Contact Blocks [83] [82]
 9001SK1L1	110–120 V, 50–60 Hz	Transformer	SK1L1RH13	SK1L1GH13	SK1L1
	220–240 V, 50–60 Hz	Transformer	SK1L7RH13	SK1L7GH13	SK1L7
	24–28 Vac/Vdc	Full Voltage	SK1L35RH13	SK1L35GH13	SK1L35
	For other voltages See Table [84]	Transformer, Flashing	SK1L■RH13	SK1L■GH13	SK1L ■
		Full Voltage	SK1L■RH13	SK1L■GH13	SK1L ■
		Resistor, Neon [85]	SK1L■RH13	SK1L■GH13	SK1L ■
LED [86]	SK1L■RH13	SK1L■GH13	SK1L ■ [87]		
 9001SK2L1	110–120 V, 50–60 Hz	Transformer	SK2L1RH13	SK2L1GH13	SK2L1
	220–240 V, 50–60 Hz	Transformer	SK2L7RH13	SK2L7GH13	SK2L7
	24–28 Vac/Vdc	Full Voltage	SK2L35RH13	SK2L35GH13	SK2L35
	For other voltages See Table [84]	Transformer, Flashing	SK2L■RH13	SK2L■GH13	SK2L ■
		Full Voltage	SK2L■RH13	SK2L■GH13	SK2L ■
		Resistor, Neon [85]	SK2L■RH13	SK2L■GH13	SK2L ■
LED [86]	SK2L■RH13	SK2L■GH13	SK2L ■ [87]		
 9001SK2L1R20	110–120 V, 50–60 Hz	Transformer	SK2L1R20H13	SK2L1G20H13	Order SK2L■ [87][88]
	220–240 V, 50–60 Hz	Transformer	SK2L7R20H13	SK2L7G20H13	
	24–28 Vac/Vdc	Full Voltage	SK2L35R20H13	SK2L35G20H13	
	For other voltages See Table [84]	Transformer, Flashing	SK2L■R20H13	SK2L■G20H13	
		Full Voltage	SK2L■R20H13	SK2L■G20H13	
		Resistor, Neon [85]	SK2L■R20H13	SK2L■G20H13	
LED [86]	SK2L■R20H13	SK2L■G20H13			
 9001SK2L1R21	110–120 V, 50–60 Hz	Transformer	SK2L1R21H13	SK2L1G21H13	Order SK2L■ [87][88]
	220–240 V, 50–60 Hz	Transformer	SK2L7R21H13	SK2L7G21H13	
	24–28 Vac/Vdc	Full Voltage	SK2L35R21H13	SK2L35G21H13	
	For other voltages See Table [84]	Transformer, Flashing	SK2L■R21H13	SK2L■G21H13	
		Full Voltage	SK2L■R21H13	SK2L■G21H13	
		Resistor, Neon [85]	SK2L■R21H13	SK2L■G21H13	
LED [86]	SK2L■R21H13	SK2L■G21H13			

Table 19.256: Color Caps

Color	Color Codes		
	SK1L/SK2L	1-3/8 in. (35 mm) Mushroom	2-1/4 in. (57 mm) Mushroom
Red	R	R20	R21
Green	G	G20	G21
Blue	L	L20	L21
Yellow	Y	Y20	Y21
White	W	W20	W21
Clear	C	C20	C21
Amber	A	A20	A21

**NOTE:** To select and order Contact Blocks, Light Modules, Knobs, and Accessories, see Type KA Contact Blocks, page 19-90 through Hermetically Sealed Power Reed Contact Blocks, page 19-92.

**NOTE:** For use in hazardous locations—See Square D Offering According to Class, Division, and Group, page 19-92. Contact blocks and legend plate not included unless otherwise noted.

[82] When ordering, add prefix 9001 to the catalog number.

[83] These operators can be ordered complete with contact blocks. For maximum block usage, see "H" Codes, page 19-93. Add the "H" number to the end of the operator type number.

[84] ■ Add the voltage assembly code as chosen from Standard and Shallow Depth Light Modules, page 19-91. **EXAMPLE:** SK2L\_ with 240 Vac/Vdc = SK2L25.

[85] On neon light modules, use clear color caps only.

[86] Add the color code as chosen from the color cap table below. **EXAMPLE:** SK2L25 with a blue 1-3/8 in. mushroom button = SK2L25L20.

[87] The cap must be the same color as the LED light module chosen, e.g., for green LED, use green color cap.

[88] The only difference between a no guard (SK2L) operator and mushroom button operator is the color cap.

**9001SK 2-Position Selector Switches**

**Table 19.257: 2-Position Selector Switches**

Contact Block Required				1—Contact Closed 0—Contact Open						
Contact Block Position	Quantity and Type KA1 or KA2 or KA3		Mount on Side KA1 or KA2 or KA3		Left	Right	Left	Right		
<p><b>Top View</b></p>	KA1	or	KA3 KA2	KA1 #2	or	KA3 #2	1	0	0	1
						KA2 #2	0	1	1	0
	KA1	or	KA3 KA2	KA1 #1	or	KA3 #1	1	0	0	1
						KA2 #1	0	1	1	0
For Cam, see Type K, KX, and SK Selector Switch Guide, page 19-78						E		D		
<b>Non-Illuminated Operators</b>						<b>Type [89]</b>		<b>Type [89]</b>		
<b>Manual Return [90], Operator Only (without contact blocks)</b>										
Without Knob						SKS11		SKS12		
With Knob [91]						SKS11♦		SKS12♦		
<b>Operator with Contact Blocks and Standard black knob</b>										
With 1 KA1 on Side #2						SKS11BH13		—		
With 1 KA1 on Side #1						SKS11BH1		—		
With 1 KA1 on Side #1 and 1 KA1 on side #2						SKS11BH2		—		
<b>Spring Return from Left [90], Operator Only (without contact blocks)</b>										
Without Knob						SKS25		—		
With Knob [91]						SKS25♦		—		
<b>Spring Return from Right [90], Operator Only (without contact blocks)</b>										
Without Knob						—		SKS34		
With Knob [91]						—		SKS34♦		
<b>Illuminated Operators</b>						<b>Type [89]</b>		<b>Type [89]</b>		
<b>Manual Return [90], Operator Only (without contact blocks)</b>										
Without Knob, 110-120V 50-60 Hz Transformer						SK11J1		SK12J1		
With Standard Red Knob, 110-120V 50-60 Hz Transformer						SK11J1R		SK12J1R		
With other Color Knob [91] and other Voltage Light Module [92]						SK11J♦		SK12J♦		
<b>Spring Return from Left [90], Operator Only (without contact blocks)</b>										
Without Knob, 110-120V 50-60 Hz Transformer						SK25J1		—		
With Standard Red Knob, 110-120V 50-60 Hz Transformer						SK25J1R		—		
With other Color Knob [91] and other Voltage Light Module [92]						SK25J♦		—		
<b>Spring Return from Right [90], Operator Only (without contact blocks)</b>										
Without Knob, 110-120V 50-60 Hz Transformer						—		SK34J1		
With Standard Red Knob, 110-120V 50-60 Hz Transformer						—		SK34J1R		
With other Color Knob [91] and other Voltage Light Module [92]						—		SK34J♦		

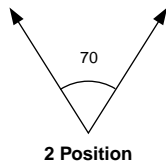

**Table 19.258: Selector Switch Assembly Code and Knob Cat. No.**

Color	Standard Knob		Gloved Hand Knob	
	Knob Code	Cat. No. [89]	Knob Code	Cat. No. [89]
Black	B	B11	FB	B25
Red	R	R8	FR	R24
Green	G	G8	FG	G24
Yellow	Y	Y8	FY	Y24
Blue	L	L8	FL	L24
White	W	W8	FW	W24
Amber	A	A8	FA	A24
Clear	C	C8	FC	C24

Contact Blocks: Contact Blocks, page 19-90, Hermetically Sealed Logic Reed Contact Blocks, page 19-92, Hermetically Sealed Power Reed Contact Blocks, page 19-92  
Light Modules: Standard Light Modules, page 19-91  
Knobs and Accessories: Additional Accessories for Type K and SK Operators, page 19-99

[89] When ordering, add prefix 9001 to the catalog number.

[90] These operators can be ordered complete with contact blocks. For maximum block usage, see "H" Codes, page 19-93. Add the chosen "H" number to the end of the operator.

[91] ♦ Add the knob color code chosen from Table 19.258 Selector Switch Assembly Code and Knob Cat. No., page 19-85. For LED, knob color must match LED.

[92] ■ Add the voltage assembly code as chosen from Standard Light Modules, page 19-91. Example: K25J with 208Vac = K25J3

9001SK 3-Position Selector Switches

Table 19.259: 3-Position Selector Switches

Contact Block Required			1 — Contact Closed 0 — Contact Open																											
Contact Block Position	Quantity and Type	Mount on Side	↕↕↕		↕↕↕		↕↕↕		↕↕↕		↕↕↕		↕↕↕		↕↕↕															
<p>Top View</p>	KA1	KA1 #2	KA3 #2	1	0	0	1	0	0	0	0	1	1	0	0	1	0	0	1	0	0	0	1	0	1	1	0			
	KA2		KA2 #2	0	1	1	0	0	1	0	1	0	0	1	0	0	0	1	0	1	1	0	1	1	1	0	0	0	0	1
	KA1	KA1 #1	KA3 #1	0	0	1	1	0	0	0	0	1	1	0	0	0	1	0	0	0	1	1	0	1	0	0	1	0	1	1
	KA2		KA2 #1	1	1	0	0	0	1	0	1	0	0	1	0	0	0	1	1	0	0	0	1	0	0	1	0	1	0	0

For Cam, see Type K, KX, and SK Selector Switch Guide, page 19-78

Non-Illuminated Operators [93]	Type	Type	Type	Type	Type	Type	Type	Type	Type
<b>Manual Return, Operator Only (without contact blocks) [94]</b>									
Without Knob	SKS42	SKS43	SKS44	SKS45	SKS46	SKS47	SKS49	SKS401	SKS402
With Knob [95]	SKS42♦	SKS43♦	SKS44♦	SKS45♦	SKS46♦	SKS47♦	SKS49♦	SKS401♦	SKS402♦
<b>Operator with Contact Blocks and Standard black knob [96]</b>									
With 1 KA1 on Side #2 (H13)	SKS42B-H13	SKS43B-H13	SKS44B-H13	SKS45B-H13	SKS46BH13	SKS47B-H13	SKS49B-H13	SKS401B-H13	SKS402B-H13
With 1 KA1 on Side #1 (H1)	SKS42B-H1	SKS43BH1	SKS44BH1	SKS45B-H1	SKS46BH1	SKS47BH1	SKS49BH1	SKS401BH1	SKS402BH1
With 1 KA1 on Side #1 and 1 KA1 on side #2 (H2)	SKS42B-H2	SKS43BH2	SKS44BH2	SKS45B-H2	SKS46B-H2	SKS47BH2	SKS49BH2	SKS401BH2	SKS402BH2
<b>Spring Return from Left to Center, Operator Only (without contact blocks) [94]</b>									
Without Knob	SKS62	SKS63	SKS64	SKS65	SKS66	SKS67	SKS69	SKS601	SKS602
With Knob [95]	SKS62♦	SKS63♦	SKS64♦	SKS65♦	SKS66♦	SKS67♦	SKS69♦	SKS601♦	SKS602♦
<b>Spring Return from Right to Center, Operator Only (without contact blocks) [94]</b>									
Without Knob	SKS72	SKS73	SKS74	SKS75	SKS76	SKS77	SKS79	SKS701	SKS702
With Knob [95]	SKS72♦	SKS73♦	SKS74♦	SKS75♦	SKS76♦	SKS77♦	SKS79♦	SKS701♦	SKS702♦
<b>Spring Return from Both Sides to Center, Operator Only (without contact blocks) [94]</b>									
Without Knob	SKS52	SKS53	SKS54	SKS55	SKS56	SKS57	SKS59	SKS501	SKS502
With Knob [95]	SKS52♦	SKS53♦	SKS54♦	SKS55♦	SKS56♦	SKS57♦	SKS59♦	SKS501♦	SKS502♦
<b>Illuminated Operators [93]</b>									
<b>Manual Return, Operator Only (without contact blocks) [94]</b>									
Without Knob, 110-120V 50-60 Hz Transformer	SK42J1	SK43J1	SK44J1	SK45J1	SK46J1	SK47J1	SK49J1	SK401J1	SK402J1
With Standard Red Knob, 110-120V 50-60 Hz Transformer	SK42J1R	SK43J1R	SK44J1R	SK45J1R	SK46J1R	SK47J1R	SK49J1R	SK401J1R	SK402J1R
With other Color Knob [95] and other Voltage Light Module [97]	SK42J♦	SK43J♦	SK44J♦	SK45J♦	SK46J♦	SK47J♦	SK49J♦	SK401J♦	SK402J♦
<b>Spring Return from Left to Center, Operator Only (without contact blocks) [94]</b>									
Without Knob, 110-120V 50-60 Hz Transformer	SK62J1	SK63J1	SK64J1	SK65J1	SK66J1	SK67J1	SK69J1	SK601J1	SK602J1
With Standard Red Knob, 110-120V 50-60 Hz Transformer	SK62J1R	SK63J1R	SK64J1R	SK65J1R	SK66J1R	SK67J1R	SK69J1R	SK601J1R	SK602J1R
With other Color Knob [95] and other Voltage Light Module [97]	SK62J♦	SK63J♦	SK64J♦	SK65J♦	SK66J♦	SK67J♦	SK69J♦	SK601J♦	SK602J♦
<b>Spring Return from Right to Center, Operator Only (without contact blocks) [94]</b>									
Without Knob, 110-120V 50-60 Hz Transformer	SK72J1	SK73J1	SK74J1	SK75J1	SK76J1	SK77J1	SK79J1	SK701J1	SK702J1
With Standard Red Knob, 110-120V 50-60 Hz Transformer	SK72J1R	SK73J1R	SK74J1R	SK75J1R	SK76J1R	SK77J1R	SK79J1R	SK701J1R	SK702J1R
With other Color Knob [95] and other Voltage Light Module [97]	SK72J♦	SK73J♦	SK74J♦	SK75J♦	SK76J♦	SK77J♦	SK79J♦	SK701J♦	SK702J♦
<b>Spring Return from Both Sides to Center, Operator Only (without contact blocks) [94]</b>									
Without Knob, 110-120V 50-60 Hz Transformer	SK52J1	SK53J1	SK54J1	SK55J1	SK56J1	SK57J1	SK59J1	SK501J1	SK502J1
With Standard Red Knob, 110-120V 50-60 Hz Transformer	SK52J1R	SK53J1R	SK54J1R	SK55J1R	SK56J1R	SK57J1R	SK59J1R	SK501J1R	SK502J1R
With other Color Knob [95] and other Voltage Light Module [97]	SK52J♦	SK53J♦	SK54J♦	SK55J♦	SK56J♦	SK57J♦	SK59J♦	SK501J♦	SK502J♦

19 PUSH BUTTONS AND OPERATOR INTERFACE

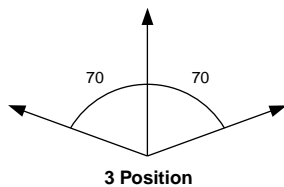

Table 19.260: Selector Switch Assembly Code and Knob Cat. No.

Color	Standard Knob		Gloved Hand Knob	
	[98] Knob Code	Cat. No. [93]	[98] Knob Code	Cat. No. [93]
Black	B	B11	FB	B25
Red	R	R8	FR	R24
Green	G	G8	FG	G24
Yellow	Y	Y8	FY	Y24
Blue	L	L8	FL	L24
White	W	W8	FW	W24
Amber	A	A8	FA	A24
Clear	C	C8	FC	C24

Contact Blocks: Contact Blocks, page 19-90, Hermetically Sealed Logic Reed Contact Blocks, page 19-92, Hermetically Sealed Power Reed Contact Blocks, page 19-92  
 Light Modules: Standard Light Modules, page 19-91  
 Knobs and Accessories: Additional Accessories for Type K and SK Operators, page 19-99

[93] When ordering, add prefix 9001 to the catalog number.

[94] These operators can be ordered complete with contact blocks. Add the "H code" from "H Codes, page 19-93 as needed for your application.

[95] ♦ Add the knob color code chosen from the Selector Switch Assembly Code table. For LED, knob color must match LED.

[96] For other color knobs replace the B with knob color code. See Table 19.260 Selector Switch Assembly Code and Knob Cat. No., page 19-86.

[97] ■ Add the voltage assembly code as chosen from Standard Light Modules, page 19-91. Example: K25J with 208Vac = K25J3

[98] Add the knob color code. For LED, knob color must match LED.

9001SK 4-Position Selector Switches

Table 19.261: 4-Position Selector Switches

Contact Block Required		1 — Contact Closed 0 — Contact Open								
Contact Block Position	Quantity and Type	Mount on Side		↖	↗	↘	↙			
<p>Top View</p>	KA1 	or	KA3 	KA1 #2	or	KA3 #2	1	0	0	0
			KA2 			KA2 #2	0	0	1	0
	KA1 	or	KA3 	KA1 #1	or	KA3 #1	0	0	0	1
			KA2 			KA2 #1	0	1	0	0
Cam (see Type K, KX, and SK Selector Switch Guide, page 19-78)						H				
<b>Non-Illuminated Operators</b>						<b>Type [99]</b>				
<b>Manual Return [100], Operator Only (without contact blocks)</b>										
Without Knob						SKS88				
With other Color Knob [101]						SKS88♦				
<b>Illuminated Operators</b>						<b>Type [99]</b>				
<b>Manual Return [100], Operator Only (without contact blocks)</b>										
Without Knob, 110-120V 50-60 Hz Transformer						SK88J1				
With Standard Red Knob, 110-120V 50-60 Hz Transformer						SK88J1R				
With other Color Knob [101] and other Voltage Light Module [102]						SK88J♦				

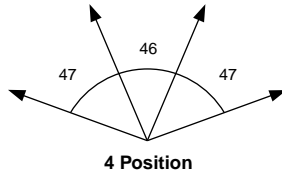

Table 19.262: Selector Switch Assembly Code and Knob Cat. No.

Color	Standard Knob		Gloved Hand Knob	
	[103] Knob Code	Cat. No. [99]	[103] Knob Code	Cat. No. [99]
Black	B	B11	FB	B25
Red	R	R8	FR	R24
Green	G	G8	FG	G24
Yellow	Y	Y8	FY	Y24
Blue	L	L8	FL	L24
White	W	W8	FW	W24
Amber	A	A8	FA	A24
Clear	C	C8	FC	C24

For Contact Blocks, see Contact Blocks, page 19-90, Hermetically Sealed Logic Reed Contact Blocks, page 19-92, Hermetically Sealed Power Reed Contact Blocks, page 19-92  
For Light Modules, see Standard Light Modules, page 19-91  
For Knobs and Accessories, see Additional Accessories for Type K and SK Operators, page 19-99

Potentiometers with Dial Plate

Table 19.263: Potentiometers with Dial Plate (not UL listed)—Maximum Voltage 300 Vac

Power	Description	Ratings	Type
2 W	Operator Only, for Single Potentiometer	NEMA 4, 13	SK20
	Operator with Single Potentiometer		SK21
	Operator Only, for Tandem Potentiometer		SK22
	Operator with Tandem Potentiometer		SK23

When ordering, add prefix 9001 to the catalog number.

Table 19.264: Potentiometer Suffixes

Single Potentiometer			
Suffix [104]	Resistance	Suffix [104]	Resistance
01	50 Ω	07	5 kΩ
02	100 Ω	08	10 kΩ
04	500 Ω	09	25 kΩ
05	1 kΩ	13	500 kΩ
39	2 kΩ	37	750 kΩ
06	2.5 kΩ	14	1 MΩ
Tandem Potentiometer			
Suffix [104]	Resistance		
	Front	Rear	
82	1 kΩ	1 kΩ	

NOTE: Any potentiometer with a shaft 7/8 in. long and 1/4 in. diameter may be used with these operators.

[99] When ordering, add prefix 9001 to the catalog number.

[100] These operators can be ordered complete with contact blocks. Add the "H" code from "H" Codes, page 19-93 as needed for your application.

[101] ♦ Add the knob color code chosen from the Selector Switch Assembly Code table. For LED, knob color must match LED.

[102] ■ Add the voltage assembly code as chosen from Standard Light Modules, page 19-91. Example: K25J with 208Vac = K25J3

[103] Add the knob color code from Table 19.237. For LED, knob color must match LED

[104] For the complete part number, add the suffix from this table to the catalog number from Table 19.263 Potentiometers with Dial Plate, page 19-87. Example: 9001K2105.

Type SK Corrosion Resistant Pilot Lights

Table 19.265: Pilot Lights—UL Types 4, 4X, [105]



Description			Voltage	Style	With Red Fresnel Color Cap [106]	With Green Fresnel Color Cap [106]	With Other Color Cap [106] [107]	Without Color Cap [106]
	9001SKP1	Standard Pilot Light (Fresnel color cap shown)	110–120 V, 50–60 Hz	Transformer	SKP1R31	SKP1G31	SKP1■	SKP1
			220–240 V, 50–60 Hz	Transformer	SKP7R31	SKP7G31	SKP7■	SKP7
			24–28 Vac/Vdc	Full Voltage	SKP35R31	SKP35G31	SKP35■	SKP35
			For other voltages [106]	Transformer, Flashing or LED [108] Full Voltage, Neon or Resistor [109]	SKP▲R31 SKP▲G31	SKP▲G31 SKP▲■	SKP▲■	SKP▲
	9001SKT1	Push-To-Test Pilot Light (Fresnel color cap shown)	110–120 V, 50–60 Hz	Transformer	SKT1R31	SKT1G31	SKT1■	SKT1
			220–240 V, 50–60 Hz	Transformer	SKT7R31	SKT7G31	SKT7■	SKT7
			24–28 Vac/Vdc	Full Voltage	SKT35R31	SKT35G31	SKT35■	SKT35
			For other voltages [106]	Transformer, Flashing or LED [108] Full Voltage, Neon or Resistor [109]	SKT▲R31 SKT▲G31	SKT▲G31 SKT▲■	SKT▲■	SKT▲
	9001SKTR38	Remote Test Pilot Light (Fresnel color cap shown)	120 Vac Only	Resistor	SKTR38R31	SKTR38G31	SKTR38■	SKTR38
			24–28 Vac Only	Full Voltage	SKTR35R31	SKTR35G31	SKTR35■	SKTR35
			For other voltages [106] [107] [110]	Full Voltage or Resistor [111]	SKTR▲R31	SKTR▲G31	SKTR▲■	SKTR▲

Table 19.266: Color Caps

Color	Plastic Fresnel [112]	Plastic Domed [112]
Amber	A31	A9
Blue	L31	L9
Clear	C31	C9
Green	G31	G9
Red	R31	R9
White	W31	W9
Yellow	Y31	Y9



Typical Wiring Diagram

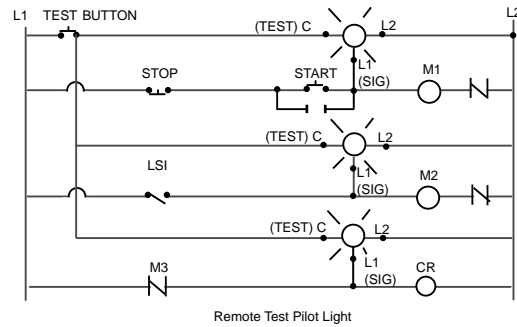
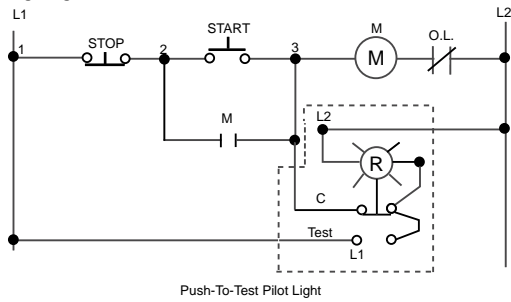

**NOTE:** To select and order Contact Blocks, Light Modules, Knobs, and Accessories, see Type KA Contact Blocks, page 19-90 through Hermetically Sealed Power Reed Contact Blocks, page 19-92.

**NOTE:** For use in hazardous locations—See Square D Offering According to Class, Division, and Group, page 19-92. Contact blocks and legend plate not included unless otherwise noted.

[105] When ordering, add prefix 9001 to the catalog number.

[106] ▲ Add the voltage assembly code as chosen from Standard and Shallow Depth Light Modules, page 19-91. EXAMPLE: SKT\*\*\*R31 with 208 Vac red LED voltage = SKT37LRR31.

[107] ■ Add the color code as chosen from the color cap table below. EXAMPLE: SKP1 with a blue fresnel cap = SKP1L31.

[108] The cap must be the same color as the LED light module chosen, e.g., for a green LED, use a green color cap.

[109] On neon light modules, use clear color caps only.

[110] Use only full voltage or resistor voltage assembly codes on remote test pilot lights. Do not choose LED, neon or transformer codes. For AC use only.

[111] Use only full voltage or resistor voltage assembly codes on remote test pilot lights. Do not choose LED (exception — these LED codes are allowed: 38LG, 38LL, 38LR, 38LW, 38LY), neon or transformer codes. For AC use only.

[112] Add the color code as chosen from the color cap table below. EXAMPLE: SKP1 with a blue fresnel cap = SKP1L31.



**Type SK Corrosion Resistant Multifunction Operators**

**Table 19.267: Multifunction Operators—UL Types 4, 4X, 13/NEMA 4, 4X, 13 [113][114]**

Interlocked Assembly	Description	Color	Contacts [115]	Without Contacts [115]
	Interlocked Assembly Both Buttons Maintained	Universal [116]	SKR11UH1	SKR11U
		Other [117]	SKR11▼H1	SKR11▼
	Interlocked Assembly One Button Momentary	Universal [116]	SKR12UH1H1	SKR12U
	Interlocked Assembly One Button Maintained	Other [117]	SKR12▼H1H1	SKR12▼

[113] For use in hazardous locations—See Square D Offering According to Class, Division, and Group, page 19-92.

[114] Legend plate and contact block not included unless otherwise noted.

[115] When ordering, add prefix 9001 to the catalog number.

[116] Universal for SKR11,12 includes 2 each of black, red, green, yellow, orange, blue, white.

[117] ▼ Choose one color for each button. R = red, G = green, B = Black. **Example: 9001SKR11 with top button gray and bottom button orange = 9001SKR11ES.** See Table 19.252 Color Codes, page 19-83

### Type KA Contact Blocks

The Class 9001 Type KA contact blocks are Fingersafe® contact blocks (meeting VDE 0106 Part 100). They have one screw mounting and captive (backed out) plus/minus terminal screws. These contact blocks are double-break, direct-acting contacts. Because of the wiping action of these contacts, they are suitable for use with programmable controllers. All contact blocks listed below accept up to 2 #12–#24 AWG solid or stranded wires. Recommended tightening torque for screw terminals is 7 lb-in.

**Table 19.268: Standard Contact Blocks**

Description	Symbol	Type
 (Clear Cover)	 Direct-Acting	KA1
 (Green Cover)		KA2
 (Red Cover)	 Direct-Acting	KA3
 (Clear Cover)	 N.O. Contact Early Closing	KA4
 (Red Cover)	 N.C. Contact Late Opening	KA5
 (Green Cover)	 N.O. Contact Early Closing	KA6

Symbol	Contact Blocks with Binder Head Screws (not Fingersafe)		Gold Flashed Contacts with Standard Pressure Wire Terminals
	Type [119]	Quantity [120]	Type [119]
	KA21	25–Up	KA31
	KA22	25–Up	KA32
	KA23	25–Up	KA33
 N.O. Early Closing	KA24	25–Up	KA34
 N.C. Contact Late Opening	KA25	25–Up	KA35

Contact blocks listed below are not Fingersafe, but provide:

- Terminals that accept ring tongue/fork tongue connectors
- Short single circuit contact blocks (0.75" deep vs. 0.97" deep on the Fingersafe)
- Same as old style Series G product available prior to March, 1989.
- For assembled operators, use form Y238 (add to catalog number as suffix, for example: 9001KRU1H13Y238)



**Table 19.270: Contact blocks (not Fingersafe)**

Symbol	Type [119]	Symbol	Type [119]
	KA1G	 N.O. Contact Early Closing	KA4G
	KA2G	 N.C. Contact Late Opening	KA5G
	KA3G	 N.O. Contact Early Closing	KA6G

**Table 19.271: Contact blocks with Quick-Connect terminals (not Fingersafe)**

Symbol	Type [119]
	KA12
	KA13

**Table 19.269: Additional Circuit Arrangements**

Description	Symbol	Type
Sequencing [118] N.O. Contact of KA4 closes before N.O. Contact on KA1	 KA4 KA1	Order One Type KA4 and One Type KA1
Overlapping [118] N.O. Contact of KA4 closes before N.C. Contact of KA5 Opens	 KA4 KA5	Order One Type KA4 and One Type KA5

**Table 19.272: Maximum Current Ratings for Control Circuit Contacts—Types KA1–KA6, KA21–KA25, KA31–KA35, KA1G–KA6G**

Volts	AC						Volts	DC				
	Inductive (NEMA / UL Type A600) 35% Power Factor					Resistive 75% Power Factor Make, Break and Continuous Amperes		Inductive and Resistive (NEMA Q600)				Continuous Carrying Capacity
	Make		Break		Continuous Carrying Amperes			Make and Break				
Amperes	VA	Amperes	VA			KA1	KA2 KA3	KA4	KA5 KA6			
120	60	7200	6.0	720	10	10	125	0.55	0.55	—	—	2.5
240	30		3.0				250	0.27	0.27	—	—	
480	15		1.5				600	0.10	0.10	—	—	
600	12		1.2									

[118] For push buttons or two-position selector switches only. For sequencing or overlapping contacts on other operators, refer to catalog 9001CT0001.

[119] When ordering, add prefix 9001 to the catalog number.

[120] Minimum order quantity is 25.

Standard and Shallow Depth Light Modules

Table 19.273: Standard Light Modules for Types K, SK, and KX Control Units [121][122][123][124]

Voltage	Description	Light Module	Voltage Assembly Code	Rating	Temperature Code T-Code	Replacement Lamp Part Number [121]
		Type [125]				
All	Full Voltage (without Bayonet Base Lamp)	KM40	40	—	—	None
6 Vac/Vdc	Full Voltage	KM31	31	.9 VA	T5	2550101020
6 Vac/Vdc	LED Red	KM31LR	31LR		T6	6508805201
6 Vac/Vdc	LED Green	KM31LG	31LG		T6	6508805203
6 Vac/Vdc	LED Yellow	KM31LY	31LY		T6	6508805202
12–14 Vac/Vdc	Full Voltage	KM32	32	1.2 VA	T5	2550101037
12–14 Vac/Vdc	LED Red	KM32LR	32LR		T6	6508805201
12–14 Vac/Vdc	LED Green	KM32LG	32LG		T6	6508805203
12–14 Vac/Vdc	LED Yellow	KM32LY	32LY		T6	6508805202
18 Vac/Vdc	Resistor	KM33	33	1.4 VA	T5	2550101037
24–28 Vac/Vdc	Full Voltage	KM35	35	1.2 VA	T3C	2550101002
24–28 Vac/Vdc	LED Red	KM35LR	35LR	.28 VA	T4	6508805210
24–28 Vac/Vdc	LED Green	KM35LG	35LG	.28 VA	T4	6508805212
24–28 Vac/Vdc	LED Yellow	KM35LY	35LY	.28 VA	T4	6508805211
24–28 Vac/Vdc	LED White	KM35LW	35LW	.28 VA	T4	6508805214
24–28 Vac/Vdc	LED Blue	KM35LL	35LL	.28 VA	T4	6508805213
48 Vac/Vdc	Full Voltage	KM36	36	2.6 VA	T3A	2550101025
110–120 V, 50–60 Hz	LED Red	KM1LR	1LR		T6	6508805201
110–120 V, 50–60 Hz	LED Green	KM1LG	1LG		T6	6508805203
110–120 V, 50–60 Hz	LED Yellow	KM1LY	1LY		T6	6508805202
110–120 V, 50–60 Hz	Transformer	KM1	1	2.4 VA	T6	2550101020
110–120 V, 50–60 Hz	Flashing	KMF1	F1	.85 VA	T6	2550101036
120 Vac/Vdc	Full Voltage/Resistor	KM38	38	3.0 VA	T4	2550101027
120 Vac/Vdc	Neon [126]	KM11	11	0.2 VA	T6	2550101013
120 Vac/Vdc	LED Red	KM38LR	38LR	1.4 VA	T4A	6508805210
120 Vac/Vdc	LED Green	KM38LG	38LG	1.4 VA	T4A	6508805212
120 Vac/Vdc	LED Yellow	KM38LY	38LY	1.4 VA	T4A	6508805211
120 Vac/Vdc	LED White	KM38LW	38LW	1.4 VA	T4A	6508805214
120 Vac/Vdc	LED Blue	KM38LL	38LL	1.4 VA	T4A	6508805213
208–220 V, 50–60 Hz	Transformer	KM3	3	2.5 VA	T6	2550101020
208–220 V, 50–60 Hz	LED Red	KM3LR	3LR		T6	6508805201
208–220 V, 50–60 Hz	LED Green	KM3LG	3LG		T6	6508805203
208–220 V, 50–60 Hz	LED Yellow	KM3LY	3LY		T6	6508805202
208–220 V, 50–60 Hz	LED White	KM3LW	3LW		T6	6508805215
208–220 V, 50–60 Hz	LED Blue	KM3LL	3LL		T6	6508805216
220–240 V, 50–60 Hz	Transformer	KM7	7	2.0 VA	T6	2550101020
220–240 V, 50–60 Hz	LED Red	KM7LR	7LR		T6	6508805201
220–240 V, 50–60 Hz	LED Green	KM7LG	7LG		T6	6508805203
220–240 V, 50–60 Hz	LED Yellow	KM7LY	7LY		T6	6508805202
220–240 V, 50–60 Hz	LED White	KM7LW	7LW		T6	6508805215
220–240 V, 50–60 Hz	LED Blue	KM7LL	7LL		T6	6508805216
240 Vac/Vdc	Resistor	KM25	25	6.0 VA	T3A	2550101027
240 Vac/Vdc	Neon [126]	KM12	12	0.3 VA	T6	2550101013
277 V, 50–60 Hz	Transformer	KM8	8	2.4 VA	T6	2550101020
380–480 V, 50–60 Hz	Transformer	KM5	5	2.8 VA	T6	2550101020
480 Vac/Vdc	Neon [126]	KM14	14	0.5 VA	T6	2550101013
550–600 V, 50–60 Hz	Transformer	KM6	6	2.5 VA	T6	2550101020



NOTE: Light modules are available in other voltages. For additional information, refer to Catalog 9001CT0001.

The products in Table 19.273 have been assigned Temperature Classifications (T-Codes) in accordance with UL 121201 (2017) — Nonincendive Electrical Equipment for Use in Class I and II, Division 2 and Class III, Divisions 1 and 2 Hazardous (Classified) Locations. These codes can aid the user in proper application of these products in accordance with ISO/ISA/IEC 60079-0 (2017-12) Explosive Atmospheres — Part 0: Equipment — General Requirements and the National Electric Code NFPA 70 — Article 500.

NOTE: Light modules shown in Table 19.274 are not UL Certified for use in hazardous locations.

Table 19.274: Shallow Depth Light Modules For Types K and SK Control Units [121] [123] [127] [122]

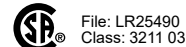

Voltage	Description	Light Module	Voltage Assembly Code	Rating	Temperature Code T-Code	Replacement Lamp Part Number
		Type [125]				
24–28 Vac/Vdc	Full Voltage	KM55	55	1.2 VA	—	2550101002
	LED Red	KM55LR	55LR	0.5 VA	—	6508805204
	LED Green	KM55LG	55LG		—	6508805206
	LED Yellow	KM55LY	55LY		—	6508805205
110–120 Vac/Vdc	Full Voltage	KM58	58	3.0 VA	—	2550101027
	LED Red	KM58LR	58LR	0.5 VA	—	6508805204
	LED Green	KM58LG	58LG		—	6508805206
	LED Yellow	KM58LY	58LY		—	6508805205



- [121] For use with all operators except KX and remote test pilot.
- [122] For use in hazardous locations—See Square D Offering According to Class, Division, and Group, page 19-92.
- [123] With LED light modules, use either a clear color cap or a cap the same color as the LED.
- [124] With neon type light modules, use a clear color cap only.
- [125] When ordering, add prefix 9001 to the catalog number.
- [126] Not for use on KX operators.
- [127] Reduces the depth of illuminated push buttons with contact blocks by over 33%.

Hazardous locations do not always require the use of explosion-proof equipment like the Class 9001 Type BR control stations. Selecting the most appropriate device for the location can save you money. For more information on the types of hazardous locations, contact your local electrical inspector.

Table 19.275: Hazardous Locations

Types K, SK  File: E10054 (N) CCN: NOIV  File: LR26817 Class: 3218 02

Square D Offering According to Class, Division, and Group

Table 19.276: Square D Offering According to Class, Division, and Group

For			Use
Class	Division	Group(s)	
I	1	A	1. Intrinsically Safe System
I	1	B, C, D	1. 9001 BR station
			2. Intrinsically Safe System
I	2	A	1. 9001 K, SK, KX control stations with restrictions [128] [129]
			2. Intrinsically Safe System
I	2	B, C, D	1. 9001 BR station
			2. 9001 K, SK, KX control stations with restrictions [128] [129]
			3. Intrinsically Safe System
II	1	E, F, G	1. 9001 BR station
			2. Intrinsically Safe System
II	2	E, F	1. 9001 BR station
			2. 9001 K, SK, KX control stations with restrictions [128] [129]
			3. Intrinsically Safe System
II	2	G	1. 9001 BR station
			2. 9001 K, SK, KX control stations with restrictions [130] [129]
			3. Intrinsically Safe System
III	1, 2	—	1. 9001 BR Station
			2. 9001 K, SK, KX control stations with restrictions [130] [129]
			3. Intrinsically Safe System

Hermetically Sealed Logic Reed Contact Blocks

Table 19.277: Hermetically Sealed Logic Reed Contact Blocks [131] [132]

Suitable for use on low energy level circuits



Description	Symbol	Type [133]
The maximum number of logic and/or power reed contact blocks per operator is as indicated on individual selection tables for standard contact blocks, <b>except</b> : <ul style="list-style-type: none"> <li>On 3 position selector switches with cams C, D, E, F, G, L, or M, mount reed blocks on <b>one side only</b> (either side), maximum 2 in tandem.</li> <li>On 4 position selector switches, mount reed blocks on <b>one side only</b> (either side), maximum 2 in tandem.</li> <li>On joysticks or on Type KR8 or SKR8 push-pull operators, mount reed blocks on <b>one side only</b> (either side), maximum 2 in tandem.</li> </ul>		KA41
		KA42
		KA43
		KA44
		KA45

Max. Vac/Vdc	Maximum Load		
	Resistive	Inductive	Continuous
32/30	.25 A	.10 A	.5 A
120/100	8 VA	3 VA	.5 A

Hermetically Sealed Power Reed Contact Blocks

Table 19.278: Hermetically Sealed Power Reed Contact Blocks [131] [132] [134]



Description	Symbol	Type [133]
The maximum number of logic and/or power reed contact blocks per operator is as indicated on individual selection tables for standard contact blocks, <b>except</b> : <ul style="list-style-type: none"> <li>On 3 position selector switches with cams C, D, E, F, G, L, or M, mount reed blocks on <b>one side only</b> (either side), maximum 2 in tandem.</li> <li>On 4 position selector switches, mount reed blocks on <b>one side only</b> (either side), maximum 2 in tandem.</li> <li>On joysticks or on Type KR8 or SKR8 push-pull operators, mount reed blocks on <b>one side only</b> (either side), maximum 2 in tandem.</li> </ul>		KA51
		KA52
		KA53
		KA54
		KA55

Volts	Make		Break		Continuous
	A	VA	A	VA	
<b>AC NEMA C300 [135]</b>					
120	10.00	1200	1.000	120	3.0
240	5.00		.500		
<b>DC NEMA Q150 [136]</b>					
115	.50	58	.50	58	3.0

[128] Any Class 9001 Type K, SK or KX operator can be used in an area classified as Class I, Division 2 hazardous locations, if:

- Only logic (KA40 series) or power (KA50 series) reed contact blocks are used.
- All Type K and SK illuminated operators are UL approved for use in Class I Division 2 areas. (Add Form Y243 to single lamp Push-To-Test pilot lights.)
- Type KX illuminated operators do not use 4 lamp light modules, or 2 lamp light modules other than the transformer type. (Add Form Y243 to single lamp Push-To-Test pilot lights.)
- The operators are mounted in any NEMA 4 & 13 enclosures.

[129] UL Listed: File E10054(N), CCN NOIV.

[130] Any Class 9001 Type K, SK, or KX operator mounted in a Class 9001 Type KY, KYSS, KYAF, SKY enclosure may be used, except potentiometer operators.

[131] Not for use in pendant stations.

[132] When ordering, add prefix 9001 to the catalog number.

[133] All contact blocks listed below accept #12–18 solid or stranded wire.

[134] The power reed contact blocks can be used with standard industrial relays and starters through NEMA Size 4. Minimum voltage is 5 V and the minimum current is 1 mA.

[135] Inductive Rating—35% Power Factor.

[136] Inductive and Resistive Ratings

**Type K, SK, and KX Contact Block "H" Numbers**

The design of Class 9001 Type KA contact blocks allows them to be mounted side by side and/or in tandem. This enables you to specify an operator and a specific arrangement of contact blocks (shipped fully assembled) with a single Type number.

**Table 19.279: "H" Codes**

Suffix No. (Add to Operator Type)	Positions					
	1	2	3	4	5	6
<b>Example:</b> A Type KR1B push button with 2 Type KA1 contact blocks would be Class 9001 Type KR1BH2.	H1 H2 H3 H4	KA1 KA1 KA1 KA1	KA1 KA1 KA1 KA1	KA1 KA1 KA1 KA1	KA1 KA1 KA1 KA1	KA1 KA1 KA1 KA1
	H5 H6 H7 H8	KA2 KA3 KA2 KA3	KA2 KA3 KA2 KA3	KA2 KA3 KA2 KA3	KA2 KA3 KA2 KA3	KA2 KA3 KA2 KA3
	H9 H10 H11 H12	KA4 KA4 KA1 KA2	KA1 KA5 KA1 KA3	KA1 KA1 KA1 KA3	KA1 KA1 KA1 KA3	KA1 KA1 KA1 KA3
	H13 H14 H15 H16	KA1 KA1 KA2 KA2	KA1 KA3 KA2 KA3	KA1 KA1 KA2 KA3	KA1 KA1 KA2 KA3	KA1 KA1 KA2 KA3
	H17 H18 H19 H21	KA1 KA1 KA1 KA2	KA1 KA1 KA1 KA3	KA1 KA1 KA1 KA3	KA1 KA1 KA1 KA3	KA1 KA1 KA1 KA3
	H23 H24 H25	KA1 KA1 KA5	KA1 KA2 KA3	KA1 KA1 KA1	KA1 KA1 KA1	KA1 KA1 KA1

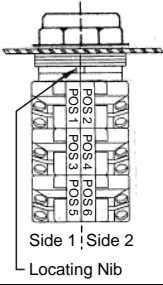

**NOTE:** For "H" Codes not in this table, contact your local Schneider Electric Customer Care Center.

**Mounting Hole for All Types K, SK, and KX Control Units**

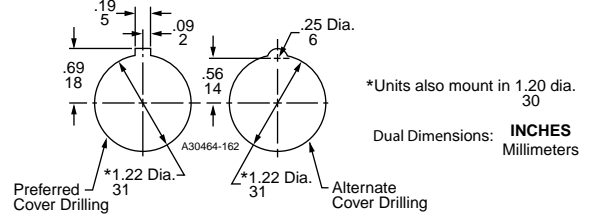

\*Units also mount in 1.20 dia. 30  
Dual Dimensions: INCHES / Millimeters

**Hole Punch:** Use Greenlee Tool #60242 to punch mounting hole and notch.

**Maximum Contact Block Usage (Includes Types K, SK and KX)**

- **2 blocks mounted side by side only:** Any 2, 3 or 4 position spring return selector switch (non-illuminated, illuminated or keyed).
- **2 blocks mounted in tandem 1 side only:** Any 2 operator interlocked push button.
- **2 blocks mounted in tandem (total of four blocks):** Any selector push button, keyed push button, 2, 3, or 4 position maintained selector switch (non-illuminated, illuminated or keyed), push-pull operators (non-illuminated or illuminated), joy stick, dual push button.
- **3 blocks mounted in tandem (total of six blocks):** Single momentary push buttons (non-illuminated or illuminated).

**Table 19.280: Dimensions When Using Contact Blocks**

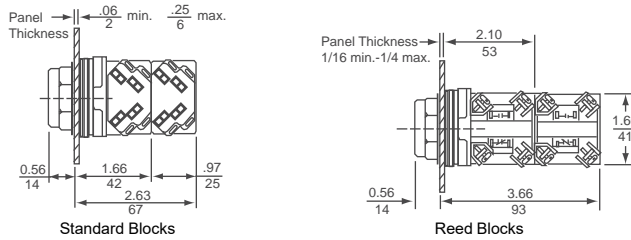

**Table 19.281: Basic Operators (Without Color Caps, Mushroom Buttons, Knobs, Selector Switch Cams, Contact Blocks, Light Modules, or Legend Plates)**

Description	For UL Types/NEMA	
	1, 3R, 4, 12, 13 [137]	4, 4X, 13 [137]
Non-Illuminated Push Button (Extended Guard)	KR2	SKR2
Non-Illuminated Push Button (No Guard)	KR3	SKR3
Non-Illuminated Push Button (Mushroom Button/Screw-On)	KR20	SKR20
Non-Illuminated Dual Push Button (Momentary)	KR6	—
Non-Illuminated Dual Push Button (Momentary Interlocked)	KR67	—
Non-Illuminated Dual Push Button (Maintained Interlocked)	KR7	—
Momentary Pull—Maintained Neutral—Momentary Push	KR8 [138] [139]	SKR8 [138]
Maintained Pull—Maintained Push	KR9 [138] [139]	SKR9 [138]
Illuminated Push Button (Full Guard—Plastic Top)	K1L [140]	SK1L [140]
Illuminated Push Button and Push-To-Test (No Guard)	K2L [140] [141]	SK2L [140] [141]
Illuminated Push Button (Full Guard—Metal Top)	K3L [140]	—
Standard Pilot Light	KP	SKP
3 Position Maintained Selector Switch	KS4 [138]	SKS4 [138]
3 Position Spring Return Both Sides To Center—Selector Switch	KS5 [138]	SKS5 [138]
3 Position Spring Return Left To Center—Selector Switch	KS6 [138]	SKS6 [138]
3 Position Spring Return Right To Center—Selector Switch	KS7 [138]	SKS7 [138]



**Table 19.282: Min. Centerline Spacing, Type K & SK Control Units**

Legend Plate	Operator	Centerline Spacing (in.)					
		A	B	C	D	E	F
<b>Legend Plate Orientation Position #1</b>							
KN2	Standard Push Button	1.75	1.31	1.44	2.25	1.69	0.88
	1.375 in. Dia. Mushroom	1.75	1.31	1.44	2.25	1.69	0.88
KN5	2.25 in. Dia. Mushroom	2.25	1.31	1.44	2.25	2.25	1.12
	Selector Switch Knobs	1.75	1.31	1.44	2.25	1.69	0.88
KN3	Standard Push Button	2.00	1.31	1.44	2.25	1.75	0.88
	1.375 in. Dia. Mushroom	2.00	1.31	1.44	2.25	1.75	0.88
KN4	2.25 in. Dia. Mushroom	2.25	1.31	1.44	2.25	2.25	1.12
	Selector Switch Knobs	2.00	1.31	1.44	2.25	1.75	0.88
KN6	Standard Push Button	2.38	1.62	1.44	2.25	2.25	1.12
	1.375 in. Dia. Mushroom	2.38	1.62	1.44	2.25	2.25	1.12
KN6	2.25 in. Dia. Mushroom	2.38	1.62	1.44	2.25	2.25	1.12
	Selector Switch Knobs	2.38	1.62	1.44	2.25	2.25	1.12
<b>Legend Plate Orientation Position #2</b>							
KN2	Standard Push Button	1.62	1.31	1.44	2.25	1.75	0.88
	1.375 in. Dia. Mushroom	1.62	1.31	1.44	2.25	1.75	0.88
KN5	2.25 in. Dia. Mushroom	2.25	1.31	1.44	2.25	2.25	1.12
	Selector Switch Knobs	1.62	1.31	1.44	2.25	1.75	0.88
KN3	Standard Push Button	1.75	1.31	1.44	2.25	2.00	0.88
	1.375 in. Dia. Mushroom	1.75	1.31	1.44	2.25	2.00	0.88
KN4	2.25 in. Dia. Mushroom	2.25	1.31	1.44	2.25	2.25	1.12
	Selector Switch Knobs	1.75	1.31	1.44	2.25	2.00	0.88
KN6	Standard Push Button	1.62	1.31	1.44	2.25	1.94	1.00
	1.375 in. Dia. Mushroom	1.62	1.31	1.44	2.25	1.94	1.00
KN6	2.25 in. Dia. Mushroom	2.25	1.31	1.62	2.38	2.38	0.88
	Selector Switch Knobs	2.25	1.31	1.62	2.38	2.38	0.88

[137] When ordering, add prefix 9001 to the catalog number.  
 [138] Operator can be converted to an illuminated operator by removing the liner (6512240601) and adding a light module.  
 [139] These operators can be supplied with 1-3/8 in. or 2-1/4 in. dia. mushroom buttons. For 1-3/8 in.: add ( ) 20 to type number. For 2-1/4 in.: Add ( ) 21 to type number. The ( ) refers to the color chosen—see Additional Accessories for Type K and SK Operators, page 19-99. Voids UL and NEMA 6 Rating.  
 [140] Operator can be converted to a non-illuminated operator by adding liner (6512240601).  
 [141] Operator includes jumper wires for push-to-test conversion.

Legend Plates for Types K and SK Operators

Table 19.283: Legend Plates

Standard Markings	Plastic Legend Plates [142] [143] for use with Types K and SK Operators									Aluminum Legend Plates [144] for use with Type K Operators		
	1-3/4" Square			2-1/4" Square			2-1/2" Square			Black Legend	Black Legend	Blue Legend
	Silver Legend with Black Letters	White Legend with Black Letters	Black Legend with White Letters	Silver Legend with Black Letters	White Legend with Black Letters	Black Legend with White Letters	Silver Legend with Black Letters	White Legend with Black Letters	Black Legend with White Letters			
<b>For Push Button or Pilot Light</b>										<b>KN200</b>	<b>KN300</b>	<b>KN800</b>
Blank	KN200SP	KN200WP	KN200BP	KN100SP	KN100WP	KN100BP	KN700SP	KN700WP	KN700BP	KN200	KN300	KN800
Blank (red)	KN200RP	KN200RP	KN200RP	KN100RP	KN100RP	KN100RP	KN700RP	KN700RP	KN700RP	KN200R	KN300R	KN800R
Start	KN201SP	KN201WP	KN201BP	KN101SP	KN101WP	KN101BP	KN701SP	KN701WP	KN701BP	KN201	KN301	KN801
Stop	KN202RP	KN202RP	KN202RP	KN102RP	KN102RP	KN102RP	KN702RP	KN702RP	KN702RP	KN202	KN302	KN802
On	KN203SP	KN203WP	KN203BP	KN103SP	KN103WP	KN103BP	KN703SP	KN703WP	KN703BP	KN203	KN303	KN803
Off	KN204RP	KN204RP	KN204RP	KN104RP	KN104RP	KN104RP	KN704RP	KN704RP	KN704RP	KN204	KN304	KN804
Emerg. Stop	KN205RP	KN205RP	KN205RP	KN105RP	KN105RP	KN105RP	KN705RP	KN705RP	KN705RP	KN205	KN305	KN805
Forward	KN206SP	KN206WP	KN206BP	KN106SP	KN106WP	KN106BP	KN706SP	KN706WP	KN706BP	KN206	KN306	KN806
Reverse	KN207SP	KN207WP	KN207BP	KN107SP	KN107WP	KN107BP	KN707SP	KN707WP	KN707BP	KN207	KN307	KN807
Close	KN208SP	KN208WP	KN208BP	KN108SP	KN108WP	KN108BP	KN708SP	KN708WP	KN708BP	KN208	KN308	KN808
Open	KN209SP	KN209WP	KN209BP	KN109SP	KN109WP	KN109BP	KN709SP	KN709WP	KN709BP	KN209	KN309	KN809
Down	KN210SP	KN210WP	KN210BP	KN110SP	KN110WP	KN110BP	KN710SP	KN710WP	KN710BP	KN210	KN310	KN810
Up	KN211SP	KN211WP	KN211BP	KN111SP	KN111WP	KN111BP	KN711SP	KN711WP	KN711BP	KN211	KN311	KN811
Fast	KN212SP	KN212WP	KN212BP	KN112SP	KN112WP	KN112BP	KN712SP	KN712WP	KN712BP	KN212	KN312	KN812
Slow	KN213SP	KN213WP	KN213BP	KN113SP	KN113WP	KN113BP	KN713SP	KN713WP	KN713BP	KN213	KN313	KN813
High	KN214SP	KN214WP	KN214BP	KN114SP	KN114WP	KN114BP	KN714SP	KN714WP	KN714BP	KN214	KN314	KN814
Low	KN215SP	KN215WP	KN215BP	KN115SP	KN115WP	KN115BP	KN715SP	KN715WP	KN715BP	KN215	KN315	KN815
Inch	KN216SP	KN216WP	KN216BP	KN116SP	KN116WP	KN116BP	KN716SP	KN716WP	KN716BP	KN216	KN316	KN816
In	KN217SP	KN217WP	KN217BP	KN117SP	KN117WP	KN117BP	KN717SP	KN717WP	KN717BP	KN217	KN317	KN817
Jog	KN218SP	KN218WP	KN218BP	KN118SP	KN118WP	KN118BP	KN718SP	KN718WP	KN718BP	KN218	KN318	KN818
Jog For.	KN219SP	KN219WP	KN219BP	KN119SP	KN119WP	KN119BP	KN719SP	KN719WP	KN719BP	KN219	KN319	KN819
Jog Rev.	KN220SP	KN220WP	KN220BP	KN120SP	KN120WP	KN120BP	KN720SP	KN720WP	KN720BP	KN220	KN320	KN820
Lower	KN221SP	KN221WP	KN221BP	KN121SP	KN121WP	KN121BP	KN721SP	KN721WP	KN721BP	KN221	KN321	KN821
Out	KN222SP	KN222WP	KN222BP	KN122SP	KN122WP	KN122BP	KN722SP	KN722WP	KN722BP	KN222	KN322	KN822
Reset	KN223SP	KN223WP	KN223BP	KN123SP	KN123WP	KN123BP	KN723SP	KN723WP	KN723BP	KN223	KN323	KN823
Run	KN224SP	KN224WP	KN224BP	KN124SP	KN124WP	KN124BP	KN724SP	KN724WP	KN724BP	KN224	KN324	KN824
Start Jog	KN225SP	KN225WP	KN225BP	KN125SP	KN125WP	KN125BP	KN725SP	KN725WP	KN725BP	KN225	KN325	KN825
Test	KN226SP	KN226WP	KN226BP	KN126SP	KN126WP	KN126BP	KN726SP	KN726WP	KN726BP	KN226	KN326	KN826
Raise	KN227SP	KN227WP	KN227BP	KN127SP	KN127WP	KN127BP	KN727SP	KN727WP	KN727BP	KN227	KN327	KN827
Decrease	KN228SP	KN228WP	KN228BP	KN128SP	KN128WP	KN128BP	KN728SP	KN728WP	KN728BP	KN228	KN328	KN828
Increase	KN229SP	KN229WP	KN229BP	KN129SP	KN129WP	KN129BP	KN729SP	KN729WP	KN729BP	KN229	KN329	KN829
Left	KN230SP	KN230WP	KN230BP	KN130SP	KN130WP	KN130BP	KN730SP	KN730WP	KN730BP	KN230	KN330	KN830
Right	KN231SP	KN231WP	KN231BP	KN131SP	KN131WP	KN131BP	KN731SP	KN731WP	KN731BP	KN231	KN331	KN831
Cycle Start	KN232SP	KN232WP	KN232BP	KN132SP	KN132WP	KN132BP	KN732SP	KN732WP	KN732BP	KN232	KN332	KN832
Feed Start	KN233SP	KN233WP	KN233BP	KN133SP	KN133WP	KN133BP	KN733SP	KN733WP	KN733BP	KN233	KN333	KN833
Cycle Stop	KN234SP	KN234WP	KN234BP	KN134SP	KN134WP	KN134BP	KN734SP	KN734WP	KN734BP	KN234	KN334	KN834
Motor Run	KN236SP	KN236WP	KN236BP	KN136SP	KN136WP	KN136BP	KN736SP	KN736WP	KN736BP	KN236	KN336	KN836
Motor Stop	KN237SP	KN237WP	KN237BP	KN137SP	KN137WP	KN137BP	KN737SP	KN737WP	KN737BP	KN237	KN337	KN837
Power On	KN238SP	KN238WP	KN238BP	KN138SP	KN138WP	KN138BP	KN738SP	KN738WP	KN738BP	KN238	KN338	KN838
Pull To Start Push To Stop	N/A	N/A	N/A	KN179SP	KN179WP	KN179BP	KN779SP	KN779WP	KN779BP	N/A	KN379	N/A
<b>For Selector Switch or Selector Push Button</b>												
For.-Rev.	KN239SP	KN239WP	KN239BP	KN139SP	KN139WP	KN139BP	KN739SP	KN739WP	KN739BP	KN239	KN339	KN839
Hand-Auto.	KN240SP	KN240WP	KN240BP	KN140SP	KN140WP	KN140BP	KN740SP	KN740WP	KN740BP	KN240	KN340	KN840
High-Low	KN241SP	KN241WP	KN241BP	KN141SP	KN141WP	KN141BP	KN741SP	KN741WP	KN741BP	KN241	KN341	KN841
Jog-Run	KN242SP	KN242WP	KN242BP	KN142SP	KN142WP	KN142BP	KN742SP	KN742WP	KN742BP	KN242	KN342	KN842
Man.-Auto.	KN243SP	KN243WP	KN243BP	KN143SP	KN143WP	KN143BP	KN743SP	KN743WP	KN743BP	KN243	KN343	KN843
Off-On	KN244SP	KN244WP	KN244BP	KN144SP	KN144WP	KN144BP	KN744SP	KN744WP	KN744BP	KN244	KN344	KN844
On-Off	KN245SP	KN245WP	KN245BP	KN145SP	KN145WP	KN145BP	KN745SP	KN745WP	KN745BP	KN245	KN345	KN845
Open-Close	KN246SP	KN246WP	KN246BP	KN146SP	KN146WP	KN146BP	KN746SP	KN746WP	KN746BP	KN246	KN346	KN846
Raise-Lower	KN247SP	KN247WP	KN247BP	KN147SP	KN147WP	KN147BP	KN747SP	KN747WP	KN747BP	KN247	KN347	KN847
Run-Jog	KN248SP	KN248WP	KN248BP	KN148SP	KN148WP	KN148BP	KN748SP	KN748WP	KN748BP	KN248	KN348	KN848
Slow-Fast	KN250SP	KN250WP	KN250BP	KN150SP	KN150WP	KN150BP	KN750SP	KN750WP	KN750BP	KN250	KN350	KN850
Start-Stop	KN251SP	KN251WP	KN251BP	KN151SP	KN151WP	KN151BP	KN751SP	KN751WP	KN751BP	KN251	KN351	KN851
Up-Down	KN253SP	KN253WP	KN253BP	KN153SP	KN153WP	KN153BP	KN753SP	KN753WP	KN753BP	KN253	KN353	KN853
Low-High	KN254SP	KN254WP	KN254BP	KN154SP	KN154WP	KN154BP	KN754SP	KN754WP	KN754BP	KN254	KN354	KN854
Stop-Start	KN255SP	KN255WP	KN255BP	KN155SP	KN155WP	KN155BP	KN755SP	KN755WP	KN755BP	KN255	KN355	KN855
Left-Right	KN256SP	KN256WP	KN256BP	KN156SP	KN156WP	KN156BP	KN756SP	KN756WP	KN756BP	KN256	KN356	KN856
On-Auto	KN276SP	KN276WP	KN276BP	KN176SP	KN176WP	KN176BP	KN776SP	KN776WP	KN776BP	KN276	KN376	KN876
Auto-Off-Hand	KN258SP	KN258WP	KN258BP	KN158SP	KN158WP	KN158BP	KN758SP	KN758WP	KN758BP	KN258	KN358	KN858
For.-Off-Rev.	KN259SP	KN259WP	KN259BP	KN159SP	KN159WP	KN159BP	KN759SP	KN759WP	KN759BP	KN259	KN359	KN859
Hand-Off-Auto.	KN260SP	KN260WP	KN260BP	KN160SP	KN160WP	KN160BP	KN760SP	KN760WP	KN760BP	KN260	KN360	KN860
Off-Off-Auto	KN262SP	KN262WP	KN262BP	KN162SP	KN162WP	KN162BP	KN762SP	KN762WP	KN762BP	KN262	KN362	KN862
Open-Off-Close	KN263SP	KN263WP	KN263BP	KN163SP	KN163WP	KN163BP	KN763SP	KN763WP	KN763BP	KN263	KN363	KN863
Up-Off-Down	KN264SP	KN264WP	KN264BP	KN164SP	KN164WP	KN164BP	KN764SP	KN764WP	KN764BP	KN264	KN364	KN864
Low-Off-High	KN265SP	KN265WP	KN265BP	KN165SP	KN165WP	KN165BP	KN765SP	KN765WP	KN765BP	KN265	KN365	KN865
Jog-Stop-Run	KN267SP	KN267WP	KN267BP	KN167SP	KN167WP	KN167BP	KN767SP	KN767WP	KN767BP	KN267	KN367	KN867
High-Low-Off	KN270SP	KN270WP	KN270BP	KN170SP	KN170WP	KN170BP	KN770SP	KN770WP	KN770BP	KN270	KN370	KN870
High-Off-Low	KN277SP	KN277WP	KN277BP	KN177SP	KN177WP	KN177BP	KN777SP	KN777WP	KN777BP	KN277	KN377	KN877
Auto-Man-Off	KN278SP	KN278WP	KN278BP	KN178SP	KN178WP	KN178BP	KN778SP	KN778WP	KN778BP	KN278	KN378	KN878

[142] ■ = Legend plate has red background with black letters.  
[143] When ordering, add prefix 9001 to the catalog number.  
[144] ▲ = Legend plate has red background with silver letters.

**Table 19.284: Legend Plates—Special Marking**

Legend Plate	Description	Type [145]	
KN100( )P (Plastic) [146] 2.25 in. Square	Standard Markings	See Legend Plates, page 19-94	
	Special Marking [147]	Silver Field, Black Letters	KN199SP
		White Field, Black Letters	KN199WP
		Red Field, Black Letters	KN199RP
		Black Field, White Letters	KN199BP
KN200 Aluminum	Standard Markings	See Legend Plates, page 19-94	
	Special Marking [147]	Black Field	KN299
		Red Field	KN299R
KN200( )P (Plastic) [146] 1.7 in. Square	Standard Markings	See Legend Plates, page 19-94	
	Special Marking [147]	Silver Field, Black Letters	KN299SP
		White Field, Black Letters	KN299WP
		Red Field, Black Letters	KN299RP
		Black Field, White Letters	KN299BP
KN300 Aluminum	Standard Markings	See Legend Plates, page 19-94	
	Special Marking [147]	Black Field	KN399
		Red Field	KN399R
KN400 Aluminum	Blank	KN400	
	Any Marking [147]	KN499	
KN500 Aluminum	Standard Markings	Select from Table 19.289 Special Legend Plates, page 19-96	
	Special Marking [147]	Black Field	KN599
		Green Red Field	KN519
KN600 Aluminum	Blank	KN600	
	Any Marking [147]	Red Field	KN600R
		Black Field	KN699
		Red Field	KN699R
		Standard Markings	Select from Legend Plates, page 19-94
KN700( )P (Plastic) [146] 2.5 in. Square	Special Marking [147]	Silver Field, Black Letters	KN799SP
		White Field, Black Letters	KN799WP
		Red Field, Black Letters	KN799RP
		Black Field, White Letters	KN799BP
	Standard Markings	Select from Legend Plates, page 19-94	
KN800 Aluminum	Special Marking [147]	Blue Field	KN899
		Red Field	KN899R
	Blank	KN900	
KN900 Aluminum	Any Marking [147]	KN999	

**Table 19.285: Maximum Number of Lines and Characters for Type KN Legend Plates**

Type	KN100	KN200	KN300	KN400	KN500	KN600	KN700	KN800	KN900
Max. No. of Characters per Line	16	14	18	18	8 per field	22	17	18	18 per pos.
Max. No. of Lines	2	1	3	2	2 per field	4	2	2	1 per pos.

**NOTE:** The maximum number of characters and lines is a practical maximum, based on a minimum size of characters to facilitate easy reading.

**Table 19.286: Circular Legends for Emergency Stop Mushroom Heads (yellow background)**

Diameter	Text	Catalog Number [145]
60 mm	—	9001KN9100
	EMERGENCY STOP	9001KN9330
90 mm	—	9001KN8100
	EMERGENCY STOP	9001KN8330

**Table 19.287: Plastic Legend Plates—Other Colors**

	Plate Color	Letter Color	1.7 in. Square [145]	2.25 in. Square [145]	2.5 in. Square [145]
Blank Legend Plates	Yellow	Black	KN200YP	KN100YP	KN700YP
	Green	White	KN200GP	KN100GP	KN700GP
	Blue		KN200LP	KN100LP	KN700LP
	Red		KN200CP	KN100CP	KN700CP
Special Engraved Legend Plates	Yellow	Black	KN299YP	KN199YP	KN799YP
	Green	White	KN299GP	KN199GP	KN799GP
	Blue		KN299LP	KN199LP	KN799LP
	Red		KN299CP	KN199CP	KN799CP

[145] When ordering, add prefix 9001 to the catalog number.

[146] Other colors available (see Table 19.287 Plastic Legend Plates—Other Colors, page 19-95).

[147] Specify marking required.

Table 19.288: Min. Centerline Spacing, Type K & SK Control Units

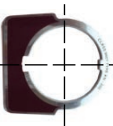
Legend Plate		Operator	Centerline Spacing (in.)					
			A	B	C	D	E	F
<b>Legend Plate Orientation Position #1</b>								
	KN2 KN5	Standard Push Button	1.75	1.31	1.44	2.25	1.69	0.88
		1.375 in. Dia. Mushroom	1.75	1.31	1.44	2.25	1.69	0.88
		2.25 in. Dia. Mushroom	2.25	1.31	1.44	2.25	2.25	1.12
		Selector Switch Knobs	1.75	1.31	1.44	2.25	1.69	0.88
	KN3	Standard Push Button	2.00	1.31	1.44	2.25	1.75	0.88
		1.375 in. Dia. Mushroom	2.00	1.31	1.44	2.25	1.75	0.88
		2.25 in. Dia. Mushroom	2.25	1.31	1.44	2.25	2.25	1.12
		Selector Switch Knobs	2.00	1.31	1.44	2.25	1.75	0.88
	KN4	Standard Push Button	1.94	1.31	1.44	2.25	1.62	0.88
		1.375 in. Dia. Mushroom	1.94	1.31	1.44	2.25	1.62	0.88
		2.25 in. Dia. Mushroom	2.25	1.31	1.44	2.25	2.25	1.12
		Selector Switch Knobs	1.74	1.31	1.44	2.25	1.62	0.88
	KN6	Standard Push Button	2.38	1.62	1.44	2.25	2.25	1.12
		1.375 in. Dia. Mushroom	2.38	1.62	1.44	2.25	2.25	1.12
		2.25 in. Dia. Mushroom	2.38	1.62	1.44	2.25	2.25	1.12
		Selector Switch Knobs	2.38	1.62	1.44	2.25	2.25	1.12
<b>Legend Plate Orientation Position #2</b>								
	KN2 KN5	Standard Push Button	1.62	1.31	1.44	2.25	1.75	0.88
		1.375 in. Dia. Mushroom	1.62	1.31	1.44	2.25	1.75	0.88
		2.25 in. Dia. Mushroom	2.25	1.31	1.44	2.25	2.25	1.12
		Selector Switch Knobs	1.62	1.31	1.44	2.25	1.75	0.88
	KN3	Standard Push Button	1.75	1.31	1.44	2.25	2.00	0.88
		1.375 in. Dia. Mushroom	1.75	1.31	1.44	2.25	2.00	0.88
		2.25 in. Dia. Mushroom	2.25	1.31	1.44	2.25	2.25	1.12
		Selector Switch Knobs	1.75	1.31	1.44	2.25	2.00	0.88
	KN4	Standard Push Button	1.62	1.31	1.44	2.25	1.94	1.00
		1.375 in. Dia. Mushroom	1.62	1.31	1.44	2.25	1.94	1.00
		2.25 in. Dia. Mushroom	2.25	1.31	1.44	2.25	2.25	1.12
		Selector Switch Knobs	1.62	1.31	1.44	2.25	1.94	1.00
	KN6	Standard Push Button	2.25	1.31	1.62	2.38	2.38	0.88
		1.375 in. Dia. Mushroom	2.25	1.31	1.62	2.38	2.38	0.88
		2.25 in. Dia. Mushroom	2.25	1.31	1.62	2.38	2.38	1.12
		Selector Switch Knobs	2.25	1.31	1.62	2.38	2.38	0.88



Special Legend Plates

Table 19.289: Special Legend Plates

Type	Type KN500 (For Use with Dual Function Operators: KR6, KR7 and KR67)	
	Standard Markings	
	Green	Red
KN500	Blank	Blank
KN501	Start	Stop
KN502	On	Off
Type	Black	Black
KN520	Blank	Blank
KN521	Start	Stop
KN522	On	Off
KN523	Forward	Reverse
KN524	Up	Down
KN525	High	Low
KN526	Open	Close



**Padlock Attachments for Type K and SK Operators**

**Table 19.290: Padlock Attachments**



Used On	Description	Type [148]
<b>Type K</b> non-illuminated push button — Standard or mushroom (KR4, KR5 mushroom buttons only).	Holds button in depressed position and can be padlocked.	K4
<b>Types K and SK</b> non-illuminated push buttons with or without protective boots.	Holds button in depressed position when padlocked.	K5 K97
<b>Types K and SK</b> non-illuminated push buttons, cover type attachment. KR, SKR	Attachment can be padlocked. Does not hold button in depressed position.	K6
<b>Types K and SK</b> push buttons, cover type attachment.	Spring loaded cover cannot be padlocked. Does not hold button in depressed position.	K60
<b>Types K and SK</b> push-pull operator and illuminated push buttons. KR8, KR9	Holds button in depressed position and can be padlocked.	K62
<b>KR11U and KR12U</b> Interlocked Assembly	Holds maintained button in depressed position and can be padlocked.	K96
<b>Type KR9 &amp; SKR9</b> Push-Pull operators—Non-Illuminated and Illuminated	Holds button in depressed position. Can be padlocked.	K162

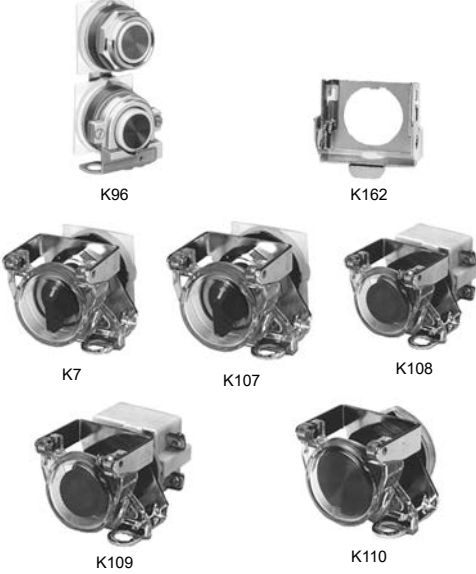

**Table 19.291: Padlock Attachments**

Used On	Description	Type [148]
<b>Types K and SK</b> selector switches and potentiometers (will not work with gloved-hand knob).	Cover type attachment that can be padlocked to keep unauthorized personnel from tampering with the operator.	K7
<b>Types K and SK</b> selector switches and potentiometers (will not work with gloved-hand knob).	Same as 9001K7 but with spring loaded lockout cover.	K107
<b>Types K and SK</b> illuminated push buttons (with or without guard) and key operated push buttons.	Cover type attachment that can be padlocked to keep unauthorized personnel from tampering with the operator.	K108
<b>Types K and SK</b> illuminated push buttons (with or without guard) and key operated push buttons.	Same as 9001K108 but with spring loaded lockout cover.	K109
<b>Types K and SK</b> maintained push-pull operators using 1.375 in. dia. mushroom buttons (-20 series, see <a href="#">Additional Accessories for Type K and SK Operators, page 19-99</a> ).	Cover type attachment that holds mushroom button in depressed position and can be padlocked.	K110

**Mushroom Button Guards for Type K and SK Operators**

**Table 19.292: Mushroom Button Guards**



Description	Used On	Type [149] [150] [151]
Aluminum Mushroom Guard for 1.375 in. Mushroom Button Operator (KR4, KR24)	KR4, KR24	K48
Yellow Plastic Extended Mushroom Guard for 1.375 in. and 1.625 in. Mushroom Button Operators	KR4, SKR4	K56■ K56+M▲
Aluminum Mushroom Guard for 2.25 in. Mushroom Button Operator	KR8, KR9, KR16, SKR8, SKR9, SKR16	K68
	KR5 KR25	K68 K685

[148] When ordering, add prefix 9001 to the catalog number.

[149] ■ B=Black G=Green R=Red Y=Yellow

[150] ◆ R=Red Y=Yellow

[151] ▲ The mushroom guard has finger holes for push-pull and turn-to-release KR16 and SKR16 operators.

Protective Boots for Type K and SK Operators

Table 19.293: Protective Boots



For Non-Illuminated Push Buttons [152]		Clear Color for	Type [153]
Color	Type [153]		
Black	KU1	Standard knob selector switch	KU17
Red	KU2		
Blue	KU3		
Brown	KU4	Gloved-hand cap for use on standard knob selector switch	KU18
Green	KU5		
Yellow	KU6	Standard pilot light and maintained contact push buttons	KU27
Clear	KU7		
Clear	KU8		
(Provides Full Guard)		Illuminated push button with guard	KU47

NOTE: These Type KU protective boots are recommended for very dirty environments or severe hose down, but they are not required for UL Type 4 rating on the Type K operators or UL Type 4 or 4X rating on the Type SK operators. The K1 wrench (see Wrenches for Type K and SK Operators, page 19-101) is required for installation of these boots.

Closing Plates for Type K and SK Operators

Table 19.294: Closing Plates

	Description	Type
 Round (1-1/2 in. Dia.)	Gray	K51 [154]
	Black	K52 [154]

For Dimensions, see catalog 9001CT0001

[152] Use KU27 for maintained contact push buttons.  
 [153] When ordering, add prefix 9001 to the catalog number.  
 [154] Meets UL and NEMA 1, 2, 3, 4, 4X, 6, 12 and 13.

**Additional Accessories for Type K and SK Operators**

**Table 19.295: Accessories**

Description	Color	Type [155]	Package Qty.
	Black Blue Gray Green Orange Red	T8BK T8BE T8GY T8GN T8OE T8RD	10
	Universal [156]	T8U	7
	White Yellow	T8WH T8YW	10
1.375 in. Snap-in Mushroom knob for KR4 and SKR4 [157]	Black Blue Green Orange Red	K16B K16L K16G K16S K16R	1
	Red [158]	K16R05	
	Yellow	K16Y	
2-1/4 in. Snap-in Mushroom knob for KR5 and SKR5 [159]	Black Blue Green Orange Red	K17B K17L K17G K17S K17R	1
	Red [158]	K17R05	
	Yellow	K17Y	
1-3/8 in. Screw-on Mushroom knob for KR24 and SKR24 [160]	Black Blue Green Orange Red Yellow	K92B K92L K92G K92S K92R K92Y	1
2-1/4 in. Screw-on Mushroom knob for KR25 and SKR25 [161]	Black Blue Green Orange Red Yellow	K93B K93L K93G K93S K93R K93Y	1
Push-Pull Knobs for KR8, KR9, SKR8, SKR9 Operators	Amber Black [162] Blue Clear Green Orange [162] Red Red [163]	A22 B23 L22 C22 G22 S23 R22	1
	White Yellow	W22 Y22	
	Black Green Red	B19 G19 R19	10
Color Inserts for Dual Function Operators KR6, KR7, KR67	Universal [164]	U19	10
Standard Color	Amber Blue Clear Green Red White Yellow	A7 L7 C7 G7 R7 W7 Y7	1
Caps for Illuminated Push Buttons K1L, K2L, K3L, SK1L, SK2L	Red	R94	1
Knob for KR9R94	Red	R94	1
Metal Knob for KR24	Red Green Black	K92RM K92GM K92BM	1
Metal Knob for KR25	Red Green Black	K93RM K93GM K93BM	1
Metal Knob for KR9 (40 mm)	Red Green Black	K94RM K94GM K94BM	1
Metal Knob for KR9 (60 mm)	Red Green Black	K95RM K95GM K95BM	1

**Table 19.296: Accessories (Continued)**

Description	Color	Type [155]	Package Qty.
1-3/8 in. Mushroom Knob for Illuminated Push Buttons K2L, SK2L [165]	Amber Blue Clear Green Red White Yellow	A20 L20 C20 G20 R20 W20 Y2	1
2-1/4 in. Mushroom Knob for Illuminated Push Buttons K2L, SK2L [165]	Amber Blue Clear Green Red White Yellow	A21 L21 C21 G21 R21 W21 Y21	1
Plastic Fresnel Pilot Light Lens for KP, KT, SKP, SKT	Amber Blue Clear Green Red White Yellow	A31 L31 C31 G31 R31 W31 Y31	1
Domed Plastic Pilot Light Lens for KP, KT, SKP, SKT	Amber Blue Clear Green Red White Yellow	A9 L9 C9 G9 R9 W9 Y9	1
Glass Pilot Light Lens for KP, KT	Amber Blue Clear Green Red White Yellow	A6 L6 C6 G6 R6 W6 Y6	1
Standard Selector Switch Knob for K and SK Selector Switches	Amber Black [162] Blue Clear Green Orange [162] Red White Yellow	A8 B11 L8 C8 G8 S11 R8 W8 Y8	1
Gloved-Hand Selector Switch Knob for K and SK Selector Switches	Amber Black [162] Blue Clear Green Orange [162] Red White Yellow	A24 B25 L24 C24 G24 S25 R24 W24 Y24	1
Color Inserts for KQ and TQ Selector Push Buttons	Black Blue Green Orange Red White Yellow	T5BK T5BE T5GN T5OE T5RD T5WH T5YW	10
Selector Switch Cams		B C D E F G H J L M	K13B K13C K13D K13E K13F K13G K13H K13J K13L K13M

[155] When ordering, add prefix 9001 to the catalog number.

[156] Includes one each of the following color inserts: Black, Red, Green, Yellow, Orange, Blue, and White.

[157] The mushroom button cap listed here may be assembled to a 9001KR1U or SKR1U to form a 9001KR4 or SKR4.

[158] "EMERGENCY STOP" is in raised letters and hot stamped white across the front of the mushroom button.

[159] The mushroom button cap listed here may be assembled to a 9001KR1U or SKR1U to form a 9001KR5 or SKR5.

[160] The mushroom button cap listed here may be assembled to a 9001KR20 to form a 9001KR24 or SKR20 to form a 9001SKR24.

[161] The mushroom button cap listed here may be assembled to a 9001KR20 to form a 9001KR25 or a SKR20 to form a 9001SKR25.

[162] These color caps are opaque and are for use on non-illuminated operators only.

[163] Red knob with "Push Emergency Stop" marked on top of knob.

[164] Includes two of each of the following color inserts: Black, Red, and Green.

[165] May be used on KR8 and KR9 operators. Order mushroom button and K54 adapter. Using the K54 adapter voids Type 6 rating.

Ring Nuts for Type K and SK Operators

Table 19.297: Ring Nuts

Used On	Type [166]	Used On	Type [166]
K1L	K44	SK1L	SK44
K30-K37	K45	—	—
K70-K73	K45	—	—
K20, K21, K22, K23	K45	SK20, SK21, SK22, SK23	SK45
K20, K21, K22, K23 [167]	SK46	SK20, SK21, SK22, SK23 [167]	SK46
K2L	K49	SK2L	SK49
K3L (complete)	K111	—	—
K3L (metal top only)	6515802701	—	—
KP, KTR	K41	SKP, SKTR	SK41
KR1	K41	SKR1	SK41
KR11	K42	SKR11	SK42
KR12 [168]	K42	SKR12 [168]	SK42
KR12 [169]	K41	SKR12 [169]	SK41
KR13, 14, 15	K55	—	—
KR2	K42	SKR2	SK42
KR20	K49	—	—
KR24	K49	—	—
KR25	K49	SKR25	SK49
KR3	K40	SKR3	SK40
KR4	K41	SKR4	SK41
KR5	K41	SKR5	SK41
KR6	K47	—	—
KR67	K47	—	—
KR7	K47	—	—
KR8	K58	SKR8	6509704401
KR9	K41	SKR9	SK41
KS	K45	SKS	SK45
KS [167]	SK46	SKS [167] SKRU11 SKRU1,2,3,4,5,10	SK46 SK41 SK40
KT	K49	SKT	SK49

Replacement and Repair Parts for Type K and SK Operators

Table 19.298: Replacement Lamps For Series A–F (black) Light Modules

Light Module Type	Lamp Number (ANSI)	Square D Replacement Lamps
		Part Number
KM1	GE44[170]	—
KM2	GE1490	2550101003
KM3	GE44[170]	—
KM4	GE1490	2550101003
KM5	GE44[170]	—
KM6	GE44[170]	—
KM7	GE44[170]	—
KM8	GE44[170]	—
KM9	GE755	2550101020
KM11	CMDK1A5	2550105014
KM12	CMDK1A5	2550105014
KM13	CMDK1A5	2550105014
KM14	CMDK1A5	2550105014
KM15	CMDK1A5	2550105014
KM21	SYL12PSB	2550105003
KM22	SYL12PSB	2550105003
KM23	SYL28PSB	2550105008
KM25	SYL120PSB	2550105005
KM31	SYL6PSB	2550105007
KM32	SYL12PSB	2550105003
KM34	SYL24PSB	2550105004
KM35	SYL28PSB	2550105008
KM36	SYL48PSB	2550105009
KM37	SYL60PSB	2550105010
KM38	SYL120PSB	2550105005

Table 19.299: Repair Parts

Description	Part Number
E10 Key	2941101100
Gray cap for KR11, KR12, SKR11, or SKR12	3105217001
Clear plastic top (only) for 9001K44 & SK44 Ring Nut)	4487D63XI
Gasket for Type K and SK Push-Pull Knob	6509701801
Gasket for Plastic Illuminated Lens	6509701901
Gasket for Type K and SK selector switch knob	3105406401
Black Compensating Gasket (Type K and SK Operators)	6509702001
Liner for Non-Illuminated Operators	6509704901
Locking Thrust Washer	6512231201
Nylon Spacer	6509705001
Locking Thrust Washer (Std. Type SK Operator)	6512240601
Push-Pull Mushroom Adapter [171]	K54
Rubber Boot for Joystick	6512243201
Knob on Joysticks without latch	4458D20X3
Knob for SK Potentiometer	3105404408
Fingersafe™ Cover for 9001KM	6508804101

Table 19.300: KU Replacement Ring Nuts (Threaded Inside and Out)

Used On	Part Number
KU1 through KU8, KU27, KU37, KU47	3105204101
KU17, KU18	3105205901

[166] When ordering, add prefix 9001 to the catalog number.

[167] Secondary ring nut (holds knob on selector switch or potentiometer).

[168] Maintained button of two button operator.

[169] Momentary button of two button operator.

[170] GE44 and GE755 are interchangeable (GE755 gives longer life). If a GE44 lamp is ordered, a GE755 (2550101020) will be substituted. For a replacement lamp in a current series light module, see *Standard and Shallow Depth Light Modules*, page 19-91.

[171] Allows Type -20 and -21 mushroom color caps to be used on push-pull operators. Use of 9001K54 voids Type 6 rating.



K3

### Interlock for Type K and SK Operators

For mechanically interlocking two push buttons so that only one button can be depressed at a time. A Type K3 attachment is furnished with the 9001 KR11, KR12, SKR11, SKR12, SKRU1 and SKRU11 operators. However, these are maintained operators and the K3 interlock serves to release one of the buttons when the other is depressed. When used with momentary contact buttons, the K3 interlock **does not** hold the buttons in the depressed position. It simply prevents pushing both buttons at the same time.

Table 19.301: Interlock

Description	Type
The Type K3 interlock is mounted behind the operators. Operators not included.	K3

NOTE: When ordering, add prefix 9001 to the catalog number.



K69

### Screwdriver for Type K and SK Operators

Table 19.302: Screwdriver

Description	Type
Used to tighten mounting screws on contact blocks and light modules.	K69

NOTE: When ordering, add prefix 9001 to the catalog number.



K95



K1

### Wrenches for Type K and SK Operators

Table 19.303: Wrenches

Where Used	Type
For tightening ring nuts on 22 and 30 mm control units	K95
For tightening threaded protective caps	K1

NOTE: When ordering, add prefix 9001 to the catalog number.

**KX Square Push Buttons with Contacts**

**Table 19.304: Push Buttons—Single, with Contacts**



Description	Button Color	Legend Marking	Contacts	Voltage	Type [1]
Non-Illuminated	Green	Start	1 N.O.	—	KXRA133
	Red	Stop	1 N.C.	—	KXRA134
	Amber	blank	2 N.O., 2 N.C.	—	KXRAAH2
	Green	blank	2 N.O., 2 N.C.	—	KXRAGH2
	Blue	blank	2 N.O., 2 N.C.	—	KXRALH2
Illuminated	Amber	blank	1 N.O., 1 N.C.	24	KXRB34AH1
	Green	blank	1 N.O., 1 N.C.	24	KXRB34GH1
	Red	blank	1 N.O., 1 N.C.	24	KXRB34RH1
	Amber	blank	1 N.O., 1 N.C.	110/120	KXRB1AH1
	Green	blank	1 N.O., 1 N.C.	110/120	KXRB1GH1
	Red	blank	1 N.O., 1 N.C.	110/120	KXRB1RH1

**Table 19.305: Push Buttons—Dual, with Contacts**

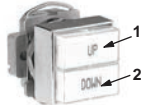

Description	Top Button (#1)	Lower Button (#2)	Contacts	Type [1]
Momentary	Start (Green)	Stop (Red)	2 N.O., 2 N.C.	KXRC111
Momentary	Start (Green)	Stop (Red)	1 N/O, 1 N/C	KXRC136
Momentary	Up (Green)	Down (Green)	2 N.O.	KXRD140
Momentary	blank (Blue)	blank (Blue)	2 N.O.	KXRDLH7
Maintained [2]	Start (Green)	Stop (Red)	1 N.O., 1 N.C.	KXRE115
Maintained [2]	On (Blue) [3]	Off (Blue) [3]	3 N.O., 3 N.C.	KXRELLH3
Maintained [2]	On (Blue) [3]	Off (Blue) [3]	3 N.O., 3 N.C.	KXRELLH3
Maintained [2]	On (Blue) [3]	Off (Blue) [3]	2 N.O., 2 N.C.	KXRELLH2

**Table 19.306: Push Buttons—Dual with One Pilot Light and Contacts**

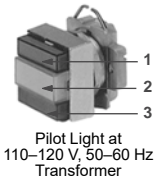

Description	Top Button (#1)	Middle Lens (#2)	Lower Button (#3)	Contacts	Voltage	Type [1]
Momentary	Start (Green)	On (Red)	Stop (Red)	2 N.O., 2 N.C.	110/120	KXRG117
Momentary	Start (Green)	On (Red)	Stop (Red)	1 N.O., 1 N.C.	110/120	KXRG137
Maintained [2]	Start (Green)	On (Red)	Stop (Red)	1 N.O., 1 N.C.	110/120	KXRJ119

**Table 19.307: Push Buttons—Dual with Two Pilot Lights and Contacts**

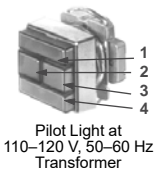

Description	Top Button (#1)	Left Lens (#2)	Right Lens (#3)	Lower Button (#4)	Contacts	Voltage	Type [1]
Momentary	Start (Green)	On (Red)	Off (Green)	Stop (Red)	2 N.C., 2 N.C.	110/120	KXRL121
Momentary	Start (Green)	On (Red)	Off (Green)	Stop (Red)	1 N.O., 1 N.C.	110/120	KXRL138
Momentary	Start (Green)	On (Red)	Off (Green)	Stop (Red)	2 N.C., 2 N.C.	24	KXRL34GRGRH2
Momentary	Start (Green)	On (Red)	Off (Green)	Stop (Red)	1 N.O., 1 N.C.	24	KXRL34GRGRH37

**KX Square Selector Switches with Contacts**

**Table 19.308: Selector Switches—with Contacts**



Description	Legend	Knob	Contacts			Type [1]
			1	0	1	
2-position, maintained	Off-On	Black	1	0		KXSA125
			0	1		
2-position, maintained	Off-On	Black	1	0		KXSA139
			1	0	0	
3-position, maintained	Hand-Off-Auto	Black	1	0	0	KXSD126
			0	0	1	

**KX Square Potentiometers**

**Table 19.309: Potentiometers**



Description	Power	Resistance	Type [1]
Single	2 W	3.2 kW	KXBB06
Single	2 W	5 kW	KXBB07
Single	2 W	10 kW	KXBB08
Tandem	2 W	5 kW / 5 kW	KXBD83

[1] When ordering, add prefix 9001 to the catalog number.

[2] Maintained operators are mechanically interlocked

[3] Text is vertical

**KX Square Pilot Lights**

**Table 19.310: Pilot Lights<sup>[4]</sup>**

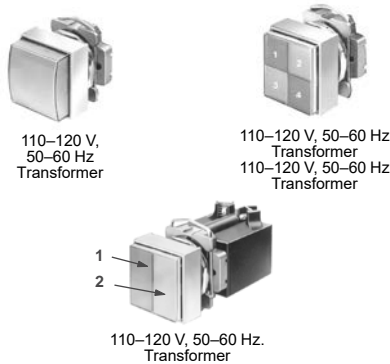

Description	Voltage	Lens 1	Lens 2	Lens 3	Lens 4	Type <sup>[5]</sup>
Single	24	Amber				KXPA35A
Single	24	Red				KXPA35R
Single	24	Green				KXPA35G
Single	24	White				KXPA35W
Single	110/120	Amber				KXPA1A
Single	110/120	Red				KXPA1R
Single	110/120	Green				KXPA1G
Single	110/120	White				KXPA1W
Dual	24	Amber	Amber			KXPB34AA
Dual	24	Red	Red			KXPB34RR
Dual	24	Green	Green			KXPB34GG
Dual	24	White	White			KXPB34WW
Dual	24	Red	Green			KXPB34RG
Dual	110/120	Amber	Amber			KXPB1AA
Dual	110/120	Red	Red			KXPB1RR
Dual	110/120	Green	Green			KXPB1GG
Dual	110/120	White	White			KXPB1WW
Dual	110/120	Red	Green			KXPB1RG
Quad	24	White	Amber	Green	Red	KXPC34WAGR
Quad	110/120	White	Amber	Green	Red	KXPC1WAGR
Quad	110/120	White	Blue	Green	Red	KXPC1WLGR

**KX Square Push Buttons without Contacts**

**Table 19.311: Push Buttons—without Contacts <sup>[6]</sup>**

Push Button	Action	Lens Color (1)	Lens Color (2)	Type <sup>[5]</sup>	
<b>Single Push Button</b>					
	Non-Illuminated	Momentary	Amber	—	KXRAA
			Green	—	KXRAG
			Blue	—	KXRAL
			Red	—	KXRAR
			White	—	KXRAW
	Illuminated 24 V	Momentary	Amber	—	KXRB35A
			Green	—	KXRB35G
			Blue	—	KXRB35L
			Red	—	KXRB35R
			White	—	KXRB35W
	Illuminated 110/120 V	Momentary	Amber	—	KXRB38A
			Green	—	KXRB38G
Blue			—	KXRB38L	
Red			—	KXRB38R	
White			—	KXRB38W	
<b>Dual Push Button</b>					
	Non-Illuminated	Momentary + Interlock	Green	Red	KXRCGR
			White	White	KXRCWW
	Non-Illuminated	Maintained + Interlock	Green	Green	KXRCGG
			Green	Red	KXREGR
			White	White	KXREWW
			Green	Green	KXREGG

**Table 19.312: Dual Push Button with Pilot Light—without Contacts <sup>[6]</sup>**

Action	Voltage	Lens Color (1)	Lens Color (2)	Lens Color (3)	Lens Color (4)	Type <sup>[5]</sup>		
<b>With One Pilot Light</b>								
	Momentary	24 Vac/dc	Red	White	Green	—	KXRG35RWG	
		24 Vac/dc	Green	White	Green	—	KXRG35GWG	
		110/120 Vac/dc	Red	White	Green	—	KXRG38RWG	
		110/120 Vac/dc	Green	White	Green	—	KXRG38GWG	
		24 Vac/dc	Red	White	Green	—	KXRH35RWG	
		24 Vac/dc	Green	White	Green	—	KXRH354GWG	
	Momentary + Interlock	110/120 Vac/dc	Red	White	Green	—	KXRH38RWG	
		110/120 Vac/dc	Green	White	Green	—	KXRH38GWG	
		Maintained + Interlock	24 Vac/dc	Red	White	Green	—	KXRJ35RWG
			24 Vac/dc	Green	White	Green	—	KXRJ35GWG
			110/120 Vac/dc	Red	White	Green	—	KXRJ38RWG
			110/120 Vac/dc	Green	White	Green	—	KXRJ38GWG
<b>With Two Pilot Lights</b>								
	Momentary	24 Vac/dc	Red	White	White	Green	KXRL35RWWG	
		24 Vac/dc	Red	Red	Green	Green	KXRL35GGRR	
		110/120 Vac/dc	Red	White	White	Green	KXRL38RWWG	
		110/120 Vac/dc	Red	Red	Green	Green	KXRL38GGRR	
		24 Vac/dc	Red	White	White	Green	KXRM35RWWG	
		24 Vac/dc	Red	Red	Green	Green	KXRM35RRGG	
	Momentary + Interlock	110/120 Vac/dc	Red	White	White	Green	KXRM38RWWG	
		110/120 Vac/dc	Red	Red	Green	Green	KXRM38RRGG	

Also see *KX Accessories*, page 19-105.

[4] Lenses are blank (no markings)  
 [5] When ordering, add prefix 9001 to the catalog number.  
 [6] Order contact blocks separately (See *Table 19.314 Contact Blocks*, page 19-104.)

**KX Square Selectors without Contacts**







**Table 19.313: Selectors—without Contacts [7]**



Description	Voltage	Knob Color	Type [8]	
2-Position, Maintained	Non-Illuminated	Black	KXSAEB	
	Illuminated	24 Vac/dc	Red	KXSJE35R
	Illuminated	24 Vac/dc	Green	KXSJE35G
	Illuminated	24 Vac/dc	White	KXSJE35W
	Illuminated	120 Vac/dc	Red	KXSJE38R
	Illuminated	120 Vac/dc	Green	KXSJE38G
	Illuminated	120 Vac/dc	White	KXSJE38W
	Key (Withdraw L)	—	N/A	KXSRE1
	Key (Withdraw R)	—	N/A	KXSRE2
	Key (Withdraw Both)	—	N/A	KXSRE3
3-Position, Maintained	Non-Illuminated	Black	KXSDB	
	Key (Withdraw C)	—	N/A	KXSVC5
	Key (Withdraw All)	—	N/A	KXSVC10
4-Position, Maintained	Non-Illuminated	Black	KXSHHB	

**Contact Blocks**

**Table 19.314: Contact Blocks—Purchase Separately**

Description	Type [8]
 (Clear Cover)	1 N.O., 1 N.C. KA1
 (Green Cover)	1 N.O. KA2
 (Red Cover)	1 N.C. KA3
 (Clear Cover)	1 N.C., 1 N.O. (Early Make) KA4
 (Red Cover)	1 N.C. (Late Break) KA5
 (Green Cover)	1 N.O. (Early Make) KA6

[7] Order contacts separately (See Table 19.314 Contact Blocks, page 19-104)

[8] When ordering, add prefix 9001 to the catalog number.



Table 19.315: Legend Plates for Selector Switches

Marking	Used On [9]	
	KXSA, KXSB, KXSC, KXSD, KXSE, KXSF, KXSG, KXSH, KXSJ, KXSK, KXSL, KXSM, KXSN, KXSO, KXSP, KXSQ	KXSR, KXSS, KXST, KXSV, KXSW, KXSX, KXSY, KXSZ
Blank	KXN600	KXN700
For-Rev.	KXN639	KXN739
Hand-Auto	KXN640	KXN740
Man-Auto	KXN643	KXN743
Off-On	KXN644	KXN744
On-Off	KXN645	KXN745
Open-Close	KXN646	KXN746
Start-Stop	KXN651	KXN751
Auto-Off-Hand	KXN658	KXN758
Hand-Off-Auto	KXN660	KXN760
Man-Off-Auto	KXN662	KXN762
Special Marking	KXN699	KXN799

Type KX Legend Plates

Table 19.316: Legend Plates for Push Buttons or Pilot Lights

Marking	Used On [9]					
	A	B	C	D	E	F
	A	B	C (vertical)	D	E	F
Blank	KXN100	KXN200	KXN200	KXN300	KXN400	KXN500
Start	KXN101	KXN201	KXN201V	KXN301	KXN401	KXN501
Stop	KXN102	KXN202	KXN202V	KXN302	KXN402	KXN502
On	KXN103	KXN203	KXN203V	KXN303	KXN403	KXN503
Off	KXN104	KXN204	KXN204V	KXN304	KXN404	KXN504
Emerg. Stop	KXN105	KXN205	KXN205V	KXN305	KXN405	KXN505
Forward	KXN106	KXN206	KXN206V	KXN306	KXN406	KXN506
Reverse	KXN107	KXN207	KXN207V	KXN307	KXN407	KXN507
Close	KXN108	KXN208	KXN208V	KXN308	KXN408	KXN508
Open	KXN109	KXN209	KXN209V	KXN309	KXN409	KXN509
Down	KXN110	KXN210	KXN210V	KXN310	KXN410	KXN510
Up	KXN111	KXN211	KXN211V	KXN311	KXN411	KXN511
Jog	KXN118	KXN218	KXN218V	KXN318	KXN418	KXN518
Reset	KXN123	KXN223	KXN223V	KXN323	KXN423	KXN523
Run	KXN124	KXN224	KXN224V	KXN324	KXN424	KXN524
Cycle Start	KXN132	KXN232	KXN232V	KXN332	KXN432	KXN532
Motor Run	KXN136	KXN236	KXN236V	KXN336	KXN436	KXN536
Power On	KXN138	KXN238	KXN238V	KXN338	KXN438	KXN538
Special-Marking	KXN199	KXN299	KXN299V	KXN399	KXN499	KXN599

Table 19.317: Letter Height For Standard Legends

	in.	mm
KXN100	1/4	6
KXN200	3/16	4.75
KXN300	3/16	4.75
KXN400	3/16	4.75
KXN500	3/16	4.75
KXN600	1/8	3
KXN700	1/8	3

Table 19.318: Maximum Number of Lines and Characters For Type KXN Legend Inserts

Letter Height	Number of ...	KXN199	KXN299 Horizontal	KXN299 Vertical	KXN399	KXN499	KXN599	
								in.
1/4	6	Characters per Line	7	7	3	7	7	3
		Lines per Legend Insert	4	2	4	1	1	1
3/16	4.75	Characters per Line	9	9	4	9	9	4
		Lines per Legend Insert	5	2	6	2	1	2
1/8	3	Characters per Line	14	14	5	14	14	6
		Lines per Legend Insert	8	4	9	3	2	3

Table 19.319: Maximum Number of Lines and Characters for Type KXN699 and KXN799 Legend Plates

Position	Letter Height		Characters Per Marking Area	
	in.	mm	A and C	B
	3/16	4.75	6	6
	1/8	3	8	9
	3/16	4.75	10	5
	1/8	3	13	7

KXN100 (Pos. 1)	KXN200 (Pos. 1)	KXN400 (Pos. 1)	KXN400 (Pos. 1)	KXN400 (Pos. 1)	KXN400 (Pos. 1)	KXN400 (Pos. 1)
KXN200 (Pos. 2)	KXN200 (Pos. 2)	KXN400 (Pos. 2)	KXN400 (Pos. 2)	KXN400 (Pos. 2)	KXN400 (Pos. 2)	KXN400 (Pos. 2)
KXN200 (Pos. 3)	KXN200 (Pos. 3)	KXN400 (Pos. 3)	KXN400 (Pos. 3)	KXN400 (Pos. 3)	KXN400 (Pos. 3)	KXN400 (Pos. 3)
KXN200 (Pos. 4)	KXN200 (Pos. 4)	KXN400 (Pos. 4)	KXN400 (Pos. 4)	KXN400 (Pos. 4)	KXN400 (Pos. 4)	KXN400 (Pos. 4)

KXRA, KXRB, KXRN, KXRP, KXPA, KXPC, KXTA, KXTB  
 KXRC, KXRD, KXRE, KXRF  
 KXRG, KXRH, KXRJ, KXRK  
 KXRL, KXRM, KXTC  
 KXPB, KXTD

All Type KX push buttons and pilot lights have a blank insert as standard. These blank inserts can be custom marked using a marking pen, a mechanical lettering set, press letters, or a tape lettering machine that marks a tape which can then be transferred to the blank insert.

To have legend inserts installed into the operators, order the operator as normal and then indicate where to install the legend inserts using the numbered positions shown on the operator ordered.

**Example:** 9001KXRL1GRGRH2 with a  
 9001KXN 401 in position 1  
 9001KXN 503 in position 2  
 9001KXN 504 in position 3  
 9001KXN 402 in position 4

[9] When ordering, add prefix 9001 to the catalog number.  
 [10] These legend inserts have vertical printing.  
 [11] These legend inserts are for the pilot lights in the center of the operator.  
 [12] These legend inserts are for the push button portion of the operator.

Table 19.320: Closing Plate

Description	Type
 UL Types 4, 13/NEMA 4, 13 Square Closing Plate (Chrome Plated) Same size as KX bezel	KXAK52

Table 19.321: Boots

Description	For Use On	Type
	All KX** push buttons and pilot lights	KXAKU7
	All KX** selector switches and potentiometers	KXAKU17B

Table 19.322: Shrouds















Description	For Use On	Color	Type
	Full Shroud	Red	KXAK41R
		Black	KXAK41B
	Short Shroud	Red	KXAK40R
		Black	KXAK40B

Table 19.323: Lamp and Lens Removal Kit

Description	Type
 Used to remove lamp and lens on all illuminated operators and pilot lights.	KXALLRT

Additional Accessories for Type KX Operators

Table 19.324: Button Covers

Description	For Use On	Color	Type	Code
 Includes 2-KXN200	KXPB KXTD	Red Green Amber Blue White	KXAC28 [13] KXAC28 [13] KXAC28 [13] KXAC28 [13] KXAC28 [13]	R [14] G [14] A [14] L [14] W [14]
 Includes KXN400	KXTC (Position 1 & 4)	Red Green Amber Blue White	KXAR4 KXAG4 KXAA4 KXAL4 KXAW4	R G A L W
 Includes KXN500	KXTC (Position 2 & 3)	Red Green Amber Blue White	KXAR5 KXAG5 KXAA5 KXAL5 KXAW5	R G A L W
 Includes 1-KXN100	KXPC	Red Green Amber Blue White	KXAC48 [15] KXAC48 [15] KXAC48 [15] KXAC48 [15] KXAC48 [15]	R [16] G [16] A [16] L [16] W [16]
 Includes KXN100	KXRA KXRB	Red Green Amber Blue White	KXAR1 KXAG1 KXAA1 KXAL1 KXAW1	R G A L W
 Includes KXN100	KXRN KXRP	Red Green Amber Blue White	KXARM1 KXAGM1 KXAAM1 KXALM1 KXAWM1	R G A L W
 Includes KXN200 [17]	KXRC KXRD KXRE KXRF	Red Green Amber Blue White	KXAR2 KXAG2 KXAA2 KXAL2 KXAW2	R G A L W
 Includes KXN300	KXRG (Position 2) KXRH (Position 2) KXRJ (Position 2) KXRK (Position 2)	Red Green Amber Blue White	KXAR3 KXAG3 KXAA3 KXAL3 KXAW3	R G A L W
 Includes KXN400	KXRG (Position 1 & 3) KXRH (Position 1 & 3) KXRJ (Position 1 & 3) KXRK (Position 1 & 3) KXRL (Position 1 & 4) KXRM (Position 1 & 4)	Red Green Amber Blue White	KXAR4 KXAG4 KXAA4 KXAL4 KXAW4	R G A L W
 Includes KXN500	KXRL (Position 2 & 3) KXRM (Position 2 & 3)	Red Green Amber Blue White	KXAR5 KXAG5 KXAA5 KXAL5 KXAW5	R G A L W
 Includes KXN100	KXPA	Red Green Amber Blue White	KXAR8 KXAG8 KXAA8 KXAL8 KXAW8	R G A L W
 Includes KXN100	KXTA KXTB	Red Green Amber Blue White	KXAR1 KXAG1 KXAA1 KXAL1 KXAW1	R G A L W

[13] Each KXAC28 includes a clear cover and 1 each of all colors. If the same color is required for position #1 and #2 of the KXPB operator, order 2 of Type KXAC28.

[14] When specifying color codes—the first will be installed in #1 and the second in #2.

[15] Each KXAC48 includes a clear cover and 1 each of all colors. If the same color is required for position #1 and #2 of the KXPC operator, order 2 of Type KXAC48.

[16] When specifying color codes—the first will be installed in #1, the second in #2, the third in #3 and the fourth in #4.

[17] Two required per operator. When ordering an assembled operator—specify two code numbers. The first code will be assembled into #1 and the second code will be assembled into #2

**XAL Control Stations, Enclosures, and Accessories**

**Table 19.325: Start or Stop Function Polycarbonate; Light gray base, RAL7035; Dark gray lid, RAL7016**



XALD101H29H7

Description	Type of Push	Type of Contact		Marking	Catalog Number
		N.O.	N.C.		
<b>Marking on Legend Holder</b>					
1 momentary push button	Flush black	1	—	Start	XALD101H29H7
	Flush red	—	1	Stop	XALD111H29H7
<b>Marking on Legend Holder</b>					
1 mushroom head push button Ø 40 mm, momentary	Red	—	1	Stop on red legend	XALD164H29H7

**Table 19.326: Trigger Action Emergency Stop Polycarbonate; Light gray base, RAL7035; Yellow lid, RAL1012**



XALK174H7

Description	Type	Type of Contact		Catalog Number
		N.O.	N.C.	
1 mushroom head push button Ø 40 mm, red Turn-to-release	Trigger action [1]	—	1	XALK178H7
1 mushroom head push button Ø 40 mm, red Key release (Key No. 455)	Trigger action [1]	—	1	XALK188H7
1 mushroom head push button Ø 40 mm, red Push-pull	Trigger action [2]	—	1	XALK198H7

**Table 19.327: Start-Stop Function Polycarbonate; Light gray base, RAL7035; Dark gray lid, RAL7016**



XALD211H29H7

XALD321H29H7

Description	Type of Push	Type of Contact		Text	Catalog Number
		N.O.	N.C.		
2 momentary push buttons	1 flush black 1 flush red	1 —	— 1	Start Stop	XALD211H29H7
	1 flush black 1 flush black	1 1	— —	Forward Reverse	XALD251H29H7

**Table 19.328: Three Function Polycarbonate; Light gray base, RAL7035; Dark gray lid, RAL7016**

Description	Type of Push	Type of Contact		Text	Catalog Number
		N.O.	N.C.		
3 momentary push buttons (no markings)	1 flush black 1 flush red 1 flush black	1	—	Open	XALD351H29H7
		—	1	Stop	
		1	—	Close	
		1	—	Forward	XALD311H29H7
		—	1	Stop	
		1	—	Reverse	
1	—	Up	XALD321H29H7		
—	1	Stop			
1	—	Down			

**Table 19.329: Empty Enclosures [3]**



Description	Number of Holes	Catalog Number
<b>For normal environments, CSA approved and UL Listed (with stainless steel lid mounting screws)</b>		
Light gray base RAL7035 Dark gray lid RAL7016	1	XALD01H7
	2	XALD02H7
	3	XALD03H7
	4	XALD04H7
	5	XALD05H7
Light gray base RAL7035 Yellow lid RAL1012	1	XALK01H7

[1] Emergency Stop (EN / IEC 13850)  
 [2] Emergency Off (IEC 60364-5-53)  
 [3] For customer assembly using XB5 operators and standard screw-terminal contact blocks, see *XB5 Non-Illuminated Operators*, page 19-46. Either mounting method can be used: contact block ZENL mounting on metal plate, or contact block ZBE mounting on operator with mounting collar.

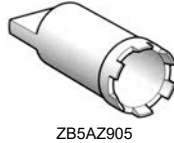

**Table 19.330: Electrical Block and Accessories (for mounting on metal plate at back of enclosure) [4]**

Description	Type	Color	Catalog Number
<b>Electrical blocks with screw clamp terminal connections</b>			
Metal-plate-mounting contact blocks	N.O. contact	—	ZENL1111
	N.C. contact	—	ZENL1121
Light blocks with <b>Protected LED</b>	24 Vac/Vdc	White	ZALVB1
		Green	ZALVB3
		Red	ZALVB4
		Yellow	ZALVB5
		Blue	ZALVB6
		120 Vac	White
	Green		ZALVG3
	Red		ZALVG4
	Yellow		ZALVG5
	Blue		ZALVG6
	230 Vac		White
		Green	ZALVM3
Red		ZALVM4	
Yellow		ZALVM5	
Blue		ZALVM6	

**Table 19.331: Accessories for electrical blocks**

Description	Application	Catalog Number
Blanking plug	Ø 22 mm units	ZB5SZ3
Nut	Head mounting	ZB5AZ901
Grounding terminal	Grounding	XALZ09
Key	For tightening nut	ZB5AZ905



**XAP Enclosures and Accessories**

**Table 19.332: Undrilled Enclosures, Glass-Reinforced Polyester**

Type		H x W Dimensions		Catalog Number
		IN	mm	
NEMA 4, 4X, 13 Usable depth 3.27 in. (83 mm)	Without hinges	3.34 x 5.75	85 x 146	XAPA1100
		3.34 x 8.90	85 x 226	XAPA2100
	With hinges	5.95 x 9.49	151 x 241	XAPA3100
		5.95 x 9.49	151 x 241	XAPA4100
Undrilled Grounding Plate	Sheet steel with ground screw	For XAPA1100		XAPZ100
		For XAPA2100		XAPZ200
		For XAPA3100 and 4100		XAPZ300



**Table 19.333: Drilled Insulated Enclosures, Glass-Reinforced Polyester [5]**

Type	Number of Knockouts 22 mm	Number of Rows		H x W Dimensions		Catalog Number
		Vertical	Horizontal	IN	mm	
NEMA 4, 4X, 13 Usable depth 3.27 in. (83 mm) 1.58 in. (40 mm) centerline spacing of holes	1	1	1	3.35 X 5.75	85 X 146	XAPA1110
	2	1	2	3.35 X 5.75	85 X 146	XAPA1120
	4	2	2	3.35 X 5.75	85 X 146	XAPA1104
	8	2	4	3.35 X 8.90	85 X 226	XAPA2108
	16	4	4	5.94 X 9.49	151 X 241	XAPA3116
Drilled Grounding Plate		Sheet steel with ground screw	For XAPA1110		XAPZ110	
			For XAPA1120		XAPZ120	
			For XAPA1104		XAPZ104	
			For XAPA2108		XAPZ208	
			For XAPA3116		XAPZ316	



**Table 19.334: Undrilled Die Cast Enclosures (Painted Gray RAL7032)**

Type	Material	Usable Depth		H x W x D Dimensions		Catalog Number
		IN	mm	IN	mm	
NEMA 4, 13	Zinc	1.93	49	3.15 x 3.15 x 2.03	80 x 80 x 51.5	XAPG19100
				5.12 x 3.15 x 2.03	130 x 80 x 51.5	XAPG29100
				6.89 x 3.15 x 2.03	175 x 80 x 51.5	XAPG39100
		2.93	74.5	3.15 x 3.15 x 3.03	80 x 80 x 77	XAPG19400
				5.12 x 3.15 x 3.03	130 x 80 x 77	XAPG29400
				6.89 x 3.15 x 3.03	175 x 80 x 77	XAPG39400
	Aluminum	2.93	2.93	8.66 x 3.15 x 3.03	220 x 80 x 77	XAPG49400
				12.20 x 3.35 x 3.03	310 x 85 x 77	XAPG59400



[4] For customer assembly using XB5 operators and standard screw-terminal contact blocks, see XB5 Non-Illuminated Operators, page 19-46. Either mounting method can be used: contact block ZENL mounting on metal plate, or contact block ZBE mounting on operator with mounting collar.  
[5] Uses standard XB5 products from XB5 Complete Devices, page 19-43 through XB5 Accessories, page 19-60. Do not use ZENL style contact blocks.

**Table 19.335: Drilled Die Cast Enclosures (Painted Gray RAL7032) [6]**

	Type	Material	Usable Depth		Number of 22 mm holes	H x W x D Dimensions		Catalog Number
			IN	mm		IN	mm	
 XAPG29703	NEMA 4, 13 1.18 in. (30 mm) centerline spacing of holes for horizontal mount	Zinc	1.93	49	2	3.15 x 3.15 x 2.03	80 x 80 x 51.5	XAPG19702
					3	5.12 x 3.15 x 2.03	130 x 80 x 51.5	XAPG29703
					4	6.90 x 3.15 x 2.03	175 x 80 x 51.5	XAPG39704
			2.93	74.5	2	3.15 x 3.15 x 3.03	80 x 80 x 77	XAPG19802
					3	5.12 x 3.15 x 3.03	130 x 80 x 77	XAPG29803
					4	6.90 x 3.15 x 3.03	175 x 80 x 77	XAPG39804
	NEMA 4, 13 1.58 in. (40 mm) centerline spacing of holes for vertical mount	Zinc	1.93	1.93	1	3.15 x 3.15 x 2.03	80 x 80 x 51.5	XAPG19201
					2	5.12 x 3.15 x 2.03	130 x 80 x 51.5	XAPG29202
					3	6.90 x 3.15 x 2.03	175 x 80 x 51.5	XAPG39203
					1	3.15 x 3.15 x 3.03	80 x 80 x 77	XAPG19501
			2.93	74.5	2	5.12 x 3.15 x 3.03	130 x 80 x 77	XAPG29502
					3	6.90 x 3.15 x 3.03	175 x 80 x 77	XAPG39503
					4	8.66 x 3.15 x 3.03	220 x 80 x 77	XAPG49504
					Aluminum	2.93	74.5	5

**Table 19.336: Drilled Flush Plates [7]**



XAPE302



XAPE303

Type	Material	Number of 22 mm holes	H x W x D Dimensions		Catalog Number
			IN	mm	
NEMA 4, 13 1.18 in. (30 mm) centerline spacing of holes	Anodized Aluminum	1	2.83 x 2.83	72 x 72	XAPE301
		2	4.13 x 2.83	105 x 72	XAPE302
		3	5.43 x 2.83	138 x 72	XAPE303
		4	6.73 x 2.83	171 x 72	XAPE304
		5	8.03 x 2.83	204 x 72	XAPE305

**Table 19.337: Optional Back Box (for finger protection, if required)**

Type	Material	For Use With	Catalog Number
Protective rear covers	Insulating Fiberglass	Flush plate XAPE301	XAPE901
		Flush plate XAPE302	XAPE902
		Flush plate XAPE303	XAPE903
		Flush plate XAPE304	XAPE904
		Flush plate XAPE305	XAPE905

[6] Can use either XB4 or XB5 products.  
[7] Can use either XB4 or XB5 products.

9001B Standard Duty Control Stations

Table 19.338: Control Stations

No. of Buttons	Nameplate Markings and Features	Contact Symbol [8]	Surface Mounting NEMA1	Stainless Steel Flush Plate [9]	Watertight and Dusttight NEMA4	For Hazardous Locations NEMA 7 & 9 [10]
			Type [11]	Type [11]	Type [11]	Type [11]
1	Start	1	BG101	BF101	BW146	BR101
	Stop	3	BG102	BF102	BW147	—
	Stop (Mushroom Button)	3	BG103	—	BW151	BR103
	Stop (Lockout)	3	BG104	—	BW148	BR104
	Universal (w/o legend insert)	16	BG107	BF107	BW159	BR107
	Off-On (Selector Switch)	19	BG111	—	—	—
	Hand-Off-Auto (Selector Switch)	17	BG112	—	—	—
	Universal Selector Switch (w/o legend insert)	19 or 17	BG114	—	—	—
2	Start-Stop	145	BG201	BF201	BW240	BR204
	Start-Stop (for latching Applications)	146	BG202	—	BW252	BR202
	Start-Stop (Mushroom on Stop)	145	BG203	—	BW250	BR203
	Start-Stop (Lockout on Stop)	145	BG204	—	BW241	BR204
	Start-Stop (Mushroom on both)	145	BG205	—	BW246	BR205
	Forward-Reverse	146	BG206	—	BW242	—
	Open-Close	146	BG207	—	BW244	—
	Up-Down	146	BG208	BF208	BW243	BR208
	Raise-Lower	146	BG209	—	BW253	—
	On-Off	145	BG210	BF210	BW245	—
	On-Off	146	BG211	BF211	BW254	—
	Universal (w/o legend inserts)	25	BG214	—	BW260	BR214
	Start-Stop (Maintained Contact)	10	BG215	BF215	BW255	BR215
	On -Off (Maintained Contact)	10	BG216	BF216	BW256	BR216
	Universal (Maintained contact w/o legend inserts)	10	BG218	—	—	BR218
	3	Fast-Slow-Stop	109	BG301	—	—
Forward-Reverse-Stop		109	BG302	—	—	—
Opn-Close-Stop		109	BG303	BF303	—	—
Raise-Lower-Stop		109	BG304	—	—	—
Up-Down-Stop		109	BG305	BF305	—	—
Start-Jog-Stop		109	BG316	—	—	—
Universal (w/o legend inserts)		8	BG307	—	—	—
Start-Stop, Red Pilot Light: 120Vac/dc	145 & 121	BG308	BF308	—	—	



NEMA 1 Surface Mounting Type BG201



NEMA 1 Flush Mounting (w/o pullbox) Type BF201



NEMA 4 Type BW243



NEMA 7 and 9 Type BR103

Table 19.339: Accessories

Description	Color	Type [11]
Mushroom Caps for NEMA 1	Red	B301
Mushroom Caps for NEMA 4	Red	B303
Lockout Kit for NEMA 1	—	B321
Pilot Light Lenses, NEMA 1 Surface Mount	Red	B331
Pilot Light Lenses, NEMA 1 Surface Mount	Green	B332
Pilot Light Lenses, NEMA 1 Flush Mount	Red	B341
Pilot Light Lenses, NEMA 1 Flush Mount	Green	B342
Replacement Covers for BW240 [12]	—	BWD219
Replacement Covers for BW241 [13][12]	—	BWD220
Replacement Covers for BW242-BW260 [12]	—	BWD219

Table 19.340: Interchangeable Push Button Legend Inserts

Marking	For NEMA 1 Surface Mount [11]	For NEMA 4 or 7/9 Lever Type [11]	For NEMA 4 Round Button [11]	For NEMA4 Mushroom Button [11]
Start	B101	B161	B259	B282
Stop	B102	B162	B260	B283
Fast	B103	—	—	—
Slow	B104	—	—	—
Forward	B105	—	B255	—
Reverse	B106	—	B256	—
Open	B107	—	B263	—
Close	B108	—	B264	—
Raise	B109	—	B261	—
Lower	B110	—	B262	—
Up	B111	—	B253	B276
Down	B112	—	B254	B277
On	B115	B175	B257	—
Off	B116	B176	B258	—
Hand	B117	—	B265	—
Auto	B118	—	B266	—
Jog	B119	—	—	—
Blank (Black)	B129	B189	B251	B251
Blank (Red)	B129R	B189R	B252	B252

For Replacement Interiors, see Replacement Interiors for Type B Standard Duty Push Button Stations, page 19-111.

For Ratings, see Electrical Contact Ratings, page 19-111.

[8] See Replacement Interiors For Type B Standard Duty Push Button Stations , page 19-111.  
 [9] Uses standard 2.0 or 2.13 in. deep wall boxes, single gang for Types BF1 and BF2, two gang for Type BF3  
 [10] Also rated for Class I, Division I and II, Groups B, C, or D; Class II, Division I and II, Groups E, F, or G  
 [11] When ordering, add prefix 9001 to the catalog number.  
 [12] Replacement case/covers are not available for Type BR devices.  
 [13] Includes factory installed lockout on the cover.

**Replacement Parts for Type B Standard Duty Control Stations**

**Table 19.341: Replacement Interiors For Type B Standard Duty Push Button Stations**



For Control Station Type	Contact Symbol	Contact Block Assembly [1]	Terminal Block Wiring Receptacle
		Type	Type
BF101–BF107	16	BOC107	BFB107
BF111–BF114	19 or 17	BOC114	BFB114
BF121–BF123	121	BOC123	BFB123
BF201–BF214	25	BOC214	BFB214
BF215–BF218	10	BOC218	BFB214
BF221–BF224	7 or 19 & 121	BOC224	BFB224
BF225–BF226	17 or 19 & 16	BOC226	BFB226
BF301–BF307	8	BOC214 & BOC107	BFB214 & BFB107
BF308–BF309	25 & 121	BOC214 & BOC123	BFB214 & BFB123
BF310–BF313	10 & 121	BOC218 & BOC123	BFB214 & BFB123
BF314–BF315	17 or 19 & 25	BOC214 & BOC114	BFB214 & BFB114
BG101–BG107	16	BGC107	BGB107
BG111–BG114	17 or 19	BGC114	BGB114
BG121–BG123	121	BGC123	BGB123
BG201–BG214	25	BGC214	BGB214
BG215–BG218	10	BGC218	BGB214
BG221–BG224	17 or 19 & 121	BGC224	BGB224
BG225–BG226	17 or 19 & 16	BGC226	BGB226
BG301–BG307	8	BGC307	BGB307
BG316–BG326			
BG308–BG309	25 & 121	BGC309	BGB309
BG310–BG313	10 & 121	BGC313	BGB309
BG314–BG315	17 or 19 & 25	BGC315	BGB315
BR101–BR107	16	BOC107	BFB107
BR202–BR214	25	BOC214	BFB214
BR215–BR219	10	BOC218	BFB214
BW101–BW107	16	BOC107	BFB107
BW202–BW214	25	BOC214	BFB214
BW215–BW218	10	BOC218	BFB214
BW146–BW159	16	BOC360	
BW240–BW260	25	BOC361	
BW255–BW258	10	BOC362	

**NOTE:** Contact block assemblies for all Type BG stations include cover and contact block. Replacement contact block assemblies and terminal block wiring receptacles for push buttons have provision for 1 N.O. & 1 N.C. circuit on each button. Unneeded circuits need not be wired.

**Table 19.342: Mounting Bracket**

Description	Catalog Number
C-Shaped Mounting Bracket for 9001BR Interior	3110112001

**Table 19.343: Electrical Contact Ratings [2]**

Volts	AC—NEMA B600					Continuous Carrying Amperes	Resistive 75% Power Factor Make, Break and Continuous Carrying Amperes	DC—NEMA P600		
	Inductive 35% Power Factor				Volts			Inductive and Resistive		
	Make		Break					Make and Break Amperes	Continuous Carrying Amperes	
	A	VA	A	VA						
120	30.5	3600	3.75	360	5	5	120	1.1	5	
240	15	3600	1.5	360	5	5	240	0.55	5	
480	7.5	3600	.75	360	5	5	600	0.2	5	
600	6	3600	.6	360	5	5				

**Contact Symbols**

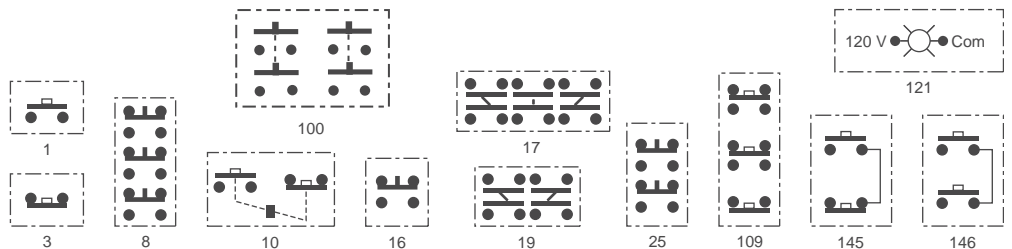



[1] Order separate legend plates, if required, from Table 19.340 Interchangeable Push Button Legend Inserts, page 19-110.

[2] OSHA Regulation, Section 1910.70, Overhead and Gantry Cranes, limits the voltage of pendant push buttons to 150 Vac or 300 Vdc.

9001KY and 9001SKY Control Stations

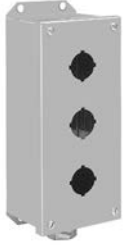
Table 19.344: Empty Enclosures (for Customer Assembly) [1]

	UL Types 1, 3 and 13/ NEMA 1, 3, and 13	UL Types 1, 3, 4 and 13/ NEMA 1, 3, 4 and 13	UL Types 1, 3, 4, 4X and 13/ NEMA 1, 3, 4, 4X and 13	
				
No of Holes	Sheet Steel Type	Die Cast Zinc Type	Stainless Steel (304) Type	Polymeric (Plastic) Type
1	KYAF1	KY1	KYSS1	SKY1
2	KYAF2	KY2 [2]	KYSS2	SKY2
3	KYAF3	KY3 [2]	KYSS3	SKY3
4	KYAF4	KY4 [2]	KYSS4	SKY4
6	KYAF6	KY6	KYSS6	SKY6

NOTE: See Assembled Control Stations , page 19-113

Table 19.345: Guarded Enclosures



KYG1Y  
(mushroom head not included)

No of Holes	UL Types 1, 3, 4 and 13/ NEMA 1, 3, 4 and 13		
	Cover Color	Die Cast Zinc Box Color	Type
1	Gray	Gray	KYG1 [3]
1	Yellow	Gray	KYG1Y [3]

NOTE: See Assembled Control Stations , page 19-113

Table 19.346: Stainless Steel (302) NEMA 1 Flush Plates [4]



K26

No of Holes	Description	Type
1	1 Hole flush plate, cover screws, insulating liners	K25
2	2 Hole flush plate, cover screws, insulating liners	K26
3	3 Hole flush plate, cover screws, insulating liners	K27
4	4 Hole flush plate, cover screws, insulating liners	K28

[1] When ordering, add prefix 9001 to the catalog number.

[2] Only KN200 series legend plates will fit upright on these enclosures with their long axis vertical.



[3] Includes 1" NPT threaded conduit opening.

[4] To be used with a standard 2 x 3 in. general purpose switch box. A 2.5 in. deep switch box should be used if two Type KA contact blocks are mounted side by side. If two Type KA contact blocks are mounted in tandem, a 3.5 in. deep box should be used.



Assembled 9001KY/SKY Control Stations

Table 19.347: Assembled Control Stations

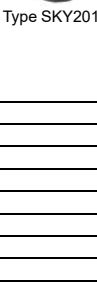
	No of Holes	Operator Style and Features	Type	Consists of				
				Enclosure	Operators	Contact Blocks	Legend Plates	
<b>UL Types 1, 3, 4 and 13/NEMA 1, 3, 4 and 13 Die Cast Zinc Enclosure [5]</b>								
	1	Selector Switch (3 Pos Maintained)	KYK111	KY1	KS43B	KA1	Hand-Off-Auto	
		Selector Switch (2 Pos Maintained)	KYK110	KY1	KS11B	KA1	Off-On	
		Push Button (Momentary)	KYK11	KY1	KR1B	KA1	Start	
		Push Button (Momentary)	KYK13	KY1	KR1R	KA1	Stop	
		Mushroom Button (Momentary)	KYK14	KY1	KR4R	KA1	Stop	
		Push Button (with Lockout)	KYK15	KY1	KR3R, K4	KA1	Stop	
		Break Glass Operator	KYK116	KY1	K15	KA1	To Stop—Break Glass	
	Break Glass Operator (Red Enclosure)	KYK117	KY1S1	K15	KA1	To Stop—Break Glass		
	2	2 Push Buttons (Lockout on Stop)	KYK224	KY2	KR1B, KR3R, K4	KA1, KA1	Jog-Stop	
		2 Push Buttons	KYK218	KY2	KR1B, KR3R	KA1, KA1	On-Off	
		2 Push Buttons	KYK26	KY2	KR1B, KR1B	KA1, KA1	Open-Close	
		2 Push Buttons	KYK25	KY2	KR1B, KR1B	KA1, KA1	Up-Down	
		2 Push Buttons	KYK21	KY2	KR1B, KR3R	KA1, KA1	Start-Stop	
		2 Push Buttons (with Sealed Contacts) [6]	KYK223	KY2	KR1B, KR3R	KA51, KA51	Start-Stop	
2 Push Buttons (Lockout on Stop)		KYK23	KY2	KR1B, KR3R, K4	KA1, KA1	Start-Stop		
2 Push Buttons (Maintained/Interlocked)		KYK27	KY2	KR11GR	KA1	Start-Stop		
3	1 Push Button, 1 Mushroom Button	KYK22	KY2	KR1B, KR4R	KA1, KA1	Start-Stop		
	3 Push Buttons	KYK31	KY3	KR1B, KR1B, KR3R	KA1, KA1, KA1	Forward; Reverse; Stop		
	3 Push Buttons (Lockout on Stop)	KYK326	KY3	KR1B, KR1B, KR3R, K4	KA1, KA1, KA1	Forward; Reverse; Stop		
	3 Push Buttons (With Sealed Contacts & Lockout on Stop) [6]	KYK322	KY3	KR1B, KR1B, KR3R, K4	KA51, KA51, KA51	Forward; Reverse; Stop		
	3 Push Buttons	KYK33	KY3	KR1B, KR1B, KR3R	KA1, KA1, KA1	Open; Close; Stop		
	Red 120v Pilot Light, 2 Push Buttons	KYK317	KY3	KP1R31, KR1B, KR3R	KA2, KA3	Start; Stop		
	3 Push Buttons	KYK32	KY3	KR1B, KR1B, KR3R	KA1, KA1, KA1	Up; Down; Stop		
3 Push Buttons (Lockout on Stop)	KYK325	KY3	KR1B, KR1B, KR3R, K4	KA1, KA1, KA1	Up ; Down; Stop			
<b>UL Types 1, 3, 4 and 13/NEMA 1, 3, 4 and 13—Stainless Steel (304) [7]</b>								
	1	Push Button (Momentary)	KYSS101	KYSS1	KR1B	KA1	Start	
		Push Button (Momentary)	KYSS103	KYSS1	KR1B	KA3	Stop	
		Selector Switch (2 Pos Maintained)	KYSS110	KYSS1	KS11B	KA1	Off-On	
		Selector Switch (3 Pos Maintained)	KYSS111	KYSS1	KS43B	KA1	Hand-Off-Auto	
	2	2 Push Buttons	KYSS201	KYSS2	KR1B, KR3R	KA1, KA3	Start; Stop	
		2 Push Buttons (Lockout on Stop)	KYSS203	KYSS2	KR1B, KR3R, K5	KA1, KA3	Start; Stop	
		2 Push Buttons (Maintained with Interlock)	KYSS210	KYSS2	KR11U	KA1, KA1	Start; Stop	
		2 Push Buttons	KYSS205	KYSS2	KR1B, KR1B	KA1, KA1	Up; Down	
		<b>UL Types 1, 3, 4, 4X and 13/NEMA 1, 3, 4, 4X and 13—Stainless Steel (304) [8]</b>						
			1	Push Button (Momentary)	KYSK101	KYSS1	SKR1B	KA1
Push Button (Momentary)	KYSK103			KYSS1	SKR3R	KA3	Stop	
Selector Switch (2 Pos Maintained)	KYSK110			KYSS1	SKS11B	KA1	Off-On	
Selector Switch (3 Pos Maintained)	KYSK111			KYSS1	SKS43B	KA1	Hand-Off-Auto	
2	2 Push Buttons		KYSK201	KYSS2	SKR1B, SKR3R	KA1, KA3	Start; Stop	
	2 Push Buttons (Lockout on Stop)		KYSK203	KYSS2	SKR1B, SKR3R, K5	KA1, KA3	Start; Stop	
	2 Push Buttons (Maintained with Interlock)		KYSK210	KYSS2	SKR11U	KA1, KA1	Start; Stop	
	2 Push Buttons		KYSK205	KYSS2	SKR1B, SKR1B	KA1, KA1	Up; Down	
	<b>UL Types 1, 3, 4, 4X and 13/NEMA 1, 3, 4, 4X and 13—Polymeric (Plastic) [8]</b>							
			1	Selector Switch (3 Pos Maintained)	SKY111	SKY1	SKS43B	KA1
Selector Switch (2 Pos Maintained)		SKY110		SKY1	SKS11B	KA1	Off-On	
Selector Switch (2 Pos Maintained with Sealed Contacts) [6]		SKY122		SKY1	SKS11B	KA51	Off-On	
Push Button (with Lockout)		SKY105		SKY1	SKR3R, K5	KA3	Stop	
2		2 Push Buttons	SKY201	SKY2	SKR1B, SKR3R	KA1, KA3	Start-Stop	
		2 Push Buttons (Lockout on Stop)	SKY203	SKY2	SKR1B, SKR1R, K5	KA1, KA3	Start-Stop	
		2 Push Buttons (With Sealed Contacts) [6]	SKY223	SKY2	SKR1B, SKR3R	KA51, KA51	Start-Stop	
		2 Push Buttons (With Sealed Contacts) [6]	SKY222	SKY2	SKR1B, SKR3R	KA51, KA51	On-Off	
		2 Push Buttons	SKY205	SKY2	SKR1B, SKR1B	KA1, KA1	Up-Down	
		3	3 Push Buttons	SKY302	SKY3	SKR1B, SKR1B, SKR3R	KA1, KA1, KA3	Up-Down-Stop
3 Push Buttons			SKY303	SKY3	SKR1B, SKR1B, SKR3R	KA1, KA1, KA3	Open-Close-Stop	
Red 120v Pilot Light, 2 Push Buttons			SKY315A	SKY3	SKP1R31, SKR1B, SKR3R	KA1, KA3	Start-Stop	
<b>UL Types 1, 3, 4 and 13/NEMA 1, 3, 4 and 13 Die Cast Zinc Enclosures with Integral Guard</b>								
		1	Guarded Enclosure (grey) with 120V Red LED Pilot Light	KYG11 [9]	KYG1	KP38LRR9	—	order separately
	Guarded Enclosure (grey) with 120V Green LED Pilot Light		KYG12 [9]	KYG1	KP38LGG9	—	order separately	
	Guarded Enclosure (Yellow Cover) with Red Push-Pull Mushroom		KYG1Y1 [9]	KYG1Y	KR9R	KA3	Push to Stop/ Pull to Start	
	Guarded Enclosure (Yellow Cover) with Red Turn-To Release Mushroom		KYG1Y2 [9]	KYG1Y	KR1B	KA3	Emergency Stop	

[5] Uses 9001K metal operators and metal legend plates.  
 [6] Control Station consists of components that are UL listed for use in Class 1, Division 2, Groups A, B, C, or D.  
 [7] Uses 9001K metal operators and plastic legend plates.  
 [8] Uses 9001SK plastic operators and plastic legend plates.  
 [9] Includes 1" NPT threaded conduit opening.

New!

Point of Purchase—PoP Products

Schneider Electric has recently expanded its line of Point of Purchase Blister Packs, comprised of 36 popular products, including: push buttons, pendants, signaling and relay devices. These blister packs are conveniently packaged with all the associated components and accessories that you'll need to complete your installation. Point-of-Purchase packaging makes it easy for you, so you can just grab what you need and go!

Table 19.348: 30 mm Push Buttons

Description	Package Includes	Catalog Number
30 mm Push Button with contact block and multi colors	9001KR1U + 9001KA1 + 9001KN201 + 9001KN202	9001AB1
30 mm Push Pull Mushroom	9001KR9R + 9001KA1	9001AB2
30 mm Mushroom with Legend	9001KR5R + 9001KA1 + 9001KN205	9001AB3
30 mm 2 Position Selector Switch with contact and legend	9001KS11B + 9001KA1 + 9001KN244	9001AS1
30 mm 3 Position Selector Switch with contact and legend	9001KS43B + 9001KA1 + 9001KN260	9001AS2
Pilot Light (KP)	9001KP1 + 9001R9 + 9001G9	9001AL1
30 mm Control Station	9001BG201	9001AE3



9001AB1



9001AE3



9001AB2



XALACS2



XVCTL1

Table 19.349: 22 mm Push Buttons

Description	Package Includes	Catalog Number
22 mm PB with contact block + 6 colors	ZB4BZ101 + ZB4BA9	XB4AB1
22 mm Mushroom with contact	XB4BS542	XB4AB2
22 mm 2 Position Selector Switch	XB4BD21	XB4AS1
22 mm 3 Position Selector Switch	XB4BJ33	XB4AS2
22 mm control station - Mushroom	XALK178	XALACS1
22 mm control station - 2 button	XALD211	XALACS2

Table 19.350: Pendants

Description	Package Includes	Catalog Number
BW Pendant	9001BW92Y	9001BWP1

Table 19.351: Tower Lights

Description	Package Includes	Catalog Number
40 mm tower light (3) 24V AC/DC	XVC4B3K	XVCTL1

Table 19.352: Power Relays

Description	Package Includes	Catalog Number
Open Power Relay 120VAC, DPDT	8501CO16V20	8501CDPDT
Open Power Relay 120VAC, DPST-N.O.	8501CO7V20	8501CDPST
Open Power Relay 120VAC, SPST-N.O.	8501CO6V20	8501CSPST

Table 19.353: Slim and Interface Relays

Description	Package Includes	Catalog Number
RSL pre-assembled (24V screw conn)	RSL1PVBU + RSLZ5	ASLSCR24
RSL pre-assembled (24V spring conn)	RSL1PRBU + RSLZ5	ASLSR24
RSL pre-assembled (120 V screw conn)	RSL1PVFU + RSLZ5	ASLSCR120
RSL pre-assembled (120 V spring conn)	RSL1PRFU + RSLZ5	ASLSR120
RSB1 pre-assembled 24VDC	RSB1A120BD + RSZE1S35M + RZM031RB + RSZR215 + RSZL300	RSB1SOC24D
RSB2 pre-assembled 24VDC	RSB2A080BD + RSZE1S48M + RZM031RB + RSZR215 + RSZL300	RSB2SOC24D

Table 19.354: Plug-In Relays

Description	Package Includes	Catalog Number
RPM1 24 VDC pre-assembled	RPM12BD + RPZF1 + RPZR235 + RXM040W + RXZL520	RPM1SOC24D
RPM1 120 VAC pre-assembled	RPM12F7 + RPZF1 + RPZR235 + RXM021FP + RXZL520	RPM1SOC120A
RXM4 24 VDC pre-assembled	RXM4AB2BD + RXZE2M114 + RXM040W + RXZR335 + RXZL520	RXM4SOC24D
RXM4 120 VAC pre-assembled	RXM4AB2F7 + RXZE2M114 + RXM021FP + RXZR335 + RXZL520	RXM4SOC120A

**XVB 70 mm Diameter Beacons**

**Table 19.355: XVB Beacons with Steady Light**



Description	Light Source and Voltage	Color	Catalog Number
Complete unit, includes: 1 lens unit 1 base unit (direct or tube mounting)	Bulb (10 W max) not included 250 V max (must order bulb separately [1])	Green	<a href="#">XVBL33</a>
		Red	<a href="#">XVBL34</a>
		Amber	<a href="#">XVBL35</a>
		Blue	<a href="#">XVBL36</a>
		Clear	<a href="#">XVBL37</a>
		Yellow	<a href="#">XVBL38</a>

**Table 19.356: XVB Beacons with Flashing Light (one flash per second)**



Description	Light Source and Voltage	Color	Catalog Number
Complete unit, includes: 1 lens unit 1 base unit (direct or tube mounting)	Bulb (10 W max) not included 24 Vac 24–48 Vdc (must order bulb separately [1])	Green	<a href="#">XVBL4B3</a>
		Red	<a href="#">XVBL4B4</a>
		Amber	<a href="#">XVBL4B5</a>
		Blue	<a href="#">XVBL4B6</a>
		Clear	<a href="#">XVBL4B7</a>
		Yellow	<a href="#">XVBL4B8</a>
	Bulb (10 W max) not included 48–230 Vac (must order bulb separately [1])	Green	<a href="#">XVBL4M3</a>
		Red	<a href="#">XVBL4M4</a>
		Amber	<a href="#">XVBL4M5</a>
		Blue	<a href="#">XVBL4M6</a>
		Clear	<a href="#">XVBL4M7</a>
		Yellow	<a href="#">XVBL4M8</a>

**Table 19.357: XVB Beacons with 10 Joule Strobe (2.75 in./70 mm diameter) [2]**

Description	Light Source and Voltage	Color	Catalog Number [3]
Complete unit, includes: 1 lens unit 1 base unit (direct or tube mounting)	Strobe 24 Vac/Vdc (includes bulb)	Green	<a href="#">XVBL8B3</a>
		Red	<a href="#">XVBL8B4</a>
		Amber	<a href="#">XVBL8B5</a>
		Blue	<a href="#">XVBL8B6</a>
		Clear	<a href="#">XVBL8B7</a>
		Yellow	<a href="#">XVBL8B8</a>
	Strobe 120 Vac (includes bulb)	Green	<a href="#">XVBL8G3</a>
		Red	<a href="#">XVBL8G4</a>
		Amber	<a href="#">XVBL8G5</a>
		Blue	<a href="#">XVBL8G6</a>
		Clear	<a href="#">XVBL8G7</a>
		Yellow	<a href="#">XVBL8G8</a>

**NOTE:** There are no replacement lenses for strobes.

[1] For bulbs, see [XVB Accessories](#), page 19-117.  
 [2] **Important:** Discharge tube elements are not suitable for continuous-operation signaling due to temperature rise caused by the discharge tube.  
 [3] For 5 Joule units, specify XVBL6\*\*, instead of XVBL8\*\*.

XVB 70 mm Components

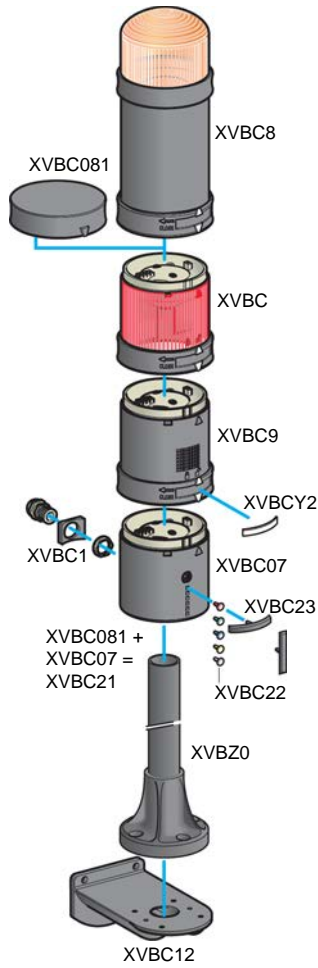

Table 19.358: XVB Lens Units for Steady Light

Description	Light Source and Voltage	Color	Catalog Number
Illuminated lens unit	Bulb (10 W max) not included 250 Vac/Vdc max (must order bulb separately [4])	Green	XVBC33
		Red	XVBC34
		Orange	XVBC35
		Blue	XVBC36
		Clear	XVBC37
		Yellow	XVBC38

Table 19.359: XVB Lens Unit for Flashing Light

Description	Light Source and Voltage	Color	Catalog Number
Illuminated lens unit	Bulb (10 W max) not included 24 Vac 24–48 Vdc (must order bulb separately [4])	Green	XVBC4B3
		Red	XVBC4B4
		Orange	XVBC4B5
		Blue	XVBC4B6
		Clear	XVBC4B7
		Yellow	XVBC4B8
	Bulb (10 W max) not included 48–230 Vac (must order bulb separately [4])	Green	XVBC4M3
		Red	XVBC4M4
		Orange	XVBC4M5
		Blue	XVBC4M6
		Clear	XVBC4M7
		Yellow	XVBC4M8

NOTE: There are no replacement lenses units for the XVBC8\*\* strobes.

Table 19.360: XVB Lens Units with 10 Joule Strobe

Description	Light Source and Voltage	Color	Catalog Number [5]	
Lens unit with integral 10 Joule strobe	Strobe 24 Vac/Vdc (includes bulb)	Green	XVBC8B3	
		Red	XVBC8B4	
		Orange	XVBC8B5	
		Blue	XVBC8B6	
		Clear	XVBC8B7	
		Yellow	XVBC8B8	
		Strobe 120 Vac (includes bulb)	Green	XVBC8G3
			Red	XVBC8G4
			Orange	XVBC8G5
	Blue		XVBC8G6	
	Clear		XVBC8G7	
	Yellow		XVBC8G8	

Table 19.361: Audible Sounder Units

Description	Supply Voltage	Catalog Number
Sounder unit 90 dB at 1 m	12–48 Vac/Vdc	XVBC9B
Adjustable from 75–90 dB Continuous or intermittent modes	120–230 Vac	XVBC9M

Table 19.362: Base Units + Cover

Description	Catalog Number
Base unit + cover for direct or tube mounting, bottom or side cable entry (includes gasket)	XVBC21

[4] For bulbs, see XVB Accessories, page 19-117.

[5] For 5 Joule units, specify XVBC6\*\*, instead of XVBC8\*\*.

**XVB 70 mm Accessories**

**Table 19.363: XVB Accessories**

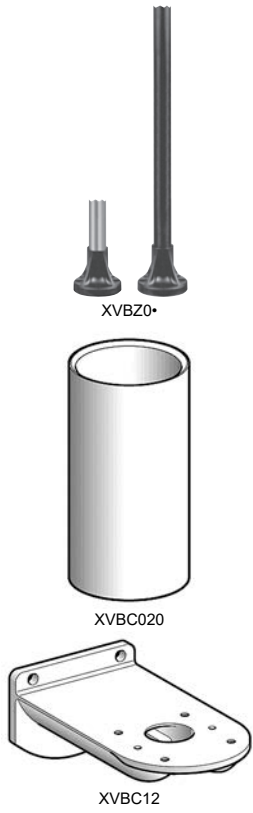

Description	Characteristics		Catalog Number		
	in.	mm			
Black tube with integral black plastic mounting base (includes gasket)	4.72	120	XVBZ02	XVBZ02A [6]	
	15.75	400	XVBZ03	XVBZ03A [6]	
	31.50	800	XVBZ04	XVBZ04A [6]	
Support tube concealment cover	3.94	100	XVC020		
	15.75	400	XVC030		
	31.50	800	XVC040		
Wall mount bracket (metal)	For direct mounting on base unit or with tulip XVC11 + tube XVC0*		XVC12		
Incandescent bulbs bayonet type BA 15d, 10 Watts	12 Vac/Vdc		DL1BLJ		
	24 Vac/Vdc		DL1BLB		
	48 Vac/Vdc		DL1BLE		
	120 Vac/Vdc		DL1BLG		
	230 Vac/Vdc		DL1BLM		
Incandescent bulbs bayonet type BA 15d, 7 Watts	12 Vac/Vdc		DL1BEJ		
	24 Vac/Vdc		DL1BEB		
	48 Vac/Vdc		DL1BEE		
	120 Vac/Vdc		DL1BEG		
	230 Vac/Vdc		DL1BEM		
Steady-On LED bulbs bayonet type BA 15d (sold as single) [7]	24 Vac/Vdc	White	DL1BDB1		
		Green	DL1BDB3		
		Red	DL1BDB4		
		Blue	DL1BDB6		
		Yellow	DL1BDB8		
	120 Vac	Amber	DL1BDB5		
		White	DL1BDG1		
		Green	DL1BDG3		
		Red	DL1BDG4		
		Blue	DL1BDG6		
Flashing LED bulbs	24 Vac/Vdc	Yellow	DL1BDG8		
		Amber	DL1BDG5		
		White	DL1BKB1		
		Green	DL1BKB3		
		Red	DL1BKB4		
	120 Vac	Amber	DL1BKB5		
		Blue	DL1BKB6		
		Yellow	DL1BKB8		
		Green	DL1BKG3		
		Red	DL1BKG4		
Adapter for side entry through base unit	With CM12 (p. 13.5) cable gland, for cable size of 0.4 to 0.55 in. (10 to 14 mm) diameter	Amber	DL1BKG5		
		Blue	DL1BKG6		
		Yellow	DL1BKG8		
		Conduit adapter	1/2 in. NPT (for customer supplied tubing)	XVC00	

**Table 19.364: XVB Markers and Legend Holders**

Description	Characteristics	Catalog Number
Set of colored markers	6 colors	XVC22
Set of 5 legend holders	Identification of stacked units on base	XVC23

**Wiring Diagrams, Base Units**

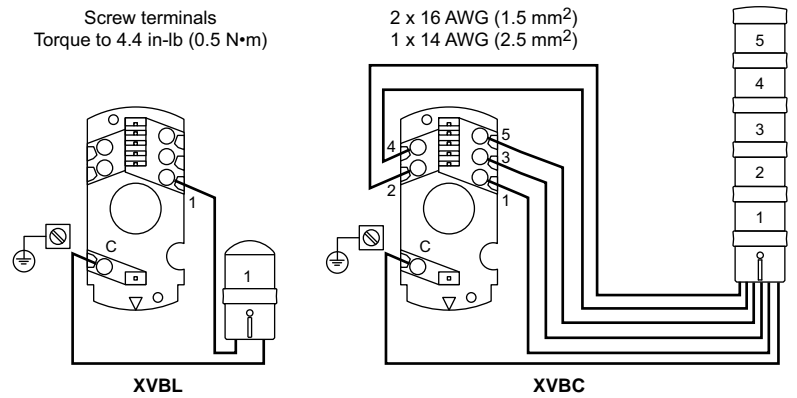

[6] Aluminum tube.  
[7] For 240 Vac, replace the B or G in the catalog number with M—for example, DL1BDM1. For flashing LEDs, refer to catalog 9001CT0001.

XVC Tower Lights and Accessories

Table 19.365: XVC4 Tower Lights — 40 mm diameter (1.5 inches)



Description	Light source (included)	Voltage	Signaling colors [8]		Catalog Number
			Steady	Flashing	
<b>With support tube mounting</b>					
Without buzzer	LED for steady light only	24 Vdc	R	—	XVC4B1
			R, O	—	XVC4B2
			R, O, G	—	XVC4B3
			R, O, G, B	—	XVC4B4
			R, O, G, B, C	—	XVC4B5
		100-240 Vac	R	—	XVC4M1
			R, O	—	XVC4M2
			R, O, G	—	XVC4M3
			R, O, G, B	—	XVC4M4
			R, O, G, B, C	—	XVC4M5
With buzzer + flashing light	LED for steady or flashing light [9]	24 Vdc	R	R	XVC4B15S
			R, O	R, O	XVC4B25S
			R, O, G	R, O, G	XVC4B35S
			R, O, G, B	R, O, G, B	XVC4B45S
			R, O, G, B, C	R, O, G, B, C	XVC4B55S
		100-240 Vac	R	R	XVC4M15S
			R, O	R, O	XVC4M25S
			R, O, G	R, O, G	XVC4M35S
			R, O, G, B	R, O, G, B	XVC4M45S
			R, O, G, B, C	R, O, G, B, C	XVC4M55S
<b>For base mounting</b>					
Without buzzer	LED for steady light only	24 Vdc	R	—	XVC4B1K
			R, O	—	XVC4B2K
			R, O, G	—	XVC4B3K
			R, O, G, B	—	XVC4B4K
			R, O, G, B, C	—	XVC4B5K

Table 19.366: Accessories for XVC4

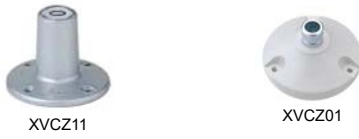

Description	Diameter mm	Minimum height to be added mm	Catalog Number
Die-cast metal mounting base (for use with XVC4** and XVC4**5S with support tube)	90	32	XVCZ11
Plastic mounting base (for use with XVC4, XVC4** and XVC4**5S — customer must discard the support tube)	84	24.5	XVCZ01

Table 19.367: XVC Tower Lights — 100 mm diameter (4 inches)



Description	Light source (included)	Voltage Vdc	Signaling colors [8]		Catalog Number
			Steady	Flashing	
<b>For base mounting</b>					
Without buzzer With flashing light	LED for steady or flashing light [9]	24	R	R	XVC1B1K
			R, O	R, O	XVC1B2K
			R, O, G	R, O, G	XVC1B3K
			R, O, G, B	R, O, G, B	XVC1B4K
			R, O, G, B, C	R, O, G, B, C	XVC1B5K
		100-240 Vac	R	R	XVC1M1K
			R, O	R, O	XVC1M2K
			R, O, G	R, O, G	XVC1M3K
			R, O, G, B	R, O, G, B	XVC1M4K
			R, O, G, B, C	R, O, G, B, C	XVC1M5K
With buzzer + flashing light	LED for steady or flashing light [9]	24	R	R	XVC1B1SK
			R, O	R, O	XVC1B2SK
			R, O, G	R, O, G	XVC1B3SK
			R, O, G, B	R, O, G, B	XVC1B4SK
			R, O, G, B, C	R, O, G, B, C	XVC1B5SK
		100-240 Vac	R	R	XVC1M1SK
			R, O	R, O	XVC1M2SK
			R, O, G	R, O, G	XVC1M3SK
			R, O, G, B	R, O, G, B	XVC1M4SK
			R, O, G, B, C	R, O, G, B, C	XVC1M5SK

Table 19.368: Accessories for XVC1



Description	Diameter mm	Height mm	Catalog Number
Mount tube and base	140	300	XVCZ13
L-shape mount bracket	—	—	XVCZ23

[8] Signaling colors: R = Red, G = Green, O = Orange, B = Blue, C = Clear. The colors are listed in the mounting order of the illuminated units from top to bottom.

[9] Flashing light function selected by wiring or programming.



**Table 19.369: XVC6 Tower Lights, 60 mm diameter (2.375 inches)**

Description	Light source (included)	Voltage	Signaling colors [10]		Catalog Number
			Steady	Flashing	
<b>With support tube mounting</b>					
Without buzzer	LED for steady light only	24 Vdc	R	–	XVC6B1
			R, O	–	XVC6B2
			R, O, G	–	XVC6B3
			R, O, G, B	–	XVC6B4
			R, O, G, B, C	–	XVC6B5
		100-240 Vac	R	–	XVC6M1
			R, O	–	XVC6M2
			R, O, G	–	XVC6M3
			R, O, G, B	–	XVC6M4
			R, O, G, B, C	–	XVC6M5
With buzzer + flashing light	LED for steady or flashing light [11]	24 Vdc	R	R	XVC6B15S
			R, O	R, O	XVC6B25S
			R, O, G	R, O, G	XVC6B35S
			R, O, G, B	R, O, G, B	XVC6B45S
			R, O, G, B, C	R, O, G, B, C	XVC6B55S
		100-240 Vac	R	R	XVC6M15S
			R, O	R, O	XVC6M25S
			R, O, G	R, O, G	XVC6M35S
			R, O, G, B	R, O, G, B	XVC6M45S
			R, O, G, B, C	R, O, G, B, C	XVC6M55S
<b>For base mounting</b>					
Without buzzer	LED for steady light only	24 Vdc	R	–	XVC6B1K
			R, O	–	XVC6B2K
			R, O, G	–	XVC6B3K
			R, O, G, B	–	XVC6B4K
			R, O, G, B, C	–	XVC6B5K
		100-240 Vac	R	–	XVC6M1K
			R, O	–	XVC6M2K
			R, O, G	–	XVC6M3K
			R, O, G, B	–	XVC6M4K
			R, O, G, B, C	–	XVC6M5K
With buzzer + flashing light	LED for steady or flashing light [11]	24 Vdc	R	R	XVC6B15SK
			R, O	R, O	XVC6B25SK
			R, O, G	R, O, G	XVC6B35SK
			R, O, G, B	R, O, G, B	XVC6B45SK
			R, O, G, B, C	R, O, G, B, C	XVC6B55SK
		100-240 Vac	R	R	XVC6M15SK
			R, O	R, O	XVC6M25SK
			R, O, G	R, O, G	XVC6M35SK
			R, O, G, B	R, O, G, B	XVC6M45SK
			R, O, G, B, C	R, O, G, B, C	XVC6M55SK



**Table 19.370: Accessories for XVC6**

Description	Diameter mm	Minimum height to be added mm	Catalog Number
Die-cast metal mounting base for XVC6B• and XVC6B•5S with support tube.	100	30	XVCZ02
Stamped metal mounting base for XVC6B• K and XVC6B•5SK	84	21.6	XVCZ12

[10] Signaling colors: R = Red, G = Green, O = Orange, B = Blue, C = Clear. The colors are listed in the mounting order of the illuminated units from top to bottom.

[11] Flashing light function selected by wiring or programming.

**Tower Lights For Customer Assembly (up to 5 units)**

**Tower Lights**

The XVU tower lights are customer assembled products comprising:

1	Top cover (black or silver)
2	Buzzer unit (black or silver) <sup>[12]</sup>
3	Illuminated units: <sup>[13]</sup>
3.1	LED illuminated units with steady or blinking light signaling (colors: green, red, orange, blue, white, or yellow)
3.2	Multi-color LED unit (colors: green, red, orange, blue, white, or yellow. Patterns: steady, blinking, flashing, or rotating)
3.3	Pulse signal multi-color LED unit (colors: green, red, orange, or blue. Patterns: steady, blinking, flashing, or rotating) <sup>[14]</sup> / <sup>[15]</sup>
4	Sound units
4.1	Sound unit
4.2	Sound unit, plus signal <sup>[15]</sup>
5	Extender unit (black or silver)
6	Base unit, DC (black or silver)
7	Base unit, AC (black or silver)
8	Flexible mounting unit
9	Direct mounting plate (black or silver)
10	100 mm/3.927 in., 400 mm/15.748 in., or 800 mm/31.496 in. pole with integrated mounting plate (black or silver for 100 mm pole, and black for 400 mm and 800 mm pole)
11	Adjustable height pole from 210 to 385 mm/8.268 to 15.157 in. <sup>[16]</sup> with integrated mounting plate
12	100 mm/3.927 in., 250 mm/9.842 in., or 400 mm/15.748 in. pole with metal bracket (black)
13	Mounting plate for use on vertical support (black) <sup>[17]</sup>
14	½" NPT conduit adapter for customer supplied tubing

**Composition**

- XVU tower lights are customer assembled signaling units that are mounted vertically or horizontally with the support of a mounting accessory.
- Maximum of 5 illuminated units or 4 illuminated units with 1 audible unit can be assembled. The illuminated or audible unit<sup>[18]</sup>, stack vertically.
- With the indicator marks on these units they can be easily assembled.
- Electrical connections between each unit are made automatically as they are mechanically assembled.
- The signaling units are identical in size and their positioning is unrestricted.

**Mounting**

- Horizontal mounting: Fixed into support panel with direct mounting plate, poles or adjustable height pole with integrated mounting plate
- Vertical mounting: Fixed into support panel with mounting plate using pole with metal bracket or mounting plate for use on vertical support
- Horizontal or vertical mounting: Fixed into support panel with mounting plate using flexible mounting unit
- Mounting plate with aluminium 1/2" NPT adapter.

**Cablling**

By means of spring cage connection terminal block incorporated in mounting unit (Direct mounting plate, pole with plate, adjustment pole)

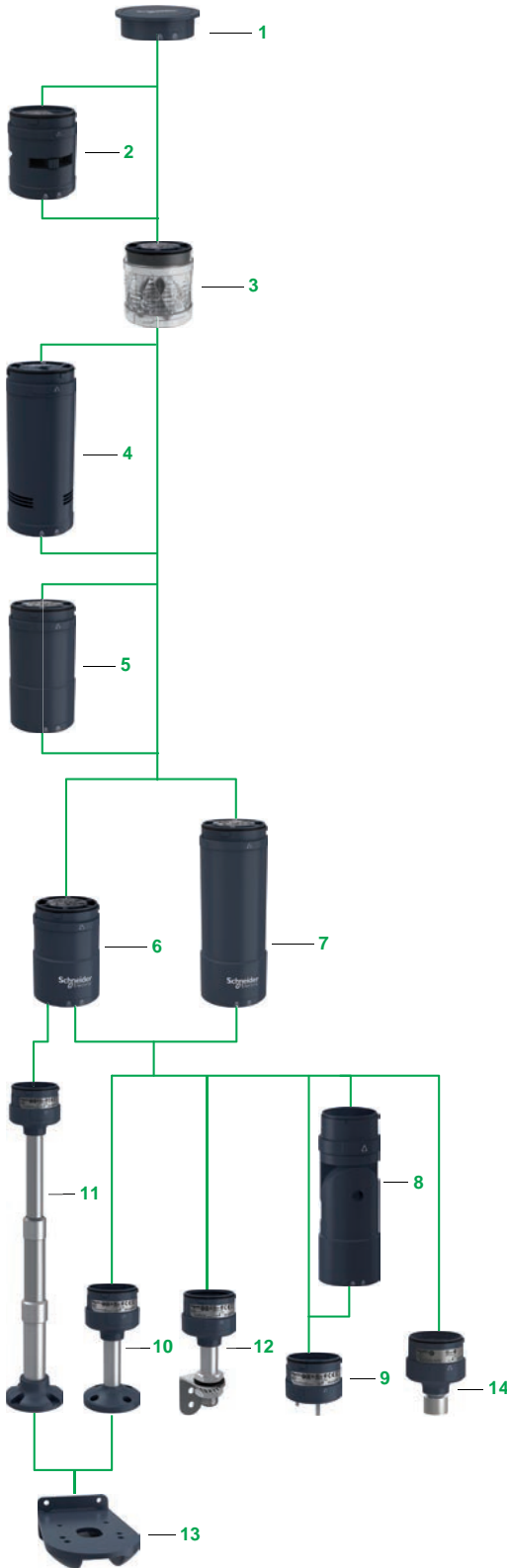

19 PUSH BUTTONS AND OPERATOR INTERFACE

[12] Always mounted on the top .  
 [13] Up to 5 LED illuminated units without sound unit; Up to 4 LED illuminated units with sound unit .  
 [14] Pulse signal multi-color LED unit cannot be combined with standard sound unit (XVUC9V).  
 [15] Up to 4 illuminated and sound units when pulse signal technology is used.  
 [16] Only for DC body unit.  
 [17] Compatible with XVUZ02, XVUZ02Q, XVUZ03, XVUZ400, XVUZ800, and XVUZ05.  
 [18] Sound unit cannot be combined with buzzer unit at the same time.



**Illuminated Units, High Flash LED Units**



XVUC23  
XVUC43



XVUC24  
XVUC44



XVUC25  
XVUC45



XVUC6  
XVUC46



XVUC27  
XVUC47



XVUC28  
XVUC48



XVUC29  
XVUC29P

Illuminated LED Units: IP 65						
Description	Signaling Type	Characteristics		Color	Reference	Weight kg/lb
		Voltage	Power			
High brightness LED Units	Steady	24 V	2.5 W	Green	XVUC23	0.064/0.141
		24 V	2.0 W	Red	XVUC24	0.064/0.141
		24 V	2.0 W	Orange	XVUC25	0.064/0.141
		24 V	2.5 W	Blue	XVUC26	0.064/0.141
		24 V	2.5 W	White	XVUC27	0.064/0.141
		24 V	2.5 W	Yellow	XVUC28	0.064/0.141
	Blinking	24 V	1.2 W	Green	XVUC43	0.064/0.141
		24 V	0.9 W	Red	XVUC44	0.064/0.141
		24 V	0.9 W	Orange	XVUC45	0.064/0.141
		24 V	1.2 W	Blue	XVUC46	0.064/0.141
		24 V	1.2 W	White	XVUC47	0.064/0.141
		24 V	1.2 W	Yellow	XVUC48	0.064/0.141
Multi-color LED unit	Steady/ blinking/ flashing/ rotating	24 V	1.5 W	Multi-color (green, red, orange, blue, white, and yellow)	XVUC29	0.064/0.141
Pulse signal Multi-color LED unit [19]	Steady/ blinking/ flashing/ rotating	24 V	1.7 W	Multi-color (green, red, orange, and blue)	XVUC29P	0.069/0.152

[19] 1 signal wire, 2 power wires. Adaptable for both NPN and PNP. Controlled by PLC dynamically.

**Audible and Base Units**

Audible Units: IP 54					
Description	Characteristics		Color	Reference	Weight kg/lb
	Voltage	Power			
Buzzer, adjustable 70...85 dB at 1 m/3.281 ft (4 configurations of audible signal)	24 V	1.7 W	Black	XVUC9S	0.077/0.170
			Silver	XVUC9SQ	0.077/0.170
Sound, adjustable 0...86 dB at 1m/3.281 ft (4 channels)	24 V	1.7 W	Black	XVUC9V	0.217/0.480
Sound unit, pulse signal 0...86 dB at 1m/3.281 ft (16 channels) <sup>[20]</sup>	24 V	4.1 W	Black	XVUC9VP	0.219/0.483

Base Units: IP 65				
Description	Voltage	Color	Reference	Weight kg/lb
Base unit with top cover <sup>[21]</sup>	24 Vac/Vdc	Black	XVUC21B	0.110/0.243
		Silver	XVUC21BQ	0.110/0.243
	100 to 240 Vac	Black	XVUC21M <sup>[22]</sup>	0.235/0.518
		Black	XVUC21MP <sup>[23]</sup>	0.235/0.518
		Black	XVUC21MQP <sup>[23]</sup>	0.235/0.518



XVUC9S



XVUC9SQ



XVUC9V



XVUC21BQ



XVUC21M

[20] 1 signal wire, 2 power wires. Adaptable for both NPN and PNP. 16 channels can be controlled by PLC.  
 [21] Direct mounting plate XVUZ01• needed for direct mounting.  
 [22] NPN type.  
 [23] PNP type.

**Accessories**

Accessories					
Description	Voltage	Height of aluminum pole mm/in.	Color	Reference	Weight kg/lb
Body extender	24 Vac/Vdc	—	Black	XVUC020	0.093/0.205
			Silver	XVUC020Q	0.093/0.205
Direct Mounting Plate		—	Black	XVUZ01 [24]	0.063/0.139
				XVUZ03 [25]	0.063/0.139
				XVUZ04 [26]	0.063/0.139
			Silver	XVUZ01Q [25]	0.063/0.139
Mounting plate with aluminum pole		100/3.927	Black	XVUZ02	0.132/0.291
		100/3.927	Silver	XVUZ02Q	0.132/0.291
		400/15.748	Black	XVUZ400	0.236/0.520
		800/31.496	Black	XVUZ800	0.430/0.945
Mounting plate with adjustable height aluminum pole [27]		210 to 385/ 8.268 to 15.157	Black	XVUZ05	0.253/0.558
Flexible mounting unit for use on horizontal or vertical support, IP 55		—	Black	XVUZ06	0.193/0.425
Metal bracket with aluminum pole, IP42		100/3.927	Black	XVUZ100T	0.220/0.485
		250/9.842	Black	XVUZ250T	0.240/0.529
		400/15.74	Black	XVUZ400T	0.320/0.705
Mounting plate for use on vertical support		—	Black	XVUZ12	0.360/0.794
Mounting plate with aluminium 1/2" NPT adapter		—	Black	XVUZ00	0.095/0.209



XVUC020



XVUZ01Q



XVUZ400



XVUZ05



XVUZ100T



XVUZ06



XVUZ12



XVUZ00

[24] Three-pin mounting.  
[25] Two-pin mounting.  
[26] Four-pin mounting.  
[27] Only for use with DC body unit.

**XVGU Multi-color USB Tower Lights**

The monolithic USB tower lights of the Harmony® XVGU range supports Magelis HMIs [28]. These tower lights with multi-color LEDs are unique and simple-to use as the states and patterns are directly set and modified in the HMI application.

The XVGU tower lights provide long distance indication of the operating status or sequences of a machine or installation, both visually by illuminated signaling units with 360° visibility, and audibly by a buzzer.

- The tower light comes with a pre-assembled USB cable for simple wiring and easy integration with the Magelis HMIs [28] [29]
- The tower light settings are selected from the Set screen of the HMI application at the time of integration.
  - The multi-color LEDs on the three levels can be set to numerous color combinations (red, orange, green or blue) for sophisticated signaling.
  - The 2-tone buzzer volume and alarm type (4 pre-recorded types) can be set easily.
- The tower lights allow to optimize your equipment: many customized configurations can be made from a sole product.
- The range involves Ø 60 mm/2.36 in. products and is therefore ideal for use in many activity sectors (textiles, packaging, baggage handling). It is also ideal for use with metal tools, plastic extrusion machines and assembly lines. This range is only for indoor applications

**NOTE:** Signaling colors correspond to a combination of 4 colors (red, orange, green, and blue) which can be set easily in the HMI application.



Magelis HMIs [28]

**Table 19.371: Pre-assembled tower lights — 5 V, 60 mm/2.36 in. Dia.**

Description	Light Source (included)	Compatible with terminals [30]	Catalog Number
<b>Tower light</b> composed of 100 mm/3.94 in. aluminium tube mounting, fixing plate and buzzer	Multi-color LED for various states and patterns (red, orange, green, or blue)	XBTGT (except GT1000 series) XBTGC (with SoMachine platform) XBTGK HMIGTO HMIGXO HMISCU	XVGU3SHAV
<b>Tower light</b> composed of direct base mounting and buzzer	Multi-color LED for various states and patterns (red, orange, green, or blue)	XBTGT (except GT1000 series) XBTGC (with SoMachine platform) XBTGK HMIGTO HMIGXO HMISCU	XVGU3SWV



XVGU3SHAV



XVGU3SWV



BMXXCAUSBH018

**Table 19.372: Accessories**

Description	Function	Length	Catalog Number
<b>Connection cable</b> from PC to the terminal (USB Type A/mini B)	Cable for transferring screen data from a PC (USB Type A) to a HMI (USB Type mini B)	1.8 m/5.91 ft	BMXXCAUSBH018

[28] Compatible with XBTGT (except GT1000 series), XBTGC (with SoMachine platform), XBTGK and HMIGTO terminals.

[29] For extension, use either the Schneider Electric USB cable (BMXXCAUSBH018) or a third-party USB Type A/mini B cable of maximum length 4 m/13.12 ft.

[30] Compatible with Vijeo Designer HMI configuration software V6.1, Service pack 1.

**XVR Pre-Wired Beacons and Accessories**  
**Table 19.373: XVR Pre-Wired Rotating Mirror Beacons**



Diameter (mm)	Sound Option	Enclosure Rating	Voltage	Color	Catalog Number
Ø 84	Without buzzer	IP 23 (IP 65 with accessories)	12 Vac/Vdc	Red	XVR08J04
				Orange	XVR08J05
				Green	XVR08J03
				Blue	XVR08J06
			24 Vac/Vdc	Red	XVR08B04
				Orange	XVR08B05
				Green	XVR08B03
				Blue	XVR08B06
Ø 106	Without buzzer	IP 23 (IP 55 with accessories)	12 Vac/Vdc	Red	XVR10J04
				Orange	XVR10J05
				Green	XVR10J03
				Blue	XVR10J06
			24 Vac/Vdc	Red	XVR10B04
				Orange	XVR10B05
				Green	XVR10B03
				Blue	XVR10B06
Ø 120	Without buzzer	IP 23	12 Vac/Vdc	Red	XVR12J04
				Orange	XVR12J05
				Green	XVR12J03
				Blue	XVR12J06
			24 Vac/Vdc	Red	XVR12B04
				Orange	XVR12B05
				Green	XVR12B03
				Blue	XVR12B06
Ø 120	With buzzer	IP 23	12 Vac/Vdc	Red	XVR12J04S
				Orange	XVR12J05S
				Green	XVR12J03S
				Blue	XVR12J06S
			24 Vac/Vdc	Red	XVR12B04S
				Orange	XVR12B05S
				Green	XVR12B03S
				Blue	XVR12B06S
Ø 130	Without buzzer	IP 23 Resistant to vibration	12 Vdc	Red	XVR13J04
				Orange	XVR13J05
			24 Vdc	Red	XVR13B04
				Orange	XVR13B05

**Table 19.374: XVR Accessories**



Description	Diameter (mm)	Height (mm)	Catalog Number
Reflecting prism	84	—	XVRZR1
	106	—	XVRZR2
	120/130	—	XVRZR3
Rubber base to increase the IP degree of protection	84	—	XVRZ081
	106	—	XVRZ082
Mount tube and base	106, 120 and 130	300	XVCZ13
L-shape mounting bracket	84, 106 and 120	—	XVCZ23

XVS Sirens and Electronic Alarms

Table 19.375: XVS Sirens and Electronic Alarms

Description	Voltage	Color	Catalog Number
Multisound siren 105 dB, 43 tones	12/24 Vdc	White	XVS14BMW
Electronic alarms 90 dB, 16 tones Panel Mount DIN72	12/24 Vac/Vdc	PNP, Black	XVS72BMBP
		PNP, White	XVS72BMMWP
		NPN, Black	XVS72MBN
		NPN, White	XVS72BMWN



XVS14BMW



XVS72BM

Table 19.376: XVS Dimensions (mm)

XVS 14BMW

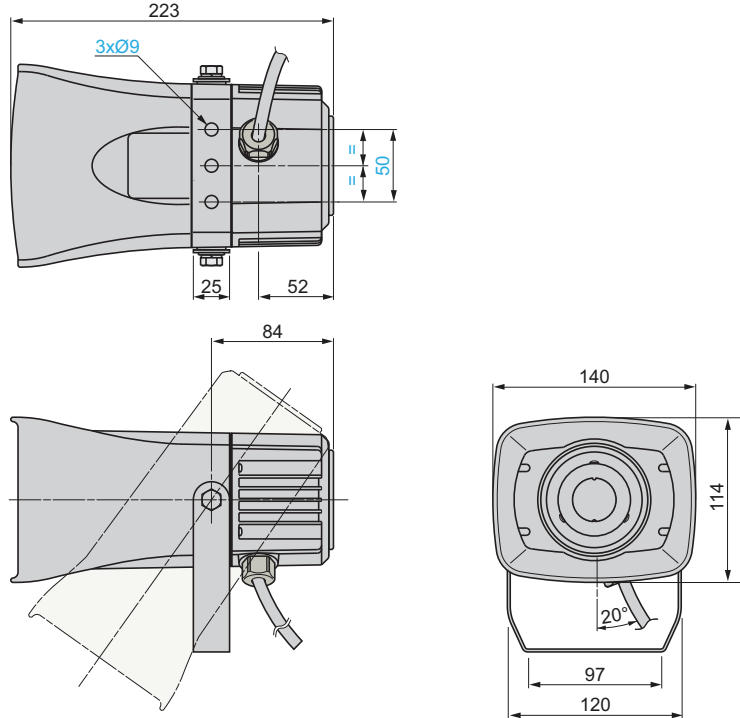

XVS 72BM●●

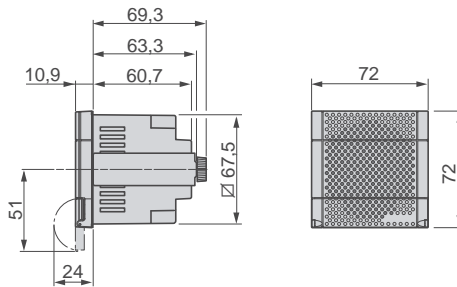

**Harmony eXLhoist**  
**Presentation**

The Harmony eXLhoist range of wireless remote control systems provides complete innovative crane operator control solutions to help improve machine and crane operator efficiency, protect people and equipment, and reduce installation and maintenance downtime.

The XARS remote control system is a combination of remote control device (or transmitter: XART) and base station (or receiver: XARB), which transmits commands and information from the operator to the machine and vice versa by wireless transmission.

The XARS system offers movement in 3 directions (for example: hoist, bridge, and trolley) at 2 speeds (low and high) for each movement.

The 2 modes available in the system are:

- Single mode: The remote control device controls one base station.
- MBC mode<sup>[1]</sup>: The remote control device controls 2 base stations simultaneously.

**Radio Communication**

Each base station has a unique identification code<sup>[2]</sup> managed by Schneider Electric. The radio communication frequency is 2.4 GHz and automatic frequency hopping allows up to 50 systems to run at the same time in a 100 x 100 m/328 x 328 ft area.

**eXLhoist Configuration Software**

Free software with a graphic user interface can be downloaded by the customer to configure the remote control station. This software has a standard Windows® interface. The configuration file is password protected and can be used to configure the following parameters:

- Base station pairing to the remote control device
- Relay-pushbutton assignment and interlocking
- Access and restart sequence
- Standby time-out duration
- Machine number assignment

**Environment**

Degree of protection:

- IP 65 for the base station
- IP 65 and NEMA 4 for the wireless control device

Product certification:

- For the base station: UL/CSA, CE, EAC
- For the wireless control device: UL/CSA, CE, EAC

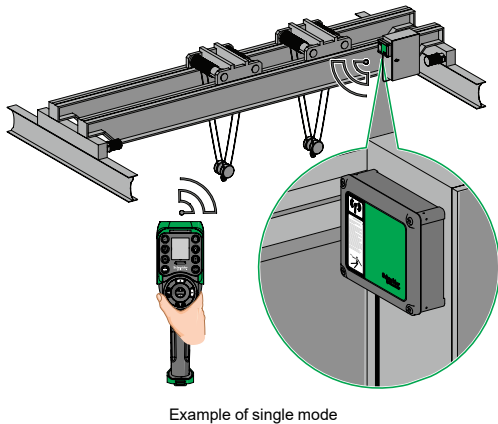

Example of single mode

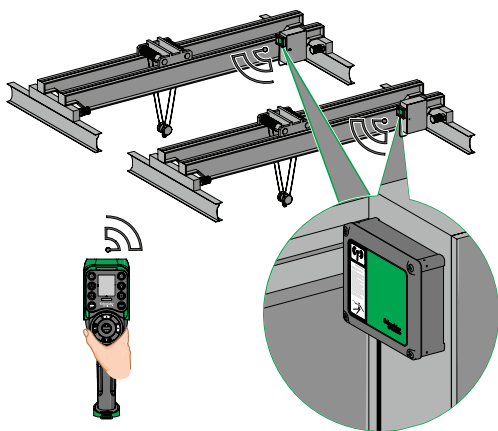

Example of MBC mode



Configuration software window

[1] MBC: Multi base control (tandem)  
[2] Third-party devices cannot communicate with the remote control system.

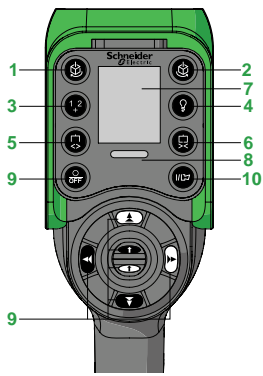

Front view of ZART12D remote device

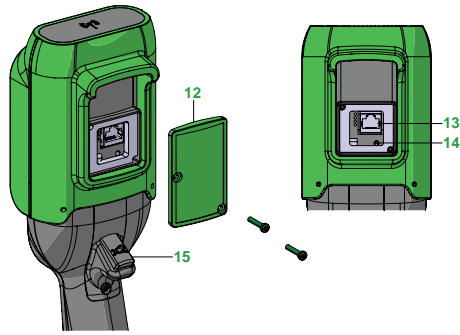

Rear view of remote device

Remote Control Device Description	
1-6	Auxiliary buttons (for ZART8D and ZART8L only buttons 5 and 6 are available)
7	Display (for ZART8L LED display only)
8	E-stop LED
9	OFF/Stop button
10	ON/Start/Horn button
11	Motion buttons
12	Cover
13	RJ45 connector
14	Reset button
15	Trigger button
16	Connector for charging remote device
17	Connector cover
18	E-stop button

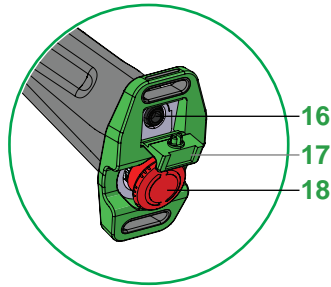

Underside view of remote device handle

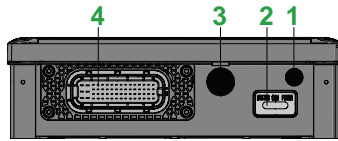

Underside view of ZARB•H base station

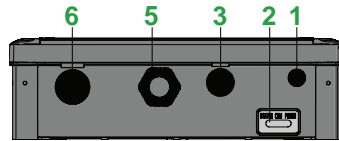

Underside view of ZARB•W base station

Base Station	
1	M12 for external antenna[3]
2	Status LEDs
3	M20 for the Safeguarding function input wires[3]
4	62-pin connector[3]
5	M25 for output wires[4]
6	M25 for detected application alarm input wires[3]
7	4 holes for standard mounting on support [3]

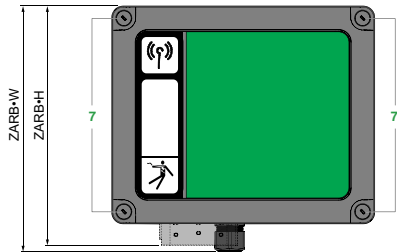

Front view of base station with cover

[3] Covered by an end cap.  
[4] Covered by a cable gland.



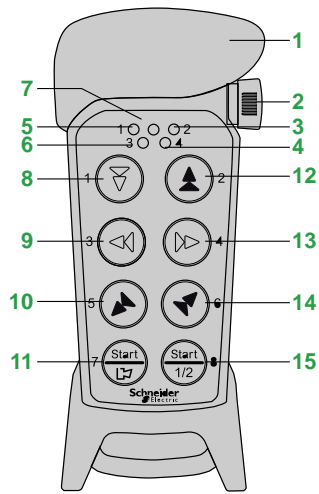

Front view of ZART8LS remote device

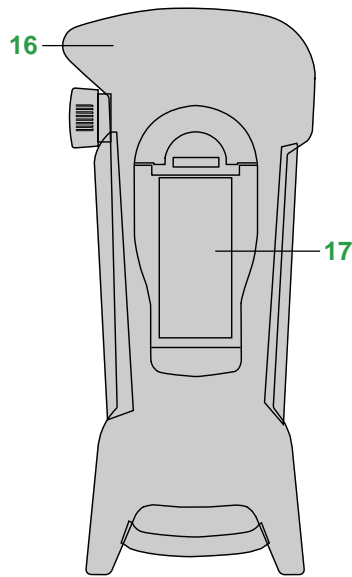

Rear view of remote device

**Remote Control Device Description**

**Front View**

1	Rubber cover
2	Stop button
3	LED 2 (red)
4	LED 4 (red)
5	LED 1 (red)
6	LED 3 (red)
7	Top LED (red, green)
8	Button 1
9	Button 3
10	Button 5
11	Button 7-left start button
12	Button 2
13	Button 4
14	Button 6
15	Button 8-right start button

**Rear View**

16	Rubber protection cover
17	Battery pack

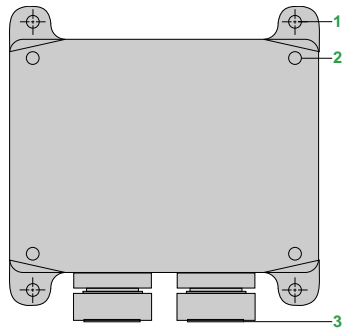

Front view of base station

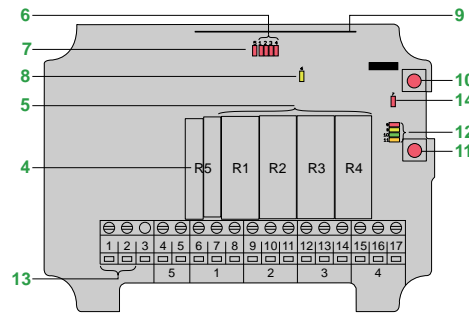

Internal board view of base station

**Base Station**

**Front View**

1	4 x Ø5 mm/0.20 in. holes for standard mounting on a support
2	4 x screws to maintain the cover of the receiver
3	2 x cable glands for cables Ø 6...13 mm/ 0.25...0.50 in.

**Internal Board View**

4	Stop relays
5	Relays R1 ...R4
6	Relay LEDs (red)
7	Stop relay LED (red)
8	Power LED (yellow)
9	Radio module
10	Function button (cancel)
11	Select button (OK)
12	Function LEDs (8 = red, 9 = yellow, 10 = green, 11 = orange)
13	Terminal block for input power
14	PLd (Performance Level d) status LED

**Expansion Board View**

15	Relays R6...R11
16	Relay LEDs (red)
17	Communication LED (green)

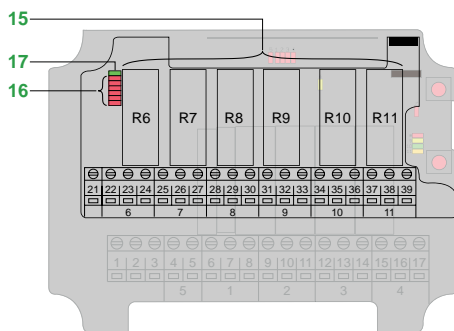

Expansion board view of base station



ZART8L

ZART8D

ZART8LS



ZARB12H

ZARB18W



ZARB10WS



XARS12D18H

Remote Control Device and Base Station

Table 19.377: Remote Control Device

Description	Characteristics		Reference		Weight kg/lb
	Motion push buttons	Auxiliary push buttons	Standard	MBC <sup>[5]</sup>	
With LEDs	6	2	ZART8L	ZART8DM (slave)	0.650/1.433
With display	6	2	ZART8D	ZART8D (master or slave)	0.650/1.433
With display	6	6	ZART12D	ZART12DM (master or slave)	0.650/1.433
With LEDs	6	1	ZART8LS	—	0.300/0.661

Table 19.378: Base Station

Description	Characteristics		Power Supply (V)	Reference		Weight kg/lb
	Outputs	Inputs		Standard	MBC <sup>[5]</sup>	
Wired connection cable gland	12 relays + 2 safety relays	—	~ 24–240	ZARB12W	—	1.450/3.197
Industrial plug connection	12 relays + 2 safety relays	—	~ 24–48	ZARB12H	—	1.450/3.197
Wired connection cable gland	18 relays + 2 safety relays	18 digital (12 limiters + 6 alarms)	~ 24–240	ZARB18W	ZARB18WM	1.450/3.197
Industrial plug connection	18 relays + 2 safety relays	18 digital (12 limiters + 6 alarms)	~ 24–48	ZARB18H	ZARB18HM	1.450/3.197
Wired connection cable gland	10 relays + 2 safety relays	—	~ 48–240	ZARB10WS	—	0.430/0.947
Wired connection (pre-wired with 1.5 m/4.92 ft cable)	10 relays + 2 safety relays	—	~ 48–240	ZARB10WSP	—	0.880/1.940

Table 19.379: Wireless Remote Control

Description	Characteristics		Reference	Weight kg/lb	
	Special Functions	Connection			
Complete unit (without charger device)	—	Wiring	XARS8L12W (ZART8L + ZARB12W) (ZART8L + ZARB12W)	2.100/4.640	
	—	Industrial plug	XARS8L12H (ZART8L + ZARB12H)	2.100/4.640	
	Limiter protection Movement monitoring	—	Wiring	XARS8D18W (ZART8D + ZARB18W)	2.100/4.640
		—	Industrial plug	XARS8D18H (ZART8D + ZARB18H)	2.100/4.640
		—	Wiring	XARS12D18W (ZART12D + ZARB18W)	2.100/4.640
		—	Industrial plug	XARS12D18H (ZART12D + ZARB18H)	2.100/4.640

Kits

Table 19.380: Kits

Description	Characteristics	Reference	Weight kg/lb
	Components		
Starting kit comprising remote control system + accessories + USB/RJ45 cable + configuration software	ZART8L + ZARB12W + ZARC01 + ZARC02 + TCSCMCNAM3M002P	XARSK8L12W	2.800/6.173
	ZART8L + ZARB12H + ZARC01 + ZARC02 + TCSCMCNAM3M002P	XARSK8L12H	2.800/6.173
	ZART8D + ZARB18W + ZARC01 + ZARC02 + TCSCMCNAM3M002P	XARSK8D18W	2.800/6.173
	ZART8D + ZARB18H + ZARC01 + ZARC02 + TCSCMCNAM3M002P	XARSK8D18H	2.800/6.173
	ZART12D + ZARB18W + ZARC01 + ZARC02 + TCSCMCNAM3M002P	XARSK12D18W	2.800/6.173
	ZART12D + ZARB18H + ZARC01 + ZARC02 + TCSCMCNAM3M002P	XARSK12D18H	2.800/6.173

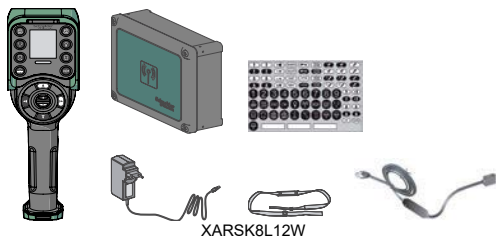

XARSK8L12W

[5] MBC: Multi base control (tandem).

**Accessories**

**Table 19.381: Accessories**

Description	Characteristics	Reference	Weight kg/lb
Charger for remote device	~100–240 V power supply	ZARC01	0.350/0.772
Shoulder belt for remote device	2 m / 6.56 ft length	ZARC02	0.100/0.220
External antenna for Base station [6]	With 2 m / 6.56 ft cable and bracket included	ZARC03	0.200/0.441
Holder for remote device	104 x 239 mm / 4.09 x 9.41 in.	ZARC04	0.250/0.551
Female plug connector	With 1.5 m / 4.92 ft	ZARC05	2.000/4.409
Cable gland kit with wire grommets	1 x M25 + 1 x M20	ZARC06	0.050/0.110
Adhesive label kit for remote device	Black and White	ZARC07	0.150/0.331
Adhesive label kit for remote device and crane equipment	Multicolored	ZARC08	0.250/0.551
Installation kit	Silent block (anti vibration) support	ZARC09	0.825/1.815
	Magnet support	ZARC091	0.625/1.375
Female plug connector	With 3 m / 9.84 ft cable	ZARC12	4.000/8.818
Female plug connector	With 5 m / 16.40 ft cable	ZARC18	7.000/5.432
Connector cable	USB to RJ45	TCSMCNAM3M002P	0.100/0.220
Multi-charger power supply 6W, 5 Vdc / 1.2 A (for ZARC702 Li-Ion rechargeable battery only)	~100–240 V power supply	ZARC701	0.100/0.220
Li-Ion rechargeable battery with battery table charger	83 x 46 mm / 3.268 x 1.811 in.	ZARC702	0.050/0.110
Battery pack for 3 x AAA (batteries not included)	83 x 46 mm / 3.268 x 1.811 in.	ZARC704	0.020/0.044
Battery table charger, (for ZARC702 Li-Ion rechargeable battery only)	5 Vdc power supply	ZARC703	0.120/0.265
Front label cover for ZART8LS push buttons	120 x 60 mm / 4.724 x 2.362 in.	ZARC705	0.005/0.011
Rubber protection cover for ZART8LS	Rubber material, black	ZARC706	0.107/0.24
Shoulder belt to support ZART8LS	Nylon material, black	ZARC707	0.130/0.29
Added features card [7]	Analog input modbus serial line card (Field bus communication analog card)	ZARCFBA01	0.144/0.317
Network communication card [7]	Sigfox connectivity (Preventive maintenance data gateway)	ZARCIOT01	0.05/0.110

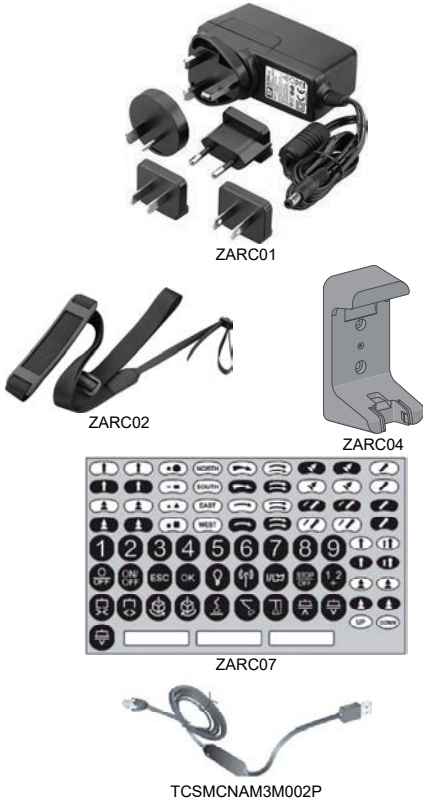

[6] This accessory can be used to increase the radio range in severe environment conditions.

[7] Compatible only with XARS12D18W, XARSK8D18W, ZARB12W, ZARB18W, ZARB18WM, ZARB12WR, ZARB18WR, ZARB18WRM base stations are not compatible with ZART8L remote control device.

### Type BW Pendant Stations and Accessories

This pre-assembled, two-button station now comes complete with internal and external strain relief. Oversized finger grips on the rear of the enclosure make it easy to grip and operate.

- Well suited for standard hoist applications
- Push button legend inserts
- Field-installable mushroom button
- Full cover gasket, to exclude harmful contaminants

**Table 19.382: BW90 and BW100 Pendant Stations – with cord connector and strain relief**

Description	Legend Insert Markings	Mechanical Interlock	Enclosure Color			Contact Symbol	Replacement Interior [8]		
			Yellow	Black	Red		9001 Type	Contact Symbol	
 BW90 / BW100	Single Speed	Up-Down	Yes	BW92Y	BW92B	BW92R	146	BOC368	146
		Forward-Reverse	Yes	BW93Y	BW93B	BW93R	146	BOC368	146
		On-Off [9]	Yes	BW94Y	BW94B	BW94R	10	BOC358	147
		Start-Stop	No	BW95Y	BW95B	BW95R	145	BOC359	25
		Start-Stop [9]	Yes	BW96Y	BW96B	BW96R	10	BOC358	147
		On-Off [9]	No	BW97Y	BW97B	BW97R	146	BOC359	25
		Up-Down	Yes	BW98Y	BW98B	—	100	—	—
		without Inserts	Yes	BW90YU	BW90BU	BW90RU	147	BOC366	25
		without Inserts	No	BW91YU	BW91BU	BW91RU	25	BOC359	25
		without Inserts [9]	Yes	BW94YU	BW94BU	BW94RU	147	BOC358	147
Two Speed	without Inserts	Yes	BW100YU	BW100BU	BW100RU	150	BOC367	150	
	Up-Down	Yes	BW102Y	BW102B	BW102R	150	BOC367	150	

**Table 19.383: Hanger Brackets**

Description	Form
 External Bracket (cannot be field installed) Y236	Y236

**Table 19.385: Interchangeable Legend Inserts for Type BW Pendant Stations [10]**

Marking	Type
Start	B259
Stop	B260
Forward	B255
Reverse	B256
Open	B263
Close	B264
Raise	B261
Lower	B262
Up	B253
Down	B254
On	B257
Off	B258
Blank - black	B251
Blank - red	B252

**Table 19.384: Strain Relief Replacement**

Description	Type
 Strain Relief Replacement BWSR	BWSR

**Table 19.386: Replacement Enclosures**

Description	Color	Type
Box & Cover with 4 screws	Yellow	BWRY
	Red	BWRR
	Black	BWRB

**Table 19.387: Electrical Contact Ratings [11]**

Volts	AC—NEMA B600					DC—NEMA P600		
	Inductive 35% Power Factor				Continuous Carrying Amperes	Resistive 75% Power Factor	Inductive and Resistive	
	Make		Break				Make and Break Amperes	Continuous Carrying Amperes
	A	VA	A	VA				
120	30.5	3600	3.75	360	5	5	1.1	5
240	15	3600	1.5	360	5	5	0.55	5
480	7.5	3600	.75	360	5	5	0.2	5
600	6	3600	.6	360	5	5		5

### Contact Symbols (Type BW Pendant Stations)

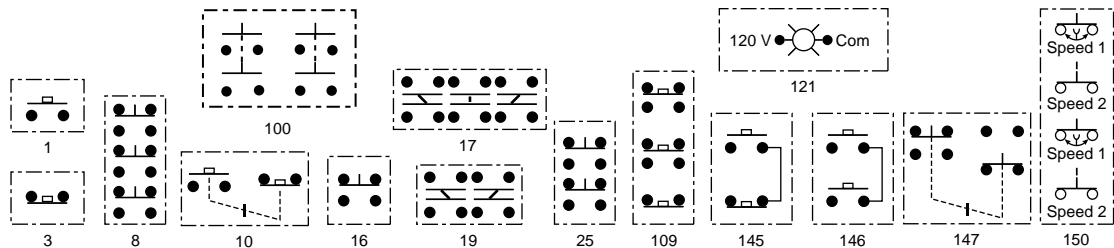

[8] Includes gasket

[9] Maintained Contact

[10] Order must specify a quantity of 10 or multiples of 10.

[11] OSHA Regulation, Section 1910.70, Overhead and Gantry Cranes, limits the voltage of pendant push buttons to 150 Vac or 300 Vdc.

**XAC Pistol Grip Stations and General Purpose Pendants**

XAC pendant stations are designed for standard- or medium-duty control circuit applications.

- Single- or two-speed versions
- Double insulated
- Shock and corrosion resistant
- 2, 4, 6, 8, 12 element versions
- Ease of operation

**Table 19.388: Pistol Grip Stations**

Description	Speeds	Function		Catalog Number
		1 speed	2 speed	
1 N.O. contact per operator 2 Mechanically interlocked operators	1	↑ ↓		XACA201 [12]
2 N.O. (staggered) contacts per operator 2 Mechanically interlocked operators	2		↑ ↓	XACA207 [12]
1 N.O. + 1 N.C. 2 Mechanically interlocked operators	1	↑ ↓		XACA205 [12]
1 N.O. contact per direction 1 Mechanically interlocked 2 way toggle	1	↑ ↓		XACD21A0101 [13]
1 N.O. + 1 N.O. staggered 1 Mechanically interlocked 2 way toggle	2		↑ ↓	XACD21A1231 [13]
1 N.O. & 1 N.C. contact per direction 1 Mechanically interlocked 2 way toggle	1	↑ ↓		XACD21A0105 [13]
1 N.C. + 1 N.O. + 1 N.O. staggered 1 Mechanically interlocked 2 way toggle	2		↑ ↓	XACD21A1241 [13]

NOTE: Legends are required to achieve NEMA4 rating.



XACA201



XACA06



XACA03 with operators

**Table 19.389: General Purpose Pendants [14][15]**

Enclosures	Catalog Number
2 hole enclosure	XACA02H7
3 hole enclosure	XACA03H7
4 hole enclosure	XACA04H7
6 hole enclosure	XACA06H7
8 hole enclosure	XACA08H7
12 hole enclosure	XACA12H7

To place a custom pendant order, use the worksheet **Type XACA Worksheet**, page 19-136 as a guide. Orders must be placed through the Product Selector in Quote to Cash. There is a 10% charge for assembly.

**XAC Contact Blocks**

**Table 19.390: Contact Blocks for Operators in Cover**

Description	Wiring Diagram	Catalog Number
1 N.O./spring return/1 speed	—	ZB2BE101
1 N.C./spring return/1 speed	—	ZB2BE102
1 N.O. early close & 1 N.C. & 1 N.O./spring return/2 speed	Figure 1	XENG1191
1 N.C. & 2 N.O./spring return/1 speed	Figure 2	XENG1491
1 N.O. & 1 N.O. latching/1 speed/interlocked	Figure 3	XENG3781
1 N.O. & 1 N.C. latching/1 speed/interlocked	Figure 4	XENG3791
3 N.C.—all direct acting	Figure 5	XENT1192

**Table 19.391: Contact Blocks for Operators in Base of Enclosure [16]**

Description	Catalog Number
1 N.O./1 speed	XACS101
1 N.C./1 speed	XACS102
2 N.O./1 speed	XACS103
2 N.C./1 speed	XACS104
1 N.O. & 1 N.C./1 speed	XACS105

**Wiring Diagrams**

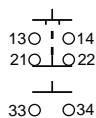

Figure 1

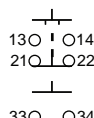

Figure 2

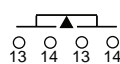

Figure 3

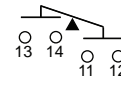

Figure 4

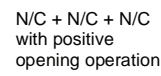
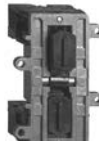

Figure 5



ZB2BE10



XENG37



XENG1191



XACS10

[12] These units are available with factory installed E-stops. Add a "3" to the end of the catalog number for standard E-stop or add a "4" for a trigger action E-stop.

[13] These units are available with a factory installed E-stop. Use XACD22 \*\*\* for a standard E-stop or XACD24\*\*\* for a trigger action E-stop.

[14] Standard enclosures include internal mounting plate, cable sleeve for 8 to 26 mm, internal cable clamp, suspension ring and cable tie.

[15] For ordering information on custom built XACA pendants, visit our website at www.Schneider-Electric.us.

[16] Cannot be used with XACA03 pendant.

XAC Operators and Accessories

Table 19.392: Operators [17]



Booted Push Button

Description	Color	Catalog Number
Booted push button	White	XACA9411
	Black	XACA9412
	Green	XACA9413
	Red	XACA9414
	Yellow	XACA9415
	Blue	XACA9416
	Brown	XACA9419

Table 19.393: Mushroom Operators



Mushroom Head

Description	Mushroom Size	Color	Catalog Number
Mushroom head, push to maintain/turn-to-release (trigger action)[18]	30 mm	Red	ZA2BS834
	40 mm	Red	ZA2BS844
Mushroom head, push to maintain/key turn-to-release (trigger action)[18]	40 mm	Red	ZA2BS944

Table 19.394: Selector Switches and Wobble Stick



Selector Switch



Selector Switch (Key operated)

Description	Color	Catalog Number
Selector switch/2 position—maintained[19]	Black	ZA2BD2
Selector switch/3 position—maintained[19]	Black	ZA2BD3
Selector switch/2 position—maintained key operated—key removal from LT or RT position[19]	NA	ZA2BG4
Selector switch/3 position—maintained key operated—key removal from LT or RT position[19]	NA	ZA2BG5
Wobble stick (bottom mounting recommended)	Black	ZA2BB2

Table 19.395: Pilot Light Components

Description	Color	Catalog Number
Direct supply base/without lamp (for 6 to 120 V applications) (AC/DC) [20]	—	ZB2BV006

Table 19.396: Enclosure Accessories

Description	Catalog Number
Blank hole plug	ZB2SZ3
Mechanical interlock (momentary). For use with XAC booted operators only	XACA009
Screw adapter for self-supporting cable	XACB961
Low suspension ring for single row station	XACA971
Protective guard for bottom mounted mushroom head	XACA982
Protective guard for bottom mounted selector switch or key switch	XACA983

Table 19.397: Lamps, BA9s Base

Type	Voltage	Watts	Catalog Number
Replacement bulbs (Type BA9s) Incandescent	6 Vac/Vdc	1.2	DL1CB006
	12 Vac/Vdc	2.0	DL1CE012
	24 Vac/Vdc	2.0	DL1CE024
	48 Vac/Vdc	2.4	DL1CE048
	130 Vac/Vdc	2.6	DL1CE130

Table 19.398: LED, BA9s Base

Type	Color	Voltage	Catalog Number
LED, BA9s base for Direct Supply blocks	Green	6 Vac/Vdc	DL1CJUS0063
	Red	6 Vac/Vdc	DL1CJUS0064
	Amber	6 Vac/Vdc	DL1CJUS0065
	Green	24 Vac/Vdc	DL1CJUS0243
	Red	24 Vac/Vdc	DL1CJUS0244
	Amber	24 Vac/Vdc	DL1CJUS0245
	White	24 Vac/Vdc	DL1CJUS0241
	Blue	24 Vac/Vdc	DL1CJUS0246
	Green	120 Vac/Vdc	DL1CJUS1203
	Red	120 Vac/Vdc	DL1CJUS1204
	Amber	120 Vac/Vdc	DL1CJUS1205

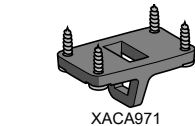

XACA971

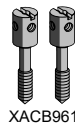

XACB961

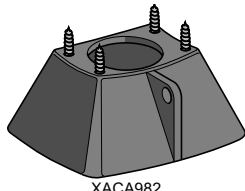

XACA982



DL1CE0\*\* (Incandescent)

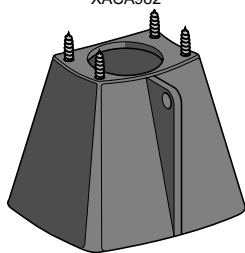

XACA983

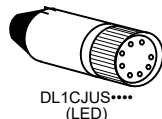

DL1CJUS\*\*\*\* (LED)

[17] Booted push buttons are for cover mounting only. All other operators can be mounted on cover or bottom.  
 [18] Trigger action mushroom heads are tamper proof in that a change of contact state is not possible by teasing or floating the operator.  
 [19] Not for use with XENG contact blocks.  
 [20] see Table 19.397 Lamps, BA9s Base, page 19-134 and LED, BA9s Base, page 19-134.

**Table 19.399: PVC Standard Legend Plates 30 x 40 mm**

Text <sup>[21]</sup>	Catalog Number	Text <sup>[21]</sup>	Catalog Number	Text <sup>[21]</sup>	Catalog Number
Bridge Forward	ZB2BY2343	Left	ZB2BY2310	Stop	ZB2BY2304
Bridge Reverse	ZB2BY2344	Low	ZB2BY2336	Stop Start	ZB2BY2366
Close	ZB2BY2314	Lower	ZB2BY2337	Trolley Right	ZB2BY2345
Down	ZB2BY2308	Man Auto	ZB2BY2372	Trolley Left	ZB2BY2346
Emergency Stop	ZB2BY2330	Off	ZB2BY2312	Up	ZB2BY2307
Fast	ZB2BY2328	On	ZB2BY2311	Up Down	ZB2BY2370
Forward	ZB2BY2305	Off On	ZB2BY2367	Up-O-Down	ZB2BY2389
For Rev	ZB2BY2371	Open	ZB2BY2313	North	6516002379
For-O-Rev	ZB2BY2384	Open Close	ZB2BY2376	South	6516002380
Hand Off Auto	ZB2BY2387	Open-O-Close	ZB2BY2388	East	6516002381
High	ZB2BY2338	Out	ZB2BY2339	West	6516002382
High Low	ZB2BY2369	Power On	ZB2BY2326		
Hoist Down	ZB2BY2342	Raise	ZB2BY2335		
Hoist Up	ZB2BY2341	Reset <sup>[21]</sup>	ZB2BY2323		
In	ZB2BY2503	Reverse	ZB2BY2306		
Inch	ZB2BY2321	Right	ZB2BY2309		
Jog For	ZB2BY2381	Run	ZB2BY2334		
Jog Rev	ZB2BY2380	Slow	ZB2BY2327		
Jog Run	ZB2BY2365	Start	ZB2BY2303		

Type	Description	Background Color	Catalog Number
PVC blank legend	Blank	Black or red background—30 mm x 40 mm	ZB2BY2101
	Blank	Yellow or white background—30 mm x 40 mm	ZB2BY4101
PVC custom engraved	Special engraving <sup>[22]</sup>	Black background, white letters—30 mm x 40 mm	ZB2BY2002
	Special engraving <sup>[22]</sup>	White background, black letters—30 mm x 40 mm	ZB2BY4001

[21] All nameplates are black with white lettering except "Stop", "Emergency Stop" and "Reset" which are red with white lettering.

For black "Reset" change final digit of catalog number to 2.

[22] Please specify lettering when ordering. Two lines with 11 characters (including spaces) maximum on each plate.

### Type XACA Worksheet

Use this worksheet to assist in component selection. Custom orders for XACA pendant stations must be placed through the Product Selector in Quote to Cash. There is a 10% charge for assembly.

### XACA Order Guide Instructions

Custom built pendant stations

1. Determine the number of operators needed, then choose an enclosure with a corresponding number of holes.
2. Select the type of operator, contact block, and appropriate nameplate for each function required.
3. Check for special functions that may be required. These items could include mechanical interlocks, adapters for self-supporting cable, lower support rings, protective guards, etc.

Functions (optional)	Catalog number of enclosure	XACA <input type="checkbox"/> <input type="checkbox"/> <input type="checkbox"/> <input type="checkbox"/>			
	Mechanical interlock (draw a vertical line between the 2 units to be interlocked ▲)	Legends	Contact blocks and pilot light bodies	Push button Pilot light or Blanking plug	
	1				
	2				
	3				
	4				
	5				
	6				
	7				
	8				
	9				
	10				
	11				
	12				

▲ Mechanical interlock XACA009 Number of XACA009 required

Unit mounted in base of station (facing downwards)

	13		
--	----	--	--

#### Attachments

Position	Type	Catalog No.
14	Adapters for self-supporting cable type BBAP (available only with cable sleeve Ø8–26 mm)	XACB961
15	Lower support ring	XACA971
16	Protective guard for base mounted selector switch or 40 mm emergency-stop push button	XACA982
17	Protective guard for key switch	XACA983

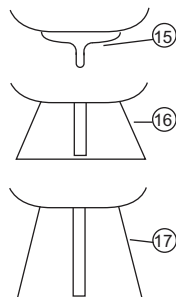
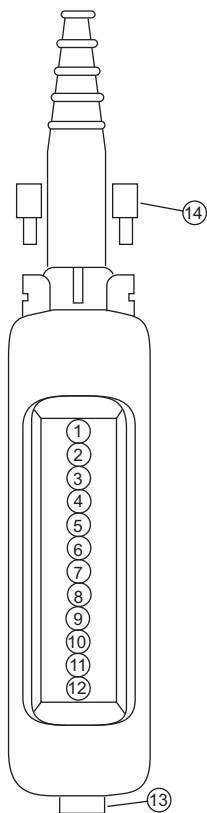

Mechanical Interlock (XACA009)

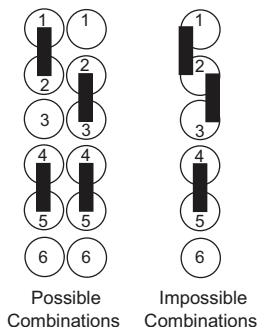



**Pendant Station Application and Ordering Information**

This line of pendant stations consists of polymeric enclosures (2 through 10 units), push button units (1 through 5 speed) and laminated legend plates. All enclosures have an extra single unit space near the top which permits the installation of a toggle switch, a Type SK operator or pilot light, or a warning label. All enclosures come with a stainless steel hanger bracket and internal strain relief post. Enclosures are yellow and have a threaded opening in the top.

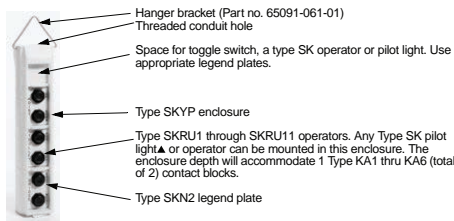
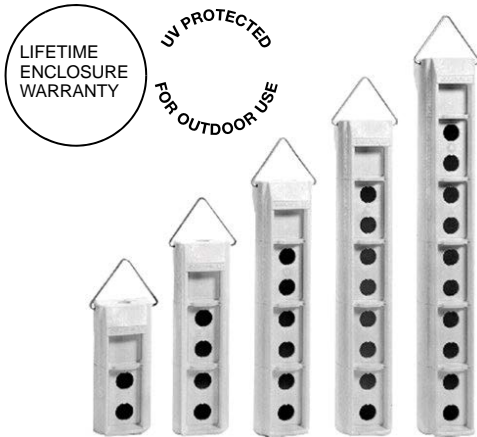

▲ Class 9001 SK push-to-test pilot lights and remote test pilot lights will not fit in these enclosures.

**Table 19.400: Enclosure Catalog Numbers**

Number of Buttons	Conduit Entrance Size	Enclosure Only [23]	Enclosure for Assembled Station [24]
		Catalog Number	Catalog Number
2	3/4"-14 NPT	SKYP2	SKYP20
4	3/4"-14 NPT	SKYP4	SKYP40
6	1"-11 1/2 NPT	SKYP6	SKYP60
8	1 1/4"-11 1/2 NPT	SKYP8	SKYP80
10	1 1/4"-11 1/2 NPT	SKYP10	SKYP100

**Table 19.401: Push Button Units**

Number of Buttons per Unit	Description	Contact Symbol	Catalog Number [25]
2	Single Speed – Momentary Interlocked	7	SKRU1[26]
2	Single Speed – Momentary Non-Interlocked	5	SKRU10[26]
2	Single Speed – Maintained Interlock	10	SKRU11[26]
2	Two Speed – Momentary Interlocked	87	SKRU2[27]
2	Three Speed – Momentary Interlocked	88	SKRU3[27]
2	Four Speed – Momentary Interlocked	89	SKRU4[27]
2	Five Speed – Momentary Interlocked	90	SKRU5[27]

**Table 19.402: Legend Plate Catalog Numbers**

Where Used	Marketing	Catalog Number
For SKRU1 through SKRU11	Blank-Blank	SKN200[28]
	Hoist: Up-Down	SKN201
	Trolley: East-West	SKN202
	Trolley: Fwd.-Rev.	SKN203
	Trolley: North-South	SKN204
	Bridge: Fwd.-Rev.	SKN205
	Bridge: East-West	SKN206
	Bridge: North-South	SKN207
	Start-Stop	SKN208
	Reset-Stop	SKN209
Aux Hoist: Up-Down	SKN210	
Power: On-Off	SKN211	
	Specify Marking	SKN299[28]
With toggle switch [29] in top space of enclosure	Blank	SKN500[30]
	Off-On	SKN544[30]
	On-Off	SKN545[30]
	Specify Marking	SKN599[30]
With 9001SK [31] operator or pilot light in top space of enclosure	Blank	SKN100[32]
	On	SKN103
	Off	SKN104
	Emerg. Stop	SKN105
	Run	SKN124
	Power On	SKN138
	Off-On	SKN144
	Specify Marking	SKN199[32]

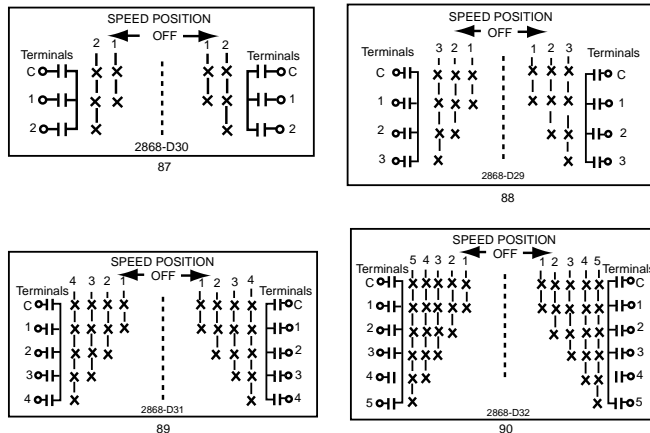

**Figure 19.1: Multispeed Contact Symbols (X = Contact Closed)**

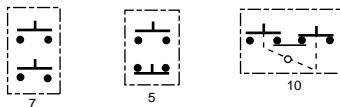

**Figure 19.2: Single Speed Contact Symbols**

**Table 19.403: Closing Plate Catalog Number**

Catalog Number
SK52

[23] Class 9001 SK push-to-test pilot lights and remote test pilot lights will not fit in these enclosures.  
 [24] Assembled pendant stations consist of an enclosure, operators and legend plates. All custom orders must include the pendant key sheet. See Type XACA Worksheet, page 19-136.  
 [25] Types SKRU 1, 10 and 11 use Type KA contact blocks. Types SKRU 2 thru 5 are factory enclosed contact blocks.  
 [26] Boot part number is 9001KU1.  
 [27] Boot part number is 9001KU37.  
 [28] 19 characters each side max.  
 [29] Can be supplied by Square D as Class 9001 Type SKTS1- includes boot for NEMA Type 4X.  
 [30] Includes legend plate, gasket and ground plate to be used with toggle switch.  
 [31] See 9001SK, page 19-82 through page 19-89  
 [32] Tri-laminated legend plate having a yellow or red background on a black core.

Type SKYP Worksheet

	<b>Control Products</b>	Use this worksheet to assist in component selection. SKYP Custom Pendant orders must be placed through the Product Selector in Quote to Cash. There is a 10% charge for assembly.
Class <b>9001</b>		Type <b>SKYP -</b> _____

1. Operator or Closing Plate.  
Example - SKRU1
2. Legend Plate Type Number  
Example - SKN201
3. Legend Plate Marking ▲  
– Used Only if Special Marking is Required  
Example:  
Line 2 - SKN299  
Line 3 - A.) Hoist  
          B.) FWD  
          C.) REV

When operator and legend plate use 2 adjacent holes - specify same in both locations. Example:

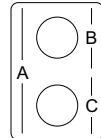

- |   |        |
|---|--------|
| 1 | SKRU1  |
| 2 | SKN201 |
| 3 |        |
- 
- |   |        |
|---|--------|
| 1 | SKRU1  |
| 2 | SKN201 |
| 3 |        |

TYPE NUMBER KEY

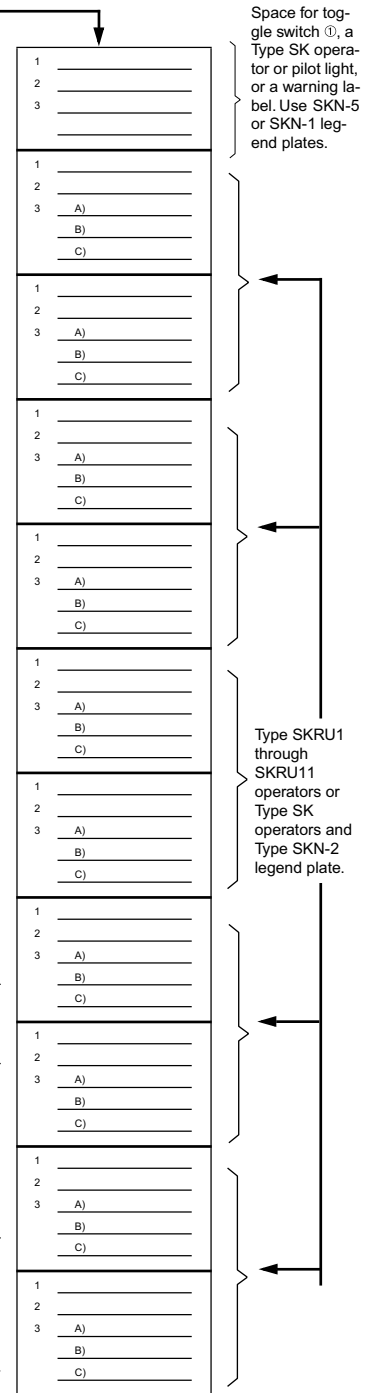

ENCLOSURES – NEMA 4X, 13

Size	Conduit Entrance Size	Enclosure for Assembled Station ▲
		Catalog Number
2 Button	3/4" -14 NPT	SKYP20
4 Button	3/4" -14 NPT	SKYP40
6 Button	1" -14 NPT	SKYP60
8 Button	1 1/4" -11 1/2	SKYP80
10 Button	1 1/4" -11 1/2	SKYP100

▲ Assembled pendant stations consist of an enclosure, operators, and legend plates.

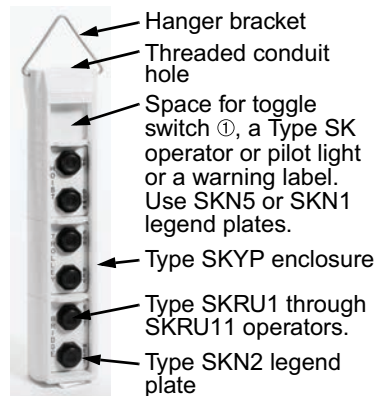

PUSH BUTTON UNITS – NEMA / UL 4X, 13

Number of Buttons per Unit	Description	Contact Symbol	Type
2	Single Speed - Momentary Interlocked	7	SKRU1
2	Single Speed - Momentary Non-Interlocked	5	SKRU10
2	Single Speed - Maintained Interlocked	10	SKRU11
2	Two Speed - Momentary Interlocked	87	SKRU2
2	Three Speed - Momentary Interlocked	88	SKRU3
2	Four Speed - Momentary Interlocked	89	SKRU4
2	Five Speed - Momentary Interlocked	90	SKRU5

LEGEND PLATES – NEMA / UL 4X, 13

Where Used	Marking	Catalog Number
For SKRU1 through SKRU11	Blank-Blank Hoist: Up-Down Trolley: East-West Trolley: Fwd.-Rev. Trolley: North-South Bridge: Fwd.-Rev. Bridge: East-West Bridge: North-South Start-Stop Reset-Stop Specify Marking	SKN200④ SKN201 SKN202 SKN203 SKN204 SKN205 SKN206 SKN207 SKN208 SKN209 SKN299④
With Toggle Switch ① in Top Space of Enclosure	Blank Off-On On-Off Specify Marking	SKN500 ② SKN544 ② SKN545 ② SKN599 ②
With Type SK Operator ▲ or Pilot Light in Top Space of Enclosure	Blank On Off Emerg. Stop Run Power On Off-On Specify Marking Specify Marking (Red Background)	SKN100 ③ SKN103 SKN104 SKN105 SKN124 SKN138 SKN144 SKN199 ③ SKN199R ③

CLOSING PLATE

Type
SK52

The price of the total station consists of the price of each individual component plus a 10% charge for assembly.

- ① Available as 9001SKSTS1
- ② Includes legend plate, gasket and ground plate to be used with toggle switch.
- ③ Tri-laminated legend plate having a yellow or red background on a black core.
- ④ 19 characters each side.
- ▲ Class 9001 Type SK Push-To-Test Pilot lights and Remote Test Pilot lights will not fit in these enclosures.

Heavy Duty Industrial Foot Switches—Oiltight, Watertight, Dusttight and Driptight Enclosure, NEMA 2, 4 and 13

**⚠ DANGER**

**HAZARDOUS APPLICATIONS**

Do not use foot switches on machines without point-of-operation protection.

**Failure to follow these instructions will result in death, serious injury, or equipment damage.**



AW2  
Type AW Foot Switch with Top Pedal Shield and Side Shields



AW132  
Type AW with Oversized Pedal Shield and Side Shields



AW117  
Type AW with Oversized Pedal Shield, Side Shields and Safety Door



AW1  
Type AW Foot Switch without Pedal Shield



AW124

**Type AW Fully Shielded Foot Switch with Oversized Pedal Shield, Side Shields and Safety Door.** The Safety Door is interlocked with the pedal to prevent operation due to shock or vibration. It prevents accidental pedal operation by requiring a simple but intentional motion to lift the door before inserting the foot.

**Operating Temperature:**  
-30 to +60 °C (-22 to +140 °F)

**Foot Switch Selection**

Foot switches are used to control many industrial processes, while leaving the operator's hands free to perform other functions. The type or model of foot switch suitable for each application will vary depending on factors such as the control function required, degree of protection required, production methods, unusual conditions, government regulations, etc. In some applications more than one foot switch may be required, as when two or more persons are operating a machine. In these cases, safe practice and regulations require that the foot switches be wired in series making it necessary that each operator's foot switch be actuated before the machine will cycle.

Only the user can be aware of all the conditions and factors present during setup, operation and maintenance of the machine; therefore, only the user can determine which foot switch(es) can be properly used. When selecting a foot switch for a particular application, the user should refer to the applicable ANSI standards and OSHA regulations. The National Safety Council's Accident Prevention Manual also provides much useful information.

In some applications, such as power presses, additional operator protection such as point-of-operation guarding must be provided when a foot switch is used as an actuator. This is necessary since the operator's hands and other parts of the body are free to enter the pinch point area and serious injury can occur. The shielding provided on foot switches cannot protect an operator from injury. For this reason the foot switch cannot be substituted for or take the place of point-of-operation protection.

A Trilingual Danger Sign regarding the need for point-of-operation protection is supplied with each foot switch. The sign incorporates three languages: English, Spanish and French. Additional copies of the sign are available by contacting your Square D sales office.

**Table 19.404: Foot Switch Catalog Numbers [1]**

Description	Features	Fully Shielded with Oversized Pedal Shield, Side Shields and Safety Door	With Oversized Pedal Shield and Side Shields	With Pedal Shield and Side Shields	UNSHIELDED (See Warning note[2])
		Catalog Number	Catalog Number	Catalog Number	Catalog Number
Single Pole [3] Double Throw	Spring Return With Mechanical Latch	AW117	AW132	AW2 AW7	AW1
Two Pole [3] Double Throw	Spring Return With Mechanical Latch	AW124 [4]	AW133	AW14 AW15	AW13
Two Stage [3] (One Pole Each Stage) Table 1	Spring Return With Mechanical Latch in 1st Stage With Mechanical Latch in 2nd Stage	AW119	AW134	AW6 AW9 AW10	AW5
Four Stage [3] (One Pole Each Stage) Table 2	Spring Return	AW123	—	AW22	AW21
Single Pole Single Throw	Maintained Contact—Push On/Push Off	—	—	AW12	AW11
Replacement Cover Assembly	—	AC5	AC7	AC8 [5]	AC1



File: E78403  
CCN: NKCR



File: LR25490  
Class: 3211-03

For **replacement parts** for Class 9002 Type AW: See instruction bulletin 65013-010-31. Also see Table 19.406 Contact Symbol—Two Stage, page 19-140 and Table 19.407 Contact Symbol—Four Stage, page 19-140.

[1] When ordering, add prefix "9002" to the catalog number.  
 [2] **WARNING:** These foot switches must not be used to operate machines or equipment where the possibility of operator injury exists. Typical uses include Emergency Stop functions, "Dead Man" controls, signal functions (lights, bells, etc.).  
 [3] A single pole snap switch that contains two double break contact elements (1 N.O. and 1 N.C.) must be used on circuits of same polarity. A double pole snap switch contains two electrically separated sets of contact elements allowing use on circuits of opposite polarity. Each set that contains two double break contact elements (1 N.O. and 1 N.C.) must be used on circuits of same polarity.  
 [4] 2 N.O. and 2 N.C. isolated, direct acting contacts.  
 [5] For replacement cover drilled to accept latch. For Series C foot switches order AC9. No replacement cover available for Series A or B devices drilled to accept latch. AC8 is spring return only.

Approximate Dimensions

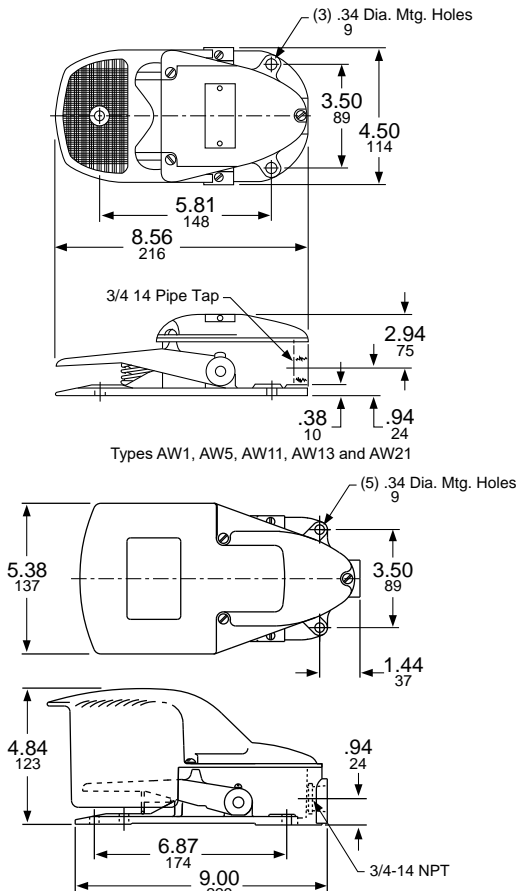

Types AW1, AW5, AW11, AW13 and AW21

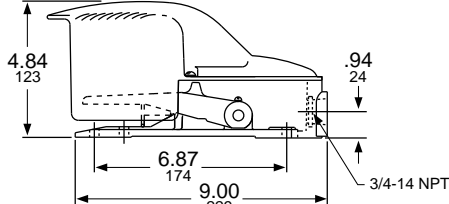
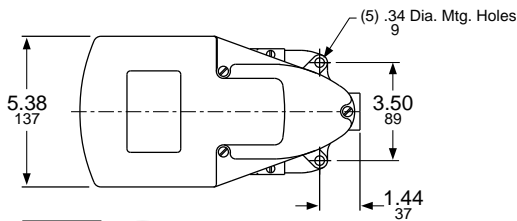

Types AW2, AW6, AW12, AW14 and AW22

Dual Dimensions: INCHES  
Millimeters

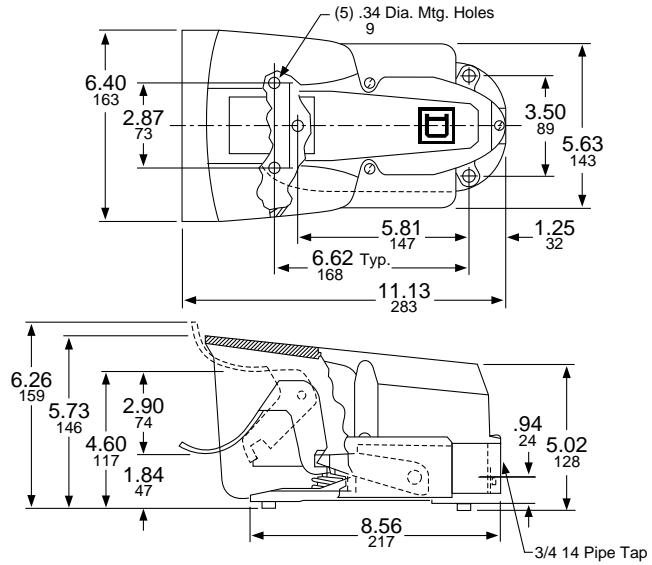

Types AW117, AW119, AW123, AW124  
Types AW132, AW133 and AW134 (without safety door)

Table 19.405: Maximum Current Ratings For Control Circuit Contacts

Type	Volts	AC Amperes			Volts	DC Amperes		
		Inductive 35% Power Factor		Resistive 75% Power Factor		Inductive and Resistive		
		Make	Break			Make and Break	Single Throw	Double Throw
AW1 through AW10, AW117, AW119, AW132	120	40	15	15	125	2.0	0.5	15
	240	20	10	10	250	0.5	0.2	15
	480	10	6	6	600	0.1	0.02	15
	600	8	5	5				
AW13, AW14, AW15, AW133	120	30	3	3	125	1.0	0.2	10
	240	15	1.5	1.5	250	0.3	0.1	10
	480	7.5	0.75	0.75	600	0.1	—	10
	600	6	0.6	0.6				
AW11, AW12	115	36	6	—	125	2.2	—	—
	230	18	3	—	250	1.1	—	—
AW21, AW22, AW123	120	15.0	1.5	10	—	—	—	—
	240	7.5	0.75	10	—	—	—	—
	480	3.75	0.375	10	—	—	—	—
	600	3.0	0.3	10	—	—	—	—
AW124	120	60	6	10	120	1.1	—	10
	240	30	3	10	240	0.55	—	10
	480	15	1.5	10	600	0.2	—	10
	600	12	1.2	10				

NOTE: Double throw switches are rated 250 Vdc maximum.

Table 19.406: Contact Symbol—Two Stage

Unit	Snap Switch		Pedal		
	Circuit	Up	Half Down	Full Down	Full Down
1	A1	0	1	1	1
	B1	1	0	0	0
2	A2	1	1	0	0
	B2	0	0	1	1

NOTE: 0 = Open 1 = Closed

Table 19.407: Contact Symbol—Four Stage

Unit	Snap Switch		Pedal Position			
	Circuit	Up	Up → Down	Down	Down	Down
1	1A1	0	0	1	1	1
	1B1	1	1	0	0	0
	2A1	0	1	1	1	1
	2B1	1	0	0	0	0
2	1A2	1	1	1	0	0
	1B2	0	0	0	1	1
	2A2	1	1	1	1	0
	2B2	0	0	0	0	1

**Class 9003**  
**Type K Rotary Cam Switches**

Applications		Used in building control panels and consoles, Type K cam switches allow control of processes and utilities in industry and buildings, and direct control for simple machines.					
							
Functions	Off-On/On-Off switches	1 to 6-pole	1 to 6-pole				
	Stepping switches	2 to 12-position, 1 to 4-pole	—				
	Changeover switches	1 to 5-pole	1 to 4-pole				
	Measurement switches	Voltmeter and ammeter	—				
	Reversing switches	2 and 3-pole	2 and 3-pole				
	Reversing star-delta switches	Star-delta	Star-delta				
	Pole change switches	2 and 3-speed	2-speed				
Conventional rated thermal current (Ith)		20 A	32 A	50 A	63 A	115 A	150 A
Electrical operating characteristics		690 V	690 V	690 V	690 V	690 V	690 V
		AC-3 - 3-phase	AC-3 - 3-phase	AC-3 - 3-phase	AC-3 - 3-phase	AC-3 - 3-phase	AC-3 - 3-phase
		230 V - 2.2 kW - 8.3 A	230 V - 5.5 kW	230 V - 7.5 kW	230 V - kW	230 V - 5 kW	230 V - 22 kW
		AC - 15	AC - 15	AC - 15	—	—	—
		230 V - 4 A	230 V - 14 A	230 V - 6 A	—	—	—
Front plate degree of protection		IP 40 IP 65 (with seal)	IP 40				
Product Composition		Complete switches and custom Adaptable sub-assemblies	Complete switches				
Compatibility		Ø 22 control and signalling units					
Mounting	Front Mounting	Multi-fixing Single Ø 22 hole	By 4 holes on 48 mm centers			By 4 holes on 68 mm centers	
	Rear Mounting	Screw fixing, 4 holes on 36 mm centers	Screw fixing, 4 holes on 48 mm centers			Screw fixing, 4 holes on 68 mm centers	
Front plate dimensions (mm)		45 x 45 60 x 60 (adaptable sub-assemblies)	64 x 64			88 x 88	
Operating heads		Black and red standard and long handles	Black standard handle Metallic legend, black marking				
		Key operator					
		Metallic head					
		Metallic legend with black marking or black legend with white marking					
Approvals		UL-CSA EN/IEC 60947-3 EN/IEC 60947-5-1	cULus EN/IEC 60947-3				
Type		Type K2	Type K30–K150				
Cam switch model [1]		Class 9003, K2	K30	K50	K63	K115	K150

[1] Incomplete part numbers. Contact your local supplier for assistance.

### Instructions for 9003K2 Key Sheet

The Key Sheet for ordering a 9003K2 cam switch is on [page 19-143](#), and an example of a completed key sheet is on [page 19-144](#). The instructions below are for filling out the key sheet on [page 19-143](#).

1. Select the box for K2 (20 A).
2. Identify the Product quantity in the box provided.
3. Verify front mounting by selecting the box: Front Mounting.
4. If ordering a base/contact block only, select 22 mm plastic or 22 mm metal mounting. Then complete the following:
  - a. ③ Switching Angle (positions)
  - b. ④ Contact scheme and jumpers (pre-wired)
5. If ordering a complete switch (base/contact block, head, legend), check the box. Then complete the following:
  - a. ① Operating head preference
  - b. ② Legend preference
  - c. ③ Switching angle (positions)
  - d. ④ Contact scheme and jumpers (pre-wired)
6. Operating head preference ① (identify the operating head preferred)
7. Legend preference ② (identify the legend preference)
8. Switching angle (positions) ③ and special legend marking
  - a. Identify whether the switch need is 30° or 60°, or 45° or 90° switching angle.
  - b. Fill in the legend markings desired at the positions indicated. Zero degrees is always straight up.
9. The rotation of the operator stops clockwise at the top or 0° position. If full rotation through 360° is desired, the Full rotation through 360° box must be checked.
10. Contact scheme and jumpers (pre-wired) ④
  - a. If jumpers are desired to be pre-wired, draw a horizontal line between the terminals to be jumpered per the example on [page 19-144](#).
  - b. Refer to the Legend at the bottom of [page 19-143](#) for contact sequences, i.e.: X indicates contact closure. See [page 19-144](#) for examples of filling in this portion of the key sheet.

**9003K2 Cam Switch Order Form**

<p>Order No. _____ <span style="float: right;">Date : _____</span></p> <p>Agency: _____</p> <p>Branch: _____</p> <p>Customer: _____</p> <p>Address: _____</p> <hr/> <p>Delivery instructions:</p> <hr/> <p>Product reference: <b>Type : K .....</b></p> <p>③ Switching angle (positions) 30° or 60°                      45° or 90°</p> <p style="text-align: center;">Full rotation through 360°: <input type="checkbox"/></p>	<p>9003K2 (20 A): <input type="checkbox"/></p> <hr/> <p><b>Product quantity:</b> <input type="checkbox"/> <b>Front mounting</b> <input type="checkbox"/></p> <hr/> <p><b>Base/contact block only (no operating head):</b></p> <p>∅ 22 plastic: <input type="checkbox"/>    ∅ 22 metal: <input type="checkbox"/></p> <p style="text-align: center;"><b>Complete:</b>    ③ ④</p> <hr/> <p><b>Complete switch (base/contact block, head, legend)</b> <input type="checkbox"/></p> <p style="text-align: center;">Complete: ① ② ③ ④</p> <p style="text-align: center;">For 22 mm plastic mounting:</p> <p>① Operating head reference: <b>9003K</b></p> <p>② Legend reference: <b>9003KZ .....</b> <i>or for mounting with metal base:</i></p> <p>① Operating head reference: <b>KAX Z .....</b></p> <p>② Legend reference: <b>XBCY .....</b></p> <p style="text-align: center;"><u>Special legend marking:</u></p> <p>As per diagram on left: <input type="checkbox"/>    As per form: <input type="checkbox"/> <b>FAX</b></p> <p>⚡ ←                      ← ⚡</p> <p><b>Accessories / comments:</b> .....</p>																																																																																																																																																																																																																																																																																																																																																																																																																								
<p>④ <b>Contact scheme and jumpers (pre-wired):</b></p> <table border="1" style="width:100%; border-collapse: collapse;"> <tr> <td style="width:100px;"> </td> <td>1</td><td>3</td><td>5</td><td>7</td><td>9</td><td>11</td><td>13</td><td>15</td><td>17</td><td>19</td><td>21</td><td>23</td><td>25</td><td>27</td><td>29</td><td>31</td><td>33</td><td>35</td><td>37</td><td>39</td> </tr> <tr> <td style="width:100px;"> </td> <td>2</td><td>4</td><td>6</td><td>8</td><td>10</td><td>12</td><td>14</td><td>16</td><td>18</td><td>20</td><td>22</td><td>24</td><td>26</td><td>28</td><td>30</td><td>32</td><td>34</td><td>36</td><td>38</td><td>40</td> </tr> <tr> <td style="width:100px;"> </td> <td colspan="20"> </td> </tr> </table> <table border="1" style="width:100%; border-collapse: collapse;"> <tr> <td style="width:50px;">*</td> <td style="width:50px;">x</td> <td style="width:20px;"></td> <td>1</td><td>3</td><td>5</td><td>7</td><td>9</td><td>11</td><td>13</td><td>15</td><td>17</td><td>19</td><td>21</td><td>23</td><td>25</td><td>27</td><td>29</td><td>31</td><td>33</td><td>35</td><td>37</td><td>39</td> </tr> <tr> <td> </td> <td> </td> <td> </td> <td>2</td><td>4</td><td>6</td><td>8</td><td>10</td><td>12</td><td>14</td><td>16</td><td>18</td><td>20</td><td>22</td><td>24</td><td>26</td><td>28</td><td>30</td><td>32</td><td>34</td><td>36</td><td>38</td><td>40</td> </tr> <tr><td> </td><td> </td><td> </td><td> </td><td> </td><td> </td><td> </td><td> </td><td> </td><td> </td><td> </td><td> </td><td> </td><td> </td><td> </td><td> </td><td> </td><td> </td><td> </td><td> </td><td> </td><td> </td><td> </td></tr> <tr><td> </td><td> </td><td> </td><td> </td><td> </td><td> </td><td> </td><td> </td><td> </td><td> </td><td> </td><td> </td><td> </td><td> </td><td> </td><td> </td><td> </td><td> </td><td> </td><td> </td><td> </td><td> </td><td> </td></tr> <tr><td> </td><td> </td><td> </td><td> </td><td> </td><td> </td><td> </td><td> </td><td> </td><td> </td><td> </td><td> </td><td> </td><td> </td><td> </td><td> </td><td> </td><td> </td><td> </td><td> </td><td> </td><td> </td><td> </td></tr> <tr><td> </td><td> </td><td> </td><td> </td><td> </td><td> </td><td> </td><td> </td><td> </td><td> </td><td> </td><td> </td><td> </td><td> </td><td> </td><td> </td><td> </td><td> </td><td> </td><td> </td><td> </td><td> </td><td> </td></tr> <tr><td> </td><td> </td><td> </td><td> </td><td> </td><td> </td><td> </td><td> </td><td> </td><td> </td><td> </td><td> </td><td> </td><td> </td><td> </td><td> </td><td> </td><td> </td><td> </td><td> </td><td> </td><td> </td><td> </td></tr> <tr><td> </td><td> </td><td> </td><td> </td><td> </td><td> </td><td> </td><td> </td><td> </td><td> </td><td> </td><td> </td><td> </td><td> </td><td> </td><td> </td><td> </td><td> </td><td> </td><td> </td><td> </td><td> </td><td> </td></tr> <tr><td> </td><td> </td><td> </td><td> </td><td> </td><td> </td><td> </td><td> </td><td> </td><td> </td><td> </td><td> </td><td> </td><td> </td><td> </td><td> </td><td> </td><td> </td><td> </td><td> </td><td> </td><td> </td><td> </td></tr> <tr><td> </td><td> </td><td> </td><td> </td><td> </td><td> </td><td> </td><td> </td><td> </td><td> </td><td> </td><td> </td><td> </td><td> </td><td> </td><td> </td><td> </td><td> </td><td> </td><td> </td><td> </td><td> </td><td> </td></tr> <tr><td> </td><td> </td><td> </td><td> </td><td> </td><td> </td><td> </td><td> </td><td> </td><td> </td><td> </td><td> </td><td> </td><td> </td><td> </td><td> </td><td> </td><td> </td><td> </td><td> </td><td> </td><td> </td><td> </td></tr> <tr><td> </td><td> </td><td> </td><td> </td><td> </td><td> </td><td> </td><td> </td><td> </td><td> </td><td> </td><td> </td><td> </td><td> </td><td> </td><td> </td><td> </td><td> </td><td> </td><td> </td><td> </td><td> </td><td> </td></tr> <tr><td> </td><td> </td><td> </td><td> </td><td> </td><td> </td><td> </td><td> </td><td> </td><td> </td><td> </td><td> </td><td> </td><td> </td><td> </td><td> </td><td> </td><td> </td><td> </td><td> </td><td> </td><td> </td><td> </td></tr> <tr><td> </td><td> </td><td> </td><td> </td><td> </td><td> </td><td> </td><td> </td><td> </td><td> </td><td> </td><td> </td><td> </td><td> </td><td> </td><td> </td><td> </td><td> </td><td> </td><td> </td><td> </td><td> </td><td> </td></tr> <tr><td> </td><td> </td><td> </td><td> </td><td> </td><td> </td><td> </td><td> </td><td> </td><td> </td><td> </td><td> </td><td> </td><td> </td><td> </td><td> </td><td> </td><td> </td><td> </td><td> </td><td> </td><td> </td><td> </td></tr> </table>			1	3	5	7	9	11	13	15	17	19	21	23	25	27	29	31	33	35	37	39		2	4	6	8	10	12	14	16	18	20	22	24	26	28	30	32	34	36	38	40																						*	x		1	3	5	7	9	11	13	15	17	19	21	23	25	27	29	31	33	35	37	39				2	4	6	8	10	12	14	16	18	20	22	24	26	28	30	32	34	36	38	40																																																																																																																																																																																																																																																																																																											
	1	3	5	7	9	11	13	15	17	19	21	23	25	27	29	31	33	35	37	39																																																																																																																																																																																																																																																																																																																																																																																																					
	2	4	6	8	10	12	14	16	18	20	22	24	26	28	30	32	34	36	38	40																																																																																																																																																																																																																																																																																																																																																																																																					
*	x		1	3	5	7	9	11	13	15	17	19	21	23	25	27	29	31	33	35	37	39																																																																																																																																																																																																																																																																																																																																																																																																			
			2	4	6	8	10	12	14	16	18	20	22	24	26	28	30	32	34	36	38	40																																																																																																																																																																																																																																																																																																																																																																																																			
<p>(x) Key withdrawal position for key operators; by default, withdrawal in all positions.</p> <p>Conditions for provision of spring return function: <b>R</b> , Spring return to 30° from 0° position or to last position after a 90° angle (for maximum of 3 contacts simultaneously)</p> <table border="1" style="width:100%; border-collapse: collapse;"> <tr> <td style="width:25%;">✘ Contact closed in 1 position.</td> <td style="width:25%;">✘ Contact closed with break between the 2 positions (for angle &gt;= 45°)</td> <td style="width:25%;">✘ Contact closed and maintained between several successive positions</td> <td style="width:25%;">✘ Contact closed and maintained between two positions</td> <td style="width:10%;">✘ ✘ <b>Overlap of two contacts between two positions</b></td> <td style="width:10%;">✘ <b>Contact overlapping on previous and next positions</b></td> </tr> </table> <p><input type="checkbox"/> Check the box to confirm selection                      .....                      Fill in with text</p>		✘ Contact closed in 1 position.	✘ Contact closed with break between the 2 positions (for angle >= 45°)	✘ Contact closed and maintained between several successive positions	✘ Contact closed and maintained between two positions	✘ ✘ <b>Overlap of two contacts between two positions</b>	✘ <b>Contact overlapping on previous and next positions</b>																																																																																																																																																																																																																																																																																																																																																																																																																		
✘ Contact closed in 1 position.	✘ Contact closed with break between the 2 positions (for angle >= 45°)	✘ Contact closed and maintained between several successive positions	✘ Contact closed and maintained between two positions	✘ ✘ <b>Overlap of two contacts between two positions</b>	✘ <b>Contact overlapping on previous and next positions</b>																																																																																																																																																																																																																																																																																																																																																																																																																				

9003K2 Cam Switch Order Form—Example

<b>Order No.</b> _____ <b>Date :</b> _____ Agency: _____ Branch: _____ <b>Customer:</b> _____ <b>Address:</b> _____ Delivery instructions: _____ Product reference: <b>Type :</b> <b>K</b> ..... ③ Switching angle (positions) 30° or 60°                      45° or 90°  Full rotation through 360°: <input type="checkbox"/>	9003K2 (20 A): <input checked="" type="checkbox"/> <b>Product quantity:</b> <input type="text" value="1"/> <b>Front mounting</b> <input checked="" type="checkbox"/> <b>Base/contact block only (no operating head):</b> Ø 22 plastic: <input type="checkbox"/> Ø 22 metal: <input type="checkbox"/> <b>Complete:</b> <input type="text" value="3"/> <input type="text" value="4"/> <b>Complete switch (base/contact block, head, legend)</b> <input checked="" type="checkbox"/> Complete: <input type="text" value="1"/> <input type="text" value="2"/> <input type="text" value="3"/> <input type="text" value="4"/> For 22 mm plastic mounting: ① Operating head reference: <b>9003KAC1B</b> ② Legend reference: <b>9003KZ18</b> or for mounting with metal base: ① Operating head reference: <b>KAX Z</b> ..... ② Legend reference: <b>XBC Y</b> ..... <b>Special legend marking:</b> As per diagram on left: <input type="checkbox"/> As per form: <input type="checkbox"/> <b>FAX</b> <b>Accessories / comments:</b> <b>KZ 36</b> ..... .....
--	--

④ Contact scheme and jumpers (pre-wired):

		1	3	5	7	9	11	13	15	17	19	21	23	25	27	29	31	33	35	37	39
		2	4	6	8	10	12	14	16	18	20	22	24	26	28	30	32	34	36	38	40
*:	x																				
A	330°		x		x																
0	0°		x			x															
1	30°			x			x														
2	60°	x		x	x																

(x) Key withdrawal position for key operators; by default, withdrawal in all positions.  
 Conditions for provision of spring return function:  
**R**, Spring return to 30° from 0° position or to last position after a 90° angle (for maximum of 3 contacts simultaneously)

<input checked="" type="checkbox"/> Contact closed in 1 position.	<input checked="" type="checkbox"/> Contact closed with break between the 2 positions (for angle >= 45°)	<input checked="" type="checkbox"/> Contact closed and maintained between several successive positions	<input checked="" type="checkbox"/> Contact closed and maintained between two positions	<input checked="" type="checkbox"/> Overlap of two contacts between two positions	<input checked="" type="checkbox"/> Contact overlapping on previous and next positions
---	--	--	---	---	--

Check the box to confirm selection                      ..... Fill in with text



# Section 20

## Electronic Sensors and Machine Cabling



Photoelectric Sensors



Proximity Sensors



Ultrasonic Sensors

<b>OsiSense Photoelectric Sensors</b>	<b>20-2</b>
XUB Tubular Sensors	20-2
XUVR and XUVA Sensors	20-3
XUK and XUX Compact Sensors	20-4
<b>OsiSense Inductive Proximity Sensors</b>	<b>20-5</b>
XS Plastic Rectangular	20-5
XS Plastic Rectangular Sensors	20-5
XS General Purpose Tubular	20-6
3-Wire, 12–48 Vdc, Long Case Sensors and Accessories	20-6
3-wire 12–24 Vdc, Short Case Sensors	20-7
XS Basic and Basic Plus	20-8
<b>OsiSense Proximity Sensors</b>	<b>20-9</b>
Inductive and Capacitive Proximity	20-9
2-Wire AC or DC, Long Case Sensors	20-9
<b>Ultrasonic Sensors</b>	<b>20-10</b>
XX•18, XUV, and XXV Sensors	20-10
VM Sensors	20-11
30 mm Ultrasonic Sensors	20-12

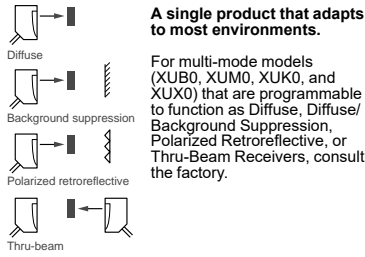

XUB Tubular Sensors

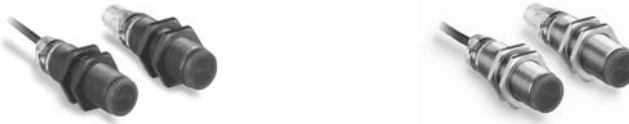

Table 20.1: XUB Tubular Sensors

XUB Tubular Sensors		XUB-A 18 mm plastic	XUB-B 18 mm metal
Usable sensing distance	Proximity diffuse (adjustable)	0.6 m (2.0 ft)	0.6 m (2.0 ft)
	Polarized retroreflective	2 m (6.6 ft)	2 m (6.6 ft)
	Retroreflective	4 m (13.1 ft)	4 m (13.1 ft)
	Thru-beam	15 m (49 ft)	15 m (49 ft)
Mounting (mm)		M 18 x 1	M 18 x 1
Enclosure: M (metal), P (plastic) / Dimensions (mm) Ø x L or W x H x D		P / M 18 x 46	P / M 18 x 46
Setup LEDs		—	—
Temperature range		-25 to +55 °C (-13 to +131 °F)	
Degree of protection (conforming to IEC 60529):		IP65; IP67 double insulation; IP69K double insulation (M12 only)	

Table 20.2: Sensors for DC Applications (Solid State Output: Transistor)

Connection		Precabled, PvR, 2 m [1]	M12 connector	Precabled, PvR, 2 m [1]	M12 connector	
		Catalog No.	Catalog No.	Catalog No.	Catalog No.	
Receiver or Transmitter/Receiver, 3-wire PNP [2]	Proximity diffuse, adjustable	N.O.	XUB5APANL2	XUB5APANM12	XUB5BPANL2	XUB5BPANM12
		N.C.	XUB5APBNL2	XUB5APBNM12	XUB5BPNL2	XUB5BPNM12
	Polarized retroreflective	N.O.	XUB9APANL2	XUB9APANM12	XUB9BPANL2	XUB9BPANM12
		N.C.	XUB9APBNL2	XUB9APBNM12	XUB9BPNL2	XUB9BPNM12
	Retroreflective	N.O.	XUB1APANL2	XUB1APANM12	XUB1BPANL2	XUB1BPANM12
		N.C.	XUB1APBNL2	XUB1APBNM12	XUB1BPNL2	XUB1BPNM12
	Thru-beam	N.O.	XUB2APANL2R	XUB2APANM12R	XUB2BPANL2R	XUB2BPANM12R
		N.C.	XUB2APBNL2R	XUB2APBNM12R	XUB2BPNL2R	XUB2BPNM12R
Transmitter		XUB2AKSNL2T	XUB2AKSNM12T	XUB2AKSNL2T	XUB2AKSNM12T	
Supply voltage limits, min/max (V) including ripple		10–36	10–36	10–36	10–36	
Switching frequency (Hz)		500	500	500	500	
Common characteristics for DC versions		Switching capacity, max (mA): 100 / Overload and short-circuit protection / LED output state				

Table 20.3: Metal Body Sensors for Two-Wire AC [3] or DC Applications (Solid-State Output: Transistor)

Connection		Precabled, PvR, 2 m [1]	1/2"-20UNF Connector	
		Catalog No.	Catalog No.	
System	Diffuse with adjustable background suppression	NO	XU8M18MA230	XU8M18MA230K
		NC	XU8M18MB230	XU8M18MB230K
	Diffuse	NO	XU5M18MA230	XU5M18MA230K
		NC	XU5M18MB230	XU5M18MB230K
	Polarized retroreflective [4]	NO	XU9M18MA230	XU9M18MA230K
		NC	XU9M18MB230	XU9M18MB230K
	Thru-beam[5]	NO	XU2M18MA230	XU2M18MA230K
		NC	XU2M18MB230	XU2M18MB230K
Rated supply voltage (Vac/Vdc)		24–240	24–240	
Switching frequency (Hz)		25	25	
Switching capacity (mA) [3]		10–200	10–200	

Table 20.4: Accessories

	mm	Catalog No.	
Reflectors	24 x 21	XUZC24	
	Ø 80	XUZC80	
	50 x 50	XUZC50	
	100 x 100	XUZC100	
Mounting brackets for XUB	Material	Catalog No.	
	Die Cast Zinc	XUZA118	
	Plastic	XUZA218	
Cables, 2 m, without LED [6]	90°	Straight	
	Catalog No.	Catalog No.	
	M8 (4-Pin)	XZCP1041L2	XZCP0941L2
	M12 (4-pin)	XZCP1241L2	XZCP1141L2
Suitable plug-in female connectors, including pre-wired versions	1/2"-20UNF	XZCP1965L2	XZCP1865L2

[1] For a 5 m cable, change L2 to L5. For example, XUMB5APANL2 becomes XUMB5APANL5.  
 [2] For version with NPN output, change "P" to "N". For example: XUB1APANL2 would become XUB1ANANL2.  
 [3] These sensors do not incorporate overload or short-circuit protection. A 0.4 A fast-acting fuse should be connected in series with the load.  
 [4] A 50 x 50 mm reflector XUZC50 is included with a polarized retroreflective system.  
 [5] Includes a thru-beam transmitter and receiver.  
 [6] For 5 or 10 meter lengths, replace 2 in the cable catalog number with 5 or 10.

XUVR / XUVA

Table 20.5: XUVR / XUVA Optical fork without adjustment

		Connector	Precabled	Angular Fork
<b>Sensing Characteristics</b>		<b>Thru-beam</b>		
Sensing range, mm (in.)		2–180 (0.08 –7.09)		
Sensing frequency		4000 Hz		
Minimum size of object detected, mm (in.)	Passageway 2–120 mm	0.8 (0.03)	1.2 (0.05)	
	Passageway u 150 mm	1 (0.04)	1.5 (0.06)	
Fork type		XUVR*	XUVA*	
<b>Power Requirements</b>				
Supply voltage		12–24 Vdc		
Max. load		100 mA with overload and short-circuit protection		
<b>Environmental</b>				
Operating temperature range		–10 to +60 °C (+14 to +140 °F)		
Environmental protection ratings		IP65 and IP67		
<b>Construction</b>				
Materials—Case		Painted aluminum and polyamide		
<b>Catalog numbers of forks type XUVR*</b>				
<b>Precabled, 2 m, Depth (B): 40 mm (1.18 in.)</b>				
<b>Passageway (A)</b>	<b>Function</b>	<b>Output</b>	<b>Catalog Number</b>	
30 mm (1.18 in.)	NO	PNP	XUVR0303PANL2	
<b>M8, 3-Pin, Depth (B): 60 mm (2.36 in.)</b>				
<b>Passageway (A)</b>	<b>Function</b>	<b>Output</b>	<b>Catalog Number</b>	
50 mm (1.97 in.)	NO	PNP	XUVR0605PANM8	
		NPN	XUVR0605NANM8	
	NC	PNP	XUVR0605PBNM8	
		NPN	XUVR0605NBNM8	
80 mm (3.15 in.)	NO	PNP	XUVR0608PANM8	
		NPN	XUVR0608NANM8	
	NC	PNP	XUVR0608PBNM8	
		NPN	XUVR0608NBNM8	
<b>Connection—M8, 3-Pin, Depth (B): 120 mm (4.72 in.)</b>				
<b>Passageway (A)</b>	<b>Function</b>	<b>Output</b>	<b>Catalog Number</b>	
120 mm (4.72 in.)	NO	PNP	XUVR1212PANM8	
		NPN	XUVR1212NANM8	
	NC	PNP	XUVR1212PBNM8	
		NPN	XUVR1212NBNM8	
180 mm (7.09 in.)	NO	PNP	XUVR1218PANM8	
		NPN	XUVR1218NANM8	
	NC	PNP	XUVR1218PBNM8	
		NPN	XUVR1218NBNM8	
<b>Catalog numbers of forks, type XUVA*</b>				
<b>M8 connector, 3-Pin</b>				
<b>Passageway (A)</b>	<b>Function</b>	<b>Output</b>	<b>Catalog Number</b>	
50 mm (1.97 in.)	NO	PNP	XUVA0505PANM8	
80 mm (3.15 in.)	NO	PNP	XUVA0808PANM8	
120 mm (4.72 in.)	NO	PNP	XUVA1212PANM8	
150 mm (5.91 in.)	NO	PNP	XUVA1515PANM8	

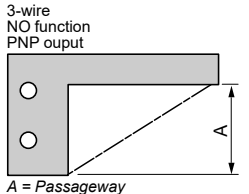
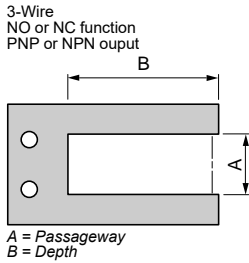



XUK and XUX Compact Sensors

Table 20.6: XUK and XUX Compact

**A single product that adapts to most environments.**

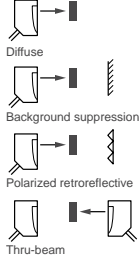
For multi-mode models (XUB0, XUM0, XUK0, and XUX0) that are programmable to function as Diffuse, Diffuse/Background Suppression, Polarized Retroreflective, or Thru-Beam Receivers, consult the factory.

Sensors		XUK Compact Design 50 x 50	XUX Compact Design		
Usable sensing distance	Proximity diffuse (adjustable sensitivity)	1 m (3.2 ft) [7]	2.1 m (6.8 ft)		
	Polarized retroreflective	5 m (16.4 ft) [7]	11 m (36 ft)		
	Retroreflective	7 m (23.0 ft) [7]	14 m (46 ft)		
	Thru-beam	30 m (98 ft) [7]	40 m (131.2 ft)		
Mounting (mm)		direct: mounting centers 40 x 40, M4 screws	direct: mounting centers 30/36 to 40/50/74, M5 screws		
Enclosure: M (metal) P (plastic) / Dimensions (mm) Ø x L or W x H x D		P / 18 x 50 x 50	P / 30 x 92 x 71		
Setup LEDs		⊗	⊗		
Sensors for DC Applications (Solid State Output: Transistor)					
Connection		Precabled, PVC, 2 m	M12 connector	Screw terminals, ISO 16 cable gland	M12 connector
Transmitter	Proximity diffuse, adjustable	N.O. XUK2AKSNL2T XUK5APANL2	XUK2AKSNM12T XUK5APANM12	XUX0AKSAT16T XUX5APANT16	XUX0AKSAM12T XUX5APANM12
	Receiver or Transmitter/ Receiver, 3-wire PNP [8]	N.C. XUK5APBNL2 XUK9APANL2 XUK9APBNL2 XUK1APANL2 XUK1APBNL2 N.O. XUK2APANL2R XUK2APBNL2R N.C.	XUK5APBNM12 XUK9APANM12 XUK9APBNM12 XUK1APANM12 XUK1APBNM12 XUK2APANM12R XUK2APBNM12R	XUX5APBNT16 XUX9APANT16 XUX9APBNT16 XUX1APANT16 XUX1APBNT16 XUX2APANT16R XUX2APBNT16R	XUX5APBNM12 XUX9APANM12 XUX9APBNM12 XUX1APANM12 XUX1APBNM12 XUX2APANM12R XUX2APBNM12R
Supply voltage limits, min/max (V) including ripple		10–36	10–36	10–36	10–36
Switching frequency (Hz)		250	250	250	250
Common characteristics for DC versions		Yellow output state LED (except T-beam transmitter): ⊗; Green power LED (T-beam Transmitter only): ⊗			
Multi-current/multi-voltage sensors for AC/DC applications, 20–264 Vac/Vdc, including ripple (relay output, 1 C/O, 3 A)					
Connection		Precabled, 2 m	—	Screw terminals, ISO 16 cable gland	—
Transmitter	Diffuse	N.O. + N.C. XUK2ARC�L2T XUK5ARC�L2	—	XUX0ARCTT16T XUX5ARCNT16	—
	Receiver or Transmitter/ Receiver	N.O. + N.C. XUK9ARC�L2 XUK1ARC�L2 N.O. + N.C. XUK2ARC�L2R	—	XUX9ARCNT16 XUX1ARCNT16 XUX2ARCNT16R	—
Switching frequency (Hz)		20	—	20	—
Yellow output state LED (except T-beam Transmitter) ⊗ /		⊗ / ⊗	—	⊗ / ⊗	—
Green power LED (T-beam Transmitter only) ⊗		—	—	—	—

**NOTE:** See Table 20.4 Accessories, page 20-2 for suitable plug-in cables with female connectors.

[7] Excess gain of 2.  
[8] For version with NPN output, change "P" to "N". For example, XUM5APCNL2 would become XUM5ANC�L2.

XS Plastic Rectangular Sensors

Table 20.7: General Purpose, Plastic Case, Limit Switch Style, 5-Position Turret Head

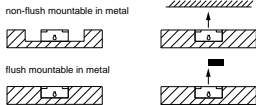
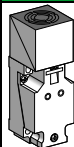
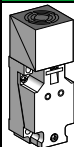
Sensor		Flush mountable in metal	Non-flush mountable in metal	
<p>A single product that automatically adapts to most environments. Accurate position detection via teach mode.</p> 				
<b>General Specifications</b>				
Product certifications		UL, CSA, CE		
Degree of protection conforming to IEC 60529		IP65, IP67, and IP69K		
Operating temperature		-25 to +70 °C (-13 to +158 °F) [1]		
<b>DC Supply</b>				
<b>Catalog Numbers</b>				
Nominal sensing distance $S_n$ , mm (in.)		Increased range 20 (0.79)	15 (0.59)	Increased range 40 (1.57)
4-wire DC (complementary outputs)	PNP, NO + NC	XS8C4A1PCN12	—	XS8C4A4PCN12
	NPN, NO + NC	XS8C4A1NCN12	—	XS8C4A4NCN12
2-wire DC (non-polarized)	NO or NC programmable	XS8C4A1DPN12	XS7C4A1DPN12	XS8C4A4DPN12
Weight, kg (lb)		0.244 (0.54)	0.244 (0.54)	0.244 (0.54)
<b>Supplemental Specifications</b>				
Connection [2]		Screw terminals, clamping capacity: 2 or 4 x 1.5 mm <sup>2</sup> (16 AWG)		
Operating zone, mm (in.)		0-16 (0-0.63)	0-12 (0-0.47)	0-32 (0-1.26)
Repeat accuracy		≤3% of effective sensing distance (Sr)		
Differential travel		3-15% of effective sensing distance (Sr)		
Status indication	Output	Yellow LED		
	Supply on	Green LED (4-wire)		
Rated supply voltage		12-48 Vdc with protection against reverse polarity		
Voltage limits (including ripple)		10-58 Vdc		
Current consumption, 4-wire no-load		<15 mA		
Switching capacity with overload + short-circuit protection		4-wire, 200 mA; 2-wire, 100 mA		
Residual current, 2-wire open state		<0.6 mA		
Voltage drop, closed state		4-wire, <2 V; 2-wire, <4.2 V		
Maximum switching frequency		300 Hz flush mount	300 Hz flush mount	150 Hz non-flush mount
Delays	First-up	4-wire, 7 ms; 2-wire, 20 ms		
	Response	Flush mount: ≤1.2 ms; non-flush mount: ≤1.4 ms		
	Recovery	Flush mount: ≤1.8 ms; non-flush mount: ≤3.5 ms		
<b>Plug-in, AC or DC supply</b>				
<b>Catalog Numbers</b>				
Nominal sensing distance $S_n$ , mm (in.)		AC, Flush Mountable 20 (0.78)	AC/DC, Flush Mountable 15 (0.59)	AC/DC, Non-Flush Mountable 40 (1.57)
2-wire AC	NO or NC programmable	XS8C4A1DPN12	XS7C4A1DPN12	XS8C4A4DPN12
2-wire AC or DC universal model	NO or NC programmable	XS8C4A1MPN12	XS7C4A1MPN12	XS8C4A4MPN12
<b>Supplemental Specifications</b>				
Weight, kg (lb)		0.244 (0.54)	0.244 (0.54)	0.244 (0.54)
Connection [2]		Screw terminals, clamping capacity 2 x 1.5 mm <sup>2</sup> (16 AWG)		
Operating zone, mm (in.)		0-16 (0-0.63)	0-12 (0-0.47)	0-32 (0-1.26)
Repeat accuracy		≤3% of effective sensing distance (Sr)		
Differential travel		3-15% of effective sensing distance (Sr)		
Output state indication		Yellow LED		
Rated supply voltage (with reverse polarity protection)		24-240 Vac, 50/60 Hz	24-240 Vac, 50/60 Hz / 24-210 Vdc	24-240 Vac, 50/60 Hz / 24-210 Vdc
Voltage limits (including ripple)		20-264 Vac or Vdc	20-264 Vac or Vdc	20-264 Vac or Vdc
Current consumption, no-load		—		
Switching capacity [3]		5-300 mA or 5-200 mA DC [3]	5-300 mA AC or 5-200 mA DC [3]	5-300 mA AC or 5-200 mA DC [3]
Residual current, open state		1.5 mA	1.5 mA	1.5 mA
Voltage drop, closed state		≤5.5 V		
Maximum switching frequency		AC: 25 Hz; DC: 300 Hz	AC: 25 Hz; DC: 300 Hz	AC: 25 Hz; DC: 150 Hz
Delays	First-up	20 ms		
	Response	Flush mount: ≤1.2 ms; non-flush mount: ≤1.4 ms		
	Recovery	Flush mount: ≤1.8 ms; non-flush mount: ≤3.5 ms		

[1] Also available: very low temperature models (suffix TF: -40 to +70 °C) or very high temperature models (suffix TT: -25 to +85 °C). Consult the Sensor Competency Center at 800-425-2121, option 2.  
 [2] 1/2" NPT conduit Entry. For PC13, change N12 to G13. For M20, change N12 to P20.  
 [3] These sensors do not incorporate overload or short-circuit protection. A 0.4 mA fast-acting fuse (XUZE04) should be connected in series with the load.

3-Wire, 12–48 Vdc, Long Case Sensors and Accessories

Table 20.8: General Purpose, Long Case, Increased Range, Flush Mountable, 3-Wire DC, Solid-State Output

Sensors, 3-wire 12–48 Vdc, long case model						
Sensing Distance Sn, mm (in.)	Function	Output	Connection	Weight		Catalog No.
				kg	lb	
<b>Ø 8, threaded M8 x 1</b>						
2.5 (0.10)	NO	PNP	Precabled (2 m) [4]	0.035	0.08	XS608B1PAL2
			M12 connector	0.015	0.03	XS608B1PAM12
		NPN	Precabled (2 m) [4]	0.035	0.08	XS608B1NAL2
	M12 connector		0.015	0.03	XS608B1NAM12	
	NC	PNP	Precabled (2 m) [4]	0.035	0.08	XS608B1PBL2
			M12 connector	0.015	0.03	XS608B1PBM12
NPN		Precabled (2 m) [4]	0.035	0.08	XS608B1NBL2	
	M12 connector	0.015	0.03	XS608B1NBM12		
<b>Ø 12, threaded M12 x 1</b>						
4 (0.16)	NO	PNP	Precabled (2 m) [4]	0.075	0.17	XS612B1PAL2
			M12 connector	0.020	0.04	XS612B1PAM12
		NPN	Precabled (2 m) [4]	0.075	0.17	XS612B1NAL2
	M12 connector		0.020	0.04	XS612B1NAM12	
	NC	PNP	Precabled (2 m) [4]	0.075	0.17	XS612B1PBL2
			M12 connector	0.020	0.04	XS612B1PBM12
NPN		Precabled (2 m) [4]	0.075	0.17	XS612B1NBL2	
	M12 connector	0.020	0.04	XS612B1NBM12		
<b>Ø 18, threaded M18 x 1</b>						
8 (0.31)	NO	PNP	Precabled (2 m) [4]	0.100	0.22	XS618B1PAL2
			M12 connector	0.040	0.09	XS618B1PAM12
			Remote screw term. connector	0.100	0.22	XS618B1PAL01B[5]
		NPN	Remote DIN 43650 connector	0.100	0.22	XS618B1PAL01C
			Remote M18 connector	0.100	0.22	XS618B1PAL01G
			Remote U78 connector	0.100	0.22	XS618B1PAL01U78
	NC	PNP	Precabled (2 m) [4]	0.100	0.22	XS618B1NAL2
			M12 connector	0.040	0.09	XS618B1NAM12
			Remote screw term. connector	0.100	0.22	XS618B1NAL01B[5]
		NPN	Remote DIN 43650 connector	0.100	0.22	XS618B1NAL01C
			Remote M18 connector	0.100	0.22	XS618B1NAL01G
			Remote U78 connector	0.100	0.22	XS618B1NAL01U78[5]
<b>Ø 30, threaded M30 x 1.5</b>						
15 (0.59)	NO	PNP	Precabled (2 m) [4]	0.205	0.45	XS630B1PAL2
			M12 connector	0.145	0.32	XS630B1PAM12
			Remote screw term. connector	0.205	0.45	XS630B1PAL01B[5]
		NPN	Remote DIN 43650 connector	0.205	0.45	XS630B1PAL01C
			Remote M18 connector	0.205	0.45	XS630B1PAL01G
			Remote U78 connector	0.100	0.22	XS630B1PAL01U78
	NC	PNP	Precabled (2 m) [4]	0.205	0.45	XS630B1NAL2
			M12 connector	0.145	0.32	XS630B1NAM12
			Remote screw term. connector	0.205	0.45	XS630B1NAL01B[5]
		NPN	Remote DIN 43650 connector	0.205	0.45	XS630B1NAL01C
			Remote M18 connector	0.205	0.45	XS630B1NAL01G
			Remote U78 connector	0.100	0.22	XS630B1NAL01U78

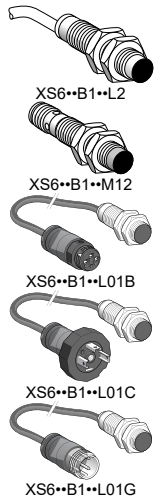

Table 20.9: Accessories

Description	For use with sensors	Weight		Catalog No.
		kg	lb	
90° metal mounting brackets	Ø 8	0.006	0.01	9006PA08
	Ø 12	0.006	0.01	9006PA12
	Ø 18	0.010	0.02	9006PA18
	Ø 30	0.020	0.02	9006PA30
Cables		Mounting Bracket		
Description	90°	Straight	with Indexing Pin for Tubular Sensors	
	M12	XZCP1241L2	XZCP1141L2	M18
Plug-in PUR female connectors, including pre-wired versions (2 m, without LED) [6]				
	Catalog No.	Catalog No.		Catalog No.
M8	XZCP0666L2	XZCP0566L2	M12	XSZB112
U20	XZCP1965L2	XZCP1865L2	M30	XSZB130

[4] For a 5 m cable replace L2 with L5; for a 10 m cable replace L2 with L10. For example, XS608B1PAL2 becomes XS608B1PAL5 with a 5 m cable.

[5] Protective cable gland included with remote screw terminal connector.

[6] For PVC models, add V after the P in the model number. For example, XZCP1241L2 becomes XZCPV1241L2.

### 3-wire 12–24 Vdc, Short Case Sensors

Table 20.10: Sensors, 3-wire 12–24 Vdc, Short Case Model

Sensing Distance Sn, mm (in.)	Function	Output	Connection	Weight		Catalog Number
				kg	lb	
<b>Ø 6.5, plain</b>						
1.5 (0.06)	NO	PNP	Precabled (2 m) [7]	0.035	0.08	XS506B1PAL2
			M8 connector	0.025	0.06	XS506B1PAM8
			M12 connector	0.025	0.06	XS506B1PAM12
	NC	NPN	Precabled (2 m) [7]	0.035	0.08	XS506B1NAL2
			M8 connector	0.025	0.06	XS506B1NAM8
			M12 connector	0.025	0.06	XS506B1NAM12
1.5 (0.06)	NO	PNP	Precabled (2 m) [7]	0.035	0.08	XS506B1PBL2
			M8 connector	0.025	0.06	XS506B1PBM8
			M12 connector	0.025	0.06	XS506B1PBL2
	NC	NPN	Precabled (2 m) [7]	0.035	0.08	XS506B1NBL2
			M8 connector	0.025	0.06	XS506B1NBM8
			M12 connector	0.025	0.06	XS506B1NBL2
<b>Ø 8, threaded M8 x 1</b>						
1.5 (0.06)	NO	PNP	Precabled (2 m) [7]	0.035	0.08	XS508B1PAL2
			M8 connector	0.025	0.06	XS508B1PAM8
			M12 connector	0.025	0.06	XS508B1PAM12
	NC	NPN	Precabled (2 m) [7]	0.035	0.08	XS508B1NAL2
			M8 connector	0.025	0.06	XS508B1NAM8
			M12 connector	0.025	0.06	XS508B1NAM12
1.5 (0.06)	NO	PNP	Precabled (2 m) [7]	0.035	0.08	XS508B1PBL2
			M8 connector	0.025	0.06	XS508B1PBM8
			M12 connector	0.025	0.06	XS508B1PBL2
	NC	NPN	Precabled (2 m) [7]	0.035	0.08	XS508B1NBL2
			M8 connector	0.025	0.06	XS508B1NBM8
			M12 connector	0.025	0.06	XS508B1NBL2
<b>Ø 12, threaded M12 x 1</b>						
2 (0.08)	NO	PNP	Precabled (2 m) [7]	0.075	0.17	XS512B1PAL2
			M12 connector	0.035	0.08	XS512B1PAM12
			M12 connector	0.035	0.08	XS512B1NAM12
	NC	NPN	Precabled (2 m) [7]	0.075	0.17	XS512B1PBL2
			M12 connector	0.035	0.08	XS512B1PBM12
			M12 connector	0.035	0.08	XS512B1NBL2
2 (0.08)	NO	PNP	Precabled (2 m) [7]	0.075	0.17	XS512B1PAL2
			M12 connector	0.035	0.08	XS512B1PAM12
			M12 connector	0.035	0.08	XS512B1NAM12
	NC	NPN	Precabled (2 m) [7]	0.075	0.17	XS512B1PBL2
			M12 connector	0.035	0.08	XS512B1PBM12
			M12 connector	0.035	0.08	XS512B1NBL2
<b>Ø 18, threaded M18 x 1</b>						
5 (0.20)	NO	PNP	Precabled (2 m) [7]	0.120	0.26	XS518B1PAL2
			M12 connector	0.060	0.13	XS518B1PAM12
			M12 connector	0.060	0.13	XS518B1NAM12
	NC	NPN	Precabled (2 m) [7]	0.120	0.26	XS518B1PBL2
			M12 connector	0.060	0.13	XS518B1PBM12
			M12 connector	0.060	0.13	XS518B1NBL2
5 (0.20)	NO	PNP	Precabled (2 m) [7]	0.120	0.26	XS518B1PAL2
			M12 connector	0.060	0.13	XS518B1PAM12
			M12 connector	0.060	0.13	XS518B1NAM12
	NC	NPN	Precabled (2 m) [7]	0.120	0.26	XS518B1PBL2
			M12 connector	0.060	0.13	XS518B1PBM12
			M12 connector	0.060	0.13	XS518B1NBL2
<b>Ø 30, threaded M30 x 1.5</b>						
10 (0.39)	NO	PNP	Precabled (2 m) [7]	0.205	0.45	XS530B1PAL2
			M12 connector	0.145	0.32	XS530B1PAM12
			M12 connector	0.145	0.32	XS530B1NAM12
	NC	NPN	Precabled (2 m) [7]	0.205	0.45	XS530B1PBL2
			M12 connector	0.145	0.32	XS530B1PBM12
			M12 connector	0.145	0.32	XS530B1NBL2

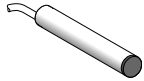







Table 20.11: Accessories

Description	For use with sensors	Weight		Catalog Number
		kg	lb	
Mounting brackets	Ø 6.5 (plain)	0.005	0.01	XSZB165
	Ø 8	0.006	0.01	XSZB108
	Ø 12	0.006	0.01	XSZB112
	Ø 18	0.010	0.02	XSZB118
	Ø 30	0.020	0.02	XSZB130

[7] For a 5 m cable replace L2 with L5; for a 10 m cable replace L2 with L10. Example: XS508B1PAL2 becomes XS508B1PAL5 with a 5 m cable.

XS...B3 Basic Plus Sensors

Table 20.12: Basic Plus, XS...B3

Sensing Characteristics	Ø 6.5 Plain Flush Mountable	Ø M8 Flush Mountable	Ø M12 Flush Mountable	Ø M18 Flush Mountable	Ø M30 Flush Mountable
Basic, Tubular, Flush-Mountable, Increased Range, 3-Wire DC, Solid-State Output					
Sensing range	2 mm (0–0.08 in.)	2 mm (0–0.08 in.)	4.0 mm (0–0.15 in.)	8.0 mm (0.31 in.)	15.0 mm (0.59 in.)
Switching frequency	2500 Hz	2500 Hz	2500 Hz	1000 Hz	500 Hz
Shock resistance	50 gn, duration 11 ms	50 gn, duration 11 ms	50 gn, duration 11 ms	50 gn, duration 11 ms	50 gn, duration 11 ms
Vibration resistance (10–55 Hz)	25 gn, amplitude ± 2 mm	25 gn, amplitude ± 2 mm	25 gn, amplitude ± 2 mm	25 gn, amplitude ± 2 mm	25 gn, amplitude ± 2 mm
<b>Power Requirements</b>					
Supply voltage	12–24 (10–36 max) Vdc with protection against reverse polarity, overload, and short circuit				
<b>Specifications</b>					
Operating zone	XS1...B3...M8, XS1...B3...M12, XS1...B3...L2				
	Ø 6.5 and Ø 8	0–2.0 mm (0–0.07 in.)			
	Ø 12	0–4.0 mm (0–0.15 in.)			
	Ø 18	0–8.0 mm (0–0.31 in.)			
Degree of protection	Conforming to IEC 60529				
Operating temperature	IP65 and IP67				
Materials	Case	–25 to +70 °C (–13 to +158 °F)			
	Cable (XS1...B3...L only)	Nickel-plated brass			
Vibration resistance	Conforming to IEC 60068-2-6				
Shock resistance	Conforming to IEC 60068-2-27				
Rated supply voltage	12–24 Vdc with protection against reverse polarity				
Switching capacity	200 mA with overload and short-circuit protection				
Maximum switching frequency	Ø 6.5, Ø 8, and Ø 12	2500 Hz			
	Ø 18	1000 Hz			
	Ø 30	500 Hz			

Sensing Distance Sn, mm (in.)	Function	Output	Connection	Sold in lots of	Weight		Catalog Number
					kg	lb	
<b>Ø 8, threaded M8 x 1</b>							
<b>Three-wire 12–24 Vdc, flush mountable</b>							
2 (0.07)	NO	PNP	Precabled (2 m) [8]	1	0.070	0.15	XS108B3PAL2
			M8 connector	1	0.030	0.06	XS108B3PAM8
			M12 connector	1	0.060	0.13	XS108B3PAM12
		NPN	Precabled (2 m) [8]	1	0.070	0.15	XS108B3NAL2
			M8 connector	1	0.030	0.06	XS108B3NAM8
			M12 connector	1	0.060	0.13	XS108B3NAM12
	NC	PNP	Precabled (2 m) [8]	1	0.070	0.15	XS108B3PBL2
			M8 connector	1	0.030	0.06	XS108B3PBM8
			M12 connector	1	0.060	0.13	XS108B3PBM12
		NPN	Precabled (2 m) [8]	1	0.070	0.15	XS108B3NBL2
			M8 connector	1	0.030	0.06	XS108B3NBM8
			M12 connector	1	0.060	0.13	XS108B3NBM12
<b>Ø 12, threaded M12 x 1</b>							
<b>Three-wire 12–24 Vdc, flush mountable</b>							
4 (0.15)	NO	PNP	Precabled (2 m) [8]	1	0.090	0.19	XS112B3PAL2
			M12 connector	1	0.030	0.06	XS112B3PAM12
			M12 connector	1	0.090	0.19	XS112B3NAL2
		NPN	M12 connector	1	0.030	0.06	XS112B3NAM12
			Precabled (2 m) [8]	1	0.090	0.19	XS112B3PBL2
			M12 connector	1	0.030	0.06	XS112B3PBM12
	NC	PNP	Precabled (2 m) [8]	1	0.090	0.19	XS112B3NBL2
			M12 connector	1	0.030	0.06	XS112B3NBM12
			M12 connector	1	0.090	0.19	XS112B3PBL2
		NPN	Precabled (2 m) [8]	1	0.090	0.19	XS112B3NBL2
			M12 connector	1	0.030	0.06	XS112B3NBM12
			M12 connector	1	0.090	0.19	XS112B3PBL2
<b>Ø 18, threaded M18 x 1</b>							
<b>Three-wire 12–24 Vdc, flush mountable</b>							
8 (0.31)	NO	PNP	Precabled (2 m) [8]	1	0.110	0.24	XS118B3PAL2
			M12 connector	1	0.060	0.13	XS118B3PAM12
			M12 connector	1	0.110	0.24	XS118B3NAL2
		NPN	M12 connector	1	0.060	0.13	XS118B3NAM12
			Precabled (2 m) [8]	1	0.110	0.24	XS118B3PBL2
			M12 connector	1	0.060	0.13	XS118B3PBM12
	NC	PNP	Precabled (2 m) [8]	1	0.110	0.24	XS118B3NBL2
			M12 connector	1	0.110	0.24	XS118B3NBL2
			M12 connector	1	0.060	0.13	XS118B3NBM12
		NPN	Precabled (2 m) [8]	1	0.110	0.24	XS118B3PBL2
			M12 connector	1	0.060	0.13	XS118B3PBM12
			M12 connector	1	0.110	0.24	XS118B3PBL2
<b>Ø 30, threaded M30 x 1.5</b>							
<b>Three-wire 12–24 Vdc, flush mountable</b>							
15 (0.59)	NO	PNP	Precabled (2 m) [8]	1	0.180	0.39	XS130B3PAL2
			M12 connector	1	0.130	0.28	XS130B3PAM12
			M12 connector	1	0.180	0.39	XS130B3NAL2
		NPN	M12 connector	1	0.130	0.28	XS130B3NAM12
			Precabled (2 m) [8]	1	0.180	0.39	XS130B3PBL2
			M12 connector	1	0.130	0.28	XS130B3PBM12
	NC	PNP	Precabled (2 m) [8]	1	0.180	0.39	XS130B3NBL2
			M12 connector	1	0.130	0.28	XS130B3NBM12
			M12 connector	1	0.180	0.39	XS130B3PBL2
		NPN	Precabled (2 m) [8]	1	0.180	0.39	XS130B3NBL2
			M12 connector	1	0.130	0.28	XS130B3NBM12
			M12 connector	1	0.180	0.39	XS130B3PBL2

[8] For a 5 m cable replace L2 with L5; for a 10 m cable replace L2 with L10. Example: XS106B3PAL2 becomes XS106B3PAL5 with a 5 m cable.



## 2-Wire AC or DC, Long Case Sensors

Table 20.13: Accessories, Basic Plus, XS\*\*\*B3

Mounting Bracket	Sensor Body	Catalog No.	Mounting Bracket with Indexing Pin for Cylindrical Sensors	Diameter	Catalog No.
	M8	9006PA08		M6	XSZB165
	M12	9006PA12		M8	XSZB108
	M18	9006PA18		M12	XSZB112
	M30	9006PA30		M18	XSZB118
				M30	XSZB130

Cables See M8 and M12 connector cables on page 3—Wire, 12 — 48 Vdc, Long Case Sensors and Accessories, page 20-6.

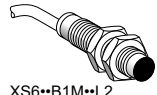

XS6\*\*B1M\*\*L2

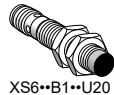

XS6\*\*B1\*\*U20



XS6\*\*B1\*\*L01B



XS6\*\*B1\*\*L01C



XS6\*\*B1\*\*L01G

Table 20.14: General Purpose, Long Case, Tubular, Increased Range, Flush Mountable, 2-Wire AC or DC

Sensors, 2-wire 24–240 V AC or DC, long case model							
Sensing Distance Sn, mm (in.)	Function	Connection	Catalog Number	Weight kg lb			
<b>Ø 12, threaded M12 x 1</b>							
4 (0.16)	NO	Precabled (2 m) [1]	XS612B1MAL2	0.075	0.17		
		1/2"-20UNF connector	XS612B1MAU20	0.025	0.06		
	NC	Precabled (2 m) [1]	XS612B1MBL2	0.075	0.17		
		1/2"-20UNF connector	XS612B1MBU20	0.025	0.06		
<b>Ø 18, threaded M18 x 1</b>							
8 (0.31)	NO	Precabled (2 m) [1]	XS618B1MAL2	0.100	0.22		
		1/2"-20UNF connector	XS618B1MAU20	0.060	0.13		
		Remote screw terminal connector	XS618B1MAL01B [2]	0.100	0.22		
		Remote DIN 43650A connector	XS618B1MAL01C	0.100	0.22		
		Remote M18 connector	XS618B1MAL01G	0.100	0.22		
		Precabled (2 m) [1]	XS618B1MBL2	0.100	0.22		
	NC	Remote screw terminal connector	XS618B1MBL01B [2]	0.100	0.22		
		Remote DIN 43650A connector	XS618B1MBL01C	0.100	0.22		
		<b>Ø 30, threaded M30 x 1.5</b>					
		15 (0.59)	NO	Precabled (2 m) [3]	XS630B1MAL2	0.205	0.45
1/2"-20UNF connector	XS630B1MAU20			0.145	0.32		
Remote screw terminal connector	XS630B1MAL01B [2]			0.205	0.45		
Remote DIN 43650A connector	XS630B1MAL01C			0.205	0.45		
Remote M18 connector	XS630B1MAL01G			0.205	0.45		
Precabled (2 m) [3]	XS630B1MBL2			0.205	0.45		
NC	1/2"-20UNF connector		XS630B1MBU20	0.145	0.32		
	Remote screw terminal connector		XS6 30B1MBL01B [2]	0.205	0.45		
	Remote DIN 43650A connector		XS6 30B1MBL01C	0.205	0.45		
	Remote M18 connector		XS6 30B1MBL01G	0.205	0.45		
<b>Description</b>		<b>For use with sensors</b>	<b>Catalog Number</b>	<b>Weight kg lb</b>			
Mounting brackets		Ø 12	XSZB112	0.006	0.01		
		Ø 18	XSZB118	0.010	0.02		
		Ø 30	XSZB130	0.020	0.04		

Table 20.15: Osisense Capacitive Proximity Sensors, Cylindrical Stainless Steel, DC

Sensing Characteristics			
	Ø M12 threaded M12 x 1	Ø M18 threaded M18 x 1	Ø M30 threaded M30 x 1.5
Sensing Range	2 mm (0.078 in.)	5 mm (0.197 in.)	10 mm (0.394 in.)
Switching Frequency	300	200	150
Shock Resistance	Conforming to IEC 60068-2-27: 30 gn, 11 ms		
Vibration Resistance	Conforming to IEC 60068-2-6 10 gn, +/- 1 mm (10–55 Hz)		
<b>Power Requirements</b>			
Supply Voltage	30 mm: 24 Vdc (12–30 Vdc limits)		32 mm: 24–240 Vac (20–264 Vac limits)
Max. Load	200 mA		
<b>Environment</b>			
Operating Temperature Range	–25 +70 °C (–13 +158 °F)		
Product Certification	CE, ETL		
Environmental Protection Ratings	IP67, NEMA 4X (Indoor Use Only), IP65 (Ø M12 PCM and Ø18 PCM)		
Connection	Precabled, PVC (2 m)		
<b>Catalog Numbers</b>			
<b>Housing Material</b>	Stainless Steel		Nickel Plated Brass
<b>Cable (flush mountable)</b>	Catalog No.		Catalog No.
3-wire / PNP / N.O. function	XT112S1PAL2		XT130B1PAL2
3-wire / NPN / N.O. function	XT112S1NAL2		XT130B1NAL2
4-wire / PNP / N.O./N.C. function	XT112S1PCL2		XT130B1PCL2
<b>Connector (flush mountable)</b>	M12		
4-wire / PNP / N.O./N.C. function	XT112S1PCM12	XT118B1PCM12	XT130B1PCM12

[1] For a 5 m cable, replace L2 with L5; for a 10 m cable, replace L2 with L10. Example: XS612B1MAL2 becomes XS612B1MAL5 with a 5 m cable.

[2] Protective cable gland included with remote screw terminal connector.

[3] Available in Ø8 plastic with double insulation. See page 2/30 of 9006CT1007.

XX•18, XUV, and XXV Sensors

Table 20.16: XX•18 Sensors, 1 m Nominal Sensing Distance, 18 mm Diameter, M12 Connector



XXS18P1•M12



XXS18B1•M12, XXS18S1•M12

Body	Output	Catalog Number
Plastic	Discrete	XXS18P1PM12
	4–20 mA	XXS18P1AM12
	0–10 V	XXS18P1VM12
Plastic (with 90° head)	Discrete	XXA18P1PM12
	4–20 mA	XXA18P1AM12
	0–10 V	XXA18P1VM12
Brass	Discrete	XXS18B1PM12
	4–20 mA	XXS18B1AM12
	0–10 V	XXS18B1VM12
Brass (with 90° head)	Discrete	XXA18B1PM12
	4–20 mA	XXA18B1AM12
	0–10 V	XXA18B1VM12
Stainless Steel	Discrete	XXS18S1PM12
	4–20 mA	XXS18S1AM12
	0–10 V	XXS18S1VM12
Stainless Steel (with 90° head)	Discrete	XXA18S1PM12
	4–20 mA	XXA18S1AM12
	0–10 V	XXA18S1VM12

Table 20.17: XUV Label Sensor

Sensing Characteristics	
Nominal Sensing Distance	3 mm (0.12 in.)
Switching Frequency	500 Hz
Power Requirements	
Supply Voltage	12–24 Vdc (10–30 Vdc limits)
Max. Load	100 mA
Environmental	
Operating Temperature Range	+5 to +55 °C (+41 to +131 °F)
Environmental Protection Ratings	IP65, NEMA 4X (indoor use only), 5, 12, 12k, 13
Construction	
Flat Profile Dimensions (W x H x D)	92.5 x 47.3 x 16.0 mm (3.64 x 1.86 x 0.63 in.)
Housing Material	Aluminium
Transducer	Glass Epoxy
Connection	
Precabled (2 m)	XUVU06M3KCNL2
Connector (M8)	XUVU06M3KSNM8



XUV



XXV

Table 20.18: XXV 18 mm Ultrasonic Sensors

Sensing Characteristics		
Nominal Sensing Distance	2 mm to 50.8 mm (0.08 in. to 2.0 in.)	
Switching Frequency	80 Hz	
Power Requirements		
Supply Voltage	12–24 Vdc	
Max. Load	200 mA	
Environmental		
Operating Temperature Range	0 to 60 °C (32 to 140 °F)	
Environmental Protection Ratings	NEMA Type 4 and 13, and IP67	
Construction		
Barrel Dimensions (Ø x L)	18 x 1 x 43.2 mm (0.71 x 0.04 x 1.70 in.)	
Housing Material	Nickel Plated Brass	
Transducer	Glass Epoxy	
Connection		
Cable		
Precabled, PVC (2 m)		
PNP	N.O.	XXV18B1PAL2
	N.C.	XXV18B1PBL2
NPN	N.O.	XXV18B1NAL2
	N.C.	XXV18B1NBL2
Connection		
M12		
PNP	N.O.	XXV18B1PAM12
	N.C.	XXV18B1PBM12
NPN	N.O.	XXV18B1NAM12
	N.C.	XXV18B1NBM12

Table 20.19: Mounting Brackets

Body Type	Catalog No.
M12	9006PA12
M18	9006PA18
M30	9006PA30

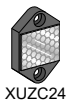

Table 20.20: Sensor Accessories

	<b>Teach Push Button Accessory for Virtu and XX•18 Series</b> Catalog No. XXZPB100
	<b>Python AC/DC Power Converter</b> Catalog No. XXZPM100M12

Table 20.21: Accessories

Description	mm	Catalog No.	
Reflectors	24 x 21	XUJC24	
	Ø 80	XUJC80	
	50 x 50	XUJC50	
Material		Catalog No.	
Mounting Brackets for XUB	Die Cast Zinc	XUZA118	
	Plastic	XUZA218	
90°		Straight	
Catalog No.		Catalog No.	
Cables (PUR), 2 m, without LED <sup>[1]</sup> Suitable plug-in female connectors, including pre-wired versions	M8 (4-Pin)	XZCP1041L2	XZCP0941L2
	M12 (4-pin)	XZCP1241L2	XZCP1141L2
	1/2-20UNF	XZCP1965L2	XZCP1865L2
Cables (PVC), 2 m, without LED <sup>[1]</sup> Suitable plug-in female connectors, including pre-wired versions	M8 (4-Pin)	XZCPV1041L2	XZCPV0941L2
	M12 (4-pin)	XZCPV1241L2	XZCPV1141L2
	1/2-20UNF	XZCPV1965L2	XZCPV1865L2



XUJC24



XUJC50

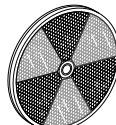

XUJC80



XZCP1241L2



XZCP1141L2



XUZA118



XUZA218

[1] For 5 or 10 meter lengths, replace 2 in the cable catalog number with 5 or 10.

VM Sensors

Table 20.22: Specifications and Catalog Numbers



Virtu™ VM1 and VM18

Specifications						
Sensing Characteristics						
Sensing Range	51–508 mm (2–20 in.)					
Max. Switching Frequency	300 Hz					
Power Requirements						
Supply Voltage	12–24 Vdc					
Supply Current	40 mA (excluding load)					
Environmental Ratings						
Operating Temperature	–30 to 70 °C (–22 to 158 °F)					
Environment	NEMA 4X (indoor use only), IP67					
Construction						
VM18 Barrel, ØxL	18 x 77.62 mm (0.709 x 3.06 in.) with 1 mm-6g thread					
VM1 Dual Mount	Ø 18 mm and Flat Format 43.7 x 18 x 59.7 mm (1.72 x 0.70 x 2.35 in.)					
Housing Material	PBT Resin					
Transducer	Glass Epoxy					
Output Type		Catalog Number				
Output		Cable			Quick Disconnect	
		Dual Mount	Barrel	Dual Mount	Barrel	
Proximity	PNP Sourcing	N.O.	VM1PNO	VM18PNO	VM1PNOQ	VM18PNOQ
		N.C.	VM1PNC	VM18PNC	VM1PNCQ	VM18PNCQ
	NPN Sinking	N.O.	VM1NNO	VM18NNO	VM1NNOQ	VM18NNOQ
		N.C.	VM1NNC	VM18NNC	VM1NNCQ	VM18NNCQ
	PNP Sourcing	N.O.	VM1PTO	VM18PTO	VM1PTOQ	VM18PTOQ
		N.C.				
NPN Sinking	N.O.	VM1NTO	VM18NTO	VM1NTOQ	VM18NTOQ	
	N.C.					
Dual-Level Pump In Normally Open	Off at loss of echo and at powerup	PNP	VM1PPI0000	VM18PPI0000	VM1PPI0000Q	VM18PPI0000Q
		NPN	VM1NPI0000	VM18NPI0000	VM1NPI0000Q	VM18NPI0000Q
	On at loss of echo and at powerup	PNP	VM1PPI1000	VM18PPI1000	VM1PPI1000Q	VM18PPI1000Q
		NPN	VM1NPI1000	VM18NPI1000	VM1NPI1000Q	VM18NPI1000Q
	Hold on loss of echo, Off at powerup	PNP	VM1PPI2000	VM18PPI2000	VM1PPI2000Q	VM18PPI2000Q
		NPN	VM1NPI2000	VM18NPI2000	VM1NPI2000Q	VM18NPI2000Q
Dual-Level Pump Out Normally Open	Off at loss of echo and at powerup	PNP	VM1PPO0000	VM18PPO0000	VM1PPO0000Q	VM18PPO0000Q
		NPN	VM1NPO0000	VM18NPO0000	VM1NPO0000Q	VM18NPO0000Q
	On at loss of echo and at powerup	PNP	VM1PPO1000	VM18PPO1000	VM1PPO1000Q	VM18PPO1000Q
		NPN	VM1NPO1000	VM18NPO1000	VM1NPO1000Q	VM18NPO1000Q
	Hold on loss of echo, Off at powerup	PNP	VM1PPO2000	VM18PPO2000	VM1PPO2000Q	VM18PPO2000Q
		NPN	VM1NPO2000	VM18NPO2000	VM1NPO2000Q	VM18NPO2000Q
Analog	Voltage 0–10 Vdc with Temperature Compensation For Direct/Inverse models, change VD or VI to VA.					
	Direct, 0 V at loss of echo and at powerup	VM1VD0000	VM18VD0000	VM1VD0000Q	VM18VD0000Q	
	Inverse, 0 V at loss of echo and at powerup	VM1VI0000	VM18VI0000	VM1VI0000Q	VM18VI0000Q	
	Direct, 10 V at loss of echo and at powerup	VM1VD1000	VM18VD1000	VM1VD1000Q	VM18VD1000Q	
	Inverse, 10 V at loss of echo and at powerup	VM1VI1000	VM18VI1000	VM1VI1000Q	VM18VI1000Q	
	Direct, hold on loss of echo, 0 V at powerup	VM1VD2000	VM18VD2000	VM1VD2000Q	VM18VD2000Q	
	Inverse, hold on loss of echo, 0 V at powerup	VM1VI2000	VM18VI2000	VM1VI2000Q	VM18VI2000Q	
	Direct, hold on loss of echo, 10 V at powerup	VM1VD3000	VM18VD3000	VM1VD3000Q	VM18VD3000Q	
	Inverse, hold on loss of echo, 10 V at powerup	VM1VI3000	VM18VI3000	VM1VI3000Q	VM18VI3000Q	
	Current 4–20 mA with Temperature Compensation For Direct/Inverse models, change CD or CI to CA					
	Direct, 4 mA at loss of echo and at powerup	VM1CD0000	VM18CD0000	VM1CD0000Q	VM18CD0000Q	
	Inverse, 4 mA at loss of echo and at powerup	VM1CI0000	VM18CI0000	VM1CI0000Q	VM18CI0000Q	
	Direct, 20 mA at loss of echo and at powerup	VM1CD1000	VM18CD1000	VM1CD1000Q	VM18CD1000Q	
	Inverse, 20 mA at loss of echo and at powerup	VM1CI1000	VM18CI1000	VM1CI1000Q	VM18CI1000Q	
	Direct, hold on loss of echo, 4 mA at powerup	VM1CD2000	VM18CD2000	VM1CD2000Q	VM18CD2000Q	
	Inverse, hold on loss of echo, 4 mA at powerup	VM1CI2000	VM18CI2000	VM1CI2000Q	VM18CI2000Q	
	Direct, hold on loss of echo, 20 mA at powerup	VM1CD3000	VM18CD3000	VM1CD3000Q	VM18CD3000Q	
	Inverse, hold on loss of echo, 20 mA at powerup	VM1CI3000	VM18CI3000	VM1CI3000Q	VM18CI3000Q	

30 mm Ultrasonic Sensors

Table 20.23: Specifications and Catalog Numbers



Specifications							
Sensing Characteristics							
Sensing Range	102–1000 mm (4–39 in.)		51 mm to 1 m (2–39 in.); 119 mm to 2 m (4.7–79 in.)		304.8 mm to 8 m (12–315 in.)		
Sensing Frequency	180 kHz		200 kHz		75 kHz		
Power Requirements							
Supply Voltage	12–24 Vdc discrete, 15–24 Vdc analog		12–24 Vdc discrete; 15–24 Vdc analog		12–24 Vdc discrete; 15–24 Vdc analog		
Supply Current	40 mA discrete, 90 mA analog (excluding load)		80 mA (excluding load)		80 mA (excluding load)		
Environmental Ratings							
Operating Temperature	0 to 70 °C (32 to 158 °F)		0 to 50 °C (32 to 122 °F) discrete –20 to 60 °C (–4 to 140 °F) analog		–40 to 60 °C (–40 to 140 °F)		
Environment	NEMA 4X (indoor use only), IP67		NEMA 4X (indoor use only), IP67		NEMA 4X (indoor use only), IP67		
Construction							
Barrel, ØxL	30 x 1 x 95.26 mm (1.18 x 3.75 in.)		30 x 1 x 95 mm (1.18 x 3.74 in.)		30 x 1 x 116 mm (9.18 x 4.58 in.)		
Housing Material	PBT Resin		PEI Resin, or Stainless Steel (1 m only)		PEI Resin		
Transducer	Glass Epoxy		Silicon Rubber or Fluorosilicone		Glass Epoxy or PVDF		
Output Type							
			<b>1 m / 2 m</b>		<b>8 m</b>		
Proximity Output	Description	Catalog No.	Description	Catalog No.	Description	Catalog No.	
	PNP Sourcing N.O.	XX6V3A1PAM12	1 m [2]	Connector	SM950A100000	Cable	SM900A800000
PNP Sourcing N.C.	XX6V3A1PBM12	Cable		SM900A100000			
	PNP Sourcing N.O./N.C.	XX6V3A1PSM12	2 m	Connector	SM950A400000	Connector	SM950A800000
	NPN Sinking N.O.	XX6V3A1NAM12					
	NPN Sinking N.C.	XX6V3A1NBM12					
	NPN Sinking N.O./N.C.	XX6V3A1NSM12					
Dual-Level Pump In	Connector		Cable 1 m [3]	PNP, NO	Cable 8 m	PNP, NO	
	Normally Open		Pump-out latch	SM902A100000	Pump-out latch	SM902A800000	
	Hold on loss of echo; Off on power up		Pump-out latch with alarm	SM902A1560000	Pump-out latch with alarm	SM902A8560000	
	PNP	XX2V3A1PGM12	Pump-out latch, with setpoint	SM902A1760000	Pump-out latch, with setpoint	SM902A8760000	
	NPN	XX2V3A1NGM12	Pump-in latch	SM902A110000	Pump-in latch	SM902A810000	
	Off on loss of echo; Off on power up		Pump-in latch with alarm	SM902A1460000	Pump-in latch with alarm	SM902A8460000	
	PNP	XX2V3A1PFM12	Pump-in latch, with setpoint	SM902A1660000	Pump-in latch, with setpoint	SM902A8660000	
	NPN	XX2V3A1NFM12	Dual setpoint	SM902A1260000	Dual setpoint	SM902A8260000	
Dual-Level Pump Out	Hold on loss of echo; Off on power up		Dual alarm	SM902A1360000	Dual alarm	SM902A8360000	
	PNP	XX2V3A1PJM12	Connector [3]	PNP, NO	Connector	PNP, NO	
	NPN	XX2V3A1NJM12	Pump-out latch	SM952A100000	Pump-out latch	SM952A800000	
	Off on loss of echo; Off on power up		Pump-out latch with alarm	SM952A1560000	Pump-out latch with alarm	SM952A8560000	
	PNP	XX2V3A1PHM12	Pump-out latch, with setpoint	SM952A1760000	Pump-out latch, with setpoint	SM952A8760000	
	NPN	XX2V3A1NHM12	Pump-in latch	SM952A110000	Pump-in latch	SM952A810000	
			Pump-in latch with alarm	SM952A1460000	Pump-in latch with alarm	SM952A8460000	
			Pump-in latch, with setpoint	SM952A1660000	Pump-in latch, with setpoint	SM952A8660000	
Analog	Quick Disconnect		Cable 1 m [3]		Cable 8 m		
	0–20 mA	Catalog No.	Voltage (0–10 Vdc)	Catalog No.	Voltage (0–10 Vdc)	Catalog No.	
	Direct/Inverse slope	XX9V3A1C4M12	Auto slope	SM906A180000	Auto slope	SM906A880000	
	Direct output	XX9V3A1D4M12	Direct slope	SM906A110000	Direct slope	SM906A810000	
	Inverse output	XX9V3A1E4M12	Inverse slope	SM906A100000	Inverse slope	SM906A800000	
	4–20 mA		Current (4–20 mA)		Current (4–20 mA)		
	Direct/Inverse slope	XX9V3A1C2M12	Auto slope	SM906A190000	Auto slope	SM906A890000	
	Direct output	XX9V3A1D2M12	Direct slope	SM906A130000	Direct slope	SM906A830000	
	Inverse output	XX9V3A1E2M12	Inverse slope	SM906A120000	Inverse slope	SM906A820000	
	0–5 Vdc		Connector		Connector		
	Direct/Inverse slope	XX9V3A1F3M12	Voltage (0–10 Vdc)		Voltage (0–10 Vdc)		
	Direct output	XX9V3A1G3M12	Auto slope	SM956A180000	Auto slope	SM956A880000	
	Inverse output	XX9V3A1H3M12	Direct slope	SM956A110000	Direct slope	SM956A810000	
	0–10 Vdc		Inverse slope	SM956A100000	Inverse slope	SM956A800000	
	Direct/Inverse slope	XX9V3A1F1M12	Current (4–20 mA)		Current (4–20 mA)		
	Direct output	XX9V3A1G1M12	Auto slope	SM956A190000	Auto slope	SM956A890000	
Inverse output	XX9V3A1H1M12	Direct slope	SM956A130000	Direct slope	SM956A830000		
		Inverse slope	SM956A120000	Inverse slope	SM956A820000		

[2] For stainless steel, add suffix S.  
[3] For the 2 m version, change model from SMxxxA1xxxx to SMxxxA4xxxx.

# Section 21

## Limit Switches

Encapsulated Miniature      Industrial Snap Switches



9007MS



9007A

Modular, Miniature, and Compact



XCMD



XCKD



XCKP



XCKT

Compact General Duty



XCKL



9007C

Heavy Duty Industrial



9007C



XCKJ

Severe Duty



9007T



L100

<b>Limit Switches</b>	<b>21-2</b>
<b>Application Data</b>	<b>21-4</b>
<b>Current Ratings</b>	<b>21-5</b>
<b>Industrial Snap Switches</b>	<b>21-6</b>
<b>Encapsulated Miniature</b>	<b>21-8</b>
<b>Osisense Limit Switches, Miniature, Metal</b>	<b>21-10</b>
<b>Osisense Limit Switches Metal and Plastic</b>	<b>21-12</b>
<b>Modular, Miniature, and Compact</b>	<b>21-13</b>
<b>Modular, Miniature and Compact Bodies</b>	<b>21-17</b>
<b>Light Duty Compact, Plastic, Non-Modular</b>	<b>21-18</b>
XCKN and XCNR Complete Switches	<b>21-18</b>
<b>Light Duty Industrial, Standard Body, Plastic</b>	<b>21-19</b>
<b>XC Standard Range, Format EN 50041</b>	<b>21-20</b>
XCKS, Plastic, Double Insulated	<b>21-20</b>
<b>OsiSense XCKW</b>	<b>21-23</b>
XCKW Wireless and Batteryless Limit Switches	<b>21-23</b>
<b>Osisense Limit Switches XC Standard, Classic</b>	<b>21-26</b>
<b>Compact General Duty</b>	<b>21-28</b>
<b>Osisense Limit Switches, Standard Industrial, Metal</b>	<b>21-30</b>
<b>Heavy Duty / Industrial Metal Body</b>	<b>21-32</b>
<b>Heavy Duty Industrial Metal Plug-in Body</b>	<b>21-36</b>
<b>Heavy Duty Industrial Single- and Two-Pole</b>	<b>21-38</b>
<b>Severe Duty, Oiltight, Mill and Foundry</b>	<b>21-43</b>

Product Panorama 1 of 2  
Refer to Catalog 9006CT1007

Design	Miniature				Compact		
Catalog number	9007 A/O	9007 MS/ML	XCMN	XCMD	XCKP	XCKD	XCKL
Page	Industrial Snap Switches, page 21-6	Heavy Duty, page 21-8	Precabled, Non-Modular, page 21-14	Precabled, Modular, page 21-14	Plastic, page 21-14	Metal, page 21-14	General Duty, page 21-28
							
Enclosure	Open, plastic	Metal body, metal head	Plastic, double insulated	Metal	Plastic, double insulated	Metal	Metal
Features	A variety of operators are available.	Bottom or side cable entry. Full range of operating heads. See page 21-8.	Mounting by the body or by the head				1 conduit entry
Modularity	Selected operators	Operator	—	Head, body, lever, and connector			Head, body, and lever
Conforming to standards	—	—	—	—	CENELEC: EN 50047		—
Body dimensions (w x h x d), mm (in.)	29.0 x 63.5 x 21.0 (1.14 x 2.5 x 0.83)	40.1 x 44.4 x 15.8 (1.58 x 1.75 x 0.62)	30 x 50 x 16 (1.18 x 1.97 x 0.63)		31 x 65 x 30 (1.22 x 2.56 x 1.18)		52 x 72 x 30 (2.05 x 2.83 x 1.18)
Head	Linear	Linear or rotary	Linear movement, plunger Rotary movement, lever Rotary movement, multi-directional [1] Same heads for ranges XCMD, XCKD, XCKP and XCKT				Linear movement, plunger. Rotary movement, lever. Rotary movement, multi-directional. [1]
<b>Contact blocks</b>							
2 snap action contacts ⊕	—	—	N.C. + N.O.	N.C. + N.O.; N.C. + N.C.	N.C. + N.O.; N.C. + N.C.	N.C. + N.O.; N.C. + N.C.	N.C. + N.O.
2 snap action contacts	—	—	N.C. + N.O.	N.C. + N.O.; N.C. + N.C.	N.C. + N.O.; N.C. + N.C.	N.C. + N.O.; N.C. + N.C.	N.C. + N.O.
3 snap action contacts ⊕	—	—	—	N.C. + N.C. + N.O.	N.C. + N.C. + N.O.; N.C. + N.O. + N.O.	N.C. + N.C. + N.O.; N.C. + N.O. + N.O.	N.C. + N.C. + N.O.; N.C. + N.O. + N.O.
3 snap action contacts	—	—	—	N.C. + N.C. + N.O.	N.C. + N.C. + N.O.; N.C. + N.O. + N.O.	N.C. + N.C. + N.O.; N.C. + N.O. + N.O.	N.C. + N.C. + N.O.; N.C. + N.O. + N.O.
4 snap action contacts ⊕	—	—	—	N.C. + N.C. + N.O. + N.O.	—	—	—
4 snap action contacts	—	—	—	N.C. + N.C. + N.O. + N.O.	—	—	—
2 slow break contacts ⊕ break before make	—	—	—	N.C. + N.O.	N.C. + N.O.	N.C. + N.O.	N.C. + N.O.
2 slow break contacts ⊕ break before make	—	—	—	N.C. + N.O.	N.C. + N.O.	N.C. + N.O.	N.C. + N.O.
2 slow break contacts ⊕ make before break	—	—	—	—	N.O. + N.C.	N.O. + N.C.	N.O. + N.C.
2 slow break contacts ⊕ make before break	—	—	—	—	N.O. + N.C.	N.O. + N.C.	N.O. + N.C.
2 slow break contacts ⊕ simultaneous	—	—	—	—	N.C. + N.C.	N.C. + N.C.	N.C. + N.C.
2 slow break contacts ⊕ simultaneous	—	—	—	—	N.O. + N.O.	N.O. + N.O.	N.O. + N.O.
3 slow break contacts ⊕ break before make	—	—	—	N.C. + N.C. + N.O.	N.C. + N.C. + N.O.; N.C. + N.O. + N.O.	N.C. + N.C. + N.O.; N.C. + N.O. + N.O.	N.C. + N.C. + N.O.; N.C. + N.O. + N.O.
3 slow break contacts ⊕ break before make	—	—	—	N.C. + N.C. + N.O.	N.C. + N.C. + N.O.; N.C. + N.O. + N.O.	N.C. + N.C. + N.O.; N.C. + N.O. + N.O.	N.C. + N.C. + N.O.; N.C. + N.O. + N.O.
2 snap action contacts	N.C. + N.O., N.O. + N.O.	N.C. + N.O.	—	—	—	—	—
4 snap action contacts	N.C. + N.C., N.O. + N.O.	—	—	—	—	—	—
Insulation voltage (Ui) / thermal current (Ithe)	See page 21-10	300 Vac/Vdc 10 A (standard)	Screw terminal 2 contacts: 400 V / 6 A	Pre-cabled 2 contacts: 400 V / 6 A 3 contacts: 400 V / 4 A 4 contacts: 400 V / 3 A	Screw terminal: 2 contacts: 500 V / 10 A 3 contacts: 400 V / 6 A Connector: Integral M12, 4-pin: 250 V / 3 A	Screw terminal: 2 contacts: 500 V / 10 A 3 contacts: 400 V / 6 A Connector: Integral M12, 5-pin: 60 V / 4 A	Screw terminal: 2 contacts: 500 V / 10 A 3 contacts: 400 V / 6 A
Enclosure rating IP = IEC enclosure rating IK = EN shock test standard	None	NEMA Types 1, 2, 4, 6, 6P, 12, 13 IP67	NEMA Types 1, 2, 13 IP65, IK04	NEMA Types 1, 2, 4X, 6, 12 IP66, IP67, IP68, IK06	NEMA Types 1, 2, 4, 6, 6P, 12, 13 IP66, IP67, IK04	NEMA Types 1, 2, 4, 6, 12, 13 IP66, IP67, IK06	NEMA Types 1, 2, 4, 6, 6P, 12, 13 IP66, IK06
Electrical connection	Screw terminal or Faston® connector	Pre-wired cable or M12 connector	Pre-wired cable	Pre-cabled. Connector: Integral or remote M12 or remote 7/8" 16UN	Screw terminal: M16, M20, Pg 11, Pg 13, 1/2" NPT, or PF 1/2 Connector: Integral M12	Screw terminal: M16, M20, Pg 11, Pg 13, 1/2" NPT, or PF 1/2 Connector: Integral M12	Screw terminal: M20 or 1/2" NPT

[1] Flexible operators do not guarantee direct (positive) opening operation.

Product Panorama 2 of 2  
Refer to Catalog 9006CT1007

Design	Standard Duty Industrial				Severe Duty Mill and Foundry	
Catalog number	9007C	XCKJ	XCKS	XCKW	9007T/FT	L100/L300
Page	Standard and Compact, page 21-38	Fixed or Plug-in Body, page 21-38	Double Insulated, page 21-19	Wireless, Batteryless, page 21-23	Convertible Sequences, page 21-42	Fixed Sequences, page 21-45
						
<b>Enclosure</b>	Metal, diecast, zinc alloy	Metal	Plastic, double insulated	Plastic	Metal	Metal
<b>Features</b>	Plug-in body	Optional low or high temperature versions	—	—	Extra heavy duty contact ratings	—
<b>Modularity</b>	Head, body, and lever			Bodies and heads		Lever
<b>Conforming to standards / Product certifications</b>	UL 508, C22-2-14-95, NEMA 250, IEC 60947, EN 60947-1, EN 60947-5-1	CENELEC: EN 50041	CENELEC: EN 50041	EN/IEC 60947-5, EMC 2004/108/EC directive, R&TTE 1999/5/EC directive, CE	NEMA A600 UL508 UL Listed, CSA Certified	NEMA A600 UL508 UL Listed, CSA Certified
<b>Body dimensions</b> w x h x d, mm (in.)	Standard: 39 x 102 x 45 (1.54 x 4.02 x 1.77) Compact: 39 x 80 x 45 (1.54 x 3.15 x 1.77)	40 x 77 x 44 (1.57 x 3.03 x 1.73) 42.5 x 84 x 36 (1.67 x 3.31 x 1.42)	40 x 72.5 x 36 (1.57 x 2.85 x 1.42)	width: 1.57 (40)	58.7 x 114.3 x 64.5 (2.31 x 4.5 x 2.54)	58.7 x 126 x 53.3 (2.31 x 4.95 x 2.10)
<b>Head</b>	Linear movement, plunger Rotary movement, lever Multi-directional movement (wobble stick, cat whisker) [2]	Linear movement, plunger Rotary movement, lever Rotary movement, multi-directional [2]	Linear movement, plunger Rotary movement, lever Rotary movement, multi-directional [2]	Linear movement, plunger Rotary movement, lever Rotary movement, multi-directional [2]	Rotary movement, lever	Rotary movement, lever
<b>Contact blocks</b>						
2 snap action contacts →	—	N.C. + N.O.; N.C. + N.C.	N.C. + N.O.; N.C. + N.C.	—	—	Various options for L100, 2- and 3-pole
2 snap action contacts	—	N.C. + N.O.; N.C. + N.C.	N.C. + N.O.; N.C. + N.C.	—	—	—
3 snap action contacts →	—	N.C. + N.C. + N.O.; N.C. + N.O. + N.O.	N.C. + N.C. + N.O.; N.C. + N.O. + N.O.	—	—	—
3 snap action contacts	—	N.C. + N.C. + N.O.; N.C. + N.O. + N.O.	N.C. + N.C. + N.O.; N.C. + N.O. + N.O.	—	—	—
4 snap action contacts →	—	—	—	—	—	—
4 snap action contacts	—	—	—	—	—	—
2 slow break contacts break before make →	—	N.C. + N.O.	—	—	—	—
2 slow break contacts break before make	—	N.C. + N.O.	—	—	—	—
2 slow break contacts make before break →	—	N.O. + N.C.	—	—	—	—
2 slow break contacts make before break	—	N.O. + N.C.	—	—	—	—
2 slow break contacts simultaneous →	—	N.C. + N.C.	—	—	—	—
2 slow break contacts simultaneous	—	N.O. + N.O.	N.O. + N.O.	—	—	—
3 slow break contacts break before make →	—	N.C. + N.C. + N.O.; N.C. + N.O. + N.O.	N.C. + N.C. + N.O.; N.C. + N.O. + N.O.	—	—	—
3 slow break contacts break before make	—	N.C. + N.C. + N.O.; N.C. + N.O. + N.O.	N.C. + N.C. + N.O.; N.C. + N.O. + N.O.	—	—	—
1 slow break contact Form Y1561 [3]	1 N.C.	—	—	—	—	—
2 snap action contacts	1 N.O. + 1 N.C.	2 C/O	2 C/O	—	1 N.C. + 1 N.O. [4] convertible sequence	1 N.C. + 1 N.O. [4] some convertible
4 snap action contacts	2 N.O. + 2 N.C.; 2 N.O. + 2 N.C., neutral position; 2 N.O. + 2 N.C., two stage	—	—	—	—	—
<b>Insulation voltage (Ui) and thermal current (Ithe)</b>	Ui: 600 V, except 9007C62, 9007C66, 9007C68 (Ui = 250 V) and 9007C84, 9007C86 (Ui: 125 V). Ithe: 10 A, except 9007C84, 9007C86 (Ithe: 2.5 A)	<b>Screw terminal</b> 2 contacts: 500 V / 10 A 3 contacts: 400 V / 6 A <b>Connector:</b> Integral M12, 5-pin: 60 V / 4 A; Integral 7/8" 16UN: 250 V / 6 A	<b>Screw terminal</b> 2 contacts: 500 V / 10 A 3 contacts: 400 V / 6 A	600 V 20 A (AC/DC)	600 V 20 A (AC), 5 A (DC)	
<b>Enclosure rating</b> IP = IEC enclosure rating IK = EN shock test standard	IP67 conforming to IEC 60529; NEMA Types 2, 4, 6, 6P, 12, 13	NEMA Types 1, 2, 4, 12; IP66, IK07	IP65, IK03	IP66 and IP67 conforming to EN/IEC 60529; IK05 conforming to EN/IEC 50102	NEMA Types 1, 2, 4, 12, 13 IP65, 66, 67	NEMA Types 1, 4, 13 IP65, 66
<b>Electrical connection</b>	<b>Cable entry:</b> 1/2"-14 NPT; M20 x 1.5 ISO cable entry. <b>Connector:</b> Integral 5-pin mini-connector	<b>Screw terminal:</b> M20 x 1.5, PG13, or 1/2" PT <b>Connector:</b> Integral M12 or 7/8" 16UN	<b>Screw terminal:</b> M20 x 1.5 or PG13	—	<b>Cable entry:</b> 1/2" NPT or PG13.5	<b>Cable entry:</b> 1/2" NPT or 3/4" NPT. Other options available <b>Connector:</b> 7/8" 16UN or Cannon MS3102E20-AP or equal; other options available

[2] Flexible operators do not guarantee direct (positive) opening operation.  
[3] Single pole only. Refer to page 7-15 for details.  
[4] For other contact options, see catalog 9006CT1007.

Application Data for All Limit Switch Types

Table 21.1: Enclosure Ratings

Type	NEMA Style												IEC Style		
	1	2	3	4	4X	6	6P	7	9	12	13	IP65	IP66	IP67	
▲ Indicates NEMA or IEC Type Rating available for each product															
9007C	▲	▲	▲	▲	▲	▲	▲	▲	▲	▲	▲	▲	▲	▲	
9007CR	▲	▲	▲	▲	▲	▲	▲	▲	▲	▲	▲	▲	▲	▲	
9007FT	▲	▲	▲	▲	▲	▲	▲	▲	▲	▲	▲	▲	▲	▲	
L100/L300	▲	▲	▲	▲	▲	▲	▲	▲	▲	▲	▲	▲	▲	▲	
9007MS/ML [1]	▲	▲	▲	▲	▲	▲	▲	▲	▲	▲	▲	▲	▲	▲	
9007T	▲	▲	▲	▲	▲	▲	▲	▲	▲	▲	▲	▲	▲	▲	
XCKJ	▲	▲	▲	▲	▲	▲	▲	▲	▲	▲	▲	▲	▲	▲	
XCKL	▲	▲	▲	▲	▲	▲	▲	▲	▲	▲	▲	▲	▲	▲	
XCKN & XCNR	▲	▲	▲	▲	▲	▲	▲	▲	▲	▲	▲	▲	▲	▲	
XCKP & XCKT [2]	▲	▲	▲	▲	▲	▲	▲	▲	▲	▲	▲	▲	▲	▲	
XCKS, XCMN	▲	▲	▲	▲	▲	▲	▲	▲	▲	▲	▲	▲	▲	▲	
XCMD, XCKD	▲	▲	▲	▲	▲	▲	▲	▲	▲	▲	▲	▲	▲	▲	

Table 21.2: Ambient Temperature Ranges

Type	Low Temperature	High Temperature at Full Rated Load
9007 C		
Lever Type	-20 °F (-28.9 °C)	+185 °F (+85 °C)
Plunger & Wobble Stick Type	0 °F (-17.8 °C)	+185 °F (+85 °C)
9007 FT [3], T	-10 °F (-23 °C)	+185 °F (+85 °C)
HL100/HL300	0 °F (-17.8 °C)	+350 °F (+177 °C)
L100/L300	0 °F (-17.8 °C)	+200 °F (+93 °C)
9007 MS/ML	-4 °F (-20 °C)	+221 °F (+105 °C)
XCKJ, XCKL, XCKP, XCKT	-13 °F (-25 °C)	+158 °F (+70 °C)
XCMN, XCKN, XCNR	-13 °F (-25 °C)	+158 °F (+70 °C)
XCKS	-13 °F (-25 °C)	+158 °F (+70 °C)
XCMD	-13 °F (-25 °C)	+158 °F (+70 °C)

Some switches are available with higher or lower temperature limits, by selecting special versions or special options. Refer to the respective product sections for further information. (Ex.: 9007MS/ML, see page 21-9.)

Table 21.3: Sealing

Type	Material
Standard shaft seals on lever types	Fluorocarbon rubber (FKM)
9007C, CR	
Plunger and wobble stick boots	Neoprene; Fluorocarbon optional
All other seals	Nitrile (Buna N); Fluorocarbon optional
R.B.Denison™ L	PVC
9007T and FT	
Shaft seal	Nitrile (Buna N)
Cover gasket	Nitrile (Buna N)
Base plate gasket	Cellulose fiber laminate
XCKJ, XCKL, XCKS	Nitrile (Buna N)
XCMD, XCKD, XCKP, XCKT, XCKN, XCNR	Nitrile (Buna N) and silicon

Table 21.4: Electrical Contact Ratings

V	AC—NEMA A600					DC			
	Max. Current—35% Power Factor					Maximum Current			
	Make	Break	Continuous Carrying Amperes			Make or Break	Continuous Carrying Amperes		
	A	VA	A	VA		A	VA		
120	60	7200	6	720	10	125	1.1/0.55 [4]	138/69 [4]	5/2.5 [4]
240	30	7200	3	720	10	—	—	—	—
480	15	7200	1.5	720	10	250	0.27	67.5	2.5
600	12	7200	1.2	720	10	600	0.10	60	2.5

Table 21.5: Contact Function Diagrams

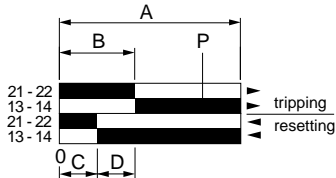

A=Maximum travel of the operator in mm or degrees.  
B=Tripping travel of the contact.  
C=Reset travel.  
D=B-C=Differential travel.  
P=Point from which positive opening is assured

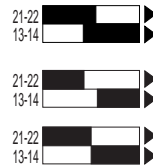

**Make-before-break (overlapping) SPDT**  
The normally open contact closes before the normally closed contact opens.

**Break-before-make (offset) SPDT**  
The normally closed contact opens before the normally open contact closes.

**Simultaneous make and break—SPDT**  
The normally closed contact opens at the same time as the normally open contact closes.

Table 21.6: Wiring Diagrams

Form A	Form B	Form C	Form AA	Form BB	Form CC	Form X	Form Y	Form Zb	Form Z	Form XX	Form YY	Form ZZ
SPST-NO	SPST-NC	SPDT	DPST-NO	DPST-NC	DPDT	SPST-NO-DB	SPST-NC-DB	SPDT-DB Isolated Contacts	SPDT-DB	DPST-NO-DB	DPST-NC-DB	DPDT-DB

[1] Enclosure ratings are NEMA 1, 2, 3, 4, 6, 6P, 12, and 13 except for option 21 (low force) which is NEMA 1 only. The 9007 MS/ML05 (omni-directional operation) enclosure ratings are NEMA 1, 2, 12, and 13

[2] For indoor use only—not UV protected.

[3] The Type FT will withstand hot falling sand up to +300°F (+149 °C); however, ambient temperature for the FT switch is the same as the Type T above (+185 °F, +85 °C). Do not use in higher temperature ambients.

[4] Type C52 compact unit ratings at 125 Vdc—same ratings as C54, CF53 and CR53 at other voltages.



**Contact Configurations**

**Contact Configurations**—Direct opening contacts meet IEC 60947-5-1 requirements. For contacts used in safety applications (end of travel, emergency stop device, etc.) the assurance of direct opening is required (see IEC 204, EN 60204, or NF C 79–130) after each test. The opening of the contact must be verified by testing with an impulse voltage (2500 V).

**Table 21.7: Maximum Current Ratings for Control Circuit Contacts—All Types**

Switch Type	Contacts	Direct Opening Contacts Meet IEC 60947-5-1 Requirements	AC—50 or 60 Hz						DC			AC/DC Continuous Carrying Amperes
			V	Inductive 35% Power Factor				Resistive 75% Power Factor Make and Break Amperes	Inductive and Resistive			
				Make		Break			Single Pole	Double Pole		
				A	VA	A	VA					
L100/L300	SPDT with 2 or 3 Contacts Form Z	No	120 240 480 600	150 75 37.5 30	18000 18000 18000 18000	20 12.5 6.25 5	2400 3000 3000 3000	6 3 1.5 1.2	125 250 600 —	1.1 0.55 0.2 —	—	20/5
XCKD 2 Contacts	SPDT Form Zb	Yes	120 240	60 30	7200 7200	6 3	720 720	6 3	125 250	0.55 0.27	—	10/2.5
XCKD 3 Contacts	3 Pole Form Zb	Yes	120 240	30 15	3600 3600	3 1.5	360 360	3 1.5	125 250	0.27 0.11	—	5/1.0
XCKJ Plug-in	SPDT Form Z	No	120 240	60 30	7200 7200	6 3	720 720	6 3	125 250	0.55 0.27	—	10
	2 SPDT Form ZZ	No	480 600	15 12	7200 7200	1.5 1.2	720 720	1.5 1.2	600 —	0.1 —	—	10 10
XCKJ Non-plug-in	SPDT Form Zb	Yes	120 240	60 30	7200 7200	6 3	720 720	6 3	125 250	0.55 0.27	—	10/2.5 10
	2 SPDT Form ZZ	No	120 240	60 30	7200 7200	6 3	720 720	6 3	125 250	0.55 0.27	—	10/2.5 10
XCKL	SPDT Form Zb	Yes	120 240	60 30	7200 7200	6 3	720 720	6 3	125 250	0.55 0.27	—	10
XCKN	2 Pole	Yes	120 240	60 30	7200 7200	6 3	720 720	6 3	125 250	0.55 0.27	—	10/2.5
XCKP 2 Contacts	SPDT Form Zb	Yes	120 240	60 30	7200 7200	6 3	720 720	6 3	125 250	0.55 0.27	—	10/2.5
XCKP 3 Contacts	3 Pole Form Zb	Yes	120 240	30 15	3600 3600	3 1.5	360 360	3 1.5	125 250	0.22 0.11	—	5/1.0
XCKT 2 Contacts	SPDT Form Zb	Yes	120 240	60 30	7200 7200	6 3	720 720	6 3	125 250	0.55 0.27	—	10/2.5
XCKT 3 Contacts	3 Pole Form Zb	Yes	120 240	30 15	3600 3600	3 1.5	360 360	3 1.5	125 250	0.22 0.11	—	5/1.0
XCMD 2-4 Contacts	2,3 or 4 Pole Form Zb	Yes	120 240	30 15	3600 3600	3 1.5	360 360	3 1.5	125 250	0.22 0.11	—	5/1.0
XCMN 2 Contacts	SPDT Form Zb	Yes	120 240	30 15	3600 3600	3 1.5	360 360	3 1.5	125 250	0.22 0.11	—	5/1.0
XCNR	2 Pole	Yes	120 240	60 30	7200 7200	6 3	720 720	6 3	125 250	0.55 0.27	—	10/2.5
9007AO1, AC	SPST, Form X or Y (rated 0.5 hp @ 110 and 200 Vac) SPDT, Form Z	No	120 240 480 600	40 20 10 8	4800 4800 4800 4800	15 10 6 5	1800 2400 2880 3000	15 10 6 5	125 250 600 —	0.5 0.25 0.05 —	0.25 0.1 — —	15
9007AO2, AO6, AB, AP	SPST, Form X or Y (rated 0.5 hp @ 110 and 200 Vac) SPDT, Form Z	No	120 240 480 600	40 20 10 8	4800 4800 4800 4800	15 10 6 5	1800 2400 2880 3000	15 10 6 5	125 250 600 —	2.0 0.5 0.1 —	0.5 0.2 0.02 —	15
9007CO3, CO6, CB, CC, CP	DPST Form AA or BB DPDT Form ZZ	No	120 240 480 600	30 15 7.5 6	3600 3600 3600 3600	3 1.5 0.75 0.6	360 360 360 360	3 1.5 0.75 0.6	125 250 600 —	1.0 0.3 0.1 —	0.2 0.1 — —	10
9007C	SPST Form Y1561 Slow break	Yes	120 240 480 600	60 30 15 12	7200 7200 7200 7200	6 3 1.5 1.2	720 720 720 720	6 3 1.5 1.2	125 250 600 —	0.55 0.27 0.1 —	—	10/2.5
	SPDT Form Z	No	120 240 480 600	60 30 15 12	7200 7200 7200 7200	6 3 1.5 1.2	720 720 720 720	6 3 1.5 1.2	125 250 600 —	0.55 0.27 0.1 —	0.22 0.11 — —	10/2.5
	DPDT Form ZZ	No	120 240 480 600	60 30 15 12	7200 7200 7200 7200	6 3 1.5 1.2	720 720 720 720	6 3 1.5 1.2	125 250 600 —	0.22 0.11 — —	0.22 0.11 — —	10/1.0
9007MS	SPDT Form C	No	120 240	60.0 30.0	7200 7200	6.0 3.0	720 720	—	—	—	—	10 (AC) / 5 (Res. @ 28 Vdc)
9007ML	SPDT Form Z	No	120 240	60.0 30.0	7200 7200	6.0 3.0	720 720	—	—	—	—	10 (AC) / 5 (Res. @ 28 Vdc)
9007T and FT	SPDT Quick Make and Break Form Z	No	120 240 480 600	150 75 37.5 30	18000 18000 18000 18000	20 12.5 6.25 5	2400 3000 3000 3000	20 12.5 6.25 5.0	125 250 600 —	5.0 1.0 0.2 —	—	20
	All Slow Make and Break Form Z	No	120 240 480 600	60 30 15 12	7200 7200 7200 7200	6 3 1.5 1.2	720 720 720 720	6 3 1.5 1.2	—	—	—	20

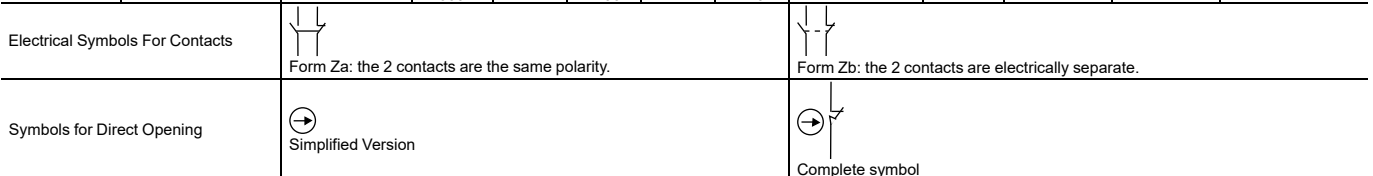

**NOTE:** Alternate Current Ratings—Several product lines offer special versions or options with alternate contact configurations or contact materials, which may result in current ratings that differ from those listed above. Refer to the respective product sections for further information.

Industrial Snap Switches Without Enclosures



Type AO2



Type AB21



Type AP222 with 2358C22G6 mushroom button

Industrial snap switches have been incorporated in many Square D products such as timers, specialty push buttons, foot switches, operating mechanisms, door interlocks, motor control centers, limit switches, and many other control products.

**Recommended Actuator:** An adjustable actuator is recommended. If nonadjustable actuator is used, a resilient type or a mechanical stop should be used to prevent "bottoming" of button mechanism.

**Adjustable Actuator Overtravel:** Minimum recommended overtravel in both trip and reset directions is 0.015 in.

**Adjustable Actuator Total Travel:** Maximum differential limit plus 0.030 in. (Example: 0.076 in. for Type AO2.)

**Nonadjustable Actuator Total Travel:** Fully retracted—at least 0.139 in. for Type AO1 and 0.160 in. for Types AO2 and CO3 from mounting surface. Fully engaged—at least 0.061 in. but not closer than 0.045 in. from mounting surface.

**Contact Configurations:** Single-pole snap switches that contain two double-break contact elements (1 N.O. and 1 N.C.) must be used on circuits of the same polarity. Double-pole snap switches contain two electrically separated sets of contact elements allowing use on circuits of opposite polarity. Each set contains two double-break contact elements (1 N.O. and 1 N.C.) that must be used on circuits of the same polarity.

Table 21.8: Quick Make and Break—600 Volts Max. AC and DC

Operator Style	Contact Arrangement	Type	Operator Style	Contact Arrangement	Type
Basic Snap Switch	1 N.O. 1 N.C.	AO1	Cabinet Door Style	1 N.O. 1 N.C.	AC1
	1 N.O.	AO1B		2 N.O. 2 N.C.	CC1
	1 N.O. 1 N.C.	AO2	Plunger Style Panel Mounting	1 N.O. 1 N.C.	AP221
	1 N.C. (Plug-in)	AO6 (Plug-in)		2 N.O. 2 N.C.	CP221
	1 N.O.	AO2A		Operator Only	AP201
	1 N.O.	AO2B			
	2 N.O. 2 N.C.	CO3	Roller Plunger Style Panel Mounting Non-Oiltight	1 N.O. 1 N.C.	AP321 [1]
	2 N.O.	CO6 (Plug-in)		2 N.O. 2 N.C.	CP321
Two Stage 2 N.O. 2 N.C.	CO7	Operator Only		AP301 [1] AP304 [2]	
Rigid Roller Lever Style	1 N.O. 1 N.C.	AB21 (RH) AB22 (LH)	Roller Plunger Style Panel Mounting Oiltight	1 N.O. 1 N.C.	AP323
	7/32" width roller	AB41 (without side mtg. bracket)		2 N.O. 2 N.C.	CP323
	1 N.O. 1 N.C.	AB23 (RH) AB24 (LH)	Operator Only	AP303 [1] AP305 [1][2]	
	15/32" width roller	CB31 (RH) CB41 (without side mtg. bracket)			
	2 N.O. 2 N.C.	CB33 (RH) CB34 (LH)			
	7/32" width roller				
	2 N.O. 2 N.C.	CB33 (RH) CB34 (LH)			
	15/32" width roller				
Rigid Roller Lever Style One Way Roller	1 N.O. 1 N.C.	AB25 (RH)	Mushroom Button Style Panel Mounting	1 N.O. 1 N.C.	AP222

Table 21.9: Maximum Current Ratings For Control Contacts—All Types

Switch Type	Contacts [3]	AC—50 or 60 Hz						DC			AC or DC Continuous Carrying Amperes
		Voltage	Inductive 35% Power Factor				Resistive 75% Power Factor Make and Break Amperes	Voltage	Inductive and Resistive		
			Make		Break				Make and Break Amperes		
			A	VA	A	VA			Single Pole	Double Pole	
AO1, AC	SPDT	120	40	4800	15	1800	15	125	0.5	0.25	15
	Form Z	240	20	4800	10	2400	10	250	0.25	0.1	15
	SPST	480	10	4800	6	2880	6	600	0.05	—	15
	Form X or Y	600	8	4800	5	3000	5	—	—	—	15
AW, AO2, and AO6, AB, AP	SPDT	120	40	4800	15	1800	15	125	2.0	0.5	15
	Form Z	240	20	4800	10	2400	10	250	0.5	0.2	15
	SPST	480	10	4800	6	2880	6	600	0.1	0.02	15
	Form X or Y	600	8	4800	5	3000	5	—	—	—	15
AW, CO3, and CO6, CB, CC, CP	DPDT	120	30	3600	3	360	3	125	1.0	0.2	10
	Form ZZ	240	15	3600	1.5	360	1.5	250	0.3	0.1	10
	DPST	480	7.5	3600	0.75	360	0.75	600	0.1	—	10
	Form AA or BB	600	6	3600	0.6	360	0.6	—	—	—	10

Acceptable Wire Size 14–22 AWG  
Recommended Terminal Clamp Torque 6–9 lb-in (0.7–1.0 N•m)



[1] For use with Type AO and CO basic switches.  
[2] Roller turned 90° from standard (perpendicular to mounting holes).  
[3] Do not meet IEC 60947–5–1 requirements for direct opening contacts

**Approximate Dimensions and Operating Data, 9007AO, CO, AP, and CP**

Approximate Dimensions and Operating Data, 9007AO, CO, AP, and CP

**9007AO, Single-Pole Snap Switch**

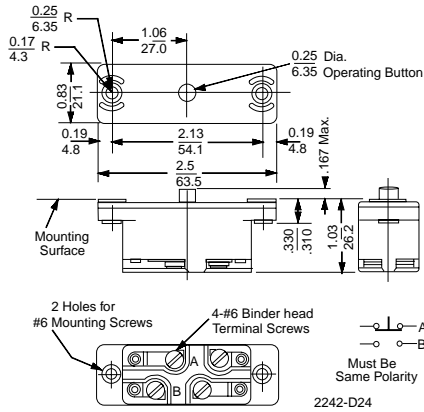

**9007CO, Two-Pole Snap Switch**

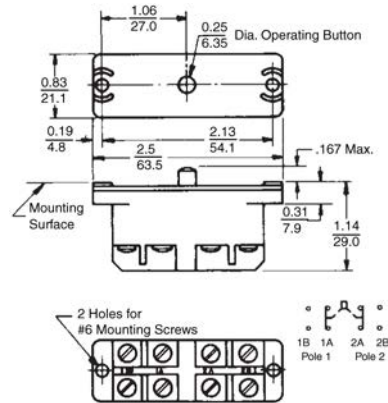

	Operating Data, in. (mm)	
	AO1, 1B	AO2, 2A, 2B
Pre-travel	0.057–0.074 (1.4–1.8)	0.057–0.074 (1.4–1.8)
Differential	0.015–0.025 (0.6–0.6)	0.035–0.046 (0.9–1.16)
Total travel	0.103–0.125 (2.6–3.2)	0.103–0.125 (2.6–3.2)
Operating force	7–11 oz (0.05–0.08 N)	10–14 oz (0.07–0.1 N)
Shipping weight	0.25 lb (0.11 kg)	0.25 lb (0.11 kg)

	Operating Data, in. (mm)	
	CO3	C07
Pre-travel 1st stage	0.057–0.074 (1.4–1.8)	0.035–0.060 (0.9–1.5)
Pre-travel 2nd stage	—	0.060–0.085 (1.5–2.1) [4]
Differential	0.025–0.046 (0.6–1.16)	0.010–0.020 (0.25–0.50)
Total travel	0.103–0.125 (2.6–3.2)	—
Operating force	7–12 oz (0.05–0.084 N)	7–12 oz (0.05–0.084 N)
Shipping weight	0.25 lb (0.11 kg)	0.25 lb (0.11 kg)

**9007AP201, 221, and CP221**

**9007AP201**

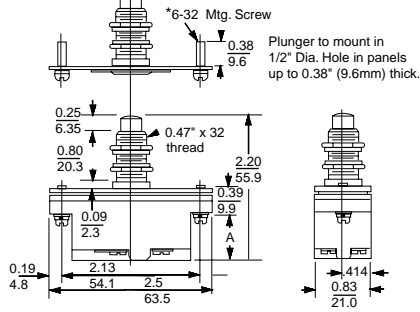

**9007AP221**

**9007AP301, 303, 304, 305, 321, 323, 324, 325, and CP321, 323, 324, 325**

**9007AP301**

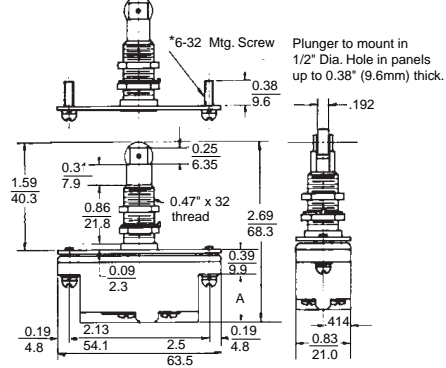

**9007AP321**

Type	Dimension A
AP221	0.70 (17.8)
CP221	0.80 (20.3)

	Operating Data, in. (mm)	
	AP221	CP221
Pretravel	0.070–0.089 (1.8–2.2)	0.070–0.089 (1.8–2.2)
Differential	0.035–0.046 (0.9–1.2)	0.025–0.046 (0.9–1.2)
Overtravel	0.161–0.180 (4.1–4.6)	0.161–0.180 (4.1–4.6)
Total travel	0.231–0.269 (5.8–6.8)	0.231–0.269 (5.8–6.8)
Operating force	10–14 oz (0.07–0.1 N)	7–12 oz (0.05–0.08 N)
Shipping weight	0.25 lb (0.11 kg)	0.25 lb (0.11 kg)

Type	Dimension A
AP321, 323, 324, 325	0.70 (17.8)
CP321, 323, 324, 325	0.80 (20.3)

	Operating Data, in. (mm)			
	AP321	AP323, 325	CP321	CP323
Pretravel	0.060–0.150 (1.5–3.8)	0.060–0.150 (1.5–3.8)	0.060–0.150 (1.5–3.8)	0.060–0.150 (1.5–3.8)
Differential	0.035–0.046 (0.9–1.2)	0.035–0.046 (0.9–1.2)	0.035–0.046 (0.9–1.2)	0.035–0.046 (0.9–1.2)
Total travel	0.200–0.340 (5.1–8.6)	0.200–0.340 (5.1–8.6)	0.200–0.340 (5.1–8.6)	0.200–0.340 (5.1–8.6)
Operating force	20 oz (0.14 N)	28 oz (0.2 N)	26 oz (0.18 N)	28 oz (0.2 N)

[4] Separation between first and second stage trip points is 0.020–0.025 (0.5–0.6).

Miniature MS Limit Switch



The heavy-duty, miniature MS limit switch is completely encapsulated and intended for difficult applications such as machine tools, earth moving equipment, and general transportation. 9007MS04S0084

The switch has 40 mm mtg hole centers.

MS Circuit—Form C	Electrical Ratings/SPDT Form C (MS Type)			
	Silver Contacts			Gold Contacts
1 N.O.—1 N.C.	Vac	Make	Break	
	120	60 A	6 A	
	240	30 A	3 A	
	10.0 Amperes Continuous			
DC Contact Rating: 5 A (Res), 28 Vdc				

ML Circuit—Form Z	Electrical Ratings/SPDT-DB Form Z (ML Type)		
	Silver Contacts		
1 N.O.—1 N.C.	Vac	Make	Break
	120	60 A	6 A
	240	30 A	3 A
	10.0 Amperes, Continuous		
DC Contact Rating: 5 A (Res), 28 Vdc			

Table 21.10: Specifications

Temperature range (The minimum temperatures listed are based on the absence of freezing moisture or water.)	-4 °F to +221 °F (-20 °C to +105 °C) For -40 °F / -40 °C minimum temperature, see Forms 21 and 80 on page 21-9.
Enclosure rating	NEMA 1, 2, 4, 6, 6P, 12, 13, IP67
Vibration resistance	10 G (75–1200 Hz)
Shock resistance	35 G
<b>Contact Characteristics</b>	
Rated thermal current	10 A (standard)
Rated insulation voltage	300 Vac and Vdc (standard)
Gold contact switching ratings	0.1A, 24 Vdc; 0.24 VA
Cable	#18 AWG SJTO

Table 21.11: Selection (append prefix 9007 to the catalog number)

Description / Functional Diagram [1]	MS	ML	Operating Force/Torque	Contact Form	Contact Type	Catalog Number [2]
<b>Top plunger</b>			80 oz	SPDT Form C	Silver	MS01S0100
			80 oz	SPDT Form C	Gold	MS01G0100
			80 oz	SPDT Form Z	Silver	ML01S0100
<b>Parallel roller plunger</b>			80 oz	SPDT Form C	Silver	MS02S0100
			80 oz	SPDT Form C	Gold	MS02G0100
			80 oz	SPDT Form Z	Silver	ML02S0100
<b>Cross roller plunger</b>			80 oz	SPDT Form C	Silver	MS03S0100
			80 oz	SPDT Form C	Gold	MS03G0100
			80 oz	SPDT Form Z	Silver	ML03S0100
<b>Rotary lever, CW and CCW</b>			48 oz-in	SPDT Form C	Silver	MS04S0100
			48 oz-in	SPDT Form C	Gold	MS04G0100
Not included (see Table 21.14 on page 21-9)			48 oz-in	SPDT Form Z	Silver	ML04S0100
<b>Omnidirectional—wire whisker (NEMA 1, 2, 12, 13 only)</b>			15 oz-in	SPDT Form C	Silver	MS05S0100
			15 oz-in	SPDT Form C	Gold	MS05G0100
<b>Bushing mounted—top plunger</b>			80 oz	SPDT Form C	Silver	MS06S0100
<b>Bushing mounted—parallel roller plunger</b>			80 oz	SPDT Form C	Silver	MS07S0100
			80 oz	SPDT Form C	Gold	MS07G0100
			80 oz	SPDT Form Z	Silver	ML07S0100
<b>Bushing mounted—cross roller plunger</b>			80 oz	SPDT Form C	Silver	MS08S0100
<b>Adjustable top plunger</b>			80 oz	SPDT Form C	Silver	MS09S0100
			80 oz	SPDT Form Z	Silver	ML09S0100

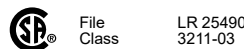





[1] If the application includes oil, booting switches are recommended. See page 21-9

[2] For available options and part number explanations, see page 21-9. Add options to the end of the catalog number. Up to three options may be added, if applicable.

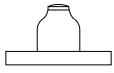
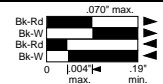
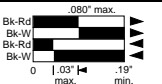
**Lever Arms and Options**

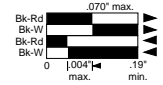
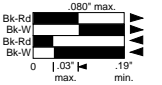
**Table 21.12: Selection—Booted Devices (append prefix 9007 to the catalog number)**

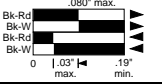
Description / Functional Diagram	MS	ML	Operating Force/Torque	Contact Form	Contact Type	Catalog Number [3]/[4]
			80 oz	SPDT Form C	Silver	MS10S0100
			80 oz	SPDT Form C	Gold	MS10G0100
			80 oz	SPDT Form Z	Silver	ML10S0100
			80 oz	SPDT Form C	Silver	MS12S0100
			80 oz	SPDT Form Z	Silver	ML12S0100
			80 oz	SPDT Form C	Silver	MS13S0100

**Table 21.13: Cable Length and General Options Designators: 9007MS01Sxxy**

Replace xx and yy in the catalog number above with the designators in the tables below. Some combinations of cable lengths and options are unavailable; consult Schneider Electric.

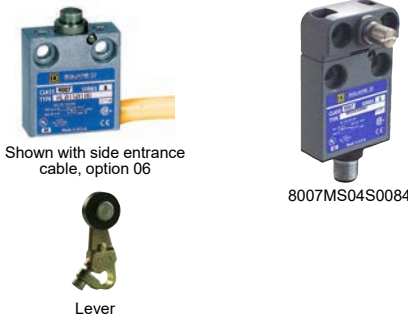

Cable Length (xx) [5]	Designator	General Options (yy) [3]	Designator
No cable [6]	00	#16 AWG SJTO cable (MS only)	02
3 ft—standard	01	Side entrance #18 AWG SJTO cable	06
6 ft	02	Gray #18 AWG SJTO cable	10
9 ft	03	Male 4 pin micro-connector in housing (DC type) (MS only)	54
12 ft	04	Male 5 pin micro-connector (DC type) (ML only)	55
18 ft	05	Low temperature (-40 °F / -40 °C), 9007MS04 (NEMA 1 only)	80
33 ft	13	Tapped holes in top of plunger housing (MS and ML)	81
		Male 4 pin micro-connector in housing (AC type) (MS only)	82
		Male 4-pin micro-connector in housing (AC type) (no cable)	84

**Table 21.14: Style 7 Levers—0.75 in. (19 mm) diameter, nylon or steel roller (9007 prefix is not required on lever catalog numbers)**

Length		Catalog Number 1/4 in. (6 mm) Wide		Catalog Number 1/2 in. (13 mm) Wide		Catalog Number 3/4 in. (19 mm) Wide	Catalog Number 1 in. (25 mm) Wide
inch	(mm)	Nylon	Steel	Nylon	Steel	Nylon	Nylon
0.875	(22.23)	7A2N	7A2	7B2N	7B2	—	—
1.375	(34.93)	7A3N	—	7B3N	—	7F3N	—
1.5	(38.10)	7A1N	7A1	7B1N	—	7F1N	7J1N
1.75	(44.45)	7A7N	—	—	—	—	—
2.00	(50.8)	7A4N	—	7B4N	—	7F4N	7J4N

**NOTE:** Lever tightening torque for mounting the lever on the shaft: minimum 17 lb-in. Other levers available. See catalog 9006CT1007. For inside (reverse) roller option at no charge, replace 7 with 7X (for example: 7A2N changes to 7XA2N).

**Table 21.15: Specialty Arms (9007 prefix is not required on lever catalog numbers)**

Description	Catalog Number
Style 7D adjustable length 1-3/8" to 3-3/8"—0.75" diameter, 1/4" wide, metal roller	7D
Style 7DN adjustable length 1-3/8" to 3-3/8"—0.75" diameter, 1/4" wide, nylon roller	7DN
Style 7S spring nylon, 6" rod, 0.3" diameter	7S
Style 7N nylon rod, 5" long, 0.3" diameter	7N

**NOTE:** Lever tightening torque for mounting the lever on the shaft: minimum 17 lb-in.

**Male plug (face) pin-outs**

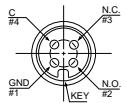

Option 54 (MS only)—DC

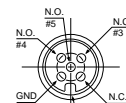

Option 55 (ML only)—DC

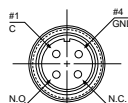

Option 12 (MS only)—AC or DC (3 Amps)

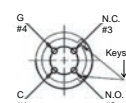

Option 82 (MS only)—AC

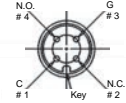

Option 84 (MS only)—AC

**NOTE:** DC connectors are rated 3 A, 250 Vac/Vdc.

[3] See available options below. Add to the end of the catalog number. Up to three options may be added, if applicable.  
 [4] This catalog number is for devices with a standard cable and no options. See page for other cable length selections and general options.  
 [5] See available options below. Add to the end of the catalog number. Up to three options may be added, if applicable.  
 [6] Use with options 54, 55, and 82.

Overview — Metal

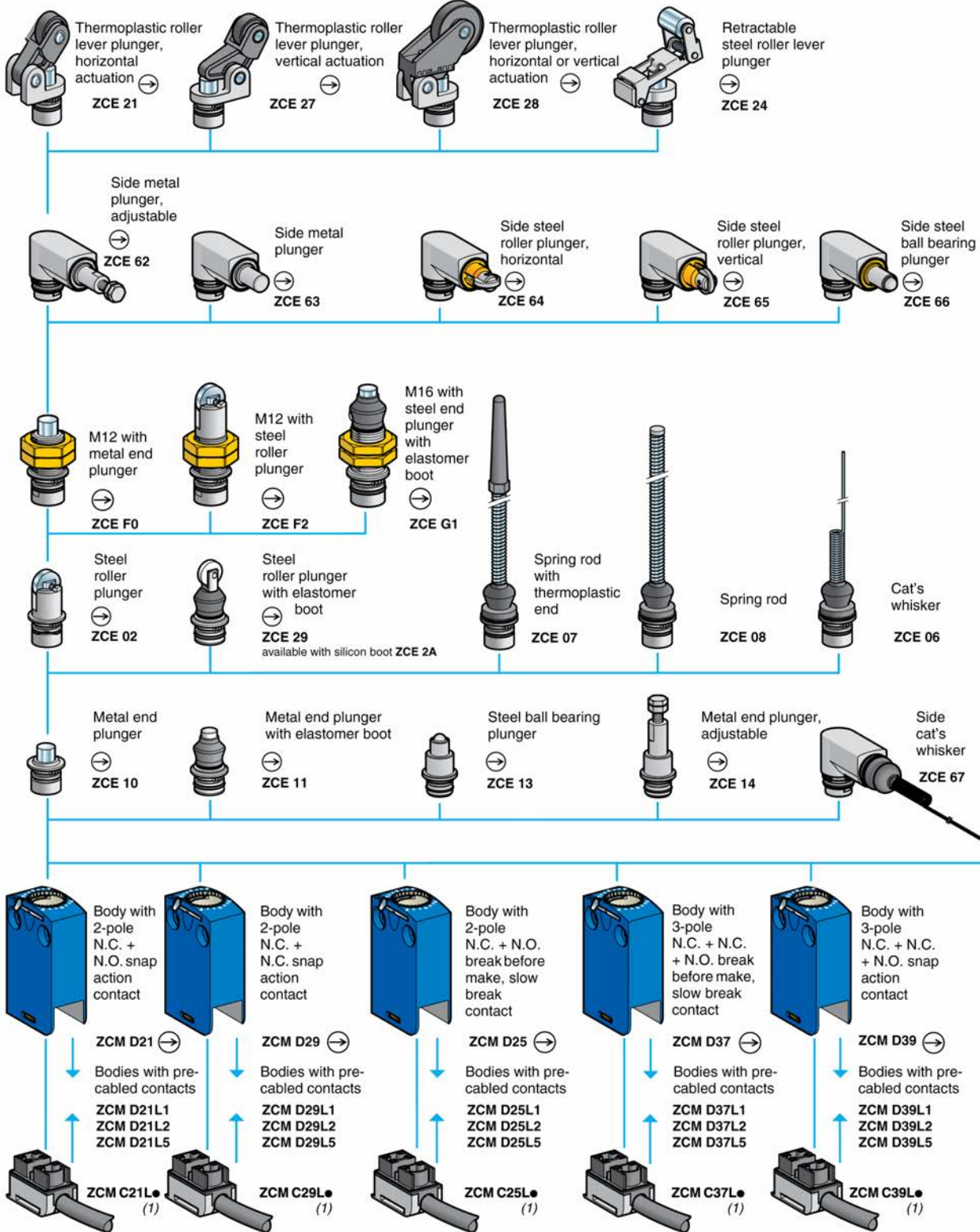

1. Pre-cabled connection components: replace the bullet (●) in the catalog number with the required cable length in meters, either 1, 2, 3, 5, 7 or 10. Example: ZCMC21● becomes ZCMC21L7 for a 7 m (23.0 ft) cable. Note: only cable lengths of 1, 2 and 5 m (3.3, 6.6, and 16.4 ft) are available for pre-cabled connection components ZCMC37L● and ZCMC39L●.

Dimensions: mm (in.)

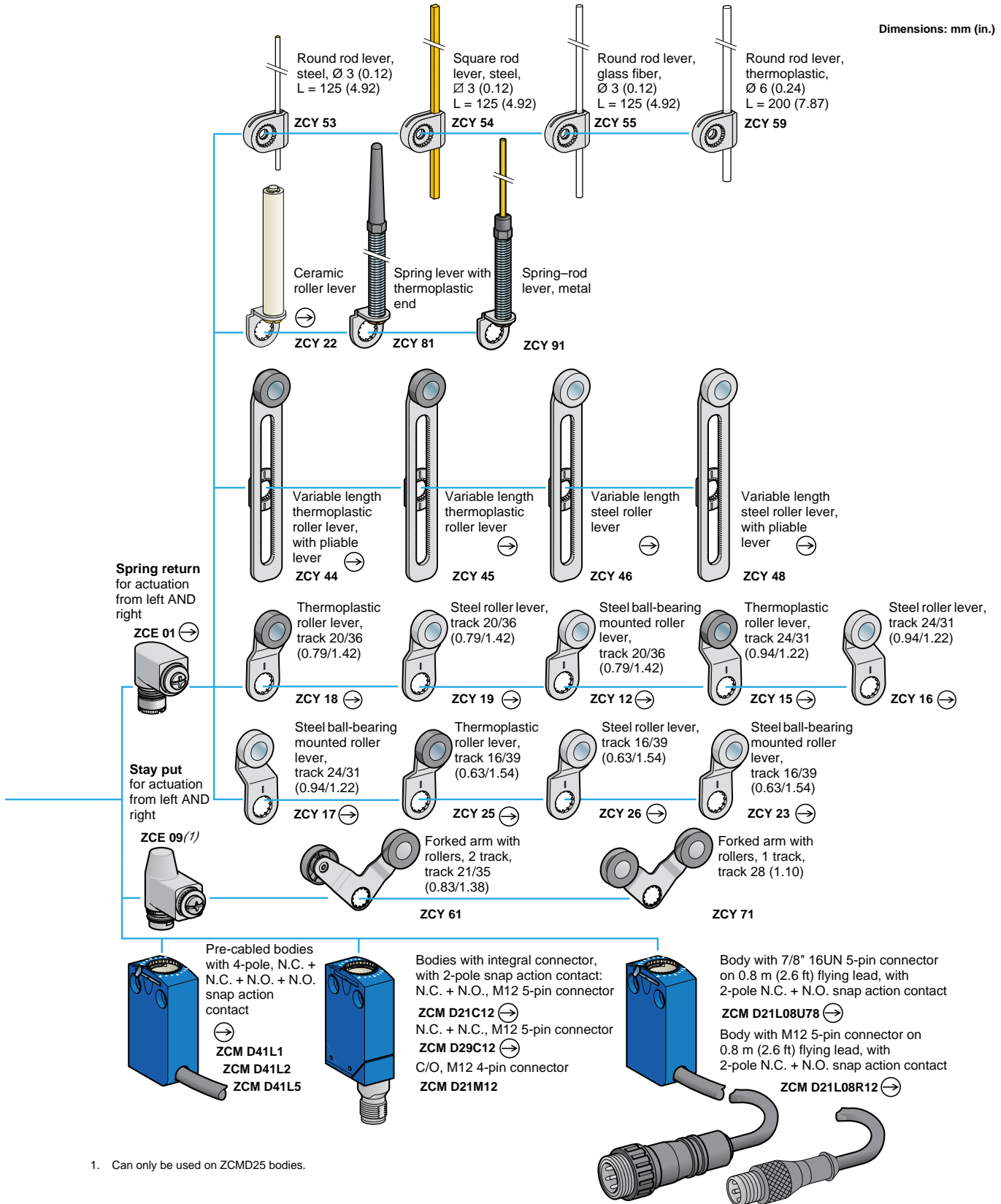

1. Can only be used on ZCMD25 bodies.

Overview — Metal and Plastic

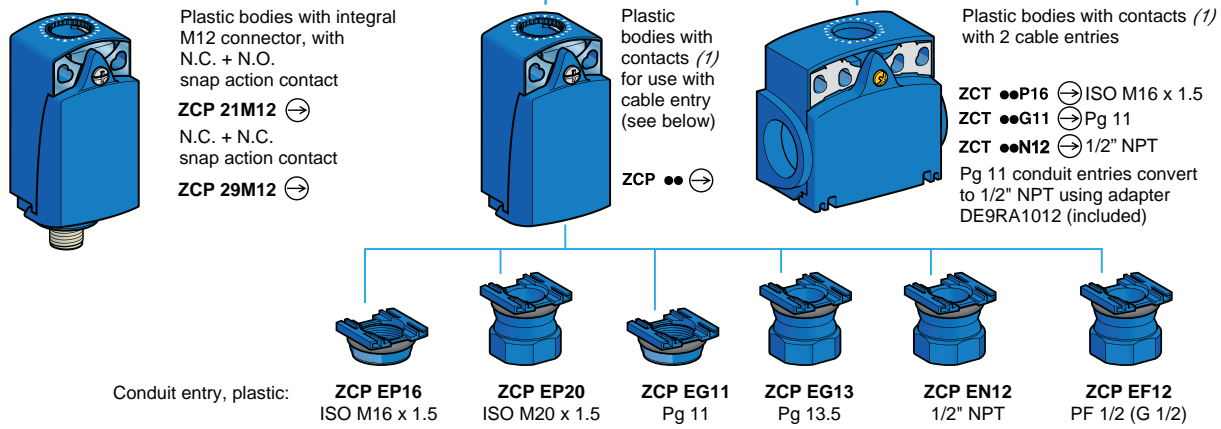
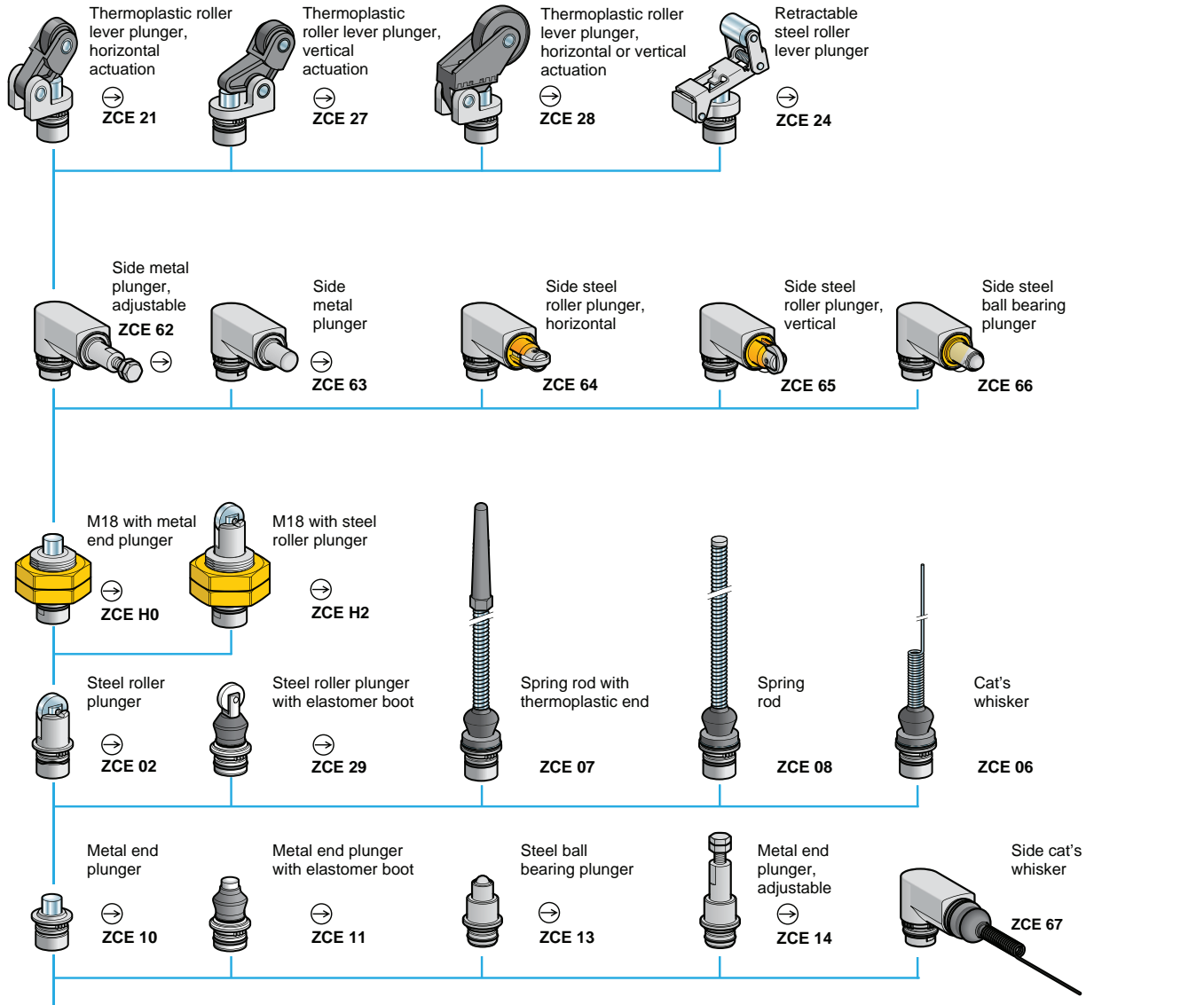

1. For further details, see catalog 9006CT1007.



Dimensions: mm (in.)

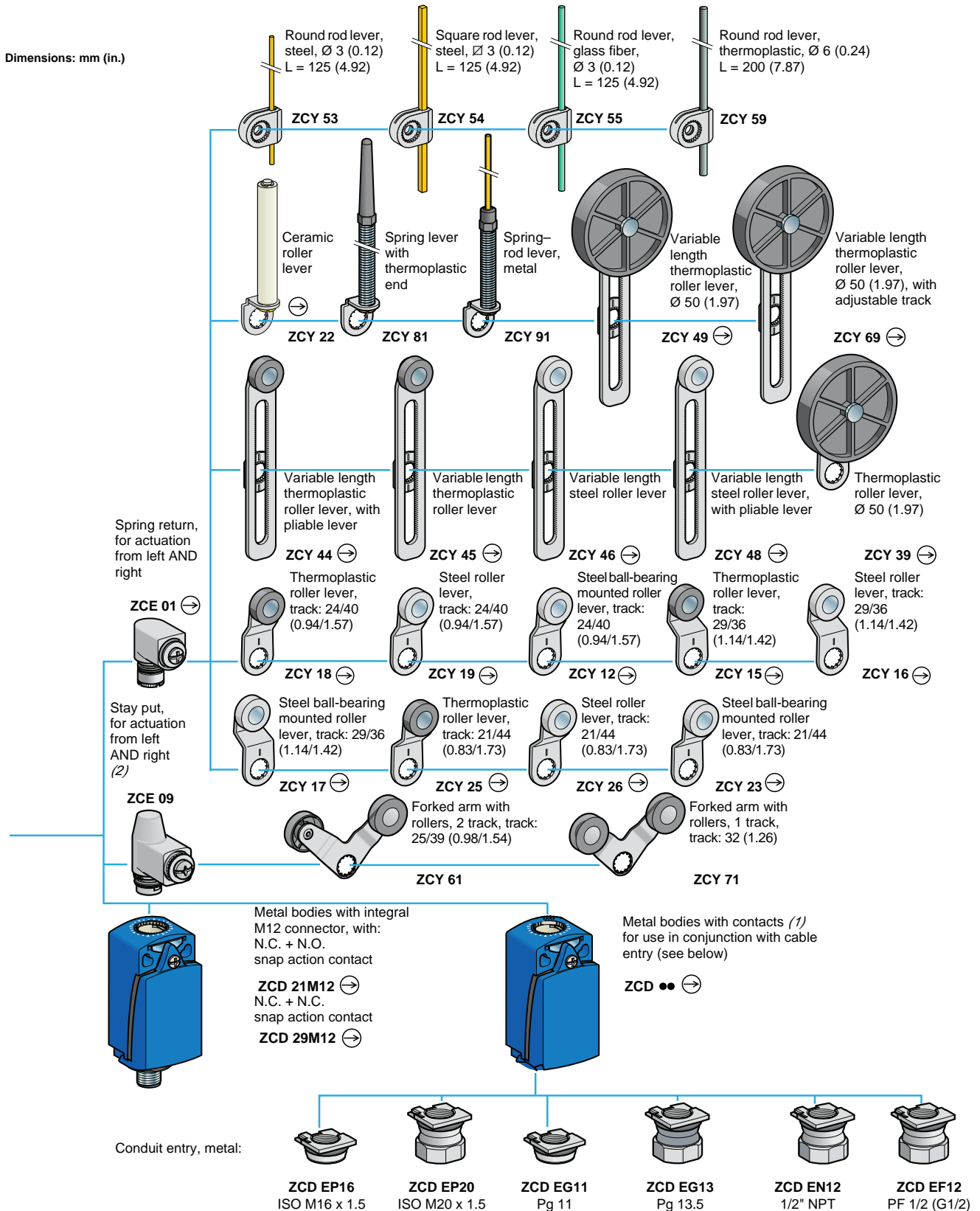

1. For further details, see catalog 9006CT1007.

Miniature, Precabled Limit Switches, Metal

Table 21.16: XCMD Modular and XCMN Non-Modular

OsiSense XCMD, XCMN	Steel Roller Plunger	Plastic Roller Lever	Variable Length Plastic Roller Lever	M12 Head Steel Roller Plunger	Cat Whisker	End Plunger (non-modular)
<p>2-pole contact N.C. + N.O. snap action</p>						
Actuation speed (m/s)	0.5	1.5	1.5	0.1	1	0.5
Switches conforming to IEC 60947-5-1 section 3	yes	yes	yes	yes	no	yes
Degree of protection conforming to IEC 60529	IP66 and IP67	IP66 and IP67	IP66 and IP67	IP66 and IP67	IP66 and IP67	IP65
Rated operational characteristics	Vac 15; B 300 (Ue = 240 V, Ie = 1.5 A) / Vdc 13; R 300 (Ue = 250 V, Ie = 0.1 A)					
Cable entry	pre-cabled, adjustable direction, length = 1 m (other lengths available on request)					pre-cabled length = 1 m
Mounting holes—in. (mm)	0.79 (20)	0.79 (20)	0.79 (20)	0.79 (20)	0.79 (20)	0.79 (20)
Body dimensions—in. (mm), W x D x H	1.18 x 0.63 x 2.32 (30 x 16 x 59)	1.18 x 0.63 x 2.32 (30 x 16 x 59)	1.18 x 0.63 x 2.32 (30 x 16 x 59)	1.18 x 0.63 x 2.32 (30 x 16 x 59)	1.18 x 0.63 x 2.32 (30 x 16 x 59)	1.18 x 0.63 x 2.32 (30 x 16 x 59)
Ordering information	Cat. No.	Cat. No.	Cat. No.	Cat. No.	Cat. No.	Cat. No.
2-pole, N.C. + N.O. snap action	XCMD2102L1	XCMD2115L1	XCMD2145L1	XCMD21F2L1	XCMD2106L1	XCMN2110L1
2-pole, N.C. + N.O. break before make, slow break	XCMD2502L1	XCMD2515L1	XCMD2545L1	XCMD25F2L1	XCMD2506L1	—

Exploded view page 21-10

Compact, Modular Limit Switches, Metal or Plastic

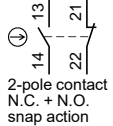



Table 21.17: XCKD and XCKP Compact, 30 mm Wide, Conforming to Standard EN 50047

OsiSense XCKP	Metal End Plunger	Plastic Roller Lever Horizontal Actuation	M18 Head Metal End Plunger	Plastic Roller Lever	Variable Length Plastic Roller Lever	Rubber Roller Lever Ø 50 mm	Cat Whisker
<p>2-pole contact N.C. + N.O. snap action 2-pole contact N.C. + N.O. slow break</p>							
Actuation speed (m/s)	0.5	1	0.5	1.5	1.5	1.5	1
Switches conforming to IEC 60947-5-1 section 3	yes	yes	yes	yes	yes	yes	no
Degree of protection conforming to IEC 50 529	IP66 and IP67	IP66 and IP67	IP66 and IP67	IP66 and IP67	IP66 and IP67	IP66 and IP67	IP66 and IP67
Rated operational characteristics	Vac 15; A 300 (Ue = 240 V, Ie = 3 A) / Vdc 13; Q 300 (Ue = 250 V, Ie = 0.27 A)						
Cable entry	1 tapped entry for 1/2" NPT						
Mounting holes (mm)	20	20	M18 x 1	20	20	20	20
Body dimensions (mm) W x D x H	30 x 30 x 73	30 x 30 x 73	30 x 30 x 73	30 x 30 x 73	30 x 30 x 73	30 x 30 x 73	30 x 30 x 73
Ordering information	Cat. No.	Cat. No.	Cat. No.	Cat. No.	Cat. No.	Cat. No.	Cat. No.
<b>XCKD Metal, 30 mm Wide</b>							
2-pole, N.C. + N.O. snap action	XCKD2110N12	XCKD2121N12	XCKD21H0N12	XCKD2118N12	XCKD2145N12	XCKD2139N12	XCKD2106N12
2-pole, N.C. + N.O. break before make, slow break	XCKD2510N12	XCKD2521N12	XCKD25H0N12	XCKD2518N12	XCKD2545N12	XCKD2539N12	XCKD2506N12
<b>XCKP Plastic, 30 mm Wide, Double Insulated</b>							
2-pole, N.C. + N.O. snap action	XCKP2110N12	XCKP2121N12	XCKP21H0N12	XCKP2118N12	XCKP2145N12	XCKP2139N12	XCKP2106N12
2-pole, N.C. + N.O. break before make, slow break	XCKP2510N12	XCKP2521N12	XCKP25H0N12	XCKP2518N12	XCKP2545N12	XCKP2539N12	XCKP2506N12

Exploded view page 21-12





**Compact Limit Switches with 2 Cable Entries and Modular Head**

**Table 21.18: XCKT Compact, Plastic, 2 Cable Entries, Standard, 40 mm**

OsiSense XCKT	Metal End Plunger	Metal Roller Plunger	Plastic Roller Lever
 <p>2-pole contact N.C. + N.O. snap action</p>			
Actuation speed (m/s)	0.5	0.5	1.5
Switches conforming to IEC 60947-5-1 section 3 	yes	yes	yes
Degree of protection conforming to IEC 60529	IP66 and IP67	IP66 and IP67	IP66 and IP67
Rated operational characteristics	Vac 15; A 300 (Ue = 240 V, Ie = 3 A) / Vdc 13; Q 300 (Ue = 250 V, Ie = 0.27 A)		
Cable entry	Two Pg 11 cable entries. One 1/2" NPT adapter, DE9RA1012, is included.		
Mounting holes—in. (mm)	0.79 or 1.57 (20 or 40)	0.79 or 1.57 (20 or 40)	0.79 or 1.57 (20 or 40)
Body dimensions—in. (mm), W x D x H	2.36 x 1.18 x 2.4 (60 x 30 x 61)	2.36 x 1.18 x 2.4 (60 x 30 x 61)	2.36 x 1.18 x 2.4 (60 x 30 x 61)
Ordering information	Cat. No.	Cat. No.	Cat. No.
Complete switch	2-pole, N.C. + N.O. snap action XCKT2110N12	XCKT2102N12	XCKT2118N12

**Modular, Compact Limit Switches with Manual Reset**

**Table 21.19: XCDR and XCPR Compact, Metal or Plastic, with Manual Reset, 30 mm**

OsiSense XCDR and XCPR	Metal End Plunger	Plastic Roller Lever Horizontal Actuation	Plastic Roller Lever Vertical Actuation
			
Actuation speed (m/s)	0.5	1	1
Switches conforming to IEC 60947-5-1 section 3 	yes	yes	yes
Degree of protection conforming to IEC 60529	IP66 and IP67	IP66 and IP67	IP66 and IP67
Rated operational characteristics	Vac 15; A 300 (Ue = 240 V, Ie = 3 A) / Vdc 13; Q 300 (Ue = 250 V, Ie = 0.27 A)		
Cable entry	1 tapped entry for 1/2" NPT		
Mounting holes—in. (mm)	0.79 (20)	0.79 (20)	0.79 (20)
Body dimensions—in. (mm), W x D x H	1.18 x 1.18 x 3.74 (30 x 30 x 95)	1.18 x 1.18 x 3.74 (30 x 30 x 95)	1.18 x 1.18 x 3.74 (30 x 30 x 95)
Ordering information	Cat. No.	Cat. No.	Cat. No.
<b>XCDR Metal</b>			
Complete switch	2-pole, N.C. + N.O. snap action XCDR2110N12	XCDR2121N12	XCDR2127N12
	2-pole, N.C. + N.O. break before make, slow break XCDR2510N12	XCDR2521N12	XCDR2527N12
<b>XCPR Plastic, Double Insulated</b>			
Complete switch	2-pole, N.C. + N.O. snap action XCPR2110N12	XCPR2121N12	XCPR2127N12
	2-pole, N.C. + N.O. break before make, slow break XCPR2510N12	XCPR2521N12	XCPR2527N12

Common Head and Levers for XCMD, XCKD, XCKP, XCKT

Table 21.20: Metal Plunger and Multi-Directional Heads

Metal End Plunger	Metal End Plunger with Elastomer Protective Boot	Steel Roller Plunger	Retractable Steel Roller Lever	Plastic Roller Lever, Horizontal Actuation	Plastic Roller Lever, Vertical Actuation
Cat. No. ZCE10	Cat. No. ZCE11	Cat. No. ZCE02	Cat. No. ZCE24	Cat. No. ZCE21	Cat. No. ZCE27

M12 Head Metal Plunger <sup>[1]</sup>	M18 Head Metal Plunger <sup>[2]</sup>	M12 Head Steel Roller Plunger <sup>[2]</sup>	M18 Head Steel Roller Plunger <sup>[2]</sup>	Spring Lever	Spring Lever with Plastic End	Cat Whisker
Bushing Mounted	Bushing Mounted	Bushing Mounted	Bushing Mounted			
Cat. No. ZCEF0	Cat. No. ZCEH0	Cat. No. ZCEF2	Cat. No. ZCEH2	Cat. No. ZCE08	Cat. No. ZCE07	Cat. No. ZCE06

Table 21.21: Metal Rotary Heads and Levers

Rotary Head without Lever, Spring Return, for Actuation from RH or LH Side	Rotary Head without Lever, Stay Put, for Actuation from RH or LH Side <sup>[3]</sup>	Plastic Roller Lever, Track: 24/31 mm (ZCMD) 29/36 mm (ZCD/P/T) <sup>[1]</sup>	Steel Roller Lever, Track: 24/31 mm (ZCMD) 29/36 mm (ZCD/P/T) <sup>[1]</sup>	Plastic Roller Lever, Track: 16/39 mm (ZCMD) 21/44 mm (ZCD/P/T) <sup>[1]</sup>	Steel Roller Lever, Track: 16/39 mm (ZCMD) 21/44 mm (ZCD/P/T) <sup>[1]</sup>	Plastic, Roller Lever, Track: 20/36 mm (ZCMD) 24/40 mm (ZCD/P/T) <sup>[2]</sup>
Cat. No. ZCE01	Cat. No. ZCE09	Cat. No. ZCY15	Cat. No. ZCY16	Cat. No. ZCY25	Cat. No. ZCY26	Cat. No. ZCY18

Steel Roller Lever, for Track: 20/36 mm (ZCMD) 24/40 mm (ZCD/P/T) <sup>[2]</sup>	Ceramic Roller Lever	Variable Length, Rigid Plastic Roller Lever	Variable Length, Bendable Plastic Roller Lever	Variable Length, Rigid Steel Roller Lever	Variable Length, Bendable Steel Roller Lever	Metal Spring Lever
Cat. No. ZCY19	Cat. No. ZCY22	Cat. No. ZCY45	Cat. No. ZCY44	Cat. No. ZCY46	Cat. No. ZCY48	Cat. No. ZCY91

Plastic Roller Lever Ø 50 mm	Adjustable Plastic Roller Lever Ø 50 mm	Square Steel Rod Lever, U 3 mm, length = 125 mm	Round, Glass Fiber Rod Lever, Ø 3 mm length = 125 mm	Round Plastic Rod Lever, Ø 6 mm, length = 200 mm	Forked Lever Arm with 2 Tracks: 25/39 mm	Forked Lever Arm with 1 Track: 32 mm
Cat. No. ZCY39	Cat. No. ZCY49	Cat. No. ZCY54	Cat. No. ZCY55	Cat. No. ZCY59	Cat. No. ZCY61 Recommended for Use with ZCE09 Head	Cat. No. ZCY71 Recommended for Use with ZCE09 Head

[1] Recommended for use with body: ZCMD...  
 [2] Recommended for use with body ZCD... / ZCP... / ZCT...  
 [3] Can only be used on ZCMD25 bodies.

**Body/Contact Assemblies**

**NOTE:** Metal components must be used with metal bodies. Plastic components must be used with plastic bodies.

**Table 21.22: Miniature, Metal Body/Contact Assemblies**

Type of contact	2-pole N.C. + N.O. Snap action	2-pole N.C. + N.C. Snap action	3-pole N.C. + N.C. + N.O. Snap action	4-pole N.C. + N.C. + N.O. + N.O. Snap action	2-pole N.C. + N.O. Slow break	3-pole N.C. + N.C. + N.O. Slow break	2-pole N.C. + N.O. Snap action 5-pin connector	1 SPDT contact Snap action 4-pin connector
Metal body	Cat. No. ZCMD21	Cat. No. ZCMD29	Cat. No. ZCMD39	Cat. No. ZCMD41	Cat. No. ZCMD25	Cat. No. ZCMD37	Cat. No. ZCMD21C12	Cat. No. ZCMD21M12

**Table 21.23: Connection of Miniature Body/Contact Assemblies**

Length (m)	Cat. No.	Cat. No.	Cat. No.	Cat. No.	Cat. No.
Specific pre-cabled connection components					
1	ZCMC21L1	ZCMC29L1	ZCMC39L1	ZCMC25L1	ZCMC37L1
2	ZCMC21L2	ZCMC29L2	ZCMC39L2	ZCMC25L2	ZCMC37L2
5	ZCMC21L5	ZCMC29L5	ZCMC39L5	ZCMC25L5	ZCMC37L5

1 - 2 = N.C.  
3 - 4 = N.O.  
5 = Ground

1 = Common  
2 = N.C.  
3 = Ground  
4 = N.O.

Exploded view page 21-10

**Table 21.24: Compact, Metal or Plastic Body/Contact Assemblies**

Type of contact	2-pole N.C. + N.O. Snap action	2-pole N.C. + N.O. Snap action	3-pole N.C. + N.C. + N.O. Snap action	2-pole N.C. + N.O. Slow break	2-pole N.C. + N.O. Snap action	2-pole N.C. + N.O. Snap action	2-pole N.C. + N.O. Snap action	2-pole N.C. + N.O. Snap action	2-pole N.C. + N.O. Slow break
Metal	Cat. No. ZCD21	Cat. No. ZCD29	Cat. No. ZCD39	Cat. No. ZCD25	Cat. No. —	Cat. No. ZCD21M12	Cat. No. —	Cat. No. —	Cat. No. —
Plastic	Cat. No. ZCP21	Cat. No. ZCP29	Cat. No. ZCP39	Cat. No. ZCP25	Cat. No. ZCP21D44	Cat. No. —	Cat. No. ZCP21M12	Cat. No. ZCT21P16	Cat. No. ZCT25P16

**Table 21.25: Connection of Compact Body/Contact Assemblies**

	ISO M16	ISO M20	Pg 11	Pg 13.5	1/2" NPT	PF 1/2 NPSF	Deutsch Connector
	Cat. No.	Cat. No.	Cat. No.	Cat. No.	Cat. No.	Cat. No.	Cat. No.
Interchangeable cable entry							
Metal	ZCDEP16	ZCDEP20	ZCDEG11	ZCDEG13	ZCDEN12	ZCDEF12	—
Plastic	ZCPEP16	ZCPEP20	ZCEP11	ZCEP13	ZCPEN12	ZCPEF12	ZCPED44

**NOTE:** Plastic conduit entries shown. Order **plastic** conduit entries for **plastic** bodies (XCKP/ZCP). Order **metal** conduit entries (chrome color) for **metal** bodies (XCKD/ZCD). *Metal conduit entries do not fit on plastic bodies.*

Exploded view page 21-12

XCKN / XCNR Compact Plastic, Non-Modular Switches

Table 21.26: XCKN Compact Plastic, Non-Modular, 30 mm Wide



















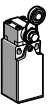

OsiSense Limit Switches						
	2 pole snap action				Thermoplastic roller-lever plunger	
	2 pole break before make, slow break	Metal end plunger	Plastic roller plunger for lateral cam approach	Plastic roller plunger for cross cam approach	Horizontal actuation in 1 direction	Vertical actuation in 1 direction
Switch actuation		On end	By 30° cam			
Type of actuation						
Maximum actuation speed		0.5 m/s (1.64 ft/s)	0.3 m/s (0.99 ft/s)	0.1 m/s (3.28 ft/s)		
Minimum force of torque		For tripping	15 N (3.37 lb)	12 N (2.70 lb)	6 N (1.35 lb)	
		For positive opening	30 N (6.75 lb)	20 N (4.50 lb)	10 N (2.25 lb)	
Weight, kg (lb)		0.065 (0.143)	0.065 (0.143)	0.065 (0.143)	0.070 (0.154)	0.070 (0.154)
Ordering Information (sold in packs of 20)		Cat. No.	Cat. No.	Cat. No.	Cat. No.	Cat. No.
2 pole N.C. + N.O. snap action		XCKN2110P20	XCKN2102P20	XCKN2103P20	XCKN2121P20	XCKN2127P20
2 pole N.C. + N.O., break before make, slow break		XCKN2510P20	XCKN2502P20	XCKN2503P20	XCKN2521P20	XCKN2527P20
2 pole N.C. + N.C. snap action		XCKN2910P20	XCKN2902P20	XCKN2903P20	XCKN2921P20	XCKN2927P20
	2 pole snap action					
	2 pole break before make, slow break	Rotary, thermoplastic roller-lever	Rotary, variable length thermoplastic roller-lever	Rotary, variable length, thermoplastic roller-lever, Ø 50 mm	Multi-directional, spring rod	Multi-directional, cat's whisker
Switch actuation		By 30° cam			By any moving part	
Type of actuation						
Maximum actuation speed		1.5 m/s (4.92 ft/s)			1 m/s (3.28 ft/s), any direction	
Minimum force of torque		For tripping	0.1 N·m (0.89 lb-in)			0.13 N·m (0.11 lb-in)
		For positive opening	0.15 N·m (1.33 lb-in)			–
Weight, kg (lb)		0.085 (0.187)	0.090 (0.198)	0.110 (0.243)	0.115 (0.254)	0.085 (0.187) / 0.075 (0.165)
Ordering Information (sold in packs of 20)		Cat. No.	Cat. No.	Cat. No.	Cat. No.	Cat. No.
2 pole N.C. + N.O. snap action		XCKN2118P20	XCKN2145P20	XCKN2139P20	XCKN2149P20	XCKN2108P20 / XCKN2106P20
2 pole N.C. + N.O., break before make, slow break		XCKN2518P20	XCKN2545P20	XCKN2539P20	XCKN2549P20	XCKN2508P20 / XCKN2506P20
2 pole N.C. + N.C. snap action		XCKN2918P20	XCKN2945P20	XCKN2939P20	XCKN2949P20	XCKN2908P20 / XCKN2906P20

Table 21.27: XCNR Compact Plastic, Non-Modular, with Manual Reset, 30 mm Wide











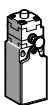

Terminal Configurations						
	2 pole N.C. + N.O.			Thermoplastic roller-lever plunger		
	2 pole N.C. + N.C.	Metal end plunger	Plastic roller plunger	Horizontal actuation in 1 direction	Vertical actuation in 1 direction	Rotary head, thermoplastic roller-lever plunger
Switch actuation		On end	By 30° cam			
Type of actuation						
Maximum actuation speed		0.5 m/s (1.64 ft/s)	0.3 m/s (0.99 ft/s)	0.1 m/s (3.28 ft/s)		1.5 m/s (4.92 ft/s)
Minimum force of torque		For tripping	15 N (3.37 lb)	12 N (2.70 lb)	6 N (1.35 lb)	
		For positive opening	30 N (6.74 lb)	20 N (4.50 lb)	10 N (2.25 lb)	
Weight, kg (lb)		0.080 (0.18)	0.080 (0.18)	0.085 (0.19)	0.090 (0.20)	0.100 (0.22)
Ordering Information (sold in packs of 20)		Cat. No.	Cat. No.	Cat. No.	Cat. No.	Cat. No.
2 pole N.C. + N.O. snap action		XCNR2110P20	XCNR2102P20	XCNR2121P20	XCNR2127P20	XCNR2118P20
2 pole N.C. + N.O. break before make, slow break		XCNR2510P20	XCNR2502P20	XCNR2521P20	XCNR2527P20	XCNR2518P20
2 pole N.C. + N.C. snap action		XCNR2910P20	XCNR2902P20	XCNR2921P20	XCNR2927P20	XCNR2918P20

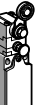
Table 21.28: Cable Entries and Contact Configurations

Cable entry	M20	Order with suffix P20 for 1 entry tapped to M20 x 1.5 mm for ISO cable entry. Clamping capacity 7 to 13 mm (0.28 to 0.51 in.)
	Pg 11	Replace P20 suffix with G11 suffix, 18.6 x 1.41
	1/2" NPT	Replace P20 suffix with G11 suffix. Order 1/2" NPT adapter DE91012
	Other cable entries	For other cable entries, including complete switches with ISO M16 x 1.5 or PF 1/2 (G 1/2) cable entry, please consult your local sales office.
Other contact configurations		For other 2- and 3-pole configurations, please consult your local sales office.
Function diagrams		See catalog 9006CT1007.







New!

**XCKS Standard Body, Plastic, Double Insulated**



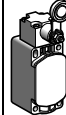
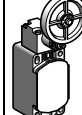
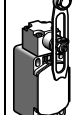

**Table 21.29: Environmental Specifications**

<b>Conforming to standards</b>	Products	IEC 60947-5-1, EN 60947-5-1, UL 508, CSA C22-2 n° 14
	Machine assemblies	IEC 60204-1, EN 60204-1
<b>Approvals</b>		UL, CSA, CCC
<b>Ambient air temperature</b>	For operation	-25 to +70 °C (-13 to +158 °F)
	For storage	-40 to +70 °C (-40 to +158 °F)
<b>Vibration resistance</b>	Conforming to IEC 60068-2-6	25 gn (10–500 Hz)
<b>Shock resistance</b>	Conforming to IEC 60068-2-27	50 gn (11 ms)
<b>Electric shock protection</b>		Class II conforming to IEC 61140 and NF C 20-030
<b>Degree of protection</b>		<b>IP65</b> conforming to <b>IEC 60529</b> ; <b>IK03</b> conforming to <b>EN 50102</b>
<b>Repeat accuracy</b>		0.05 mm on the tripping points, with 1 million operating cycles for head with end plunger
<b>Cable entry</b>	Depending on model	Tapped entry for PG 13 conduit thread. To convert to 1/2" NPT, use adapter <b>DE9RA1212</b> . For ISO M20 x 1.5, add <b>H29</b> to the end of the catalog number. Example: <b>XCKS101</b> becomes <b>XCKS101H29</b> .
<b>Materials</b>		Plastic (body and head)

**Table 21.30: Selection, Plunger and Rotary Heads**

	Form B [1]	Form C [1]	Form A [1]				Form D [1]
 <p>2-pole N.C. + N.O. snap action</p>							
 <p>2-pole N.C. + N.O. break before make, slow break</p>	<b>Metal end plunger</b>	<b>Steel roller plunger</b>	<b>Thermoplastic roller lever [2]</b>	<b>Elastomer roller lever, Ø 50 mm (1.97 in.) [2]</b>	<b>Variable length thermoplastic roller lever [2]</b>	<b>Variable length elastomer roller lever, Ø 50 mm (1.97 in.) [2]</b>	<b>Round thermoplastic rod lever, Ø 6 mm (0.24 in.) [3] [4]</b>
 <p>2-pole N.C. + N.C.</p>							
Ordering Information[5]	Cat. No.	Cat. No.	Cat. No.	Cat. No.	Cat. No.	Cat. No.	Cat. No.
2-pole N.C. + N.O. snap action (XE2SP2151)	XCKS101	XCKS102	XCKS131	XCKS139	XCKS141	XCKS149	XCKS159
2-pole N.C. + N.O. break before make, slow break (XE2NP2151)	XCKS501	XCKS502	XCKS531	XCKS539	XCKS541	XCKS549	XCKS559
2-pole N.C. + N.C. snap action (XE2SP2141)	ZCKS9 + ZCKD01	ZCKS9 + ZCKD02	ZCKS9 + ZCKD31	ZCKS9 + ZCKD39	ZCKS9 + ZCKD41	ZCKS9 + ZCKD49	ZCKS9 + ZCKD59
2-pole N.C. + N.C. simultaneous, slow break (XE2NP2141)	ZCKS7 + ZCKD01	ZCKS7 + ZCKD02	ZCKS7 + ZCKD31	ZCKS7 + ZCKD39	ZCKS7 + ZCKD41	ZCKS7 + ZCKD49	ZCKS7 + ZCKD59
<b>Weight, kg (lb)</b>	0.095 (0.209)	0.105 (0.231)	0.145 (0.320)	0.150 (0.331)	0.155 (0.342)	0.155 (0.342)	0.150 (0.331)
<b>Contact operation</b>	⊖ N.C. contact with positive opening operation, when properly mounted and using a conforming operator.			—			

**Table 21.31: Specifications**

Switch actuation	On end	By 30° cam			By any moving part
<b>Type of actuation</b>					
<b>Maximum actuation speed</b>	0.5 m/s (1.64 ft/s)	1.5 m/s (4.92 ft/s)			1 m/s (3.28 ft/s)
<b>Minimum force or torque</b>	For tripping	15 N (3.37 lb)	12 N (2.70 lb)	0.15 N•m (1.33 lb-in)	
	For positive opening	45 N (10.12 lb)	36 N (8.09 lb)	0.3 N•m (2.66 lb-in)	—
<b>Cable entry</b>	1 entry tapped M20 x 1.5 mm for ISO cable entry, clamping capacity 7 to 13 mm (0.28 to 0.51 in.) To convert PG 13 to 1/2" NPT, use adapter <b>DE9RA1212</b> . For ISO M20 x 1.5, add <b>H29</b> to the end of the catalog number. Example: <b>XCKS101</b> becomes <b>XCKS101H29</b> .				

[1] Form conforming to EN 50041. See page 6/92 of catalog 9006CT1007.  
 [2] Adjustable throughout 360° in 5° steps, or in 90° steps by reversing the notched washer.  
 [3] Adjustable throughout 360° in 5° steps, or in 45° steps by reversing the lever mounting.  
 [4] Value taken with actuation by moving part at 100 mm (3.94 in.) from the mounting.  
 [5] Switches with gold contacts or eyelet type connections: please consult your local sales office.

New!



Type of head	Plunger (fixing by the body)		Rotary (fixing by the body)				
Form conforming to EN 50041 [1]	B	C	A	A	A	A	D
Type of operator	Metal end plunger	Steel roller plunger	Thermoplastic or steel roller lever [2]	Elastomer roller lever, Ø50 mm [2]	Variable length thermoplastic or steel roller lever [2]	Variable length elastomer roller lever, Ø50 mm [2]	Round thermoplastic rod lever, Ø6 mm [3] [4]
Positive operation	⊕	⊕	⊕	—	⊕	—	—

References of complete switches with 1 ISO M20 x 1.5 cable entry							
2-pole NC + NO snap action	XCKS101H29	XCKS102H29	XCKS131H29 (thermoplastic) (steel)	XCKS139H29	XCKS141H29 (thermoplastic) (steel)	XCKS149H29	XCKS159H29
2-pole NC + NO break before make, slow break	XCKS501H29	XCKS502H29	XCKS531H29 (thermoplastic) XCKS533H29 (steel)	XCKS539H29	XCKS541H29 (thermoplastic) XCKS543H29 (steel)	XCKS549H29	XCKS559H29
Weight, kg (lb)	0.125 (0.28)	0.135 (0.30)	0.160 (0.35)	0.175 (0.39)	0.165 (0.36)	0.180 (0.40)	0.170 (0.37)
Contact operation			(A) = cam displacement (P) = positive opening point		NC contact with positive opening operation		

Catalog numbers of complete switches with 1 Pg 13.5 cable entry  
For an entry tapped for a Pg 13.5 cable gland, delete H29 from the end of the reference. (Except XCKS133H29, XCKS143H29, XCKS533H29 and XCKS543H29). Example: XCKS101H29 becomes XCKS101.

Catalog numbers of complete switches with 1/2" NPT cable entry  
For an entry tapped for a 1/2" NPT cable gland, replace H29 at the end of the reference by H7. (Except XCKS133H29, XCKS143H29, XCKS501H29, XCKS533H29, XCKS539H29, XCKS543H29, XCKS549H29 and XCKS559H29). Example: XCKS101H29 becomes XCKS101H7.

Specifications							
Switch actuation	On end	By 30° cam			By any moving part		
Type of actuation				or			
Maximum actuation speed	0.5 m/s (1.64 ft/s)	1.5 m/s (4.92 ft/s)			1 m/s (3.28 ft/s)		
Mechanical durability (in millions of operating cycles)	25	15	20				
Minimum force or torque	For tripping	15 N (3.37 lbf)	12 N (2.70 lbf)	0.10 N·m (0.86 lb-in)			
	For positive opening	30 N (6.74 lbf)	20 N (4.50 lbf)	0.15 N·m (1.33 lb-in)	—	0.15 N·m (1.33 lb-in)	—
Cable entry	1 entry tapped M20 x 1.5 mm for ISO cable gland, clamping capacity 7–13 mm						

[1] Form conforming to EN 50041, see page 31900/9.  
[2] Adjustable throughout 360° in 5° steps, or in 90° steps by reversing the notched washer.  
[3] Adjustable throughout 360° in 5° steps, or in 45° steps by reversing the lever mounting.  
[4] Value taken with actuation by moving part at 100 mm from the fixing.





NOTE: ZCKD heads can only be used with ZCKS bodies.

**Catalog numbers of variable composition switches (ZCKS bodies and ZCKD heads) with 1 ISO M20 x 1.5 cable entry [5]**

Form conforming to EN 50041 [6]	B	C	A	A	A	A	D
<b>Type of operator</b>	Metal end plunger	Steel roller plunger	Thermoplastic roller lever [7]	Elastomer roller lever, Ø50 mm [7]	Variable length thermoplastic roller lever [7]	Variable length elastomer roller lever, Ø50 mm [7]	Round thermoplastic rod lever, Ø6 mm [8] [9]
<b>Positive operation</b>				—		—	—
<b>2-pole NC + NC snap action (XE2SP2141)</b>	ZCKS9H29 + ZCKD01 	ZCKS9H29 + ZCKD02 	ZCKS9H29 + ZCKD31 	ZCKS9H29 + ZCKD39 	ZCKS9H29 + ZCKD41 	ZCKS9H29 + ZCKD49 	ZCKS9H29 + ZCKD59 
<b>2-pole NC + NC simultaneous, slow break (XE2NP2141)</b>	ZCKS7H29 + ZCKD01 	ZCKS7H29 + ZCKD02 	ZCKS7H29 + ZCKD31 	ZCKS7H29 + ZCKD39 	ZCKS7H29 + ZCKD41 	ZCKS7H29 + ZCKD49 	ZCKS7H29 + ZCKD59 
<b>3-pole NC + NC + NO snap action (XE3SP2141)</b>	ZCKSD39H29 + ZCKD01 	ZCKSD39H29 + ZCKD02 	ZCKSD39H29 + ZCKD31 	ZCKSD39H29 + ZCKD39 	ZCKSD39H29 + ZCKD41 	ZCKSD39H29 + ZCKD49 	ZCKSD39H29 + ZCKD59 
<b>3-pole NC + NC + NO break before make, slow break (XE3NP2141)</b>	ZCKSD37H29 + ZCKD01 	ZCKSD37H29 + ZCKD02 	ZCKSD37H29 + ZCKD31 	ZCKSD37H29 + ZCKD39 	ZCKSD37H29 + ZCKD41 	ZCKSD37H29 + ZCKD49 	ZCKSD37H29 + ZCKD59 
<b>Weight, kg (lb)</b>	0.095 (0.21)	0.105 (0.23)	0.145 (0.32)	0.150 (0.33)	0.155 (0.34)	0.155 (0.34)	0.150 (0.33)
<b>Contact operation</b>		closed 	(A) = cam displacement (P) = positive opening point	NC contact with positive opening operation			

**Catalog numbers of variable composition switches (ZCKS bodies and ZCKD heads) with 1 Pg 13.5 cable entry**

For ZCKS bodies with 1 Pg 13.5 cable entry, delete H29 from the end of the reference. Example: ZCKS1H29 becomes ZCKS1.

**Specifications**

Switch actuation	On end	By 30° cam	By any moving part	
<b>Type of actuation</b>				
<b>Maximum actuation speed</b>	0.5 m/s (1.64 ft/s)		1.5 m/s (4.92 ft/s)	
<b>Mechanical durability [10] (in millions of operating cycles)</b>	25	15	20	
<b>Minimum force or torque</b>	For tripping 15 N (3.37 lbf)	12 N (2.70 lbf)	0.15 N•m (1.33 lb-in)	
	For positive opening 45 N (10.12 lbf)	36 N (8.09 lbf)	—	0.3 N•m (2.66 lb-in)
<b>Cable entry</b>	1 entry tapped M20 x 1.5 mm for ISO cable gland, clamping capacity 7–13 mm			

[5] Switches with gold contacts or eyelet type connections: please consult our Customer Care Centre.

[6] Form conforming to EN 50041

[7] Adjustable throughout 360° in 5° steps, or in 90° steps by reversing the notched washer.

[8] Adjustable throughout 360° in 5° steps, or in 45° steps by reversing the lever mounting.

[9] Value taken with actuation by moving part at 100 mm from the fixing.

[10] Limited to 15 million operating cycles for switches with contacts XE3P.

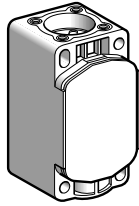

ZCKS\*

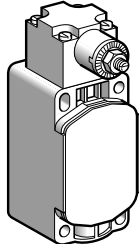

ZCKS404

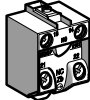

XE2SP21+1

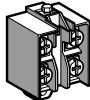

XE2NP21+1

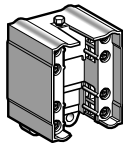

XE3P21+

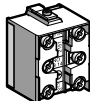

XE3P21+



DE9RA+12

**Table 21.32: Bodies with 2-Pole Contact**

Style	With contact block	Positive operation	Cable entry	Catalog No.	Weight, kg (lb)
1 step	NC + NO snap action (XE2SP2151)	⊕	Pg 13.5	ZCKS1	0.080 (0.18)
			ISO M20 x 1.5	ZCKS1H29	0.080 (0.18)
	2 CO simultaneous, snap action (XESP3021)	—	Pg 13.5	ZCKS2	0.080 (0.18)
			ISO M20 x 1.5	ZCKS2H29	0.080 (0.18)
	NC + NO break before make, slow break (XE2NP2151)	⊕	Pg 13.5	ZCKS5	0.080 (0.18)
			ISO M20 x 1.5	ZCKS5H29	0.080 (0.18)
	NO + NC make before break, slow break (XE2NP2161)	⊕	Pg 13.5	ZCKS6	0.080 (0.18)
			ISO M20 x 1.5	ZCKS6H29	0.080 (0.18)
	NC + NC simultaneous, slow break (XE2NP2141)	⊕	Pg 13.5	ZCKS7	0.080 (0.18)
			ISO M20 x 1.5	ZCKS7H29	0.080 (0.18)
NO + NO simultaneous, slow break (XE2NP2131)	—	Pg 13.5	ZCKS8	0.080 (0.18)	
		ISO M20 x 1.5	ZCKS8H29	0.080 (0.18)	
NC + NC snap action (XE2SP2141)	⊕	Pg 13.5	ZCKS9	0.080 (0.18)	
		ISO M20 x 1.5	ZCKS9H29	0.080 (0.18)	

**Table 21.33: Bodies with Double-Pole Contact and Spring Return Rotary Head**

Without operating lever					
Style	With contact block	Positive operation	Cable entry	Catalog No.	Weight, kg (lb)
2 step 1 from left and 1 from right	2 CO staggered snap action	—	Pg 13.5	ZCKS404	0.150 (0.33)
			ISO M20 x 1.5	ZCKS404H29	0.150 (0.33)

**Table 21.34: Bodies with 3-Pole Contact and 1 Cable Entry**

Style	With contact block	Positive operation (1)	Cable entry	Catalog No.	Weight, kg (lb)
—	NC + NO + NO snap action (XE3SP2151)	⊕	Pg 13.5	ZCKSD31	0.080 (0.18)
			ISO M20 x 1.5	ZCKSD31H29	0.080 (0.18)
	NC + NC + NO snap action (XE3SP2141)	⊕	Pg 13.5	ZCKSD39	0.080 (0.18)
			ISO M20 x 1.5	ZCKSD39H29	0.080 (0.18)
	NC + NC + NO break before make, slow break (XE3NP2141)	⊕	Pg 13.5	ZCKSD37	0.080 (0.18)
			ISO M20 x 1.5	ZCKSD37H29	0.080 (0.18)
NC + NO + NO break before make, slow break (XE3NP2151)	⊕	Pg 13.5	ZCKSD35	0.080 (0.18)	
		ISO M20 x 1.5	ZCKSD35H29	0.080 (0.18)	

**Table 21.35: Contact Blocks for ZCKS Bodies**

Type of contact	For body	Positive operation	Catalog No.	Weight, kg (lb)
<b>2-pole contact</b>				
NC + NO snap action	ZCKS1	⊕	XE2SP2151	0.020 (0.04)
NC + NO break before make, slow break	ZCKS5	⊕	XE2NP2151	0.020 (0.04)
2 CO simultaneous snap action	ZCKS2	—	XESP3021	0.045 (0.10)
NO + NC make before break, slow break	ZCKS6	⊕	XE2NP2161	0.020 (0.04)
NC + NC simultaneous, slow break	ZCKS7	⊕	XE2NP2141	0.020 (0.04)
NO + NO simultaneous, slow break	ZCKS8	—	XE2NP2131	0.020 (0.04)
NC + NC snap action	ZCKS9	⊕	XE2SP2141	0.020 (0.04)
<b>3-pole contact</b>				
NC + NO + NO snap action	ZCKSD31	⊕	XE3SP2151	0.035 (0.08)
NC + NC + NO snap action	ZCKSD39	⊕	XE3SP2141	0.035 (0.08)
NC + NC + NO break before make, slow break	ZCKSD37	⊕	XE3NP2141	0.035 (0.08)
NC + NO + NO break before make, slow break	ZCKSD35	⊕	XE3NP2151	0.035 (0.08)

**Table 21.36: Accessories for ZCKS and XCKS**

Description	Minimum order quantity	Catalog No.	Weight, kg (lb)
Adapter for 1/2" NPT conduit (male Pg 13.5 / female 1/2" NPT)	10	DE9RA1212	0.035 (0.08)
Adapter for 1/2" NPT conduit (male M20 x 1.5 / female 1/2" NPT)	5	DE9RA2012	0.050 (0.11)
Other versions	Gold flashed contacts. Consult the Customer Care Center (1-888-778-2733).		

⊕ NC contact with positive opening operation, or head assuring positive opening operation

**Table 21.37: Limit Switch Catalog Numbers** *New!*

Actuator type	Reference	Weight, kg (lb)
Metal plunger	XCKW101	0.210 (0.46)
Steel roller plunger	XCKW102	0.220 (0.49)
Thermoplastic roller lever	XCKW131	0.240 (0.53)
Steel roller lever	XCKW133	0.245 (0.54)
Variable length thermoplastic roller lever	XCKW141	0.260 (0.57)
Variable length steel roller lever	XCKW143	0.265 (0.58)
Elastomer roller lever, Ø50 mm	XCKW139	0.220 (0.49)
Variable length elastomer roller lever, Ø50 mm	XCKW149	0.270 (0.60)
Round thermoplastic rod lever, Ø6 mm	XCKW159	0.230 (0.51)



Table 21.38: Ready-to-Use Packs, Catalog Numbers

Composition	Reference	Weight, kg (lb)
<ul style="list-style-type: none"> <li>1 limit switch with steel roller plunger <b>XCKW102</b>.</li> <li>1 receiver with 2 relay outputs <b>ZBRRD</b>.</li> </ul>	XCKWD02 [1]	0.410 (0.90)
<ul style="list-style-type: none"> <li>1 limit switch with thermoplastic roller lever <b>XCKW131</b>.</li> <li>1 receiver with 2 relay outputs <b>ZBRRD</b>.</li> </ul>	XCKWD31 [1]	0.410 (0.90)

**NB:** The transmitter (limit switch) and receiver are factory-paired.



Table 21.39: Receivers

Number and type of outputs	Power supply	Number of transmitters	Reference	Weight, kg (lb)
4 PNP outputs 200 mA / 24 V	24-Vdc	32	ZBRRC [1]	0.130 (0.29)
2 relay outputs type C/O, 3A	24-240 Vac/Vdc	32	ZBRRD [1]	0.130 (0.29)
2 PNP outputs 200 mA / 24 V	24 Vdc	2	XZBWR2STT24 [2]	0.130 (0.29)



Table 21.40: Network Access Points <sup>New!</sup>

Description	Data Function	Output Type	Receiver Voltage	Catalog Number	Weight, kg
Configurable access points equipped with: <ul style="list-style-type: none"> <li>7-segment display</li> <li>jog dial</li> <li>8 LED indicators (power ON, function modes, communication status, signal strength)</li> <li>external antenna connector and protective cap</li> <li>for 60 transmitters max.</li> </ul>	Set/Reset	2 RS485 connectors that provide Modbus RS485 serial link connectivity	24-240 Vac/Vdc	ZBRN2 [3]	0.270 (0.60)
	Set/Reset	1 slot for communication module (to be ordered separately)	24-240 Vac/Vdc	ZBRN1 [3]	0.270 (0.60)

[1] Schneider Electric product, also compatible with **ZB-RTA** wireless push buttons (with a software version  $\geq$ V2.0).  
 [2] Also compatible with **ZB-RTA** wireless push buttons and the **XZBWE112A24** wireless multi-sensor transmitter (with a software version  $\geq$ V1.0).  
 [3] Schneider Electric product, also compatible with **ZB-RTA** wireless push buttons (with a software version above or equal to V1.5).



ZBRCETH



ZBRA1



ZBRA2

**Table 21.41: Modbus/TCP network communication module**

Description	Communication port	Reference	Weight, kg (lb)
Communication module for access point <b>ZBRN1</b> Modbus/TCP protocol with embedded web pages, available in 5 languages, for configuration, monitoring and diagnostics	2 RJ45 connectors for daisy chain or daisy chain loop operation	ZBRCETH[4]	0.044 (0.10)

**Table 21.42: Antennas**

Use	Description	Reference	Weight, kg (lb)
<b>Relay Antenna</b>			
Increases the distance between the limit switches and the receivers	24–240 Vac/Vdc 5 m cable, 1 Power On LED, 2 reception/transmission LEDs	ZBRA1[5]	0.200 (0.04)
<b>External antenna</b>			
Connected to access point (ZBRN1 or ZBRN2) to increase the transmission distance	2 m cable 1 RF connector	ZBRA2[4]	0.040 (0.09)

[4] Schneider Electric product.

[5] Schneider Electric product, also compatible with **ZB-RTA** wireless push buttons.

Overview — Metal, Variable Composition

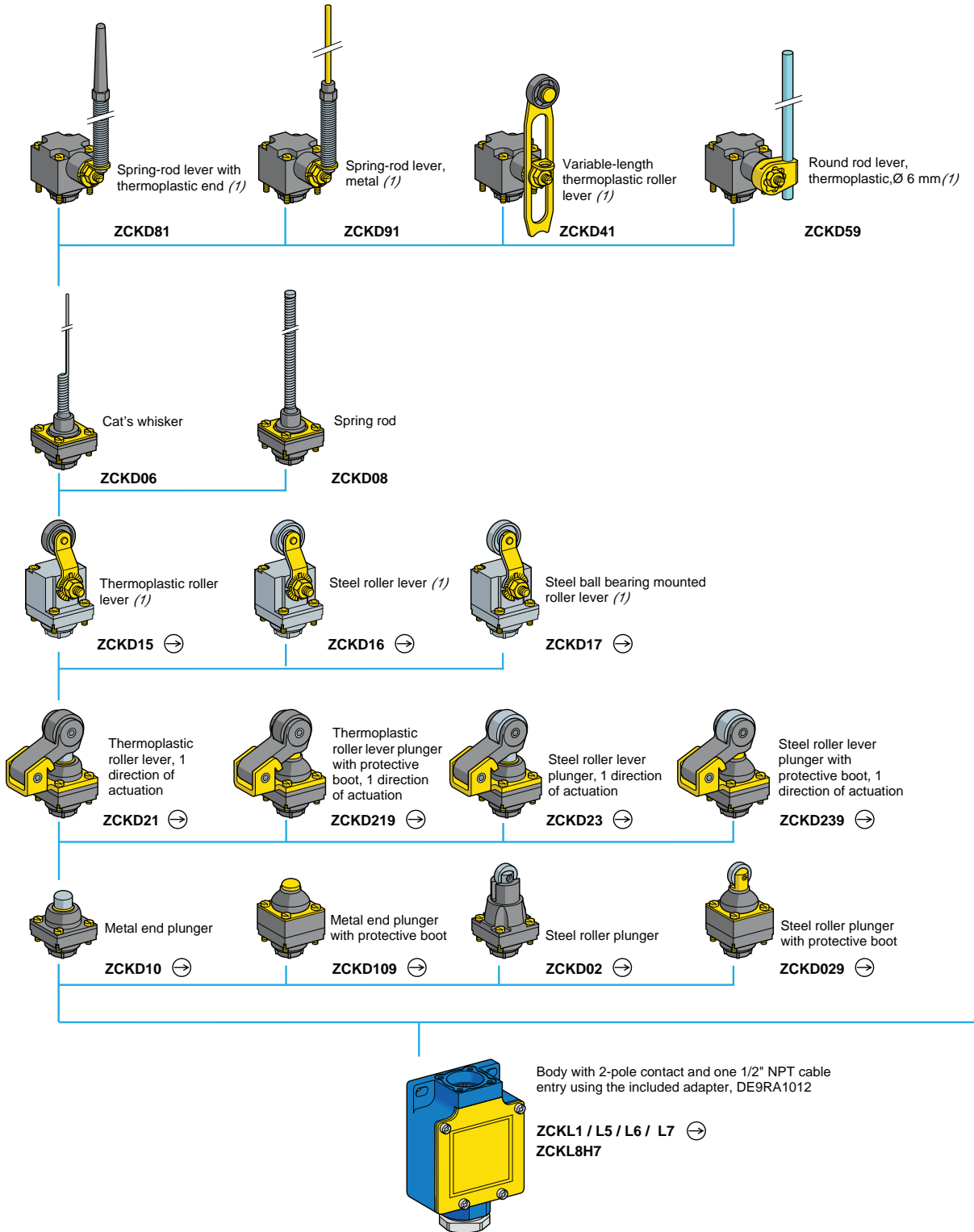

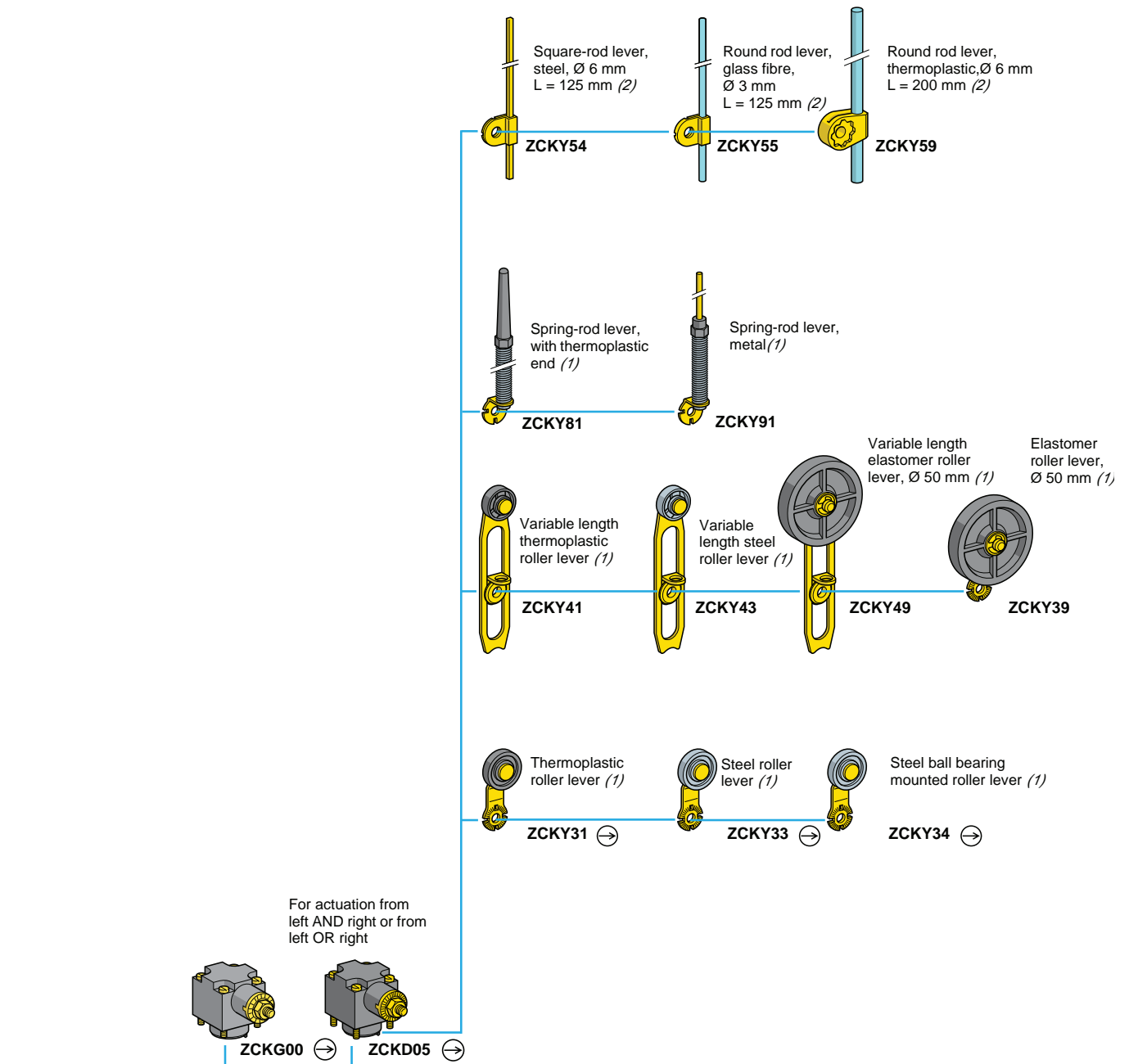

- ⊖ Head assuring positive opening operation when used with a conforming lever.
- (1) Adjustable throughout 360° in 5° steps, or in 90° steps by reversing the notched washer.
- (2) Adjustable throughout 360° in 5° steps, or in 45° steps by reversing the lever mounting.

**XCKL Limit Switch**

XCKL is a compact, general-duty limit switch for applications such as machine tools and material handling.



XCKL110H7

**Table 21.43: Specifications**

Rated Power (conforms to IEC 947-5-1, duty categories AC15 and DC13)	
Temperature range	-13 to +158 °F (-25 to +70 °C) The minimum temperatures listed are based on the absence of freezing moisture or water.
Enclosure rating	NEMA Type 1, 2, 3, 4, 12 IP66
Vibration resistance	25 G (10–500 Hz), conforming to IEC 68-2-6
Shock resistance	50 G, conforming to IEC 68-2-27
Repeatability	0.002 in. (0.05 mm)
Cable entry	Standard: Pg 11 with DE9RA1012 adapter for 1/2" NPT conduit entry
Contact Characteristics	
Rated thermal current	10 A
Rated insulation voltage	300 Vac and dc (A300 and Q300)
Contact resistance (max.)	25 mW
Cable (max.)	2 x #16 AWG (1.5 mm <sup>2</sup> ) per terminal
Short circuit protection (customer supplied)	10 A fuse type SC. Outside U.S. use gl or N.

**Complete Switches**

**Table 21.44: Lever Operated Switches**

Description [1]	Functional Diagram	Operating Torque/Force	Contact Configuration	Catalog Number
Programmable head CW and/or CCW—snap action Delrin® roller lever—adjustable in 5° or 45° increments (reversible mounting) →		14.2 oz-in	SPDT (N.O. + N.C.) snap	XCKL10011H7
		14.2 oz-in	SPDT (N.O. + N.C.) slow	XCKL50011H7
Adjustable length roller lever—adjustable in 5° or 45° increments (reversible mounting) →		14.2 oz-in	SPDT (N.O. + N.C.) snap	XCKL10041H7
		14.2 oz-in	SPDT (N.O. + N.C.) slow	XCKL50041H7
CW and CCW, Delrin roller lever →		21.3 oz-in	SPDT (N.O. + N.C.) snap	XCKL115H7
		21.3 oz-in	SPDT (N.O. + N.C.) slow	XCKL515H7
One way lever-Delrin roller →		25.3 oz-in	SPDT (N.O. + N.C.) snap	XCKL121H7
		25.3 oz-in	SPDT (N.O. + N.C.) slow	XCKL521H7



XCKL10011H7



XCKL115H7

**Table 21.45: Omnidirectional**

Description [1]	Functional Diagram	Operating Torque/Force	Contact Configuration	Catalog Number
Wobble stick-steel rod		1.84 oz-in	SPDT (N.O. + N.C.) snap	XCKL106H7
		1.84 oz-in	SPDT (N.O. + N.C.) slow	XCKL506H7



XCKL110H7



XCKL102H7

**Table 21.46: Plunger Operated**

Description [1]	Functional Diagram	Operating Torque/Force	Contact Configuration	Catalog Number
Rod plunger →		35.6 oz	SPDT (N.O. + N.C.) snap	XCKL110H7
		35.6 oz	SPDT (N.O. + N.C.) slow	XCKL510H7
Roller plunger →		35.6 oz	SPDT (N.O. + N.C.) snap	XCKL102H7
		35.6 oz	SPDT (N.O. + N.C.) slow	XCKL502H7

Exploded view [page 21-26](#)

Lever arms [page 21-29](#)



File E39281  
CCN NKCR



File Class LR44087  
3211-03



**Acceptable Wire Sizes: 14–24 AWG**  
**Recommended Terminal Clamp Torque: 13 lb-in**

[1] Diagrams shown are for XCKL1 . . .  
21-28



**XCKL Components**



ZCKL1H7, ZCKL5H7



ZCKG00H7



ZCKD15, 16, 17H7

**BUILDING A COMPLETE SWITCH**

Complete Switch = Body (with contact assembly) + Head + Lever

Examples:

Body ZCKL1H7 + Head ZCKD15 = XCKL115H7

Body ZCKL5H7 + Head ZCKD02 = XCKL502H7

Body ZCKL1H7 + Head ZCKG00 + Lever ZCKY11 = XCKL10011H7

NOTE: Some combinations are not available as complete switches.

**Table 21.47: Bodies—Electric**

Components	Contacts	Catalog Number
Body: Single pole, double break, 1 N.O. + 1 N.C. Snap action, positive opening, same polarity	Silver	ZCKL1H7
	Gold Flashed	ZCKL18H7
Body: Single pole, double break, 1 N.O. + 1 N.C. Slow make, slow break isolated	Silver	ZCKL5H7

**Table 21.48: Rotary Heads**

Components	Catalog Number
Programmable head [2] CW and/or CCW	Select lever arm separately ZCKG00
Offset Delrin roller lever [3]	ZCKD15
Offset steel roller lever [3]	ZCKD16
Offset ball-bearing roller lever [3]	ZCKD17

**Table 21.49: Plunger Heads**

Description	Catalog Number
Rod plunger	ZCKD10
Booted rod plunger	ZCKD109
Roller plunger	ZCKD02
Booted roller plunger	ZCKD029
One-way lever—Delrin roller	ZCKD21
Steel roller	ZCKD23

**Table 21.50: Omnidirectional Heads**

Description	Catalog Number
Cat whisker—steel rod [4]	ZCKD06
Wobble spring—steel spring [4]	ZCKD08

**Table 21.51: Replacement Parts**

Description	Catalog Number
Contact block for ZCKL1	XESP2151
Contact block for ZCKL5	XENP2151
Gold flashed contact block for ZCKL18	XESP2158
Pg 11 to 1/2" NPT conduit entry adapter	DE9RA1012

**Table 21.52: Levers (for use with ZCKG00 heads only—will not fit ZCKD heads)**

Description	Size	Adjustment [5] Increments	Catalog Number
Delrin roller	0.9 in. diameter, 0.2 in. wide, 1.6 in. long	5° or 45°	ZCKY11
Steel roller	0.9 in. diameter, 0.2 in. wide, 1.6 in. long	5° or 45°	ZCKY13
Ball bearing roller	0.9 in. diameter, 0.2 in. wide, 1.6 in. long	5° or 45°	ZCKY14
Adjustable length Delrin roller [6]	0.74 in. diameter, 0.2 in. wide, 4.2 in. long (max.)	5° or 90°	ZCKY41
Steel roller	0.74 in. diameter, 0.2 in. wide, 4.2 in. long (max.)	5° or 90°	ZCKY43
Steel rod, square [6]	1/8 in. side, 5.4 in. long (max.)	5° or 45°	ZCKY51
Fiberglass rod, round [6]	1/8 in. diameter, 5.4 in. long (max.)	5° or 45°	ZCKY52
Steel rod, round [6]	1/8 in. diameter, 5.4 in. long (max.)	5° or 45°	ZCKY53
Plastic rod, round [6]	1/4 in. diameter, 8.4 in. long (max.)	5° or 45°	ZCKY59
Fork, 2 track Delrin roller	0.9 in. diameter, 0.2 in. wide for ZCKE092	5° or 45°	ZCKY71
Coil spring lever [6]	4.41 in. (112 mm)	5° or 45°	ZCKY81
Spring rod lever [6]	7.05 in. (179 mm)	5° or 45°	ZCKY91

Acceptable Wire Sizes: 14–24 AWG  
Recommended Terminal Clamp Torque: 13 lb-in

**ZCKG00 Programming**

The ZCKG00 head is field convertible to CW, CCW, or CW/CCW.



File: 78403  
CCN: NKCR



File: LR25490  
Class: 3211 03



Reverse Lever Mounting



[2] See page 21-28

[3] Replacement arms are not available separately. Order complete head as a replacement.

[4] Replacement cat whiskers and wobble extensions are not available separately. Order complete head as a replacement.

[5] Reverse mounting (for ZCKG00 head)—The higher increment (45° or 90°) is a positive opening contact feature which ensures no loss of mechanical effort between the actuation point and the moving contact bridge of the N.C. contact even if the lever is loosely mounted on the head shaft.

[6] Flexible operators do not guarantee direct (positive) opening operation.

**Overview — Standard Industrial, Metal**

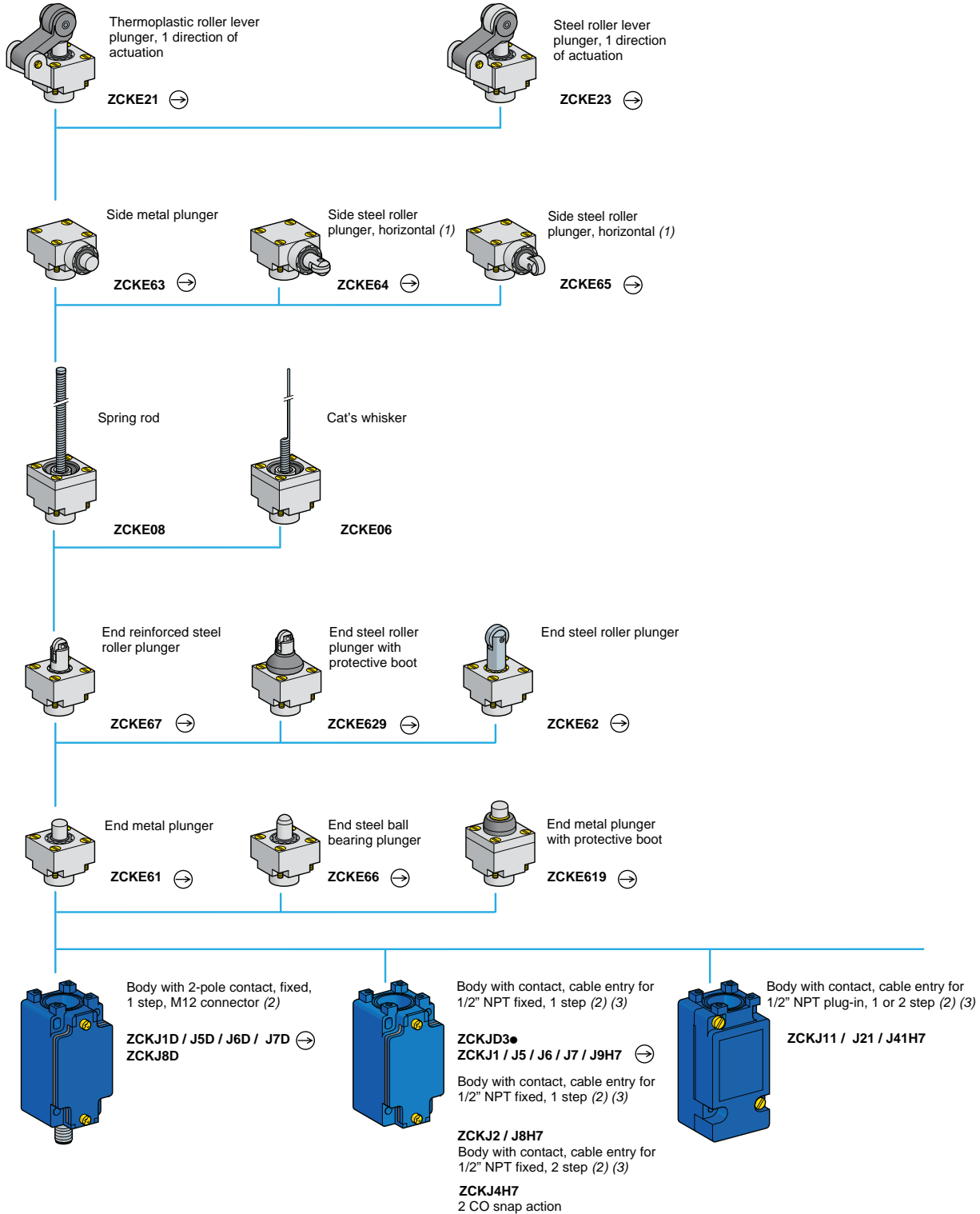

(1) Cannot be used with bodies ZCKJ4H7 and ZCKJ41H7.  
 (2) For further information, see page 21-27.  
 (3) For a cable entry tapped ISO M20 x 1.5, change H7 to H29. Example: ZCKJ1H7 becomes ZCKJ1H29.  
 For a cable entry tapped Pg 13.5, delete H7 from the catalog number. Example: JCKJ1H7 becomes ZCKJ1.

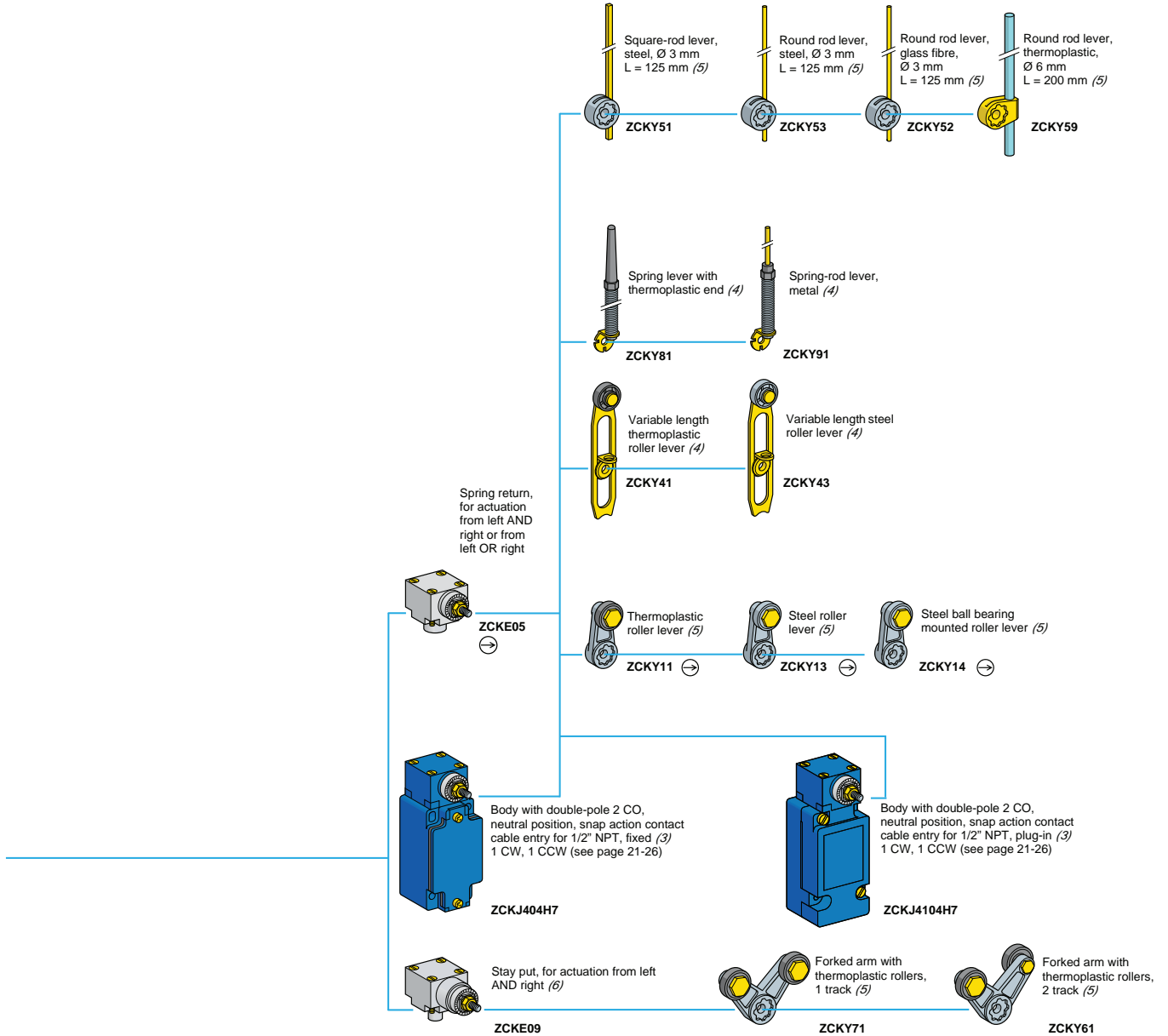

⊖ Head assuring positive opening operation when used with a conforming lever.  
 (4) Adjustable throughout 360° in 5° steps, or in 90° steps by reversing the notched washer.  
 (5) Adjustable throughout 360° in 5° steps, or in 45° steps by reversing the lever mounting.  
 (6) Suitable for bodies with contacts ZCKJ1 / J2 / J31 / J39H7.

XCKJ Switches

XCKJ fixed body type precision switches with an SPDT configuration have direct opening contacts to meet most international standards.

Table 21.53: Specifications

Rated Power (conforms to IEC 947-5-1, duty categories AC15 and DC13)	
Temperature range	-13 to +158 °F (-25 to +70 °C); optional -40 to +248 °F (-40 to +120 °C). The minimum temperatures listed are based on the absence of freezing moisture or water.
Enclosure rating	NEMA 1, 2, 3, 4, 12; IEC Type IP66
Vibration resistance	25 G (10-500 Hz), conforming to IEC 68-2-6
Shock resistance	50 G, conforming to IEC 68-2-27
Repeatability (max.)	0.0004 in. (0.01 mm)
Cable entry	1/2" NPT standard
Contact Characteristics	
Rated thermal current	10 A, conforming to UL 508, CSA C22-2 No.14, IEC 337-1, NFC 63-140, VDE 0660-200
Rated insulation voltage	Non-plug-in: 300 Vac (A300) and DC (Q300) Plug-in: 600 Vac (A600) and DC (Q600)
Contact resistance (max)	Non-plug-in: 25 m W Plug-in: 45 m W
Cable (max.)	2 x 16 AWG (1.5 mm <sup>2</sup> ) per terminal—1 x #16 AWG for 2 SPDT (2 N.O., 2 N.C.)
Short circuit protection	10 A fuse type SC; Form I Class J or equivalent. Outside US use type gl or N.

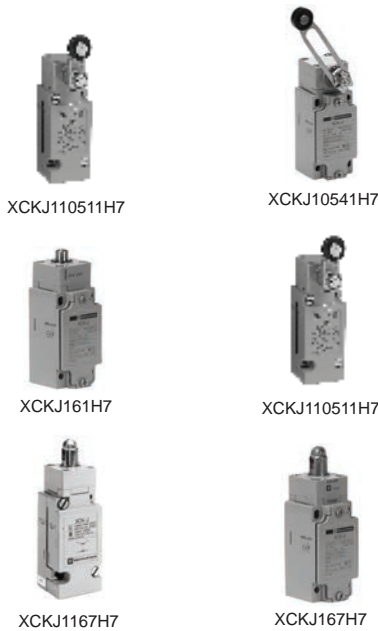

Table 21.54: Complete Switches, XCKJ

Description and Functional Diagram	Operating Torque	Contact Type	Direct Opening	Catalog Number
<b>Non-plug-in Housings</b>				
<b>Delrin roller lever adjustable in 5° or 45° increments (reversible mountings)</b>				
	33.3 oz-in	SPDT (N.O. + N.C.)	Y [1]	XCKJ10511H7
	33.3 oz-in	2 SPDT (2 N.O. + 2 N.C.)	N	XCKJ20511H7
<b>Adjustable length—Delrin roller lever adjustable in 5° or 90° increments</b>				
	33.3 oz-in	SPDT (N.O. + N.C.)	N	XCKJ10541H7
	33.3 oz-in	2 SPDT (2 N.O. + 2 N.C.)	N	XCKJ20541H7
<b>Adjustable length—1/8 in. diameter steel rod adjustable in 5° or 45° increments</b>				
	33.3 oz-in	SPDT (N.O. + N.C.)	N	XCKJ10553H7
<b>Adjustable length—1/4 in. plastic rod adjustable in 5° or 45° increments</b>				
	33.3 oz-in	SPDT (N.O. + N.C.)	N	XCKJ10559H7
<b>Neutral Position</b> One SPDT contact switch per direction. Past 20° CW, contact 1 (11-12 / 13-14) switches. Past 20° CCW, contact 2 (21-22 / 23-24) switches. Levers not included.				
	26.6 oz-in	2 SPDT (2 N.O. + 2 N.C.)	N	ZCKJ404H7
<b>Plunger Operated</b>				
	Rod plunger 48 oz	SPDT (N.O. + N.C.)	Y [1]	XCKJ161H7
	Steel roller plunger 48 oz	SPDT (N.O. + N.C.)	Y [1]	XCKJ167H7
<b>Plug-in Housings</b>				
<b>Lever Operated</b>				
	33.3 oz-in	SPDT (N.O. + N.C.)	N	XCKJ110511H7
	33.3 oz-in	2 SPDT (2 N.O. + 2 N.C.)	N	XCKJ110541H7
<b>Neutral Position</b> One SPDT contact switch per direction. Past 20° CW, contact 1 (11-12 / 13-14) switches. Past 20° CCW, contact 2 (21-22 / 23-24) switches. Levers not included.				
	26.6 oz-in	2 SPDT (2 N.O. + 2 N.C.)	N	ZCKJ4104H7
<b>Plunger Operated</b>				
	Rod plunger 48 oz	SPDT (N.O. + N.C.)	N	XCKJ1161H7
	Steel roller plunger 48 oz	SPDT (N.O. + N.C.)	N	XCKJ1167H7

Exploded view page 21-30

[1] Direct opening contacts meet IEC 947-5-1 requirements for positive opening contacts.

**XCKJ Bodies and Options**

**Table 21.55: Non-plug-in**

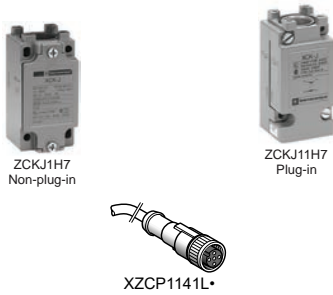

Silver Contacts (10 A)				Direct Opening	Catalog Number
1 Step	SPDT	(N.O. + N.C.)	Snap action	Y[2]	ZCKJ1H7
1 Step	SPDT	(isolated N.O. + N.C.)	Slow break-before-make	Y[2]	ZCKJ5H7
1 Step	2 SPDT	(2 N.O. + 2 N.C.)	Snap action	N	ZCKJ2H7
2 Step	2 SPDT	(2 N.O. + 2 N.C.)	Snap action	N	ZCKJ4H7
Gold Flashed Contacts (low power circuits max. 12 V, 0.1 A)					
1 Step	SPDT	(N.O. + N.C.)	Snap action	Y[2]	ZCKJ18H7
1 Step	2 SPDT	(2 N.O. + 2 N.C.)	Snap action	N	ZCKJ28H7
High Temperature: +248 °F (+120 °C)					
1 Step	SPDT	(N.O. + N.C.)	Snap action	Y[2]	ZCKJ15H7
1 Step	2 SPDT	(N.O. + N.C.)	Snap action	N	ZCKJ25H7
Neutral Position	2 SPDT	(2 N.O. + 2 N.C.)	Snap action	N	ZCKJ4045H7

**Table 21.56: Plug-in**

Silver Contacts (10 A)				Direct Opening	Catalog Number
1 Step	SPDT	(N.O. + N.C.)	Snap action	N	ZCKJ11H7
1 Step	2 SPDT	(2 N.O. + 2 N.C.)	Snap action	N	ZCKJ21H7
2 Step	2 SPDT	(2 N.O. + 2 N.C.)	Snap action	N	ZCKJ41H7
High Temperature: +248 °F (+120 °C)					
1 Step	SPDT	(N.O. + N.C.)	Snap action	N	ZCKJ115H7
1 Step	2 SPDT	(2 N.O. + 2 N.C.)	Snap action	N	ZCKJ215H7
Neutral Position	2 SPDT	(2 N.O. + 2 N.C.)	Snap action	N	ZCKJ41045H7

**Table 21.57: Wiring Options**

	Catalog Number	Pins	Suffix
Mini style male receptacle (For example, to order a ZCKJ1H7 body with a mini-style connector option, the part number is ZCKJ1547.)	ZCKJ1/J11/J5H7	5 pins	547
	ZCKJ2/J4/J21/J41H7	9 pins	947

**Table 21.58: Plug and Cable Assemblies**

Description	Cable Length	Pins	Matches Receptacle Option	Catalog Number
Plug and cable	3 ft	5	547	BH2053
	6 ft			BH2056
	12 ft			BH20512
Plug and cable	3 ft	9	947	BH2093
	6 ft			BH2096
	12 ft			BH20912
Pre-wired connector, female	6.56 ft	4	XCSDMR-L / XCSDMP-L	XZCP1141L2
	16.40 ft			XZCP1141L5
	32.81 ft			XZCP1141L10

**Building a Complete Switch**

**Complete Switch = Body (with contact assembly)+ Head + Lever**

**Example:**

$$\text{Body ZCKJ1H7} + \text{Head ZCKE05} + \text{Lever ZCKY11} = \text{XCKJ10511H7}$$

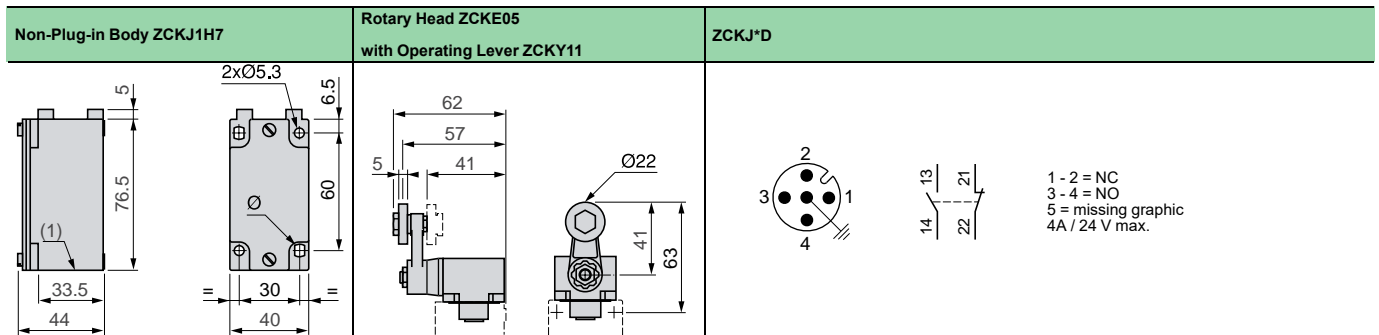

File E39281  
CCN NKCR



File LR44087  
Class 3211-03



Acceptable Wire Sizes: 14–24 AWG  
Recommended Terminal Clamp Torque: 13 lb-in

[2] Direct opening contacts meet IEC 947-5-1 requirements for positive opening contacts when using head.

Operating Heads

Table 21.59: Lever-Operated Heads

Contact Operation with Switch Bodies:	1 Step	2 Step	1 Step	Operating Force/Torque	Catalog Number
	ZCKJ1[3] / J11 / J2 / J21H7	ZCKJ4 / J41H7	ZCKJ5H7 [3]		
Standard operation 1 Step CW and/or CCW				33 oz-in, 0.25 N	ZCKE05
2 Step 11-12, 13-14 first step					
21-22, 23-24 second step					
ZCKE05 Programming					
	<b>CW and CCW</b>	<b>CW</b>	<b>CW and CCW</b>	<b>CCW</b>	
Maintained operation				33 oz-in, 0.25 N	ZCKE09

NOTE: Neutral position head ZCKE04 is not available separately. Order the head and body subassemblies from page 21-30.

Table 21.60: Plunger-Operated Heads

Contact Operation with Switch Bodies:	1 Step	2 Step	1 Step	Operating Force/Torque	Catalog Number
	ZCKJ1[3] / J11 / J2 / J21 / H7	ZCKJ4 / J41H7	ZCKJ5H7 [3]		
Top rod plunger				48 oz 18 N	ZCKE61
Ball-bearing top plunger				48 oz 18 N	ZCKE66
Steel roller plunger				48 oz 18 N	ZCKE67
One-way Delrin roller based on actuation by 30° cam				48 oz 18 N	ZCKE21
One way steel roller based on actuation by 30° cam				48 oz 18 N	ZCKE23
Side rod plunger				48 oz 18 N	ZCKE63
Side steel roller-plunger, horizontal based on actuation by 30° cam				48 oz 18 N	ZCKE64
Side steel roller-plunger, vertical based on actuation by 30° cam				48 oz 18 N	ZCKE65

[3] Direct opening when used with any head on this page except ZCKE09 (maintained operation).

**XCKJ Accessories**

**Table 21.61: Omnidirectional Heads**

Non-plug-in Style Contact Block



XE2SP2151



ZCKY11/13/14



ZCKY43/41



ZCKY51/52/53/59



ZCKY61



ZCKY71



ZCKY81



ZCKY91

Contact Operation with Switch Bodies:	1 Step	2 Step	1 Step	Operating Force/Torque	Catalog Number
	ZCKJ1, J11, J2, J21	ZCKJ4, J41	ZCKJ5		
Cat whisker-steel [4]				18.4 oz-in, 0.13 N	ZCKE06
Wobble coil springs [4]				18.4 oz-in, 0.13 N	ZCKE08

**Table 21.62: Operating Heads—for extended temperature ranges**

Description	Catalog Number	
	Low temperature [5] -40 °F to +158 °F (-40 °C to +70 °C)	High temperature [5] -13 °F to +248 °F (-25 °C to +120 °C)
Lever operated	Standard operations	ZCKE056
	Maintained operations	ZCKE096
Plunger operated	Top rod plunger	ZCKE616
	Ball-bearing top plunger	ZCKE666
	Top roller plunger	ZCKE676
	One way Delrin roller	ZCKE216
	One way steel roller	ZCKE236
	Side rod plunger	ZCKE636
	Side steel roller plunger-horizontal	ZCKE646
Omnidirectional	Side steel roller plunger-vertical	ZCKE656
	Cat whisker	ZCKE066
	Wobble coil spring	ZCKE086

**Table 21.63: Replacement Parts**

Description	Direct Opening	Catalog Number
(see page 21-30 for contact description)		
Contact block for ZCKJ1H7	Y	XE2SP2151
Contact block for ZCKJ2H7	N	XESP2021
Contact block for ZCKJ4H7	N	XESP2031
Contact block for ZCKJ5H7	Y	XE2NP2151
Contact block for ZCKJ18H7 (gold flashed)	Y	XE2SP2158
Contact block for ZCKJ28H7 (gold flashed)	N	XESP2028
Plug-in module for ZCKJ11H7 (includes contact block)	N	ZCKJ01H7
Plug-in module for ZCKJ21 (includes contact block)	N	ZCKJ02H7
Plug-in module for ZCKJ41 (includes contact block)	N	ZCKJ04H7
Base receptacle for ZCKJ11H7	—	ZCKJ019H7
Base receptacle for ZCKJ21H7	—	ZCKJ029H7
Base receptacle for ZCKJ41H7	—	ZCKJ029H7

**Table 21.64: Lever Arms**

Description	Adjustment Increments	Catalog Number
<b>Adjustable or Flexible Operators [6]</b>		
Adjustable Delrin roller, 0.74 in. diameter, 0.2 in. wide, 3 in. long (max.)	5° or 90°	ZCKY41
Adjustable steel roller, 0.74 in. diameter, 0.2 in. wide, 3 in. long (max.)	5° or 90°	ZCKY43
Adjustable rod-square, steel, 1/8 in. side, 5.4 in. long (max.)	5° or 45°	ZCKY51
Adjustable rod-round, fiberglass, 1/8 in. diameter, 5.4 in. long (max.)	5° or 45°	ZCKY52
Adjustable rod-round, steel, 1/8 in. diameter, 5.4 in. long (max.)	5° or 45°	ZCKY53
Adjustable rod-round, plastic, 1/4 in. diameter, 8.4 in. long (max.)	5° or 45°	ZCKY59
Coil spring lever	5° or 90°	ZCKY81
Spring rod lever	5° or 90°	ZCKY91
<b>Reverse Mounting</b>		
Delrin roller 0.9 in. diameter, 0.2 in. wide, 1.6 in. long	5° or 45° [7]	ZCKY11
Steel roller 0.9 in. diameter, 0.2 in. wide, 1.6 in. long	5° or 45° [7]	ZCKY13
Ball bearing roller 0.9" diameter, 0.2 in. wide, 1.6 in. long	5° or 45° [7]	ZCKY14
Fork, 2 track, Delrin roller, 0.9 in. diameter, 0.2 in. wide for ZCK-E09	5° or 45° [7]	ZCKY61
Fork, 1 track, Delrin roller, 0.9 in. diameter, 0.2 in. wide for ZCK-E09	5° or 45° [7]	ZCKY71

[4] Flexible operators do not guarantee direct (positive) opening operation.

[5] The minimum temperatures listed are based on the absence of freezing moisture or water.

[6] Adjustable and flexible operators do not guarantee positive opening operation.

[7] Reverse mounting: The higher increment (45°) is a direct (positive) opening contact feature which ensures no loss of mechanical effort between the actuation point and the moving contact bridge of the direct (positive) contact (N.C.) even if the lever is loosely mounted.

Overview — 9007C Adaptable Sub-Assemblies

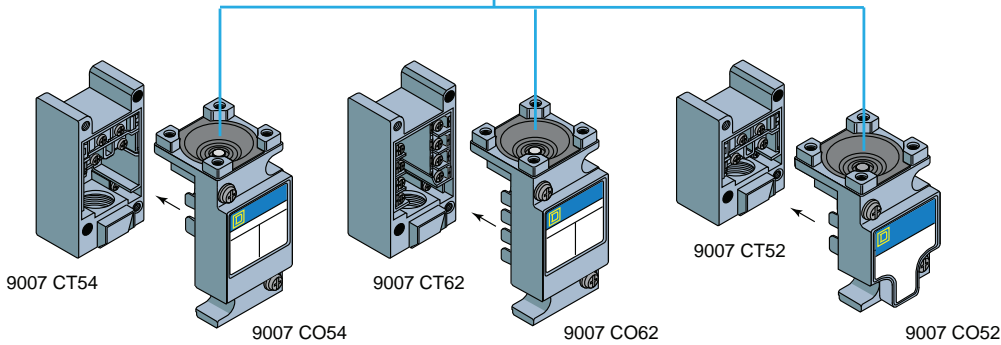
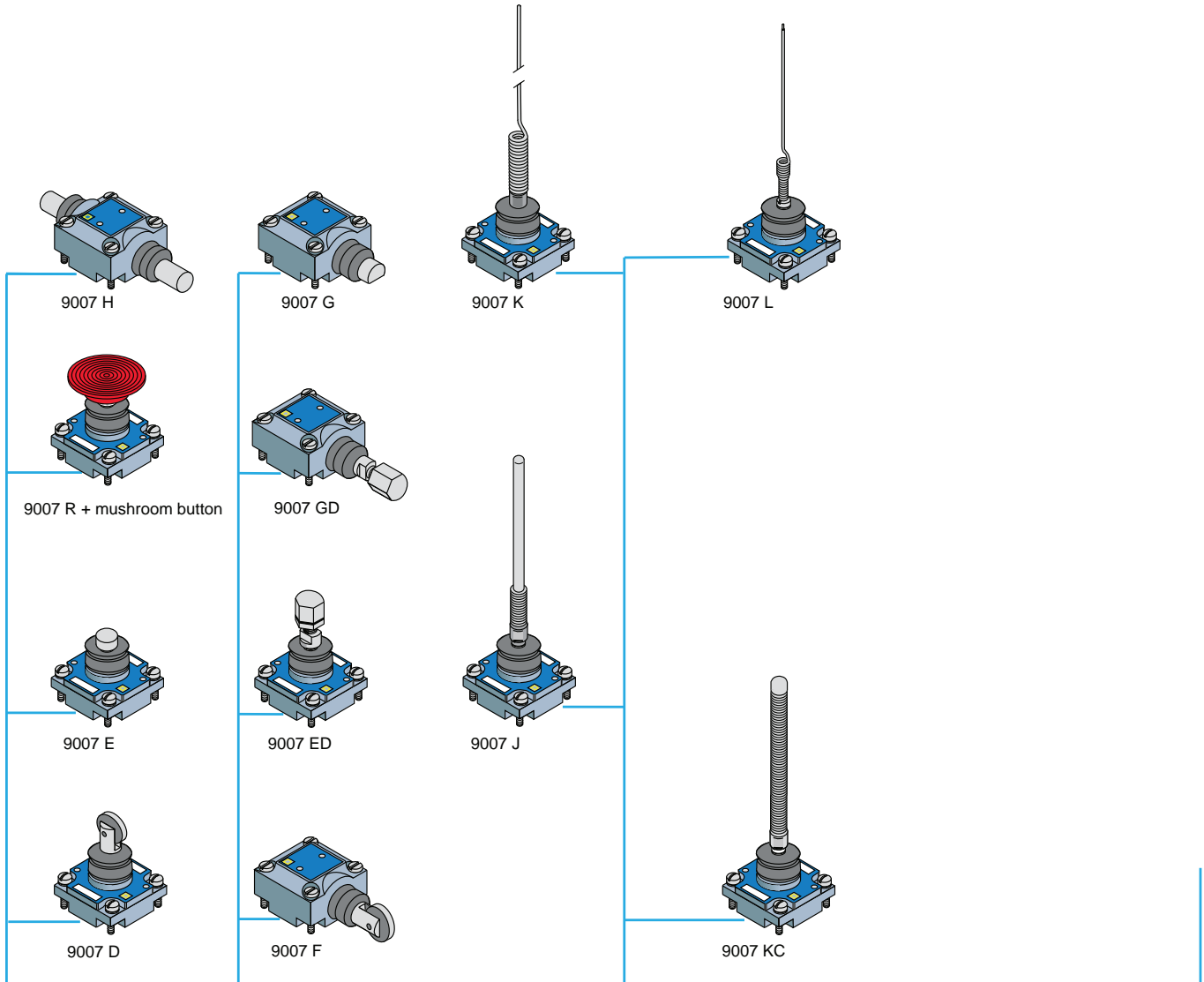

**NOTE:** Order the mushroom operator cap from [page 21-39](#).





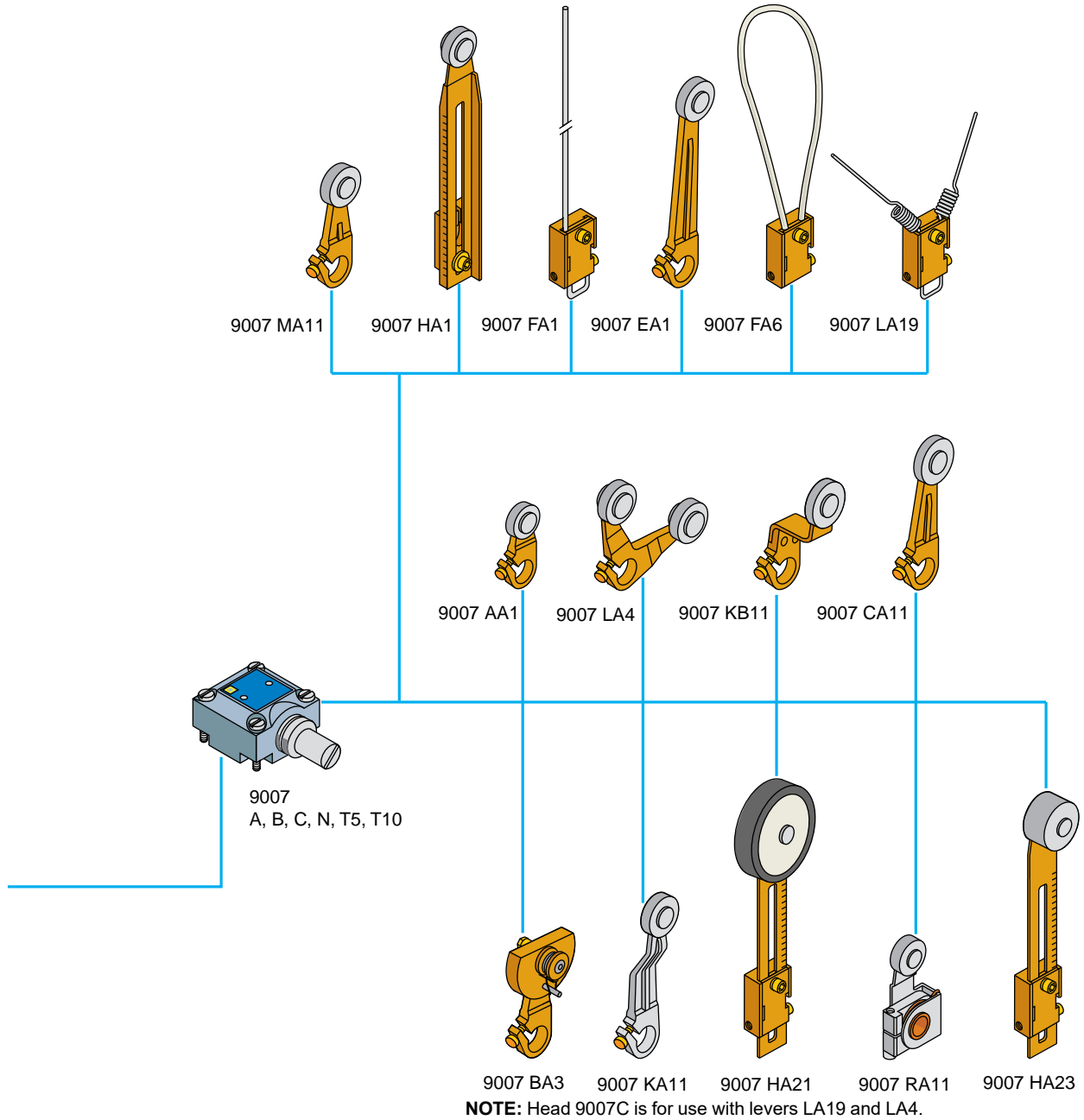

**Overview—Head 9007C Lever Switches**

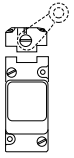

Oiltight, Watertight Switches—Standard and Compact Bodies

Table 21.65: All Type C Switches—Standard and Compact Bodies

Select Turret Head		Rotary Lever Arm					Side Plunger				
	Standard Pre-travel Spring Return	Low Differential Spring Return	Neutral Position		Light Operating Torque Spring Return	Maintained Contact	Side Roller-Plunger Spring Return Vertical Roller Type [1]	Side Push-Rod Plunger Spring Return	Side Push-Rod Plunger Adjustable Spring Return [2]	Side Push-Rod Plunger Maintained Contact	
	CW & CCW [3]	CW & CCW [3]	CW & CCW	CW & CCW	CW & CCW [3]	CW (Trip) CCW (Reset)					
Select Basic Switch	Contacts	Type (Class 9007)									
Standard Box Plug-in	1 N.O. 1 N.C.	C54B2	C54A2	—	—	C54N2	C54C	C54F	C54G	C54GD	C54H
	2 N.O. 2 N.C.	C62B2	C62A2	—	—	C62N2	C62C	C62F	C62G	C62GD	C62H
	2 N.O.—2 N.C. Neutral Position	—	—	C68T10	C68T5	—	—	—	—	—	—
	2 N.O.—2 N.C. Two Stage	C66B2	C66A2	—	—	C66N2	—	C66F	C66G	C66GD	—
Compact Box Plug-in	1 N.O. 1 N.C.	C52B2	C52A2	—	—	C52N2	C52C	C52F	C52G	C52GD	C52H
	UL Listed for Hazardous Location Division I Class I Groups B, C, D Class II Groups E, F, G	1 N.O. 1 N.C.	CR53B2	CR53A2	—	—	CR53N2	CR53C	CR53F	CR53G	CR53GD
	2 N.O. 2 N.C.	CR61B2	CR61A2	—	—	CR61N2	CR61C	CR61F	CR61G	CR61GD	CR61H
	2 N.O.—2 N.C. Neutral Position	—	—	CR67T10	CR67T5	—	—	—	—	—	—
	2 N.O.—2 N.C. Two Stage	CR65B2	CR65A2	—	—	—	—	—	—	—	—
Head Only (Example: 9007B)		B	A	T10	T5	N	C	F	G	GD	H
Nominal Operating Data	Pre-travel	10°	5°	10°	5°	10°	45°	0.08 in. (2 mm)		0.14 in. (3.6 mm)	
	Pre-travel Two Stage	First Stage	10°	5°	—	—	10°	—	0.08 in. (2 mm)		—
		First to Second Stage	2-1/2°	1-1/2°	—	—	2-1/2°	—	0.02 in. (0.5 mm)		—
	Total Travel	90°	90°	90°	90°	90°	90°	0.25 in. (6.3 mm)		0.25 in. (6.3 mm)	
	Differential	4°	2°	4°	2°	4°	—	0.03 in. (0.8 mm)		—	
	Reverse Overtravel	90°	90°	90°	90°	90°	—	—		—	
	Operating Torque/Force—1 Pole & 2 Pole	4 lb-in (0.45 N•m)	4 lb-in (0.45 N•m)	4 lb-in (0.45 N•m)	4 lb-in (0.45 N•m)	25 oz-in (0.18 N•m)	3 lb-in (0.34 N•m)	4 lb (0.45 N•m)		7 lb (0.80 N•m)	
Repeat Accuracy—Linear travel of cam (1-1/2 in. lever arm)	± 0.002 in. (0.05 mm)	± 0.001 in. (0.03 mm)	± 0.002 in. (0.05 mm)	± 0.002 in. (0.05 mm)	± 0.002 in. (0.05 mm)	± 0.002 in. (0.05 mm)	0.001 in. (0.3 mm)		—		

NOTE: CW = clockwise; CCW = counter-clockwise

Acceptable Wire Sizes: 12–22 AWG.  
Recommended Terminal Clamp Torque: 7 lb-in (0.80 N•m)

Mode Change—Lever Arm Type

Mode of operation is easily convertible to clockwise, counterclockwise, or both. Simply point the arrow to the letters representing the desired direction—CW, CCW, or CW/CCW. All parts are captive.

Exploded view page 21-36, Rotary Head Lever Arms, page 21-37

Lever arms page 21-9, page 21-40, page 21-41

Electrical ratings page 21-5

Special features page 21-41, page 21-42

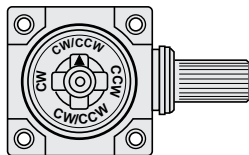











[1] Can be converted to horizontal roller type in the field. To order horizontal roller version add the letter "H" at the end of the equivalent vertical roller version type number (Example: C54F would become C54FH).

[2] To lock the nut in the desired position, crimp the slot near the bottom of the nut.

[3] These devices are factory set to operate the contacts in both the CW and CCW directions. Mode of operation is field convertible to CW only or CCW only. To order factory converted devices—for CCW only operation, change the "2" at the end of the type number to "1" (Example: C54B2 becomes C54B1); for CW only operation, delete the "2" at the end of the type number (Example: C54B2 becomes C54B).

**Type C Switches**

**Table 21.66: All Type C Switches Rated NEMA 6P And UL Type 6P**

Select Turret Head		Top Plunger				Wobble Stick				Plug-In	
		Top Roller-Plunger Spring Return	Top Push-Rod Plunger Spring Return	Top Push-Rod Plunger Adjustable Spring Return	Palm Operated	Wobble Stick Delrin Extension	Wobble Stick Wire Extension	Wobble Stick Coil Spring Extension	Cat Whisker	Plug-in Unit without Head	Plug-in Receptacle Only
											
Select Basic Switch	Contacts	Type (Class 9007)									
Standard Box Plug-in	1 N.O. 1 N.C.	C54D	C54E	C54ED	C54R	C54J	C54K	C54KC	C54L	CO54	CT54
	2 N.O. 2 N.C.	C62D	C62E	C62ED	—	C62J	C62K	C62KC	C62L	CO62	CT62
	2 N.O.–2 N.C. Neutral Position	—	—	—	—	—	—	—	—	CO68	CT62
	2 N.O.–2 N.C. Two Stage	C66D	C66E	C66ED	—	C66J	C66K	C66KC	C66L	CO66	CT62
Compact Box Plug-in	1 N.O. 1 N.C.	C52D	C52E	C52ED	C52R	C52J	C52K	C52KC	C52L	CO52	CT52
UL Listed for Hazardous Location Division I Class I Groups B, C, D Class II Groups E, F, G	1 N.O. 1 N.C.	CR53D	CR53E	CR53ED	CR53R	CR53J	CR53K	CR53KC	CR53L	—	—
	2 N.O. 2 N.C.	CR61D	CR61E	CR61ED	CR61R	CR61J	CR61K	CR61KC	CR61L	—	—
	2 N.O.–2 N.C. Neutral Position	—	—	—	—	—	—	—	—	—	—
	2 N.O.–2 N.C. Two Stage	CR65D	—	CR65ED	—	CR65J	CR65K	CR65KC	—	—	—
Head Only		D	E	ED	R [5]	J	K	KC	L	—	—
Nominal Operating Data	Pre-travel	0.08 in. (2 mm)				10° (Any Direction)			20°		
	Pre-travel First Stage	0.08 in. (2 mm)				10° (Any Direction)			20°		
	Pre-travel Two Stage	0.01 in. (0.06 mm)				4°			5°		
	Total Travel	0.25 in. (6.3 mm)				90°			90°		
	Differential	0.02 in. (0.5 mm)				3°			6°		
	Reverse Overtravel	—				—			—		
	Operating Torque/ Force— 1 Pole and 2 Pole	3 lbs. (0.34 N•m)				3 lb-in (0.34 N•m)			7 oz-in (0.05 N•m)		
	Repeat Accuracy — Linear travel of cam	± 0.001 in. (0.03 mm)				—			—		

Acceptable Wire Sizes: 12–22 AWG  
Recommended Terminal Clamp Torque: 7 lb-in (0.80 N•m)

**Table 21.67: Mushroom Button For Palm Operated Turret Head**

Color	Catalog No.	
	1-3/8 in. Dia. Button	2-1/4 in. Dia. Button
Black	2358C6G3	2358C22G2
Red	2358C6G2	2358C22G3
Green	—	2358C22G6

**Table 21.68: Wobble Stick Extensions**

Description	Catalog Number
Delrin extension	9007WJ
Wire extension	9007WK
Coil spring extension	9007WKC

Type C  File CCN E78403 NKCR  File Class LR25490 3211-03 

Type CR  File CCN E10054 NOIV  File Class LR26817 3218-02



[4] To lock the nut in the desired position, crimp the slot near the bottom of the nut.  
[5] Mushroom button must be ordered separately. See Table 21.67.  
[6] Delrin® is a registered trademark of DuPont. Not for use outdoors.  
[7] Wobble stick extensions are available separately as replacements for complete devices. See Table 21.68.

### Lever Arms for 9007AW and 9007C Heavy Duty / Industrial Limit Switches

Standard roller is hardened oil-impregnated sintered iron. Bold-face Catalog Numbers indicate the most commonly used lever arms.

Table 21.69: Cast Zinc Lever Arms

Length of Arm (A)	Catalog Number								
	Roller Style								
	Standard 3/4" Dia. (B) 1/4" Wide (C)	Standard 3/4" Dia. (B) 5/8" Wide (C)	Standard 5/8" Dia. (B) 1/4" Wide (C)	Standard 5/8" Dia. (B) 5/8" Wide (C)	Nylon 3/4" Dia. (B) 1/4" Wide (C)	Nylon 5/8" Dia. (B) 1/4" Wide (C)	Nylon 5/8" Dia. (B) 5/8" Wide (C)	Nylon [8] 1" Dia. (B) 5/8" Wide (C)	
7/8"	—	—	<b>9007AA1</b>	<b>9007AA2</b>	—	—	<b>9007AA17</b>	—	—
1-3/8"	<b>9007BA11</b>	9007BA12	<b>9007BA1</b>	9007BA2	9007BA18	9007BA8	9007BA17	9007BA13	—
1-1/2"	<b>9007MA11</b>	9007MA12	<b>9007MA1</b>	9007MA2	<b>9007MA18</b>	9007MA8	9007MA17	9007MA13	—
2"	<b>9007CA11</b>	9007CA12	<b>9007CA1</b>	9007CA2	9007CA18	9007CA8	9007CA17	9007CA13	—
2-1/2"	<b>9007DA11</b>	9007DA12	<b>9007DA1</b>	9007DA2	9007DA18	9007DA8	9007DA17	9007DA13	—
3"	<b>9007EA11</b>	9007EA12	<b>9007EA1</b>	9007EA2	9007EA18	9007EA8	9007EA17	9007EA13	—
Length of Arm (A)	Nylon 1" Dia. (B) 1/4" Wide (C)	Ball Bearing 1 1/16" Dia. (B) 1/4" Wide (C)	Standard 3/4" Dia. (B) 1/4" Wide (C) Roller on Opposite Side to Standard	Standard 5/8" Dia. (B) 1/4" Wide (C) Roller on Opposite Side to Standard	Standard 5/8" Dia. (B) 5/8" Wide (C) Roller on Opposite Side to Standard	Without Roller	Standard 3/4" Dia. (B) 1/4" Wide (C), Countersunk Roller Pin	Cable Operated With Eyebolt (3/8" I.D.) Instead of Roller	
7/8"	—	<b>9007AA9</b>	—	<b>9007AA5</b>	<b>9007AA6</b>	<b>9007AA0</b>	—	—	—
1-3/8"	9007BA4	9007BA9	9007BA15	9007BA5	9007BA6	9007BA0	—	—	—
1-1/2"	9007MA4	9007MA9	9007MA15	9007MA5	9007MA6	9007MA0	9007MA31	9007MA22	—
2"	9007CA4	9007CA9	9007CA15	9007CA5	9007CA6	9007CA0	9007CA31	—	—
2-1/2"	9007DA4	9007DA9	9007DA15	9007DA5	9007DA6	9007DA0	9007DA31	—	—
3"	9007EA4	9007EA9	9007EA15	9007EA5	9007EA6	9007EA0	—	—	—

Cast Zinc Lever Arm Dimensions

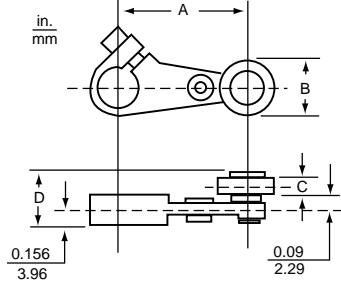

A = Length of Lever Arm  
B = Roller Diameter  
C = Roller Width  
D = C + 5/16"

See the tables in this topic for A, B, and C dimensions.



Flat Steel Lever Arm



90° Forked Arm 1-1/2" Length

Table 21.70: Flat Steel Lever Arms

Length of Arm (A)	Catalog Number				
	Roller Style				
	Standard 5/8" Dia. (B) 1/4" Wide (C)	Standard 5/8" Dia. (B) 5/8" Wide (C)	Nylon 3/4" Dia. (B) 1/4" Wide (C)	Nylon 1" Dia. (B) 1/4" Wide (C)	No Roller
7/8"	9007AA1S	9007AA2S	—	—	—
1-3/8"	9007BA1S	9007BA2S	—	9007BA4S	—
1-1/2"	—	—	9007MA18S	—	—
2"	9007CA1S	9007CA2S	—	9007CA4S	9007CA0S
2-1/2"	9007DA1S	9007DA2S	—	9007DA4S	9007DA0S
3"	9007EA1S	9007EA2S	—	9007EA4S	9007EA0S

Table 21.71: 90° Forked Cast Zinc Lever Arms

Roller Position	Catalog Number				
	Roller Style				
	Standard 3/4" Dia. (B) 1/4" Wide (C)	Standard 5/8" Dia. (B) 1/4" Wide (C)	Nylon 3/4" Dia. (B) 1/4" Wide (C)	Nylon 3/4" Dia. (B) 1" Wide (C)	Ball Bearing 1 1/16" Dia. (B) 1/4" Wide (C)
Rollers on Same Side	9007LA4	9007LA1	9007LA16	9007LA10	9007LA7
R.H. Roller on Opposite Side	9007LA5	9007LA2	9007LA17	9007LA11	—
L.H. Roller on Opposite Side	9007LA6	9007LA3	9007LA18	9007LA12	9007LA9

Approximate shipping weights range from 1/8 to 1/4 lb.

Table 21.72: One-Way Cast Zinc Roller Lever Arm

Length of Arm	Catalog Number	
	Roller, 1-1/4" Dia. (B) 1/4" Wide (C)	Cast Arm Flat Steel Arm
1-3/8"	9007BA3	9007BA3S
1-1/2"	9007MA3	—
2"	9007CA3	9007CA3S
2-1/2"	9007DA3	9007DA3S
3"	9007EA3	9007EA3S

Table 21.73: Offset-style Cast Zinc Lever Arms

Offset Lever Arm	Roller	Dia. (B)	Width (C)	Catalog Number
2" Length 7/16" Offset	Standard	5/8	1/4	<b>9007KA1</b>
		5/8	5/8	9007KA2
		3/4	1/4	9007KA11
		3/4	5/8	9007KA12
	Ball Bearing	11/16	1/4	9007KA9
1-1/2" Length 7/8" Offset	Nylon	3/4	1/4	9007KA18
		3/4	1	9007KA21
	Standard	3/4	1/4	9007KB11
		3/4	1/4	9007KB15 [9]

Table 21.74: One-Way Lever Arms

Length of Arm	Catalog Number				Rod Type
	Standard 3/4" Dia. (B) 1/4" Wide (C)	Nylon 3/4" Dia. (B) 1/4" Wide (C)	Ball Bearing 1-1/16" Dia. (B) 1/4" Wide (C)	9007RA9	
1-1/2"	9007RA11	9007RA18	—	—	—
5"	—	—	—	—	9007FA2

Table 21.75: Rod Type Lever Arms

Rod, in. (mm)	Catalog Number
10 (254) Stainless Steel Rod	<b>9007FA1</b>
12 (304) Spring Rod, Steel	<b>9007FA3</b>
18 (304) Spring Rod, Steel	9007FA4
12 Spring Rod, Delrin	<b>9007FA5</b>
Looped Delrin Rod	9007FA6
90° Forked Rod, 2-1/2" Spring Rods, Steel	9007LA19

Dimensions: page 21-41. For more information on LA19, refer to catalog 9006CT1007.

[8] Recommended in place of Types BA7, CA7, DA7, EA7 and MA7 lever arms with steel rollers. If necessary, the latter arms can be furnished at an additional cost.

[9] Roller inside.

**Lever Arms**

Standard roller is hardened oil-impregnated sintered iron.  
Bold-face Type numbers indicate the most commonly used lever arms.

**Table 21.76: Lever Arm, Adjustable Length from 7/8" to 4"**

Style	Type (Class 9007)								
	No Roller	Roller							
		Standard 5/8" Dia. 1/4" Wide	Standard 5/8" Dia. 5/8" Wide	Nylon 5/8" Dia. 1/4" Wide	Ball Brg. 11/16" Dia. 1/4" Wide	Nylon [10] 1" Dia. 5/8" Wide	Delrin 1-5/8" Dia. 1/4" Wide	Nylon 2" Dia. 1/4" Wide	Rubber Tire 2-1/8" Dia. 1/2" Wide
Non-bendable	HA0	<b>HA1</b>	<b>HA2</b>	<b>HA4</b>	HA24	HA22	—	—	—
Bendable	HA9	<b>HA5</b>	<b>HA6</b>	<b>HA8</b>	HA25	HA23	HA20	HA26	HA21

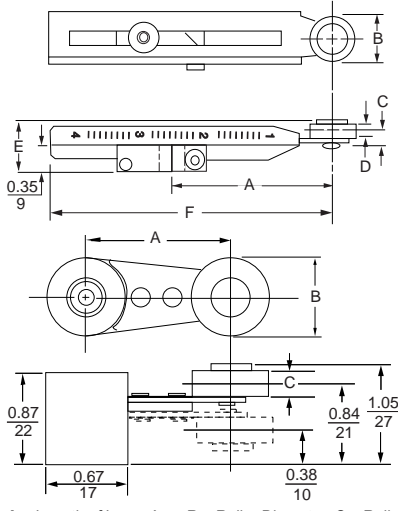

A = Length of Lever Arm; B = Roller Diameter; C = Roller Width

**Table 21.77: 360° Angular Adjustable Lever Arms**

Length of Arm	Catalog Number				
	Standard 5/8" Dia. 1/4" Wide	Standard 3/4" Dia. 1/4" Wide	Nylon 5/8" Dia. 1/4" Wide	Nylon 3/4" Dia. 1/4" Wide	Ball Bearing 11/16" Dia. 1/4" Wide
	Roller Outside	Roller Inside	Roller Outside		Roller Outside
7/8"	9007AA1M	—	—	9007AA8M	—
1-3/8"	9007BA1M	9007BA5M	9007BA11M	—	—
1-1/2"	9007MA1M	9007MA5M	9007MA11M	—	9007MA18M
2"	9007CA1M	9007CA5M	9007CA11M	9007CA8M	—
2-1/2"	9007DA1M	—	9007DA11M	—	9007DA18M
3"	9007EA1M	9007EA5M	9007EA11M	9007EA8M	9007EA18M

**NOTE:** Roller can be changed in the field from roller outside to roller inside position or vice versa.  
Approximate shipping weights range from 1/8 to 1/4 lb.

**Special Features**

**Table 21.78: Special Features (do not apply to Type CR unless noted)—Field Installable**

Description	Part Number
<b>Conduit Seal Only</b>	
Conduit seal fits in conduit entrance and excludes liquids	5 hole seal 9 hole seal
3103248801 3103281501	
<b>Adapters</b>	
Switch with adapter plate permitting substitution of any Type C switch with standard box for any Type T switch with Style B baseplate	Form Y147
Adapter plate kit only (plate plus mounting screws) for above	9007BT1
Adapter plate for direct substitution of Type C plunger switches for Type B plug-in plunger switches— <b>use only</b> if there is a problem in lining up cam tracks	Standard Box
9007CT10 [11]	
Metric conduit-connection adapter—male 1/2" NPT on one end, female 20 mm on the other end	9007CT12

**Rotary lever arms**

9007C\*\*\* A, B, C, N, T5, T10

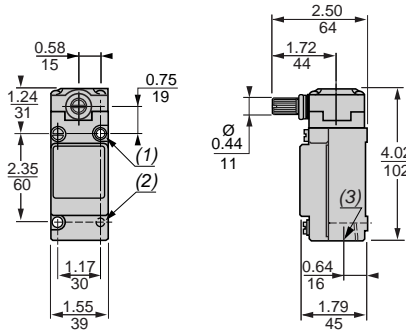

Dual dimensions:  
in. / mm

- 2 x 0.20/5 x 0.22/6 HLS.
- 2 x 10-24 Tapped HLS Back Mtg 0.29/7 DP.
- 1/2 14 NPT.

**Rod type lever arms**

9007FA1

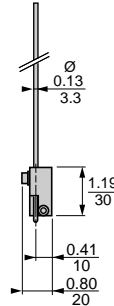
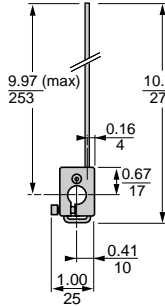

9007FA9

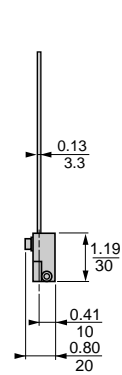
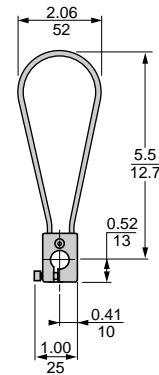





[10] Recommended in place of Types HA3 and HA7 lever arms with steel rollers. If necessary these arms can be furnished at an additional cost.

[11] Dimensions: 0.22 x 2.94 x 1.54 in.

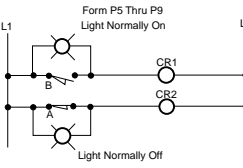
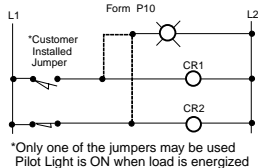
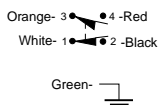
Factory Modifications

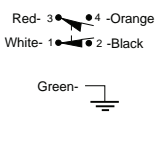
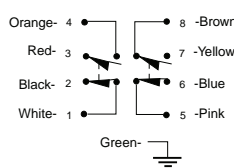
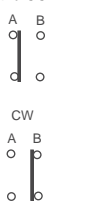
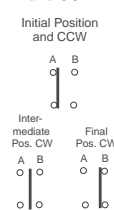
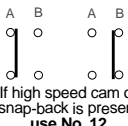
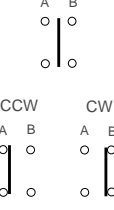
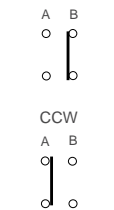
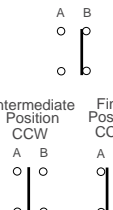
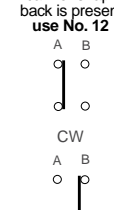

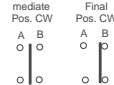
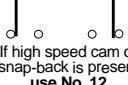
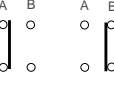
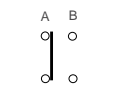
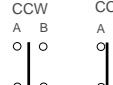
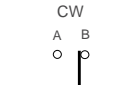







Table 21.79: Special Features (do not apply to Type CR unless noted)—Not Field Installable, Except Where Noted

Special Features	Form
<p><b>Optional Shaft Equipped With 9007T / 9007FT Hub:</b> Any lever arm Type C, CF, or CR switch can be furnished with an optional shaft and hub combination which will accept the lever arms normally used with Type T and FT limit (position) switches. To order, add <b>S9</b> as suffix to the device type number. For example, to order a 9007C54B2 with this modification, order as 9007C54B2S9. For details about the switches and lever arms that can be furnished with this modification, see catalog 9007CT1007.</p> <p><b>Hub Only:</b> Can be field installed on any Type C lever type switch.</p> 	<p>Add <b>S9</b> as a suffix to the catalog number</p> <p>Cat. No. 9007S9</p>
<p><b>LED Pilot Light, 24–120 Vac or Vdc on Plug-In Type Switch (Type C52, C54, C62, C64, C66, or C68):</b></p> <div style="display: flex; justify-content: space-around;"> <div style="text-align: center;"> <p>Form P5 Thru P9 Light Normally On</p>  </div> <div style="text-align: center;"> <p>Form P10 *Customer Installed Jumper</p>  <p>*Only one of the jumpers may be used Pilot Light is ON when load is energized</p> </div> </div>	<p>Addition of LED pilot light in parallel with N.O. contact (light normally on) P5</p> <p>Addition of LED pilot light in parallel with N.C. contact (light normally off) P6</p> <p>Addition of one isolated LED pilot light (light on when load is energized) (Type C54 only. Not available with Y1901.) P10</p>
<p><b>Pre-Wired Receptacle Single Pole</b></p>	<p>Plug-in limit (position) switch with pre-wired mini 5 pin male receptacle. For use with Brad Harrison female portable plug No. 41306, 41307, or 41308 (or equal). (Not available with P10 or for hazardous locations.) Y1901</p> <p>Same as Y1901 but with different wire color coding Y1905</p>
<p>Other versions with different wiring diagrams per automotive requirements are available. Contact your local Schneider Electric field office.</p> <p style="text-align: center;">Wiring Diagrams Form Y190_</p>	
<p><b>Mating plug and cables available.</b></p>	<div style="display: flex; justify-content: space-around;"> <div style="text-align: center;"> <p><b>Forms Y1901</b></p>  </div> <div style="text-align: center;"> <p><b>Form Y1905</b></p>  </div> </div> 
<p><b>Potted Limit (Position) Switch or Plug-In Receptacle Only: With Individual Wires</b></p> <ul style="list-style-type: none"> <li>Single pole plug-in limit (position) switch or receptacle pre-wired with <b>five #16 wires</b> 5 ft long and wire entry completely sealed with epoxy resin</li> </ul>	Y1841
<p><b>With STOWA Cord</b></p> <ul style="list-style-type: none"> <li>Single pole plug-in limit (position) switch or receptacle pre-wired with <b>five conductor #16 STOWA cord</b> 8 ft long and wire entry completely sealed with epoxy resin</li> <li>Double pole plug-in limit (position) switch or receptacle pre-wired with <b>nine conductor #16 STOWA cord</b> 8 ft long and wire entry completely sealed with epoxy resin</li> </ul>	Y1851 Y1852
<p>Other versions with different wiring diagrams for automotive requirements are available.</p> <div style="display: flex; justify-content: space-around;"> <div style="text-align: center;"> <p><b>Form Y1851</b></p>  </div> <div style="text-align: center;"> <p><b>Form Y1852</b></p>  </div> </div>	
<p><b>Low Temperature—Lever Types Only:</b> Limit (Position) switch will operate in an ambient temperature range of -40 to +185 °F (standard limit switch ambient temperature range is -20 to +185 °F). Minimum temperature is based on the absence of freezing moisture or water.</p>	Y128
<p><b>Fluorocarbon Rubber (FKM) Gaskets And Seals</b> Substitute fluorocarbon rubber gaskets and seals on:</p> <ul style="list-style-type: none"> <li>Lever arm type, standard box (shaft seals on lever arm types are fluorocarbon rubber as standard)</li> <li>Lever arm type, compact box (shaft seals on lever arm types are fluorocarbon rubber as standard)</li> <li>Plunger type, standard box</li> <li>Plunger type, compact box</li> </ul> <p><b>NOTE:</b> Fluorocarbon rubber has been shown to resist sunlight aging problems.</p>	Y140
<p><b>Direct Acting Contacts [12]</b> Substitution of direct acting contact unit for snap switch of single-pole switch: One pole, normally closed, slow-make slow-break, direct acting contact mechanism substituted for standard snap switch on Types C52, C54, CF53, and CR53 devices. This mechanism was designed for use in emergency overtravel applications. The movable contact of this basic switch unit is acted upon directly by the actuating mechanism of the limit switch—it does not depend on the force exerted by a snap-switch blade or a spring to open the circuit. Because these contacts are slow-make slow-break, they are best suited for applications where they are not actuated during normal operation, but only if abnormal overtravel is encountered.</p>	 <p>Direct Acting Contact Mechanism (shown without cover)</p> <p>Y1561</p>







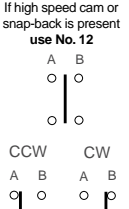
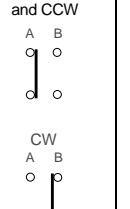
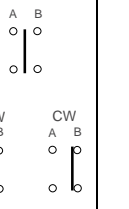
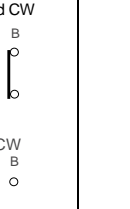
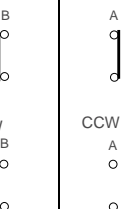
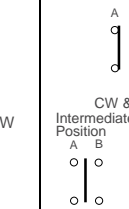
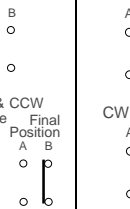
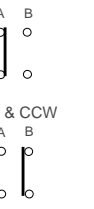
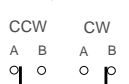
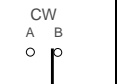
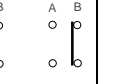
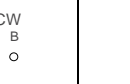
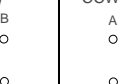
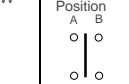
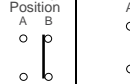

[12] The direct acting contacts described above come standard on the 9007CLS1 hoist overtravel switch.

**Selection**

**Table 21.80: Complete with Base Plate, Without Lever Arm (bold type numbers indicate the most commonly used switches)**

		Universal Type						
		No. 1	No. 2	No. 3 [1]	No. 4	No. 5	No. 6	No. 7 [1]
Select the Operating Sequence		Single-Pole Double-Throw Spring-Return CW Only	Single-Pole Double-Throw Spring-Return CW Only	Single-Pole Double-Throw Maintained Contact	Single-Pole Double-Throw Spring-Return Neutral Position	Single-Pole Double-Throw Spring-Return CCW Only	Single-Pole Double-Throw Spring-Return CCW Only	Single-Pole Double-Throw Maintained
		Initial Position and CCW 	Initial Position and CCW 	Spring return of arm to initial position, contact position maintained until operated in reverse direction CCW CW 	Initial Position 	Initial Position and CW 	Initial Position and CW 	If high speed cam or snap-back is present use No. 12 
Select the Basic Switch								
Surface Mounting	Base Plate	Catalog Number						
	A B C D	9007TUA1 <b>9007TUB1</b> 9007TUC1 9007TUD1	— <b>9007TUB2</b> — —	9007TUA3 9007TUB3 9007TUC3 —	9007TUA4 <b>9007TUB4</b> 9007TUC4 9007TUD4	9007TUA5 <b>9007TUB5</b> 9007TUC5 9007TUD5	— 9007TUB6 — —	— 9007TUB7 — <b>9007TUD7</b>
Nominal Operating Data	Pre-travel	14°	Int. Pos. 9°, Final 16°	7°	6°	14°	Int. Pos. 9°, Final 16°	10°
	Total-travel	88°	88°	81°	81°	88°	88°	85°
	Differential	12°	5°	7°	5°	12°	5°	12°
	Oper. Torque	12 lb-in	12 lb-in	12 lb-in	12 lb-in	12 lb-in	12 lb-in	2.5 lb-in
Repeat Accuracy [2]	±0.004 in.	±0.004 in.	±0.004 in.	±0.004 in.	±0.004 in.	±0.004 in.	±0.004 in.	±0.004 in.
To convert sequences, remove the base plate, positioning plate and latches. Reassemble the positioning plate and latches as shown.								 [3]

		Universal Type					Standard Type		
		No. 8 [1]	No. 9	No. 10	No. 11	No. 12	No. 1	No. 2	No. 3
Select the Operating Sequence		Single-Pole Maintained Double-Throw Neutral Position	Single-Pole Double-Throw Spring-Return Slow Make Slow Break	Single-Pole Double-Throw Spring-Return Slow Make Slow Break	Single-Pole Double-Throw Spring-Return Slow Make Slow Break	Single-Pole Double-Throw Maintained	Single-Pole Double-Throw Spring-Return CW & CCW	Single-Pole Double-Throw Spring-Return CW & CCW	Single-Pole Double-Throw Spring-Return CW & CCW Slow Make Slow Break
		Initial Position If high speed cam or snap-back is present use No. 12 	Initial Position and CCW 	Initial Position 	Initial Position and CW 	CCW 	Initial Position 	Initial Position 	Initial Position 
Select the Basic Switch									
Surface Mounting	Base Plate	Catalog Number							
	A B C D	— <b>9007TUB8</b> — —	— 9007TUB9 — —	— 9007TUB10 — —	— 9007TUB11 — —	— <b>9007TUB12</b> 9007TUC12 9007TUD12	9007TSA1 <b>9007TSB1</b> 9007TSC1 9007TSD1	— 9007TSB2 — —	— 9007TSB3 — —
Nominal Operating Data	Pre-travel	6°	12°	3°	12°	45°	14°	Int. Pos. 9°, Final 16	9°
	Total-travel	81°	87°	81°	87°	90°	89°	89°	89°
	Differential	10°	0°	0°	0°	0°	12°	Int. Pos. 5.5°, Final 7.5°	5°
	Oper. Torque	2.5 lb-in	12 lb-in	12 lb-in	12 lb-in	8 lb-in	10 lb-in	10 lb-in	10 lb-in
Repeat Accuracy [2]	±0.004 in.	±0.004 in.	±0.004 in.	±0.004 in.	±0.004 in.	±0.004 in.	±0.004 in.	±0.004 in.	±0.004 in.
To convert sequences, remove the base plate, positioning plate and latches. Reassemble the positioning plate and latches as shown.		 [3]				Not Adjustable			

**NOTE:** For a Type FT Foundry Switch, change the T at the beginning of the equivalent Type number to FT (for example, 9007TUB1 changes to 9007FTUB1).  
Lever arms page 21-44

[1] Sequence 3, 7, and 8 devices are available but are not recommended where high speed cams or lever arm snap-back is present. The application should be checked and No. 12 sequence substituted where possible.  
[2] Linear travel of cam on 1-1/2 in. lever arm.  
[3] Remove the spring from the positioning plate.

Class 9007 Type T and FT, Oiltight

Table 21.81: Lever Arms for Types T and FT Limit Switches or Type C with S9 Hub

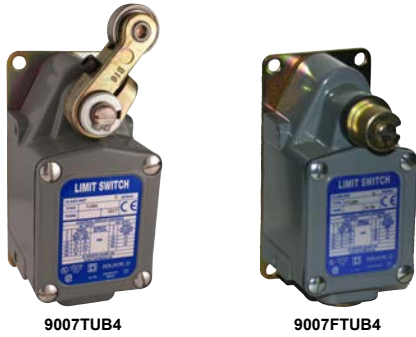

9007TUB4

9007FTUB4

Type of Arm	Length of Arm (in.)	Description	Roller Width	Type		
				Roller Dia. (in.)		
				3/4	1	1-3/8
Straight	1-1/2	Front or Back	1/4	B1	B2	B3
	1-1/2	Front or Back	1/2	B12	B13	B14
	2-1/2	Front or Back	1/4	B7	B8	B9
	2-1/2	Front or Back	1/2	B22	B23	B24
	2-7/8	None	None	Without Roller B21	—	—
	5	Front or Back	1/4	B19	—	—
	Adj.	Does not include a lever arm clamp or rod. Lever arm clamp is required—use 9007 R16 or R17, plus a customer-supplied rod.	1/4	R18	R19	R20
Offset	1-1/2	Inside Offset	1/4	C1	C2	C3
	1-1/2	Outside Offset	1/4	D1	D2	D3
	1-7/8	Outside Offset	1/4	E4	E5	E6
120° Forked	1-1/2	Inside Offset	1/4	F4	F5	F6
	1-1/2	Rollers on Same Side	1/4	J1	J2	—
	1-1/2	LH Roller on Opposite Side	1/4	K1	K2	—
90° Forked	1-1/2	RH Roller on Opposite Side	1/4	N1	N2	—
	1-1/2	Rollers on Same Side	1/4	X1	X2	—
	1-1/2	RH Roller on Opposite Side	1/4	Y1	Y2	—
Cable Operated	1-1/2	None	None	Y3		
	2-1/2	With eyebolt (1/4 in. I.D.) instead of roller	None	B27		
Rod	Adj.	Clamp for 3/16 in. Rod (rod not included)	None	R16		
	Adj.	Clamp for 1/4 in. Key Stock (key stock not included)	None	R17		
Weld-On	3-1/2	None	None	G10		
1-Way Roller	1-1/2	Outside Offset	1/4	D4		
Conveyor Side Guide	8-7/16	1-1/2 in. dia. 3-3/4 in. Delrin roller. For use with Type T and FT only.		R21		
		7/8 in. dia. 3-3/4 in. Delrin roller. For use with Type T, FT, or C with S9.		R22		

Table 21.82: Separate Base Plates

Style	Mounting Holes	Part Number
A	None <sup>[4]</sup>	2934D32G1
B	End	2934D14G1
C	Side	2934D33G1
D	End	2934D34G1

For all Type T and FT:  
Acceptable Wire Sizes: 14–18 AWG  
Recommended Terminal Clamp Torque: 13–16 lb-in

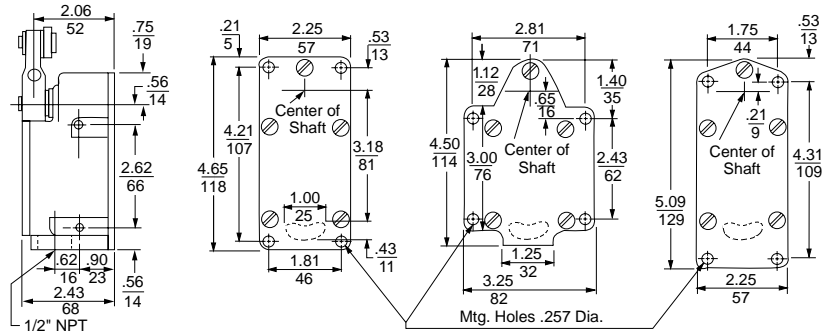

Style A Baseplate Shown

Style B

Style C

Style D

Dual Dimensions: INCHES  
Millimeters



File 78403  
CCN NKCR



File LR25490  
Class 3211 03



[4] No mounting holes in base plate. Side mounting holes in switch case must be used.





L300WS2M1

R.B.Denison™ LoX-Switch™ L

Table 21.83: General Specifications

Temperature range	0 to +200 °F (-17 to +93 °C) standard. For high and low temperature options, see page 21-45. Minimum temperatures are based on the absence of freezing moisture or water.
Enclosure rating	NEMA 1, 4, and 13; IP 65, 66
Vibration resistance	30G max. (10–55Hz)
Repeatability	0.03°
Cable entry	1/2" NPT standard double circuit, 3/4" NPT triple circuit
<b>Contact Characteristics</b>	
Rated thermal current	20 A
Rated insulation voltage	600 Vac and Vdc
Wire (max.)	1 x 12 AWG or 2 x 14 AWG per screw terminal

Table 21.84: Switching Ratings: A600 (AC), P600 (DC)

Contact Rating Designation (M=Make, B=Break)	Maximum current (A)												Maximum VA	
	120 V		125 V		240 V		250 V		480 V		< 600 V		M	B
A600 (AC)	60	6.00	—	—	30	3.00	—	—	15	1.50	12	1.20	7200	720
P600 (DC)	—	—	1.1	1.1	—	—	0.55	0.55	—	—	0.2	0.2	138	138

Mounting Plates, L100 and L300 Models

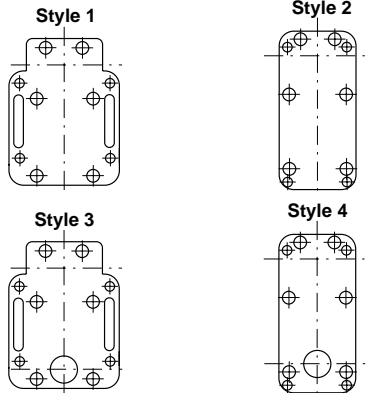

Table 21.85: Type L Selection

Select L100 for a standard (mill) switch and L300 for an extra heavy duty (foundry) switch

Description	Contact Diagram	Operating Torque	Cat. No.
Snap-action CW Spring return		190 oz-in (1.34 N·m)	L100WS2M1
		190 oz-in (1.34 N·m)	L300WS2M1
Snap-action CCW Spring return		190 oz-in (1.34 N·m)	L100WS2M2
		190 oz-in (1.34 N·m)	L300WS2M2
Maintained contact CW and CCW Snap action <sup>[5]</sup>		45 oz-in (0.32 N·m)	L100WS2M3
		45 oz-in (0.32 N·m)	L300WS2M3
Snap action CW Spring return		190 oz-in (1.34 N·m)	L100WDR2M4
		190 oz-in (1.34 N·m)	L300WDR2M4
Neutral position N.O.-CW, N.O.-CCW Spring return Snap action <sup>[5]</sup>		170 oz-in (1.2 N·m)	L100WNS2M26
		170 oz-in (1.2 N·m)	L300WNS2M26
Neutral position N.O.-CW, N.O.-CCW Maintained in CW only <sup>[5]</sup>		170 oz-in (1.2 N·m)	L100WNSL2M29
		170 oz-in (1.2 N·m)	L100WNSL2M29
2 Step Sequence CW Spring return, Snap action, 2 N.O.		150 oz-in (1.06 N·m)	L525WDR2M56
		150 oz-in (1.06 N·m)	L525WDR2M56
2 Step Sequence CCW Spring return, Snap action, 2 N.O.		150 oz-in (1.06 N·m)	L525WDL2M57
		150 oz-in (1.06 N·m)	L525WDL2M57
2 Step Sequence CW Spring return, Snap action, 2 N.C.		150 oz-in (1.06 N·m)	L525WDL2M58
		150 oz-in (1.06 N·m)	L525WDL2M58
2 Step Sequence CCW Spring return, Snap action, 2 N.C.		150 oz-in (1.06 N·m)	L525WDR2M59
		150 oz-in (1.06 N·m)	L525WDR2M59
2 Step Sequence CW Spring return Snap action N.O./N.C		150 oz-in (1.06 N·m)	L100WS0S2M60
		150 oz-in (1.06 N·m)	L100WS0S2M60

[5] The lever must not be allowed to snap freely from any overtravel position.

Interpreting the Catalog Numbers

Use the table below to interpret the catalog numbers of the L100/L300 switches. Do not generate new catalog numbers from the table. If the required contact sequence is not listed, contact your local field office.

The only modifications to the existing catalog numbers are:

- Mounting Plates—Style 1, 2, 3 or 4
- Front Covers—Metal, transparent plastic, or transparent plastic with a neon light.
- Special Features—Select from catalog 9006CT1007 and add to the type number.

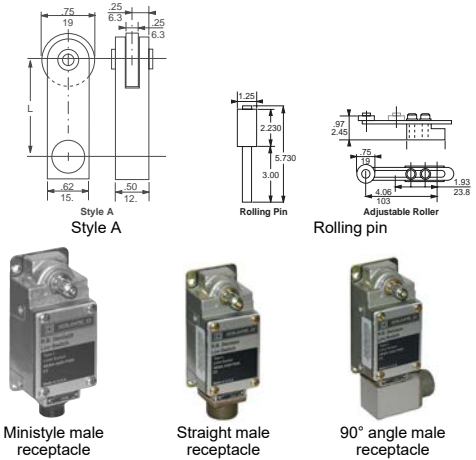

Style	Housing	Function	Mounting Plate	Front Cover	Contact Arrangement				
L	1	0	0	W	S	2	P	F	
Standard (mill)	100		1						See catalog 9006CT1007
Extra heavy duty (foundry)	300		2						
	Two circuit single operation	WS	3			M			Standard metal
	Two circuit dual operation	WD	4			PF			Transparent plastic
	Triple circuit	WT				GF			Transparent plastic with neon light
	Neutral	WN							

Table 21.86: Steel Roller Lever Arms (0.25 in. wide, 0.75 in. dia.)

Length (L)		Lever Number
in.	mm	
1.50	(38.1)	AA
2.00	(50.8)	AH
2.50	(63.5)	AO
2.75	(69.8)	AK
3.00	(76.2)	AB
4.00	(101.6)	AM
6.00	(152.4)	AR

Table 21.87: Lever Arm Options [6]

Description	Suffix
1 in. diameter roller	1
1-1/4 in. diameter roller	4
1-1/2 in. diameter roller	2
Nylon roller	N
Ball bearing roller (3/4 in. diameter)	R
Stainless steel roller pin nylon roller	NS
Ex: AB1; ABR	

Table 21.88: Rolling Pin

For use with 2 step switches for conveyor or belt applications

Length (L), In. (mm)	Lever Number
2.25 (75.1)	AL1650
2.25 (75.1) (Teflon for high temperature applications)	AL16501
3 (50.8)	AL1802

Table 21.89: Roller, Adjustable

from 2 to 4 in. (0.25 in. wide, 0.75 in. diameter)

Length (L), In. (mm)	Lever Number
Adjustable 2 to 4 (50.8 to 101.6)	AL2820

Table 21.90: Housing options [6]

Description	Examples	Prefix Adder or Modifier
3/4" conduit opening. Available on 2 circuit switches. Standard on 3 circuit switches.	L100WS2M1 changes to GL100WS2M1	G
High temperature 0 to +350 °F [7] Metal front cover only	L100WS2M1 changes to HL100WS2M1	H
Low temperature -20 to +200 °F [7]	L100WS2M1 changes to TL100WS2M1	T
High shock. Available only on operating sequences 1, 2, 4, 5, 7-11, 13, 14.	L100WS2M1 changes to L526WS2M1 L300WS2M1 changes to L326WS2M1	526/326
Gold contacts	L100WS2M1 changes to L522WS2M1 L300WS2M1 changes to L322WS2M1	522/322

Table 21.91: Wiring [6]

Description	Examples	Prefix Adder or Modifier
Straight male receptacle 4 pin [8]	Factory prewired L100WS2M1 changes to PL100WS2M1	P
90° Angle male receptacle 4 pin [8]	Factory prewired—facing right L100WS2M1 changes to APL100WS2M1	AP
Ministyle male receptacle [9]	8 A max., 5 pin (double circuit) 7 A max., 7 pin (triple circuit) L100WS2M1 changes to BL100WS2M1	B B
Potted and prewired	5 wires, 6 ft long 5 wires, 12 ft long 5 wires 18 ft long L100WS2M1 changes to L100WS2M1P L100WS2M1 changes to L100WS2M1P12 L100WS2M1 changes to L100WS2M1P18	P P12 P18

Table 21.92: Accessories

Description	Catalog Number
Sealed female plug and cable for P and AP receptacles	
4 pins, 16 AWG STO cable, 60 °C	4 ft 1010004 6 ft 1010006 10 ft 1010010
Sealed female plug and cable for ministyle receptacle (B)	
5 pins, 16 AWG STO cable, 105 °C	3 ft cable BH2053 6 ft cable BH2056 12 ft cable BH20512

Table 21.93: Front covers [6]

Description	Designator
Standard metal	M
Transparent plastic cover with metal frame	PF
Transparent plastic cover with metal frame and Neon indicator light (not connected)	GF

Example: L100WS2M1 changes to L100WS2PF1

[6] Some product configurations are not available—contact your Schneider Electric representative for details.  
 [7] The minimum temperatures listed are based on the absence of freezing moisture or water.  
 [8] Receptacle is a 4 pin male APL/PL-SWTS, Cannon part # MS3102E20-4P-F79 or equal.  
 [9] Ministyle male receptacles are: 5-pin, Brad Harrison #41310 (or equal); 7-pin, Brad Harrison #42805 (or equal)

# Section 22

## Pressure, Vacuum, and Float Switches



Electronic Pressure Sensors  
XMLG XMLK XMLR



9012G  
Industrial Pressure Switch



9012G Machine Tool  
Pressure Switch



XMLA Electromechanical  
Pressure Switch



9016G  
Vacuum Switch



9013F  
Water Pump Switch



9013G  
Air Compressor Switch



9036D  
Open Tank Float Switch



9037H  
Closed Tank Float Switch





<b>Pressure, Vacuum, and Float Switches</b>	<b>22-2</b>
Selection Guide	22-2
9012 Sensor Selections	22-2
9013, 9036, 9037, 9038 Sensor Selections	22-3
<b>Electronic Pressure Sensors</b>	<b>22-4</b>
XMLG Pressure Transmitters	22-4
XMLP Pressure Transmitters	22-6
Compact Metal Body, 316L Stainless Steel Fluid Entry, with Analog Output	22-6
XMEP Pressure Transmitters for Mobile Equipment	22-8
With Analog Output	22-8
XMLK Pressure Transmitters	22-9
XMLK Pressure Transmitters and Switches	22-10
XMLR Pressure Transmitters	22-11
<b>Pressure Switches</b>	<b>22-13</b>
XMLA, XMLB, XMLC, XMLD Industrial Pressure Switches	22-13
XMLA, XMLB, XMLC, XMLD Dimensions	22-15
Industrial, Type G	22-16
Machine Tool, Type G	22-17
<b>Pressure Switches and Vacuum Switches</b>	<b>22-19</b>
Class 9012 and 9016 Electrical Ratings and Dimensions	22-19
<b>Pressure Switches</b>	<b>22-20</b>
Class 9012G Dimensions	22-20
Machine Tool, Modifications, and Accessories	22-21
<b>Vacuum Switches</b>	<b>22-22</b>
Types GAW and GVG	22-22
<b>Commercial Pressure Switches</b>	<b>22-23</b>
Type FHG—Pumptrol™ Compressor Pressure Switch	22-23
Type F—Pumptrol™ Water Pump Pressure Switches	22-24
Type G—Pumptrol Pressure Switch	22-26
<b>Float Switches</b>	<b>22-28</b>
Open Tank, Types D and G	22-28
Open Tank, 9036FG, and Closed Tank, 9037E	22-29
Closed Tank, Type H	22-31
Mechanical Alternators, Types A and C	22-32
Mechanical Alternators, Closed Tank, Type D	22-33
<b>Accessories and Renewal Parts</b>	<b>22-34</b>
Kits for Class 9012–9038 Devices	22-34

9012 Sensor Selections

Application	Electronic					Electromechanical Control	
							
Product Family	XMLG	XMLP	XMEP	XMLK	XMLR	XMLE, B, C, D	9012G
Type of Installation/ Application	Control circuits	Control circuits	Control circuits for mobile equipment	Control circuits Pumping applications	Control circuits	Control circuits	Control circuits
Fluids Controlled	Air, water, hydraulic oils, corrosive fluids	Air, fresh water, most hydraulic oils	Hydraulic oils, air, fresh water, gas	Air, fresh water, 0 to +80 °C (32 to 176 °F)	Air, water, hydraulic oils, corrosive fluids		
Type of Operation and Features	Pressure/vacuum transmitters Analog output 4–20 mA or 0–10 V	Pressure/vacuum transmitters Analog output 4–20 mA, 0–10 V, 0.5–4.5 V ratiometric	Pressure transmitters Analog output 4–20 mA, 0–10 V, 0.5–4.5 V ratiometric	Pressure transmitters Analog output, 4–20 mA or 0–10 V	Pressure/vacuum switches and transmitters Configurable units with digital display Analog output 4–20 mA, 0–10 V Regulation between 2 trip points (adjustable differential)	Pressure/vacuum switches Detection of single trip point (nonadjustable differential) Regulation between 2 trip points (adjustable differential)	Pressure switches Detection of single trip point (nonadjustable differential) Regulation between 2 trip points (adjustable differential) 2-stage
Size/Range	–14.5 to 5800 psi	–14.5 to 6000 psi	0–870 psi, 0–1450 psi, 0–3625 psi, 0–5800 psi, 0–8700 psi	0 to 25 bar or 0 to 300 psi, depending on the model	–14.5 to 8700 psi	–14.5 to 7250 psi	0.2 to 9000 psi
Type of Output	Analog, 4–20 mA or 0–10 V	Analog, 4–20 mA, 0–10 V, 0.5–4.5 V	Analog, 4–20 mA, 0–10 V or 0.5–4.5 V	Analog, 4–20 mA or 0–10 V	Analog, 4–20 mA, 0–10 V Digital, PNP or NPN, 10 A continuous	Snap action contacts SPDT or DPDT 10 A continuous	Snap action contacts SPDT or DPDT 10 A continuous
Electrical Connection	M12 connector or integrated quick connection	M12, DIN 43650, Metri-Pack 150 connector, or 2 m PVC cable	M12 connector (4-pin), AMP Superseal 1.5 connector (3-pin), AMP Junior Power Timer connector (3-pin), Deutsch DT04-3P connector (3-pin)	M12, DIN 43650 A or Metri-Pack connector [1]	M12 connector SAE 7/8-16 UN2A	Cable entry for Pg 13 (DIN PG13.5) cable gland, ISO M20, 1/2" NPT, and 1/2" PF	1/2" -14 NPT Cable entry 20 mm
Fluid Connection	G 1/4" BSP internal, 1/4" NPT internal SAE 7/16"-20 UNF female	1/4 A male, 1/4"-18 NPT male, SAE 7/16-20 UNF-2A male, SAE 7/16-20 UNF-2B female	G 1/4 A DIN 3852-E male, 1/4"-18 NPT male	G 1/4 A (male) conforming to ISO7 or 1/4"-18 NPT male [1]	G 1/4" BSP internal, 1/4" NPT internal SAE 7/16"-20 UNF female	G 1/4" BSP internal, 1/4" NPT internal 1/4"-18 NPT external	1/4" - 18 NPTF internal 7/16"-20 UNF-2B internal G 1/4" BSP internal G 1/4"-19 BSP internal
Fluid Characteristics	Hydraulic oils, air, fresh water, sea water, corrosive fluids from –15 to +125 °C (+5 to +257 °F)	Fresh water (0 to +135 °C) Air, hydraulic oils, refrigeration fluids (–30 to +135 °C)	Hydraulic oils, air, fresh water, gas (–40 to +125 °C)	Air, fresh water, 0 to +80 °C (+32 to +176 °F)	Hydraulic oils, air, fresh water, sea water, corrosive fluids from –15 to +80 °C (+5 to +176 °F)	Hydraulic oils, air, fresh water, sea water, steam, corrosive fluids, viscous products, 0 to +160 °C (+32 to +320 °F) depending on the model	Hydraulic oils, air, fresh water, sea water, corrosive fluids from –26 to +120 °C (–15 to +250 °F) depending on the model
Enclosure Rating	IP66, IP67 conforming to IEC/EN 60529, NEMA 4	IP65 or IP67, IP69K (M12 connector), conforming to EN/IEC 60529	IP65, IP67, and IP69K conforming to EN/IEC 60529	IP65 conforming to IEC/EN60529, NEMA 4	IP67 conforming to IEC/EN 60529, NEMA 4/6/12/13	Screw terminal models: IP66 conforming to IEC 529, NEMA 4	NEMA Type 4, 4X, 7, 9, 13
Dimensions of Case, in. (mm) width x height x depth	dia. 0.90 x 2.76 (dia. 22.8 x 70.1 mm)	Ø 26 x 38 (M12) Ø 26 x 60.5 (DIN 43650) Ø 26 x 55 (Metri-Pack)	Ø 24 x 38.1, Ø 24 x 62.1, Ø 24 x 60.5, Ø 24 x 54, Ø 24 x 60	dia. 1.40 x 3.10 (dia. 36 x 79.5)	1.6 x 3.93 x 1.6 in. (41 x 100 x 42 mm)	4.45 x 1.38 x 2.95 in. (113 x 35 x 75 mm) NEMA 4: 3.50 x 3.60 x 2.63 in. (89 x 91 x 67 mm)	NEMA 1: 2.06 x 5.03 x 2.75 in. (52 x 128 x 70 mm) NEMA 4: 3.50 x 3.60 x 2.63 in. (89 x 91 x 67 mm)
Conforming to Standards	CE, IEC/EN 60947-1, IEC/EN 60947-5-1, EN 50081-1, EN 50082-2, EN 61000-6-2	CE, ROHS, EN/IEC 61326-2-3, NSF ANSI 61	CE, ROHS, EN/IEC 61326-2-3, ECE 10R-5, ISO 13766, ISO 14982, EN 13309	CE, IEC/EN 60947-1, IEC/EN 60947-5-1, EN 50081-1, EN 50082-2, EN 61000-6-2	CE, IEC/EN 60947-1, IEC/EN 60947-5-1, EN 50081, EN 50082, EN 61000-6-2, EN 61000-4-2/3/4/5/6/8/11	CE, IEC/EN 60947-5-1, VDE 0660-200, UL 508, CSA C22-2 No. 14	NEMA A600 UL508
Certifications	UL Listed, CSA Certified	cULus conforming to UL 61010-1 and CSA-C22.2 no. 61010-1, EAC, RCM	cULus conforming to UL 61010-1, E2 conforming to UNECE 10R-5 (pending)	UL: File E97729, CCN NKPZ CSA: File 240515, Class 3211-03	UL Listed, CSA Certified	UL B300 - R300 Listed, CSA B300 - R300, (BV, GL, RINA, LROS pending)	UL Listed, CSA Certified
Catalog Number	XMLG	XMLP	XMEP	XMLK	XMLR	XMLE, XMLB, XMLE, XMLD	9012GA, GB, GC, GD, GE, GF, GG, GH, GJ, GK, GL, GM, GN, GP, GQ, GR, GS, GT

[1] For other connections, consult the Sensor Competency Center.

**9013, 9036, 9037, 9038 Sensor Selections**

Application	Electromechanical Control	Electromechanical Pressure Switches	Electromechanical Float Switches	Electromechanical Float Switches	Electromechanical Float Switches	Electromechanical Float Switches	Electromechanical Float Switches
							
<b>Product Family</b>	9016G	9013F	9013G	9036D, 9036F	9036G	9037	9038
<b>Type of Installation/ Application</b>	Control/power circuits	Power circuits	Power circuits	Power circuits	Power circuits	Power circuits	Power circuits
<b>Fluids Controlled</b>	Air, water, hydraulic oils, corrosive fluids	Fresh water, air		Fresh or sea water, hydraulic oils; suitable for corrosive fluids except for cast iron bushing (shown above)			
<b>Type of Operation and Features</b>	Vacuum switches Regulation between 2 trip points (adjustable differential)	Pressure switches Detection of single trip point (fixed differential) Regulation between 2 trip points (adjustable differential)	Pressure switches Regulation between 2 trip points (adjustable differential)	Liquid level control in <b>Open</b> tanks—either pumping in or pumping out of tank	Liquid level control in <b>Open</b> tanks—either pumping in or pumping out of tank	Liquid level control in <b>Closed</b> tanks for condensate, return heating water, fuel oil, etc.	Liquid level control in <b>Open</b> or <b>Closed</b> tanks—two pumps alternate, and both pumps run in peak demand Non-alternating option also available
<b>Size/Range (psi)</b>	0 to 29 in. of Hg	6 to 200 psi	10 to 250 psi	Light duty	Medium duty	—	—
<b>Type of Output</b>	Snap action contacts SPDT 10 A continuous DPST horsepower rated	1-pole or 2-pole, snap action contacts HP rated	2-pole, snap action contacts HP rated	2-pole, snap action contacts HP rated	2-pole, snap action contacts HP rated	2-pole, snap action contacts HP rated	2 sets of 2-pole, snap action contacts HP rated
<b>Electrical Connection</b>	<b>9016G:</b> 1/2" -14 NPT Cable entry 20 mm 9016GVG <b>NEMA Type 1 and 3R:</b> 3 knockouts for 1/2 in. conduit <b>NEMA Type 7 and 9:</b> 2 conduit entries, 3/4"-14 NPT	2 open side entries, 0.88 in. diameter, with two flats, 0.84 in. (21.3 mm) across flat	<b>NEMA Type 1 and 3R:</b> 3 knockouts for 1/2 in. conduit <b>NEMA Type 7 and 9:</b> 2 conduit entries, 3/4"-14 NPT	4 screw terminals <b>NEMA Type 1:</b> 2 open side entries, 0.88 in. diameter, with two flats, 0.84 in. (21.3 mm) across <b>NEMA Type 4, 7, 9:</b> 2 cable entries, 3/4-14 conduit entry <b>9036FG:</b> 2 cable entries, 0.88 in. (22.4 mm) with 0.84 in. (21.3 mm) across flat	4 screw terminals <b>NEMA Type 1:</b> 3 knockouts for 1/2 in. conduit entry <b>NEMA Type 4, 7, 9:</b> 2 cable entries, 3/4-14 conduit entry	4 screw terminals <b>NEMA Type 1:</b> 2 open side entries, 0.88 in. diameter, with two flats, 0.84 in. (21.3 mm) across <b>NEMA Type 4, 7, 9:</b> 2 cable entries, 3/4-14 conduit entry	8 screw terminals <b>NEMA Type 1:</b> 8 knockouts for 1/2 or 3/4 in. conduit entry <b>NEMA Type 4, 7, 9:</b> 2 cable entries, 3/4-14 conduit entry
<b>Fluid Connection</b>	G 1/4" BSP internal, 1/4" NPT internal 1/4"-18 NPT external	1/4" NPSF internal, 1/4" NPT external, plus other options	1/4" NPSF internal, 1/4" NPT external	Open tank	Open tank	Closed tank	Open tank (9038A) Closed tank (9038C, D)
<b>Fluid Characteristics</b>	Hydraulic oils, air, fresh water, sea water, from -26 to +120 °C (-15 to +250 °F) depending on the model	Fresh water, air		Fresh water, sea water, hydraulic oils (and corrosive fluids, depending on the model) with a density ≥ 0.8			
<b>Enclosure Rating</b>	<b>9016G:</b> NEMA Type 4, 4X, 7, 9, 13 <b>9016GVG:</b> NEMA Type 1	NEMA Type 1 NEMA Type 3R IP20	NEMA Type 1, 3R, 7, 9 IP20	NEMA Type 1, 4, 7, 9	NEMA Type 1, 4, 7, 9	NEMA Type 1, 4, 7, 9	NEMA Type 1, 4, 7, 9
<b>Dimensions of Case width x height x depth in. (mm)</b>	Control circuit: same as 9012G Power circuit: same as 9013G	3.76 x 2.8 x 2.78 in. (95.5 x 71.12 x 70.6 mm)	3.68 x 3.85 x 3.44 in. (93.47 x 97.79 x 87.37 mm)	See page 22-28	See page 22-28	See page 22-30–page 22-31	See page 22-32
<b>Conforming to Standards</b>	NEMA A600 UL508	NEMA A600 UL508	NEMA A600 UL508	NEMA A600 UL508	NEMA A600 UL508	NEMA A600 UL508	NEMA A600 UL508
<b>Certifications</b>	UL Listed, CSA Certified	UL Listed, CSA Certified	UL Listed, CSA Certified	UL Listed, CSA Certified	UL Listed, CSA Certified	UL Listed, CSA Certified	UL Listed, CSA Certified
<b>Catalog Number</b>	9016GA, 9016GV	9013FS, 9013FR, 9013FH, 9013FT, 9013FY	9013GS, 9013GH, 9013GM	9036DG, 9036DW, 9036DR, 9036FG	9036GG, 9036GW, 9036GR	9037EG, 9037EW, 9037ER, 9037HG, 9037HW, 9037HR	9038AG, 9038AW, 9038AR, 9038CG, 9038CW, 9038CR, 9038DG, 9038DW, 9038DR



XMLG...D  
M12 Connector

XMLG...Q  
Quick Connect

**XMLG Pressure Transmitters**

XMLG pressure transmitters are characterized by their ceramic pressure-measuring cell. The deformation caused by the pressure is transmitted to the resistors of a Wheatstone bridge silk-screened on the ceramic. The change in resistance is then processed by the integrated electronics, providing an analog output signal.

**Table 22.1: Specifications**

Enclosure Rating	IP66, IP67 conforming to IEC/EN 60529, NEMA 4
Ambient Temperature (Operation)	-15 to +85 °C (+5 to +185 °F)
Media Temperature	-15 to +125 °C (+5 to +257 °F)
Precision (Linearity, Repeat Accuracy, Hysteresis)	Transmitters: <0.3%
Repeat Accuracy (PNP/NPN output)	0.1% of the measuring range
Current Consumption	Transmitters: < 20 mA
Maximum Load Current	Transmitters: < 20mA
Rated Voltage	12/24 V for transmitters
Voltage Limits	24 V for transmitters
Fluids Controlled	Hydraulic oils, air, fresh/sea water, corrosive fluids from -15 to +125 °C (+5 to +257 °F)
Materials in Contact with Fluid	Ceramic Al <sub>2</sub> O <sub>3</sub> , stainless steel type AISI 303, Viton® FPM, PPS (leakage protection for P> 40 bar)
Output Response Time	< 2 ms

**Table 22.2: Interpretation of the Catalog Number (example: XMLG100D23TQ)**

XMLG	100	D	2	3	TQ		
Units without Display, 22.8 mm diameter	Rated Pressure Range		Electrical Connection	Output	Fluid Connection	Bulk Pack	
	Code	psi	bar				
	M01	-14.5 to 0	-1 to 0	D: M12	1: DC Analog, 4–20 mA, shunt calibration	1: G 1/4 A (BSP male)	
	001	0 to 14.5	0 to 1	Q: Integrated quick connect	2: Analog, 4–20 mA	3: 1/4" NPT male	
	006	0 to 87.0	0 to 6		7: Analog, 0–10 V (bulk packs only)	7: 7/16-20 UNF male	
	010	0 to 145	0 to 10		11: DC Analog, 0–10 V shunt calibration		
	016	0 to 232.1	0 to 16				
	025	0 to 362.5	0 to 25				
	100	0 to 1450	0 to 100				
	160	0 to 2329.6	0 to 160				
	250	0 to 3625	0 to 250				
	400	0 to 5800	0 to 400				

**NOTE:** Use this table only to interpret the catalog number. Some combinations are not available.

**Table 22.3: Selection**

Rated Pressure Range		Fluid Connection	Electrical Connection	Catalog Number <sup>[1][2]</sup>	
				Analog Output, 4–20 mA	Analog Output, 0–10 Vdc
-14.5 to 0 psi	-1 to 0 bar	1/4" NPT Male	M12	XMLGM01D23	XMLGM01D73
0 to 14.5 psi	0 to 1 bar			XMLG001D23	XMLG001D73
0 to 87 psi	0 to 6 bar			XMLG006D23	XMLG006D73
0 to 145 psi	0 to 10 bar			XMLG010D23	XMLG010D73
0 to 232 psi	0 to 16 bar			XMLG016D23	XMLG016D73
0 to 362.5 psi	0 to 25 bar			XMLG025D23	XMLG025D73
0 to 1450 psi	0 to 100 bar			XMLG100D23	XMLG100D73
0 to 2320 psi	0 to 160 bar			XMLG160D23	XMLG160D73
0 to 3625 psi	0 to 250 bar			XMLG250D23	XMLG250D73
0 to 5800 psi	0 to 400 bar			XMLG400D23	XMLG400D73

**NOTE:** For units with a solid-state output, the settings must be specified for each order.

**Table 22.4: Wiring Configurations (M12)**

Output	Pin 1	Pin 3	Pin 4
Analog, 4–20 mA	+ Power supply	Output	—
Analog, 0–10 Vdc	+ Power supply	Output	Ground
Solid State, NPN	+ Power supply	Ground	Output
Solid State, PNP	+ Power supply	Ground	Output



UL E164865  
CCN NKPZ



LR 44087  
Class 3211-03



For wiring diagrams, refer to page 22-5.

[1] For devices with a switch output or 0–10 Vdc analog output, contact the Sensor Competency Center at 1-800-435-2121.

[2] For a bulk package (25 units), add TQ to the end of the catalog number. The minimum order quantity is 50 units (two bulk packs). When ordering, specify the individual number of units, NOT the number of bulk packs. Minimum order quantity for factory ordered individual items (non-stock) is 50 pieces.

**XMLG Pressure Transmitters and Switches**

For connectors and cables, see page 22-12.

Dimension A	
XMLG***D2**1	G 1/4 A (BSAP Male)
XMLG***D2**3	1/4" NPT Male
XMLG***D2**7	7/16-20 UNF Male

**Table 22.5: Dimensions, in. (mm)**  
XMLG\*\*\*D\*\*\*, M12 x 1 Connection

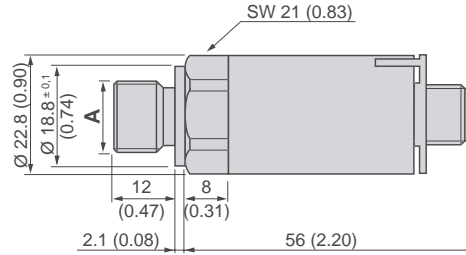

XMLG\*\*\*Q\*\*\*, Integrated Quick Connection

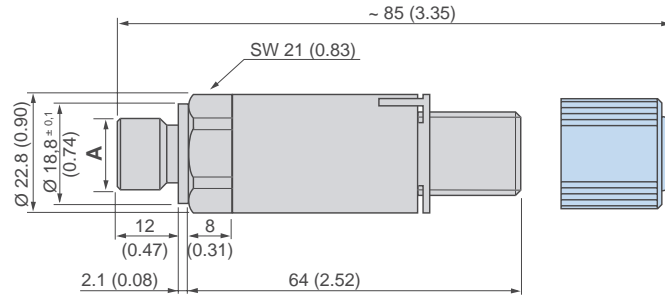

**Table 22.6: Connector Wiring**

Pressure Transmitters		Electronic Pressure Switches	
M12	Integrated Quick Connection	M12	Integrated Quick Connection
2-wire (4–20 mA)	2-wire (4–20 mA)	3-wire (PNP)	3-wire (PNP)
<p><b>3-wire (0–10 V)</b></p>	<p><b>3-wire (0–10 V)</b></p>	<p><b>3-wire (NPN)</b></p>	<p><b>3-wire (NPN)</b></p>

For wiring configurations, refer to page 22-5.

**Compact Metal Body, 316L Stainless Steel Fluid Entry, with Analog Output**  
Fluid Connection: 1/4"-18 NPT (male)



**Table 22.7: -14.5 to 0 psi (-1 to 0 bar)**

Maximum permissible accidental pressure: 44 psi, destruction pressure: 73 psi			
Analog output type	Electrical connection	Catalog Number	Weight, kg (lb)
4-20 mA	M12	XMLPM00RD23F [3]	0.078 (0.172)
	EN 175301-803-A	XMLPM00RC23F	0.094 (0.207)
	Packard Metri-Pack 150	XMLPM00RP23F	0.080 (0.176)
0-10 V	M12	XMLPM00RD73F [3]	0.078 (0.172)
	EN 175301-803-A	XMLPM00RC73F	0.094 (0.207)
	Packard Metri-Pack 150	XMLPM00RP73F	0.080 (0.176)
0.5-4.5 V ratiometric	M12	XMLPM00RD13F	0.078 (0.172)
	EN 175301-803-A	XMLPM00RC13F	0.094 (0.207)
	Packard Metri-Pack 150	XMLPM00RP13F	0.080 (0.176)

**Table 22.8: -14.5 to 15 psi (-1 to 1.03 bar)**

Maximum permissible accidental pressure: 44 psi, destruction pressure: 73 psi			
Analog output type	Electrical connection	Catalog Number	Weight, kg (lb)
4-20 mA	M12	XMLPM15RD23F [3]	0.078 (0.172)
	EN 175301-803-A	XMLPM15RC23F	0.094 (0.207)
	Packard Metri-Pack 150	XMLPM15RP23F [3]	0.080 (0.176)
0-10 V	M12	XMLPM15RD73F [3]	0.078 (0.172)

**Table 22.9: -14.5 to 60 psi (-1 to 4.14 bar)**

Maximum permissible accidental pressure: 260 psi, destruction pressure: 350 psi			
Analog output type	Electrical connection	Catalog Number	Weight, kg (lb)
4-20 mA	M12	XMLPM60RD23F [3]	0.078 (0.172)
	EN 175301-803-A	XMLPM60RC23F	0.094 (0.207)
	Packard Metri-Pack 150	XMLPM60RP23F	0.080 (0.176)
0-10 V	M12	XMLPM60RD73F [3]	0.078 (0.172)

**Table 22.10: 0 to 15 psi (0 to 1.03 bar)**

Maximum permissible accidental pressure: 44 psi, destruction pressure: 73 psi			
Analog output type	Electrical connection	Catalog Number	Weight, kg (lb)
4-20 mA	M12	XMLP015RD23F [4]	0.078 (0.172)
	EN 175301-803-A	XMLP015RC23F	0.094 (0.207)
	Packard Metri-Pack 150	XMLP015RP23F	0.080 (0.176)
0-10 V	M12	XMLP015RD73F [4]	0.078 (0.172)
	EN 175301-803-A	XMLP015RC73F	0.094 (0.207)
	Packard Metri-Pack 150	XMLP015RP73F	0.080 (0.176)

**Table 22.11: 0 to 30 psi (0 to 2.07 bar)**

Maximum permissible accidental pressure: 109 psi, destruction pressure: 145 psi			
Analog output type	Electrical connection	Catalog Number	Weight, kg (lb)
4-20 mA	M12	XMLP030RD23F [4]	0.078 (0.172)
	EN 175301-803-A	XMLP030RC23F	0.094 (0.207)
	Packard Metri-Pack 150	XMLP030RP23F	0.080 (0.176)
0-10 V	M12	XMLP030RD73F [4]	0.078 (0.172)
	EN 175301-803-A	XMLP030RC73F	0.094 (0.207)
	Packard Metri-Pack 150	XMLP030RP73F	0.080 (0.176)

**Table 22.12: 0 to 50 psi (0 to 3.45 bar)**

Maximum permissible accidental pressure: 174 psi, destruction pressure: 232 psi			
Analog output type	Electrical connection	Catalog Number	Weight, kg (lb)
4-20 mA	M12	XMLP050RD23F [4]	0.078 (0.172)
	EN 175301-803-A	XMLP050RC23F	0.094 (0.207)
	Packard Metri-Pack 150	XMLP050RP23F	0.080 (0.176)
0-10 V	M12	XMLP050RD73F [4]	0.078 (0.172)

**Table 22.13: 0 to 100 psi (0 to 6.9 bar)**

Maximum permissible accidental pressure: 260 psi, destruction pressure: 340 psi			
Analog output type	Electrical connection	Catalog Number	Weight, kg (lb)
4-20 mA	M12	XMLP100RD23F	0.078 (0.172)
0-10 V	M12	XMLP100RD73F	0.078 (0.172)
Maximum permissible accidental pressure: 300 psi, destruction pressure: 900 psi			
4-20 mA	M12	XMLP100PD230 [5]	0.088 (0.194)
	Packard Metri-Pack 150	XMLP100PD230 [5]	0.090 (0.198)
0-10 V	M12	XMLP100PD730	0.088 (0.194)
	Packard Metri-Pack 150	XMLP100PP730	0.090 (0.198)
0.5-4.5 V ratiometric	M12	XMLP100PD130	0.088 (0.194)
	Packard Metri-Pack 150	XMLP100PP130	0.090 (0.198)

[3] Available in lots of 25—add Q to the end of the selected catalog number. For example, XMLPM00RD23F becomes XMLPM00RD23FQ.  
 [4] Available in lots of 25—add Q to the end of the selected catalog number. For example, XMLP030RD73F becomes XMLP030RD73FQ.  
 [5] Available in lots of 25—add Q to the end of the selected catalog number. For example, XMLP100PD230 becomes XMLP100PD230Q.





XMLP•0PD•30



XMLP•0PP•30



XMLP•K0PD•30



XMLP•K0PP•30

**Table 22.14: 0 to 150 psi (0 to 10.3 bar)**

Maximum permissible accidental pressure: 450 psi, destruction pressure: 900 psi			
Analog output type	Electrical connection	Catalog Number	Weight, kg (lb)
4–20 mA	M12	XMLP150PD230 [6]	0.088 (0.194)
	Packard Metri-Pack 150	XMLP150PP230	0.090 (0.198)
0–10 V	M12	XMLP150PD730	0.088 (0.194)
	Packard Metri-Pack 150	XMLP150PP730	0.090 (0.198)
0.5–4.5 V ratiometric	M12	XMLP150PD130	0.088 (0.194)

**Table 22.15: 0 to 200 psi (0 to 13.8 bar)**

Maximum permissible accidental pressure: 600 psi, destruction pressure: 1400 psi			
Analog output type	Electrical connection	Catalog Number	Weight, kg (lb)
4–20 mA	M12	XMLP200PD230 [6]	0.088 (0.194)
	Packard Metri-Pack 150	XMLP200PP230	0.090 (0.198)
0–10 V	M12	XMLP200PD730	0.088 (0.194)
	Packard Metri-Pack 150	XMLP200PP730	0.090 (0.198)
0.5–4.5 V ratiometric	M12	XMLP200PD130	0.088 (0.194)

**Table 22.16: 0 to 300 psi (0 to 20.7 bar)**

Maximum permissible accidental pressure: 900 psi, destruction pressure: 2200 psi			
Analog output type	Electrical connection	Catalog Number	Weight, kg (lb)
4–20 mA	M12	XMLP300PD230 [7]	0.088 (0.194)
	Packard Metri-Pack 150	XMLP300PP230	0.090 (0.198)
0–10 V	M12	XMLP300PD730	0.088 (0.194)
	Packard Metri-Pack 150	XMLP300PP730	0.090 (0.198)
0.5–4.5 V ratiometric	M12	XMLP300PD130	0.088 (0.194)
	Packard Metri-Pack 150	XMLP300PP130	0.090 (0.198)

**Table 22.17: 0 to 600 psi (0 to 41.4 bar)**

Maximum permissible accidental pressure: 1800 psi, destruction pressure: 3600 psi			
Analog output type	Electrical connection	Catalog Number	Weight, kg (lb)
4–20 mA	M12	XMLP600PD230	0.088 (0.194)
	Packard Metri-Pack 150	XMLP600PP230 [7]	0.090 (0.198)
0–10 V	M12	XMLP600PD730	0.088 (0.194)
	Packard Metri-Pack 150	XMLP600PP730	0.090 (0.198)
0.5–4.5 V ratiometric	M12	XMLP600PD130	0.088 (0.194)
	Packard Metri-Pack 150	XMLP600PP130	0.090 (0.198)

**Table 22.18: 0 to 1000 psi (0 to 69 bar)**

Maximum permissible accidental pressure: 3000 psi, destruction pressure: 6000 psi			
Analog output type	Electrical connection	Catalog Number	Weight, kg (lb)
4–20 mA	M12	XMLP1K0PD230	0.088 (0.194)
	Packard Metri-Pack 150	XMLP1K0PP230	0.090 (0.198)
0–10 V	M12	XMLP1K0PD730	0.088 (0.19)
	Packard Metri-Pack 150	XMLP1K0PP730	0.090 (0.198)
0.5–4.5 V ratiometric	M12	XMLP1K0PD130	0.088 (0.194)

**Table 22.19: 0 to 2000 psi (0 to 138 bar)**

Maximum permissible accidental pressure: 6000 psi, destruction pressure: 12,000 psi			
Analog output type	Electrical connection	Catalog Number	Weight, kg (lb)
4–20 mA	M12	XMLP2K0PD230	0.092 (0.203)
0–10 V	M12	XMLP2K0PD730	0.092 (0.203)
0.5–4.5 V ratiometric	M12	XMLP2K0PD130	0.092 (0.203)

**Table 22.20: 0 to 3000 psi (0 to 207 bar)**

Maximum permissible accidental pressure: 9000 psi, destruction pressure: 18,000 psi			
Analog output type	Electrical connection	Catalog Number	Weight, kg (lb)
4–20 mA	M12	XMLP3K0PD230	0.092 (0.203)
	Packard Metri-Pack 150	XMLP3K0PP230	0.094 (0.207)
0–10 V	M12	XMLP3K0PD730 [8]	0.092 (0.203)
	Packard Metri-Pack 150	XMLP3K0PP730	0.094 (0.207)
0.5–4.5 V ratiometric	M12	XMLP3K0PD130	0.092 (0.203)

**Table 22.21: 0 to 6000 psi (0 to 414 bar)**

Maximum permissible accidental pressure: 18,000 psi, destruction pressure: 36,000 psi			
Analog output type	Electrical connection	Catalog Number	Weight, kg (lb)
4–20 mA	M12	XMLP6K0PD230	0.092 (0.203)
0–10 V	M12	XMLP6K0PD730	0.092 (0.203)
	Packard Metri-Pack 150	XMLP6K0PP730	0.094 (0.207)
0.5–4.5 V ratiometric	M12	XMLP6K0PD130	0.092 (0.203)
	Packard Metri-Pack 150	XMLP6K0PP130 [8]	0.094 (0.207)

[6] Available in lots of 25—add **Q** to the end of the selected catalog number. For example, XMLP100PD230 becomes XMLP100PD230Q.  
 [7] Available in lots of 25—add **Q** to the end of the selected catalog number. For example, XMLP600PP230 becomes XMLP600PP230Q.  
 [8] Available in lots of 25—add **Q** to the end of the selected catalog number. For example, XMLP6K0PP130 becomes XMLP6K0PP130Q.

**With Analog Output**

Fluid Connection: 1/4"-18 NPT (male)

**Table 22.22: 0 to 1000 psi (0 to 69 bar)**

Maximum permissible accidental pressure: 2200 psi, destruction pressure: 4400 psi			
Analog output type	Electrical connection	Catalog Number	Weight, kg (lb)
4–20 mA	Deutsch DT04-3P	XMEP1K0PT230	0.098 (0.22)
0–10 V	Deutsch DT04-3P	XMEP1K0PT730	0.098 (0.22)
0.5–4.5 V ratiometric	Deutsch DT04-3P	XMEP1K0PT130	0.098 (0.22)

**Table 22.23: 0 to 3000 psi (0 to 207 bar)**

Maximum permissible accidental pressure: 9000 psi, destruction pressure: 18,000 psi			
Analog output type	Electrical connection	Catalog Number	Weight, kg (lb)
4–20 mA	Deutsch DT04-3P	XMEP3K0PT230	0.098 (0.22)
0–10 V	Deutsch DT04-3P	XMEP3K0PT730	0.098 (0.22)
0.5–4.5 V ratiometric	Deutsch DT04-3P	XMEP3K0PT130	0.098 (0.22)

**Table 22.24: 0 to 5000 psi (0 to 345 bar)**

Maximum permissible accidental pressure: 15,000 psi, destruction pressure: 30,000 psi			
Analog output type	Electrical connection	Catalog Number	Weight, kg (lb)
4–20 mA	Deutsch DT04-3P	XMEP5K0PT230	0.098 (0.22)
0–10 V	Deutsch DT04-3P	XMEP5K0PT730	0.098 (0.22)
0.5–4.5 V ratiometric	Deutsch DT04-3P	XMEP5K0PT130	0.098 (0.22)

**Table 22.25: 0 to 7500 psi (0 to 517 bar)**

Maximum permissible accidental pressure: 18,750 psi, destruction pressure: 30,000 psi			
Analog output type	Electrical connection	Catalog Number	Weight, kg (lb)
4–20 mA	Deutsch DT04-3P	XMEP7K5PT230	0.098 (0.22)
0–10 V	Deutsch DT04-3P	XMEP7K5PT730	0.098 (0.22)
0.5–4.5 V ratiometric	Deutsch DT04-3P	XMEP7K5PT130	0.098 (0.22)

### XMLK Pressure Transmitters

Type XMLK pressure transmitters are characterized by their ceramic pressure-measuring cell. The deformation caused by the pressure is transmitted to the resistors of a Wheatstone bridge silk-screened on the ceramic. The change in resistance is then processed by the integrated electronics to provide an analog output signal.



**Table 22.26: Environmental Specifications**

<b>Enclosure Rating</b>	IP65 conforming to IEC/EN 60529, NEMA 4
<b>Ambient Air Temperature</b>	<b>For Operation</b> 0 to +80 °C (32 to 176 °F) <b>For Storage</b> -25 to +85 °C (13 to 185 °F)
<b>Precision (Resolution)</b>	Combined sum of linearity, hysteresis, and repeat accuracy <math>\leq \pm 0.5\%</math> of the measuring range Setting tolerance of zero point and measuring range limit <math>< \pm 1\%</math> of the measuring range
<b>Repeat Accuracy</b>	$\pm 0.3\%$ of the measuring range
<b>Current Consumption</b>	4–20 mA: <math>< 20\text{ mA}</math> 0–10 V: <math>< 6\text{ mA}</math>
<b>Rated Supply Voltage</b>	24 Vdc
<b>Voltage Limits</b>	4–20 mA: 8–33 Vdc 0–10 V: 16.2–33 Vdc
<b>Fluids or Products Controlled</b>	Air, fresh water (0 to +80 °C / 32 to 176 °F)
<b>Materials in Contact with Fluid</b>	Steel, type AISI 303 (stainless steel) nitrile (NBR)
<b>Output Response Time</b>	<math>< 2\text{ ms}</math>

**Table 22.27: Interpretation of the Catalog Number**

Units Without Display	Rated Pressure			Unit of Pressure	O-Ring	Electrical Connection	Output	Fluid Connection	Bulk Pack
	Code	psi	bar						
<b>XMLK</b>	<b>100</b>			<b>P</b>	<b>2</b>	<b>D</b>	<b>2</b>	<b>3</b>	<b>TQ</b>
36 mm (1.42 in.) diameter	006		0–6	B: bar	2: NBR (Nitrile)	C: DIN 43650A	2: Analog, 4–20 mA 7: Analog, 0–10 V	1: G 1/4 A (male) 3: 1/4"-18 NPT (male)	
	010		0–10	P: psi		D: M12			
	016		0–16			P: Metri-Pack			
	025		0–25						
	100	0–100							
	150	0–150							
	200	0–200							
	300	0–300							

**NOTE:** Use this table only to interpret the catalog number. Some combinations are not available.

**Table 22.28: Selection**

Rated Pressure Range	Catalog Number [9]					
	4–20 mA Analog Output			0–10 Vdc Analog Output		
	DIN	M12	Metri-Pack	DIN	M12	Metri-Pack
<b>Bar Version, G 1/4 A Male Fluid Connector</b>						
0–6 bar (0–87 psi)	XMLK006B2C21	XMLK006B2D21	—	XMLK006B2C71	XMLK006B2D71	—
0–10 bar (0–145 psi)	XMLK010B2C21	XMLK010B2D21	—	XMLK010B2C71	XMLK010B2D71	—
0–16 bar (0–232 psi)	XMLK016B2C21	XMLK016B2D21	—	XMLK016B2C71	XMLK016B2D71	—
0–25 bar (0–362.5 psi)	XMLK025B2C21	XMLK025B2D21	—	XMLK025B2C71	XMLK025B2D71	—
<b>PSI Version, 1/4"-18 NPT Male Fluid Connector</b>						
0–100 psi (0–6.9 bar)	XMLK100P2C23	XMLK100P2D23	XMLK100P2P23	XMLK100P2C73	XMLK100P2D73	XMLK100P2P73
0–150 psi (0–10.3 bar)	XMLK150P2C23	XMLK150P2D23	XMLK150P2P23	XMLK150P2C73	XMLK150P2D73	XMLK150P2P73
0–200 psi (0–13.8 bar)	XMLK200P2C23	XMLK200P2D23	XMLK200P2P23	XMLK200P2C73	XMLK200P2D73	XMLK200P2P73
0–300 psi (0–20.7 bar)	XMLK300P2C23	XMLK300P2D23	XMLK300P2P23	XMLK300P2C73	XMLK300P2D73	XMLK300P2P73

**Table 22.29: Wiring Configurations (M12)**

Output	Pin 1	Pin 3	Pin 4
Analog, 4–20 mA	+ Power supply	Output	—
Analog, 0–10 Vdc	+ Power supply	Output	Ground
Solid State, NPN	+ Power supply	Ground	Output
Solid State, PNP	+ Power supply	Ground	Output

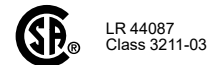

For wiring diagrams, refer to page 22-5.

[9] For a bulk package (25 units), add TQ to the end of the catalog number. The minimum order quantity is 50 units (two bulk packs). When ordering, specify the individual number of units, not the number of bulk packs. Minimum order quantity for factory ordered individual items (non-stock) is 50 pieces.

**XMLK Dimensions**

For connectors and cables, see [XMLF Accessories](#), [Wiring Configurations](#), and [Electrical Connections](#), page 22-12.

**Table 22.30: Dimensions**

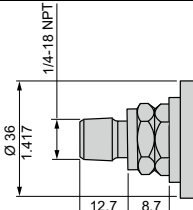
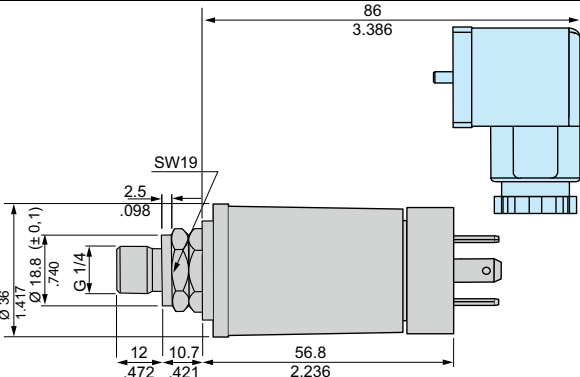
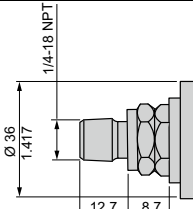
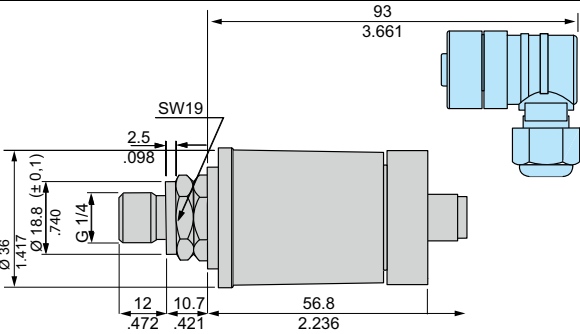
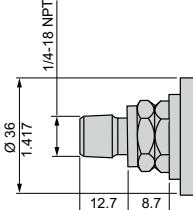
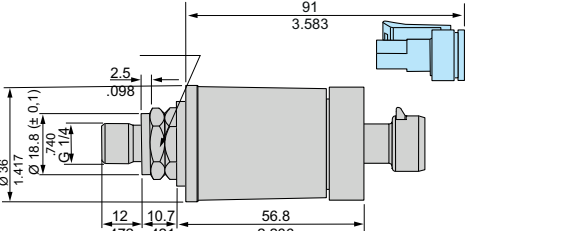
XMLK, DIN connector	
NPT	G 1/4 A (male)
 <p>Dimensions = mm / in.</p>	
XMLK, M12 connector	
NPT	G 1/4 A (male)
	
XMLK, Metri-Pack connector	
NPT	G 1/4 A (male)
	

**Table 22.31: Connector Wiring**

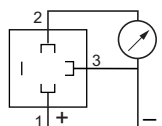
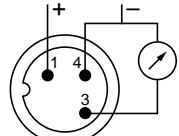
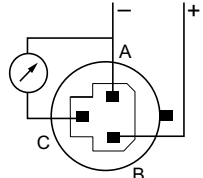
DIN 43650A	M12	Metri-Pack
		



**XMLR and ZMLP Pressure Switches**

XMLR and ZMLP are user-friendly electronic pressure switches with an easy-to-read four digit display and finger-operated adjustment buttons for scrolling up and down through the menu functions. Burst pressure is six times the nominal pressure (up to 1,800 bar or 26,100 psi).

**Configurable functions:**  
**Display**

- Pressure unit of measurement ( bar, psi, kPa, or MPa).
- Display refresh time: fast (50 ms), normal (200 ms), slow (600 ms).
- 180° reversed display function.

**Analog output (4–20 mA or 0–10 V):**

- Offset compensation in the range of ±5% of the nominal pressure.
- Adjustment of analog end point between 75 and 125% of the nominal pressure.

**Solid-state output**

- NO or NC contact.
- Switching mode of outputs: Hysteresis (pumping) or Window (control).
- Time delay both on trip and on reset (adjustable from 0 to 50 s, in steps of 1 s).

**Diagnostic functions**

- Illumination of all the segments of the display on each power-up, enabling checking of their operation.
- Diagnostic function for checking correct operation of the sensor.
- Saving of min. and max. pressures measured by the sensor and their subsequent display.

Outputs change state when the pressure ranges outside the window settings.

**Table 22.32: Interpretation of the Catalog Number (example: XMLRM01G0T25)**

XMLR	M01	G	0	T	2	5
<b>Pressure range</b>						
-1 – +0	M01					
1	001					
2.5	002					
10	010					
16	016					
25	025					
40	040					
100	100					
160	160					
250	250					
400	400					
600	600					

<b>Pressure technology</b>	
Gauge ceramic	G
Gauge metal	M

<b>Digital output</b>	
No digital output	0
1 DC Digital output	1
2 DC Digital output	2

<b>Output / input type</b>	
No digital output / Test input	T
PNP	P
NPN	N

<b>Analog output</b>	
No analog output	0
DC analog 4 – 20 mA	2
DC analog 0 – 10 V	7

<b>Fluid entry</b>	
G 1/4 (female) DIN 3852-E	5
1/4 in. – 18 NPT (female)	6
7/16 in. – 20 UNF-2B (female)	9

**NOTE:** Use this table only to interpret the catalog number. Some combinations are not available.

**Table 22.33: Specifications**

Enclosure Rating	IP67 NEMA 4, 6, 12, 13	
Ambient Air Temperature for Operation	DC Models: –25 to +80 °C (–13 to +176 °F) AC Models: –25 to +80 °C (–13 to +176 °F)	
Media Temperature	–15 to +80 °C (+5 to +176 °F)	
Precision	Analog Output	≤0.6% of the measurement range, output offset <200 mV
	Digital Output	≤0.6% of the measurement range
Repeat Accuracy (PNP/NPN output)	≤0.5% of the measurement range	
Maximum Load Current	<b>DC:</b> 200 mA for 17–33 Vdc; <b>AC:</b> 2.5A AC15 C300	

**Table 22.34: ZMLP Selection**

Output 1	Output 2	Switching Mode	Catalog Number
4–20 mA	PNP	Hysteresis	ZMLPA2PSH
		Windows	ZMLPA2PSW
	NPN	Hysteresis	ZMLPA2NSH
		Windows	ZMLPA2NSW
PNP	PNP	Hysteresis	ZMLPDPSSH
NPN	NPN	Hysteresis	ZMLPDNNSH

**Table 22.35: XMLR Selection**

Fluid entries	Outputs			Size							
	4–20 mA	PNP	NPN	–1 bar	1 bar	10 bar	16 bar	40 bar	250 bar	400 bar	
1/4"-18NPT	1	—	1	XMLRM01G1N26	XMLR001G1N26	XMLR010G1N26	XMLR016G1N26	XMLR040G1N26	XMLR250M1N26	XMLR400M1N26	
	—	—	2	XMLRM01G2N06	XMLR0012G2N06	XMLR010G2N06	XMLR016G2N06	XMLR040G2N06	XMLR250M2N06	XMLR400M2N06	
G1/4A	1	—	—	XMLRM01G0T25	XMLR001G0T25	XMLR010G0T25	XMLR016G0T25	XMLR040G0T25	XMLR250M0T25	XMLR400M0T25	
	—	1	—	XMLRM01G1P25	XMLR001G1P25	XMLR010G1P25	XMLR016G1P25	XMLR040G1P25	XMLR250M1P25	XMLR400M1P25	
	—	2	—	XMLRM01G2P05	XMLR001G2P05	XMLR010G2P05	XMLR016G2P05	XMLR040G2P05	XMLR250M2P05	XMLR400M2P05	

For more options for fluid entry, output, and size, visit [www.schneider-electric.com](http://www.schneider-electric.com).



File: E164865  
CCN / NKPZ



File: LR44087  
Class: 3211-03





XMLZL009

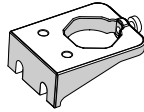

XMLZL017

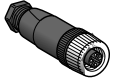

XZCC12FDM0B



XZCC12FC0B

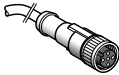

XZCP1141L

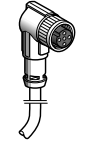

XZCP1241L

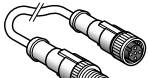

XZCR15110

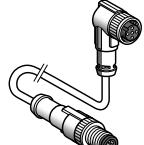

XZCR15120

XMLR Accessories, Wiring, and Electrical Connections

Table 22.36: Accessories

Description	For use with	Catalog Number	Weight kg (oz)
Cooler with G 1/4 A (male) connections Usage temperature: 150° C (302° F) max. for the fluid, 50° C (122° F) for the ambient air	XMLR.....5	XMLZL009	0.370 (13.051)
Fixing bracket aluminium	XMLR...	XMLZL017	0.029 (1.023)

Table 22.37: Connectors

Description	For use with	Type	Catalog Number	Weight kg (oz)
M12 female connector, 4-pin metal clamping ring	XMLR.....0T..	Straight	XZCC12FDM40B	0.020 (0.705)
	XMLR.....1P..			
	XMLR.....1N..			
	XMLR.....2P0p			
M12 female connector, 5-pin metal clamping ring	XMLR.....2N0.	Elbowed	XZCC12FCM40B	0.020 (0.705)
	XMLR.....2P2. XMLR.....2N2.	Straight	XZCC12FDM50B	0.020 (0.705)
	XMLR.....2P2. XMLR.....2N2.	Elbowed	XZCC12FCM50B	0.020 (0.705)

Table 22.38: Pre-wired connectors and jumper cables

Description	For use with	Type	Cable length m (ft)	Catalog Number	Weight kg (oz)
Pre-wired M12, 4-pin connectors Metal clamping ring PUR cable	XMLR.....0T.. XMLR.....1P.. XMLR.....1N.. XMLR.....2P0. XMLR.....2N0.	Straight	2 (6.56)	XZCP1141L2	0.090 (3.174)
			5 (16.40)	XZCP1141L5	0.190 (6.702)
			10 (32.81)	XZCP1141L10	0.370 (13.051)
		Elbowed	2 (6.56)	XZCP1241L2	0.090 (3.174)
			5 (16.40)	XZCP1241L5	0.190 (6.702)
			10 (32.81)	XZCP1241L10	0.370 (13.051)
Pre-wired M12, 5-pin connectors PVC cable	XMLR.....2P2. XMLR.....2N2.	Straight female connector	2 (6.56)	XZCPV11V12L2	0.100 (3.527)
			5 (16.40)	XZCPV11V12L5	0.200 (7.054)
		Elbowed female connector	10 (32.81)	XZCPV11V12L10	0.400 (14.109)
			2 (6.56)	XZCPV12V12L2	0.100 (3.527)
			10 (32.81)	XZCPV12V12L10	0.400 (14.109)
			Straight female connector	1 (3.28)	XZCR1511041C1
Elbowed female connector	2 (6.56)	XZCR1511041C2		0.100 (3.527)	
		1 (3.28)	XZCR1512041C1	0.100 (3.527)	
		2 (6.56)	XZCR1512041C2	0.100 (3.527)	
	M12-M12 4-pin jumper cables PUR cable	XMLR.....0T.. XMLR.....1P.. XMLR.....1N.. XMLR.....2P0. XMLR.....2N0.	Straight female connector	1 (3.28)	XZCR1511064D1
2 (6.56)				XZCR1511064D2	0.100 (3.527)
Elbowed female connector			1 (3.28)	XZCR1512064D1	0.100 (3.527)
			2 (6.56)	XZCR1512064D2	0.100 (3.527)



XMLB



XMLD

**XML Industrial Pressure Switches**

XML industrial pressure switches meet IEC, Cenelec, UL, and CSA standards. They are CE marked.

- Fixed differential (XMLA), adjustable differential single-pole (XMLB) or double-pole (XMLC), and dual stage (XMLD)
- Range listed is on increasing pressure (psi, bar, kPa)
- External pressure setting window available
- 1 N.O.–1 N.C. snap acting contacts standard
- Temperature range: –13 to +158 °F (–25 to +70 °C)
- Enclosure rating: IP65 with plug-in connector, IP66 with terminal connections
- Operating rate: up to 120 operations / min. for diaphragm and 60 / min. for piston
- Media connection: 1/4" NPT
- Conduit connection: 1/2" NPT

**Table 22.39: Specifications**

<b>Enclosure Rating</b>	Screw terminal models: IP66 conforming to IEC/EN 60529; Connector models: IP65 conforming to IEC/EN 60529	
<b>Ambient Temperature</b>	<b>Operation</b>	–25 to +70 °C (–13 to +158 °F)
	<b>Storage</b>	–40 to +70 °C (–40 to 158 °F)
<b>Repeat Accuracy</b>	< 2%	
<b>Fluids Controlled</b>	Hydraulic oils, air, fresh water, 32 to 320 °F (0 to +160 °C), depending on the model Steam, corrosive fluids, viscous products, 32 to 320 °F (0 to +160 °C), depending on the model	
<b>Operating Rate (operating cycles/minute)</b>	Piston version switches: up to 60 cycles/minute for temperatures above 32 °F (0 °C) Diaphragm version switches: up to 120 cycles/minute for temperatures above 32 °F (0 °C)	
<b>Operational Characteristics</b>	AC-15; B300 (Ue = 240 V, Ie = 1.5 A; Ue = 120 V, Ie = 3 A) DC-13; R300 (Ue = 250 V, Ie = 0.1) conforming to IEC 947-5-1 Appendix A, EN 60 947-5-1	
<b>Type of Contacts</b>	Silver tipped contacts XMLA & XMLB: 1 C/O single-pole contact (4 terminal), snap action XMLC: 2 C/O single-pole contacts (8 terminals), simultaneous snap action XMLD: 2 C/O single-pole contacts (8 terminals), staggered snap action	
<b>Resistance Across Terminals</b>	< 25 mW conforming to NF C 93-050 method A or IEC 255-7 category 3	
<b>Terminal Referencing</b>	Conforming to CENELEC EN 50013	
<b>Short-Circuit Protections</b>	10 A cartridge fuse type gG (gl) recommended	
<b>Connection</b>	Screw clamp terminals; Clamping capacity, min: 1 x 0.2 mm <sup>2</sup> , max: 2 x 2.5 mm <sup>2</sup>	

**Table 22.40: Component Materials in Contact with Fluid**

Pressure Switch Catalog Number	Zinc Alloy	Stainless Steel	Brass	Steel	Nitrile	PTFE	FPM, FKM	Aluminum
XMLAM01V**** / XMLM02V****	X	X [1]	—	—	X	—	—	—
XMLBM03S****	—	X [1]	—	—	—	X	—	—
XMLM05A****	X	X [1]	—	—	X	—	—	—
XMLBL05S****	—	X [2]	—	—	—	X	—	—
XMLL35R****	—	X [2]	—	X	—	—	X	—
XMLL35S**** / XML001S****	—	X [2]	—	—	—	X	—	—
XML002A****	X	—	—	—	X	—	—	—
XML002B****	—	—	—	X	—	—	X	—
XMLA004A**** / XMLB004A****	X	—	—	—	X	—	—	—
XML004B****	—	—	—	X	—	—	X	—
XML010A****	X	—	—	—	X	—	—	—
XML010B****	—	—	X	—	—	—	X	—
XML020A**** / XML035A****	X	—	—	—	X	—	—	X
XML020B**** / XML035B****	—	—	X	—	—	—	X	—
XML070D**** / XML160D**** / XML300D****	—	—	X	X	—	X	X	—
XML500D****	—	—	X1	X	—	X	X	—

**Table 22.41: Interpretation of the Catalog Number (example: XMLD070D1S13)**

(XML) D	070	D	1	S	1	3	
Contacts	Rated Pressure	Actuator	Scale	Electrical Connection	Output	Fluid Connection	
A Fixed differential, single-pole contact	<b>Code</b>	<b>Diaphragm</b>	1 Without	S Without connector (not available on solid-state devices)	1 Contacts	<b>Fluid</b>	<b>Electrical</b>
	<b>L05</b> 0 to 0.725 0 to 0.05						
B Adjustable differential, single-pole contact	<b>M01</b> -14.5 to -4.06 -1 to -0.28	B Hydraulic oil, air, fresh water, sea water (0 to 160 °C)	With	C Square / DIN 43650	2 1/4 Gas	ISO M20	
	<b>M02</b> -14.5 to -2.03 -1 to -0.14	C Corrosive fluids					3 1/4 in. NPTF 1/2 in. NPT
C 2 adjustable differential, single-pole contacts, simultaneous	<b>M03</b> -2.9 to -.029 -0.2 to -0.02	P Viscous fluids	4	D M12 Micro connector	4 PT 1/4 (JIS B0203)	1/2 in. PF (JIS B0202)	
	<b>M05</b> -7.25 to 72.5 -0.5 to 5	R Hydraulic oil, air (0 to 160 °C)					
D 2 fixed differential, single-pole contacts, staggered	<b>001</b> 0 to 14.5 0 to 1	S Fresh/sea water, corrosive fluids (0 to 160 °C)	500				
	<b>002</b> 0 to 36.25 0 to 2.5	<b>Vacuum</b>					
	<b>004</b> 0 to 58 0 to 4	V Hydraulic oil, air, fresh water, sea water (0 to 70 °C)					
	<b>010</b> 0 to 145 0 to 10	T Hydraulic oil, air, fresh water, sea water (0 to 160 °C)					
	<b>020</b> 0 to 290 0 to 20	<b>Piston</b>					
	<b>035</b> 0 to 507.5 0 to 35	D Hydraulic oil					
	<b>040</b> 0 to 580 0 to 40	E Fresh / sea water					
	<b>070</b> 0 to 1015 0 to 70						
	<b>160</b> 0 to 2320 0 to 160						
	<b>300</b> 0 to 4350 0 to 300						

**NOTE:** Use this table only to interpret the catalog number. Some combinations are not available

[1] X2GNiMo 17-12-2 (AISI 316L)  
[2] X8GNiS 18-09 (AISI 303)

Terminal Diagrams

**XMLA, XMLB**

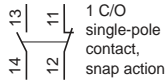

**XMLC**

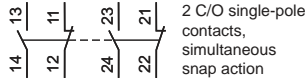

**XMLD**

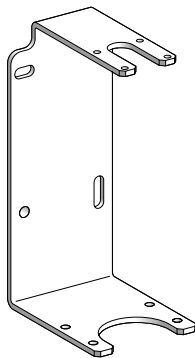
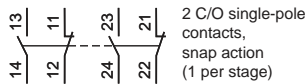

XMLZL006

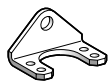

XMLZL002

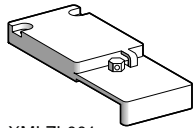

XMLZL001

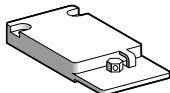

XMLZL011

XML Catalog Numbers and Accessories

Table 22.42: Fixed Differential Catalog Numbers

Range on Increasing Pressure (psi)	Approximate Differential Across Range	Maximum Allowable Pressure	Catalog Number
<b>Fixed, 1 Single-Pole Contact (XMLA)</b>			
-4.06 to -14.5	3.5	130.5	XMLAM01V2S13
0.435 to 14.5	0.29 low / 0.58 high	32.62	XMLA001S2S13
2.17 to 36.25	1.88	130.5	XMLA002A2S13
5.8 to 58	5.07	130.5	XMLA004A2S13
8.7 to 145	7.25	326.25	XMLA010A2S13
10.2 to 290	5.8 low / 14.5 high	652.5	XMLA020A2S13
21.75 to 507.5	18.12	1160	XMLA035A2S13
72.5 to 1015	43.5 low / 108.75 high	2320	XMLA070D2S13
145 to 2320	79.75 low / 261 high	5220	XMLA160D2S13
290 to 4350	239.25 low / 507.5 high	9787.5	XMLA300D2S13
435 to 7250	290 low / 652.5 high	16312.5	XMLA500D2S13
<b>Fixed, 2 Single-Pole Contacts, Staggered (XMLD)</b>			
0.84 to 5.07	0.44	32.62	XMLDL35S1S13
-1.74 to -14.5	1.45	130.5	XMLDM02V1S13
1.74 to 14.5	0.44 low / 1.02 high	32.62	XMLD001S1S13
4.93 to 36.25	2.03 low / 2.76 high	130.5	XMLD002B1S13
5.8 to 58	2.18 low / 2.76 high	130.5	XMLD004B1S13
17.4 to 145	6.53 low / 8.7 high	326.25	XMLD010B1S13
2.14 to 20	10.15 low / 18.85 high	652.5	XMLD020B1S13
63.8 to 507.5	21.75 low / 37.7 high	1160	XMLD035B1S13
136.3 to 1015	72.5 low / 137.75 high	2320	XMLD070D1S13
239.25 to 2320	127.6 low / 290 high	5220	XMLD160D1S13
522 to 4350	246.5 low / 609 high	9787.5	XMLD300D1S13
594.5 to 7250	304.5 low / 942.5 high	16312.5	XMLD500D1S13

Table 22.43: Adjustable Differential Catalog Numbers

Range on Increasing Pressure (psi)	Approximate Differential Across Range	Maximum Allowable Pressure	Catalog Number
<b>Adjustable, 1 Single-Pole Contact (XMLB)</b>			
0.038 to 0.72	0.02 low / 0.06 high	1.63	XMLBL05S2S13
0.65 to 5.07	0.6 low / 0.72 high	32.62	XMLBL35R2S13
-2 to -14.5	1.9	130.5	XMLBM02V2S13
-0.29 to -2.9	0.26	29	XMLBM03S2S13
-7.25 to 72.5	7.25	163.12	XMLBM05A2S13
0.72 to 14.5	0.58 low / 0.87 high	32.62	XMLB001S2S13
4.35 to 36.25	2.32 low / 3.04 high	130.5	XMLB002A2S13
3.62 to 58	2.9 low / 3.62 high	130.5	XMLB004A2S13
10.15 to 145	8.26 low / 12.32 high	326.25	XMLB010A2S13
18.9 to 290	14.5 low / 23.2 high	652.5	XMLB020A2S13
50.75 to 507.5	24.65 low / 36.97 high	1160	XMLB035A2S13
101.5 to 1015	68.15 low / 127.6 high	2320	XMLB070D2S13
145 to 2320	134.85 low / 301.6 high	5220	XMLB160D2S13
319 to 4350	281.3 low / 536.5	9787.5	XMLB300D2S13
435 to 7250	333.5 low / 762.7 high	16312.5	XMLB500D2S13
<b>Adjustable, 2 Single-Pole Contacts, Simultaneous (XMLC)</b>			
0.65 to 5.07	0.29 low / 0.51 high	32.62	XMLCL35S2S13
-2 to -14.5	1.89 low / 2.03 high	130.5	XMLCM02V2S13
-7.97 to 72.5	6.52	163.12	XMLCM05S2S13
0.725 to 14.5	0.43 low / 0.58 high	32.62	XMLC001S2S13
4.35 to 36.25	1.89 low / 2.47 high	130.5	XMLC002B2S13
4.35 to 58	2.18 low / 2.47 high	130.5	XMLC004B2S13
10.15 to 145	6.53 low / 10.15 high	326.25	XMLC010B2S13
18.85 to 290	10.15 low / 14.5 high	652.5	XMLC020B2S13
50.75 to 507.5	14.5 low / 21.75 high	1160	XMLC035B2S13
101.5 to 1015	65.25 low / 129.05 high	2320	XMLC070D2S13
174 to 2320	130.5 low / 304.5 high	5220	XMLC160D2S13
319 to 4350	232 low / 507.5 high	9787.5	XMLC300D2S13
435 to 7250	275.5 low / 754 high	16312.5	XMLC500D2S13

Table 22.44: Accessories for XML Pressure and Vacuum Switches

Description	For Use with Switches	Catalog Number
<b>Rear mounting bracket</b> For vibrations > 2 gn	XML-L35 XML-001	XMLZL006
<b>Additional top support bracket</b> For vibrations > 4 gn	XMLAM01 XML-M05 XMLA004 XML-010 ... XML-500	XMLZL002
<b>Lead sealable protective cover</b> To prevent unauthorized access to the adjustment screws and the switch cover mounting screw	XMLA XMLB	XMLZL001
<b>Lead sealable protective cover</b> To prevent unauthorized access to adjustment screws	All models	XMLZL011



**XML Dimensions**

XMLAM01, XMLBM05, XMLCM05, XMLA004, X-ML010...500

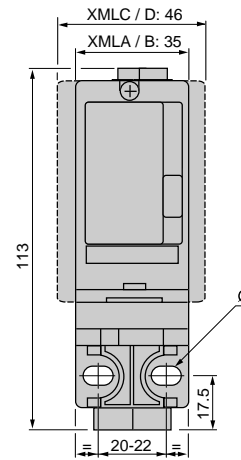
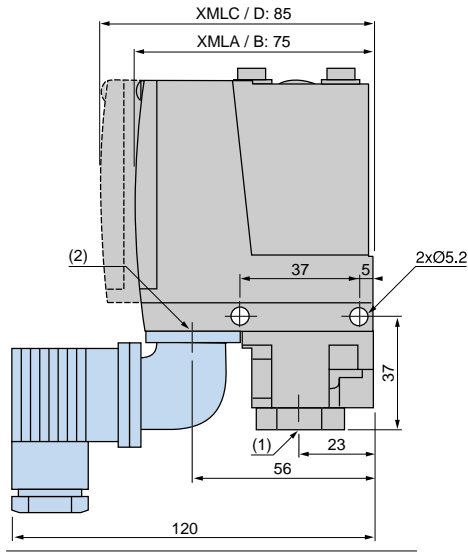

(1) 1 fluid entry, tapped G 1/4 (BSP female) or 1/4" NPT  
(2) 1 electrical connections entry, tapped M20 x 1.5 or Pg 13.5, or 1/2" NPT  
Ø: 2 elongated holes Ø 5.2 x 6.7

**XML-M02, XML-002, XMLB004, XMLC004, XMLD004**

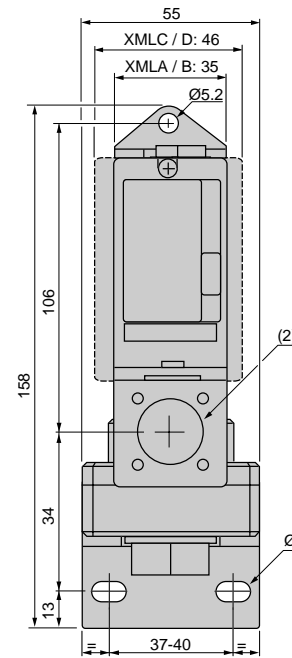
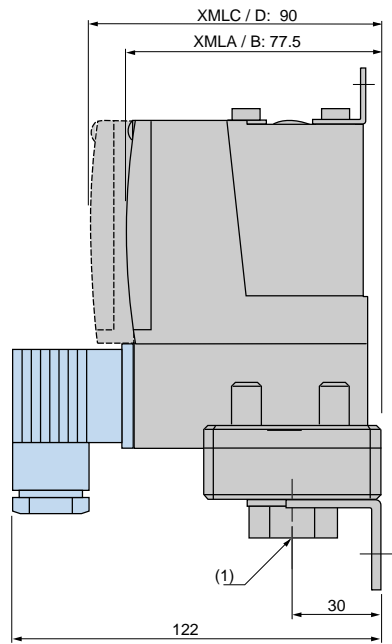

(1) 1 fluid entry, tapped G 1/4 (BSP female) or 1/4" NPT  
(2) 1 electrical connections entry, tapped M20 x 1.5 or Pg 13.5, or 1/2" NPT  
Ø: 2 elongated holes Ø 10.2 x 5.2



NEMA 1



Open Type

Class 9012 Type G Pressure Switches

Table 22.45: Fixed Differential, Open Type or NEMA 1 Enclosure

Range On Decreasing Pressure psig	Approximate Differential at Mid-Range psig [3]	Maximum Allowable Pressure psig	Open Type	NEMA 1
			Catalog No.	Catalog No.
<b>Diaphragm Actuated—Nitrile (Buna-N) Diaphragm, Zinc Plated Steel Housing</b>				
0.2–10	0.4 ±0.1	100	9012GRO1	9012GRG1
1–40	1.2 ±0.3	100	9012GRO3	9012GRG3
1.5–75	2.2 ±0.4	240	9012GRO4	9012GRG4
3–150	4.2 ±1	475	9012GRO5	9012GRG5
5–250	7.4 ±2	750	9012GRO6	9012GRG6
13–425	13 ±3	850	—	9012GSG1
20–675	19 ±5	2000	—	9012GSG2
<b>Piston Actuated—#440 Stainless Steel Piston. #303 Stainless Steel Housing, Viton® Fluorocarbon Diaphragm and O-Ring, Teflon® Retaining Ring</b>				
20–1000	49 ±10	10000	—	9012GTG1
90–2900	141 ±15	15000	9012GTO2	9012GTG2
170–5600	200 ±40	20000	9012GTO3	9012GTG3
270–9000	350 ±45	25000	—	9012GTG4

Table 22.46: Adjustable Differential, Open Type or NEMA 1 Enclosure

Range On Decreasing Pressure psig	Approximate Mid-Range Differential Adds to Decreasing Set Point [3]	Maximum Allowable Pressure psig	Open Type	NEMA 1
			Catalog No.	Catalog No.
<b>Diaphragm Actuated—Nitrile (Buna-N) Diaphragm, Zinc Plated Steel Housing</b>				
0.2–10	0.4–0.9	100	9012GNO1	9012GNG1
1–40	1.2–3.6	100	9012GNO3	9012GNG3
1.5–75	2.2–6.6	240	9012GNO4	9012GNG4
3–150	4.2–13.2	475	9012GNO5	9012GNG5
5–250	7.4–33.6	750	9012GNO6	9012GNG6
13–425	13–37.2	850	9012GPO1	9012GPG1
20–675	19–58.8	2000	9012GPO2	9012GPG2
<b>Piston Actuated—#440 Stainless Steel Piston. #303 Stainless Steel Housing, Viton Fluorocarbon Diaphragm and O-Ring, Teflon Retaining Ring</b>				
20–1000	49–150	10000	—	9012GQG1
90–2900	141–455	15000	9012GQO2	9012GQG2
170–5600	200–950	20000	9012GQO3	9012GQG3
270–9000	350–1400	25000	—	9012GQG4

Table 22.47: Available Modifications [4]

Modification	Applies to	Form
Standard Nitrile (Buna-N) diaphragm in #316 stainless steel housing	<b>Not available</b> on GNG1, GNO1, GRG1, or GRO1. <b>Available</b> on all other GNG, GNO, GPG, GPO, GRG, GRO, GSG, and GSO switches.	Q1
Viton fluorocarbon diaphragm in #316 stainless steel housing	<b>Not available</b> on GNG1, GNO1, GRG1, or GRO1. <b>Available</b> on all other GNG, GNO, GPG, GPO, GRG, GRO, GSG, and GSO switches.	Q4
1/4–18 NPT external thread pressure connection	GNG, GNO, GRG, GRO	Z
1/2–14 NPT external thread, 1/4–18 NPTF internal thread pressure connection. Standard actuator only.	GNG, GNO, GRG, GRO	Z16
7/16–20 UNF-2B internal thread pressure connection	GNG, GNO, GPG, GPO, GQG, GQO, GRG, GRO, GSG, GSO, GTG, GTO	Z18

Table 22.48: Class 9049 Accessories for Class 9012 Pressure Switches

Description	Applies to Class	Catalog No.
Stainless steel surge reducer for use on oils, coolants, and hydraulic fluids (not recommended for air or water)	9012G	9049A26S

Acceptable Wire Sizes 12-22 AWG

Recommended Terminal Clamp Torque 7 lb-in

Electrical Rating page 22-19

Temperature Rating page 22-19

Renewal Parts Kits page 22-34



File E12158  
CCN NKPZ



File LR25490  
Class 3211-03



[3] Determines operating point on rising pressure.

[4] Some product configurations are not available—contact your Schneider Electric representative for details.

Control Circuit Rated Type G Pressure Switches

Class 9012 single stage pressure switches are control circuit rated devices used in pneumatic or hydraulic systems on a wide variety of machine and process applications to protect the equipment and control or monitor the system pressure.

- Type G machine tool switches are available with NEMA Type 4, 4X, and 13 (IEC IP66) enclosure ratings.
- The NEMA 7 and 9 devices are UL listed for use in the following hazardous locations: Class I, Divisions 1 and 2, Groups C and D; and Class II, Divisions 1 and 2, Groups E, F, and G.
- Enclosure materials are cast aluminum.
- To ensure repeatability and minimize setting drift, pressure settings should fall within the middle 80 percent of the pressure range.



9012GAW5  
NEMA 4, 4X, 13

Table 22.49: Fixed Differential [5]

NEMA 4, 4X, 13 Enclosure

UL Listed and CSA Certified As Industrial Control Equipment

Range on Decreasing Pressure psig	[6] Approximate Differential at Mid-Range psig	Maximum Allowable Pressure psig	Single Pole Double Throw	Double Pole Double Throw
			Catalog No.	Catalog No.
<b>Diaphragm Actuated—Nitrile (Buna-N) Diaphragm, Zinc Plated Steel Housing</b>				
2-10	0.6 ±0.1	100	9012GDW1	9012GDW21
1-40	1.6 ±0.4	100	9012GDW2	9012GDW22
1.5-75	3.0 ±0.5	240	9012GDW4	9012GDW24
3-150	6.0 ±0.8	475	9012GDW5	9012GDW25
5-250	10.0 ±1.5	750	9012GDW6	9012GDW26
13-425	16 ±3.5	850	9012GEW1	9012GEW21
20-675	27 ±5	2000	9012GEW2	9012GEW22
<b>Piston Actuated—#440 Stainless Steel Piston, #303 Stainless Steel Housing, Viton® Fluorocarbon Diaphragm and O-ring, Teflon® Retaining Ring</b>				
20-1000	59 ±9	10000	9012GFW1	9012GFW21
90-2900	170 ±15	15000	9012GFW2	9012GFW22
170-5600	289 ±55	20000	9012GFW3	9012GFW23
270-9000	495 ±70	25000	9012GFW4	9012GFW24

Table 22.50: Adjustable Differential [5]

NEMA 4, 4X, 13 Enclosure UL Listed and CSA Certified As Industrial Control Equipment

Range on Decreasing Pressure psig	[6] Adjustable Differential Approximate at Mid-Range	Maximum Allowable Pressure psig	Single Pole Double Throw	Double Pole Double Throw
			Catalog No.	Catalog No.
<b>Diaphragm Actuated—Nitrile (Buna-N) Diaphragm, Zinc Plated Steel Housing</b>				
2-10	0.6-2	100	9012GAW1	9012GAW21
1-40	1.6-8	100	9012GAW2	9012GAW22
1.5-75	3.5-15	240	9012GAW4	9012GAW24
3-150	6.0-30	475	9012GAW5	9012GAW25
5-250	10.0-49	750	9012GAW6	9012GAW26
13-425	16-90	850	9012GBW1	9012GBW21
20-675	27-130	2000	9012GBW2	9012GBW22
<b>Piston Actuated—#440 Stainless Steel Piston, #303 Stainless Steel Housing, Viton Fluorocarbon Diaphragm and O-ring, Teflon® Retaining Ring</b>				
20-1000	59-200	10000	9012GCW1	9012GCW21
90-2900	170-560	15000	9012GCW2	9012GCW22
170-5600	289-1260	20000	9012GCW3	9012GCW23
270-9000	495-1900	25000	9012GCW4	9012GCW24

Table 22.51: Fixed Differential

NEMA 7 & 9 Enclosure

Class I & II, Division 1 & 2, Groups C, D, E, F, G

Range on Decreasing Pressure psig	[6] Approximate Differential at Mid-Range psig	Maximum Allowable Pressure psig	Single Pole Double Throw	Double Pole Double Throw
			Catalog No.	Catalog No.
<b>Diaphragm Actuated—Nitrile (Buna-N) Diaphragm, Zinc Plated Steel Housing</b>				
0.2-10	1.0 ±0.1	100	9012GDR1	—
1-40	2.4 ±0.8	100	9012GDR2	9012GDR22
1.5-75	4.5 ±1	240	9012GDR4	9012GDR24
3-150	9 ±1.5	475	9012GDR5	9012GDR25
5-250	15 ±3	750	9012GDR6	9012GDR26
13-425	25 ±7	850	9012GER1	9012GER21
<b>Piston Actuated—#440 Stainless Steel Piston, #303 Stainless Steel Housing, Viton Fluorocarbon Diaphragm and O-ring, Teflon® Retaining Ring</b>				
20-1000	89 ±18	10000	9012GFR1	9012GFR21
90-2900	255 ±30	15000	9012GFR2	9012GFR22
170-5600	578 ±110	20000	9012GFR3	—

Table 22.52: Adjustable Differential

NEMA 7 & 9 Enclosure

Class I & II, Division 1 & 2, Groups C, D, E, F, G

Range on Decreasing Pressure psig	[6] Adjustable Differential Approximate at Mid-Range	Maximum Allowable Pressure psig	Single Pole Double Throw	Double Pole Double Throw
			Catalog No.	Catalog No.
<b>Diaphragm Actuated—Nitrile (Buna-N) Diaphragm, Zinc Plated Steel Housing</b>				
0.2-10	1.0-2	100	9012GAR1	9012GAR21
1-40	2.4-8	100	9012GAR2	9012GAR22
1.5-75	4.5-15	240	9012GAR4	9012GAR24
3-150	9-35	475	9012GAR5	9012GAR25
5-250	15-49	750	9012GAR6	9012GAR26
13-425	25-90	850	9012GBR1	9012GBR21
20-675	41-130	2000	9012GBR2	9012GBR22
<b>Piston Actuated—#440 Stainless Steel Piston, #303 Stainless Steel Housing, Viton Fluorocarbon Diaphragm and O-ring, Teflon® Retaining Ring</b>				
20-1000	89-200	10000	9012GCR1	9012GCR21
90-2900	255-560	15000	9012GCR2	—
170-5600	578-1260	20000	9012GCR3	9012GCR23
270-9000	788-1900	25000	9012GCR4	—

Acceptable Wire Sizes: 12-22 AWG  
Recommended Terminal Clamp Torque: 7 lb-in  
Electrical Rating: see page 22-19  
Temperature Rating: see page 22-19  
Modifications: see page 22-21  
Accessories: see page 22-21  
Renewal Parts Kits: see page 22-34  
Dimensions: see page 22-20



File: E12443 Haz. Loc. CCN NOWT G•R  
File: E12158 CCN NKPZ G•O, G•G, G•W  
File: E12158 CCN NTHT Marine Use, G•W



File: LR25490 Class 3211-03 G•W, G•O, G•G  
File: LR26817 Class 3218-02 G•R



Complies with IEC 60957.5.1, 5C8.3.4 when protected with a Bussmann CCKTK-R-10 fuse.

[5] For metric threads, add M after the W on all types (offered at an additional cost). To order a Pg13.5 electrical conduit entry and a 1/4"-19 BSP pressure connection, add M12 to the end of the catalog number, as well as adding "M" after "W" for metric threads. For example: 9012GAW1 = 1/2" NPT electrical conduit entry

9012GAWM1 = 20 x 1.5 mm electrical conduit entry  
9012GAWM1M12 = Pg13.5 electrical conduit entry and 1/4-19 BSP pressure connection.

[6] The differential adds to the range setting and determines the operating point on rising pressure.



9012GGW1

### Differential/Dual Stage, Type G

#### Differential-Pressure Operation

Pressure switches for differential-pressure operation monitor the change in the difference between two pressures. Type G differential-pressure switches are used in applications to signal that a predetermined pressure difference has been reached as a result of a widening or increasing difference between the two pressures. They can also signal that a predetermined pressure difference has been reached as a result of a narrowing or decreasing difference between the two pressures.

**Table 22.53: Differential-Pressure Switches**

**NEMA 4, 4X, 13 Enclosures**

**UL Listed and CSA Certified As Industrial Control Equipment [7]**

Working Pressure Range on Decreasing X (upper) Actuator	Adjustable Difference on Decreasing Pressure (adds to working pressure) Y (lower) Actuator	Adjustable Differential Actuates on Increasing Pressure (adds to adjustable difference)	Maximum Allowable Pressure psi	Single Pole Double Throw	Double Pole Double Throw
				Cat. No.	Cat. No.
<b>Diaphragm Actuated—Nitrile (Buna-N) Diaphragm, Zinc Plated Steel Housing</b>					
0-75	0.25-10	0.8-2	100	GGW1	GGW21
0-175	0.5-36	5-15	240	GGW4	GGW24
0-500	3-175	22-90	850	GHW1	GHW21
<b>Piston Actuated—#440 Stainless Steel Piston. #303 Stainless Steel Housing, Viton® Fluorocarbon Diaphragm and O-ring, Teflon® Retaining Ring</b>					
0-5000	15-825	80-200	7500	GJW1	GJW21

#### Dual-Stage Operation

Type G dual stage pressure switches are designed for use in applications where two separate pressure operations must be controlled by a single pressure monitoring device. These controls are most commonly used where dual functions are required or in sequencing applications such as alarm, followed by shutdown.

**Table 22.54: Dual-Stage Pressure Switch**

**NEMA 4, 4X, 13 Enclosure**

**UL Listed and CSA Certified As Industrial Control Equipment [8]**

Range Setting Limits of Pressure Between Which Stage 1 Can Be Adjusted to Operate on Decreasing Pressure	Add Adjustable Spread to Range Setting to Obtain Decreasing Operating Point of Stage 2	Fixed Differential—Add to Low (Decreasing) Operating Point to Obtain Approximate High (Rising) Operating Point of Each Stage		Maximum Allowable Pressure psi	SPDT Each Stage
		Stage 1	Stage 2		Catalog No.
<b>Diaphragm Actuated—Nitrile (Buna-N) Diaphragm, Zinc Plated Steel Housing</b>					
2-10	1-5	1.0 ±0.2	1.5 ±0.4	100	9012GKW1
1-40	4-20	4.0 ±1.0	6.0 ±1.5	100	9012GKW2
1.5-75	6-30	5.0 ±1.5	8.0 ±2.0	240	9012GKW4
3-150	12-75	8.0 ±2.0	12 ±3	475	9012GKW5
5-250	22-110	14 ±3	21 ±5	750	9012GKW6
13-425	40-180	20 ±4	30 ±7.5	850	9012GLW1
20-675	45-250	30 ±6	45 ±11	2000	9012GLW2
<b>Piston Actuated—#400 Stainless Steel Piston. #303 Stainless Steel Housing, Viton® Fluorocarbon Diaphragm and O-ring, Teflon® Retaining Ring</b>					
20-1000	50-300	50 ±10	75 ±19	10000	9012GMW1
90-2900	140-800	140 ±30	210 ±52	15000	9012GMW2
170-5600	300-1700	275 ±60	400 ±100	20000	9012GMW3
270-9000	500-2500	400 ±80	800 ±150	25000	9012GMW4



9012GKW1

#### Ordering Dual-Stage Pressure Switches

- Specify Class 9012 Type..., and indicate the high or low operating point for each stage within the limits shown in the above table.

**Example:**

Class 9012 Type GKW4

Set: Stage 1 at 30 psi decreasing pressure

Stage 2 at 50 psi decreasing pressure

(20 psi spread)

Differential of each stage will be approximately as shown in the table above.

- For available modifications see page 22-21. If one or more of these modifications are desired, add the appropriate Form to the Class and Type. Arrange form letters in alphabetical order when ordering more than one modification.

Acceptable Wire Sizes 12-22 AWG  
 Recommended Terminal Clamp Torque 7 lb-in  
 Electrical Rating page 22-19  
 Temperature Rating page 22-19  
 Modifications page 22-21  
 Accessories page 22-21  
 Renewal Parts Kits page 22-34  
 Dimensions page 22-20



File E12158 CCN NKPZ  
 File E12158 CCN NTHT - Marine Use



File LR25490 Class 3211-03



[7] UL Marine Listed for use on vessels greater than 65 feet long where ignition protection is not required.

[8] UL Marine Listed for use on vessels greater than 65 feet long where ignition protection is not required.

**Electrical Ratings**

**Table 22.55: Control Duty Circuit Ratings**

Contacts	AC—50 or 60 Hz						DC			AC or DC
	V	Inductive, 35% Power Factor				Resistive 75% Power Factor Make and Break Amperes	Inductive and Resistive Make and Break Amperes		Continuous Carrying Amperes	
		Make A	VA	Break A	VA		Single Throw	Double Throw		
SPDT	120	60	7200	6	720	6	0.55	0.22	10	
	240	30	7200	3	720	3	0.27	0.11	10	
	480	15	7200	1.5	720	1.5	0.10	—	10	
	600	12	7200	1.2	720	1.2	—	—	—	
DPDT	120	60	7200	6	720	6	0.22	0.22	10	
	240	30	7200	3	720	3	0.11	0.11	10	
	480	15	7200	1.5	720	1.5	—	—	10	
	600	12	7200	1.2	720	1.2	—	—	—	

**Table 22.56: Type G Machine Tool and Vacuum (except GVG)**

Type	Contact Arrangement	Contact Symbol
Single Pole Double Throw	1 N.O.—1 N.C.	

**NOTE:** Snap switch contains two double-break contact elements (1 N. O. and 1 N.C.) that must be used on circuits of same polarity.

**Table 22.57: Type G Industrial**

Contact Arrangement	Contact Symbol
1 N.O.—1 N.C. (600 Vdc rating does not apply)	

**NOTE:** Contacts are single pole, double throw—one circuit normally open and one circuit normally closed. These circuits are not electrically separate and can not be used on opposite polarities.

Type	Contact Arrangement	Contact Symbol
Double Pole Double Throw	2 N.O.—2 N.C.	

**NOTE:** Snap switch contains two electrically separated sets of contact elements allowing use on circuits of opposite polarity. Each set contains two double break contact elements (1 N.O. and 1 N.C.) that must be used on circuits of the same polarity.

**Table 22.58: Temperature Ratings**

	Actuator	Minimum	Maximum
Ambient	All	-23 °C (-10 °F)	+85 °C (+185 °F)
	Diaphragm	-40 °C (-40 °F)	
Media	Piston	-26 °C (-15 °F)	+120 °C (+250 °F)
	All with Forms Q4 and Q14	-26 °C (-15 °F)	

**Types GAW, GBW, GCW, GDW, GEW, GFW, GKW, GLW, and GMW Machine Tool Switches (except 1, 21)**

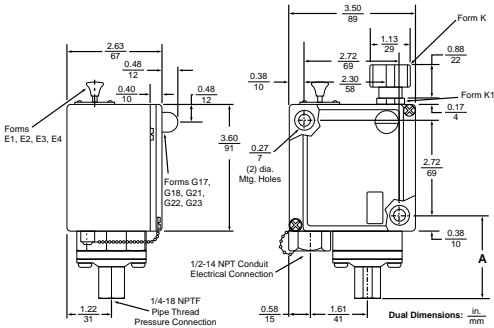

**Types GAW, GDW, GKW 1, 21**

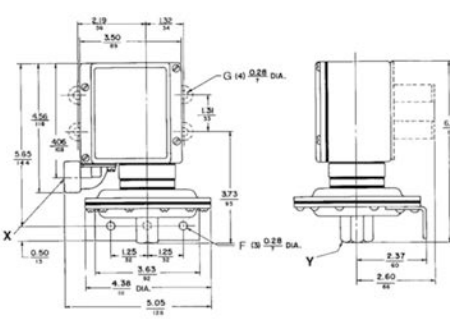

X: Conduit connection: G-W = 1/2-14 NPT; G-WM = 20MMBGS4568, Form M12 = Pg13.5; DIN40430.

Y: Pressure connection: G-W = 1/4-18 NPTF; G-WM = 8; Form M14 = G 1/4 BS 2779; RP1/4 ISO 711; R 1/4 DIN 2999; GJ 1/4 UN1339.

**Table 22.59: Dimension A for G-W Switches**

Type	Dimension A, in. (mm)
GAW, GDW, GKW 2, 4, 5, 6, 22, 24, 25, 26, 52, 54, 55, 56	2.33 (59)
GBW, GEW, GLW 1, 2, 21, 22, 51, 52	2.23 (57)
GCW, GFW, GMW 1, 2, 3, 4, 21, 22, 23, 24, 51, 52, 53, 54	3.15 (80)

**Table 22.60: Dimension A for G-R, Switches**

Type / Tipo / Type	Dimension A, in. (mm)
GAR1, 2, 21, 22	2.02 (51.3)
GAR4, 5, 6, 24, 25, 26	1.42 (36.1)
GBR1, 2, 21, 22; GCR1, 21	1.32 (33.5)
GCR2, 3, 4, 22, 23, 24	2.24 (56.9)
GDR1, 2, 21, 22	2.02 (51.3)
GDR4, 5, 6, 24, 25, 26	1.42 (36.1)
GER1, 2, 21, 22; GFR1, 21	1.32 (33.5)
GFR2, 3, 4, 22, 23, 24	2.24 (56.9)

**Types GAR, GBR, GCR, GDR, GER, and GFR**

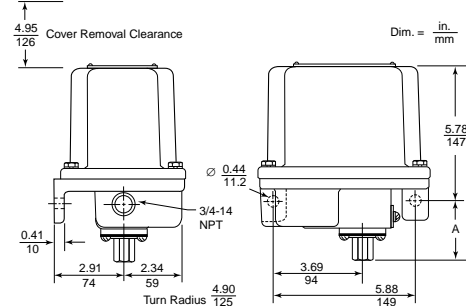

Dimensions  
9012G Dimensions, in. (mm)

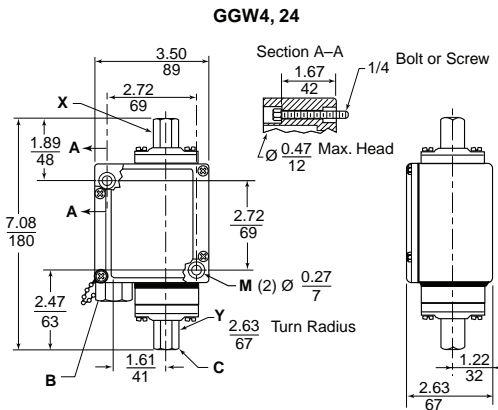
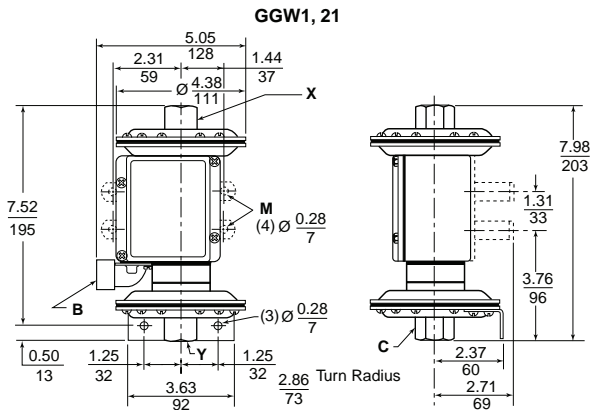

B = Conduit  
Standard = 1/2-14 NPT  
Options = Pg 13.5, 20 mm

C = Fluid Connection  
Standard = 1/4-18 NPTF  
Options = G 1/4

X = Lower pressure source  
Y = Higher pressure source

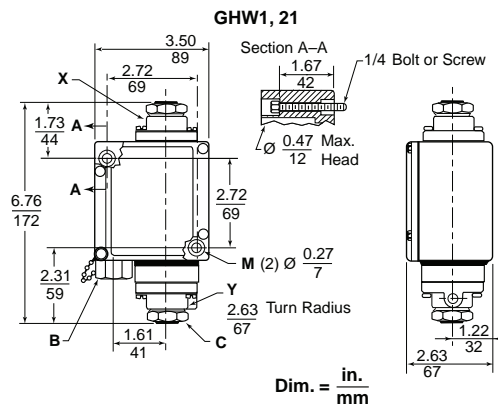
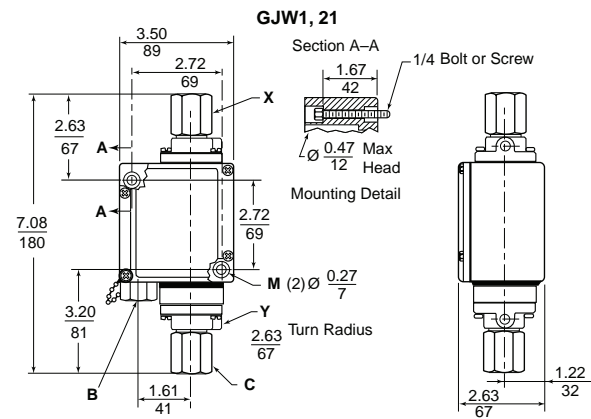

Dim. = in. / mm

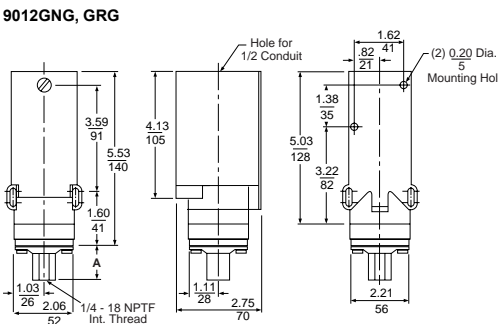
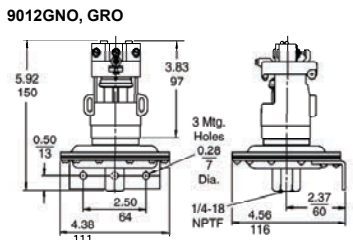
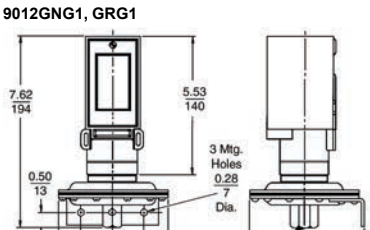
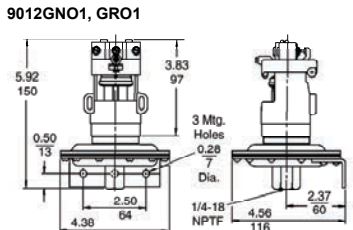

Type	Dimension A, in. (mm)
GNO, GRO 3, 4, 5, 6	1.41 (35.8)
GPO, GSO 1, 2, 3	1.31 (33.3)
GQO, GTO 1, 2, 3, 4	2.24 (56.9)

Type	Dimension A, in. (mm)
GNG, GRG 3, 4, 5, 6	1.41 (35.8)
GPG, GSG 1, 2, 3	1.31 (33.3)
GQG, GTG 1, 2, 3, 4	2.24 (56.9)

**Factory Modifications and Accessories**

**Table 22.61: Factory Modifications for Class 9012 Pressure Switches**

Modification	Applies to Pressure Switch Type	Form
Lock on rising pressure, manual reset only	Available on GDW, GDWM, GEW, GEWM, GFW, GFWM only	E3
120 Vac or Vdc neon pilot light	Available on all GAW–GMW, GAWM–GFWM	with clear lens G17 with red lens G18
24 Vdc only LED	For pilot light conversion kits: See 9998 PC-306–308. Complete Class and Type information required	with clear lens G21 with red lens G22
24 Vdc LED pilot light with green lens	Class 9012 GAW–GMW and GAWM–GFWM, or Class 9016 GAW and Class 9025G	G23
SPDT snap switch rated 1.1 A at 125 Vdc (minimum differential doubles)	Available on GAR–GFR, GAW–GJW, GAWM–GFWM	H3
Prewired 5-pin Brad Harrison male receptacle #41310 or interchangeable Crouse-Hinds receptacle. For use with Brad Harrison female portable plug #41306, 41307, 41308, or equivalent.	Available on GAW–GJW single pole devices only	H10 or H11
Micro connector, 4-pin, for 24 Vdc pilot light	G–W (single pole only), except GAW2 and Form B2.	H17
External range adjustment (includes knob and range scale window)	GAW–GFW, GAWM–GFWM, GKW–GMW	K
External range adjustment slotted for screwdriver (includes range scale window)	GAW–GFW, GAWM–GFWM, GKW–GMW	K1
Pg 13.5 conduit thread and 1/4–19 BSP pressure connection	G–WM only	M12
Standard Nitrile (Buna-N) diaphragm in #316 stainless steel flange	<b>Not available</b> on Types 1 and 21. <b>Available</b> on all other GAR, GAW, GBR, GBW, GDR, GDW, GER, GEW, GAWM, GBWM, GDWM, GEWM, GGW, GHW, GKW, and GLW switches.	Q1
Viton® fluorocarbon diaphragm in #316 stainless steel flange	<b>Not available</b> on Types 1 and 21. <b>Available</b> on all other GAR, GAW, GBR, GBW, GDR, GDW, GER, GEW, GAWM, GBWM, GDWM, GEWM, GGW, GHW, GKW, and GLW switches.	Q4
Range scale window (standard with Forms K and K1)	GAW–GMW, GAWM–GFWM	V1
Special setting specified (if indicating only a fixed differential setting, specify whether this setting is on increasing or decreasing pressure.)	All 9012G	Y1
1/4"–18 NPT external thread pressure connection	GAR, GAW, GDR, GDW, GGW, GKW Not available in combination with Forms Q1, Q3, Q4.	Z
1/2"–14 NPT external thread, 1/4"–18 NPTF internal thread pressure connection	GAR, GAW, GDR, GDW, GGW, GKW Not available in combination with Forms Q1, Q3, Q4.	Z16
7/16"–20 UNF–2B internal thread pressure connection	GAR–GFR; GAW–GMW Not available in combination with Forms Q1, Q3, Q4.	Z18

**Table 22.62: Factory Modifications for Renewal Parts Kits for Class 9012 Pressure Switches**

Suffixes for renewal parts kits, see page 22-34

Modification	Applies to Parts Kit Type	Form
SPDT snap switch rated 1.1 A at 125 Vdc (minimum differential doubles)	9998PC313	H3
Standard Nitrile (Buna-N) diaphragm in #316 stainless steel flange	9998PC177–179, 268, 269 9998PC265–267	Q1
Viton® fluorocarbon diaphragm in #316 stainless steel flange	9998PC177–178, 268, 269 9998PC265–267	Q4
1/4"–18 NPT external thread pressure connection	9998PC265–269	Z
1/2"–14 NPT external thread, 1/4"–18 NPTF internal thread pressure connection	9998PC265–269	Z16
7/16"–20 UNF–2B internal thread pressure connection	9998PC177, 178, 265–273	Z18

**Table 22.63: Class 9049 Accessories for Class 9012 Pressure Switches**

Description	Applies to Class	Type
Stainless steel surge reducer for use on oils, coolants, and hydraulic fluids (not recommended for air or water)	9012G	9049A26S



**Type GAW—Sensitive Control Applications**

9016GAW vacuum switches are provided with double throw contacts; normally open and normally closed circuits allow these controls to be used for standard or reverse action applications.

Standard devices can be mounted from the front with the bracket provided. Two mounting screws are required for a firm attachment to any smooth, flat surface. Allowance must be made for flange projection. Controls with Form F modification include two mounting feet with 9/32" mounting holes on 3-3/4" centers. Range and Differential adjustments are internal and exposed by removal of the front cover.

Maximum allowable positive pressure: 100 psig.  
Diaphragms are oil resistant, nitrile butadiene (Buna N) rubber.  
Electrical Ratings and Temperature Limitations—See page 22-17 for Type G machine tool.  
Dimensions—See page 22-20.

**Table 22.64: Class 9016, Diaphragm Actuated**

Range on Decreasing Vacuum (In. of Hg)	Adjustable Differential Adds to Range <sup>[1]</sup> (In. of Hg)	Contact Arrangement	Pipe Tap (NPTF)	Enclosure	
				NEMA 4, 4X & 13	NEMA 7 & 9 <sup>[2]</sup>
				Catalog No.	Catalog No.
0–28.7	At Minimum Range: 0.8–9 At Mid-Range: 1.3–7.4	1 N.O., 1 N.C.	1/4"-18	9016GAW1	9016GAR1
0–25	5–20	1 N.O., 1 N.C.	1/4"-18	9016GAW2	N/A
0–28.3	At Minimum Range: 1–9 At Mid-Range: 1.7–7.4	2 N.O., 2 N.C.	1/4"-18	9016GAW21	9016GAR21
0–25	5–20	2 N.O., 2 N.C.	1/4"-18	9016GAW22	N/A

**Table 22.65: Available Modifications**

Description	Form
Range scale window	V1
1/4"-18 NPT external thread pressure connection	Z
1/2"-14 NPT external thread, 1/4"-18 NPTF internal thread pressure connection (standard actuator only)	Z16



File E12443 Haz Loc  
File E12158  
File E12158

CCN NOWT G-R  
CCN NKPZ G-W  
CCN NTHT Marine Use, G+W



File LR25490 Type GAW only  
File LR26817 Type GAR only  
(NEMA 7 and 9 Haz Loc)



**Type GVG—Power Circuit Applications**

The 9016GVG1 vacuum switch is a companion to the 9036GG and 9037GG float switches commonly used on vacuum heating pumps. Electrical ratings of float and vacuum switch types are equal.



Class 9016 Type GVG1  
Forms E, F

**Table 22.66: Class 9016, Contacts Open on Increasing Vacuum**

Cut-out Range (In. of Hg)	Approximate Adjustable Differential (In. of Hg)	Cut-in Range (In. of Hg)	Poles	Pressure Connection	NEMA 1 Enclosure
					Catalog No.
5–25	5–10	0–20	2	1/4"-18 NPSF	9016GVG1

**NOTE:** Maximum allowable positive pressure: 150 psig.  
In. of Hg = inches of mercury.

**Table 22.67: Available Modifications**

Description	Form
3-way lever—nameplate marked: Float only—Vacuum and Float—Continuous (factory modification only)	E
Mounting bracket (for retrofit, order 9049A53 bracket kit)	F
Reverse action—normally open contacts	R
1/4" male pipe connection (1/4"-18 NPT, external thread) (for retrofit, use 1/4" pipe nipple)	Z

**Table 22.68: Electrical Ratings—9016GVG**

Voltage	AC		DC
	Single Phase	Polyphase	
110 V	2 hp	3 hp	1 hp
220 V	3 hp	5 hp	1 hp
440–550 V	5 hp	5 hp	—
32 V	—	—	1/2 hp

**NOTE:** Control Circuit Rating: A600

**Table 22.69: Vacuum Codes**

Settings (In. of Hg)	Code
3–8	J09
16.5–25	J10
17–22	J11
18–23	J12
20–25	J13
Specify other setting (minimum order quantity is 4 pieces)	J99

**Ordering Information:** Specify Class 9016 Type G. Give vacuum settings within the limits of the listings above.  
**For Setting Codes,** see the table entitled Vacuum Codes above. If special features are desired, add the appropriate Form letter to the Class and Type. Arrange the Form letters in alphabetical order when ordering more than one special feature.



File E12158  
CCN NKPZ



File LR25490

Dimensions page 22-19

[1] Add Differential to Range to obtain the operating point on increasing vacuum (within vacuum limitations). The differential increases linearly over its range.  
[2] The minimum differential doubles with NEMA 7 & 9 enclosures.



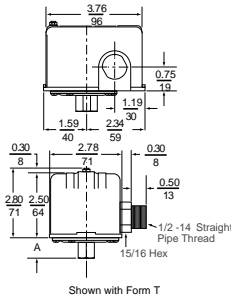

**FHG Pressure Switch Selection and Features**

Class 9013 Type FHG pressure switches are designed for the control of small electrically driven air compressors.

- Contacts open on pressure rise.
- Diaphragm actuated.
- For application data, see page 22-19.
- For repair parts kits, see page 22-34.

**Table 22.70: Dimensions, Type F (Net Weight, 1-1/8 lb)**

Switch Type	A	
	in.	mm
FHG2, 12, 22, 32, 42, 52 / FRG2, FSG2, FYG2	2-29/32	23
FHG3, 13, 33 / FRG3, FSG3, FYG3	1-9/32	33
FHG9, 19, 29, 39, 49, 59 / FSG9, FYG9	1-3/32	28

**Table 22.71: Special Features and Modifications for Type FHG<sup>[1]</sup>**

Description	Form
Bulk pack	[2]
Addition of a second ground screw	G4[3]
Maintained manual cut-out lever (Auto-Off)	M1
Pulsation plug—factory order only (available only on 1/4-inch fittings, not to include 4-way)	P
Slip-on connectors (load side terminals only)	U
Slip-on connectors (line and load terminals)	U2
Two-way pressure release valve	X
Quick connect two-way pressure release valve (for use with Polyflow® tubing)	X1
Black cover	Z22

**Table 22.73: Pressure Code (fixed differential)<sup>[1]</sup>**

Off at...	Code A
80 psi	J43
100 psi	J27
110 psi	J37
115 psi	J38
120 psi	J69
125 psi	J52
135 psi	J39
140 psi	J68
155 psi	J40
150 psi	J55
175 psi	J59
Specify other pressure (minimum order quantity is 4 pieces)	J99

**NOTE:** The existence of a code does not imply that the code is available for any or all devices.

**Table 22.72: Selection Table**

Adjustable Cut-out Range Increasing Pressure (psig)	Approximate-Differential Fixed (psig)	Poles	PressureConnec-tion	NEMA 1 Enclosure	
				Lower hp	Higher hp
				Catalog No.	Catalog No.
40-100	20	2	1/4" NPSF internal	9013FHG2	9013FHG22
			3/8" NPSF internal	9013FHG3	—
			1/4" four way	9013FHG4	9013FHG24
70-150	30	2	1/4" NPT external	9013FHG9	9013FHG29
			1/4" NPSF internal	9013FHG12	9013FHG32
			3/8" NPSF internal	9013FHG13	9013FHG33
100-200	40	2	1/4" four way	9013FHG14	9013FHG34
			1/4" NPT external	9013FHG19	9013FHG39
			1/4" NPSF internal	9013FHG42	9013FHG52
			1/4" four way	9013FHG44	9013FHG54
			1/4" NPT external	9013FHG49	9013FHG59

**Table 22.74: Electrical Ratings For All 9013 Switches**

Switch Type	Voltage	Single Phase AC	Polyphase AC <sup>[4]</sup>	DC	Control Circuit Rating
FHG2, 9, 12, 13, 14, 19, 42, 43, 44, 49 FSG, FSW	115	1-1/2 hp	2 hp	1/4 hp <sup>[5]</sup>	A600
	230	2 hp	3 hp	1/4 hp <sup>[5]</sup>	
	460/575	—	1 hp	—	
FHG22, 29, 32, 33, 34, 39, 52, 54, 59 FYG, FYW	115	2 hp	3 hp	1/2 hp <sup>[6]</sup>	A600
	230	3 hp	5 hp	1/2 hp <sup>[6]</sup>	
	460/575	—	1 hp	—	
FRG One Pole (All Form H)	32	—	—	—	A300
	115	1 hp	—	1/4 hp	
	230	1 hp	—	1/4 hp	
FRG Two Pole	32	—	—	1/4 hp	A300
	115	1 hp	1 hp	1/4 hp	
	230	1 hp	1 hp	1/4 hp	
All 9013G Form H	115	1 hp	—	1/2 hp	A600
	230	2 hp	—	1/2 hp	
	460/575	2 hp	—	—	
All 9013G, except Form H	115	2 hp	3 hp	1 hp	A600
	230	3 hp	5 hp	1 hp	
	460/575	1 hp	1 hp	—	

**Ordering Information**

- Specify Class 9013 Type FHG.
- Select pressure code from the table entitled Pressure Code (fixed differential) on the left side of the page, and add the code designation to end of the Type number. Ensure that the pressure rating of the code falls within the limits of the device as shown in Table 22.72, page 22-23.
- To order special features as shown in Table 22.71, add the appropriate Form designation to the Class and Type. Arrange Forms in alphabetical order when specifying more than one feature or modification. Accessories: page 22-26



**NOTE:** If conduit or pressure line is rigid, UL; if both are flexible, UR.

[1] Some product configurations are not available—contact your Schneider Electric representative for details.  
 [2] For bulk package quantities and Form numbers, see on page 22-24. If a Form is not specified, devices will be shipped individually packaged.  
 [3] Can be field installed. Nameplate should then be marked with the Form letter and maintenance and ordering records corrected.  
 [4] See 1993 NEC Article 430-84  
 [5] DC rating does not apply to Form M4.  
 [6] 1/4 hp with Form M1.



Table 22.75: Pressure Codes [7]

Standard Action Devices		Reverse Action Devices	
Settings	Code	Settings	Code
5–21 psi	J15	10–5 psi	J36
8–20 psi	J16	22–12 psi	J22
20–40 psi	J20	22–16 psi	J19
20–50 psi	J18	35–20 psi	J70
30–50 psi	J21	40–20 psi	J23
40–60 psi	J24	50–30 psi	J35
50–70 psi	J33	150–120 psi	J64[8]
60–80 psi	J25	Specify other pressure	J99[8]
Specify other pressure	J99[8]	Specify other pressure	J99[8]

Table 22.77: Maximum Allowable Pressure for All 9013 Switches

Type	Pressure
FHG, FSG, FYG, FSW, FYW, FRG	220 psig
GHB, GHG, GSB, GSG	300 psig
GMG, GSR, GSW	100 psig
GHR, GHW	250 psig

Table 22.78: Temperature Limitations for All 9013 Switches

Operation (Media)	Storage
–36 to +125 °C (–33 °F to +257 °F)	–36 to +125 °C (–33 to +257 °F)

Ordering Information

- Specify Class 9013 Type F.
- Select the pressure code from Table 22.75, and add the code designation to the end of the Type number. Ensure that the pressure rating of the code falls within the limits of the device as shown in Table 22.76 and Table 22.79.
- To order special features from Table 22.80, add the appropriate Form letter to the Class and Type. Arrange the Form letters in alphabetical order when ordering more than one special feature.

See also:

- Electrical Ratings For All 9013 Switches, page 22-23
- Dimensions, Type F, page 22-23
- Renewal Parts for Class 9012–9038 Devices, page 22-34

Type F Pressure Switch Selection and Features

- Designed for the control of electrically driven water pumps. Diaphragm actuated.
- Type FSG is the standard water pump switch, suitable for all types of pumps: jets, submersible, reciprocating, etc.
- Type FYG is designed to meet higher horsepower and pressure requirements.
- Type FRG is reverse acting: contacts open on falling pressure.

Table 22.76: Standard Action: Contacts Open On Rising Pressure

Cut-out Range (psig)	Approximate Adjustable Differential (psig)	Cut-in Range (psig)	Pressure Connection	2 Pole	
				NEMA 1 Catalog No.	NEMA 3R[9]
20–65	15–30	5–45	1/4" NPSF internal	9013FSG2	9013FSW2
			1/4" NPT external	9013FSG9	9013FSW9
			1/4" bayonet (barbed)	9013FSG10	9013FSW10
20–50	10–30	10–30	1/4" NPSF internal	9013FSG22	9013FSW22
20–60	10–30	10–45	1/4" NPT external	9013FSG29	9013FSW29
9–30	6–20	3–10	1/4" NPSF internal	9013FSG42	9013FSW42
9–30	6–20	3–10	1/4" NPT external	9013FSG49	9013FSW49
25–80	20–30	5–60	1/4" NPSF internal	9013FSG52	—
			1/4" NPT external	9013FSG59	—
34–65	15–30	19–45	(FSG1 through 20 with Form M4 is only available in this range)		
25–80	20–30	5–60	1/4" NPSF internal	9013FYG2	9013FYW2
			1/4" NPT external	9013FYG9	9013FYW9
			1/4" bayonet (barbed)	9013FYG10	9013FYW10
39–80	20–30	19–60	(FYG1 through 20 with Form M4 is only available in this range)		
20–50	10–30	10–30	1/4" NPSF internal	9013FYG22	9013FYW22
20–60	10–30	10–45	1/4" NPT external	9013FYG29	9013FYW29
9–40	6–30	3–10	1/4" NPSF internal	9013FYG42	9013FYW42
9–40	6–30	3–10	1/4" NPT external	9013FYG49	9013FYW49

Table 22.79: Reverse Action: Contacts Open On Falling Pressure

Cut-in Range (psig)	Approximate Adjustable Differential (psig)	Cut-out Range (psig)	Pressure Connection	Catalog Number	
				1-Pole	2-Pole
23–65	15–30	8–45	1/4" NPSF internal	9013FRG12	9013FRG2
			3/8" NPSF internal	9013FRG13	9013FRG3
			1/4" NPT external	9013FRG19	9013FRG9
10–45	6–20	4–25	1/4" NPSF internal	9013FRG32	9013FRG22
			3/8" NPSF internal	9013FRG33	9013FRG23
			1/4" NPT external	9013FRG39	9013FRG29
6–14	5, Fixed	1–9	1/4" NPSF internal	9013FRG52	9013FRG42
			3/8" NPSF internal	9013FRG53	9013FRG43
40–100	20–30	20–80	1/4" NPT external	9013FRG59	9013FRG49
			1/4" NPSF internal	9013FRG72	9013FRG62
			3/8" NPSF internal	9013FRG73	9013FRG63
65–150	30–45	35–120	1/4" NPSF internal	9013FRG92	9013FRG82
			3/8" NPSF internal	9013FRG93	9013FRG83
			1/4" NPT external	9013FRG99	9013FRG89

[7] Existence of a code does not imply that the code is available for any or all devices.

[8] Minimum order quantity is 4 pieces.

[9] Must be mounted in vertical position to maintain enclosure rating.



File E12158 CCN NKPZ



File LR25490

**NOTE:** Products on this page are UL Listed, however type numbers ending in 8, 10 or 20 (non rigid pressure lines) must have Form T or TI—otherwise these are UL component recognized.

**Table 22.80: Special Features and Modifications for Type FSG, FYG & FRG Devices**

[10]

Description	Applies to Types	Form
Bulk package	All Type F	[11]
One normally open—one normally closed contact	FRG 2-Pole only	H
Maintained manual cut-out lever (Auto-Off)	FSG, FYG	M1
Momentary manual cut-in lever (Auto-Start)	FRG2-59 only	M3
Low pressure cut-off (Auto-Start-Off) – Operates at approximately 10 psig below cut-in and will turn off the pump	FSG, FYG	M4
Maintained manual cut-in lever (Auto-On)	FRG2-59 only	M5
Pulsation plug (Type 2 & 9 only)	FRG, FSG, FYG	P [12]
Plastic flange (max. temp. 120 °F) (max. pressure 80 psi) Available only on Types FSG2, FYG2, FRG2, FSG*2, FYG*2, FRG*2	FSG*, FYG*, FRG* 1/4" NPSF internal only	Q8
1/2" conduit bushing, 1/2" long thread—on left	All Type F	T
Slip-on connectors (load side terminals <i>only</i> )	FSG, FYG	U
Slip-on connectors (line <i>and</i> load terminals)	FSG, FYG	U2
Black cover	FSG, FYG	Z22

**Table 22.81: Bulk Package Form Numbers for 9013F Pressure Switches**

Description	Bulk Package Quantity					
	16	20	40	50	400	500
Product without Forms M1, M3, M4, M5, T, X1	9013FHG (without 1/4" four-way)	—	C20	—	C50	—
	9013FHG4, 14, 24, 34, 44, 54 (with 1/4" four-way)	—	C20	—	C50	C400
	9013FRG	—	C20	—	C50	—
	9013FSG	—	C20	—	C50	—
	9013FYG	—	C20	—	C50	—
Product with Forms M1, M3, M4, M5	9013FHG (without 1/4" four-way)	—	C20	C40	—	—
	9013FHG4, 14, 24, 34, 44, 54 (with 1/4" four-way)	—	C20	C40	—	—
	9013FRG	—	C20	C40	—	—
	9013FSG	—	C20	C40	—	—
	9013FYG	—	C20	C40	—	—
Product with Forms T, X1	9013FHG (without 1/4" four-way)	C16	—	C40	—	—
	9013FHG4, 14, 24, 34, 44, 54 (with 1/4" four-way)	C16	—	C40	—	—
	9013FRG	C16	—	C40	—	—
	9013FSG	C16	—	C40	—	—
	9013FYG	C16	—	C40	—	—
9013FHG9 Special with Extended Flange	C16	—	—	—	—	C500

[10] Some product configurations are not available—contact your Schneider Electric representative for details.

[11] For bulk package quantities and Form numbers, see on page 22-24. If a Form is not specified, devices will be shipped individually packaged.

[12] Nylon pulsation plug can be field installed on types having 1/4" NPSF internal connector. Part number 1530S6G1 is one bag of 50 plugs.



Shown with Form X



File E12158  
CCN NKPZ  
File E12443 Haz Loc  
CCN NOWT



File 25490  
File 26817  
Haz. Loc.

**Table 22.82: Pressure Codes**

Code	Pressure Setting (Close-Open), psi
J20	20–40
J21	30–50
J23	40–20 (reverse action)
J24	40–60
J25	60–80
J26	70–90
J28	70–100
J29	75–100
J30	80–100
J31	90–120
J50	135–175
J51	100–80 (reverse action)
J53	100–125
J54	110–125
J56	110–150
J57	120–150
J58	125–150
J60	125–175
J61	130–175
J62	140–175
J63	145–175
J64	150–120 (reverse action)
J65	215–250
J99	Specify the required setting

**Table 22.83: Special Features and Modifications**

Description	Form
3-Way Lever (On-Auto-Off)	E
One Normally Open / One Normally Closed Contact	H
Pulsation Plug	P
Reverse Action	R
Slip-On Connectors (Load Side Terminals Only)	U
Slip-On Connectors (Line and Load Terminals)	U2
Two-Way Pressure Release Valve	X
1/4" Male Pipe Thread on Pressure Connection	Z
1/2"-14 NPT External, 1/4"-18 NPT Internal	Z16

**Type G Pressure Switch Selection and Features**

Class 9013 Type G Pumptrol pressure switches are designed to control electrically driven water pumps and air compressors. These devices cover higher electrical ratings for directly controlling motors in pump and compressor applications.

- Contacts open on pressure rise.
- Diaphragm actuated.
- For electrical ratings, see [Table 22.74](#).  
For repair parts kits, see [page 22-34](#).

**Table 22.84: Selection Tables**

Cut-out Range (psig)	Approximate Adjustable Differential (psig)	Cut-in Range (psig)	Enclosure	Poles	NPSF Internal Pressure Connection	Catalog No.
10–35	4–8	5.5–30.5	NEMA 1 (General Purpose)	2	1/4	9013GMG2
20–80	15–30	5–60	NEMA 3R [13] (Rainproof)	2	1/4	9013GSB2
20–80	15–30	5–60	NEMA 1 (General Purpose)	2	1/8	9013GSG1
					1/4	9013GSG2
					3/8	9013GSG3
20–80	20–40	5–50	NEMA 7 & 9 (Hazardous Locations)	2	1/8	9013GSR1
					1/4	9013GSR2
			NEMA 4 (Watertight)		3/8	9013GSR3
					1/8	9013GSW1
					1/4	9013GSW2
65–200	20–40	40–170	NEMA 3R [13] (Rainproof)	2	1/4	9013GHB2
65–200	20–40	40–170	NEMA 1 (General Purpose)	2	1/8	9013GHG1
					1/4	9013GHG2
					3/8	9013GHG3
65–200	30–50	35–150	NEMA 7 & 9 (Hazardous Locations)	2	1/8	9013GHR1
					1/4	9013GHR2
			NEMA 4 (Watertight)		3/8	9013GHR3
					1/8	9013GHW1
					1/4	9013GHW2
80–250	25–45	32–215	NEMA 3R [13] (Rainproof)	2	1/4	9013GHB5
80–250	24–45	32–215	NEMA 1 (General Purpose)	2	1/8	9013GHG4
					1/4	9013GHG5
					3/8	9013GHG6
80–250	40–60	30–190	NEMA 7 & 9 (Hazardous Locations)	2	1/8	9013GHR4
					1/4	9013GHR5
			NEMA 4 (Watertight)		3/8	9013GHR6
					1/8	9013GHW4
					1/4	9013GHW5
					3/8	9013GHW6

**NOTE:** Some product configurations are not available. Contact your Schneider Electric representative for details.

**Ordering Information**

- Specify Class 9013 Type G.
- Select the pressure code from [Table 22.82](#), and add the code to the end of the Type number. Ensure that the pressure rating of the code falls within the limits of the device. See [Table 22.84](#).
- To order special features, add the appropriate Form letter to the Class and Type. Arrange Form letters in alphabetical order when ordering more than one special feature.

[13] Must be mounted in vertical position to maintain enclosure rating.

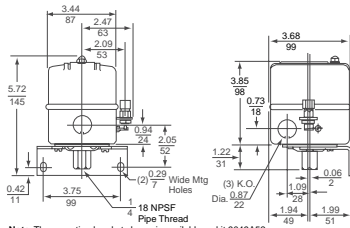

Note: The mounting bracket shown is available as kit 9049A52.

**9013GHG, GSG - with or without Form X**

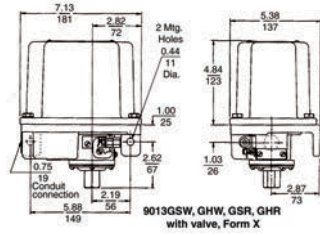

**9013GSW, GHW, GSR, GHR with valve, Form X**

**Table 22.85: Special Features and Modifications for Type G Devices [14]**

Description	Applies to	Form
Standard pack of 10 switches[15]	All Type G	C10
3-way lever (On-Auto-Off) (not compatible with Form X)	GHG, GMG, GSG	E
1 N.O., 1 N.C. contact	All Type G	H
Pulsation plug (not field replaceable.)	All Type G	P
Reverse action (Select pressure code from Table 22.79)	All Type G	R
Slip-on connectors (load side terminals only)	All Type G	U
Slip-on connectors (line and load terminals)	All Type G	U2
Two-way pressure release valve (Not compatible with Form E)	GHB, GMG, GSB, GHG, GSG GHR, GHW, GSR, GSW	X
1/4" male pipe thread on pressure connection	All Type G	Z
1/2"-14 NPT external 1/4"-18 NPT internal[16]	All Type G	Z16

**Table 22.86: Class 9049 Accessories for Class 9013 Pressure Switches**

Description	Applies to Class	Catalog No.
Two-way pressure release valve, replacement only. Cannot be added to switch that originally had no valve.	9013GHG, GSG, Form X only	9049A12
Mtg. bracket—replacing obsolete 9013A with 9013G	9013GHG, GSG	9049A52
Mtg. bracket—replacing obsolete 9013A with 9013G, or for current 9016GVG	9013GMG, 9016GVG	9049A53
Two-way pressure release valve. Replacement only. Cannot be added to switch that originally had no valve.	9013FHG, Form X only	9049A56

[14] Some product configurations are not available—contact your Schneider Electric representative for details.  
[15] Available on GHB, GHG, GSB, and GSG.  
If Form C10 is not specified, devices will be shipped individually packaged  
[16] UL Listed industrial control equipment.



Type DG2



File No. E12158  
File No. E12443  
Haz Loc



Type GG



File LR25490  
File LR26817  
Haz Loc

Open Tank or Sump Applications

Ambient temperature ratings: Min. -30 °C (-22 °F); Max. +105 °C (+220 °F).

For accessories, refer to page 22-34.

Table 22.87: Class 9036, 2-Pole, Single Lever Operated

Contact Operation	NEMA 1	NEMA 4	NEMA 7, 9
	Catalog No.	Catalog No.	Catalog No.
Close on liquid rise	9036DG2	9036DW31	9036DR31
Open on liquid rise	9036DG2R	9036DW31R	9036DR31R
Close on liquid rise	9036GG2	9036GW1	9036GR1
Open on liquid rise	9036GG2R	9036GW1R	9036GR1R

Order the universal mounting bracket and float accessory kits separately from the Class 9049 Accessories section on page 22-34. Types GW and GR use a center-hole float. Devices with Form C use a center-hole float. All others use a tapped-at-top float.

Table 22.88: Modifications [1]

Description	Factory Installed	Field Installed
	Form	Class 9049 Kit
Types DG, DW, DR		
Reverse action (Type DG)	R	9049A58
Compensating spring (Type DG)	C	9049A19
Compensating spring (Type DR, DW)	C	9049A20
Compensating spring and reverse action	CR	Not available
Types GG, GW, GR		
Compensating spring for Type GG2	C	9049A13
Combination of compensating spring and reverse action (Type GG2)	CR	9049A13
1 N.O., 1 N.C. contact configuration	H	Not available
Combination of comp. spring & 1 N.O., 1 N.C. contact for Type GG2	CH	Not available
Reverse action (Type GR, GW)	R	Not available

Table 22.89: Class 9049 Float Accessory Specifications (oz)

Item	Type A6	Type A6S	Type A6C	Type A6CS	Type A6A	Type A6CA
Net buoyancy [2] (in water) 7" float	60 [3]	60 [3]	70 [3]	70 [3]	60 [3]	70 [3]
Weight of 5 ft rod	18.5	16.9	18.5	16.9	6	6
Weight of extra ft of rod (per ft)	3.7	3.4	3.7	3.4	1.2	1.2
Total weight of stops	3 (2 stops)	3 (2 stops)	6 (4 stops)	6 (4 stops)	3 (2 stops)	6 (4 stops)

[1] Some product configurations are not available—contact your Schneider Electric representative for details.

[2] Buoyancy data is calculated for use in water. Consult factory for buoyancy data in media with a different specific gravity than water.

**When ordering float accessories**, first specify the desired float accessory package, such as 9049A6 or 9049A6CS, then as a second item give the number of additional rod kits required.

For example, for a 9049A6 with 15 ft of rod, order as follows:

Item A = 9049A6, quantity = 1; Item B = 9049T1, quantity = 4.

[3] Net buoyancy of float has been calculated with float 80% submerged, thus allowing 20% factor of safety.

**Table 22.90: Maximum Forces at Which Switches Are Tested (oz)**

Type	Force Up To Trip	Force Down To Trip	Weight Supported with Compensating Spring	Type (with or without Form H)	Lever Length Position	Force Up to Trip	Force Down to Trip	Weight Supported with Compensating Spring at Max. Adjustment (oz)
DG2	9	8	60	GG2	Short	33	39	[4]
DG2 Form R	8	8	60	GG2	Long	21	27	100
DW31	8	8	66	GG2 Form R	Short	30	24	[4]
DW31 Form R	8	8	66	GG2 Form R	Long	22	16	150
DR31	8	8	66	GR1, GW1	Short	24	31	80
DR31 Form R	8	8	66	GR1, GW1	Medium	22	29	72
				GR1, GW1	Long	20	27	64

**Type DG Dimensions**

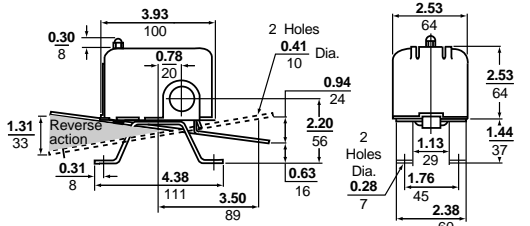

Float lever travel between closing and opening of contacts: short = 1 in. (25 mm), medium = 1.12 (28 mm), long = 1.25 in. (31.8)

**Type GG Dimensions**

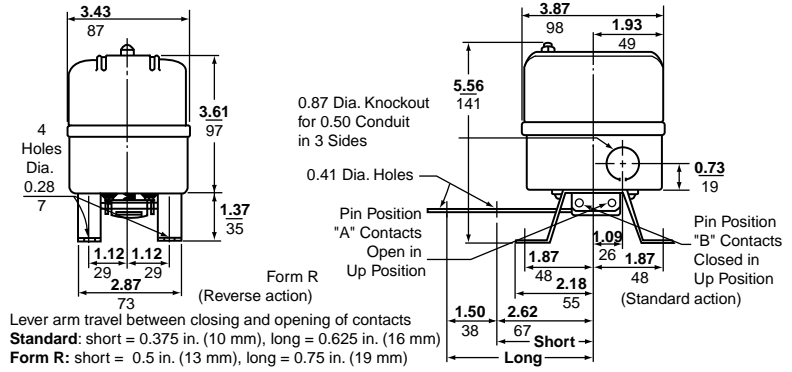

Lever arm travel between closing and opening of contacts  
**Standard:** short = 0.375 in. (10 mm), long = 0.625 in. (16 mm)  
**Form R:** short = 0.5 in. (13 mm), long = 0.75 in. (19 mm)  
 For Type GR/GW dimensions, see catalog 9034CT9701.

For Type DR/DW dimensions, see catalog 9034CT9701.

**Table 22.91: Electrical Ratings for All Float Switches**

Applies to Class and Type	Control Circuit	Single Phase AC			Polyphase AC [5]			DC		
		115 V	230 V	460/ 575 V	115 V	230 V	460/ 575 V	32 V	115 V	230 V
9036DG, DR, DW (2-pole), FG	A600	2 hp	3 hp	—	3 hp	5 hp	1 hp	1/4 hp	1/2 hp	1/2 hp
9036GG, GR, GW (2-pole)	A600	2 hp	3 hp	5 hp	3 hp	5 hp	5 hp	1/2 hp	1 hp	1 hp
9036G Form H (1 N.O., 1 N.C.)	A300	1 hp	2 hp	2 hp	—	—	—	—	1/2 hp	1/2 hp
9037EG, ER, EW; HG, HR, HW (2-pole)	A600	2 hp	3 hp	—	3 hp	5 hp	1 hp	1/4 hp	1/2 hp	1/2 hp
9038 All Devices (2-pole)	A600	2 hp	3 hp	—	3 hp	5 hp	1 hp	1/4 hp	1/2 hp	1/2 hp

**Open Tank or Sump Applications, Float Switch, Class 9036 Type FG**

The Class 9036 Type FG30 pedestal style float switch is designed for liquid level control with electric motor operated pumps either directly or through a magnetic starter. It can also be used to activate alarms in liquid level control systems. The upward or downward movement of the lever arm of the Class 9036 Type FG30 float switch controls the On and Off positions corresponding to the water level changes required to turn the pump or alarm on and off.

Ambient temperature ratings: Min. -30 °C (-22 °F); Max. +105 °C (+220 °F)



9036FG, 9049A60, and 9049A61

**Table 22.92: Type FG Float Switch and Accessories**

Description	Catalog Number
2-pole, NEMA 1, contacts close on liquid rise	9036FG30
Plastic center hole float (1 required)	9049A60
33.75 inch aluminum rod, 2 float stop assemblies and attaching hardware (1 required)	9049A61

[4] Compensating spring not effective in combination with Short lever length position.  
 [5] See 1993 NEC Article 430-84

Refer to Catalog 9034CT9701



9037EG with 9049ER3 Rod Kit and 9049EF1 Float

**Closed Tank, Class 9037 Type E**

Type E switches are flange mounted and float movement is transmitted through a Quad-Ring® seal.

Build up the switch to meet your exact requirements from the **basic switch, float rod, and float** groups below. Switch may be assembled in the field to give contacts that open on liquid rise or close on liquid rise. Consult Schneider Electric for use in media with a different specific gravity than water.

Ambient temperature ratings: Min. -30 °C (-22 °F); Max. +105 °C (+220 °F)

**Table 22.93: Class 9037 Type E**

Application	Post Length L (in.)	NEMA 1	NEMA 4	NEMA 7 & 9
		Catalog No.	Catalog No.	Catalog No.
For minimum water level change	2-5/8	9037EG8	9037EW8	9037ER8
	4-11/16	9037EG10	—	—
For maximum water level change	2-5/8	9037EG9	9037EW9	9037ER9
	4-11/16	9037EG13	9037EW13	—

**Table 22.94: Class 9049 Floats for Type E Switches**

Description	Catalog No.
#304 stainless steel	9049EF1
#316 stainless steel	9049EF2

**Table 22.95: Class 9049 Float Rod Kits**

Catalog No.	A (in.)	F (in.)	R (in.)	H (in.)
9049ER1	1.00	4.75	1.75	8.25
9049ER2	1.00	4.75	2.5	9.00
9049ER3	1.00	4.75	3.50	9.50
9049ER5	1.00	4.75	5.25	11.75
9049ER7	1.00	5.00	7.25	13.75
9049ER12	1.00	5.75	12.25	18.75

UL File No. E12158 and E12443 Haz Loc  
 SF File 25490 except Types ER8, ER9

**Type EG Dimensions, in. (mm)**  
 For 9037ER/EW dimensions and rod positions, see catalog 9034CT9701

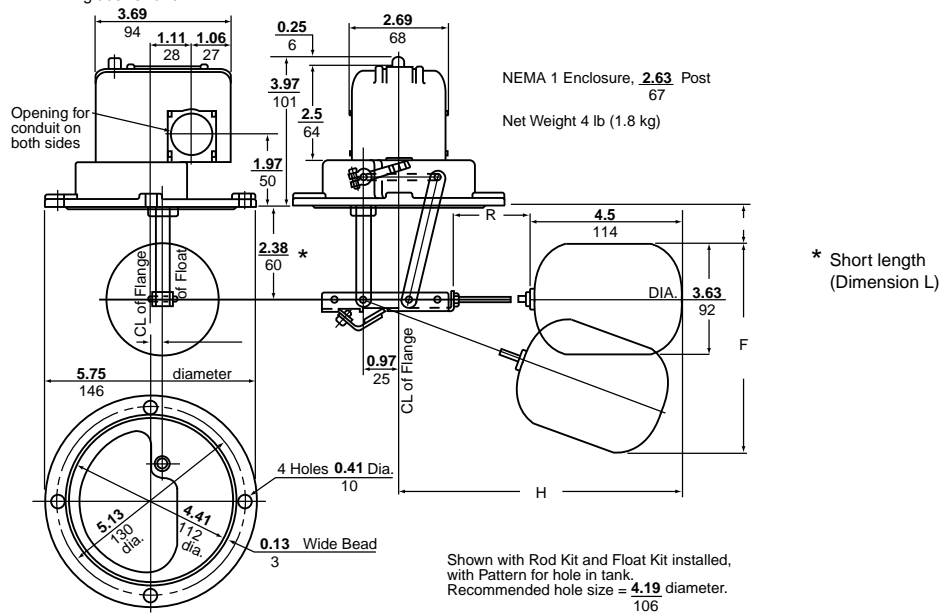



Type H Switches

Type H switches are attached to the tank by means of a 2-1/2 in. screw-in bushing. An external pointer indicates the float position within the tank when the unit is mounted. Switches come complete with stainless steel float and rod. A Buna N Quad-Ring® seal is used between the float rod and sealing connector. Normal application is at atmospheric pressure, but where higher pressures are encountered, the switch will withstand tank pressures up to 50 psi at temperatures up to +220 °F. Occasional replacement of the Quad-Ring seal may be necessary. Ambient temperature ratings: Min. -30 °C (-22 °F); Max. +105 °C (+220 °F)



Type HG35  
Float on Right, 90° Offset Rod



File No. E12158 and  
E12443 Haz Loc



File LR25490,  
File LR26817 Haz Loc

Table 22.96: Class 9037 Type H Contacts Close On Liquid Rise

Float Position (viewed from front of switch, facing indicator scale)	Float Rod Angle	Approximate Water Level Change (Field Adjustable)		NEMA 1	NEMA 4	NEMA 7 & 9
		Min. (in.)	Max. (in.)	Catalog No.	Catalog No.	Catalog No.
Right	45°	2	5	9037HG33	9037HW33	9037HR33
			5	9037HG35	9037HW35	9037HR35
	90° Offset	2	7	9037HG37	9037HW37	9037HR37
			8-1/4	9037HG39	9037HW39	—
Left	45°	2	5	9037HG34	9037HW34	9037HR34
			5	9037HG36	9037HW36	9037HR36
	90° Offset	2	7	9037HG38	—	9037HR38
			8-1/4	9037HG30	9037HW30	9037HR30
			11-1/2	9037HG32	9037HW32	9037HR32
			11-1/2	9037HG32	9037HW32	9037HR32

NOTE: For replacement floats, see Class 9049 Type H on page 22-34. Types shaded in gray are available with Form Z19; see Table 22.98 on page 22-31. See Accessories and Renewal Parts on page 22-34.

Table 22.97: Type H Float Travel Distances

Float Rod Angle	R in. (mm)	H [6] in. (mm)	f1 in. (mm)		f2 in. (mm)		F in. (mm)	
			Minimum	Maximum	Minimum	Maximum	Minimum	Maximum
45°	—	6.22 (158)	2.25 (57)	4.50 (114)	2.00 (52)	4.50 (110)	4.25 (108)	9.00 (229)
	3.00 (76)	4.25 (108)	2.75 (70)	4.25 (108)	2.25 (57)	4.25 (108)	5.00 (127)	7.50 (191)
90° offset	4.25 (108)	5.50 (140)	3.50 (89)	5.50 (140)	2.75 (70)	4.00 (102)	6.25 (159)	9.50 (241)
	5.00 (127)	6.25 (159)	3.75 (95)	6.25 (159)	3.00 (76)	4.50 (110)	6.75 (171)	10.75 (273)
	7.00 (178)	8.25 (210)	4.75 (121)	8.25 (210)	3.75 (95)	5.75 (146)	8.50 (216)	14.00 (356)

Table 22.98: Available Modifications For Class 9037 Type H [7]

Description	Form
Omit 2-1/2" tank connecting bushing	F3
Omit float	L
Reverse action, contacts open on rise	R
Viton® packing: 5 oz. float (diesel fuel) for Types shaded in gray in Table 22.96 above.	Z19
Viton packing (suitable for applications up to +250 °F)	Z20
#316 stainless steel float and Viton packing	Z21

Type HG—45° Angle Dimensions

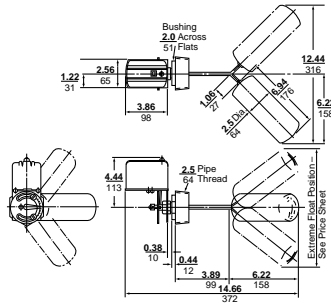

Type HG—90° Offset Dimensions

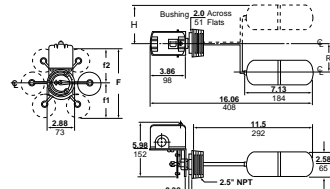

Type HR/HW—45° Angle Dimensions

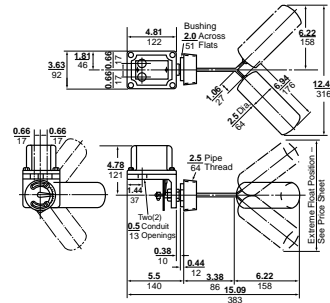

Type HR/HW—90° Offset Dimensions

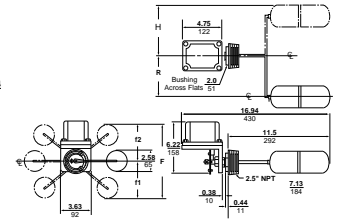

[6] Clearance from the centerline of the hub to the side of the tank.

[7] Some product configurations are not available—contact your Schneider Electric representative for details.



Type AG1 Mechanical Alternator, Float Operated

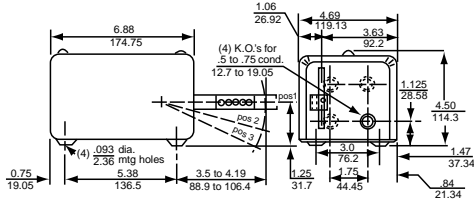

Type A Dimensions, in. (mm)



File No. E12158  
excludes NEMA 7 & 9 products  
(9038AR, CR, and DR)



File LR25490  
excludes NEMA 7 & 9 products  
(9038AR, CR, and DR)

### Type A, Open Tank

Alternators are designed to provide motor alternation in the operation of two motors.

Table 22.99: Class 9038 Type A

Application	Description	NEMA 1 Catalog No.	NEMA 4 Catalog No.	NEMA 7 and 9 Catalog No.
For open tank or sump systems using duplex pumps	Mechanical alternator float operated	9038AG1	9038AW1	9038AR1

**NOTE:** For use with Class 9049 float accessories listed on page 22-34. Type AW and AR alternators **must** use center hole floats.

Table 22.100: Operating Forces—Types AG, AR and AW

Type	Without Compensating Spring (No Form C)		With Compensating Spring (Form C)			
	Force Up [8]	Force Down	Maximum Weight of Rod and Stops Supported		Length of Rod Supported at the Maximum Adjustment	
			Note: AW1 and AR1 have compensating spring standard.	Brass [9]	Stainless Steel [9]	Aluminum [9]
AG1 (min. lever ext.)	18 oz	20 oz	47 oz.	10 ft	12 ft	25 ft
AG1 (max. lever ext.)	16	17	41	8	10	21
AG1 Form R (min. lever ext.)	14	16	33	7	8	17
AG1 Form R (max. lever ext.)	11	12	30	6	7	15
AR1, AW1 (standard lever)	—	—	74	16	20	41
AR1, Form R, AW1 Form R (std. lever)	—	—	85	19	23	47

### Type C, Closed Tank, with Bushing

Flange mounted with bushing for control of liquid level within a closed tank. Build up the switch to meet your requirements from the basic switch, rod kit, and float kit groups below.

Type C switches are attached to the tank by means of a 2-1/2 in. screw-in bushing. An external pointer indicates the float position within the tank when the unit is mounted. Switches come complete with screw-in connector, stainless steel float and rod.



Type CG36 Float on left

Table 22.101: Class 9038 Type C

Float Position Viewed from Front of Switch Facing Indicator Scale	R in. (mm)	Approx. Water Level Change		NEMA Type 1	NEMA Type 4	NEMA Type 7, 9
		Min. (in.)	Max. (in.)	Catalog No.	Catalog No.	Catalog No.
Right	7 (178)	6.5 (165)	13 (330)	9038CG31	9038CW31	9038CR31
Left	7 (178)	6.5 (165)	13 (330)	9038CG32	9038CW32	9038CR32
Right	4.25 (108)	4 (102)	7.75 (197)	9038CG33	9038CW33	9038CR33
Left	4.25 (108)	4 (102)	7.75 (197)	9038CG34	9038CW34	9038CR34
Right	5 (127)	4.75 (121)	9.25 (235)	9038CG35	—	—
Left	5 (127)	4.75 (121)	9.25 (235)	9038CG36	9038CW36	9038CR36

Table 22.102: Type C Float Travel Adjustments

R in. (mm)	A in. (mm)		B in. (mm)		C in. (mm)		D in. (mm)		F in. (mm)	
	Min.	Max.	Min.	Max.	Min.	Max.	Min.	Max.	Min.	Max.
7 (178) [10]	2.5 (64)	5 (127)	5 (127)	7 (178)	2 (51)	4 (102)	5 (152)	7 (178)	10 (254)	14 (495)
5 (127) [11]	2.25 (57)	3.75 (95)	4 (102)	5.25 (133)	2.75 (70)	3 (76)	4 (102)	5.25 (133)	8 (203)	10.5 (267)
4.25 (108) [12]	2 (51)	3.5 (89)	3.5 (89)	4.75 (121)	2.5 (64)	3.75 (95)	3.5 (89)	4.75 (121)	7 (178)	9.5 (241)

Type A Dimensions, in. (mm)

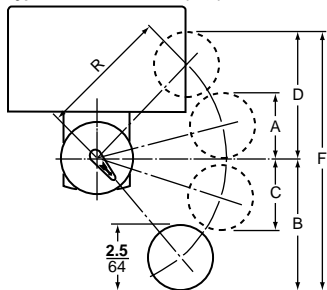

Replacement Float: 9049HF page 22-28

Type CG Dimensions

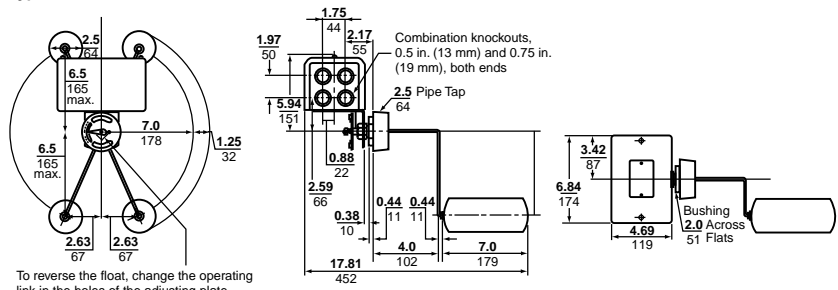

To reverse the float, change the operating link in the holes of the adjusting plate.

[8] Add 2 oz for Form N5 High Water alarm.

[9] Rod length has been determined using the weight of the rod material furnished on Class 9049 accessories (3/8" O.D. tubing). Other types of rod should be weighed and compared to the Maximum Weight of Rod column in Table 22.100.

[10] CG31, CG32, CW31, CW32, CR31, CR32

[11] CG35, CG36, CW35, CW36, CR35, CR36

[12] CG33, CG34, CW33, CW34, CR33, CR34



Type DG Shown with Rod Kit 9049ER5 and Float Kit 9049HF3 Installed.



File No. E12158,  
excludes NEMA 7 & 9 products  
(9038AR, CR, and DR)



File LR25490,  
excludes NEMA 7 & 9 products  
(9038AR, CR, and DR)

**Type D, Closed Tank, Top Mounted**

Designed for applications where mounting is to be made at the top of a closed tank.

**Table 22.103: Class 9038 Type D Contacts Close On Liquid Rise**

Water Level Change	Hinge Post Dimension "V" (in.)	NEMA 1	NEMA 4	NEMA 7 and 9
		Cat. No.	Cat. No.	Catalog No.
Min.	2-5/8	9038DG7	9038DW7	—
Max.		9038DG8	9038DW8	9038DR8
Min.	4-11/16	9038DG9	—	—
Max.		9038DG10	—	—

**Float Kits, For Use with Type D Switches**

Size and Material Diameter x Length (in.)	Catalog No.
3.625 x 4.50, #304 stainless steel	9049EF1
3.625 x 4.50, #316 stainless steel	9049EF2
2.50 x 7, #304 stainless steel	9049HF3
2.50 x 7, #316 stainless steel	9049HF4

**Float Rod Kit, Class 9049**

Catalog No.	R (in.)	H (in.)	G (in.)	F (in.)
9049ER1	1.75	8.25	3.25	8.75
9049ER2	2.50	9.00	3.50	10.50
9049ER3	3.25	9.50	3.50	11.00
9049ER5	5.25	11.75	3.75	12.75
9049ER7	7.25	13.75	4.00	14.50
9049ER12	12.25	18.75	4.75	19.00

**Table 22.104: Available Modifications for All Mechanical Alternators [13]**

Description	Form
Compensating spring (Type AG)	C
Omit 2-1/2 in. connecting bushing (Type CG, CR, CW)	F3
Omit float (Type CG, CR, CW)	L
Two-level non-alternating unit	N4
Addition of a third, high-water alarm circuit (Type AG, AR, AW, CG, DG only)	N5
High-water alarm circuit, 2-pole (Type CG only)	N25
Reverse action (contacts open on Rise)	R
Viton® packing, 5 oz. float (diesel fuel) (Type CG)	Z19
Viton packing (Type CG, CR, CW)	Z20
#316 stainless steel float and Viton packing (Type CG, CR, CW)	Z21

**Type DG Dimensions, in. (mm)**

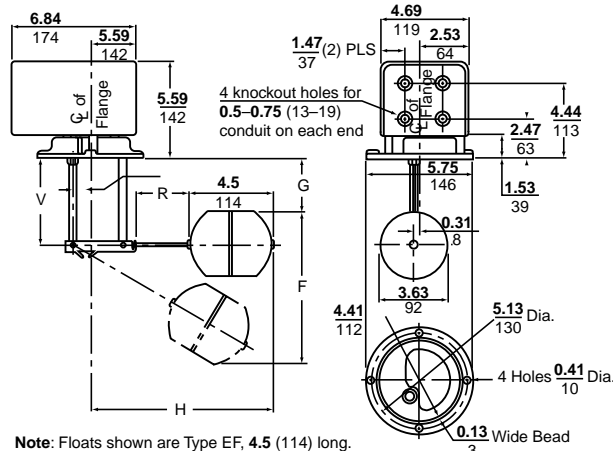

**Note:** Floats shown are Type EF, 4.5 (114) long. The recommended size of the hole in the tank for the entry of the float and the mounting of the control is 4.19 (106). Add 2.5 (64) to "H" if using Type HF Floats, which are 7.0 (178) long.

**Table 22.105: Temperature Ratings for Class 9038**

Description	Rating	
Ambient Temperature	-22 to 200 °F (-30 to 93 °C)	
Media	Buna-N Seal	Up to 215 °F (102 °C)
	Viton® Seal	Up to 250 °F (121 °C)

[13] Some product configurations are not available—contact your Schneider Electric representative for details.

Accessories for Float Switches

Table 22.106: Class 9049 Accessories for Float Switches

Description		Applies to Class	Catalog Number
Compensating Spring		9036GG	9049A13
		9038AG	9049A15
		9036DR, DW	9049A20
Float	Dia. 3.62 in. (92 mm), length 4.5 in. (114 mm)	#304 stainless steel	9037E, 9038D
		#316 stainless steel	9037E, 9038D
	Dia. 2.5 in. (64 mm), length 7 in. (178 mm)	#304 stainless steel	9037H, 9038C
		#316 stainless steel	9037H, 9038C
Float Kit	7 in. tapped-at-top #304 stainless steel float, 5 ft rod, 2 stops	Brass rod	All 9036, 9038A
		Aluminum rod	All 9036, 9038A
	7 in. center-hole #304 stainless steel float, 5 ft rod, 4 stops	Brass rod	All 9036, 9038A
		Aluminum rod	All 9036, 9038A
	7 in. center-hole #316 stainless steel float, 5 ft stainless steel rod, 4 stainless steel stops	All 9036, 9038A	9049A6CA
	7 in. tapped-at-top #316 stainless steel float, 5 ft stainless steel rod, 2 stainless steel stops	All 9036, 9038A	9049A6S
Replacement float—7 in. round center-hole #304 stainless steel	9049A6C, A6CA	9049AF1	
Lever	Form R	9036DG	9049A58
	Replacing obsolete 9036A with 9036G	9036GG	9049A54
Mounting Bracket	Replacing 9036A (S or F1) with 9036G	9036GG	9049A55
	Universal	All 9036, 9038AG, AR, AW	9049UMS1
Rod	Stainless steel	1-3/4 in. long	9037E, 9038D
		2-1/2 in. long	9037E, 9038D
		3-1/4 in. long	9037E, 9038D
		5-1/4 in. long	9037E, 9038D
		7-1/4 in. long	9037E, 9038D
		12-1/4 in. long	9037E, 9038D
Rod Kit	Additional 2-1/2 ft section with connector	Brass rod	9049A6, A6C
		Aluminum rod	9049A6A, A6CA
		Stainless steel rod	9049A6S, A6CS

Renewal Parts for Class 9012–9038 Devices

Renewal parts are generally available for Pump Control Products with a numerical date code—for example, 172 (first quarter, 1972)—or a current date code. Parts are no longer available for devices manufactured before 1965.

Table 22.107: Class 9998 Renewal Parts Kits for Class 9012–9038 Devices

Description / Equipment To Be Serviced	Catalog Number
Actuator Assembly	9012GA, GD, GG, GK, GN, GR 5, 25, 55 Series C only
	9012GA, GD, GG, GK, GN, GR 6, 26, 36, 46, 56 Series C only
	9012GB, GE, GH1, 21, 31, 41, 51; GL, GP, GS1
	9012GB, GE, GH2, 22, 32, 42, 52; GL, GP, GS2
Contact Kit (2-Pole Contacts)	9013FHG2, 29, 32, 39, 52, 59; 9013 FYG; 9036DG, DR, DW; 9037EG, ER, EW, HG, HR, HW30–39; 9038 All Types (2 Kits Required); obsolete 9013HHGY, HSGY; HSWY; 9037HEG, HSG3, 4; 9035DG10, DW10 (This kit also contains a replacement diaphragm for pressure switches. The diaphragm fits pressure switch only.)
	9013GHG, GSG, GHR, GSR, GMG; 9036GG, GR, GW; 9037GG Series C All except Forms H & R; 9016GVG, Form R
	9013GHG, GSG, GSR, GMG; 9036GG, GR, GW; 9037GG, GR, GW Series C Form H only; 9016GVG, Form H
	9013GHG, GSG, GHR, GSR, GMG; 9036GR, GW: Series C Form R only; 9016GVG
Contact Replacement Kit	9013FHG2 thru 19, 42 thru 49, all FSG (Complete contact replacement kit—includes new diaphragm)
	9012GA, GD, GN, GR1, 21 Series C only
Diaphragm Assembly	9012GA, GD, GG, GK, GN, GR 2, 3, 22, 52 Series C only
	9012GA, GD, GG, GK, GN, GR4, 24, 54 Series C only
	Convolute diaphragm assembly for 9013GHG, GSG: Series C
	9013GHW, GSW; and GSW, GHR: Series C
Gasket Kit	9016 GAW-1, 21
Pilot Light, 24 Vdc	Contains all replaceable gaskets for all 9012 open, NEMA 1, 4, 4X, 13 devices
Piston Assembly	9012GA, GD, GN, GR1, 21 Series C only
	9012GC, GF, GJ, GQ, GT1, 21, 31, 41, 51 Series C only
	9012GC, GF, GJ, GQ, GT2, 22, 32, 42, 52 Series C only
Seal Kit	9012GC, GF, GQ, GT4, 24, 34, 44, 54 Series C only
	Buna N, for Series A devices: 9037HG/HW/HR30–39; 9038CG/CW/CR31–36
Seal Tube Kit	Fluorocarbon, for Series A devices with Form Z19 or Z20: 9037HG/HW/HR30–39; 9038CG/CW/CR31–36
	Fluorocarbon, for 9037E and 9038D
Snap Switch	Fluorocarbon Quad-Ring, for Series C devices: 9037HG/HW/HR3–12; 9038CG/CW/CR1–6
	Fluorocarbon Quad-Ring, for Series C devices: 9037HG/HW/HR3–12; 9038CG/CW/CR1–6
Switch Mechanism	SPDT, for 9012GA, GB, GC, GD, GE, GF, GG, GH, GJ single pole; except Forms E2, E3, E4, H3: Series C only
	DPDT, for 9012GA, GB, GC, GD, GE, GF, GG, GH, GJ double pole; except Forms E2, E3, H6, H7: Series C only

[1] If one of these Form designations appears on the pressure switch nameplate, complete the 9998 PC number by adding that same Form suffix from page 22-21, and add the Form price to the kit price.

# Section 23

## Relays and Timers

RELAYS AND TIMERS

23



### General Purpose Relays 23-2

Zelio™ RSL Interface Relays	23-2
Zelio™ RSB Interface Relays	23-3
Zelio™ RXG Interface Relays	23-4
Zelio™ RXM Plug-In Relays	23-6
Zelio™ RPM Plug-In Relays	23-9
Zelio™ RUM Plug-In Relays	23-11
Zelio™ RPF Power Relays	23-13
792 Ice Cube Relays	23-14
781R / 782 / 783 / 784 Plug-in Relays	23-16
750R Series Universal Relays	23-24
788R Series Universal Relays	23-27
199 Power Relays	23-48
725 Power Relays	23-51
389F Power Relays	23-53
300 Power Relays	23-56
92 Power Relays	23-58
Square D™ Universal Relays	23-60
Square D™ Plug-in Relays	23-62
Square D™ Miniature Control Relays	23-63
Square D™ Power Relays	23-65
750H Hazardous Location Series	23-66

### Solid State Relays 23-68

861H Solid-State Relays	23-68
Zelio™ SSL Relays	23-70
Zelio™ SSM Relays	23-71
Zelio™ SSL, SSM and SSP	23-73
6000 Solid-State Relays	23-79
SSRDIN Solid-State Relays	23-81
861 Solid-State Relays	23-83
70S2 Solid-State Relays	23-85

### Industrial Relays 23-87

TeSys™ D IEC Style Instantaneous Control Relays	23-87
TeSys™ K IEC Style Control Relays	23-90
TeSys™ SK IEC Style Control Relays	23-93
Square D™ NEMA Style AC Relays	23-94
Square D™ NEMA Style DC Relays	23-96

### Timers 23-100

Zelio™ RE17, E22 and RENF22 Modular Timers	23-100
Zelio™ RE48 Panel Mount Timers	23-102
Zelio™ REXL Miniature Plug-In Timers	23-103
820 Series Time Delay and Sensor Relays	23-104
TDR782 Series Time Delay and Sensor Relays	23-105
TDRPRO Series Time Delay and Sensor Relays	23-107
Square D™ JCK General Purpose Plug-In Timers	23-109

### Control and Measurement Relays 23-111

Zelio™ Current Measurement Relays	23-111
Zelio™ Phase Measurement Relays	23-112
Zelio™ Voltage Measurement Relays	23-113

### Power Supplies 23-117

### Interface Modules 23-118



RSL 1PV\*\*



RSL 1PR\*\*



RSL 1AB\*\*



RSL ZVA\*



RSL ZRA\*



RSL Z2



RSL Z3

### Zelio™ RSL Interface Relays

Zelio RSL slim interface relays save valuable panel space with a 6 mm width and have a 6 A general purpose load rating. Features include:

- Pre-assembled option: relay and socket are combined into one catalog number.
- Universal AC/DC sockets have built-in protection from transients and reverse polarity voltages (see catalog DIA3ED2090304EN-US for more detailed information).
- Accessories, which include isolators, ID tags, and bus jumper save valuable installation time.
- SPDT (1 C/O) design

Refer to [Online EZ Selector](#).

**Table 23.1: Pre-assembled Relay and Socket Combination (sold in lots of 10)**

Socket Supply Voltage	Pre-Assembled Catalog Number <sup>[1]</sup>		Replacement Relays Catalog Number
	Screw Connector	Spring Terminal	
12 Vac/Vdc	RSL1PVJU	RSL1PRJU	RSL1AB4JD
24 Vac/Vdc	RSL1PVBU	RSL1PRBU	RSL1AB4BD
48 Vac/Vdc	RSL1PVEU	RSL1PREU	RSL1AB4ED
110 Vac/Vdc	RSL1PVFU	RSL1PRFU	RSL1AB4ND
230 Vdc	RSL1PVPU	RSL1PRPU	RSL1AB4ND

**Table 23.2: Relays (sold in lots of 10)**

Relay Coil Voltage <sup>[2]</sup>	Catalog Number
12 Vdc	RSL1AB4JD
24 Vdc	RSL1AB4BD
48 Vdc	RSL1AB4ED
60 Vdc	RSL1AB4ND

**Table 23.3: Sockets (sold in lots of 10)**

Control Voltage	Socket Type		For Use with Relays:
	Screw Connector Catalog Number	Spring Terminal Catalog Number	
12 Vac/Vdc	RSLZVA1	RSLZRA1	RSL1AB4JD
24 Vac/Vdc		RSLZRA1	RSL1AB4BD
48 Vac/Vdc	RSLZVA2	RSLZRA2	RSL1AB4ED
60 Vac/Vdc		RSLZRA2	RSL1AB4ND
110 Vac/Vdc	RSLZVA3	RSLZRA3	RSL1AB4ND
230 Vac/Vdc	RSLZVA4	RSLZRA4	RSL1AB4ND

**Table 23.4: Accessories**

Description	Compatibility	Catalog Number
ID tags (2 sheets of 64 tags)	With all RSL and SSL series sockets	RSLZ5
Bus jumper (10 x 20-pole jumpers)		RSLZ2
Butterfly isolator (10 isolators)		RSLZ3

#### Approvals for RSL Relays



File: E173076  
CCN: NRNT2, NRNT8



File: 240278  
Class: 3211 04



IEC 61810-1 RoHS Compliant

#### Approvals for RSLZ Sockets



File: E172326  
CCN: SWIV2, SWIV8



File: 254977  
Class: 3211 07



IEC 61984 RoHS Compliant

[1] Relays are mounted on sockets equipped with LED and protection circuit.  
[2] The RSL sockets will accept an AC or DC input voltage; however, the relay always receives a filtered DC voltage.

### Zelio™ RSB Interface Relays

Zelio RSB interface relays and sockets provide the optimum combination of robust performance and space saving for the most demanding applications. Relays are rated at 8 A, 12 A, and 16 A (250 Vac / 28 Vdc). Features include:

- Optional protection modules for protection against electrical transients
- Optional plastic hold-down ejector clips
- Socket or printed circuit board installation options

Refer to [Online EZ Selector](#).



RSB1A160F7



RSB2A080BD



RSZE1S48M



RSB1A120JD Relay  
+ RZM031FPD Socket  
+ RSZE1S35M Module



RSB1A160BD Relay  
+ RSZE1S48M Socket

Table 23.5: Relays (sold in lots of 10)

Coil Voltage	Number and type of contacts - Thermal current (Ith)		
	SPDT (1 C/O) -12 A Res.	SPDT (1 C/O) -16 A Res.	DPDT (2 C/O) -8 A Res.
	Catalog Number <sup>[3]</sup>	Catalog Number <sup>[3]</sup>	Catalog Number <sup>[3]</sup>
6 Vdc	RSB1A120RD	RSB1A160RD	RSB2A080RD
12 Vdc	RSB1A120JD	RSB1A160JD	RSB2A080JD
24 Vdc	RSB1A120BD	RSB1A160BD	RSB2A080BD
48 Vdc	RSB1A120ED	RSB1A160ED	RSB2A080ED
60 Vdc	RSB1A120ND	RSB1A160ND	RSB2A080ND
110 Vdc	RSB1A120FD	RSB1A160FD	RSB2A080FD
24 Vac	RSB1A120B7	RSB1A160B7	RSB2A080B7
48 Vac	RSB1A120E7	RSB1A160E7	RSB2A080E7
120 Vac	RSB1A120F7	RSB1A160F7	RSB2A080F7
220 Vac	RSB1A120M7	RSB1A160M7	RSB2A080M7
230 Vac	RSB1A120P7	RSB1A160P7	RSB2A080P7
240 Vac	RSB1A120U7	RSB1A160U7	RSB2A080U7

Table 23.6: Sockets – 12 A, 300 Vac (sold in lots of 10)

Contact Terminal Arrangement	Connection	For Use with Relays	Catalog Number
Separate <sup>[4]</sup>	Box lug connector	RSB1A120**	RSZE1S35M
		RSB1A160** <sup>[5]</sup>	RSZE1S48M
		RSB2A080**	

Table 23.7: Protection Modules (sold in lots of 10)

Description	Compatibility	Voltage	Catalog Number
Diode	RSZ***** sockets (RSB series), RGZ***** sockets (RXG series)	6–230 Vdc	RZM040W
RC circuit		24–60 Vac	RZM041BN7
		110–240 Vac	RZM041FU7
		6–24 Vdc	RZM031RB
Diode + green LED		24–60 Vdc	RZM031BN
		110–230 Vdc	RZM031FPD
Varistor + green LED	6–24 Vac/Vdc	RZM021RB	
	24–60 Vac/Vdc	RZM021BN	
		110–230 Vac/Vdc	RZM021FP

Table 23.8: Accessories (sold in lots of 10)

Description	Compatibility	Catalog Number
Plastic hold-down ejector clip	RSZ***** sockets (RSB series)	RSZR215
ID tags		RSZL300

#### Approvals for RSB Relays



File: E173076  
CCN: NRNT2,  
NRNT8



File: 215736  
Class: 3211 07



IEC  
61810-1

RoHS Compliant

#### Approvals for RSZ Sockets



File: E173076  
CCN: NRNT2,  
NRNT8



File: 254977  
Class: 3211 07



IEC  
61810-1

RoHS Compliant

- RZM modules are RoHS compliant.
- For mounting track, see [Mounting Track, End Clamps, Jumpers, Fanning Strips, page](#)

<sup>[3]</sup> To order a relay complete with socket (sold in lots of 20): add suffix S to the catalog numbers selected above.  
Example: RSB 2A080RD + RSZ E1S48M becomes RSB 2A080RDS.

<sup>[4]</sup> The inputs and outputs are on separate sides.

<sup>[5]</sup> When using the RSB1A160\*\* relay with socket RSZ E1S48M, terminals 11 and 21, 14 and 24, 12 and 22 must be linked.

23

RELAYS AND TIMERS

New!

**Zelio™ RXG Interface Relays**

The Zelio RXG interface relay range is comprised of 10 A relays with 1 C/O contact and 5 A relays with 2 C/O contacts all in the same optimal foot print. The mating sockets feature separate contact terminals with reliable screw connections that attach either to a convenient 35 mm DIN rail or flexible panel mounting. The entire offer is a complete system solution with protection modules (diode, diode + LED, RC circuit, or varistor + LED), plastic ejector/maintaining clip and ID Tags to identify relays.

- Standard hold-down ejector clip integrated with socket
- Optional protection modules for protection against electrical transients
- Industry standard footprint for seamless compatibility with competitive sockets
- UL Listed combination (Relay + Socket) for expedited system certification

Refer to [Online EZ Selector](#).



RGZE1S35M Socket + RXG12BD Relay



RXG11RD



RXG22B7



RXG13RD



RXG15RD

**Table 23.9: Relays: Standard Cover, without LED, with Test Button and Lock-Down Door (sold in lots of 10)**

Coil Voltage	Number and type of contacts - Thermal current (Ith)	
	SPDT (1 C/O) - 10 A	DPDT (2 C/O) - 5 A
	Catalog Number	Catalog Number
6 Vdc	RXG11RD	RXG21RD
12 Vdc	RXG11JD	RXG21JD
24 Vdc	RXG11BD	RXG21BD
48 Vdc	RXG11ED	RXG21ED
60 Vdc	RXG11ND	RXG21ND
110 Vdc	RXG11FD	RXG21FD
24 Vac	RXG11B7	RXG21B7
48 Vac	RXG11E7	RXG21E7
120 Vac	RXG11F7	RXG21F7
220 Vac	RXG11M7	RXG21M7
230 Vac	RXG11P7	RXG21P7

**Table 23.10: Relays: Standard Cover, with LED, with Test Button and Lock-Down Door (sold in lots of 10)**

Coil Voltage	Number and type of contacts - Thermal current (Ith)	
	SPDT (1 C/O) - 10 A	DPDT (2 C/O) - 5 A
	Catalog Number	Catalog Number
6 Vdc	RXG12RD	RXG22RD
12 Vdc	RXG12JD	RXG22JD
24 Vdc	RXG12BD	RXG22BD
48 Vdc	RXG12ED	RXG22ED
60 Vdc	RXG12ND	RXG22ND
110 Vdc	RXG12FD	RXG22FD
24 Vac	RXG12B7	RXG22B7
48 Vac	RXG12E7	RXG22E7
120 Vac	RXG12F7	RXG22F7
220 Vac	RXG12M7	RXG22M7
230 Vac	RXG12P7	RXG22P7

**Table 23.11: Relays: Standard Cover, with LED, without Test Button and Lock-Down Door (sold in lots of 10)**

Coil Voltage	Number and type of contacts - Thermal current (Ith)	
	SPDT (1 C/O) - 10 A	DPDT (2 C/O) - 5 A
	Catalog Number	Catalog Number
6 Vdc	RXG13RD	RXG23RD
12 Vdc	RXG13JD	RXG23JD
24 Vdc	RXG13BD	RXG23BD
48 Vdc	RXG13ED	RXG23ED
60 Vdc	RXG13ND	RXG23ND
110 Vdc	RXG13FD	RXG23FD
24 Vac	RXG13B7	RXG23B7
48 Vac	RXG13E7	RXG23E7
120 Vac	RXG13F7	RXG23F7
220 Vac	RXG13M7	RXG23M7
230 Vac	RXG13P7	RXG23P7

**Table 23.12: Relays: Clear Cover, without LED, without Test Button and Lock-Down Door (sold in lots of 10)**

Coil Voltage	Number and type of contacts - Thermal current (Ith)	
	SPDT (1 C/O) - 10 A	DPDT (2 C/O) - 5 A
	Catalog Number	Catalog Number
6 Vdc	RXG15RD	RXG25RD
12 Vdc	RXG15JD	RXG25JD
24 Vdc	RXG15BD	RXG25BD
48 Vdc	RXG15ED	RXG25ED
60 Vdc	RXG15ND	RXG25ND
110 Vdc	RXG15FD	RXG25FD
24 Vac	RXG15B7	RXG25B7
48 Vac	RXG15E7	RXG25E7
120 Vac	RXG15F7	RXG25F7
220 Vac	RXG15M7	RXG25M7
230 Vac	RXG15P7	RXG25P7





RGZE1S48M



RZM031RB



RSZL300

**Table 23.13: Sockets (sold in lots of 10)**

Contact Terminal Arrangement	Connection	For Use with Relays	Catalog Number
Separate <sup>[6]</sup>	Box lug connector	RXG1***	RGZE1S35M <sup>[7]</sup>
		RXG2***	RGZE1S48M <sup>[7]</sup>

**Table 23.14: Protection Modules (sold in lots of 10)**

Description	Voltage	Compatibility	Catalog Number	
Diode	6 to 230 Vdc 24 to 60 Vac	RSZ***** sockets (RSB series), RGZ***** sockets (RXG series)	RZM040W	
RC circuit	110 to 240 Vac		RZM041BN7	
	6 to 24 Vdc		RZM041FU7	
Diode + green LED	24 to 60 Vdc 110 to 230 Vdc		RZM031RB	
	6 to 24 Vdc/Vac		RZM031BN	
Varistor + green LED	24 to 60 Vdc/Vac		RZM031FPD	
	24 to 60 Vdc/Vac		RZM021RB	
	110 to 230 Vdc/Vac		RZM021BN	
				RZM021FP

**Table 23.15: Accessories (sold in lots of 10)**

Description	For Use With	Catalog Number
Plastic ejector clip	RXG series (RSZ***** sockets)	RGZR215
Socket ID tags		RSZL300
Relay ID tags		RGZL520

**Approvals for RXG Relays**



**Approvals for RGZ Sockets**



RELAYS AND TIMERS

23

[6] The inputs and outputs are on separate sides.  
 [7] Please note that RGZE1S35M and RGZE1S48M sockets come standard with the RGZR215 ejector clip  
 [8] When used with the appropriate RGZ socket.



RXM4AB2BD + RXZE2S114M + RXZR335 + RXZL520



RXM2AB1B7



RXM2AB2BD



RXM2AB3F7

### Zelio™ RXM Plug-In Relays

Zelio RXM miniature plug-in relays and sockets provide a complete system solution in response to the most demanding applications ranging from 3 to 12 A. Some of the features include:

- Test button with removable lock-down door for testing the contacts (depending on model)
- Green LED indication of relay status (depending on model)
- Mechanical indication of relay status (standard)
- Optional protection modules to protect against electrical spikes
- Bus jumpers for connecting multiple terminals reduce installation time

[Online EZ Selector](#)

**Table 23.16: Relays: without LED, with Test button and Lock-Down Door (sold in lots of 10)**

Coil Voltage	Number and type of contacts - Thermal current (Ith)		
	DPDT (2 C/O) -12 A Res.	3PDT (3 C/O) - 10 A Res.	4PDT (4 C/O) - 8 A Res.
	Catalog Number	Catalog Number	Catalog Number
12 Vdc	RXM2AB1JD	RXM3AB1JD	RXM4AB1JD
24 Vdc	RXM2AB1BD	RXM3AB1BD	RXM4AB1BD
48 Vdc	RXM2AB1ED	RXM3AB1ED	RXM4AB1ED
110 Vdc	RXM2AB1FD	RXM3AB1FD	RXM4AB1FD
220 Vdc	—	—	RXM4AB1MD
24 Vac	RXM2AB1B7	RXM3AB1B7	RXM4AB1B7
48 Vac	RXM2AB1E7	RXM3AB1E7	RXM4AB1E7
120 Vac	RXM2AB1F7	RXM3AB1F7	RXM4AB1F7
230 Vac	RXM2AB1P7	RXM3AB1P7	—
240 Vac	—	—	RXM4AB1U7

**Table 23.17: Relays: with LED, with Test Button and Lock-Down Door (sold in lots of 10)**

Coil Voltage	Number and type of contacts - Thermal current (Ith)		
	DPDT (2 C/O) -12 A Res.	3PDT (3 C/O) - 10 A Res.	4PDT (4 C/O) - 8 A Res.
	Catalog Number	Catalog Number	Catalog Number
12 Vdc	RXM2AB2JD	RXM3AB2JD	RXM4AB2JD
24 Vdc	RXM2AB2BD	RXM3AB2BD	RXM4AB2BD
48 Vdc	RXM2AB2ED	RXM3AB2ED	RXM4AB2ED
110 Vdc	RXM2AB2FD	RXM3AB2FD	RXM4AB2FD
125 Vdc	—	—	RXM4AB2GD
24 Vac	RXM2AB2B7	RXM3AB2B7	RXM4AB2B7
48 Vac	RXM2AB2E7	RXM3AB2E7	RXM4AB2E7
120 Vac	RXM2AB2F7	RXM3AB2F7	RXM4AB2F7
230 Vac	RXM2AB2P7	RXM3AB2P7	RXM4AB2P7

**Table 23.18: Relays: with LED, without Test Button and Lock-Down Door (sold in lots of 10)**

Coil Voltage	Number and type of contacts - Thermal current (Ith)		
	DPDT (2 C/O) -12 A Res.	3PDT (3 C/O) - 10 A Res.	4PDT (4 C/O) - 8 A Res.
	Catalog Number	Catalog Number	Catalog Number
12 Vdc	RXM2AB3JD	—	RXM4AB3JD
24 Vdc	RXM2AB3BD	—	RXM4AB3BD
48 Vdc	RXM2AB3ED	—	RXM4AB3ED
110 Vdc	RXM2AB3FD	—	RXM4AB3FD
125 Vdc	—	—	RXM4AB3GD
24 Vac	RXM2AB3B7	—	RXM4AB3B7
48 Vac	RXM2AB3E7	—	RXM4AB3E7
120 Vac	RXM2AB3F7	—	RXM4AB3F7
230 Vac	RXM2AB3P7	—	RXM4AB3P7

**Table 23.19: Relays: Low level Contacts, without LED, with Test Button and Lock-Down Door (sold in lots of 10)**

Coil Voltage	Number and type of contacts - Thermal current (Ith)
	4PDT (4 C/O) -3 A Res.
	Catalog Number
12 Vdc	RXM4GB1JD
24 Vdc	RXM4GB1BD
48 Vdc	RXM4GB1ED
110 Vdc	RXM4GB1FD
24 Vac	RXM4GB1B7
48 Vac	RXM4GB1E7
120 Vac	RXM4GB1F7
230 Vac	RXM4GB1P7



RXM4GB2F7

**Table 23.20: Relays: Low Level Contacts, with LED, with Test button and Lock-Down Door (sold in lots of 10)**

Coil Voltage	Number and type of contacts - Thermal current (Ith)	
	4PDT (4 C/O) - 3 A Res.	
	Catalog Number	
12 Vdc		RXM4GB2JD
24 Vdc		RXM4GB2BD
48 Vdc		RXM4GB2ED
110 Vdc		RXM4GB2FD
24 Vac		RXM4GB2B7
48 Vac		RXM4GB2E7
120 Vac		RXM4GB2F7
230 Vac		RXM4GB2P7
240 Vac		RXM4GB2U7

**Table 23.21: Relays: Low Level Contacts, with LED, without Test Button and Lock-Down Door (sold in lots of 10)**

Coil Voltage	Number and type of contacts - Thermal current (Ith)	
	4PDT (4 C/O) - 3 A Res.	
	Catalog Number	
12 Vdc		RXM4GB3JD
24 Vdc		RXM4GB3BD
48 Vdc		RXM4GB3ED
110 Vdc		RXM4GB3FD
125 Vdc		—
24 Vac		RXM4GB3B7
48 Vac		RXM4GB3E7
120 Vac		RXM4GB3F7
230 Vac		RXM4GB3P7

- For sockets and accessories, see [page 23-8](#).



RXZE2S108M



RXM040W



RXZ400

Sockets and Accessories for Zelio™ RXM Relays

Refer to Online EZ Selector.

Table 23.22: Sockets (sold in lots of 10)

Contact Terminal Arrangement	Connection	For Use with Relays	Catalog Number
Mixed <sup>[9]</sup>	Screw clamp terminals	RXM2**** <sup>[10]</sup> RXM4**** <sup>[10]</sup>	RXZE2M114 <sup>[11]</sup>
	Box lug connector	RXM2**** RXM4****	RXZE2M114M <sup>[11]</sup>
Separate <sup>[12]</sup>	Box lug connector	RXM2****	RXZE2S108M <sup>[13]</sup>
		RXM3****	RXZE2S111M <sup>[11]</sup>
	Spring Terminal	RXM4**** RXM2****	RXZE2S114M RXZE2S114S

Table 23.23: Protection Modules (sold in lots of 10)

Description	Voltage	Compatibility	Catalog Number
Diode	6–250 Vdc	RXZ**** sockets (RXM series), RPZF1 and RPZF2 sockets (RPM series)	RXM040W
RC circuit	24–60 Vac		RXM041BN7
	110–240 Vac		RXM041FU7
Varistor	6–24 Vac/Vdc		RXM021RB
	24–60 Vac/Vdc	RXM021BN	
	110–240 Vac/Vdc	RXM021FP	

Table 23.24: Accessories (sold in lots of 10)

Description	Compatibility	Catalog Number
Metal hold-down clip	RXZ sockets (RXM series)	RXZ400
Plastic hold-down ejector clip	RXZ sockets (RXM series)	RXZR335
Bus jumper, 2-pole (Ith: 5 A max. )	RXZE2S sockets (RXM series)	RXZS2
DIN rail mounting adapter <sup>[14]</sup>	RXM series relays, RPM1 and RPM2 series relays	RXZE2DA RXZE2FA
Relay ID tags (sheet of 108 tags)	RXM series relays, RPM series relays, RUM series relays	RXZL520
Socket ID tags	RXZ sockets (RXM series, except RXZE2M114), RUZS sockets (RUM series)	RXZL420

Approvals for RXM Relays



File: E164862  
CCN: NLDX,  
NLDX7<sup>[15]</sup>



File:  
E164862  
CCN:  
NLDX2,  
NLDX8



File:  
230765  
Class:  
3211 07



RoHS  
Compliant

Approvals for RXZ Sockets



File: E172326  
CCN: SWIV2,  
SWIV8



File: 230765  
Class: 3211 07



RoHS  
Compliant

[9] The inputs and outputs are mixed on both sides.  
 [10] When mounting relay RXM2\*\*\*\* on socket RXZE2M\*\*\*\*, the thermal current must not exceed 10 A.  
 [11] Thermal current Ith: 10 A  
 [12] The inputs and outputs are on separate sides.  
 [13] Thermal current Ith: 12 A  
 [14] Test button and lock-down door become inaccessible.  
 [15] When used with the appropriate RXZ socket.

**Zelio™ RPM Plug-In Relays**

Zelio RPM plug-in relays and sockets provide a complete system solution for the most demanding applications up to 15 A. Some of the features include:

- Test button with removable lock-down door for testing the contacts (depending on model)
- Green LED indication of relay status (depending on model)
- Mechanical indication of relay status (standard)
- Optional modules to protect against electrical spikes

Refer to [Online EZ Selector](#).



RPZF4 Socket  
+RPM42P7 Relay



RPM13BD



RPM23P7



RPM33BD



RPM43BD

**Table 23.25: Relays: without LED, with Test Button and Lock-Down Door (sold in lots of 10)**

Coil Voltage	Number and type of contacts - Thermal current (Ith)			
	SPDT (1 C/O) - 15 A	DPDT (2 C/O) - 15 A	3PDT (3 C/O) - 15 A	4PDT (4 C/O) - 15 A
	Res.	Res.	Res.	Res.
	Catalog Number	Catalog Number	Catalog Number	Catalog Number
12 Vdc	RPM11JD	RPM21JD	RPM31JD	RPM41JD
24 Vdc	RPM11BD	RPM21BD	RPM31BD	RPM41BD
48 Vdc	RPM11ED	RPM21ED	RPM31ED	RPM41ED
110 Vdc	RPM11FD	RPM21FD	RPM31FD	RPM41FD
24 Vac	RPM11B7	RPM21B7	RPM31B7	RPM41B7
48 Vac	RPM11E7	RPM21E7	RPM31E7	RPM41E7
120 Vac	RPM11F7	RPM21F7	RPM31F7	RPM41F7
230 Vac	RPM11P7	RPM21P7	RPM31P7	RPM41P7

**Table 23.26: Relays: with LED, with Test Button and Lock-Down Door (sold in lots of 10)**

Coil Voltage	Number and type of contacts - Thermal current (Ith)			
	SPDT (1 C/O) - 15 A	DPDT (2 C/O) - 15 A	3PDT (3 C/O) - 15 A	4PDT (4 C/O) - 15 A
	Res.	Res.	Res.	Res.
	Catalog Number	Catalog Number	Catalog Number	Catalog Number
12 Vdc	RPM12JD	RPM22JD	RPM32JD	RPM42JD
24 Vdc	RPM12BD	RPM22BD	RPM32BD	RPM42BD
48 Vdc	RPM12ED	RPM22ED	RPM32ED	RPM42ED
110 Vdc	RPM12FD	RPM22FD	RPM32FD	RPM42FD
24 Vac	RPM12B7	RPM22B7	RPM32B7	RPM42B7
48 Vac	RPM12E7	RPM22E7	RPM32E7	RPM42E7
120 Vac	RPM12F7	RPM22F7	RPM32F7	RPM42F7
230 Vac	RPM12P7	RPM22P7	RPM32P7	RPM42P7

**Table 23.27: Relays: with LED, without Test Button and Lock-Down Door (sold in lots of 10)**

Coil Voltage	Number and type of contacts - Thermal current (Ith)			
	SPDT (1 C/O) - 15 A	DPDT (2 C/O) - 15 A	3PDT (3 C/O) - 15 A	4PDT (4 C/O) - 15 A
	Res.	Res.	Res.	Res.
	Catalog Number	Catalog Number	Catalog Number	Catalog Number
12 Vdc	RPM13JD	RPM23JD	RPM33JD	RPM43JD
24 Vdc	RPM13BD	RPM23BD	RPM33BD	RPM43BD
48 Vdc	RPM13ED	RPM23ED	RPM33ED	RPM43ED
110 Vdc	RPM13FD	RPM23FD	RPM33FD	RPM43FD
125 Vdc	—	—	—	—
24 Vac	RPM13B7	RPM23B7	RPM33B7	RPM43B7
48 Vac	RPM13E7	RPM23E7	RPM33E7	RPM43E7
120 Vac	RPM13F7	RPM23F7	RPM33F7	RPM43F7
230 Vac	RPM13P7	RPM23P7	RPM33P7	RPM43P7



RPZF2



RXM041BN7



RUW241P7



RUW101MW



RPZ1DA



RPZ3FA

Sockets and Accessories for Zelio™ RPM Relays

Table 23.28: Sockets (sold in lots of 10)

Contact Terminal Arrangement	Connection	For Use with Relays	Catalog Number
Mixed <sup>[16]</sup>	Screw terminals	RPM1***	RPZF1
		RPM2***	RPZF2
		RPM3***	RPZF3
		RPM4***	RPZF4

Table 23.29: Protection Modules (sold in lots of 10)

Description	Voltage	Compatibility	Catalog Number
Diode	6–250 Vdc	RXZ sockets (RXM series), RPZF1, RPZF2	RXM040W
		RPZF3, RPZF4	RUW240BD
RC circuit	24–60 Vac	RXZ sockets (RXM series), RPZF1, RPZF2	RXM041BN7
	110–240 Vac		RXM041FU7
	110–240 Vac	RPZF3, RPZF4	RUW241P7
Varistor	6–24 Vac/Vdc	RXZ sockets (RXM series), RPZF1, RPZF2	RXM021RB
	24–60 Vac/Vdc		RXM021BN
	110–240 Vac/Vdc	RPZF3, RPZF4	RUW242B7
	24 Vac/Vdc	RPZF3, RPZF4	RUW242B7
	240 Vac/Vdc	RPZF3, RPZF4	RUW242P7

Table 23.30: Timer Module<sup>[17]</sup> (sold in lots of 1)

Description	Voltage	Compatibility	Catalog Number
On-delay timer, interval timer, repeat cycle timer/starting on-delay, repeat cycle timer/starting off-delay, off-delay timer, one-shot timer, timing on de-energization, on-delay timer	24–240 Vac/Vdc	RPZF3, RPZF4	RUW101MW

Table 23.31: Accessories (sold in lots of 10)

Description	Compatibility	Catalog Number
Metal hold-down clip (for single-pole relays)	RPZF1	RPZR235
DIN rail mounting adapter <sup>[18]</sup>	RPM1***	RPZ1DA
	RPM2***	RXZE2DA
	RPM3***	RPZ3DA
	RPM4***	RPZ4DA
Panel mounting adapter <sup>[18]</sup>	RPM1***	RPZ1FA
	RPM2***	RXZE2FA
	RPM3***	RPZ3FA
	RPM4***	RPZ4FA
ID tags (sheet of 108 tags)	RXM series relays, RPM series relays, RUM series relays	RXZL520

Approvals for RPM Relays



File: E164862  
CCN: NLDX,  
NLDX7<sup>[19]</sup>



File: E164862  
CCN: NLDX2,  
NLDX8



File: 230765  
Class: 3211 07



RoHS Compliant

Approvals for RPZ Sockets



File: E172326  
CCN: SWIV2,  
SWIV8



File: 230765  
Class: 3211 07



RoHS Compliant

[16] The inputs and outputs are mixed on both sides.

[17] See timer module description (selection of functions and time delays) in catalog DIA3ED2090304EN-US.

[18] Test button and lock-down door become inaccessible

[19] When used with the appropriate RPZ socket.

New!

### Zelio™ RUM Plug-In Relays

Zelio RUM plug-in relays and sockets provide a complete system solution for the most demanding applications up to 10 A. Some of the features include:

- Test button with lock-down door for testing the contacts (depending on model)
- Green LED indication of relay status (depending on model)
- Mechanical indication of relay status (standard)
- Optional protection modules to protect against electrical spikes
- Bus jumpers for connecting multiple terminals reduce installation time.

Refer to [Online EZ Selector](#).



RUZSF3M Socket  
+ RUMF32BD Relay



RUMC31F7



RUMF22BD



RUMC23F7

**Table 23.32: Relays: without LED, with Test Button, and Lock-Down Door (sold in lots of 10)**

Pins	Coil Voltage	Number and type of contacts - Thermal current (Ith)	
		DPDT (2 C/O) -10 A Res.	3PDT (3 C/O) -10 A Res.
		Catalog Number	Catalog Number
Octal	12 Vdc	RUMC21JD	RUMC31JD
	24 Vdc	RUMC21BD	RUMC31BD
	48 Vdc	RUMC21ED	RUMC31ED
	60 Vdc	—	RUMC31ND
	110 Vdc	RUMC21FD	RUMC31FD
	125 Vdc	—	RUMC31GD
	220 Vdc	—	RUMC31MD
	24 Vac	RUMC21B7	RUMC31B7
	48 Vac	RUMC21E7	RUMC31E7
	120 Vac	RUMC21F7	RUMC31F7
Blade	230 Vac	RUMC21P7	RUMC31P7
	12 Vdc	RUMF21JD	RUMF31JD
	24 Vdc	RUMF21BD	RUMF31BD
	48 Vdc	RUMF21ED	RUMF31ED
	110 Vdc	RUMF21FD	RUMF31FD
	24 Vac	RUMF21B7	RUMF31B7
	48 Vac	RUMF21E7	RUMF31E7
	120 Vac	RUMF21F7	RUMF31F7
230 Vac	RUMF21P7	RUMF31P7	

**Table 23.33: Relays: with LED, Test Button, and Lock-Down Door (sold in lots of 10)**

Pins	Coil Voltage	Number and type of contacts - Thermal current (Ith)	
		DPDT (2 C/O) -10 A Res.	3PDT (3 C/O) -10 A Res.
		Catalog Number	Catalog Number
Octal	12 Vdc	RUMC22JD	RUMC32JD
	24 Vdc	RUMC22BD	RUMC32BD
	48 Vdc	RUMC22ED	RUMC32ED
	60 Vdc	—	RUMC32ND
	110 Vdc	RUMC22FD	RUMC32FD
	125 Vdc	—	RUMC32GD
	24 Vac	RUMC22B7	RUMC32B7
	48 Vac	RUMC22E7	RUMC32E7
	120 Vac	RUMC22F7	RUMC32F7
	230 Vac	RUMC22P7	RUMC32P7
Blade	12 Vdc	RUMF22JD	RUMF32JD
	24 Vdc	RUMF22BD	RUMF32BD
	48 Vdc	RUMF22ED	RUMF32ED
	110 Vdc	RUMF22FD	RUMF32FD
	24 Vac	RUMF22B7	RUMF32B7
	48 Vac	RUMF22E7	RUMF32E7
	120 Vac	RUMF22F7	RUMF32F7
	230 Vac	RUMF22P7	RUMF32P7

**Table 23.34: Relays: with LED, without Push Button, and Lock-Down Door (sold in lots of 10)**

Pins	Coil Voltage	Number and type of contacts - Thermal current (Ith)	
		DPDT (2 C/O) -10 A Res.	3PDT (3 C/O) -10 A Res.
		Catalog Number	Catalog Number
Octal	12 Vdc	RUMC23JD	RUMC33JD
	24 Vdc	RUMC23BD	RUMC33BD
	48 Vdc	RUMC23ED	RUMC33ED
	60 Vdc	—	RUMC33ND
	110 Vdc	RUMC23FD	RUMC33FD
	125 Vdc	—	RUMC33GD
	24 Vac	RUMC23B7	RUMC33B7
	48 Vac	RUMC23E7	RUMC33E7
	120 Vac	RUMC23F7	RUMC33F7
	230 Vac	RUMC23P7	RUMC33P7
Blade	12 Vdc	RUMF23JD	RUMF33JD
	24 Vdc	RUMF23BD	RUMF33BD
	48 Vdc	RUMF23ED	RUMF33ED
	110 Vdc	RUMF23FD	RUMF33FD
	125 Vdc	—	—
	24 Vac	RUMF23B7	RUMF33B7
	48 Vac	RUMF23E7	RUMF33E7
	120 Vac	RUMF23F7	RUMF33F7
230 Vac	RUMF23P7	RUMF33P7	

Sockets and Accessories for Zelio™ RUM Relays

Refer to [Online EZ Selector](#).

Table 23.35: Sockets (sold in lots of 10)

Contact Terminal Arrangement	Connection	For Use with Relays	Catalog Number
Mixed [20]	Box lug connector (screw terminals)	RUMC2****	RUZC2M
		RUMC3****	RUZC3M
		RUMC2****	RUZSC2M
RUMC3****		RUZSC3M	
Separate[21]		RUMF2****	RUZSF3M
		RUMF3****	

Table 23.36: Protection Modules (sold in lots of 10)

Description	Compatibility	Voltage	Catalog Number
Diode	RUZ... sockets (RUM series)	6–250 Vdc	RUW240BD
RC circuit		110–240 Vac	RUW241P7
Varistor		24 Vac/Vdc	RUW242B7
		240 Vac/Vdc	RUW242P7

Table 23.37: Timer Module [22] (sold in lots of 1)

Description	Compatibility	Voltage	Catalog Number
On-delay timer, interval timer, repeat cycle timer/starting on-delay, repeat cycle timer/starting off-delay, off-delay timer, one-shot timer, timing on de-energization, on-delay timer.	RUZ... sockets (RUM series)	24–240 Vac/Vdc	RUW101MW

Table 23.38: Accessories (sold in lots of 10)

Description	Compatibility	Catalog Number
Metal hold-down clip	RUZ sockets (RUM series)	RUZC200
Bus jumper, 2-pole (lth: 5 A)	RUZS sockets (RUM series)	RUZS2
Relay ID tags (sheet of 108 tags)	RXM series relays, RPM series relays, RUM series relays	RXZL520
Socket ID tags	RXZ sockets (RXM series, except RXZE2M114), RUZS sockets (RUM series),	RUZL420

Approvals for RUM Relays



File: E164862  
CCN: NLDX, NLDX7 [23]



File: E164862  
CCN: NLDX2, NLDX8



File: 230765  
Class: 3211 07



RoHS Compliant

Approvals for RUZ Sockets



File: E172326  
CCN: SWIV2, SWIV8



File: 230765  
Class: 3211 07



RoHS Compliant



RUZC2M



RUW241P7



RUW101MW



RUZS2



RUZC200

23

RELAYS AND TIMERS

[20] The inputs and outputs are mixed on both sides.

[21] The inputs and outputs are on separate sides.

[22] See timer module description (selection of functions and time delays) in catalog DIA3ED2090304EN-RUM-US.

[23] When used with the appropriate RUZ socket.



**Zelio™ RPF Power Relays**

Zelio RPF power relays respond to the most demanding applications up to 30 A. Features include:

- UL Listed
- Sealed construction
- Motor load ratings: 1 hp @ 120 Vac / 3 hp @ 240 Vac (N/O contacts only)
- DIN rail and panel mounting capability
- Short circuit rating of 5,000 A rms @ 3 hp, 240 Vac (N/O contacts only)

Refer to [Online EZ Selector](#).



RPF2AP7



RPF2BBD

**Table 23.39: Relays (sold in lots of 10)**

Coil Voltage	Number and type of contacts - Thermal current (Ith)	
	DPST (2 N/O) - 30 A at 277 Vac, 20 A at 28 Vdc	DPDT (2 C/O) - 30 A at 277 Vac, 20 A at 28 Vdc, 3A (NC)
	Catalog Number	Catalog Number
12 Vdc	RPF2AJD	RPF2BJD
24 Vdc	RPF2ABD	RPF2BBD
24 Vac	RPF2AB7	RPF2BB7
120 Vac	RPF2AF7	RPF2BF7
230 Vac	RPF2AP7	RPF2BP7

**Approvals for RPF Relays**



File: E43641  
CCN: NLDX, NLDX7



File: 040787  
Class: 3211-07



IEC 61810-1  
RoHS Compliant

- For mounting track (DIN rail), see [Mounting Track, End Clamps, Jumpers, Fanning Strips, page](#) .

RELAYS AND TIMERS

23

**792 Ice Cube Relays**  
**DPDT 12 A; 4PDT 6 A and 3 A**

**Description**

The 792 plug-in control relays offer clear or full-feature covers with multiple mounting options and accessories. The 4PDT models save valuable space while adding increased functionality.



792 Clear Cover

792 Full-Feature Cover

Feature	Benefit
12 A / 6 A / 3 A switching current	Ideal choice for various automation panels and controls
Clear or full-feature cover options	Full-feature covers include an LED indicator and a locking test button to facilitate maintenance and speed up commissioning
DPDT and 4PDT contact options	Simultaneous control of 2 or 4 separate circuits
Socket-mounting option	Simplified installation and maintenance; use of protection modules, hold-down clips, and other accessories
Gold-flashed contacts	Reduced contact oxidation and increased shelf life
Mechanical flag indicator (standard)	Display of the status of an unpowered relay during testing or operation

23

RELAYS AND TIMERS

Contact Rating	Contact Configuration	Nominal Coil Voltage	Coil Resistance (Ω)	Contacts	Part Number		
					Clear Cover	Clear Cover with LED	Full-Feature Cover
3 A	4PDT	12 Vac	44	Low-Level Bifurcated	792DX3C-12A	792DX3CL-12A	792DX3M4L-12A
		24 Vac	177		792DX3C-24A	792DX3CL-24A	792DX3M4L-24A
		48 Vac	708		792DX3C-48A	792DX3CL-48A	792DX3M4L-48A
		120 Vac	3630		792DX3C-120A	792DX3CL-120A	792DX3M4L-120A
		240 Vac	17720		792DX3C-240A	792DX3CL-240A	792DX3M4L-240A
		12 Vdc	160		792DX3C-12D	792DX3CL-12D	792DX3M4L-12D
		24 Vdc	640		792DX3C-24D	792DX3CL-24D	792DX3M4L-24D
		48 Vdc	2560		792DX3C-48D	792DX3CL-48D	792DX3M4L-48D
		110 Vdc	13440		792DX3C-110D	792DX3CL-110D	792DX3M4L-110D
		12 A	DPDT		12 Vac	44	Standard
24 Vac	177			792BXC-24A	—	792BXM4L-24A	
48 Vac	708			792BXC-48A	—	792BXM4L-48A	
120 Vac	3630			792BXC-120A	—	792BXM4L-120A	
240 Vac	17720			792BXC-240A	—	792BXM4L-240A	
12 Vdc	160			792BXC-12D	—	792BXM4L-12D	
24 Vdc	640			792BXC-24D	—	792BXM4L-24D	
48 Vdc	2560			792BXC-48D	—	792BXM4L-48D	
110 Vdc	13440			792BXC-110D	—	792BXM4L-110D	
6 A	4PDT			12 Vac	44	Standard	
		24 Vac	177	792DXC-24A	792DXCL-24A		792DXM4L-24A
		48 Vac	708	792DXC-48A	792DXCL-48A		792DXM4L-48A
		120 Vac	3630	792DXC-120A	792DXCL-120A		792DXM4L-120A
		240 Vac	17720	792DXC-240A	792DXCL-240A		792DXM4L-240A
		12 Vdc	160	792DXC-12D	792DXCL-12D		792DXM4L-12D
		24 Vdc	640	792DXC-24D	792DXCL-24D		792DXM4L-24D
		48 Vdc	2560	792DXC-48D	792DXCL-48D		792DXM4L-48D
		110 Vdc	13440	792DXC-110D	792DXCL-110D		792DXM4L-110D

**Specifications**

Part Number	792DX3	792BXC	792DXC	
<b>Contact Characteristics</b>				
Terminal Style	Blade	Blade	Blade	
Contact Material	Silver Alloy	Silver Alloy	Bifurcated	
Contact Configuration	DPDT	4PDT	4PDT	
Carrying Current	12 A	6 A	3 A	
Load Type	—	Standard	Low Level	
Maximum Switching Voltage	IEC: 250 Vac / 28 Vdc UL/CSA: 300 Vac / 30 Vdc	300 V	300 V	
Rated Switching Current (Conforming to IEC AC-1 and DC-1)	N.O.: 12 A at 250 Vac, N.C.: 6 A at 250 Vac	N.O.: 6 A; N.C.: 3 A	N.O.: 2 A; N.C.: 1 A	
	N.O.: 12 A at 28 Vdc, N.C.: 6 A at 28 Vdc	N.O.: 6 A; N.C.: 3 A	N.O.: 2 A; N.C.: 1 A	
Rated Switching Current (Conforming to UL)	General Purpose	—	3 A at 240–277 Vac	
	Resistive	12 A at 277 Vac, 100 k cycles	6 A at 277 Vac, 200 k cycles	3 A at 30 Vdc
		12 A at 120 Vac, 200 k cycles	8 A at 120 Vac, 200 k cycles	—
	Motor	12 A at 30 Vdc, 100 k cycles	8 A at 30 Vdc, 200 k cycles	—
		1/2 hp at 120 Vac, 6 k cycles	1/3 hp at 120 Vac, 6 k cycles	1/16 hp (2.8 A FLA) at 120 Vac
1 hp at 277 Vac, 6 k cycles	1/2 hp at 277 Vac, 6 k cycles	—		
B300 Pilot Duty	6 k cycles	—	—	
Pilot Duty	—	B300, 6 k cycles	5 A make, 0.5 A break, 3 A continuous at 120 Vac	
Minimum Switching Requirement	10 mA at 17 Vdc	10 mA at 17 Vdc	3 mA at 5 Vdc	
<b>Coil Characteristics</b>				
Maximum Operating Voltage	110% (AC/DC)	—	—	
Maximum Pickup Voltage	80% (AC/DC)	—	—	
Drop-out Voltage Threshold	15% (AC); 10% (DC)	—	—	
Average Consumption	0.9–1.2 VA (AC); 0.8–1.1 W (DC)	—	—	

**Dimensions, in. (mm)**

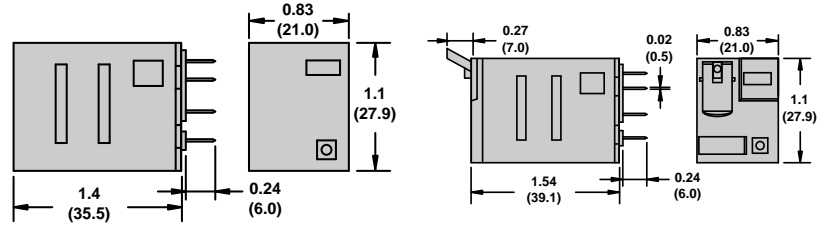

Clear Cover Dimension

Full-Feature Cover Dimension

**Wiring Diagrams**

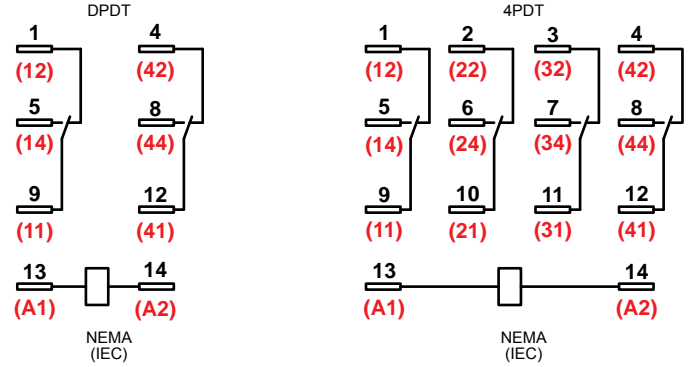

**Relay Accessories**

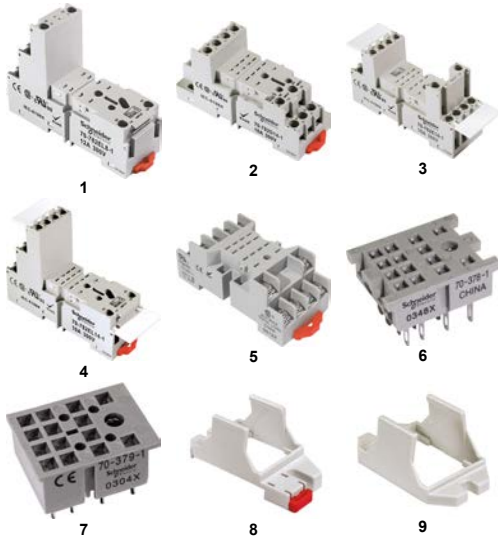

Description	Function	For Use with Relays	Pkg. Min.	Standard Part Number	
1	Socket	DIN or panel mounting with elevator terminals	792XB	10	70-782EL8-1
2	Socket	DIN or panel mounting with screw terminals and clamping plates	792XB / 792XDX	10	70-782D14-1
3	Socket	DIN or panel mounting with rising elevator box terminals		10	70782E141
4	Socket	DIN or panel mounting with elevator terminals		10	70-782E14-1
5	Socket	DIN or panel mounting with screw terminals and clamping plates		10	704611
6	Socket	Solder terminals for chassis mounting	792XDX	10	703781
7	Socket	Printed circuit terminals for PCB mounting	792XB / 792XDX	10	703791
8	Adapter	Direct DIN rail mounting		10	16-782C
9	Adapter	Direct panel mounting		10	16-782C1

23

RELAYS AND TIMERS



Socket Accessories

Description	Function	For Use with Sockets	Coil Voltage	Pkg. Min.	Standard Part Number
1 Metal Spring Clip	Securing the relay in the socket	70-782D14-1, 70-782E14-1, 70-782EL14-1, 70-782EL8-1	—	10	16-782SC
2 Plastic Hold-Down Clip	Securing the relay in the socket or ejecting the relay from the socket		—	10	16-782PC1
3 Write-on Tag	Small write-on tag		—	10	16-782FT-1
4 Write-on Tag	Write-on tag for the 16-782PC-1 hold-down clip	—	—	10	16-700ST-1
5 Extruded Aluminum DIN Rail, 1 m (39.37 in.)	Quick installation and removal of sockets	70-782D14-1, 70-782E14-1, 70-782EL8-1, 70-782EL14-1	—	10	16-700DIN
5 DIN Rail End Clip	Holding the sockets firmly in place on a DIN rail	—	—	10	16-DCLIP-1
6 Insulated Coil Bus Jumper System	Wireless socket connection	70-782EL8-1, 70-782EL14-1	—	10	16-782CBJ-1
<b>Small Socket Modules</b>					
Protection Diode	Protecting the external drive circuitry from inductive voltages	70-782D14-1, 70-782E14-1, 70-782EL14-1, 70-782EL8-1	6–250 Vdc	10	70-BSMD-250
7 LED Indicator	Providing coil status at a glance		24 Vac/Vdc	10	70-BSMLG-24
MOV Suppressor	Protection from damaging electrical spikes		120 Vac/Vdc	10	70-BSMM-120
			24 Vac/Vdc	10	70-BSMM-24
			240 Vac/Vdc	10	70-BSMM-240

NOTE: Using an LED socket module can increase the coil power draw by up to 10%.

781R / 782 / 783 / 784 Plug-in Relays

781R Series—SPDT 15A

Description

The 781R Series plug-in relays offer clear or full-feature covers with multiple mounting options and accessories.



UL Listed when used with corresponding sockets



781R Clear Cover

781R Full-Feature Cover

Feature	Benefit
15 A max. switching current	Ideal choice for automation control panels
14 mm width	Slim design to save valuable space
Clear or full-feature cover options	Full-feature covers include an LED indicator and a locking test button
Socket-mounting option	Simplified installation and maintenance; use of protection modules, hold-down clips, and other accessories
Gold-flashed contacts	Reduced contact oxidation and increased shelf life
Mechanical flag indicator (standard)	Display of the relay status during testing or operation

Contact Rating	Contact Configuration	Nominal Voltage	Coil Resistance (Ω)	Standard Part Number		
				Clear Cover	Clear Cover with LED	Full-Feature
15 A	SPDT	12 Vac, 50/60 Hz	44	781XAXRC-12A	781XAXRCL-12A	781XAXRM4L-12A
		24 Vac, 50/60 Hz	177	781XAXRC-24A	781XAXRCL-24A	781XAXRM4L-24A
		48 Vac, 50/60 Hz	708	781XAXRC-48A	781XAXRCL-48A	781XAXRM4L-48A
		120 Vac, 50/60 Hz	4430	781XAXRC-120A	781XAXRCL-120A	781XAXRM4L-120A
		240 Vac, 50/60 Hz	17720	781XAXRC-240A	781XAXRCL-240A	781XAXRM4L-240A
		12 Vdc	115	781XAXRC-12D	781XAXRCL-12D	781XAXRM4L-12D
		24 Vdc	450	781XAXRC-24D	781XAXRCL-24D	781XAXRM4L-24D
		48 Vdc	1800	781XAXRC-48D	781XAXRCL-48D	781XAXRM4L-48D
		110 Vdc	9460	781XAXRC-110D	781XAXRCL-110D	781XAXRM4L-110D

**Specifications**

<b>Part Number</b>		<b>781 / 782 / 783 / 784</b>
<b>Contact Characteristics</b>		
Terminal Style	Blade	
Contact Material	Silver Alloy	
Contact Configuration	1CO / 2CO / 3CO / 4CO	
Carrying Current	15 A	
Maximum Switching Voltage	IEC: 250 Vac / 28 Vdc UL/CSA: 300 Vac / 28 Vdc	
Rated Switching Current at Voltage (Conforming to IEC AC-1 and DC-1)	at 250 Vac	N.O. : 15 A; N.C. : 7.5 A
	at 28 Vdc	N.O. : 15 A; N.C. : 7.5 A
Rated Switching Current (Conforming to UL)	Resistive	15 A at 277 Vac, 50/60 Hz, 100 k cycles 15 A at 28 Vdc, 100 k cycles
	Motor	1/2 hp at 120 Vac, 1 k cycles 1 hp at 277 Vac, 1 k cycles
	Pilot Duty	B3000
Minimum Switching Requirement	10 mA at 17 Vdc	
<b>Coil Characteristics</b>		
Maximum Operating Voltage	110% (AC/DC)	
Maximum Pickup Voltage	85% (AC/DC)	
Drop-out Voltage Threshold	15% (AC); 10% (DC)	
Average Consumption	Standard: 1.6 VA (AC); 1.1 W (DC) With LED: 1.9 VA (AC); 1.4 W (DC)	

RELAYS AND TIMERS

23

**Dimensions, in. (mm)**

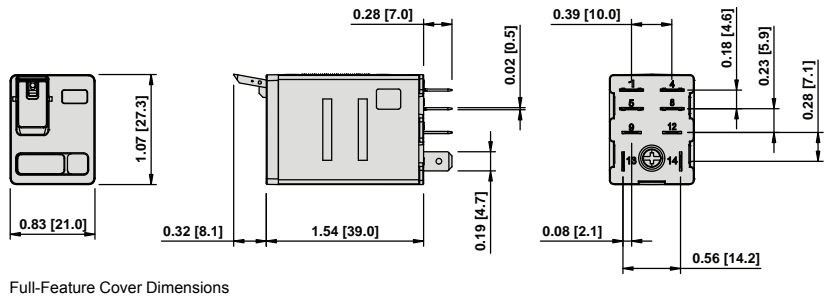
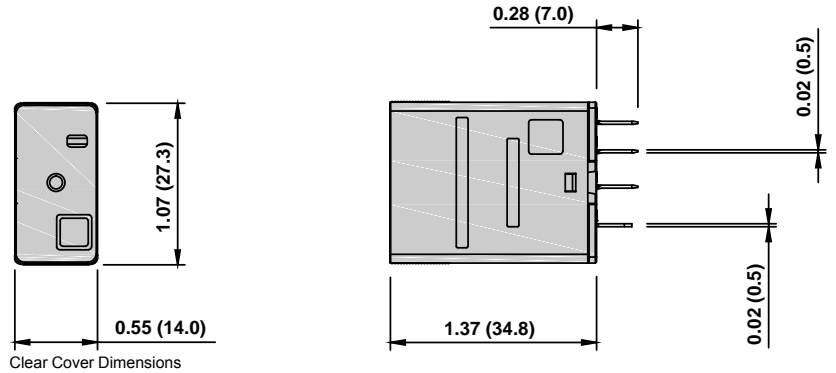

**Wiring Diagram**

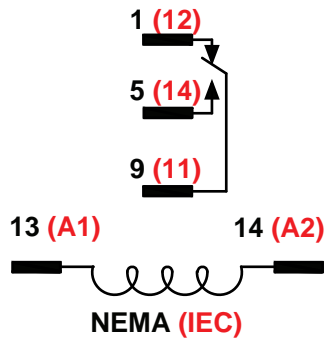

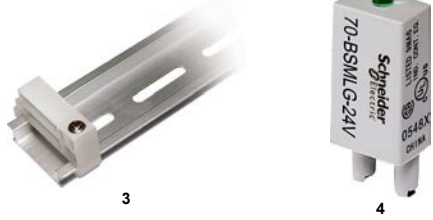
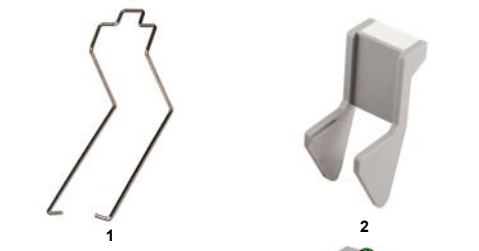

Relay Accessories

Description	Function	For Use with Relays	Pkg. Min.	Standard Part Number
1 Socket	DIN or panel mounting with screw terminals and clamping plates	781XAXR	10	70-781D5R-1A
2 Socket	PCB mounting		10	70-781T-1
3 Adapter	Direct DIN rail mounting		10	16-781C
4 Adapter	Direct panel mounting		10	16-781C1

Socket Accessories

Description	Function	For Use with Sockets	Coil Voltage	Pkg. Min.	Standard Part Number
1 Metal Spring Clip	Securing the relay in the socket	70-781D5R-1A, 70-781T-1	—	10	16-781SC
2 Plastic ID Hold-Down Clip	Securing the relay in the socket and providing labeling	70-781D5R-1A	—	10	16781IDC
3 Extruded Aluminum DIN Rail, 1 m (39.37 in.)	Quick installation and removal of sockets		—	10	16-700DIN

Small Socket Modules

Protection Diode	Protecting the external drive circuitry from inductive voltages	70-781D5R-1A	6–250 Vdc	10	70-BSMD-250
LED Indicator	Providing coil status at a glance		24 Vac/Vdc	10	70-BSMLG-24
MOV Suppressor	Protection from damaging electrical spikes		120 Vac/Vdc	10	70-BSMM-120
			24 Vac/Vdc	10	70-BSMM-24
			240 Vac/Vdc	10	70-BSMM-240

NOTE: Using an LED socket module can increase the coil power draw by up to 10%.



782 Clear Cover



782 Full-Feature Cover

**782 Power Series—DPDT 15 A**

Contact Rating	Contact Configuration	Nominal Voltage	Coil Resistance (Ω)	Standard Part Number			
				Clear Cover	Clear Cover with LED	PC Mount	Full-Feature
15 A	DPDT	6 Vac, 50/60 Hz	11	—	—	782XBXC-6A	—
		12 Vac, 50/60 Hz	44	782XBXC-12A	782XBXC-12A	782XBXC-12A	782BXM4L-12A
		24 Vac, 50/60 Hz	177	782XBXC-24A	782XBXC-24A	782XBXC-24A	782BXM4L-24A
		48 Vac, 50/60 Hz	708	782XBXC-48A	782XBXC-48A	782XBXC-48A	782BXM4L-48A
		120 Vac, 50/60 Hz	4430	782XBXC-120A	782XBXC-120A	782XBXC-120A	782BXM4L-120A
		240 Vac, 50/60 Hz	17720	782XBXC-240A	782XBXC-240A	782XBXC-240A	782BXM4L-240A
		6 Vdc	40	—	—	782XBXC-6D	—
		12 Vdc	160	782XBXC-12D	782XBXC-12D	782XBXC-12D	782BXM4L-12D
		24 Vdc	640	782XBXC-24D	782XBXC-24D	782XBXC-24D	782BXM4L-24D
		48 Vdc	2560	782XBXC-48D	782XBXC-48D	782XBXC-48D	782BXM4L-48D
		110 Vdc	13440	782XBXC-110D	782XBXC-110D	782XBXC-110D	782BXM4L-110D

**Dimensions, in. (mm)**

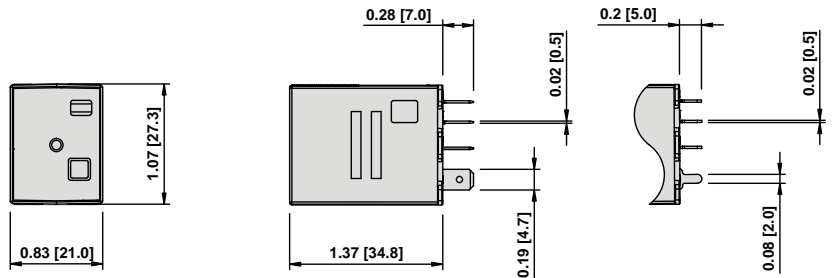

Clear Cover Dimensions

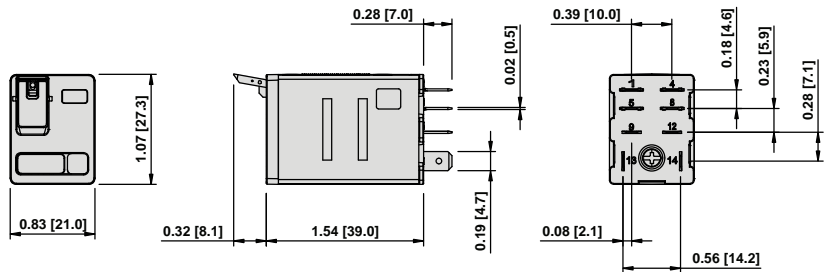

Full-Feature Cover Dimensions

**Wiring Diagram**

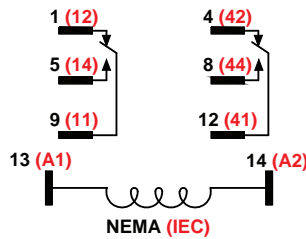

**Relay Accessories**

Description	Function	For Use with Relays	Pkg. Min.	Standard Part Number
1	Socket	DIN or panel mounting with screw terminals and clamping plates	10	70-782D8-1A
2	Socket	DIN or panel mounting with screw terminals and clamping plates	10	704591
3	Socket	Quick Connect terminals for chassis mounting	10	704011
4	Socket	Printed circuit terminals for PCB mounting	10	704021
5	Adapter	Direct panel mounting	10	16-782C1
6	Adapter	Direct DIN rail mounting	10	16-782C

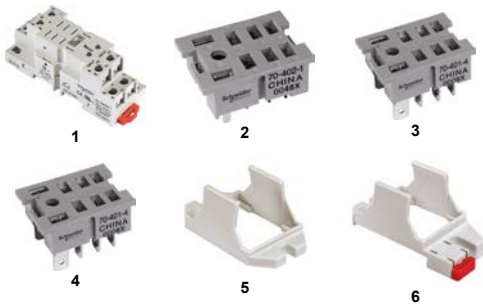



Socket Accessories

	Description	Function	For Use with Sockets	Coil Voltage	Pkg. Min.	Standard Part Number
1, 2	Metal Spring Clip	Securing the relay in the socket	70-782D8-1A, 704591, 704011, 704021	—	10	161342
3	Plastic Hold-Down Clip	Securing the relay in the socket, or ejecting the relay from the socket	70-782D8-1A	—	10	16-782PC1
4	Write-on Tag	Write-on tag for the 16-782PC1 hold-down clip	—	—	10	16-700ST-1
5	Plastic ID Hold-Down Clip	Securing the relay in the socket and providing labeling	70-782D8-1A, 704591, 704011, 704021	—	10	16-782IDC
6	Extruded Aluminum DIN Rail, 1 m (39.37 in.)	Quick installation and removal of sockets	70-782D8-1A, 704591	—	10	16-700DIN
6	DIN Rail End Clip	Holding the sockets firmly in place on a DIN rail		—	10	16-DCLIP-1
<b>Small Socket Modules</b>						
	Protection Diode	Protecting the external drive circuitry from inductive voltages	70-782D8-1A	6–250 Vdc	10	70-BSMD-250
7	LED Indicator	Providing coil status at a glance		24 Vac/Vdc	10	70-BSMLG-24
	MOV Suppressor	Protection from damaging electrical spikes		120 Vac/Vdc	10	70-BSMM-120
				24 Vac/Vdc	10	70-BSMM-24
				240 Vac/Vdc	10	70-BSMM-240

NOTE: Using an LED socket module can increase the coil power draw by up to 10%.





783 Clear Cover



783 Full-Feature Cover

**783 Series—3PDT 15 A**

Contact Rating	Contact Configuration	Nominal Voltage	Coil Resistance (Ω)	Standard Part Number		
				Clear Cover	Clear Cover with LED	Full-Feature
15 A	3PDT	12 Vac, 50/60 Hz	30	783XCXC-12A	783XCXCL-12A	783CXM4L-12A
		24 Vac, 50/60 Hz	110	783XCXC-24A	783XCXCL-24A	783CXM4L-24A
		48 Vac, 50/60 Hz	460	783XCXC-48A	783XCXCL-48A	783CXM4L-48A
		120 Vac, 50/60 Hz	2880	782DXH10-120A	783XCXCL-120A	783CXM4L-120A
		240 Vac, 50/60 Hz	11300	783XCXC-240A	783XCXCL-240A	783CXM4L-240A
		12 Vdc	80	783XCXC-12D	783XCXCL-12D	783CXM4L-12D
		24 Vdc	320	783XCXC-24D	783XCXCL-24D	783CXM4L-24D
		48 Vdc	1280	783XCXC-48D	783XCXCL-48D	783CXM4L-48D
		110 Vdc	6720	782DXH10-110D	783XCXCL-110D	783CXM4L-110D

**Dimensions, in. (mm)**

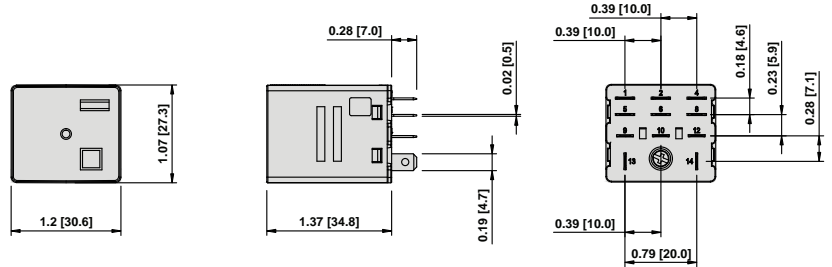

Clear Cover Dimensions

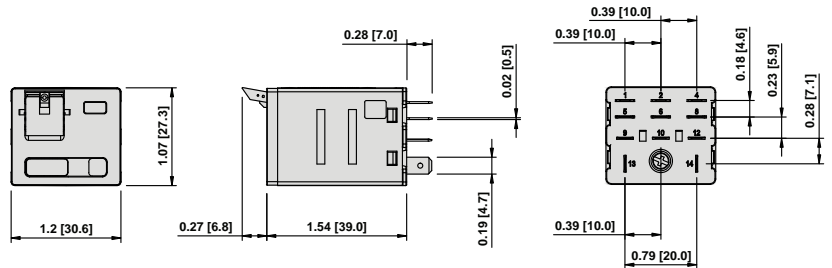

Full-Feature Cover Dimensions

**Wiring Diagram**

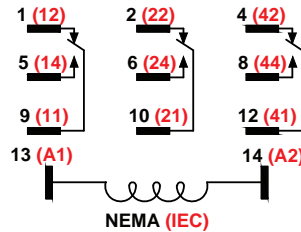

**Relay Accessories**

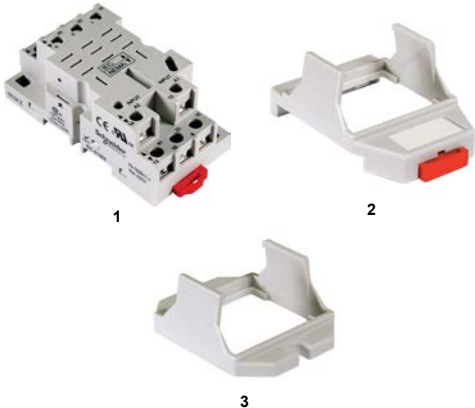

Description	Function	For Use with Relays	Pkg. Min.	Standard Part Number
1	Socket	DIN or panel mounting (finger-safe according to IP20), with screw terminals and clamping plates	10	70-783D11-1A
2	Adapter	Direct DIN rail mounting	10	16-783C
3	Adapter	Direct panel mounting	10	16-783C1

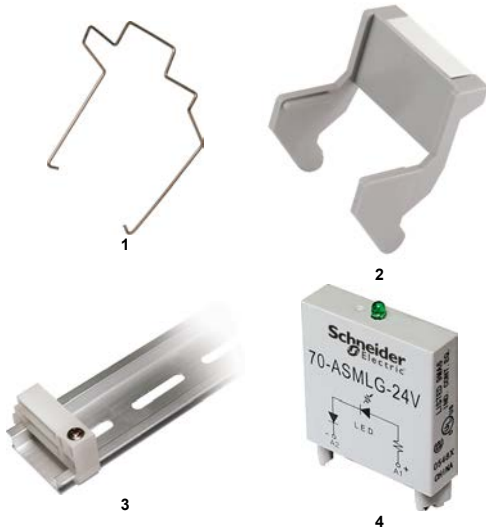

Socket Accessories

Description	Function	For Use with Sockets	Coil Voltage	Pkg. Min.	Standard Part Number
1 Metal Spring Clip	Securing the relay in the socket	70-783D11-1A	—	10	16783SC
2 Plastic ID Hold-Down Clip	Securing the relay in the socket and providing labeling		—	10	16-783IDC
3 Extruded Aluminum DIN Rail, 1 m (39.37 in.)	Quick installation and removal of sockets		—	10	16-700DIN
3 DIN Rail End Clip	Holding the sockets firmly in place on a DIN rail	—	—	10	16-DCLIP-1
<b>Large Socket Module</b>					
MOV Suppressor	Protection from damaging electrical spikes	70-783D11-1A	24 Vac/Vdc	10	70-ASMM-24
Protection Diode	Protecting the external drive circuitry from inductive voltages		250 Vdc	10	70-ASMD-250
4 LED Indicator	Providing coil status at a glance		110/240 Vac/Vdc	10	70ASMLG110/240
RC Suppressor	Snubbing back the EMF of the relay coil		110/240 Vac/Vdc	10	70ASMR110/240

NOTE: Using an LED or RC socket module can increase the coil power draw by up to 10%.

784 Series—4PDT 15 A



784 Clear Cover

784 Full-Feature Cover

Contact Rating	Contact Configuration	Nominal Voltage	Coil Resistance (Ω)	Standard Part Number		
				Clear Cover	Clear Cover with LED	Full-Feature
15 A	3PDT	12 Vac, 50/60 Hz	20	784DXC-12A	784DXCL-12A	784DXM4L-12A
		24 Vac, 50/60 Hz	80	784DXC-24A	784DXCL-24A	784DXM4L-24A
		48 Vac, 50/60 Hz	310	784DXC-48A	784DXCL-48A	784DXM4L-48A
		120 Vac, 50/60 Hz	2100	784DXC-120A	784DXCL-120A	784DXM4L-120A
		240 Vac, 50/60 Hz	8000	784DXC-240A	784DXCL-240A	784DXM4L-240A
		12 Vdc	76	784DXC-12D	784DXCL-12D	784DXM4L-12D
		24 Vdc	303	784DXC-24D	784DXCL-24D	784DXM4L-24D
		48 Vdc	1210	784DXC-48D	784DXCL-48D	784DXM4L-48D
		110 Vdc	6370	784DXC-110D	784DXCL-110D	784DXM4L-110D

Dimensions, in. (mm)

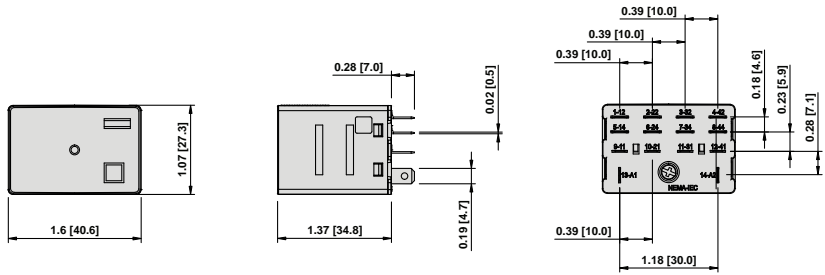

Clear Cover Dimensions

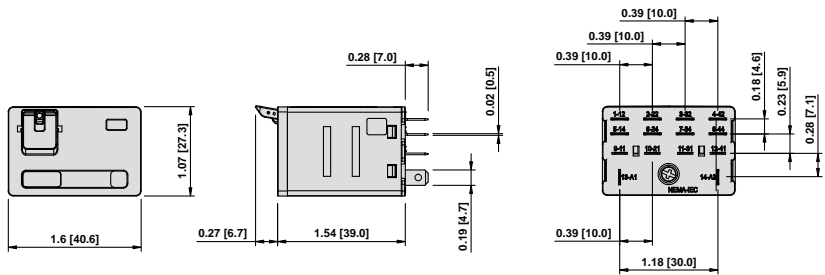

Full-Feature Cover Dimensions

**Wiring Diagram**

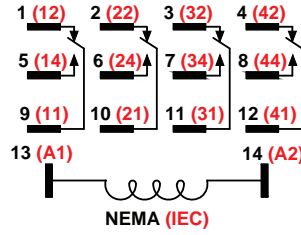

**Relay Accessories**

Description	Function	For Use with Relays	Pkg. Min.	Standard Part Number
1 Socket	DIN or panel mounting (finger-safe according to IP20), with screw terminals and clamping plates	784DXD	10	70-784D14-1
2 Adapter	Direct DIN rail mounting		10	16784C
3 Adapter	Flange mount adapter		10	16-783C1

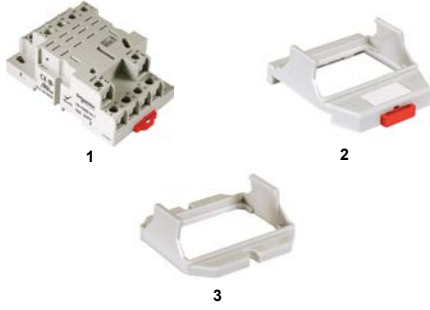

**Socket Accessories**

Description	Function	For Use with Sockets	Coil Voltage	Pkg. Min.	Standard Part Number
1 Metal Spring Clip	Securing the relay in the socket	70-784D14-1	—	10	16-784SC
2 Plastic ID Hold-Down Clip	Securing the relay in the socket and providing labeling		—	10	16-784IDC
3 Extruded Aluminum DIN Rail, 1 m (39.37 in.)	Quick installation and removal of sockets		—	10	16-700DIN
3 DIN Rail End Clip	Holding the sockets firmly in place on a DIN rail	—	—	10	16-DCLIP-1

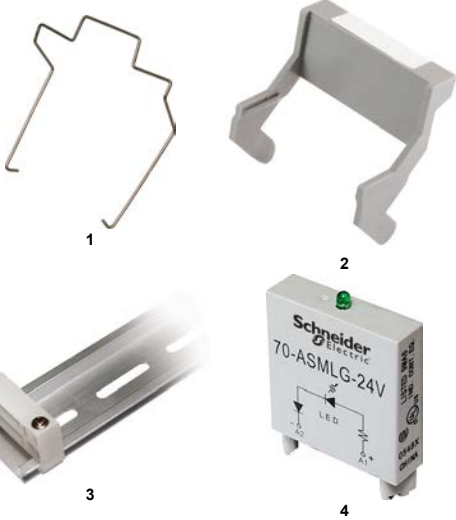

**Large Socket Module**

MOV Suppressor	Protection from damaging electrical spikes	70-784D14-1	24 Vac/Vdc	10	70-ASMM-24
Protection Diode	Protecting the external drive circuitry from inductive voltages		250 Vdc	10	70-ASMD-250
LED Indicator	Providing coil status at a glance		110/240 Vac/Vdc	10	70ASMLG110/240
RC Suppressor	Snubbing back the EMF of the relay coil		110/240 Vac	10	70ASMR110/240

**NOTE:** Using an LED or RC socket module can increase the coil power draw by up to 10%.

**750R Series Universal Relays**  
**DPDT and 3PDT, 10 A**

**Description**

The 750R series octal base, plug-in relays offer clear or full-feature covers with multiple mounting options and accessories.



UL Listed when used with corresponding sockets

23

RELAYS AND TIMERS



750R Clear Cover



750R Full-Feature Cover

Feature	Benefit
Octal style mounting	Robust and historically proven mounting platform that provides excellent structural support
10 A max. switching current	Ideal choice for automation panels and controls
Clear or full-feature cover options	Full-feature covers include an LED indicator and a locking test button
DPDT and 3PDT contact configurations	Simultaneous control of separate circuits
Socket-mounting option	Simplified installation and maintenance; use of protection modules, hold-down clips, and other accessories
Gold-flashed contacts	Reduced contact oxidation and increased shelf life
Mechanical flag indicator (standard)	Display of the relay status during testing or operation

Contact Rating	Contact Configuration	Nominal Voltage	Coil Resistance (Ω)	Standard Part Number				
				Clear Cover	Clear Cover with LED	Full-Feature		
10 A	DPDT	6 Vac, 50/60 Hz	3.9	750XBXRC-6A	—	—		
		12 Vac, 50/60 Hz	16.9	750XBXRC-12A	750XBXRCL-12A	750XBXRM4L-12A		
		24 Vac, 50/60 Hz	72	750XBXRC-24A	750XBXRCL-24A	750XBXRM4L-24A		
		48 Vac, 50/60 Hz	290	—	—	750XBXRM4L-48A		
		120 Vac, 50/60 Hz	1700	750XBXRC-120A	750XBXRCL-120A	750XBXRM4L-120A		
		240 Vac, 50/60 Hz	6800	750XBXRC-240A	750XBXRCL-240A	750XBXRM4L-240A		
	3PDT	DPDT	6 Vdc	3.9	750XBXRC-6D	—	750XBXRM4L-6D	
			12 Vdc	120	750XBXRC-12D	750XBXRCL-12D	750XBXRM4L-12D	
			24 Vdc	470	750XBXRC-24D	750XBXRCL-24D	750XBXRM4L-24D	
			48 Vdc	1800	750XBXRC-48D	750XBXRCL-48D	750XBXRM4L-48D	
			110 Vdc	7300	750XBXRC-110D	750XBXRCL-110D	750XBXRM4L-110D	
			240 Vac, 50/60 Hz	72	750XCXRC-24A	750XCXRCL-24A	750XCXRM4L-24A	
		3PDT	3PDT	48 Vac, 50/60 Hz	290	—	—	750XCXRM4L-48A
				120 Vac, 50/60 Hz	1700	750XCXRC-120A	750XCXRCL-120A	750XCXRM4L-120A
				240 Vac, 50/60 Hz	6800	750XCXRC-240A	750XCXRCL-240A	750XCXRM4L-240A
				12 Vdc	120	750XCXRC-12D	750XCXRCL-12D	750XCXRM4L-12D
				24 Vdc	470	750XCXRC-24D	750XCXRCL-24D	750XCXRM4L-24D
				48 Vdc	1800	750XCXRC-48D	750XCXRCL-48D	750XCXRM4L-48D
110 Vdc	7300	750XCXRC-110D	750XCXRCL-110D	750XCXRM4L-110D				

**Specifications**

Part Number	750XBRC	750XCRC
<b>Contact Characteristics</b>		
Terminal Style	Octal	Octal
Contact Material	Silver Alloy	Silver Alloy
Contact Configuration	DPDT	3PDT
Carrying Current	10 A	10 A
Maximum Switching Voltage	IEC: 250 Vac / 28 Vdc UL/CSA: 300 Vac / 30 Vdc	IEC: 250 Vac / 28 Vdc UL/CSA: 300 Vac / 30 Vdc
Rated Switching Current (Conforming to IEC AC-1 and DC-1)	N.O.: 10 A at 250 Vac / 28 Vdc N.C.: 5 A at 250 Vac / 28 Vdc	N.O.: 10 A at 250 Vac / 28 Vdc N.C.: 5 A at 250 Vac / 28 Vdc
Rated Switching Current (Conforming to UL)	Resistive	10 A at 277 Vac, 50/60 Hz, 200 k cycles 10 A at 30 Vdc, 200 k cycles
	Motor	1/3 hp at 120 Vac, 6 k cycles 1 hp at 277 Vac, 6 k cycles
	Pilot Duty	B300, 6 k cycles
Minimum Switching Requirement	10 mA at 17 Vdc	10 mA at 17 Vdc
<b>Coil Characteristics</b>		
Maximum Operating Voltage	110% (AC/DC)	
Maximum Pickup Voltage	85% (AC); 80% (DC)	
Drop-out Voltage Threshold	15% (AC); 10% (DC)	
Average Consumption	3 VA (AC); 1.4 W (DC)	

**Dimensions, in. (mm)**

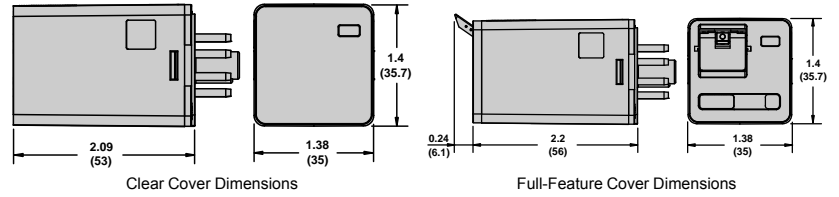

**Wiring Diagrams**

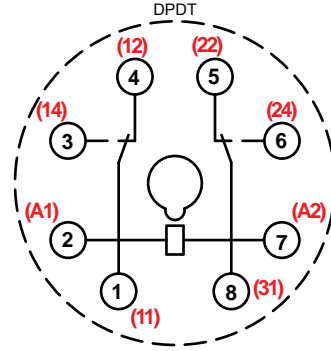

**NEMA (IEC)**

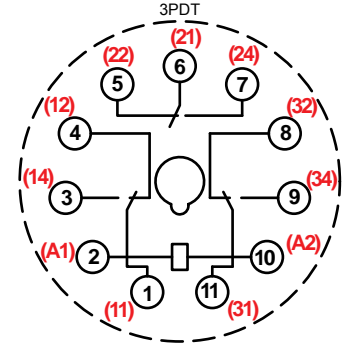

**NEMA (IEC)**

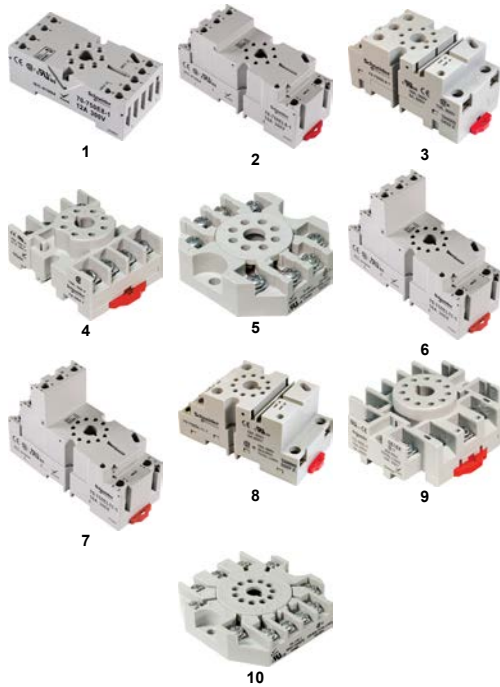

**Relay Accessories**

Description	Function	For Use with Relays	Pkg. Min.	Standard Part Number
1 Socket	DIN or panel mounting, module compatible	750XBXR	10	70750E81
2 Socket	DIN or panel mounting with elevator terminals, module compatible		10	70750EL81
3 Socket	DIN or panel mounting, module compatible		10	70-750DL8-1
4 Socket	DIN or panel mounting with screw terminals and clamping plates		10	704641
5 Socket	Panel mounting with screw terminals and clamping plates		10	701691
6 Socket	DIN or panel mounting with elevator terminals, module compatible	750XCXR	10	70750E111
7 Socket	DIN or panel mounting with elevator terminals		10	70-750E11-1
8 Socket	DIN or panel mounting, module compatible		10	70-750DL11-1
9 Socket	DIN or panel mounting with screw terminals and clamping plates		10	704651
10 Socket	Panel mounting with screw terminals and clamping plates		10	701701

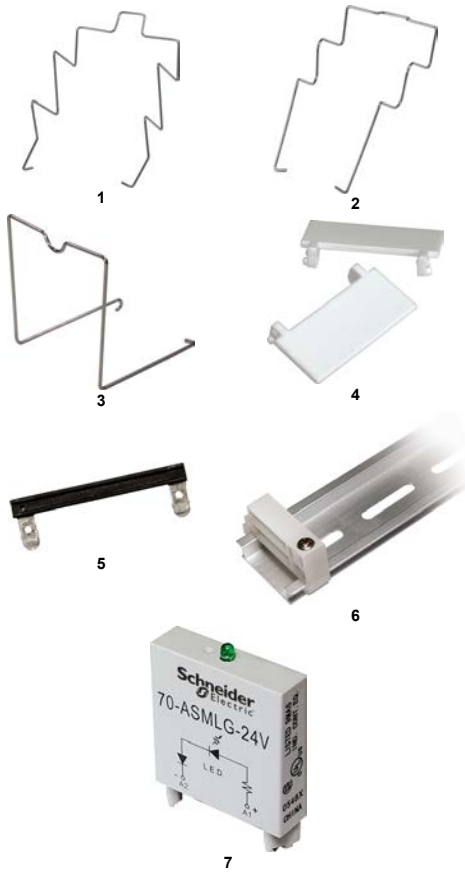

Socket Accessories

Description	Function	For Use with Sockets	Coil Voltage	Pkg. Min.	Standard Part Number
1 Metal Spring Clip	Securing the relay in the socket	70750EL81, 70750E81, 70750E111, 704641	—	10	161351
2 Metal Spring Clip	Securing the relay in the socket	70750E81, 70-750DL8-1, 70750E111, 704641	—	10	161344
3 Metal Spring Clip	Securing the relay in the socket	70-750DL8-1	—	10	161332
4 Plastic ID Tag	Write-on plastic labels	70750E81, 70750EL81, 70-750DL8-1, 70750E111, 70750EL11, 70-750DL11-1	—	10	16750/788FT1
5 Insulated Coil Bus Jumper System	Wireless socket connection	70750E81, 70750EL81, 70-750DL8-1, 70750E111, 70750EL11, 70-750DL11-1	—	10	16750/788CBJ1
6 Extruded Aluminum DIN Rail, 1 m (39.37 in.)	Quick installation and removal of sockets	70750EL81, 70750E81, 70-750DL8-1, 70750E111, 704641, 704651	—	10	16-700DIN
6 DIN Rail End Clip	Plastic end clip with locking screw	—	—	10	16-DCLIP-1
<b>Large Socket Modules</b>					
MOV Suppressor	Protection from damaging electrical spikes		24 Vac/Vdc	10	70-ASMM-24
Protection Diode	Protecting the external drive circuitry from inductive voltages	70750E81, 70750EL81, 70-750DL8-1, 70750E111, 70-750E11-1, 70-750DL11-1	250 Vdc	10	70-ASMD-250
7 LED Indicator	Providing coil status at a glance		110/240 Vac/Vdc	10	70ASMLG110/240
RC Suppressor	Snubbing back the EMF of the relay coil		110/240 Vac	10	70ASMR110/240

**NOTE:** Using an LED or RC socket module can increase the coil power draw by up to 10%.



**788R Series Universal Relays**  
**DPDT and 3PDT 10 A**

**Description**

The 788R Series square base, plug-in relays offer clear, full-feature, top flange, and side flange covers as well as optional sockets and accessories.



7885 Clear Cover

7885 Full-Feature Cover

Feature	Benefit
10 A max. switching current	Ideal choice for automation panels and controls
Clear or full-feature cover options	Full-feature covers include an LED indicator and a locking test button
DPDT and 3PDT contact configurations	Simultaneous control of separate circuits
Socket-mounting option	Simplified installation and maintenance; use of protection modules, hold-down clips, and other accessories
Gold-flashed contacts	Reduced contact oxidation and increased shelf life
Mechanical flag indicator (standard)	Display of the relay status during testing or operation

Contact Rating	Contact Configuration	Nominal Voltage	Coil Resistance (Ω)	Standard Part Number				
				Clear Cover	Clear Cover with LED	Flange Mount	Full-Feature	
10 A	DPDT	24 Vac, 50/60 Hz	72	788XBXRC-24A	788XBXRCL-24A	788XBXRC1-24A	788XBXRM4L-24A	
		48 Vac, 50/60 Hz	290	—	—	—	788XBXRM4L-48A	
		120 Vac, 50/60 Hz	1700	788XBXRC-120A	788XBXRCL-120A	788XBXRC1-120A	788XBXRM4L-120A	
		240 Vac, 50/60 Hz	6800	788XBXRC-240A	788XBXRCL-240A	788XBXRC1-240A	788XBXRM4L-240A	
		12 Vdc	120	788XBXRC-12D	788XBXRCL-12D	788XBXRC1-12D	788XBXRM4L-12D	
		24 Vdc	470	788XBXRC-24D	788XBXRCL-24D	788XBXRC1-24D	788XBXRM4L-24D	
	3PDT	3PDT	48 Vdc	1800	788XBXRC-48D	788XBXRCL-48D	788XBXRC1-48D	788XBXRM4L-48D
			110 Vdc	7300	788XBXRC-110D	788XBXRCL-110D	788XBXRC1-110D	788XBXRM4L-110D
			12 Vac, 50/60 Hz	16.9	788XCXRC-12A	—	—	—
			24 Vac, 50/60 Hz	72	788XCXRC-24A	788XCXRCL-24A	788XCXRC1-24A	788XCXRM4L-24A
			48 Vac, 50/60 Hz	290	—	—	—	788XCXRM4L-48A
			120 Vac, 50/60 Hz	1700	788XCXRC-120A	788XCXRCL-120A	788XCXRC1-120A	788XCXRM4L-120A
			240 Vac, 50/60 Hz	6800	788XCXRC-240A	788XCXRCL-240A	788XCXRC1-240A	788XCXRM4L-240A
			12 Vdc	120	788XCXRC-12D	788XCXRCL-12D	788XCXRC1-12D	788XCXRM4L-12D
24 Vdc	470	788XCXRC-24D	788XCXRCL-24D	788XCXRC1-24D	788XCXRM4L-24D			
48 Vdc	1800	788XCXRC-48D	788XCXRCL-48D	788XCXRC1-48D	788XCXRM4L-48D			
110 Vdc	7300	788XCXRC-110D	788XCXRCL-110D	788XCXRC1-110D	788XCXRM4L-110D			

**NOTE:** Magnetic blowout versions are also available with an added contact rating of 3 A at 150 Vdc. Refer to the Part Number Explanation shown below.

**Specifications**

Part Number	788XB	788XC
<b>Contact Characteristics</b>		
Terminal Style	Blade	Blade
Contact Material	Silver Alloy	Silver Alloy
Contact Configuration	DPDT	3PDT
Carrying Current	10:00 AM	10:00 AM
Maximum Switching Voltage	IEC: 250 Vac / 28 Vdc UL/CSA: 300 Vac / 30 Vdc	IEC: 250 Vac / 28 Vdc UL/CSA: 300 Vac / 30 Vdc
Rated Switching Current (Conforming to IEC AC-1 and DC-1)	N.O.: 10 A at 250 Vac / 28 Vdc N.C.: 5 A at 250 Vac / 28 Vdc	N.O.: 10 A at 250 Vac / 28 Vdc N.C.: 5 A at 250 Vac / 28 Vdc
Rated Switching Current (Conforming to UL)	Resistive	10 A at 277 Vac, 50/60 Hz, 200 k cycles 10 A at 30 Vdc, 200 k cycles
	Motor	1/3 hp at 120 Vac, 6 k cycles 1 hp at 277 Vac, 6 k cycles
	Pilot Duty	B300, 6 k cycles
Rated Current with Magnetic Blowout (Code 69)	UL: 3 A at 150 Vdc (DPDT only), 6 k cycles	UL: 3 A at 150 Vdc (DPDT only), 6 k cycles
Minimum Switching Requirement	10 mA at 17 Vdc	10 mA at 17 Vdc
<b>Coil Characteristics</b>		
Maximum Operating Voltage	110% (AC/DC)	110% (AC/DC)
Maximum Pickup Voltage	85% (AC); 80% (DC)	85% (AC); 80% (DC)
Drop-out Voltage Threshold	15% (AC); 10% (DC)	15% (AC); 10% (DC)
Average Consumption	3 VA (AC); 1.4 W (DC)	3 VA (AC); 1.4 W (DC)

Dimensions, in. (mm)

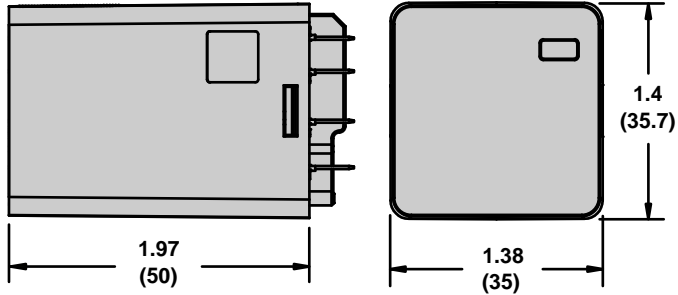

Clear Cover Dimensions

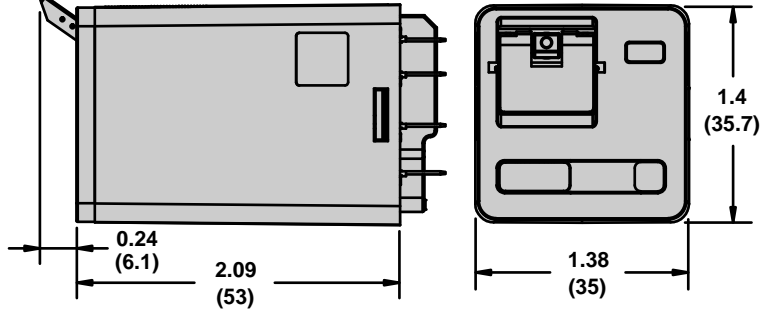

Full-Feature Cover Dimensions

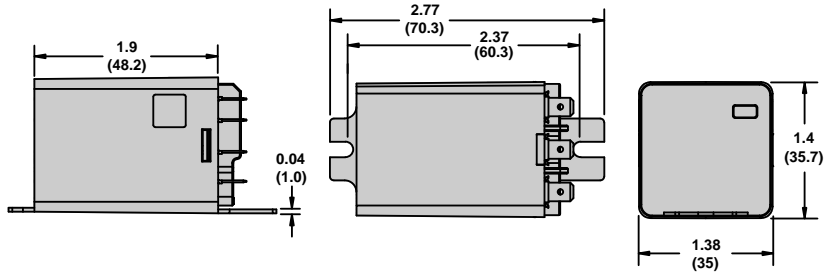

Side Flange Cover Dimensions

Wiring Diagrams

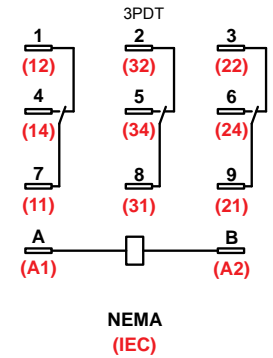
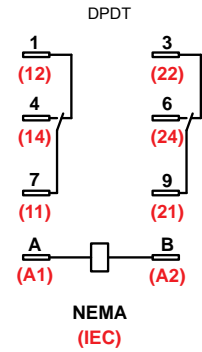
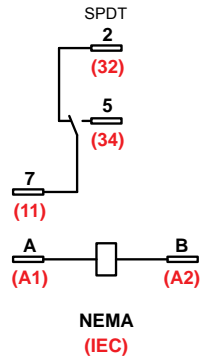



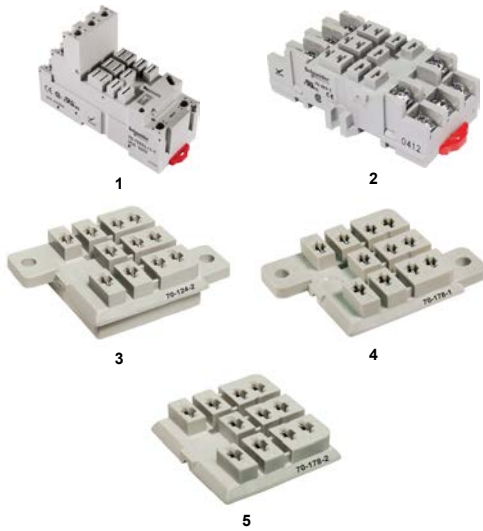

**Relay Accessories**

Description	Function	For Use with Relays	Pkg. Min.	Standard Part Number
1 Socket	DIN mounting with elevator terminals	788XBXR/ XCXR	10	70-788EL11-1
2 Socket	DIN or panel mounting with screw terminals and clamping plates		10	704631
3 Socket	0.187 in. Quick Connect terminals with mounting tabs		10	701242
4 Socket	Printed circuit terminals—with mounting tabs		10	701781
5 Socket	Printed circuit terminals—without mounting tabs		10	701782

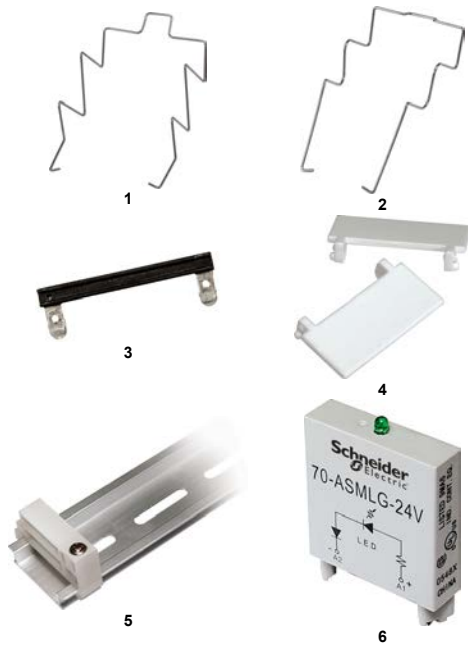

**Socket Accessories**

Description	Function	For Use with Sockets	Coil Voltage	Pkg. Min.	Standard Part Number
1 Metal Spring Clip	Securing the relay in the socket	70-788EL11-1, 704631, 701241, 701781, 701782	—	10	161351
2 Metal Spring Clip	Securing the relay in the socket	704631	—	10	161344
3 Insulated Coil Bus Jumper System	Wireless socket connection	70-788EL11-1	—	10	16750/788CBJ1
4 Plastic ID Tag	Write-on plastic labels		—	10	16750/788FT1
5 Extruded Aluminum DIN Rail, 1 m (39.37 in.)	Quick installation and removal of sockets	70-788EL11-1, 704631	—	10	16-700DIN
5 DIN Rail End Clip	Holding the sockets firmly in place on a DIN rail	—	—	10	16-DCLIP-1

**Large Socket Modules**

MOV Suppressor	Protection from damaging electrical spikes	70-788EL11-1	24 Vac/Vdc	10	70-ASMM-24
Protection Diode	Protecting the external drive circuitry from inductive voltages		250 Vdc	10	70-ASMD-250
6 LED Indicator	Providing coil status at a glance		110/240 Vac/Vdc	10	70ASMLG110/240
RC Suppressor	Snubbing back the EMF of the relay coil		110/240 Vac	10	70ASMR110/240

**Socket Specifications**  
701242 Socket Specifications

<b>Part Number</b>		<b>701242</b>
Contact Configuration		3PDT
Number of Terminals		11
Mounting Style		Panel / Chassis
Current Rating		15 A
Nominal Voltage Rating		300 V
Temperature Range	Storage	-40 to +105°C (-40 to +221°F)
	Operating	-40 to +55°C (-40 to +131°F)
Protection Category		IP20
Internal Metal Tracks		Copper Alloy, Zinc Plated
Screw Terminals		Copper Alloy, Zinc Plated
Screw Style		—
Screw Size		—
Maximum Screw Torque		—
Terminal Connection		Solder
Terminal Layout		Mix
Maximum Wire Size	Solid Copper (Output)	16 AWG, 1.0 mm <sup>2</sup>
	Stranded Copper (Output)	16 AWG, 1.0 mm <sup>2</sup>
DIN Rail Mounting, EN 60715		—
Chassis Mount Screw Torque		—
Flammability Rating		94V-0
Weight		12.1 g (0.43 oz)
Agency Approvals		UL (E70550), CE, CSA (LR40787), RoHS

**Dimensions, in. (mm)**

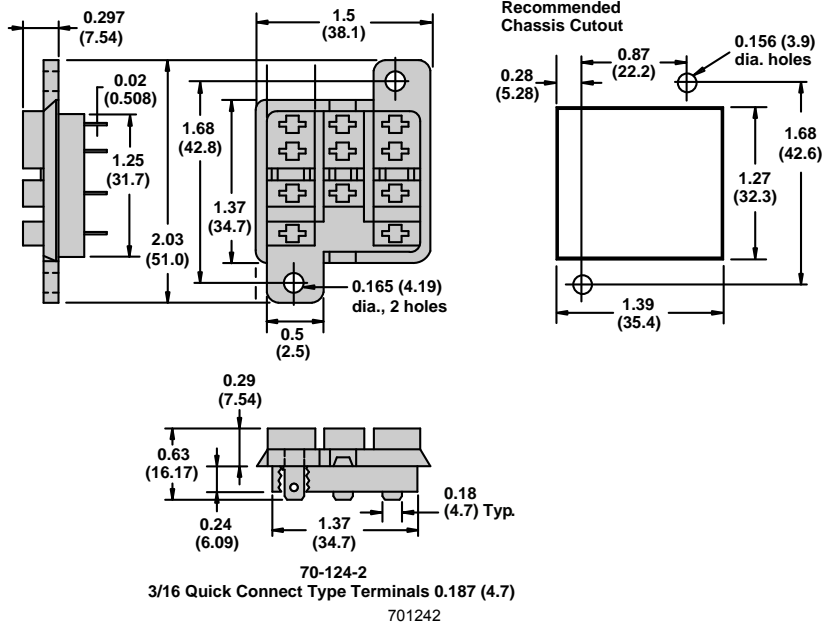

**Wiring Diagram**

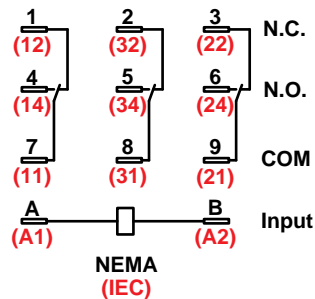

**701691 and 701701 Socket Specifications**

Part Number		701691	701701
Contact Configuration		DPDT	3PDT
Number of Terminals		8	11
Mounting Style		Panel	Panel
Current Rating		15 A	15 A
Nominal Voltage Rating		300 V	300 V
Temperature Range	Storage	-40 to +105°C (-40 to +221°F)	-40 to +105°C (-40 to +221°F)
	Operating	-40 to +55°C (-40 to +131°F)	-40 to +55°C (-40 to +131°F)
Protection Category		—	—
Internal Metal Tracks		Copper Alloy, Zinc Plated	Copper Alloy, Zinc Plated
Screw Terminals		Steel, Zinc Plated	Steel, Zinc Plated
Screw Style		Combination Head	Combination Head
Screw Size		M3.5 mm	M3.5 mm
Maximum Screw Torque		9 lb-in (1.0 N•m)	9 lb-in (1.0 N•m)
Terminal Connection		Screw Clamping	Screw Clamping
Terminal Layout		Mix	Mix
Maximum Wire Size	Solid Copper	Two 14–12 AWG (two 2.5–4 mm <sup>2</sup> )	Two 14–12 AWG (two 2.5–4 mm <sup>2</sup> )
	Stranded Copper	Two 14–12 AWG (two 2.5–4 mm <sup>2</sup> )	Two 14–12 AWG (two 2.5–4 mm <sup>2</sup> )
DIN Rail Mounting, EN 60715		35 mm	35 mm
Chassis Mount Screw Torque		7 lb-in (0.8 N•m)	7 lb-in (0.8 N•m)
Flammability Rating		94V-0	94V-0
Weight		57 g (2.01 oz)	57 g (2.01 oz)
Agency Approvals		UL (E70550), CE, CSA (LR97899), RoHS	UL (E70550), CE, CSA (LR97899), RoHS

**Dimensions, in, (mm)**

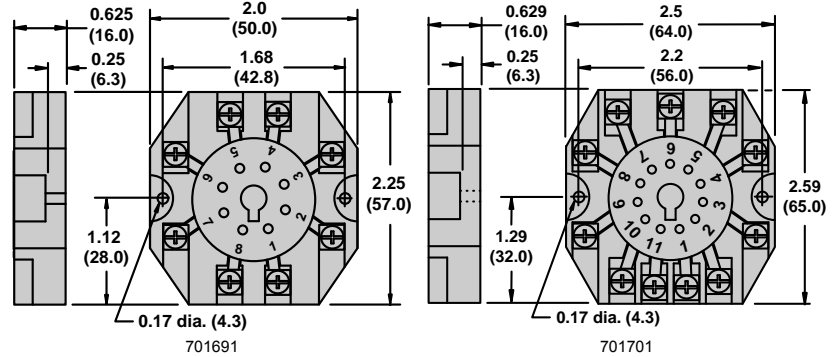

**Wiring Diagrams**

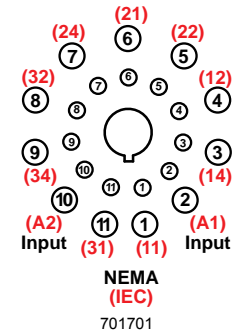
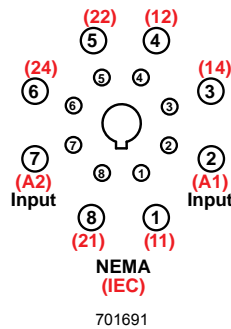

701781 and 701782 Socket Specifications

Part Number	701781	701782
Contact Configuration	3PDT	3PDT
Number of Terminals	11	11
Mounting Style	Panel / PCB	PCB
Current Rating	15 A	15 A
Nominal Voltage Rating	300 V	300 V
Temperature Range	Storage	-40 to +105°C (-40 to +221°F)
	Operating	-40 to +55°C (-40 to +131°F)
Protection Category	IP20	IP20
Internal Metal Tracks	Copper Alloy, Zinc Plated	Copper Alloy, Zinc Plated
Screw Terminals	Copper Alloy, Zinc Plated	Copper Alloy, Zinc Plated
Screw Style	—	—
Screw Size	—	—
Maximum Screw Torque	—	—
Terminal Connection	PCB	PCB
Terminal Layout	Mix	Mix
Maximum Wire Size	Solid Copper (Output)	16 AWG, 1.0 mm <sup>2</sup>
	Stranded Copper (Output)	16 AWG, 1.0 mm <sup>2</sup>
DIN Rail Mounting, EN 60715	—	—
Chassis Mount Screw Torque	—	—
Flammability Rating	94V-0	94V-0
Weight	12.1 g (0.43 oz)	12.1 g (0.43 oz)
Agency Approvals	UL (E70550), CE, CSA (LR40787), RoHS	UL (E70550), CE, CSA (LR40787), RoHS

Dimensions, in. (mm)

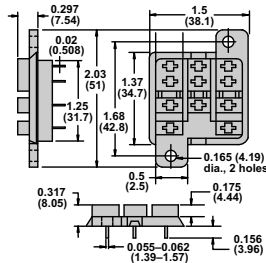

70178

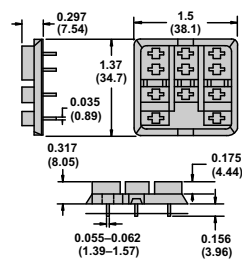

701782

Recommended Circuit Board Layout

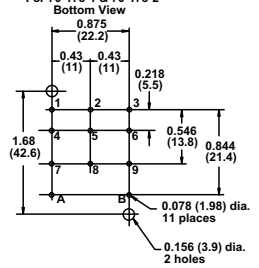

Wiring Diagram

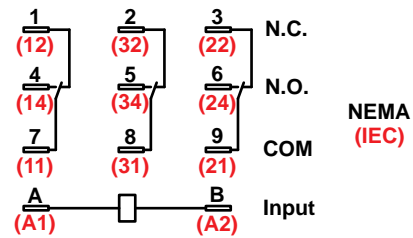

701781 and 701782

**703781 and 703791 Socket Specifications**

Part Number	703781	703791
Contact Configuration	4PDT	4PDT
Number of Terminals	14	14
Mounting Style	Chassis	PCB
Current Rating	5 A	5 A
Nominal Voltage Rating	120 V	120 V
Temperature Range	Storage	-40 to +105°C (-40 to +221°F)
	Operating	-40 to +55°C (-40 to +131°F)
Protection Category	—	—
Internal Metal Tracks	Copper Alloy, Zinc Plated	Copper Alloy, Zinc Plated
Screw Terminals	Copper Alloy, Zinc Plated	Copper Alloy, Zinc Plated
Screw Style	—	—
Screw Size	—	—
Maximum Screw Torque	—	—
Terminal Connection	Solder	PCB
Terminal Layout	Mix	Mix
Maximum Wire Size	Solid Copper (Output)	18 AWG, 0.8 mm <sup>2</sup>
	Stranded Copper (Output)	18 AWG, 0.8 mm <sup>2</sup>
DIN Rail Mounting, EN 60715	35 mm	—
Chassis Mount Screw Torque	7 lb-in (0.8 N·m)	—
Flammability Rating	94V-0	94V-0
Weight	6.2 g (0.22 oz)	5.8 g (0.20 oz)
Agency Approvals	UL (E70550), CE, CSA (LR40787), RoHS	UL (E70550), CE, CSA (LR40787), RoHS

**Dimensions, in, (mm)**

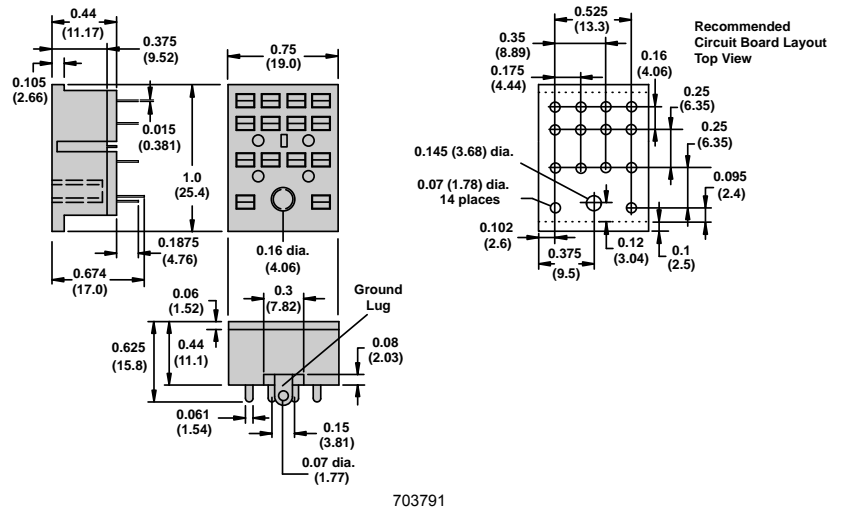
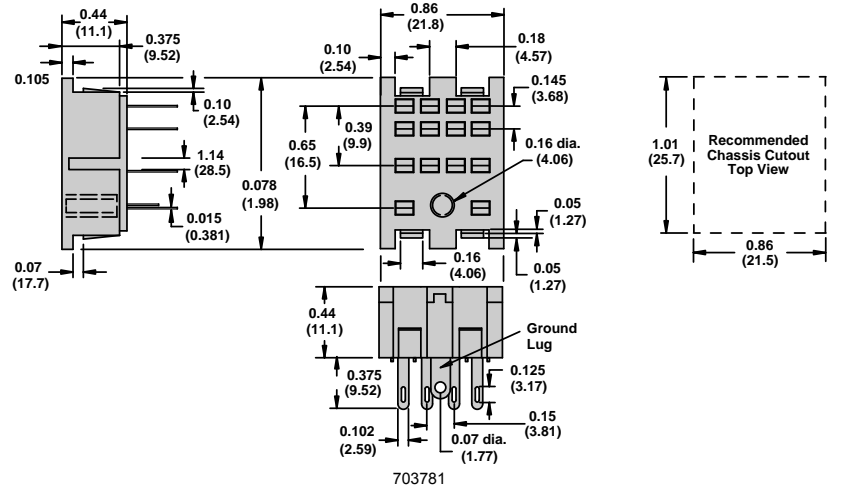

Wiring Diagrams

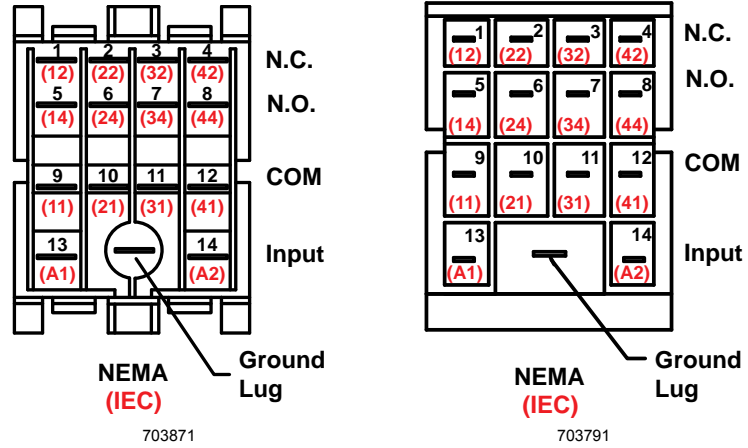

704011 and 704021 Socket Specifications

Part Number	704011	704021
Contact Configuration	DPDT	DPDT
Number of Terminals	8	8
Mounting Style	Chassis	PCB
Current Rating	10 A	10 A
Nominal Voltage Rating	300 V	300 V
Temperature Range	Storage	-40 to +105°C (-40 to +221°F)
	Operating	-40 to +55°C (-40 to +131°F)
Protection Category	—	—
Internal Metal Tracks	Copper Alloy, Zinc Plated	Copper Alloy, Zinc Plated
Screw Terminals	Copper Alloy, Zinc Plated	Copper Alloy, Zinc Plated
Screw Style	Combination Head	—
Screw Size	M3.5 mm	—
Maximum Screw Torque	9 lb-in (1.0 N•m)	—
Terminal Connection	Solder	PCB
Terminal Layout	Mix	Mix
Maximum Wire Size	Solid Copper (Output)	18 AWG, 0.8 mm <sup>2</sup>
	Stranded Copper (Output)	18 AWG, 0.8 mm <sup>2</sup>
DIN Rail Mounting, EN 60715	—	—
Chassis Mount Screw Torque	7 lb-in (0.8 N•m)	—
Flammability Rating	94V-0	94V-0
Weight	6.2 g (0.22 oz)	6.5 g (0.23 oz)
Agency Approvals	UL (E70550), CE, RoHS	UL (E70550), CE, RoHS

Dimensions, in, (mm)

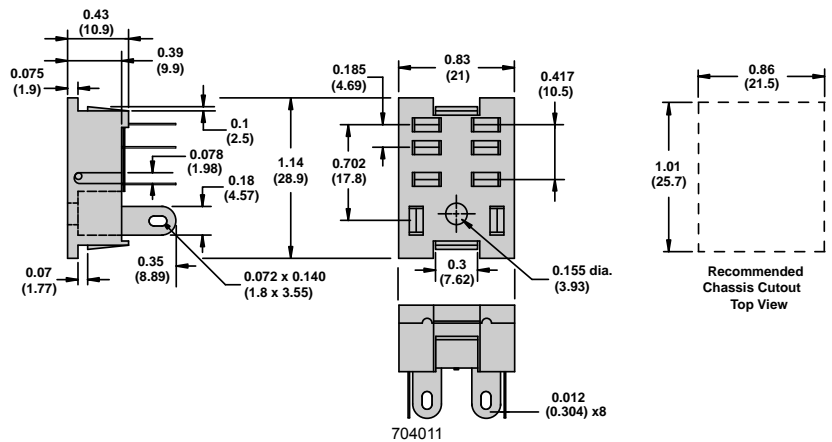

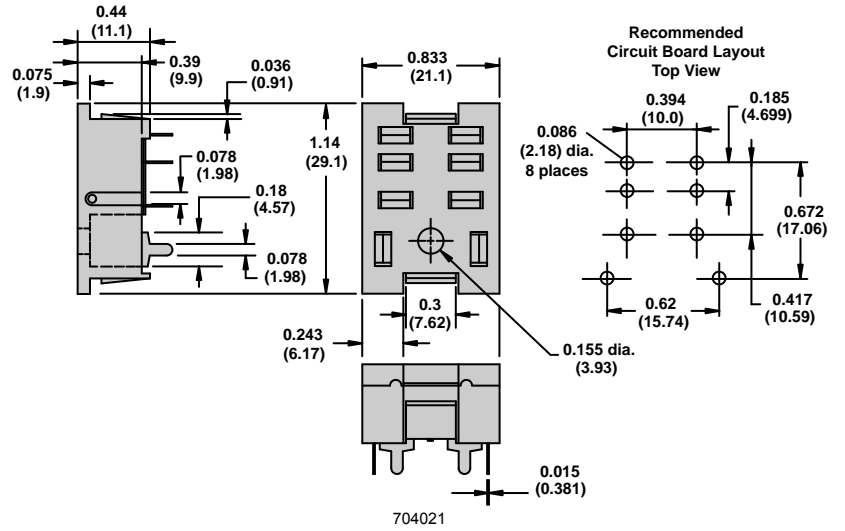

**Wiring Diagrams**

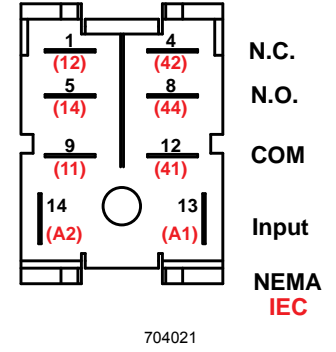
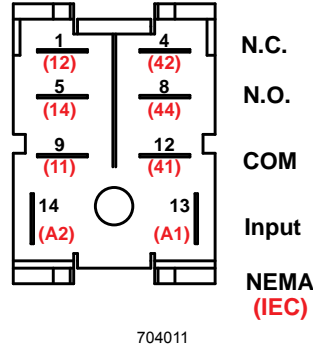

704591, 704611, and 70463 Socket Specifications

Part Number	704591	704611	704631
Contact Configuration	DPDT	4PDT	3PDT
Number of Terminals	8	14	11
Mounting Style	Panel or DIN rail	Panel or DIN rail	Panel or DIN rail
Current Rating	10 A	10 A	15 A
Nominal Voltage Rating	300 V	300 V	300 V
Temperature Range	Storage	-40 to +105°C (-40 to +221°F)	-40 to +105°C (-40 to +221°F)
	Operating	-40 to +55°C (-40 to +131°F)	-40 to +70°C (-40 to +158°F)
Protection Category	—	—	—
Internal Metal Tracks	Copper Alloy, Zinc Plated	Copper Alloy, Zinc Plated	Copper Alloy, Zinc Plated
Screw Terminals	Steel, Zinc Plated	Steel, Zinc Plated	Steel, Zinc Plated
Screw Style	Combination Head	Combination Head	Combination Head
Screw Size	M3.5 mm	M3 mm	M3.5 mm
Maximum Screw Torque	9 lb-in (1.0 N·m)	7 lb-in (0.8 N·m)	9 lb-in (1.0 N·m)
Terminal Connection	Screw Clamping	Screw Clamping	Screw Clamping
Terminal Layout	Mix	Mix	Mix
Maximum Wire Size	Solid Copper	Two 14–12 AWG (two 2.5–4 mm <sup>2</sup> )	Two 16–14 AWG (two 1.5–2.5 mm <sup>2</sup> )
	Stranded Copper	Two 14–12 AWG (two 2.5–4 mm <sup>2</sup> )	Two 16–14 AWG (two 1.5–2.5 mm <sup>2</sup> )
DIN Rail Mounting, EN 60715	35 mm	35 mm	35 mm
Chassis Mount Screw Torque	7 lb-in (0.8 N·m)	7 lb-in (0.8 N·m)	7 lb-in (0.8 N·m)
Flammability Rating	94V-0	94V-0	94V-0
Weight	50 g (1.76 oz)	50 g (1.76 oz)	51 g (1.79 oz)
Agency Approvals	UL (E70550), CE, CSA (LR97899), RoHS	UL (E70550), CE, CSA (LR97899), RoHS	UL (E70550), CE, CSA (LR97899), RoHS

Dimensions, in, (mm)

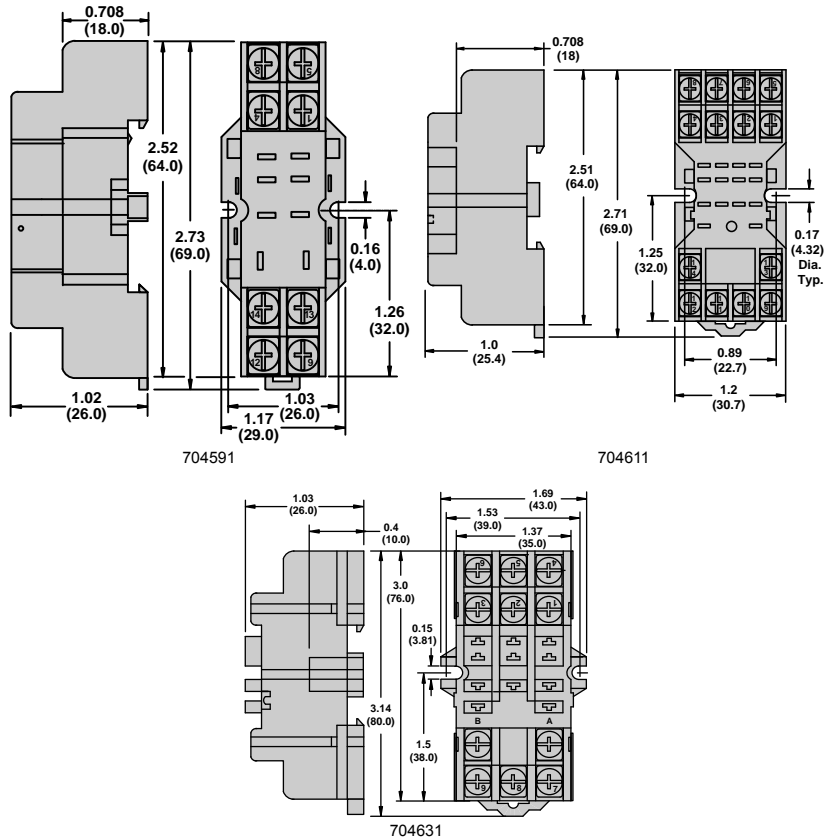



**Wiring Diagrams**

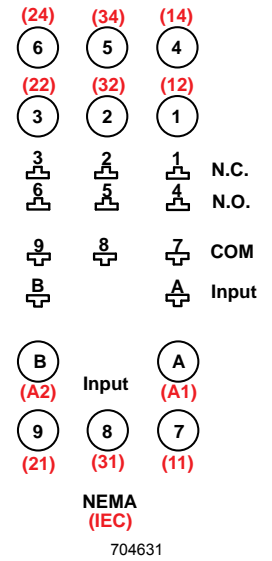
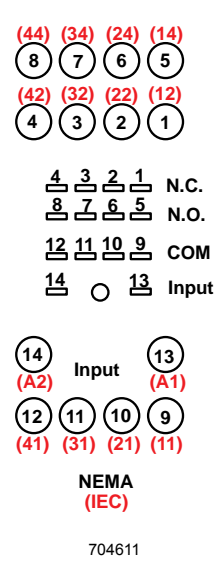
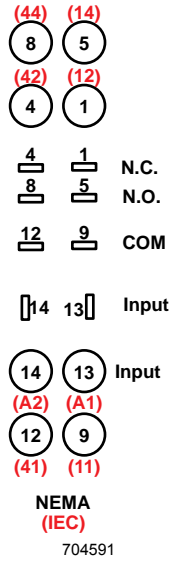

704641 and 704651 Socket Specifications

<b>Contact Configuration</b>		8	11
Number of Terminals		8	11
Mounting Style		Panel or DIN rail	Panel or DIN rail
Current Rating		15 / 10 A	15 / 5 A
Nominal Voltage Rating		300 / 600 V	300 / 600 V
Temperature Range	Storage	-40 to +105°C (-40 to +221°F)	-40 to +105°C (-40 to +221°F)
	Operating	-40 to +55°C (-40 to +131°F)	-40 to +55°C (-40 to +131°F)
Protection Category		—	—
Internal Metal Tracks		Copper Alloy, Zinc Plated	Copper Alloy, Zinc Plated
Screw Terminals		Steel, Zinc Plated	Steel, Zinc Plated
Screw Style		Combination Head	Combination Head
Screw Size		M3.5 mm	M3.5 mm
Maximum Screw Torque		9 lb-in (1.0 N•m)	9 lb-in (1.0 N•m)
Terminal Connection		Screw Clamping	Screw Clamping
Terminal Layout		Mix	Mix
Maximum Wire Size	Solid Copper	Two 14–12 AWG (two 2.5–4 mm <sup>2</sup> )	Two 14–12 AWG (two 2.5–4 mm <sup>2</sup> )
	Stranded Copper	Two 14–12 AWG (two 2.5–4 mm <sup>2</sup> )	Two 14–12 AWG (two 2.5–4 mm <sup>2</sup> )
DIN Rail Mounting, EN 60715		35 mm	35 mm
Chassis Mount Screw Torque		7 lb-in (0.8 N•m)	7 lb-in (0.8 N•m)
Flammability Rating		94V-0	94V-0
Weight		40 g (1.41 oz)	57 g (2.01 oz)
Agency Approvals		UL (E70550), CE, CSA (LR97899), RoHS	UL (E70550), CE, CSA (LR97899), RoHS

Dimensions, in. (mm)

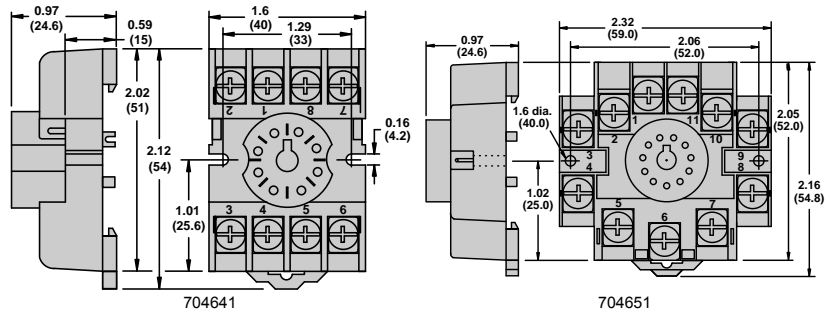

Wiring Diagrams

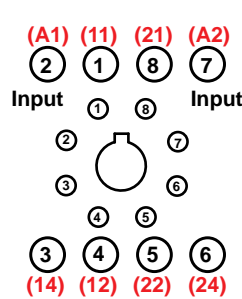

704641

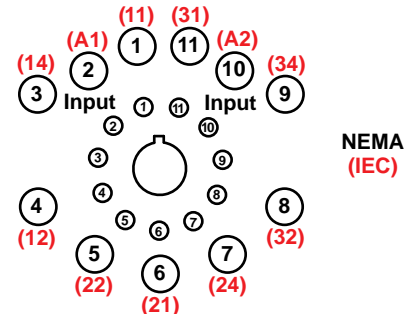

704651

**70-750DL8-1 and 70-750DL11-1 Socket Specifications**

Part Number	70-750DL8-1	70-750DL11-1
Contact Configuration	DPDT	3PDT
Number of Terminals	8	11
Mounting Style	Panel or DIN rail	Panel or DIN rail
Current Rating	16 A	16 A
Nominal Voltage Rating	300 V	600 V
Temperature Range	Storage	-40 to +105°C (-40 to +221°F)
	Operating	-40 to +55°C (-40 to +131°F)
Protection Category	IP20	IP20
Internal Metal Tracks	Copper Alloy, Zinc Plated	Copper Alloy, Zinc Plated
Screw Terminals	Steel, Zinc Plated	Steel, Zinc Plated
Screw Style	Combination Head	Combination Head
Screw Size	M3.5 mm	M3.5 mm
Maximum Screw Torque	9 lb-in (1.0 N•m)	9 lb-in (1.0 N•m)
Terminal Connection	Screw Clamping	Screw Clamping
Terminal Layout	Mix	Mix
Maximum Wire Size	Solid Copper	Two 14–12 AWG (two 2.5–4 mm <sup>2</sup> )
	Stranded Copper	Two 14–12 AWG (two 2.5–4 mm <sup>2</sup> )
DIN Rail Mounting, EN 60715	35 mm	35 mm
Chassis Mount Screw Torque	7 lb-in (0.8 N•m)	7 lb-in (0.8 N•m)
Flammability Rating	94V-0	94V-0
Weight	60 g (2.12 oz)	78 g (2.75 oz)
Agency Approvals	UL (E70550), CE, CSA (LR40787), RoHS	UL (E70550), CE, CSA (LR40787), RoHS

**Dimensions, in, (mm)**

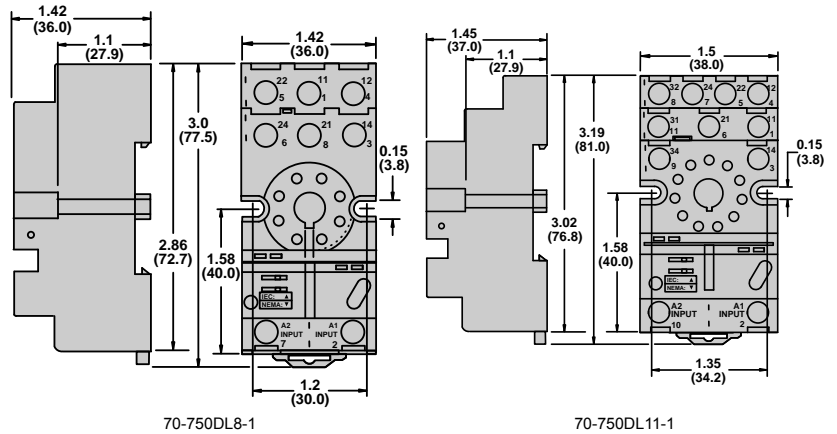

**Wiring Diagrams**

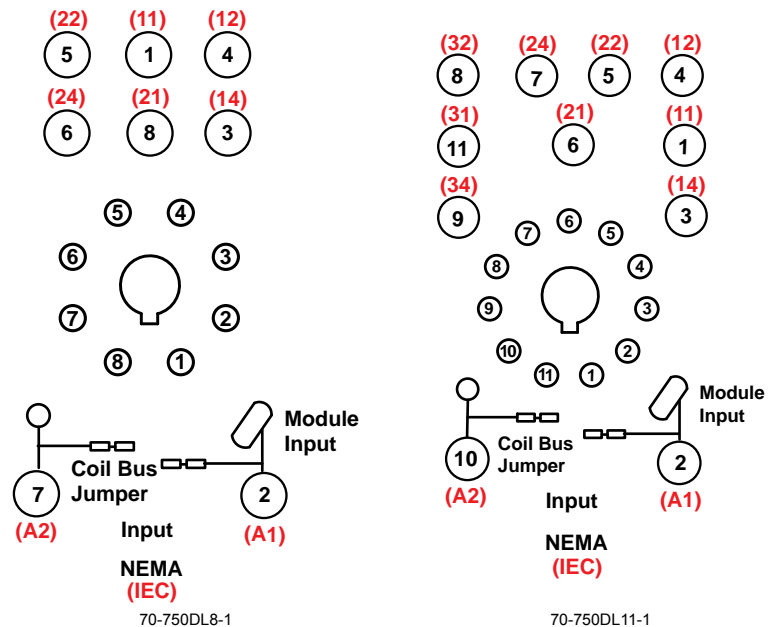

70750E81 and 70750E111 Socket Specifications

Part Number		70750E81	70750E111
Contact Configuration		DPDT	3PDT
Number of Terminals		8	11
Mounting Style		Panel or DIN rail	Panel or DIN rail
Current Rating		12 A	12 A
Nominal Voltage Rating		300 V	300 V
Temperature Range	Storage	-40 to +105°C (-40 to +221°F)	-40 to +105°C (-40 to +221°F)
	Operating	-40 to +55°C (-40 to +131°F)	-40 to +55°C (-40 to +131°F)
Protection Category		IP20	IP20
Internal Metal Tracks		Copper Alloy, Zinc Plated	Copper Alloy, Zinc Plated
Screw Terminals		Steel, Zinc Plated	Steel, Zinc Plated
Screw Style		Combination Head	Combination Head
Screw Size		M3.5 mm	M3.5 mm
Maximum Screw Torque		9 lb-in (1.0 N•m)	9 lb-in (1.0 N•m)
Terminal Connection		Elevator	Elevator
Terminal Layout		Separate	Separate
Maximum Wire Size	Solid Copper	Two 14–12 AWG (two 2.5–4 mm <sup>2</sup> )	Two 14–12 AWG (two 2.5–4 mm <sup>2</sup> )
	Stranded Copper	Two 14–12 AWG (two 2.5–4 mm <sup>2</sup> )	Two 14–12 AWG (two 2.5–4 mm <sup>2</sup> )
DIN Rail Mounting, EN 60715		35 mm	35 mm
Chassis Mount Screw Torque		7 lb-in (0.8 N•m)	7 lb-in (0.8 N•m)
Flammability Rating		94V-0	94V-0
Weight		85 g (3.0 oz)	85 g (3.0 oz)
Agency Approvals		UL (E70550), CE, CSA (LR40787), RoHS	UL (E70550), CE, CSA (LR40787), RoHS

Dimensions, in. (mm)

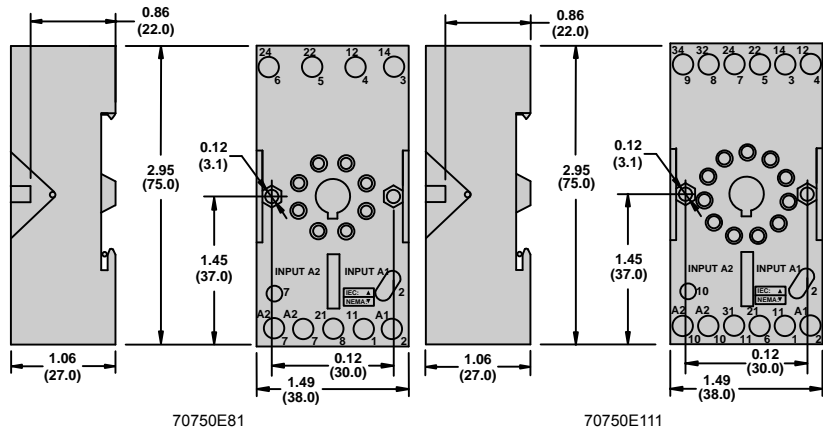

Wiring Diagrams

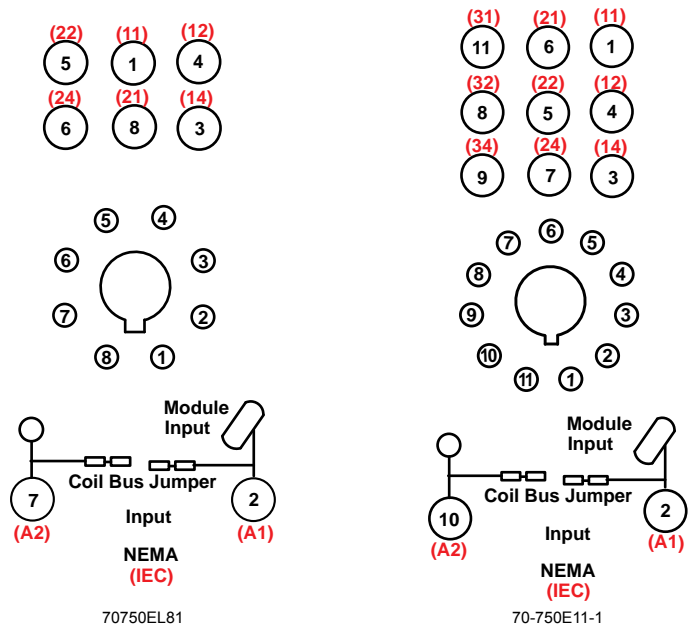

**70750EL81 and 70-750E11-1 Socket Specifications**

Part Number	70750EL81	70-750E11-1
Contact Configuration	DPDT	3PDT
Number of Terminals	8	11
Mounting Style	Panel or DIN rail	Panel or DIN rail
Current Rating	16 A	16 A
Nominal Voltage Rating	300 V	300 V
Temperature Range	Storage	-40 to +105°C (-40 to +221°F)
	Operating	-40 to +55°C (-40 to +131°F)
Protection Category	Storage	-40 to +105°C (-40 to +221°F)
	Operating	-40 to +55°C (-40 to +131°F)
Protection Category	IP20	IP20
Internal Metal Tracks	Copper Alloy, Zinc Plated	Copper Alloy, Zinc Plated
Screw Terminals	Steel, Zinc Plated	Steel, Zinc Plated
Screw Style	Combination Head	Combination Head
Screw Size	M3.5 mm	M3.5 mm
Maximum Screw Torque	9 lb-in (1.0 N·m)	9 lb-in (1.0 N·m)
Terminal Connection	Elevator	Elevator
Terminal Layout	Separate	Separate
Maximum Wire Size	Solid Copper	Two 14–12 AWG (two 2.5–4 mm <sup>2</sup> )
	Stranded Copper	Two 14–12 AWG (two 2.5–4 mm <sup>2</sup> )
DIN Rail Mounting, EN 60715	35 mm	35 mm
Chassis Mount Screw Torque	7 lb-in (0.8 N·m)	7 lb-in (0.8 N·m)
Flammability Rating	94V-0	94V-0
Weight	79 g (2.79 oz)	79 g (2.79 oz)
Agency Approvals	UL (E70550), CE, CSA (LR40787), RoHS	UL (E70550), CE, CSA (LR40787), RoHS

**Dimensions, in., (mm)**

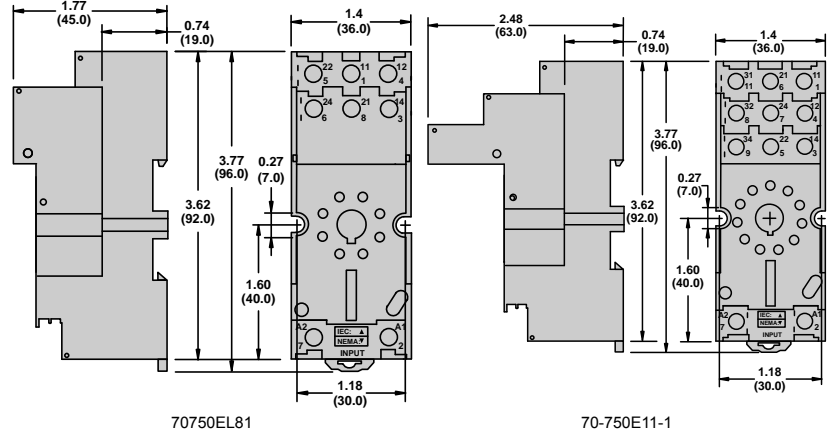

70750EL81

70-750E11-1

**Wiring Diagrams**

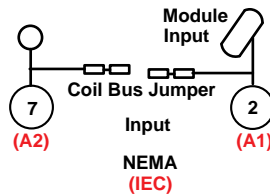
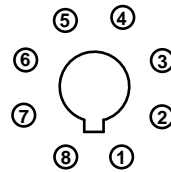
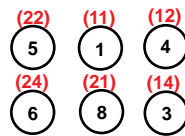

70750EL81

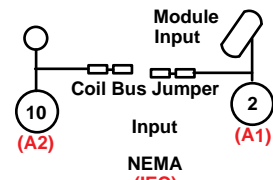
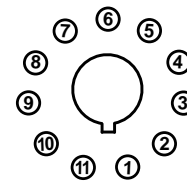
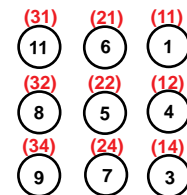

70-750E11-1

70-781D5R-1A and 70-781T-1 Socket Specifications

<b>Part Number</b>		70-781D5R-1A	70-781T-1
Contact Configuration		SPDT	SPDT
Number of Terminals		5	5
Mounting Style		Panel or DIN rail	PCB
Current Rating		16 A	10 A
Nominal Voltage Rating		300 V	300 V
Temperature Range	Storage	-40 to +85°C (-40 to +185°F)	-40 to +105°C (-40 to +221°F)
	Operating	-40 to +55°C (-40 to +131°F)	-40 to +55°C (-40 to +131°F)
Protection Category		IP20	—
Internal Metal Tracks		Copper Alloy, Zinc Plated	Copper Alloy, Zinc Plated
Screw Terminals		Steel, Zinc Plated	Copper Alloy, Zinc Plated
Screw Style		Combination Head	—
Screw Size		M3 mm / M3.5 mm	—
Maximum Screw Torque	M3	7 lb-in (0.8 N•m)	—
	M3.5	9 lb-in (1.0 N•m)	—
Terminal Connection		Screw Clamping	PCB
Terminal Layout		Mix	Mix
Maximum Wire Size	Solid Copper	Two 12 AWG (two 4 mm <sup>2</sup> ) without cable end	—
	Stranded Copper	Two 14 AWG (two 2.5 mm <sup>2</sup> ) with cable end	—
DIN Rail Mounting, EN 60715		35 mm	—
Chassis Mount Screw Torque		7 lb-in (0.8 N•m)	—
Flammability Rating		94V-0	94V-0
Weight		31 g (1.09 oz)	18 g (0.63 oz)
Agency Approvals		UL (E70550), CE, CSA (168986), RoHS	UL (E70550), CE, RoHS

Dimensions, in. (mm)

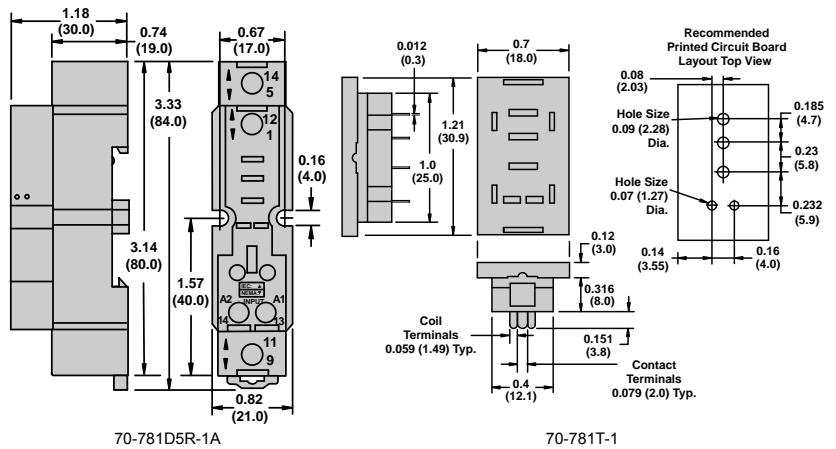

Wiring Diagrams

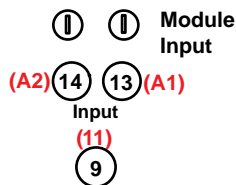
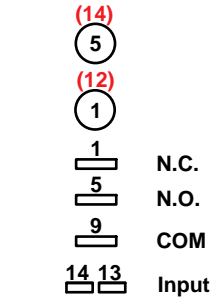

NEMA (IEC)  
70-781D5R-1A

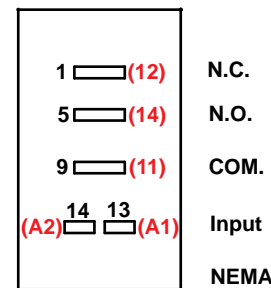

NEMA (IEC)  
70-781T-1

**70-782D8-1A and 70-782D14-1 Socket Specifications**

Part Number		70-782D8-1A	70-782D14-1
Contact Configuration		DPDT	4PDT
Number of Terminals		8	14
Mounting Style		Panel or DIN rail	Panel or DIN rail
Current Rating		16 A	10 A
Nominal Voltage Rating		300 V	300 V
Temperature Range	Storage	-40 to +105°C (-40 to +221°F)	-40 to +105°C (-40 to +221°F)
	Operating	-40 to +55°C (-40 to +131°F)	-40 to +70°C (-40 to +158°F)
Protection Category		IP20	IP20
Internal Metal Tracks		Copper Alloy, Zinc Plated	Copper Alloy, Zinc Plated
Screw Terminals		Steel, Zinc Plated	Steel, Zinc Plated
Screw Style		Combination Head	Combination Head
Screw Size		M3.5 mm	M3 mm
Maximum Screw Torque		9 lb-in (1.0 N•m)	7 lb-in (0.8 N•m)
Terminal Connection		Screw Clamping	Screw Clamping
Terminal Layout		Mix	Mix
Maximum Wire Size	Solid Copper	Two 14–12 AWG (two 2.5–4 mm <sup>2</sup> )	Two 14–12 AWG (two 2.5–4 mm <sup>2</sup> )
	Stranded Copper	Two 14–12 AWG (two 2.5–4 mm <sup>2</sup> )	Two 14–12 AWG (two 2.5–4 mm <sup>2</sup> )
DIN Rail Mounting, EN 60715		35 mm	35 mm
Chassis Mount Screw Torque		7 lb-in (0.8 N•m)	7 lb-in (0.8 N•m)
Flammability Rating		94V-0	94V-0
Weight		55 g (1.94 oz)	62 g (2.19 oz)
Agency Approvals		UL (E70550), CE, CSA (LR40787), RoHS	UL (E70550), CE, CSA (LR40787), RoHS

**Dimensions, in, (mm)**

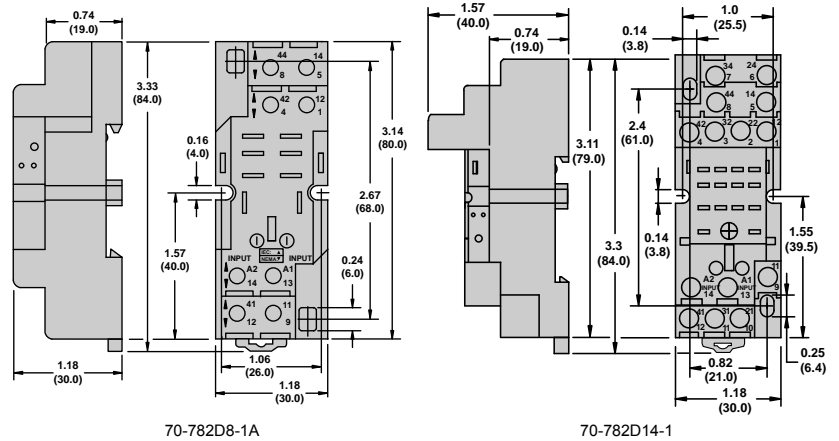

**Wiring Diagrams**

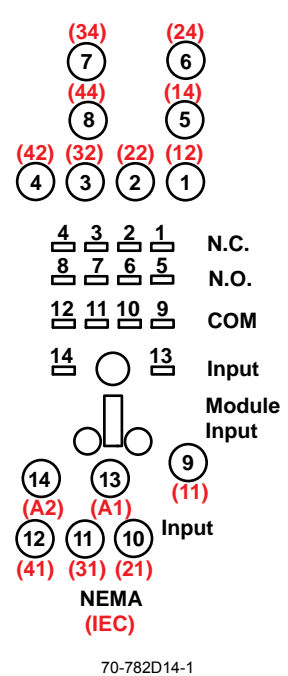
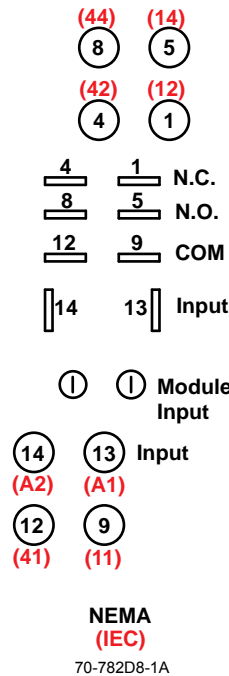

70782E141 and 70-782EL8-1 Socket Specifications

Part Number		70782E141	70-782EL8-1
Contact Configuration		4PDT	DPDT
Number of Terminals		14	8
Mounting Style		Panel or DIN rail	Panel or DIN rail
Current Rating		10 A	12 A
Nominal Voltage Rating		300 V	300 V
Temperature Range	Storage	-40 to +105°C (-40 to +221°F)	-40 to +105°C (-40 to +221°F)
	Operating	-40 to +70°C (-40 to +158°F)	-40 to +55°C (-40 to +131°F)
Protection Category		IP20	IP20
Internal Metal Tracks		Copper Alloy, Zinc Plated	Copper Alloy, Zinc Plated
Screw Terminals		Steel, Zinc Plated	Steel, Zinc Plated
Screw Style		Combination Head	Combination Head
Screw Size		M3 mm	M3.5 mm
Maximum Screw Torque		7 lb-in (0.8 N•m)	9 lb-in (1.0 N•m)
Terminal Connection		Elevator	Elevator
Terminal Layout		Separate	Separate
Maximum Wire Size	Solid Copper	Two 16–14 AWG (two 1.5–2.5 mm <sup>2</sup> )	Two 14–12 AWG (two 2.5–4 mm <sup>2</sup> )
	Stranded Copper	Two 16–14 AWG (two 1.5–2.5 mm <sup>2</sup> )	Two 14–12 AWG (two 2.5–4 mm <sup>2</sup> )
DIN Rail Mounting, EN 60715		35 mm	35 mm
Chassis Mount Screw Torque		7 lb-in (0.8 N•m)	7 lb-in (0.8 N•m)
Flammability Rating		94V-0	94V-0
Weight		56 g (1.98 oz)	46 g (1.62 oz)
Agency Approvals		UL (E70550) CE, CSA (LR40787), RoHS	UL (E70550), CE, CSA (LR40787), RoHS

Dimensions, in. (mm)

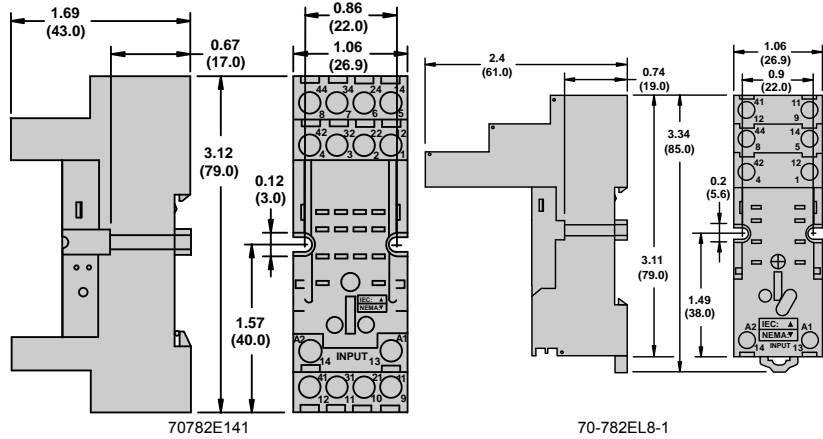

Wiring Diagrams

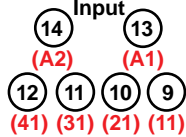
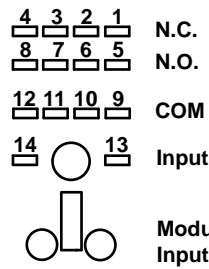

NEMA (IEC)

70782E141

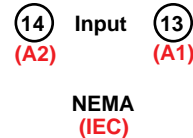
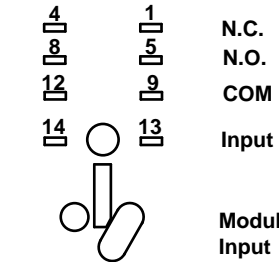
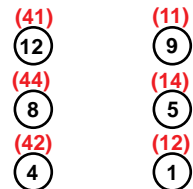

NEMA (IEC)

70-782EL8-1



**70-782E14-1 Socket Specifications**

<b>Part Number</b>		<b>70-782E14-1</b>
Contact Configuration		4PDT
Number of Terminals		14
Mounting Style		Panel or DIN rail
Current Rating		10 A
Nominal Voltage Rating		300 V
Temperature Range	Storage	-40 to +105°C (-40 to +221°F)
	Operating	-40 to +70°C (-40 to +158°F)
Protection Category		IP20
Internal Metal Tracks		Copper Alloy, Zinc Plated
Screw Terminals		Steel, Zinc Plated
Screw Style		Combination Head
Screw Size		M3 mm
Maximum Screw Torque		7 lb-in (0.8 N•m)
Terminal Connection		Elevator
Terminal Layout		Separate
Maximum Wire Size	Solid Copper	Two 16–14 AWG (two 1.5–2.5 mm <sup>2</sup> )
	Stranded Copper	Two 16–14 AWG (two 1.5–2.5 mm <sup>2</sup> )
DIN Rail Mounting, EN 60715		35 mm
Chassis Mount Screw Torque		7 lb-in (0.8 N•m)
Flammability Rating		94V-0
Weight		62 g (2.19 oz)
Agency Approvals		UL (E70550), CE, CSA (LR40787), RoHS

**Dimensions, in, (mm)**

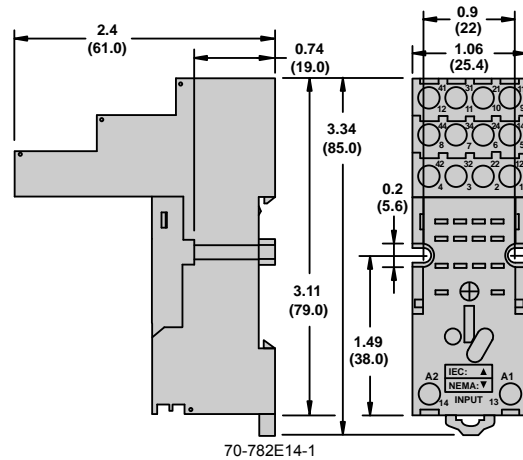

**Wiring Diagrams**

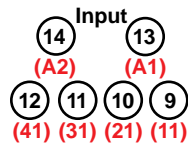
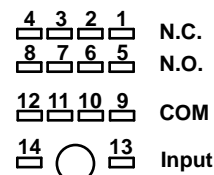

**NEMA  
(IEC)**

70-782E14-1

70-783D11-1A and 70-784D14-1 Socket Specifications

Part Number		70-783D11-1A	70-784D14-1
Contact Configuration		3PDT	4PDT
Number of Terminals		11	14
Mounting Style		Panel or DIN rail	Panel or DIN rail
Current Rating		16 A	16 A
Nominal Voltage Rating		300 V	300 V
Temperature Range	Storage	-40 to +105°C (-40 to +221°F)	-40 to +105°C (-40 to +221°F)
	Operating	-40 to +55°C (-40 to +131°F)	-40 to +55°C (-40 to +131°F)
Protection Category		IP20	IP20
Internal Metal Tracks		Copper Alloy, Zinc Plated	Copper Alloy, Zinc Plated
Screw Terminals		Steel, Zinc Plated	Steel, Zinc Plated
Screw Style		Combination Head	Combination Head
Screw Size		M3.5 mm	M3.5 mm
Maximum Screw Torque		9 lb-in (1.0 N•m)	9 lb-in (1.0 N•m)
Terminal Connection		Screw Clamping	Screw Clamping
Terminal Layout		Mix	Mix
Maximum Wire Size	Solid Copper	Two 14–12 AWG (two 2.5–4 mm <sup>2</sup> )	Two 14–12 AWG (two 2.5–4 mm <sup>2</sup> )
	Stranded Copper	Two 14–12 AWG (two 2.5–4 mm <sup>2</sup> )	Two 14–12 AWG (two 2.5–4 mm <sup>2</sup> )
DIN Rail Mounting, EN 60715		35 mm	35 mm
Chassis Mount Screw Torque		7 lb-in (0.8 N•m)	7 lb-in (0.8 N•m)
Flammability Rating		94V-0	94V-0
Weight		55 g (1.94oz)	62 g (2.19 oz)
Agency Approvals		CE, RoHS, UL (E70550), CSA (LR40787)	CE, RoHS, UL (E70550), CSA (LR40787)

Dimensions, in, (mm)

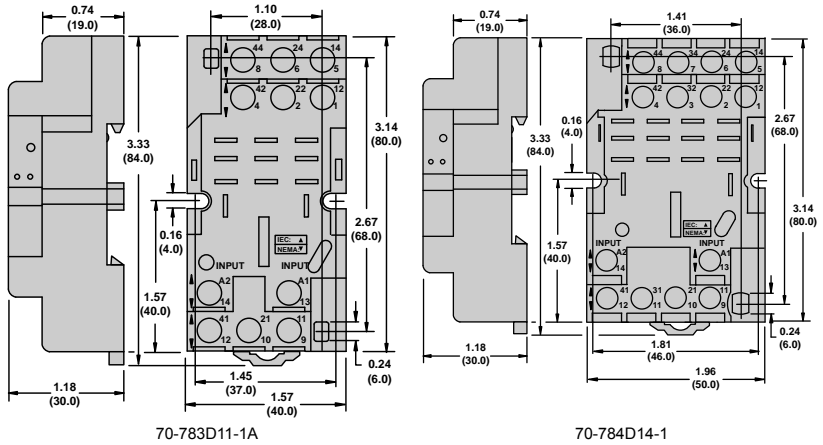

Wiring Diagrams

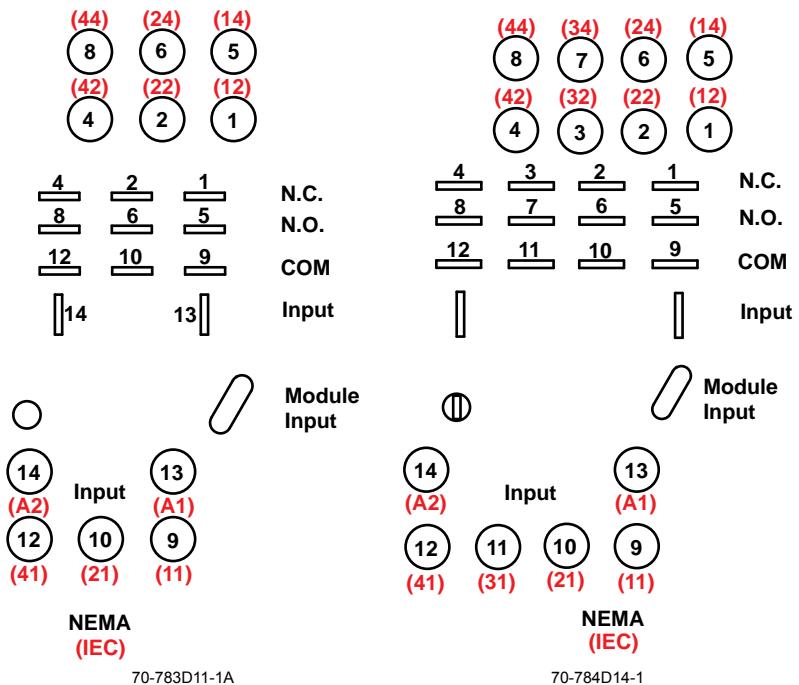

**70-788EL11-1 Socket Specifications**

<b>Part Number</b>		<b>70-788EL11-1</b>
Contact Configuration		3PDT
Number of Terminals		11
Mounting Style		DIN rail
Current Rating		25 A
Nominal Voltage Rating		300 V
Temperature Range	Storage	-40 to +105°C (-40 to +221°F)
	Operating	-40 to +55°C (-40 to +131°F)
Protection Category		IP20
Internal Metal Tracks		Copper Alloy, Zinc Plated
Screw Terminals		Steel, Zinc Plated
Screw Style		Combination Head
Screw Size		M3.5 mm
Maximum Screw Torque		9 lb-in (1.0 N•m)
Terminal Connection		Elevator
Terminal Layout		Separate
Maximum Wire Size	Solid Copper	Two 14–10 AWG (two 2.5–6 mm <sup>2</sup> )
	Stranded Copper	Two 14–10 AWG (two 2.5–6 mm <sup>2</sup> )
DIN Rail Mounting, EN 60715		35 mm
Chassis Mount Screw Torque		7 lb-in (0.8 N•m)
Flammability Rating		94V-0
Weight		96 g (3.39 oz)
Agency Approvals		UL (E70550), CE, CSA (LR40787), RoHS

**Dimensions, in, (mm)**

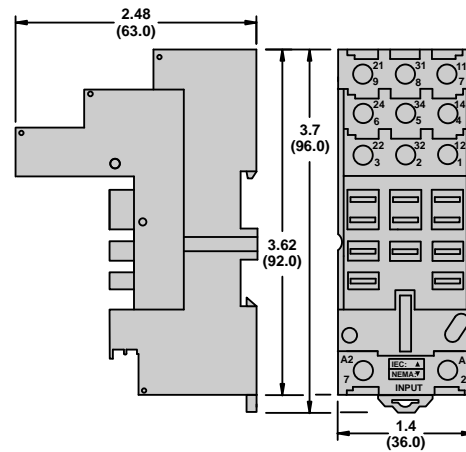

70-788EL11-1

**Wiring Diagram**

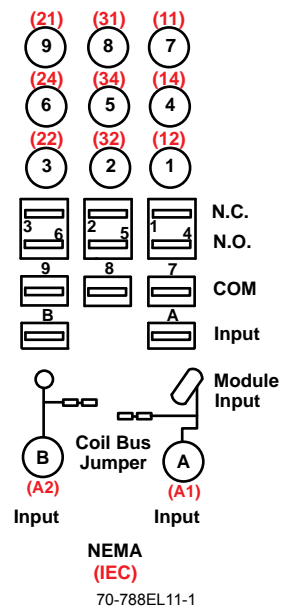



23

RELAYS AND TIMERS



199 Series Relay

199 Power Relays

199—SPST-NO-DM, 40 A; SPDT, 40 A; DPST-NO, 40 A; DPDT, 40 A

Table 23.40: Standard Part Numbers

Rated Contact Current	Contact Configuration	Coil Voltage	Coil Resistance (Ω)	Special Features	Standard Part Number
40 A <sup>[24]</sup>	SPST-NO-DM	120 Vac	290		199ADX-4
		12 Vdc	70		199DX-2
		24 Vdc	290	Blowout Magnet	199DBX-3
		48 Vdc	1200	Blowout Magnet	199DX-3
	SPDT	120 Vac	290		199AX-4
		12 Vdc	70		199X-2
		24 Vdc	290		199X-3
	DPST-NO	120 Vac	290		199AX-9
		240 Vac	1200		199AX-10
		12 Vdc	70		199X-7
		24 Vdc	290		199X-8
	DPDT	24 Vac	12		199AX-13
		120 Vac	290	Blowout Magnet	199ABX-14
					199AX-14
		240 Vac	1200		199AX-15
		12 Vdc	70	Blowout Magnet	199BX-12
				199X-12	
24 Vdc		290	Blowout Magnet	199BX-13	
				199X-13	
			Blowout Magnet	199BX-14	
				199X-14	

199 Specifications (UL 508)

Part Numbers	199AX, 199X, 199ABX <sup>[25]</sup> , 199BX <sup>[25]</sup>	199ADX, 199DX, 199DYX, 199DBX <sup>[25]</sup>
<b>Contact Characteristics</b>		
Contact Configuration	SPST, SPDT, DPST, DPDT	SPST-DM, SPST-DB
Contact Material	Silver alloy	
Thermal (Carrying) Current	40 A	
Maximum Switching Voltage	600 V(rms)	
Rated Switching Current at Voltage	Resistive: 40 A at 300 Vac 50/60 Hz; 5 A at 480 Vac 50/60 Hz; 5 A at 600 Vac 50/60 Hz; 40 A at 28 Vdc	Resistive: 40 A at 300 Vac 50/60 Hz; 12 A at 480 Vac 50/60 Hz; 10 A at 600 Vac 50/60 Hz; 40 A at 28 Vdc
	Motor: 2 hp at 120–600 Vac 50/60 Hz	
	Tungsten: 15 A at 120 Vac 50/60 Hz	
	Pilot Duty: A600	
Minimum Switching Requirement	1 A at 5 Vac/Vdc	
<b>Coil Characteristics</b>		
Coil Voltage Range <sup>[26]</sup>	6–600 Vac 50/60 Hz; 6–250 Vdc	
Operating Range (% of Nominal)	85%–110% (AC); 80%–110% (DC)	
Average Consumption (Maximum)	10 VA (AC); 4 W (DC)	
Drop-Out Voltage Threshold	10% (AC/DC)	

Table 23.41: Additional DC Ratings with Blowout Magnet

Load Voltage	Contact Rating
110 Vdc	20 A
220 Vdc	8 A
325 Vdc	4 A
500 Vdc	2 A

Table 23.42: Auxiliary Switch Ratings (Non-Standard Option)

Load Type	Contact Rating
Resistive Load 120/250 Vac (50/60 Hz)	10 A
Motor Load 125/250 Vac (50/60 Hz)	0.25 hp
Tungsten Load 125 Vac (50/60 Hz)	3 A

[24] 50 A versions and additional options available. Call Customer Service for more information (847-441-2540).  
 [25] For ratings with blowout magnet, refer to Table 23.41 Additional DC Ratings with Blowout Magnet, page 23-48  
 [26] For available standard coil voltages, refer to Standard Part Numbers, page 23-48

**Table 23.43: Contact Ratings and Electrical Endurance (per IEC 60947-1, 60947-4)**

Contact Ratings	Load Voltage	Frequency	Load Type	Estimated Electrical Endurance	See Note(s)
<b>AC Load</b>					
40 A	300 V	50/60 Hz	Resistive	50,000 cycles	[27][28]
2 hp	120–600 V		Motor	50,000 cycles	[29][28]
15 A	120 V		Tungsten	20,000 cycles	[28][30]
A600	—		Pilot Duty	100,000 cycles	[28]
<b>DC Load</b>					
40 A	28 V	DC	Resistive	100,000 cycles	[28]
20 A	110 V				
8 A	220 V				
4 A	325 V				
2 A	500 V				

**Dimensions, in. (mm)**

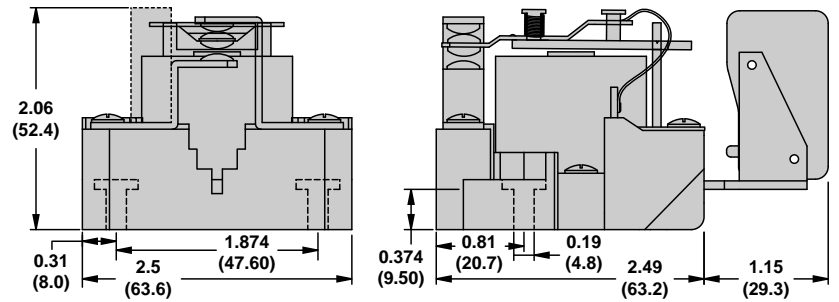

SPDT—Short Base (shown with optional Auxiliary Switch)

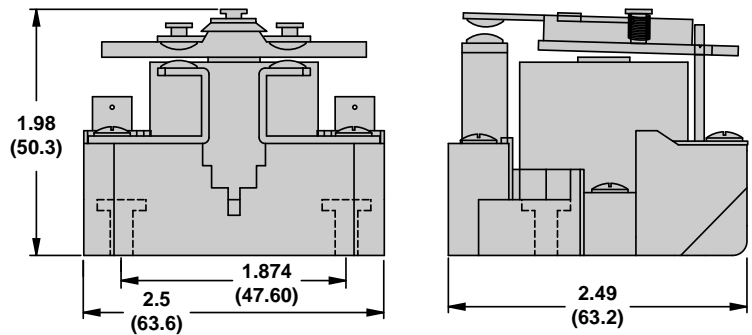

SPST-NO-DM

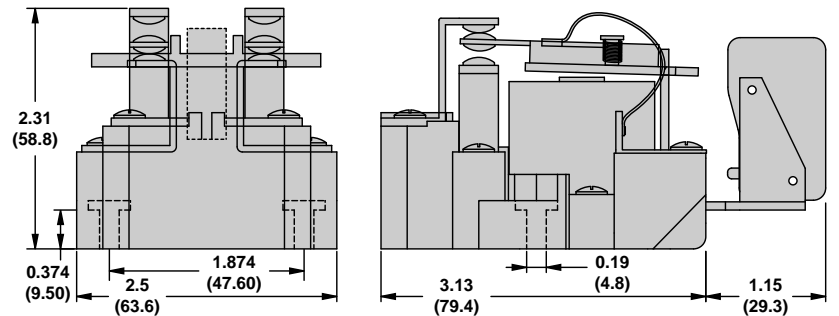

DPDT—Long Base (shown with optional Auxiliary Switch)

[27] Resistive AC load ratings are based on a power factor of 0.85–1.0.

[28] All ratings are based on applying the rated nominal power to the relay coil so as to provide a “clean” make and break that does not result in any contact chatter or multiple actuation of the contacts.

[29] Motor horsepower ratings are based on a power factor of 0.4–0.5, and an initial inrush current not exceeding

[30] The tungsten rating is based on cold-filament inrush current not exceeding 15 times the rated steady-state lamp current.

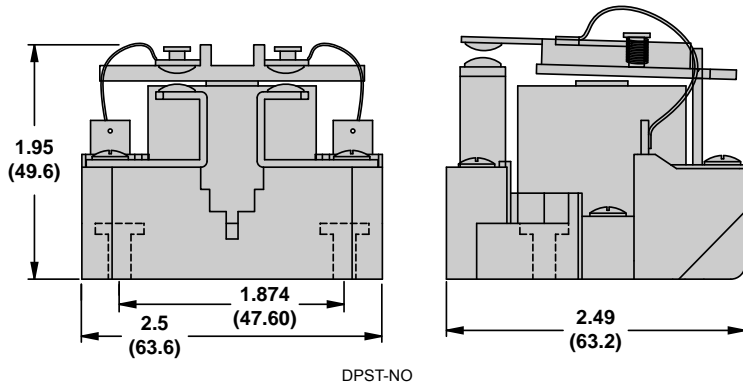

Wiring Diagrams

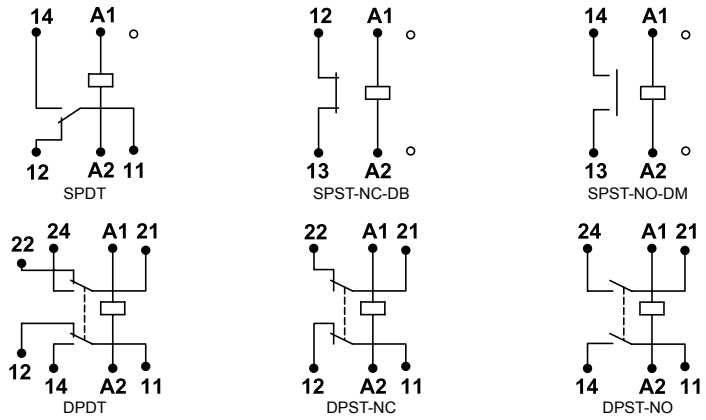



Plug-In Socket Mount with full-feature cover



Panel/DIN Mount with blade terminals



Panel/DIN Mount with screw terminals

**725 Power Relays**  
725—SPST-NO, 30 A; DPST-NO, 25 A

**Table 23.44: Standard Coil Voltages**

Rated Contact Current	Contact Configuration	Coil Voltage	Coil Resistance (Ω)	Mounting Style	Terminal Style	Standard Part Number
25 A	DPST-NO	24 Vac	275	DIN and panel	Blade terminals	725BXXBC3ML-24A
					Screw terminals	725BXXSC3ML-24A
		120 Vac	5200	DIN and panel	Blade terminals	725BXXBC3ML-120A
					Screw terminals	725BXXSC3ML-120A
		240 Vac	21000	DIN and panel	Blade terminals	725BXXBC3ML-240A
					Screw terminals	725BXXSC3ML-240A
12 Vdc	75	DIN and panel	Blade terminals	725BXXBC3ML-12D		
			Screw terminals	725BXXSC3ML-12D		
24 Vdc	300	DIN and panel	Blade terminals	725BXXBC3ML-24D		
			Screw terminals	725BXXSC3ML-24D		
30 A	SPST-NO	24 Vac	275	DIN and panel	Blade terminals	725AXXBC3ML-24A
					Screw terminals	725AXXSC3ML-24A
		120 Vac	5200	DIN and panel	Blade terminals	725AXXBC3ML-120A
					Screw terminals	725AXXSC3ML-120A
		240 Vac	21000	DIN and panel	Blade terminals	725AXXBC3ML-240A
					Screw terminals	725AXXSC3ML-240A
		12 Vdc	75	DIN and panel	Blade terminals	725AXXBC3ML-12D
					Screw terminals	725AXXSC3ML-12D
		24 Vdc	300	DIN and panel	Blade terminals	725AXXBC3ML-24D
					Screw terminals	725AXXSC3ML-24D

RELAYS AND TIMERS

23

**725 Specifications**

Part Number	725AX	725BX
<b>Contact Characteristics</b>		
Contact Configuration	SPST-NO	DPST-NO
Contact Material	Silver alloy	
Thermal (Carrying) Current	30 A	25 A
Maximum Switching Voltage	300 V	
Current Ratings at Voltage	Resistive: 30 A at 277 Vac 50/60 Hz, 6,000 cycles	Resistive: 25 A at 277 Vac 50/60 Hz; 25 A at 30 Vdc, 6,000 cycles
	Motor: 1.5 hp at 120 Vac 50/60 Hz; 3.0 hp at 277 Vac 50/60 Hz, 6,000 cycles	Motor: 1.0 hp at 120 Vac 50/60 Hz; 2.0 hp at 277 Vac 50/60 Hz, 6,000 cycles
	Tungsten: 1.5 kW at 120 Vac 50/60 Hz, 6,000 cycles	Tungsten: 1.3 kW at 120 Vac 50/60 Hz, 6,000 cycles
Minimum Switching Requirement	100 mA at 5 Vdc (0.5 W)	
<b>Coil Characteristics</b>		
Coil Voltage Range <sup>[31]</sup> Standard Coil Voltages, page 23-51	6–240 Vac 50/60 Hz (All AC coils are rectified); 6–110 Vdc <sup>[31]</sup> Standard Coil Voltages, page 23-51	
Operating Range (% of Nominal)	75%–110% (AC/DC)	
Average Consumption	2.5 VA (AC); 1.9 W (DC)	
Insulation System Per UL 508	Class B (130°C)	

[31] For available standard coil voltages, refer to the

Dimensions, in, (mm)

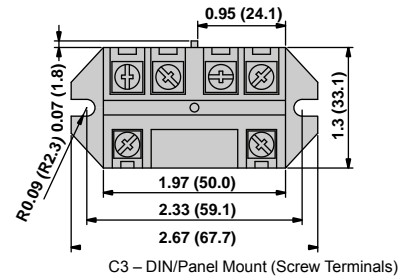
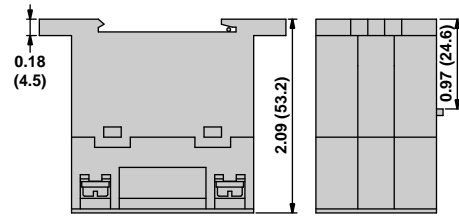
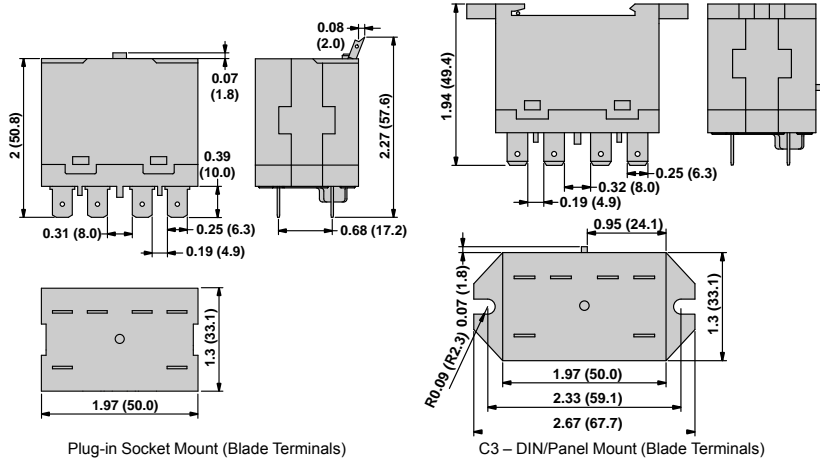

Wiring Diagrams

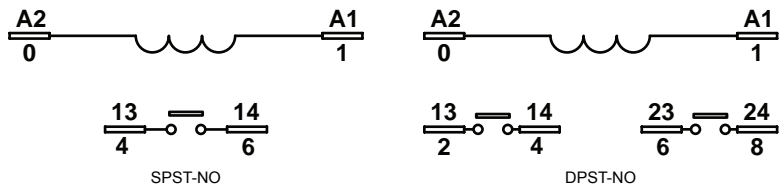





Plug-In (Socket) Cover



Side Flange Cover

**389F Power Relays**

389F—SPST, 30 A; DPDT, 20–25 A; SPDT, 25–30 A; 3PDT, 20 A

**Table 23.45: Standard Part Numbers**

Rated Contact Current	Contact Configuration	Coil Voltage	Coil Resistance (Ω)	Cover Style	Standard Part Number
20 A	3PDT	12 Vac	17.7	Side flange	389FXCXC1-12A
		24 Vac	72	Side flange	389FXCXC1-24A
				Plug-in (socket)	389FXCXC-24A
		120 Vac	1700	Plug-in (socket)	389FXCXC-120A
				Side flange	389FXCXC1-120A
		240 Vac	7200	Plug-in (socket)	389FXCXC-240A
				Side flange	389FXCXC1-240A
		12 Vdc	100	Plug-in (socket)	389FXCXC-12D
				Side flange	389FXCXC1-12D
				24 Vdc	400
Side flange	389FXCXC1-24D				
25 A	DPDT	24 Vac	72	Plug-in (socket)	389FXBXC-24A
				Side flange	389FXBXC1-24A
		120 Vac	1700	Plug-in (socket)	389FXBXC-120A
				Side flange	389FXBXC1-120A
		240 Vac	7200	Plug-in (socket)	389FXBXC-240A
				Side flange	389FXBXC1-240A
	12 Vdc	100	Plug-in (socket)	389FXBXC-12D	
			Side flange	389FXBXC1-12D	
	24 Vdc	400	Plug-in (socket)	389FXBXC-24D	
			Side flange	389FXBXC1-24D	
	SPDT	24 Vac	72	Side flange	389FXAXC1-24A
				Side flange	389FXAXC1-24A
		120 Vac	1700	Side flange	389FXAXC1-120A
				Side flange	389FXAXC1-240A
240 Vac		7200	Side flange	389FXAXC1-240A	
			Side flange	389FXAXC1-12D	
12 Vdc	100	Side flange	389FXAXC1-12D		
		Side flange	389FXAXC1-24D		
30 A	SPDT-DM-DB	24 Vac	72	Side flange	389FXHXC1-24A
				Side flange	389FXHXC1-120A
		240 Vac	7200	Side flange	389FXHXC1-240A
				Side flange	389FXHXC1-12D
	12 Vdc	100	Side flange	389FXHXC1-12D	
			Side flange	389FXHXC1-24D	
	24 Vdc	400	Side flange	389FXHXC1-24D	
			Side flange	389FHXXC1-24A	
	SPST-NO-DM	120 Vac	1700	Side flange	389FHXXC1-120A
				Side flange	389FHXXC1-240A
240 Vac		7200	Side flange	389FHXXC1-240A	
			Side flange	389FHXXC1-12D	
12 Vdc		100	Side flange	389FHXXC1-12D	
			Side flange	389FHXXC1-24D	
24 Vdc	400	Side flange	389FHXXC1-24D		

389F Specifications

23

RELAYS AND TIMERS

Part Number	389F 25A	389F 20A	389F 30A
<b>Contact Characteristics</b>			
Contact Configuration	SPDT; DPDT	3PDT	SPSTNODM; SPDTDMDB
Contact Material	Silver alloy		
Thermal (Carrying) Current	25 A	20 A	30 A
Maximum Switching Voltage	600 V	300 V	600 V
Rated Switching Current at Voltage (Conforming to IEC AC-1 and DC-1)	NO and NC: 25 A at 250 Vac NO and NC: 15 A at 28 Vdc	NO and NC: 20 A at 250 Vac NO and NC: 15 A at 28 Vdc	NO and NC: 30 A at 250 Vac NO and NC: 30 A at 28 Vdc
Current Ratings at Voltage (Conforming to UL)	Resistive: 25 A at 300 Vac 50/60 Hz; 5 A at 600 Vac 50/60 Hz; 13 A at 28 Vdc, 100,000 cycles  Motor: 1.5 hp at 200–240 Vac 50/60 Hz; 1 hp at 120–200 and 480–600 Vac <sup>[32]</sup> 50/60 Hz, 6,000 cycles  Pilot Duty: B600, 6,000 cycles  FLA/LRA: 22/98 A at 120 Vac, 6,000 cycles  Ballast: 20 A, 277 Vac 50/60 Hz, 6,000 cycles	Resistive: 20 A at 150 Vac 50/60 Hz, 15 A at 250 Vac, 50/60 Hz 13 A at 28 Vdc, 50,000 cycles  Motor: 0.5 hp at 120–240 Vac 50/60 Hz, 6,000 cycles  Pilot Duty: B300, 6,000 cycles  Ballast: 20 A, 150 Vac 50/60 Hz 6.67 A at 277 Vac 6,000 cycles	Resistive: 30 A at 300 Vac 50/60 Hz 10 A at 600 Vac 50/60 Hz 30 A at 28 Vdc, 100,000 cycles  Motor: 1.5 hp at 200–600 Vac 50/60 Hz; 1 hp at 120–200 Vac 50/60 Hz, 6,000 cycles  Pilot Duty: A600, 6,000 cycles  FLA/LRA: 22/98 A at 120 Vac, 6,000 cycles; 17/60 A at 300 Vac, 6,000 cycles <sup>[32]</sup>  Ballast: 25 A, 277 Vac 50/60 Hz, 6,000 cycles
Minimum Switching Requirement	100 mA at 5 Vdc		
<b>Coil Characteristics</b>			
Coil Voltage Range <sup>[33]</sup> Table 23.45 Standard Part Numbers, page 23-53	12–240 Vac 50/60 Hz; 12–24 Vdc <sup>[33]</sup> Table 23.45 Standard Part Numbers, page 23-53		
Operating Range (% of Nominal)	85%–110% (AC); 80%–110% (DC)		
Average Consumption	2 VA (AC); 1.5 W (DC)		
Drop-out Voltage Threshold	10% minimum (AC/DC)		
<b>General Characteristics</b>			
Electrical Life at Rated Load <sup>[34]</sup>	100,000 operations for IEC AC-1, 50,000 operations for IEC DC-1		
Mechanical Life at No Load (Unpowered)	5,000,000 operations		
Operate Time at Nominal Coil Voltage	20 ms (maximum)		
Dielectric Strength	Between coil and contact: 2200 Vac; between poles: 2200 Vac; between contacts: 1600 Vac		
Operating Temperature Range	-30 to +55°C (-22 to +131°F)		
Storage Temperature Range	-30 to +85°C (-22 to +185°F)		
Weight (Average)	84 g (3.0 oz)		
Product Certifications	UL (E164862), CE (per IEC 60947), CSA (File: 044087 Class: 3211-07), RoHS		

Dimensions, in. (mm)

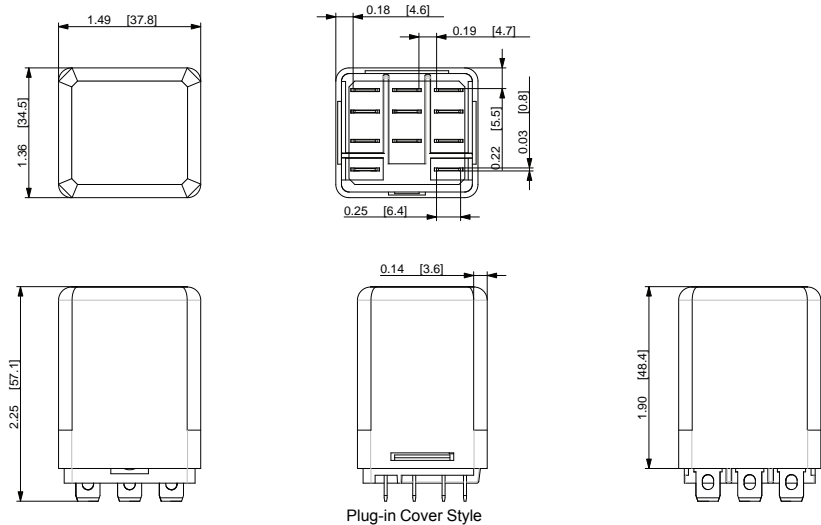

[32] Break all lines for 1 hp at 600 Vac, 50/60 Hz.  
 [33] For available standard coil voltages, refer to the  
 [34] The NO and NC contacts were tested independently

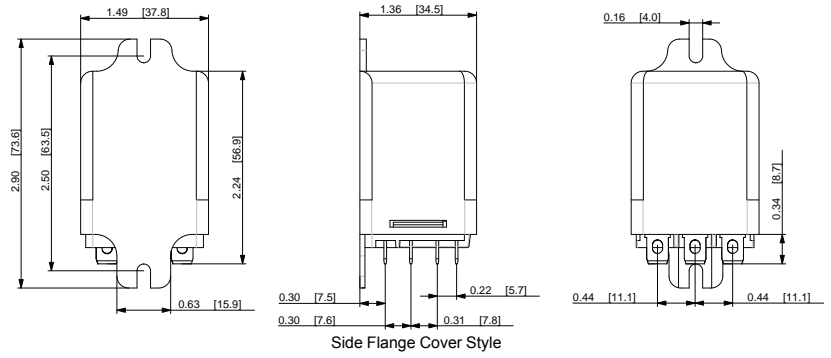

**Wiring Diagrams**

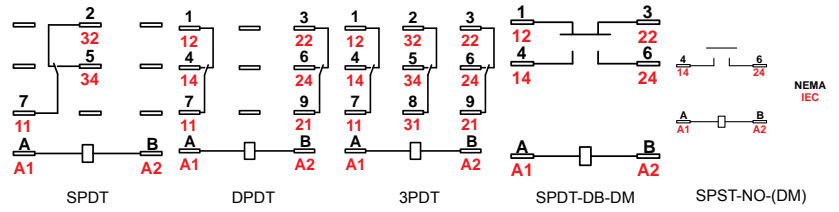



23

RELAYS AND TIMERS



Top DIN Mount Cover



Side Flange Cover

**300 Power Relays**  
300—DPDT, 30 A

**Table 23.46: Standard Part Numbers**

Rated Contact Current	Contact Configuration	Coil Voltage	Coil Resistance (Ω)	Cover Style	Standard Part Number
30 A	DPDT	12 Vac	13.5	Side flange mount	300XBXC1-12A
		24 Vac	54	Side flange mount	300XBXC1-24A
		120 Vac	1270	Side flange mount	300XBXC1-120A
		240 Vac	5400	Side flange mount	300XBXC1-240A
		12 Vdc	57	Side flange mount	300XBXC1-12D
		24 Vdc	300	Side flange mount (with magnetic blowout)	300XBXC1-24D

**300 Specifications**

<b>Part Number</b>	[35]
<b>Contact Characteristics</b>	
Contact Configuration	DPDT
Contact Material	Silver alloy
Thermal (Carrying) Current	30 A
Maximum Switching Voltage	600 V
Current Ratings at Voltage [35]	Resistive: 30 A at 300 Vac 50/60 Hz; 30 A at 28 Vdc; 15 A at 600 Vac 50/60 Hz Motor: 1 hp at 120 Vac 50/60 Hz; 6,000 cycles; 2 hp at 208–600 Vac 50/60 Hz [36]; 6,000 cycles Pilot Duty: 5.5 A at 120 Vac 50/60 Hz, 6,000 cycles; 1.2 A at 600 Vac 50/60 Hz, 6,000 cycles
Minimum Switching Requirement	500 mA at 5 Vdc
<b>Coil Characteristics</b>	
Coil Voltage Range [37]	12–240 Vac 50/60 Hz; 12–24 Vdc
Operating Range (% of Nominal)	85%–110% (AC); 80%–110% (DC)
Average Consumption	3.4 VA (AC at 60 Hz); 2.3 W (DC)
Drop-out Voltage Threshold	15% (AC); 10% (DC)
<b>General Characteristics</b>	
Electrical Life at Rated Load	6,000 operations
Mechanical Life at No Load (Unpowered)	5,000,000 operations
Operate Time at Nominal Coil Voltage	20 ms
Dielectric Strength	Between coil and contact: 4000 Vac; Between poles: 2500 Vac; Between contacts: 2500 Vac
Operating Temperature Range	–40 to +55°C (–40 to +131°F)
Storage Temperature Range	–40 to +85°C (–40 to +185°F)
Weight (Average)	without blowout magnet: 85 g (3.0 oz) with blowout magnet: 95 g (3.4 oz)
Product Certifications	UL (E164862), CSA (File: 044087 Class: 3211-07), RoHS

**Table 23.47: Additional DC Ratings with Blowout Magnet**

Load Voltage	Contact Rating
150 Vdc	5 A

[35] For additional ratings with blowout magnet, refer to Table 23.47 Additional DC Ratings with Blowout Magnet, page 23-56

[36] Break all lines for 2 hp / 480–600 Vac, 50/60 Hz.

[37] For available standard coil voltages, refer to Table 23.46 Standard Part Numbers, page 23-56

**Dimensions, in, (mm)**

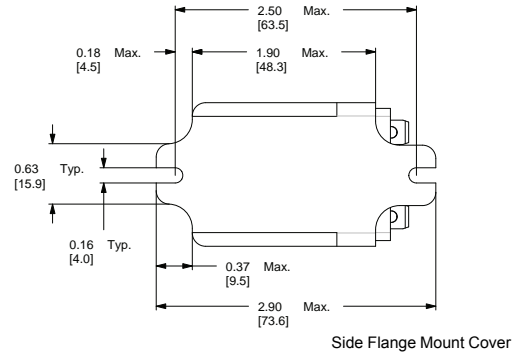
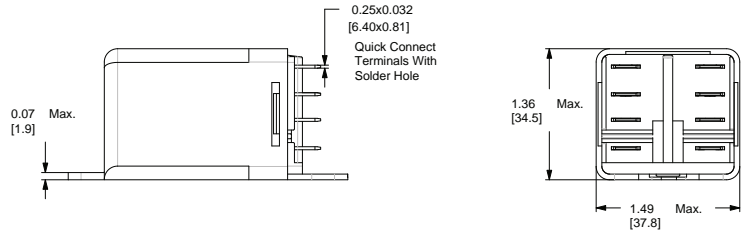

**Wiring Diagrams**

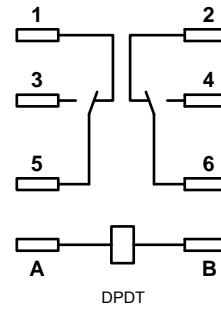



23

RELAYS AND TIMERS



92S7A22D-24

**92 Power Relays**  
**92—DPST-NO, 30 A; DPDT, 30 A (NO) / 3 A (NC)**

**Table 23.48: Standard Part Numbers**

Rated Contact Current	Contact Configuration	Coil Voltage	Coil Resistance (Ω)	Standard Part Number
30 A	DPST-NO	24 Vac	170 <sup>[38]</sup>	92S7A22D-24
		120 Vac	4250 <sup>[38]</sup>	92S7A22D-120
		240 Vac	16500 <sup>[38]</sup>	92S7A22D-240
		12 Vdc	86	92S7D22D-12
		24 Vdc	350	92S7D22D-24
30 A (NO) / 3 A (NC)	DPDT	24 Vac	170 <sup>[38]</sup>	92S11A22D-24
		120 Vac	4250 <sup>[38]</sup>	92S11A22D-120
		240 Vac	16500 <sup>[38]</sup>	92S11A22D-240
		12 Vdc	86	92S11D22D-12
		24 Vdc	350	92S11D22D-24

**92 Specifications**

Part Number	92S	92S11
<b>Contact Characteristics</b>		
Contact Configuration	DPST-NO	DPDT
Contact Material	Silver alloy	
Thermal (Carrying) Current	30 A	30 A (NO); 3 A (NC)
Maximum Switching Voltage (Conforming to IEC)	250 Vac / 28 Vdc	
Maximum Switching Voltage (Conforming to UL)	300 Vac / 28 Vdc	
Current Ratings at Voltage (Conforming to IEC)	(NO) 30 A at 250 Vac; 25 A at 28 Vdc, 100,000 cycles	(NO) 30 A at 250 Vac; 25 A at 28 Vdc, 100,000 cycles (NC) 3 A at 250 Vac; 3 A at 28 Vdc, 100,000 cycles
Current Ratings at Voltage (Conforming to UL)	(NO) General Use: 30 A at 277 Vac, 100,000 cycles Resistive: 20 A at 28 Vdc, 100,000 cycles Motor: 1.0 hp at 120 Vac; 3.0 hp at 240 Vac, 100,000 cycles LRA/FLA : 96 A / 22 A @ 240 Vac (AC coil), 30,000 cycles; 110 A / 25.3 A @ 240 Vac (DC coil), 30,000 cycles Pilot Duty: 720 VA / A300, 6,000 cycles Short Circuit: 5000 A(rms) @ 240 Vac Tungsten: 10 A at 120 Vac 50/60 Hz, 25,000 cycles; 6 A at 250 Vac 50/60 Hz, 25,000 cycles	(NO) General Use: 30 A at 277 Vac, 100,000 cycles Resistive: 20 A at 28 Vdc, 100,000 cycles Motor: 1.0 hp at 120 Vac; 3.0 hp at 240 Vac, 100,000 cycles LRA/FLA : 96 A / 22 A @ 240 Vac (AC coil), 30,000 cycles; 110 A / 25.3 A @ 240 Vac (DC coil), 30,000 cycles Pilot Duty: 720 VA / A300, 6,000 cycles Short Circuit: 5000 A(rms) @ 240 Vac Tungsten: 10 A at 120 Vac 50/60 Hz, 25,000 cycles; 6 A at 250 Vac 50/60 Hz, 25,000 cycles (NC) Resistive: 3 A at 277 Vac 6,000 cycles; 3 A at 28 Vdc 100,000 cycles
Switching Capacity	Maximum: 7500 VA / 840 W (when mounted with 13 mm gap between 2 relays); 6250 VA / 700 W (when mounted side by side without a gap) Minimum: 170 mW	
Minimum Switching Requirements	10 mA at 17 V	
<b>Coil Characteristics</b>		
Coil Voltage Range <sup>[39]</sup>	12–240 Vac <sup>[38]</sup> 50/60 Hz; 12–24 Vdc	
Operating Range (% of Nominal)	80%–110%	
Average Consumption	4 VA –20% / +10% (AC); 1.7 W –20% / +10% (DC)	
Drop-out Voltage Threshold	15% minimum (AC); 10% minimum (DC)	

[38] All AC coils are rectified.

[39] For available standard coil voltages, refer to the Table 23.48 Standard Part Numbers, page 23-58

**Dimensions, in, (mm)**

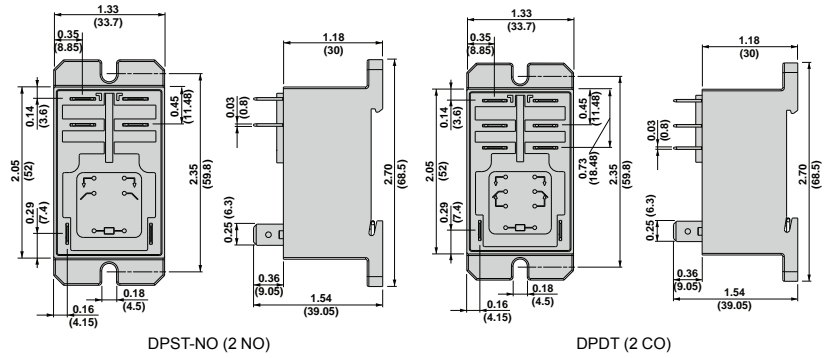

**Wiring Diagrams**

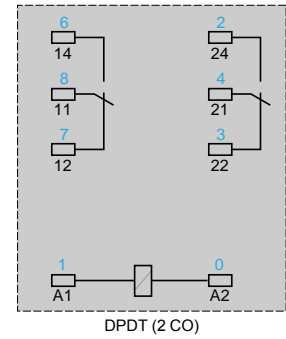
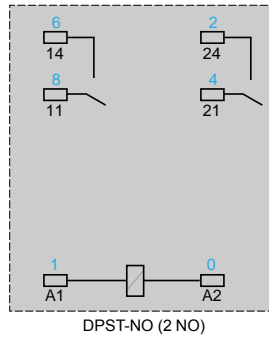

23

New!

**Square D™ Universal Relays**

8501K relays are designed for multipole switching applications at 240 Vac or lower. These relays have industry standard wiring and pin terminal arrangements which allow for their use as replacements for many competitive relays without wiring or hardware modifications.

- 10 A relays
- DPDT or 3PDT
- Green pilot light option
- Motor load (hp) ratings
- DPDT latching models available
- AC or DC operation
- RoHS Compliant



8501KPDR12V60



8501KFR13V20

RELAYS AND TIMERS



8501KUDR12P14V60



8501NR61

**Table 23.49: Relays: Standard Cover, without LED**

Pins	Coil Voltage	Number and Type of Contacts - Thermal current (Ith)	
		DPDT (2 C/O) - 10 A	3PDT (3 C/O) - 10 A
		Catalog Number	Catalog Number
Octal	12 Vdc	8501KPDR12V51	8501KPDR13V51
	24 Vdc	8501KPDR12V53	8501KPDR13V53
	48 Vdc	8501KPDR12V56	8501KPDR13V56
	110 Vdc	8501KPDR12V60	8501KPDR13V60
	24 Vac	8501KPR12V14	8501KPR13V14
	120 Vac	8501KPR12V20	8501KPR13V20
Blade	240 Vac	8501KPR12V24	8501KPR13V24
	12 Vdc	8501KUDR12V51	8501KUDR13V51
	24 Vdc	8501KUDR12V53	8501KUDR13V53
	48 Vdc	8501KUDR12V56	8501KUDR13V56
	110 Vdc	8501KUDR12V60	8501KUDR13V60
	24 Vac	8501KUR12V14	8501KUR13V14
	120 Vac	8501KUR12V20	8501KUR13V20
	240 Vac	8501KUR12V24	8501KUR13V24

**Table 23.50: Relays: Flange Mount Cover**

Pins	Coil Voltage	Number and Type of Contacts - Thermal current (Ith)	
		DPDT (2 C/O) - 10 A	3PDT (3 C/O) - 10 A
		Catalog Number	Catalog Number
Blade	12 Vdc	8501KFDR12V51	8501KFDR13V51
	24 Vdc	8501KFDR12V53	8501KFDR13V53
	48 Vdc	8501KFDR12V56	8501KFDR13V56
	110 Vdc	8501KFDR12V60	8501KFDR13V60
	24 Vac	8501KFR12V14	8501KFR13V14
	120 Vac	8501KFR12V20	8501KFR13V20
	240 Vac	8501KFR12V24	8501KFR13V24



8501NR52



8501NR82

**Table 23.51: Relays: Standard Cover, with LED**

Pins	Coil Voltage	Number and Type of Contacts - Thermal current (Ith)	
		DPDT (2 C/O) - 10 A	3PDT (3 C/O) - 10 A
		Catalog Number	Catalog Number
Octal	12 Vdc	8501KPDR12P14V51	8501KPDR13P14V51
	24 Vdc	8501KPDR12P14V53	8501KPDR13P14V53
	48 Vdc	8501KPDR12P14V56	8501KPDR13P14V56
	110 Vdc	8501KPDR12P14V60	8501KPDR13P14V60
	24 Vac	8501KPR12P14V14	8501KPR13P14V14
	120 Vac	8501KPR12P14V20	8501KPR13P14V20
Blade	240 Vac	8501KPR12P14V24	8501KPR13P14V24
	12 Vdc	8501KUDR12P14V51	8501KUDR13P14V51
	24 Vdc	8501KUDR12P14V53	8501KUDR13P14V53
	48 Vdc	8501KUDR12P14V56	8501KUDR13P14V56
	110 Vdc	8501KUDR12P14V60	8501KUDR13P14V60
	24 Vac	8501KUR12P14V14	8501KUR13P14V14
	120 Vac	8501KUR12P14V20	8501KUR13P14V20
	240 Vac	8501KUR12P14V24	8501KUR13P14V24

8501NR52 Socket  
+8501KPR13P14V2 Relay

8501NR82 Socket  
+8501KUDR12P14V Relay

**Table 23.52: Sockets**

Contact Terminal Arrangement	Connection	For Use with Relays	Sold in Lots of	Catalog Number <sup>[1]</sup>		
Mixed	Screw Connector	8501KPR12*** 8501KPDR12***	1	8501NR51		
		8501KPR12*** 8501KPDR12***	10	8501NR51B		
		8501KPR13*** 8501KPDR13***	1	8501NR61		
		8501KPR13*** 8501KPDR13***	10	8501NR61B		
		Separate	Screw Connector	8501KPR12*** 8501KPDR12***	1	8501NR52
				8501KPR12*** 8501KPDR12***	10	8501NR52B
8501KPR13*** 8501KPDR13***	1			8501NR62		
8501KPR13*** 8501KPDR13***	10			8501NR62B		
8501KUR12*** 8501KUDR12***	1			8501NR82		
8501KUR12*** 8501KUDR12***	10			8501NR82B		
		8501KUR13*** 8501KUDR13***	1	8501NR82		

[1] Please note that the B suffix only designates quantities of 10 and is not printed on the socket.



**Table 23.52 Sockets (cont'd.)**

Contact Terminal Arrangement	Connection	For Use with Relays	Sold in Lots of	Catalog Number <sup>[2]</sup>
		8501KUR13... 8501KUDR13...	10	8501NR82B

**Table 23.53: Accessories (Sold in Lots of 10)**

Description	For Use With	Sold in Lots of	Catalog Number
Metal Restraining Strap	8501NR51 sockets	1	8501NH7
	8501NR52 sockets		
	8501NR62 sockets		
	8501NR82 sockets		
Metal Hold-Down Clip	8501NR52 sockets	10	8501NH52
	8501NR62 sockets		8501NH82
	8501NR82 sockets		



8501NH7

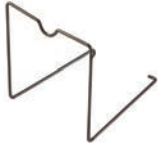

8501NH52



8501NH82

**Approvals for 8501 KPR, KUR, and KFR Relays**



File: E3190  
CCN: NLDX,  
NLDX7<sup>[2]</sup>



File: E3190  
CCN:  
NLDX2,  
NLDX8



File:  
260367  
Class:  
3211 07



IEC  
61810-1

RoHS  
Compliant

**Approvals for 8501NR Sockets**



File: E66924  
CCN: SWIV2,  
SWIV8



File: 211268  
Class: 3211 07



IEC  
61810-1

RoHS  
Compliant

<sup>[2]</sup> Please note that the B suffix only designates quantities of 10 and is not printed on the socket.

<sup>[2]</sup> When used with the appropriate 8501NR socket.



8501RS41P14V20



8501RSD42P14V51



8501RS43P14V20



8501RS44P14V20



8501NR41 Socket  
+8501RS41P14V20 Relay



8501NR42 Socket  
+8501RSD42P14V51 Relay



8501NR43 Socket  
+8501RS43P14V20 Relay



8501NR34 Socket  
+8501RS44P14V20 Relay

### Square D™ Plug-in Relays

8501R miniature plug-in relays have a 15 A resistive rating. The compact size of these relays makes them ideal for downsizing equipment and applications where space is at a premium.

- SPDT through 4PDT
- AC or DC operated
- Horsepower rated
- Socket compatible
- Green LED pilot light option
- Silver alloy contacts

Table 23.54: Relays: Standard Cover, without LED

Coil Voltage	Number and Type of Contacts - Thermal current (Ith)			
	SPDT (1 C/O) - 15 A	DPDT (2 C/O) - 15 A	3PDT (3 C/O) - 15 A	4PDT (4 C/O) - 15 A
	Catalog Number	Catalog Number	Catalog Number	Catalog Number
12 Vdc	8501RSD41V51	8501RSD42V51	8501RSD43V51	8501RSD44V51
24 Vdc	8501RSD41V53	8501RSD42V53	8501RSD43V53	8501RSD44V53
110 Vdc	8501RSD41V60	8501RSD42V60	8501RSD43V60	8501RSD44V60
12 Vac	8501RS41V36	8501RS42V36	8501RS43V36	8501RS44V36
24 Vac	8501RS41V14	8501RS42V14	8501RS43V14	8501RS44V14
120 Vac	8501RS41V20	8501RS42V20	8501RS43V20	8501RS44V20
240 Vac	8501RS41V24	8501RS42V24	8501RS43V24	8501RS44V24

Table 23.55: Relays: Standard Cover, with LED

Coil Voltage	Number and Type of Contacts - Thermal current (Ith)			
	SPDT (1 C/O) - 15 A	DPDT (2 C/O) - 15 A	3PDT (3 C/O) - 15 A	4PDT (4 C/O) - 15 A
	Catalog Number	Catalog Number	Catalog Number	Catalog Number
12 Vdc	8501RSD41P14V51	8501RSD42P14V51	8501RSD43P14V51	8501RSD44P14V51
24 Vdc	8501RSD41P14V53	8501RSD42P14V53	8501RSD43P14V53	8501RSD44P14V53
110 Vdc	8501RSD41P14V60	8501RSD42P14V60	8501RSD43P14V60	8501RSD44P14V60
12 Vac	8501RS41P14V36	8501RS42P14V36	8501RS43P14V36	8501RS44P14V36
24 Vac	8501RS41P14V14	8501RS42P14V14	8501RS43P14V14	8501RS44P14V14
120 Vac	8501RS41P14V20	8501RS42P14V20	8501RS43P14V20	8501RS44P14V20
240 Vac	8501RS41P14V24	8501RS42P14V24	8501RS43P14V24	8501RS44P14V24

Table 23.56: Sockets

Contact Terminal Arrangement	Connection	For Use with Relays	Sold in Lots of	Catalog Number <sup>[3]</sup>
Separate <sup>[4]</sup>	Screw Connector	8501RS41***	1	8501NR41
		8501RSD41***	10	8501NR41B
		8501RS42***	1	8501NR42
		8501RSD42***	10	8501NR42B
		8501RS43***	1	8501NR43
		8501RSD43***	10	8501NR43B
		8501RS44***	1	8501NR34
		8501RSD44***	10	8501NR34B

Table 23.57: Accessories (Sold in Lots of 10)

Description	For Use With	Sold in Lots of	Catalog Number
Plastic ID Clip	8501NR41 socket	Supplied with socket	—
	8501NR42 socket		
Metal Hold-Down Clip	8501NR43 socket	10	8501NH42
	8501NR34 socket		

#### Approvals for 8501 RS41, RSD41, RS42, RSD42, RS43, RSD43, RS44, and RSD44



File: E3190  
CCN: NLDX,  
NLDX7<sup>[5]</sup>



File: E3190  
CCN:  
NLDX2,  
NLDX8



File:  
260367  
Class:  
3211 07



IEC  
61810-1  
RoHS  
Compliant

#### Approvals for 8501NR Sockets



File: E66924  
CCN: SWIV2,  
SWIV8



File: 211268  
Class: 3211 07



IEC  
61810-1  
RoHS  
Compliant

[3] Please note that the B suffix only designates quantities of 10 and is not printed on the socket.

[4] The inputs and outputs are on separate sides.

[5] When used with the appropriate 8501NR socket.

**Square D™ Miniature Control Relays**

8501R relays are suited for use as logic elements and power switching output devices. The short stroke motion of the armature provides long mechanical life required for high speed operation of control systems. Different contact compositions allow these relays to be used in a variety of applications. Bifurcated crossbar (gold overlay silver) is suitable for high contact reliability and low level switching requirements. Silver alloy is best suited for inductive loads. Class I Division II sealed relays can be used in specified hazardous locations.

- 4PDT
- Complete socket line
- Horsepower rated
- AC or DC operation
- Green pilot light option



8501NR45 Socket  
+8501RS14V20 Relay



8501RS14V14



8501RSD24P14V60



8501RSD34V51

**Table 23.58: Relays: Standard Cover, without LED**

Coil Voltage	Number and Type of Contacts — Thermal current (Ith)	
	4PDT (4 C/O) — 6 A	4PDT (4 C/O) — 3 A
	Catalog Number	Catalog Number
12 Vdc	8501RSD14V51	8501RSD24V51
24 Vdc	8501RSD14V53	8501RSD24V53
48 Vdc	8501RSD14V56	8501RSD24V56
110 Vdc	8501RSD14V60	8501RSD24V60
24 Vac	8501RS14V14	8501RS24V14
120 Vac	8501RS14V20	8501RS24V20
240 Vac	8501RS14V24	8501RS24V24

**Table 23.59: Relays: Standard Cover, with LED**

Coil Voltage	Number and Type of Contacts — Thermal current (Ith)	
	4PDT (4 C/O) — 6 A	4PDT (4 C/O) — 3 A
	Catalog Number	Catalog Number
12 Vdc	8501RSD14P14V51	8501RSD24P14V51
24 Vdc	8501RSD14P14V53	8501RSD24P14V53
48 Vdc	8501RSD14P14V56	8501RSD24P14V56
110 Vdc	8501RSD14P14V60	8501RSD24P14V60
24 Vac	8501RS14P14V14	8501RS24P14V14
120 Vac	8501RS14P14V20	8501RS24P14V20
240 Vac	8501RS14P14V24	8501RS24P14V24

**Table 23.60: Relays: Hermetically Sealed Miniature Control Relays**

Coil Voltage	Number and Type of Contacts — Thermal current (Ith)	
	4PDT (4 C/O) — 5 A	
	Catalog Number	Catalog Number
6 Vdc	8501RSD34V50	
12 Vdc	8501RSD34V51	
24 Vdc	8501RSD34V53	
48 Vdc	8501RSD34V56	
110 Vdc	8501RSD34V60	
6 Vac	8501RS34V35	
12 Vac	8501RS34V36	
24 Vac	8501RS34V14	
48 Vac	8501RS34V17	
110 Vac	8501RS34V20	
240 Vac	8501RS34V24	



8501NR45



8501NH45

Table 23.61: Sockets

Contact Terminal Arrangement	Connection	For Use With Relays	Sold in Lots of	Catalog Number <sup>[6]</sup>
Separate <sup>[7]</sup>	Screw Clamp Terminals	8501RS(D)14***	1	8501NR45
		8501RS(D)24***		
		8501RS(D)34***		
	Spring Clamp Terminals	8501RS(D)14***	10	8501NR45B
		8501RS(D)24***		
		8501RS(D)34***		
		8501RS(D)14***	10	RXZE2S114S
	8501RS(D)24***			
	8501RS(D)34***			

Table 23.62: Accessories (Sold in Lots of)

Description	For Use With	Sold in Lots of	Catalog Number
Metal hold-down clip	8501NR45 socket	10	8501NH45
Clip-in ID tags	RXZE2S114S socket	10	RSZL300

Approvals for 8501 RS14, RSD14, RS24, and RSD24 Relays



File: E3190  
CCN: NLDX,  
NLDX7<sup>[8]</sup>



File: E3190  
CCN:  
NLDX2,  
NLDX8



File:  
260367  
Class:  
3211 07



RoHS  
Compliant

Approvals for 8501 RS34 and RSD34 Relays



File: E123950  
CCN: NLDX,  
NLDX7<sup>[8]</sup>  
ANSI/ISA  
12.12.01



File:  
E196809  
CCN:  
NQMJ2,  
NQMJ8



File:  
211268  
Class:  
3218 06



RoHS  
Compliant

Approvals for 8501NR Sockets



File: E66924  
CCN: SWIV2,  
SWIV8



File: 211268  
Class: 3211 07



RoHS  
Compliant

<sup>[6]</sup> Please note that the B suffix only designates quantities of 10 and is not printed on the socket.

<sup>[7]</sup> The inputs and outputs are on separate sides.

<sup>[8]</sup> When used with the appropriate 8501NR socket.



8501CDO6V51

**Square D™ Power Relays**

8501C relays are ideally suited for controlling single-phase motors, electric heaters, pumps, conveyors, material handling equipment, and other applications.

- 40 A contact rating
- Motor load (hp) ratings
- Durable open-frame construction
- UL Listed
- CSA certified
- CE approved
- RoHS compliant

**Table 23.63: Relays: AC Rated Contacts, 40 A at 277 V (sold in lots of 1)**

Coil Voltage	Number and type of contacts - Thermal current (Ith)				
	SPST: 1 NO / 0 NC	DPST: 2 NO / 0 NC	SPST: 0 NO / 1 NC	SPDT: 1 NO / 1 NC	DPDT: 2 NO / 2 NC
	Catalog Number	Catalog Number	Catalog Number	Catalog Number	Catalog Number
6 Vdc	8501CDO6V50	8501CDO7V50	8501CDO8V50	8501CDO15V50	8501CDO16V50
12 Vdc	8501CDO6V51	8501CDO7V51	8501CDO8V51	8501CDO15V51	8501CDO16V51
24 Vdc	8501CDO6V53	8501CDO7V53	8501CDO8V53	8501CDO15V53	8501CDO16V53
110 Vdc	8501CDO6V60	8501CDO7V60	8501CDO8V60	8501CDO15V60	8501CDO16V60
6 Vac	8501CO6V35	8501CO7V35	8501CO8V35	8501CO15V35	8501CO16V35
12 Vac	8501CO6V36	8501CO7V36	8501CO8V36	8501CO15V36	8501CO16V36
24 Vac	8501CO6V14	8501CO7V14	8501CO8V14	8501CO15V14	8501CO16V14
120 Vac	8501CO6V20	8501CO7V20	8501CO8V20	8501CO15V20	8501CO16V20
208 Vac	8501CO6V08	8501CO7V08	8501CO8V08	8501CO15V08	8501CO16V08
240 Vac	8501CO6V24	8501CO7V24	8501CO8V24	8501CO15V24	8501CO16V24
277 Vac	8501CO6V04	8501CO7V04	8501CO8V04	8501CO15V04	8501CO16V04
480 Vac	8501CO6V29	8501CO7V29	8501CO8V29	8501CO15V29	8501CO16V29

**Table 23.64: Relays: DC Rated Contacts, 20 A at 110 V (sold in lots of 1)**

Coil Voltage	Number and type of contacts - Thermal current (Ith)
	SPST: 1 NO / 0 NC
	Catalog Number
6 Vdc	8501CDO21V50
12 Vdc	8501CDO21V51
24 Vdc	8501CDO21V53
110 Vdc	8501CDO21V60
6 Vac	8501CO21V35
12 Vac	8501CO21V36
24 Vac	8501CO21V14
120 Vac	8501CO21V20
208 Vac	8501CO21V08
240 Vac	8501CO21V24
277 Vac	8501CO21V04
480 Vac	8501CO21V29

**Table 23.65: Relays: DC Rated Contacts, 10 A at 110 V (sold in lots of 1)**

Coil Voltage	Number and type of contacts - Thermal current (Ith)
	DPDT: 1 NO / 0 NC
	Catalog Number
6 Vdc	8501CDO22V50
12 Vdc	8501CDO22V51
24 Vdc	8501CDO22V53
110 Vdc	8501CDO22V60
6 Vac	8501CO22V35
12 Vac	8501CO22V36
24 Vac	8501CO22V14
120 Vac	8501CO22V20
208 Vac	8501CO21V08
240 Vac	8501CO22V24
277 Vac	8501CO22V04
480 Vac	8501CO22V29

**Approvals for Square D Power Relays**



File: E78351  
CCN: NLDX,  
NLDX7



File: 218139  
Class: 3211 04



IEC 60947-4-1



UL Listed when used with corresponding sockets

23

RELAYS AND TIMERS



750H Hazardous Location Relay

750H Hazardous Location Series  
DPDT, PDT 12A

Contact Rating	Contact Configuration	Nominal Voltage	Coil Resistance (Ω)	Standard Part Number
12 A	DPDT	12 Vac, 50/60 Hz	18	750XBXH-12A
		24 Vac, 50/60 Hz	72	750XBXH-24A
		120 Vac, 50/60 Hz	1700	750XBXH-120A
		240 Vac, 50/60 Hz	7200	750XBXH-240A
		12 Vdc	120	750XBXH-12D
		24 Vdc	470	750XBXH-24D
	110 Vdc	10000	750XBXH-110D	
	3PDT	12 Vac, 50/60 Hz	18	750XCXH-12A
		24 Vac, 50/60 Hz	72	750XCXH-24A
		120 Vac, 50/60 Hz	1700	750XCXH-120A
		240 Vac, 50/60 Hz	7200	750XCXH-240A
		12 Vdc	120	750XCXH-12D
24 Vdc		470	750XCXH-24D	
		110 Vdc	10,000	750XCXH-110D

750H Specifications

Part Number	750XBXH	750XCXH
<b>Contact Characteristics</b>		
Terminal Style	Octal	
Contact Material	Silver Alloy	
Load Type	Standard	
Contact Configuration	DPDT	3PDT
Carrying Current	12A	
Maximum Switching Voltage	300 V	
Rated Switching Current Conforming to UL and ANSI/ ISA 12.12.01)	Resistive	12 A at 120 Vac, 50/60 Hz, 100,000 cycles 12 A at 240 Vac, 50/60 Hz, 100,000 cycles 12 A at 28 Vdc, 100,000 cycles
	Motor	1/2 hp at 240 Vac, 50/60 Hz, 100,000 cycles 1/3 hp at 120 Vac, 50/60 Hz, 100,000 cycles
	Pilot Duty	B300 — 100,000 cycles
Minimum Switching Requirement	100 mA at 5 Vdc	
<b>Coil Characteristics</b>		
Maximum Operating Voltage	110% (AC/DC)	
Maximum Pickup Voltage	85% (AC); 80% (DC)	
Drop-out Voltage Threshold	15% (AC); 10% (DC)	
Average Consumption	2.75 VA at 60 Hz (AC); 1.2 W (DC)	

Dimensions, in. (mm)

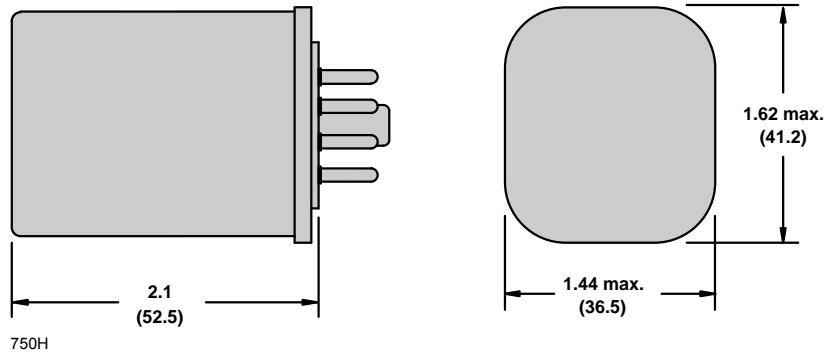

750H

**Wiring Diagrams**

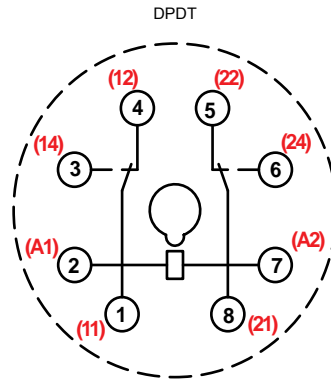

**NEMA (IEC)**

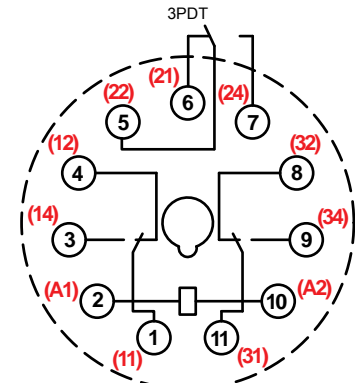

**NEMA (IEC)**

RELAYS AND TIMERS

**Relay Accessories**

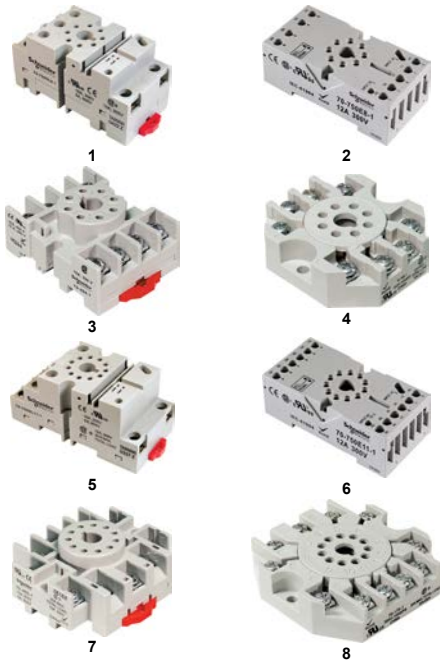

Description	Function	For Use with Relays	Pkg. Min.	Standard Part Number
1 Socket	DIN or panel mounting with screw terminals	750XBXH	10	70-750DL8-1
2 Socket	DIN or panel mounting with elevator terminals, module		10	70750E81
3 Socket	DIN or panel mounting with screw terminals and clamping plates		10	704641
4 Socket	Panel mounting with screw terminals and clamping plates		10	701691
5 Socket	DIN or panel mounting	750XCXH	10	70-750DL11-1
6 Socket	DIN or panel mounting with elevator terminals		10	70750E111
7 Socket	DIN or panel mounting with screw terminals and clamping plates		10	704651
8 Socket	Panel mounting with screw terminals and clamping plates		10	701701

23

23

RELAYS AND TIMERS



**CLASS I DIVISION 2**  
Class I, Division 2 certification for use in hazardous locations. (Temperature code: T5)



861H Relay

**861H Solid-State Relays**  
861H—SPST-NO, 8–15 A

Switching Type	Switching Device (1)	Input Voltage Range	Output Voltage Range	Contact Configuration	Rated Output Current (A)	Standard Part Number	
DC Switching	MOSFET	3.5–32 Vdc	3–50 Vdc	SPST-NO	15	861HSSR115-DD	
			3–150 Vdc	SPST-NO	8	861HSSR208-DD	
AC Random	Triac	3–32 Vdc	24–280 Vac	SPST-NO	8	861HSSRA208-DC-2	
				SPST-NC	8	861HSSRA208-DC-4	
			48–480 Vac	SPST-NO	8	861HSSRA408-DC-2	
				SPST-NO	8	861HSSRA208-AC-2	
			90–280 Vac	48–480 Vac	SPST-NO	8	861HSSRA408-AC-2
				48–480 Vac	SPST-NO	8	861HSSRA408-AC-2
	SCR	3–32 Vdc	24–280 Vac	SPST-NO	10	861HSSR210-DC-2	
				SPST-NC	10	861HSSR210-DC-4	
		48–480 Vac	SPST-NO	10	861HSSR410-DC-2		
			SPST-NO	10	861HSSR610-DC-2		
		90–280 Vac	24–280 Vac	SPST-NO	10	861HSSR210-AC-2	
			48–480 Vac	SPST-NO	10	861HSSR410-AC-2	
AC Zero Cross	Triac	3–32 Vdc	24–280 Vac	SPST-NO	8	861HSSRA208-DC-1	
				SPST-NO	8	861HSSRA408-DC-1	
			48–480 Vac	SPST-NO	8	861HSSRA208-AC-1	
				SPST-NO	8	861HSSRA408-AC-1	
			90–280 Vac	24–280 Vac	SPST-NO	8	861HSSR210-DC-1
				48–480 Vac	SPST-NO	8	861HSSR410-DC-1
	SCR	3–32 Vdc	24–280 Vac	SPST-NO	10	861HSSR210-DC-1	
				SPST-NO	10	861HSSR410-DC-1	
		48–480 Vac	SPST-NO	10	861HSSR610-DC-1		
			SPST-NO	10	861HSSR410-AC-1		
		90–280 Vac	24–280 Vac	SPST-NO	10	861HSSR210-AC-1	
			48–480 Vac	SPST-NO	10	861HSSR410-AC-1	

**861H Specifications**

Part Number	861HSSR115-DD	861HSSR208-DD	861HSSR410	861HSSR610	861HSSR610
<b>Input Characteristics</b>					
Input Voltage Range	3.5–32 Vdc	3–32 Vdc		90–280 Vac	
Must Release Voltage	1 Vdc			10 Vac	
Nominal Input Impedance	Current regulator			16–25 kW	
Typical Input Current at 5 Vdc	12 mA		16 mA (12 mA for 861HSSR210-DC-4)	12 mA	
Reverse Polarity Protection	Yes			N/A	
<b>Output Characteristics</b>					
Switching Device	MOSFET	Triac	SCR	Triac	SCR
Switching Type	DC Switching	AC Zero Cross; AC Random			
Contact Configuration	SPST-NO		SPST-NO, SPST-NC		
Output Voltage Range	3–50 Vdc; 3–150 Vdc		24–480 Vac; 48–480 Vac; 48–600 Vac		
Maximum Rate of Rise Off-State Voltage (dv/dt)	N/A	250 V/us	500 V/us, 350 V/us (861HSSR410, 861HSSR610-DC-1), 200 V/us (861HSSR210-DC-4, 861HSSR610-DC-2)	250 V/us	500 V/us, 350 V/us (861HSSR410), 250 V/us (861HSSR610)
Current Ratings	Load rating	8 A (rms), 15 A (rms)	8 A (rms)	10 A (rms)	8 A (rms)
	Incandescent lamp rating	N/A	5 A (rms)	8 A (rms)	5 A (rms)
	Motor load rating	N/A	3 A (rms)	4.5 A (rms)	3 A (rms)
Minimum Load Current—Maintain On	20 mA	150 mA	50 mA	150 mA	50 mA
Non-Replicative Surge Current (1 cycle)	861HSSR115-DD: 35 A; 861HSSR208-DD: 50 A	200 A	500 A	200 A	500 A
Maximum RMS Overload Current (1 s)	861HSSR115-DD: 17 A; 861HSSR208-DD: 24 A	24 A			
Maximum Off-State Leakage Current	0.25 mA	10 mA (rms)			
Typical On-State Voltage Drop	N/A	1.25 Vac (rms)			
Maximum On-State Voltage Drop	0.5 Vdc	1.6 Vac (rms)			
Maximum On-State Resistance	40 mW	N/A			
Maximum Turn-On Time	5 ms	8.3 ms			
Maximum Turn-Off Time	5 ms	8.3 ms			
Maximum I <sup>2</sup> T for Fusing	N/A	250 A <sup>2</sup> sec	1250 A <sup>2</sup> sec (861HSSR210); 850 A <sup>2</sup> sec (861HSSR410); 600 A <sup>2</sup> sec (861HSSR610)	250 A <sup>2</sup> sec	1250 A <sup>2</sup> sec (861HSSR210); 850 A <sup>2</sup> sec (861HSSR410); 600 A <sup>2</sup> sec (861HSSR610)



Dimensions, in. (mm)

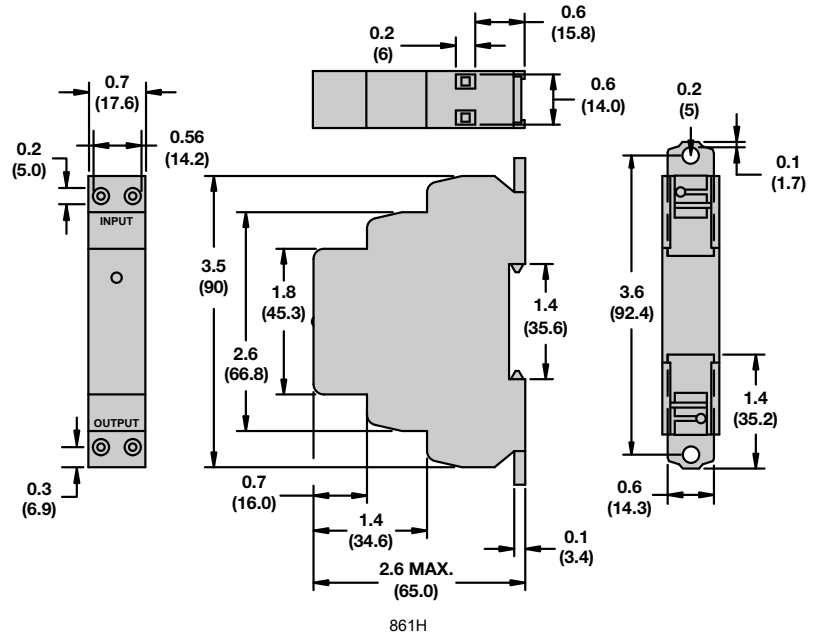

Wiring Diagram

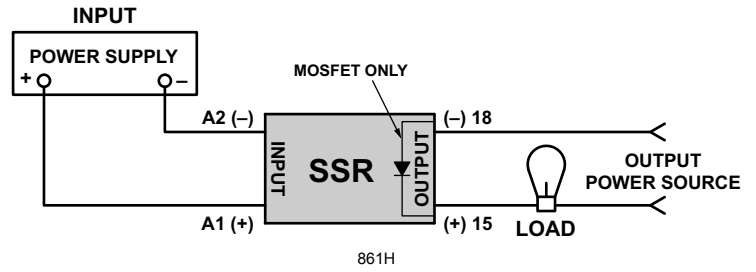

23



SSL1A12JD

### Zelio™ SSL Relays

Zelio SSL solid state relays offer the advantages of several input and output configurations for both AC and DC switching applications. Their compact size and modular design reduces space and allows easy mounting on the socket. Key features include:

- Available with zero voltage switching for resistive load and random switching for inductive load applications.
- Socket with reverse polarity protection circuit and LED indicator for easy identification of control status.

Refer to [Online EZ Selector](#).

**Table 23.66: Relays (sold in lots of 12)**

Switching	Input Voltage	Output Voltage	Contact Configuration	Load Current Range	SPDT (1 C/O)
					Catalog Number
DC switching	3–12 Vdc	1–24 Vdc	SPST N.O. (1 N/O)	3.5 A	SSL1D03JD
		1–48 Vdc	SPST N.O. (1 N/O)	0.1 A	SSL1D101JD
	15–30 Vdc	1–24 Vdc	SPST N.O. (1 N/O)	3.5 A	SSL1D03BD
		1–48 Vdc	SPST N.O. (1 N/O)	0.1 A	SSL1D101BD
	38–72 Vdc	1–24 Vdc	SPST N.O. (1 N/O)	3.5 A	SSL1D03ND
		1–48 Vdc	SPST N.O. (1 N/O)	0.1 A	SSL1D101ND
Zero voltage switching	3–12 Vdc	24–280 Vac	SPST N.O. (1 N/O)	2 A	SSL1A12JD
	15–30 Vdc	24–280 Vac	SPST N.O. (1 N/O)	2 A	SSL1A12BD
	38–72 Vdc	24–280 Vac	SPST N.O. (1 N/O)	2 A	SSL1A12ND
Random switching	3–12 Vdc	24–280 Vac	SPST N.O. (1 N/O)	2 A	SSL1A12JDR
	15–30 Vdc	24–280 Vac	SPST N.O. (1 N/O)	2 A	SSL1A12BDR
	38–72 Vdc	24–280 Vac	SPST N.O. (1 N/O)	2 A	SSL1A12NDR



SSLVA1

**Table 23.67: Sockets (sold in lots of 10)**

Control Voltage	For Use with Relays	Socket Type	
		Screw Connector Catalog Number	Spring Terminal Catalog Number
5 Vdc	SSL1D03JD SSL1D101JD SSL1A12JD SSL1A12JDR	SSLZVA1	SSLZRA1
24 Vdc	SSL1D03BD SSL1D101BD SSL1A12BD SSL1A12BDR	SSLZVA1	SSLZRA1
60 Vdc	SSL1D03ND SSL1D101ND SSL1A12ND SSL1A12NDR	SSLZVA2	SSLZRA2
110 Vac/Vdc	SSL1D03ND SSL1D101ND SSL1A12ND SSL1A12NDR	SSLZVA3	SSLZRA3
230 Vac/Vdc	SSL1D03ND SSL1D101ND SSL1A12ND SSL1A12NDR	SSLZVA4	SSLZRA4



RSLZ2



RSLZ3

**Table 23.68: Accessories**

Description	Compatibility	Catalog Number
ID tags (2 sheets of 64 tags)		RSLZ5
Bus jumper (10 x 20-pole jumper)	RSL series sockets, SSL series sockets	RSLZ2
Butterfly isolator (10 isolators)		RSLZ3

### Approvals for SSL Relays



File:  
E173076  
CCN:  
NRNT2,  
NRNT8



File:  
257594  
Class:  
3211 07



IEC 60950–1 RoHS Compliant

### Approvals for SSLZ Sockets



File:  
E172326  
CCN:  
SWIV2



File:  
254977  
Class:  
3211 07



IEC 60950–1 RoHS Compliant

RELAYS AND TIMERS

**Zelio™ SSM Relays**

Zelio SSM solid state relays are ready-to-use modular relays with SCR/MOSFET outputs for greater switching density. The unique IP20 housing design and integrated heat sink with no exposed metal surface offers compactness and enhances operating conditions of the relay. SSM relays are DIN rail mounted and available with zero voltage switching for resistive load and random switching for inductive load applications. The SSM relay range comprises:

- SSM1: Single channel, single-phase relays with 6 A and 12 A ratings
- SSM2: Dual channel, single-phase relays with 6 A rating

Refer to [Online EZ Selector](#).



SSM1A36BD



SSM1A312BD

**Table 23.69: SSM1 Single Channel Solid State Relays (sold in lots of 1)**

Switching	Input Voltage	Output Voltage	Contact Configuration	Load Current Range	Motor Load Rating	Catalog Number
DC switching	4–32 Vdc	1–60 Vdc	SPST N.O. (1 N/O)	6 A	–	SSM1D26BD
			SPST N.O. (1 N/O)	12 A	–	SSM1D212BD
		1–100 Vdc	SPST N.O. (1 N/O)	6 A	–	SSM1D36BD
			SPST N.O. (1 N/O)	12 A	–	SSM1D312BD
Zero voltage switching	4–32 Vdc	24–280 Vac	SPST N.O. (1 N/O)	6 A	1/6 hp @ 240 Vac	SSM1A16BD
			SPST N.O. (1 N/O)	12 A	1/3 hp @ 240 Vac	SSM1A112BD
		48–600 Vac	SPST N.O. (1 N/O)	6 A	1/6 hp @ 240 Vac	SSM1A36BD
			SPST N.O. (1 N/O)	12 A	1/3 hp @ 240 Vac	SSM1A312BD
	18–36 Vac	24–280 Vdc	SPST N.O. (1 N/O)	6 A	1/6 hp @ 240 Vac	SSM1A16B7
			SPST N.O. (1 N/O)	12 A	1/3 hp @ 240 Vac	SSM1A112B7
		48–600 Vac	SPST N.O. (1 N/O)	12 A	1/3 hp @ 240 Vac	SSM1A312B7
			90–140 Vac	24–280 Vac	SPST N.O. (1 N/O)	6 A
	SPST N.O. (1 N/O)	12 A			1/3 hp @ 240 Vac	SSM1A112F7
	48–600 Vac	SPST N.O. (1 N/O)		12 A	1/3 hp @ 240 Vac	SSM1A312F7
		200–265 Vac		24–280 Vac	SPST N.O. (1 N/O)	6 A
	SPST N.O. (1 N/O)		12 A		1/3 hp @ 240 Vac	SSM1A112P7
	48–600 Vac		SPST N.O. (1 N/O)	12 A	1/3 hp @ 240 Vac	SSM1A312P7
			4–32 Vdc	24–280 Vac	SPST N.O. (1 N/O)	6 A
	SPST N.O. (1 N/O)	12 A			1/3 hp @ 240 Vac	SSM1A112BDR
	48–600 Vac	SPST N.O. (1 N/O)			6 A	1/6 hp @ 240 Vac
SPST N.O. (1 N/O)		12 A			1/3 hp @ 240 Vac	SSM1A312BDR
18–36 Vac	24–280 Vac	SPST N.O. (1 N/O)		6 A	1/6 hp @ 240 Vac	SSM1A16B7R
		SPST N.O. (1 N/O)		12 A	1/3 hp @ 240 Vac	SSM1A112B7R
	48–600 Vac	SPST N.O. (1 N/O)		12 A	1/3 hp @ 240 Vac	SSM1A312B7R
		90–140 Vac		24–280 Vac	SPST N.O. (1 N/O)	6 A
SPST N.O. (1 N/O)	12 A		1/3 hp @ 240 Vac		SSM1A112F7R	
48–600 Vac	SPST N.O. (1 N/O)		12 A	1/3 hp @ 240 Vac	SSM1A312F7R	
	200–265 Vac		24–280 Vac	SPST N.O. (1 N/O)	6 A	1/6 hp @ 240 Vac
SPST N.O. (1 N/O)		12 A		1/3 hp @ 240 Vac	SSM1A112P7R	
48–600 Vac		SPST N.O. (1 N/O)	12 A	1/3 hp @ 240 Vac	SSM1A312P7R	



SSM2A36BD

**Table 23.70: SSM2 Dual Channel Solid State Relays (sold in lots of 1)**

Switching	Input Voltage	Output Voltage	Contact Configuration	Load Current Range	Catalog Number [1]
Zero voltage switching	4–32 Vdc	24–280 Vac	DPST N.O. (2 N/O)	6	SSM2A16BD
		48–600 Vac	DPST N.O. (2 N/O)	6	SSM2A36BD
Random switching	4–32 Vdc	24–280 Vac	DPST N.O. (2 N/O)	6	SSM2A16BDR
		48–600 Vac	DPST N.O. (2 N/O)	6	SSM2A36BDR

**Approvals for SSM Relays**



File: E359576  
CCN: NMFT2, NMFT8



File: 257594  
Class: 3211 04



IEC 60950-1

RoHS Compliant

[1] 4-pin connector for dual channel output only. Mating connector: MOLEX 050579404 or equivalent.



SSP1D425BD



SSM1A120M7



SSM1A445BD



SSRHP07

### Zelio™ SSL, SSM and SSP

Zelio SSL, SSM and SSP relays do not have any moving parts to wear out. Combined with vibration resistance, arc-less switching and the lack of acoustical noise, solid state relays are the ideal product for switching applications that demand reliable execution. For added reliability, the Zelio SSL, SSM and SSP solid state relays use Direct Copper Bonding (DCB) technology to decrease internal temperatures and improve the overall quality of the product. The SSR solid state relay range comprises:

- Relays for DIN rail mounting: SSRD
- Relays for panel mounting: SSRP

Key features include:

- Input voltage range 3–32 Vdc, 90–280 Vac
- Breaking capacities up to 125 A
- Zero voltage turn on, low EMI/RFI
- No moving parts
- Shock and vibration resistant
- No acoustical noise
- Fast response
- Arc-less switching
- Long life (>10<sup>9</sup> operations typical)

Refer to [Online EZ Selector](#).

**Table 23.71: Pre-assembled solid state slim relays**

Relays mounted on screw sockets (sold in lots of 30)					
1 NO contact Switching	Voltage Range		Load Current Range	Reference	Weight
	Control Input	Load Output			
	V	V	A		kg/lb
DC Switching	4 to 12	1 to 24	3.5	SSL1D03JDPV (SSL1D03JD + SSLZVA1)	0.033/0.073
	4 to 12	1 to 48	0.1	SSL1D101JDPV (SSL1D101JD + SSLZVA1)	0.033/0.073
Zero voltage switching	4 to 12	24 to 250	2	SSL1A12JDPV (SSL1A12JD+SSLZVA1)	0.033/0.073
Random switching	4 to 12	24 to 250	2	SSL1A12JDRPV (SSL1A12JDR + SSLZVA1)	0.033/0.073
DC Switching	16 to 30	1 to 24	3.5	SSL1D03BDPV (SSL1D03BD+SSLZVA1)	0.033/0.073
	16 to 30	1 to 48	0.1	SSL1D101BDPV (SSL1D101BD + SSLZVA1)	0.033/0.073
Zero voltage switching	16 to 30	24 to 250	2	SSL1A12BDPV (SSL1A12BD+SSLZVA1)	0.033/0.073
Random switching	16 to 30	24 to 250	2	SSL1A12BDRPV (SSL1A12BDR + SSLZVA1)	0.033/0.073
Relays mounted on spring sockets (sold in lots of 30)					
DC Switching	4 to 12	1 to 24	3.5	SSL1D03JDPR (SSL1D03JD+SSLZRA1)	0.033/0.073
	4 to 12	1 to 48	0.1	SSL1D101JDPR (SSL1D101JD + SSLZRA1)	0.033/0.073
Zero voltage switching	4 to 12	24 to 250	2	SSL1A12JDPR (SSL1A12JD+SSLZRA1)	0.033/0.073
Random switching	4 to 12	24 to 250	2	SSL1A12JDRPR (SSL1A12JDR + SSLZRA1)	0.033/0.073
DC Switching	16 to 30	1 to 24	3.5	SSL1D03BDPR (SSL1D03BD + SSLZRA1)	0.033/0.073
	16 to 30	1 to 48	0.1	SSL1D101BDPR (SSL1D101BD + SSLZRA1)	0.033/0.073
Zero voltage switching	16 to 30	24 to 250	2	SSL1A12BDPR (SSL1A12BD + SSLZRA1)	0.033/0.073
Random switching	16 to 30	24 to 250	2	SSL1A12BDRPR (SSL1A12BDR + SSLZRA1)	0.033/0.073

Table 23.72: Relays and sockets for customer assembly

SSL single-phase solid state relays (sold in lots of 12)					
Switching	Voltage Range		Load Current Range	Reference	Weight
	Control Input	Load Output			
	V	V	A		kg/lb
DC Switching	3 to 12	1 to 24	3.5	SSL1D03JD	0.004/0.009
		1 to 48	0.1	SSL1D101JD	0.004/0.009
	15 to 30	1 to 24	3.5	SSL1D03BD	0.004/0.009
		1 to 48	0.1	SSL1D101BD	0.004/0.009
	38 to 72	1 to 24	3.5	SSL1D03ND	0.004/0.009
1 to 48		0.1	SSL1D101ND	0.004/0.009	
Zero voltage switching	4 to 12	24 to 250	2	SSL1A12JD	0.033/0.073
Random switching	4 to 12	24 to 250	2	SSL1A12BD	0.033/0.073
DC Switching	16 to 30	1 to 24	3.5	SSL1A12ND	0.033/0.073
	16 to 30	1 to 48	0.1	SSL1A12JDR	0.033/0.073
Zero voltage switching	16 to 30	24 to 250	2	SSL1A12BDR	0.033/0.073
		24 to 250	2	SSL1A12NDR	0.033/0.073

Sockets equipped with LED and protection circuit (sold in lots of 10)					
Control Voltage (Nominal)	For Use With Relays	Socket Type		Unit Reference	Weight kg/lb
		Screw Connector	Spring Terminals		
V		Unit Reference	Weight kg/lb		
5	SSL1D03JD SSL1D101JD SSL1A12JD SSL1A12JDR	SSLZVA1	0.029/ 0.063	SSLZRA1	0.029/0.063
24	SSL1D03BD SSL1D101BD SSL1A12BD SSL1A12BDR	SSLZVA1	0.029/ 0.063	SSLZRA1	0.029/0.063
60	SSL1D03ND SSL1D101ND SSL1A12ND SSL1A12NDR	SSLZVA2	0.029/ 0.063	SSLZRA2	0.029/0.063
110	SSL1D03ND SSL1D101ND SSL1A12ND SSL1A12NDR	SSLZVA3	0.029/ 0.063	SSLZRA3	0.029/0.063
230	SSL1D03ND SSL1D101ND SSL1A12ND SSL1A12NDR	SSLZVA4	0.029/ 0.063	SSLZRA4	0.029/0.063

Table 23.73: SSM1 single-phase solid state relays (12 and 18 mm)

Description	Compatibility	Reference	Weight kg/lb
Clip-in legends (2 sheets of 64 legends)	SSL sockets	RSLZ5	0.001/0.002
Bus jumper (10 x 20-pole jumper)	SSL sockets	RSLZ2	0.001/0.002
Partition plate (10 partition plates)	SSL sockets	RSLZ3	0.001/0.002

Table 23.74: SSM1 single-phase solid state relays (12 and 18 mm)

Switching	Voltage range		Load current range	Reference	Weight kg/lb
	Control input	Load output			
	V	V			
DC switching	4...32	1...60	6	SSM1D26BD	0.050/0.110
			12	SSM1D212BD	0.090/0.198
		1...100	6	SSM1D36BD	0.050/0.110
			12	SSM1D312BD	0.090/0.198
Zero voltage switching	4...32	24...280	6	SSM1A16BD	0.050/0.110
			12	SSM1A112BD	0.090/0.198
		48...600	6	SSM1A36BD	0.050/0.110
			12	SSM1A312BD	0.090/0.198
	18...36	24...280	6	SSM1A16B7	0.050/0.110
			12	SSM1A112B7	0.090/0.198
		48...600	6	SSM1A36B7	0.050/0.110
			12	SSM1A312B7	0.090/0.198
	90...140	24...280	6	SSM1A16F7	0.050/0.110
			12	SSM1A112F7	0.090/0.198
		48...600	6	SSM1A36F7	0.050/0.110
			12	SSM1A312F7	0.090/0.198
200...265	24...280	6	SSM1A16P7	0.050/0.110	
		12	SSM1A112P7	0.090/0.198	
	48...600	6	SSM1A36P7	0.050/0.110	
		12	SSM1A312P7	0.090/0.198	
Random switching	4...32	24...280	6	SSM1A16BDR	0.050/0.110
			12	SSM1A112BDR	0.090/0.198
		48...600	6	SSM1A36BDR	0.050/0.110
			12	SSM1A312BDR	0.090/0.198
	18...36	24...280	6	SSM1A16B7R	0.050/0.110
			12	SSM1A112B7R	0.090/0.198
		48...600	6	SSM1A36B7R	0.050/0.110
			12	SSM1A312B7R	0.090/0.198
	90...140	24...280	6	SSM1A16F7R	0.050/0.110
			12	SSM1A112F7R	0.090/0.198
		48...600	6	SSM1A36F7R	0.050/0.110
			12	SSM1A312F7R	0.090/0.198
	200...265	24...280	6	SSM1A16P7R	0.050/0.110
			12	SSM1A112P7R	0.090/0.198
		48...600	6	SSM1A36P7R	0.050/0.110
			12	SSM1A312P7R	0.090/0.198

23

RELAYS AND TIMERS

**Table 23.75: SSM2 single-phase solid state relays, dual channel**

Switching	Voltage range		Load current range	Reference	Weight kg/lb
	Control input	Load output			
	V	V			
Zero voltage switching	4...32	24...280	6	SSM2A16BD	0.090/0.198
		48...6000	6	SSM2A36BD	0.090/0.198
Random switching	4...32	24...280	6	SSM2A16BDR	0.090/0.198
		48...6000	6	SSM2A36BDR	0.090/0.198

**Table 23.76: SSM1 single-phase solid state relays (22.5 and 45 mm)**

Switching	Voltage range		Load current range	Reference	Weight kg/lb
	Control input	Load output			
	V	V			
Zero voltage switching	4...32	24...280	20	SSM1A120BD	0.280/0.617
			30	SSM1A130BD	0.280/0.617
	3...32	24...280	45	SSM1A145BD	0.476/1.049
			30	SSM1A430BD	0.280/0.617
	4...32	48...660	45	SSM1A445BD	0.476/1.049
			55	SSM1A455BD	0.476/1.049
			20	SSM1A120M7	0.280/0.617
	90...280	24...280	30	SSM1A130M7	0.280/0.617
			30	SSM1A430M7	0.280/0.617
	90...140	24...280	45	SSM1A145F7	0.476/1.049
			45	SSM1A445F7	0.476/1.049
			55	SSM1A455F7	0.476/1.049

**Table 23.77: SSM3 three-phase solid state relays**

Switching	Voltage range		Load current range	Reference	Weight kg/lb
	Control input	Load output			
	V	V			
Zero voltage switching	4...32	48...600	25	SSM3A325BD	0.740/1.631
			25	SSM3A325F7	0.740/1.631
	90...140	48...600	25	SSM3A325P7	0.740/1.631
			25	SSM3A325BDR	0.740/1.631

**Table 23.78: SSP1 single-phase solid state relays**

Switching	Voltage range		Load current range	Reference	Weight kg/lb		
	Control input	Load output					
	V	V					
<b>Relays with embedded thermal pad</b>							
DC switching	3.5...32	1...150	12	SSP1D412BDT	0.089/0.196		
			25	SSP1D425BDT	0.089/0.196		
			40	SSP1D440BDT	0.089/0.196		
Zero voltage switching	3...32	24...300	10	SSP1A110BDT	0.089/0.196		
			25	SSP1A125BDT	0.089/0.196		
			50	SSP1A150BDT	0.089/0.196		
			75	SSP1A175BDT	0.089/0.196		
			50	SSP1A450BDT	0.089/0.196		
			75	SSP1A475BDT	0.089/0.196		
	4...32	48...660	90	SSP1A490BDT	0.089/0.196		
			125	SSP1A4125BDT	0.089/0.196		
			90...280	24...300	10	SSP1A110M7T	0.089/0.196
					25	SSP1A125M7T	0.089/0.196
					50	SSP1A150M7T	0.089/0.196
				48...660	75	SSP1A175M7T	0.089/0.196
50	SSP1A450M7T	0.089/0.196					
75	SSP1A475M7T	0.089/0.196					
90	SSP1A490M7T	0.089/0.196					
125	SSP1A4125M7T	0.089/0.196					
<b>Relays without embedded thermal pad</b>							
DC switching	3.5...32	1...150	12	SSP1D412BD	0.089/0.196		
			25	SSP1D425BD	0.089/0.196		
			40	SSP1D440BD	0.089/0.196		
Zero voltage switching	3...32	24...300	10	SSP1A110BD	0.089/0.196		
			20	SSP1A125BD	0.089/0.196		
			50	SSP1A150BD	0.089/0.196		
			75	SSP1A175BD	0.089/0.196		
			50	SSP1A450BD	0.089/0.196		
			75	SSP1A475BD	0.089/0.196		
	4...32	48...660	90	SSP1A490BD	0.089/0.196		
			125	SSP1A4125BD	0.089/0.196		
			90...280	24...300	10	SSP1A110M7	0.089/0.196
					25	SSP1A125M7	0.089/0.196
					50	SSP1A150M7	0.089/0.196
				48...660	75	SSP1A175M7	0.089/0.196
50	SSP1A450M7	0.089/0.196					
75	SSP1A475M7	0.089/0.196					
90	SSP1A490M7	0.089/0.196					
125	SSP1A4125M7	0.089/0.196					
<b>Relays with embedded thermal pad and smart diagnostic features</b>							
Zero voltage switching	3...32	24...300	25	SSP1A125BDS	0.097/0.214		
			50	SSP1A150BDS	0.097/0.214		
			50	SSP1A450BDS	0.097/0.214		
	4...32	48...660	75	SSP1A475BDS	0.097/0.214		
			90	SSP1A490BDS	0.097/0.214		
			125	SSP1A4125BDS	0.097/0.214		

Table 23.79: SSP3 three-phase solid state relays

Switching	Voltage range	Load output	Load current range	Reference	Weight kg/lb	
	Control input	V				
<b>Relays with embedded thermal pad</b>						
Zero voltage switching	4...32	48...530	25	SSP3A225BDT	0.240/0.529	
			50	SSP3A250BDT	0.240/0.529	
	18...36	48...530	25	SSP3A225B7T	0.240/0.529	
			50	SSP3A250B7T	0.240/0.529	
	90...140	48...530	25	SSP3A225F7T	0.240/0.529	
			50	SSP3A250F7T	0.240/0.529	
	180...280	48...530	25	SSP3A225P7T	0.240/0.529	
			50	SSP3A250P7T	0.240/0.529	
	Random switching	4...32	48...530	25	SSP3A225BDRT	0.240/0.529
				50	SSP3A250BDRT	0.240/0.529
18...36		48...530	25	SSP3A225B7RT	0.240/0.529	
			50	SSP3A250B7RT	0.240/0.529	
90...140		48...530	25	SSP3A225F7RT	0.240/0.529	
			50	SSP3A250F7RT	0.240/0.529	
180...280		48...530	25	SSP3A225P7RT	0.240/0.529	
			50	SSP3A250P7RT	0.240/0.529	
<b>Relays without embedded thermal pad</b>						
Zero voltage switching		4...32	48...530	25	SSP3A225BD	0.240/0.529
	50			SSP3A250BD	0.240/0.529	
	18...36	48...530	25	SSP3A225B7	0.240/0.529	
			50	SSP3A250B7	0.240/0.529	
	90...140	48...530	25	SSP3A225F7	0.240/0.529	
			50	SSP3A250F7	0.240/0.529	
	180...280	48...530	25	SSP3A225P7	0.240/0.529	
			50	SSP3A250P7	0.240/0.529	
	Random switching	4...32	48...530	25	SSP3A225BDR	0.240/0.529
				50	SSP3A250BDR	0.240/0.529
18...36		48...530	25	SSP3A225B7R	0.240/0.529	
			50	SSP3A250B7R	0.240/0.529	
90...140		48...530	25	SSP3A225F7R	0.240/0.529	
			50	SSP3A250F7R	0.240/0.529	
180...280		48...530	25	SSP3A225P7R	0.240/0.529	
			50	SSP3A250P7R	0.240/0.529	

Table 23.80: Heat sinks for customer assembly

Mounting	Number and type of relays supported	Surface area	Thermal resistance	Reference	Weight kg/lb
		cm <sup>2</sup> /in <sup>2</sup>	oC/W		
Panel mount	Up to 3 SSP1 units 1 SSP3 unit	6,823/1,058	0.2	SSRHP02	2.592/5.714
	Up to 3 SSP1 units 1 SSP3 unit	4,406/683	0.5	SSRHP05	1.440/3.174
	1 SSP1 unit	1,640/254	0.7	SSRHP07	0.526/1.159
	Up to 3 SSP1 units 1 SSP3 unit	1,425/221	1	SSRHP10	0.620/1.367
	Up to 2 SSP1 units	659/102	1.7	SSRHP17	0.195/0.430
	1 SSP1 unit	336/52.10	2.5	SSRHP25	0.100/0.220
DIN rail mount	Up to 3 SSP1 units 1 SSP3 unit	1,425/221	1	SSRHD10	0.630/1.389

Table 23.81: Accessories

Description	Type of relays supported	Unit reference	Weight kg/lb
Copper terminal lug for AWG 6 (13.3 mm <sup>2</sup> ) to AWG 0 (53.5 mm <sup>2</sup> ) Sold in lots of 10	SSP1	SSRAL1	0.042/0.093
Copper terminal lug for AWG 14 (2.1 mm <sup>2</sup> ) to AWG 6 (13.3 mm <sup>2</sup> ) Sold in lots of 10	SSP1	SSRAL2	0.009/0.002

Approvals for SSRP and SSRD Relays



File: E258297  
CCN: NRNT2,  
NRNT8



File: 230765  
Class: 3211 07



IEC 60950-1  
RoHS Compliant





SSP3A225P7

**Zelio™ SSP Relays**

Zelio SSP solid state relays are three-phase panel mounted relays with IP20 housing. The SCR outputs allow them to be used in various power switching applications. These power relays with 25 A and 50 A current rating are EMC compliant. SSP relays are integrated with an R-C snubber circuit and TVS (Transient Voltage Suppression). They are available with zero voltage switching for resistive load and random switching for inductive load applications.

Refer to [Online EZ Selector](#).

**Table 23.82: SSP Three-Phase Solid State Relays (sold in lots of 1)**

Switching	Input Voltage	Output Voltage	Contact Configuration	Load Current Range	Motor Load Rating	Catalog Number [2]
Zero voltage switching	4–32 Vdc	48–530 Vac	3PST N.O. (3 N/O)	25 A	3/4 hp @ 120 Vac 1 hp @ 240 Vac 3 hp @ 480 Vac 4.4 hp @ 530 Vac	SSP3A225BD
				50 A	1.5 hp @ 120 Vac 3 hp @ 240 Vac 7.5 hp @ 480 Vac 8.8 hp @ 530 Vac	SSP3A250BD
	18–36 Vac	48–530 Vac	3PST N.O. (3 N/O)	25 A	3/4 hp @ 120 Vac 1 hp @ 240 Vac 3 hp @ 480 Vac 4.4 hp @ 530 Vac	SSP3A225B7
				50 A	1.5 hp @ 120 Vac 3 hp @ 240 Vac 7.5 hp @ 480 Vac 8.8 hp @ 530 Vac	SSP3A250B7
	90–140 Vac	48–530 Vac	3PST N.O. (3 N/O)	25 A	3/4 hp @ 120 Vac 1 hp @ 240 Vac 3 hp @ 480 Vac 4.4 hp @ 530 Vac	SSP3A225F7
				50 A	1.5 hp @ 120 Vac 3 hp @ 240 Vac 7.5 hp @ 480 Vac 8.8 hp @ 530 Vac	SSP3A250F7
	180–280 Vac	48–530 Vac	3PST N.O. (3 N/O)	25 A	3/4 hp @ 120 Vac 1 hp @ 240 Vac 3 hp @ 480 Vac 4.4 hp @ 530 Vac	SSP3A225P7
				50 A	1.5 hp @ 120 Vac 3 hp @ 240 Vac 7.5 hp @ 480 Vac 8.8 hp @ 530 Vac	SSP3A250P7
Random switching	4–32 Vdc	48–530 Vac	3PST N.O. (3 N/O)	25 A	3/4 hp @ 120 Vac 1 hp @ 240 Vac 3 hp @ 480 Vac 4.4 hp @ 530 Vac	SSP3A225BDR
				50 A	1.5 hp @ 120 Vac 3 hp @ 240 Vac 7.5 hp @ 480 Vac 8.8 hp @ 530 Vac	SSP3A250BDR
	18–36 Vac	48–530 Vac	3PST N.O. (3 N/O)	25 A	3/4 hp @ 120 Vac 1 hp @ 240 Vac 3 hp @ 480 Vac 4.4 hp @ 530 Vac	SSP3A225B7R
				50 A	1.5 hp @ 120 Vac 3 hp @ 240 Vac 7.5 hp @ 480 Vac 8.8 hp @ 530 Vac	SSP3A250B7R
	90–140 Vac	48–530 Vac	3PST N.O. (3 N/O)	25 A	3/4 hp @ 120 Vac 1 hp @ 240 Vac 3 hp @ 480 Vac 4.4 hp @ 530 Vac	SSP3A225F7R
				50 A	1.5 hp @ 120 Vac 3 hp @ 240 Vac 7.5 hp @ 480 Vac 8.8 hp @ 530 Vac	SSP3A250F7R
	180–280 Vac	48–530 Vac	3PST N.O. (3 N/O)	25 A	3/4 hp @ 120 Vac 1 hp @ 240 Vac 3 hp @ 480 Vac 4.4 hp @ 530 Vac	SSP3A225P7R
				50 A	1.5 hp @ 120 Vac 3 hp @ 240 Vac 7.5 hp @ 480 Vac 8.8 hp @ 530 Vac	SSP3A250P7R

RELAYS AND TIMERS

23

[2] Add a T to the end of the part number to order the SSP with a thermal pad interface.

23

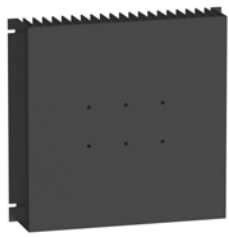

SSRHP02

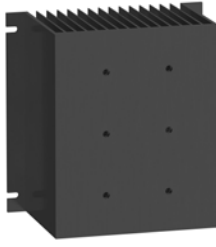

SSRHP05

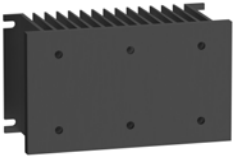

SSRHP10



SSRAT1

RELAYS AND TIMERS

Table 23.83: Accessories

Description	Compatibility	Thermal Resistance	Catalog Number
Heat sink panel mount (lot of 10)	1 x SSP 1 x SSRP 2 x SSRP 3 x SSRP	0.2 °C/W	SSRHP02
	1 x SSP 1 x SSRP 2 x SSRP 3 x SSRP	0.5 °C/W	SSRHP05
	1 x SSP 1 x SSRP 2 x SSRP	1 °C/W	SSRHP10
	1 x SSRP 2 x SSRP	1.7 °C/W	SSRHP17
	1 x SSRP	2.5 °C/W	SSRHP25
Heat sink DIN rail mount (lot of 1)	1 x SSP 1 x SSRP 2 x SSRP	0.9 °C/W	SSRAH1
	1 x SSP 1 x SSRP 2 x SSRP	1 °C/W	SSRHD10
Thermal pad interface (lot of 10)	SSRPP8S**** SSRPCDS**** SSRPCDM****	—	SSRAT1

Approvals for SSP Relays



File: E359576  
CCN: NMFT2,  
NMFT8



File: 257594  
Class: 3211 04



RoHS  
Compliant



6000 Series Relays

**6000 Solid-State Relays**  
6000—SPST-NO, 10–75 A DPST-NO, 10–25 A

Switching Type	Switching Device	Input Voltage Range	Output Voltage Range	Contact Configuration	Rated Output Current (A)	Standard Part Number	
DC Switching	MOSFET	3.5–32 Vdc	3–200 Vdc	SPST-NO	12	6312AXXMDS-DC3	
					25	6325AXXMDS-DC3	
					40	6340AXXMDS-DC3	
AC Zero Cross	SCR	3–32 Vdc	24–280 Vac	SPST-NO	10	6210AXXSZS-DC3	
					25	6225AXXSZS-DC3	
					40	6240AXXSZS-DC3	
			48–480 Vac	SPST-NO	50	6250AXXSZS-DC3	
					75	6275AXXSZS-DC3	
					25	6425AXXSZS-DC3	
		90–280 Vac	24–280 Vac	SPST-NO	40	6440AXXSZS-DC3	
					50	6450AXXSZS-DC3	
					75	6475AXXSZS-DC3	
			48–480 Vac	SPST-NO	25	6210AXXSZS-AC90	
					40	6225AXXSZS-AC90	
					50	6240AXXSZS-AC90	
		TRIAIC <sup>[3]</sup>	3–32 Vdc	24–280 Vac	DPST-NO	10	6210BXXTZB-DC3
						25	6425AXXTZB-DC3
						25	6425BXXTZB-DC3
				48–480 Vac	DPST-NO	40	6440AXXSZS-AC90
						50	6450AXXSZS-AC90
						75	6475AXXSZS-AC90

RELAYS AND TIMERS

23

**6000 Specifications (UL 508)**

Part Number	6210AXXSZS-DC3	6225AXXSZS-DC3	6240AXXSZS-DC3	6250AXXSZS-DC3
<b>Input Characteristics</b>				
Control Voltage Range	90–280 Vac (rms)		3–32 Vdc	4–32 Vdc
Maximum Turn-On Voltage	90 Vac (rms)		3 Vdc	4 Vdc
Minimum Turn-Off Voltage	10 Vac (rms)		1 Vdc	
Nominal Input Impedance	60 kΩ		N/A (active current limiter)	
Typical Input Current	2 mA at 120 V (rms); 4 mA at 240 V (rms)		10 mA at 12 Vdc	15 mA DC
<b>Output Characteristics</b>				
Switching Device	SCR			
Switching Type	AC Zero Cross			
Contact Configuration	SPST-NO			
Output Current Range	10–75 A	10–25 A	10–50 A	25–50 A
Output Voltage Range (47–63 Hz)	24–280 Vac (rms)	48–530 Vac (rms)	24–280 Vac (rms)	48–530 Vac (rms)
Transient Overvoltage	600 Vpk	1200 Vpk	600 Vpk	1200 Vpk
Maximum Off-State Leakage Current at Rated Voltage	10 mA (rms)		1 mA (rms)	
Minimum Off-State dv/dt at Maximum Rated Voltage	500 V/us			
Minimum Load Current	40 mA (rms)		150 mA (rms)	
Maximum Surge Current (16.6 ms)	10 A: 120 Apk 25 A: 250 Apk 40/50 A: 625 Apk 75 A: 1000 Apk	10 A: 140 Apk 25 A: 250 Apk	10 A: 120 Apk 25 A: 250 Apk 40/50 A: 625 Apk	25 A: 250 Apk 50 A: 625 Apk
Maximum On-State Voltage Drop at Rated Current	1.6 V (rms)	1.7 V (rms)	1.6 V (rms)	
Maximum I <sup>2</sup> T for Fusing (8.3 ms)	10 A: 60 A <sup>2</sup> sec 25 A: 260 A <sup>2</sup> sec 40/50 A: 1620 A <sup>2</sup> sec 75 A: 4150 A <sup>2</sup> sec	10 A: 81 A <sup>2</sup> sec 25 A: 260 A <sup>2</sup> sec	10 A: 60 A <sup>2</sup> sec 25 A: 260 A <sup>2</sup> sec 40/50 A: 1620 A <sup>2</sup> sec	25 A: 260 A <sup>2</sup> sec 50 A: 1620 A <sup>2</sup> sec

[3] Blade terminals.

6000 Specifications (UL 508) Continued

23

RELAYS AND TIMERS

Part Number	125A/250Vdc	125A/32Vdc
<b>Input Characteristics</b>		
Control Voltage Range	3–32 Vdc	3.5–32 Vdc
Maximum Turn-On Voltage	3 Vdc	3.5 Vdc
Minimum Turn-Off Voltage	1 Vdc	
Nominal Input Impedance	Active current limiter	1 kΩ
Typical Input Current	25 A: 16 mA 10 A: 2 mA	10 mA
<b>Output Characteristics</b>		
Switching Device	TRIAC	MOSFET
Switching Type	AC Zero Cross	DC Switching
Contact Configuration	SPST-NO, DPST-NO	SPST-NO
Output Current Range	10–25 A	12–40 A
Output Voltage Range	10 A: 24–280 Vac 25 A: 48–480 Vac	3–200 Vdc
Transient Overvoltage	600 Vpk	200 Vpk
Maximum Off-State Leakage Current at Rated Voltage	10 mA	< 1 mA
Minimum Off-State dv/dt at Maximum Rated Voltage	250 V/us	N/A
Minimum Load Current—Maintain	80 mA	N/A
Maximum Surge Current (16.6 ms)	250 A	12 A: 27 A 25 A: 50 A 40 A: 90 A
Maximum On-State Voltage Drop at Rated Current	1.6 Vac (rms)	2.8 Vdc (at 40 A load)
Maximum I <sup>2</sup> T for Fusing (8.3 ms)	200 A <sup>2</sup> s	N/A
Minimum Power Factor (with Maximum Load)	0.5	0.95

Dimensions, in. (mm)

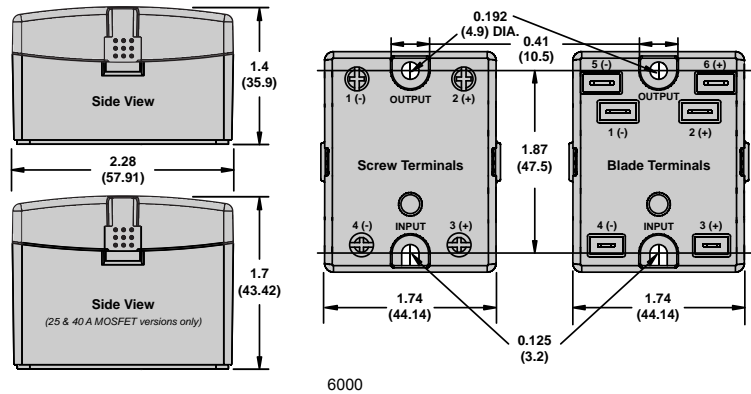

Wiring Diagram

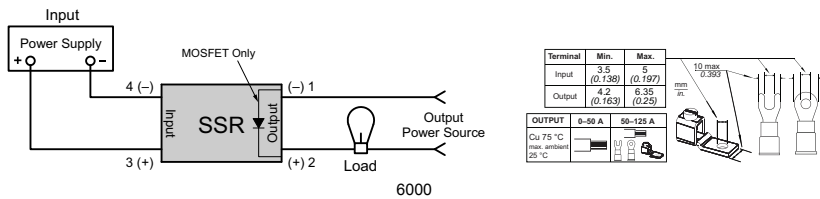

SSRDIN Solid-State Relays

SSRDIN—SPST-NO, 10–45 A



SSRDIN Relay

Switching Type	Switching Device	Input Voltage Range	Output Voltage Range	Contact Configuration	Rated Output Current (A)	Standard Part Number
DC Switching	MOSFET	4–32 Vdc	0–60 Vdc	SPST-NO	10	SSR310DIN-DC22
					20	SSR320DIN-DC22
					30	SSR330DIN-DC22
AC Zero Cross	SCR	4–32 Vdc	24–280 Vac	SPST-NO	10	SSR210DIN-DC22
					20	SSR220DIN-DC22
					30	SSR230DIN-DC22
		3–32 Vdc	24–280 Vac	SPST-NO	45	SSR245DIN-DC45
					10	SSR610DIN-DC22
					20	SSR620DIN-DC22
		4–32 Vdc	48–660 Vac	SPST-NO	30	SSR630DIN-DC22
					45	SSR645DIN-DC45
					65	SSR665DIN-AC-45
		90–280 Vac	24–280 Vac	SPST-NO	10	SSR210DIN-AC22
					20	SSR220DIN-AC22
					30	SSR230DIN-AC22
		90–140 Vac	24–280 Vac	SPST-NO	45	SSR245DIN-AC45
					10	SSR610DIN-AC22
					20	SSR620DIN-AC22
90–280 Vac	48–660 Vac	SPST-NO	30	SSR630DIN-AC22		
			45	SSR645DIN-AC45		
			65	SSR665DIN-AC-45		

SSRDIN Specifications (UL 508)

Part Number	SSR210DIN-DC22	SSR220DIN-DC22	SSR230DIN-DC22	SSR245DIN-DC45	SSR610DIN-DC22
<b>Input Characteristics</b>					
Input Voltage Range	10/20/30 A: 4–32 Vdc; 45/65 A: 3–32 Vdc			10/20/30 A: 90–280 Vac; 45/65 A: 90–140 Vac	
Maximum Turn-On Voltage	4 Vdc			90 Vrms	
Minimum Turn-Off Voltage	1 Vdc			10 Vrms	
Typical Input Current	8–12 mA	9–11 mA	8–12 mA	2–4 mA	
<b>Output Characteristics</b>					
Output Type	SCR	MOSFET	SCR		
Switching Type	AC Zero Cross	DC Switching	AC Zero Cross		
Output Voltage	24–280 Vac	0–60 Vdc	48–660 Vac	24–280 Vac	48–660 Vac
Load Current Range	10–45 A	10–30 A	10–45 A		
Transient Overvoltage	600 Vpk	N/A	1200 Vpk	600 Vpk	1200 Vpk
Maximum Surge Current	10 A: 120 Apk; 20 A: 250 Apk; 30/45 A: 625 Apk (at 16.6 ms)	10 A: 30 Apk; 20 A: 60 Apk; 30 A: 90 Apk (at 10 ms)	625 Apk (at 16.6 ms)	10 A: 120 Apk; 20 A: 250 Apk; 30/45 A: 625 Apk (at 16.6 ms)	625 Apk (at 16.6 ms)
Maximum On-State Voltage Drop at Rated Current	1.6 Vpk	10 A: 0.2 Vpk; 20 A: 0.4 Vpk; 30 A: 0.5 Vpk	1.6 Vpk	1.6 Vpk	1.6 Vpk
Maximum I <sup>2</sup> t For Fusing, (8.3 ms)	10 A: 60 A <sup>2</sup> sec; 20 A: 260 A <sup>2</sup> sec; 30/45 A: 1620 A <sup>2</sup> sec	N/A	1620 A <sup>2</sup> sec	10 A: 60 A <sup>2</sup> sec; 20 A: 260 A <sup>2</sup> sec; 30/45 A: 1620 A <sup>2</sup> sec	1620 A <sup>2</sup> sec
Maximum Off-State Leakage Current at Rated Voltage	10 mA	0.1 mA	1 mA	10 mA	1 mA
Maximum Rate of Rise Off-State Voltage (dv/dt)	500 V/us	N/A	500 V/us		
Maximum Response Time (On and Off)	1/2 cycle	1.0 ms	1/2 cycle		
Maximum On-State Resistance	N/A	10 A: 20 mΩ; 20 A: 18 mΩ; 30 A: 16 mΩ	N/A		

RELAYS AND TIMERS

23

Dimensions, in. (mm)

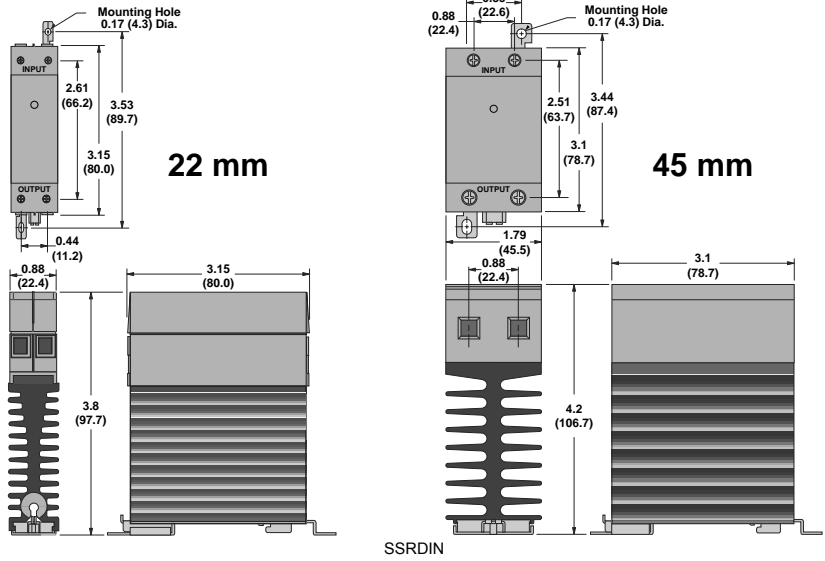

Wiring Diagram

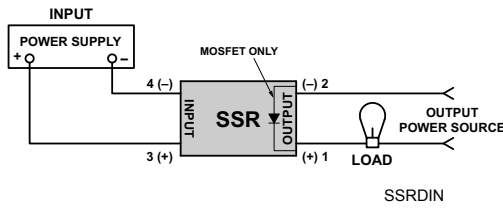

	22 mm		45 mm	
	input	output	input	output
a	6 mm <sup>2</sup>	6 mm <sup>2</sup>	4 mm <sup>2</sup>	10 mm <sup>2</sup>
	AWG 10	AWG 10	AWG 12	AWG 8

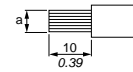



861 Relay

**861 Solid-State Relays**  
861—SPST-NO, 8–15 A SPST-NC, 10 A

Switching Type	Switching Device	Input Voltage Range	Output Voltage Range	Contact Configuration	Rated Output Current (A)	Standard Part Number
DC Switching	MOSFET	3.5–32 Vdc	3–50 Vdc	SPST-NO	15	861SSR115-DD
			3–150 Vdc	SPST-NO	8	861SSR208-DD
AC Random	Triac	3–32 Vdc	24–280 Vac	SPST-NO	8	861SSRA208-DC-2
			24–280 Vac	SPST-NC	8	861SSRA208-DC-4
			48–480 Vac	SPST-NO	8	861SSRA408-DC-2
			48–480 Vac	SPST-NO	8	861SSRA408-AC-2
	SCR	3–32 Vdc	24–280 Vac	SPST-NO	10	861SSR210-DC-2
			24–280 Vac	SPST-NC	10	861SSR210-DC-4
			48–480 Vac	SPST-NO	10	861SSR410-DC-2
			48–480 Vac	SPST-NO	10	861SSR410-DC-2
			24–280 Vac	SPST-NO	10	861SSR210-AC-2
			48–480 Vac	SPST-NO	10	861SSR210-AC-2
AC Zero Cross	Triac	3–32 Vdc	24–280 Vac	SPST-NO	8	861SSRA208-DC-1
			48–480 Vac	SPST-NO	8	861SSRA408-DC-1
			24–280 Vac	SPST-NO	8	861SSRA208-AC-1
			48–480 Vac	SPST-NO	8	861SSRA408-AC-1
	SCR	3–32 Vdc	24–280 Vac	SPST-NO	10	861SSR210-DC-1
			48–480 Vac	SPST-NO	10	861SSR410-DC-1
			48–480 Vac	SPST-NO	10	861SSR410-DC-1
			24–280 Vac	SPST-NO	10	861SSR210-AC-1
			48–480 Vac	SPST-NO	10	861SSR410-AC-1
			48–600 Vac	SPST-NO	10	861SSR610-AC-1

**861 Specifications (UL 508)**

Part Number	861SSR-DC	861SSRA-DC	861SSR-DC	861SSRA-AC	861SSR-AC
<b>Input Characteristics</b>					
Input Voltage Range	3.5–32 Vdc	3–32 Vdc		90–280 Vac	
Must Release Voltage	1 Vdc			10 Vac	
Nominal Input Impedance	Current regulator			16–25 kW	
Typical Input Current at 5 Vdc	12mA		16 mA; 12 mA (861SSR210-DC-4)	12mA	
Reverse Polarity Protection	Yes			N/A	
<b>Output Characteristics</b>					
Switching Device	MOSFET	Triac	SCR	Triac	SCR
Switching Type	DC Switching		AC Zero Cross; AC Random		
Contact Configuration	SPST-NO		SPST-NO; SPST-NC		
Output Voltage Range	3–50 Vdc; 3–150 Vdc		24–280 Vac; 48–480 Vac; 48–600 Vac		
Maximum Rate of Rise, Off-State Voltage (dv/dt)	N/A	250 V/us	500 V/us; 350 V/us (861SSR410, 861SSR610-DC-1); 200 V/us (861SSR210-DC-4, 861SSR610-DC-2)	250 V/us	500 V/us; 350 V/us (861SSR410); 250 V/us (861SSR610)
Current Ratings	Load rating: 8 A rms, 15 A rms	Load rating: 8 A (rms) Incandescent lamp rating: 5 A (rms) Motor load rating: 3 A (rms)	Load rating: 10 A (rms) Incandescent lamp rating: 8 A (rms) Motor load rating: 4.5 A (rms)	Load rating: 8 A (rms) Incandescent lamp rating: 5 A (rms) Motor load rating: 3 A (rms)	Load rating: 10 A (rms) Incandescent lamp rating: 8 A (rms) Motor load rating: 4.5 A (rms)
Minimum Load Current—Maintain On	20mA	150mA	50 mA	150mA	50 mA
Non-Replicative Surge Current (1 cycle)	861SSR115-DD: 35 A; 861SSR208-DD: 50 A	200 A	500 A	200 A	500 A
Maximum RMS Overload Current (1 s)	861SSR115-DD: 17 A; 861SSR208-DD: 24 A	24 A			
Maximum Off-State Leakage Current	0.25 mA	10 mA (rms)			
Typical On-State Voltage Drop	N/A	1.25 Vac (rms)			
Maximum On-State Voltage Drop	0.5 Vdc	1.6 Vac (rms)			
Maximum On-State Resistance	40 mW	N/A			
Maximum Turn-On Time	5 ms	8.3 ms			
Maximum Turn-Off Time	5 ms	8.3 ms			
Maximum I <sup>2</sup> T for Fusing	N/A	250 A <sup>2</sup> sec	1250 A <sup>2</sup> sec (861SSR210); 850 A <sup>2</sup> sec (861SSR410); 600 A <sup>2</sup> sec (861SSR610)	250 A <sup>2</sup> sec	1250 A <sup>2</sup> sec (861SSR210); 850 A <sup>2</sup> sec (861SSR410); 600 A <sup>2</sup> sec (861SSR610)

Dimensions, in. (mm)

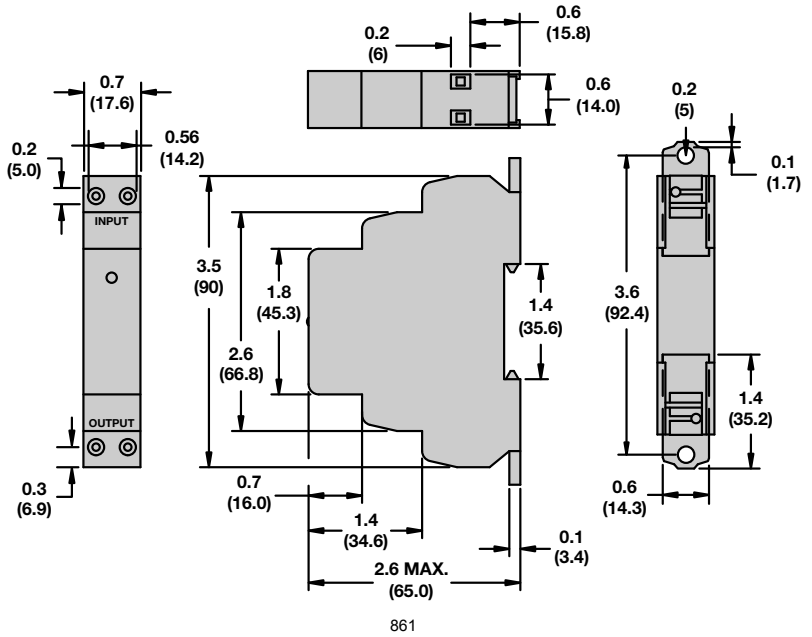

Wiring Diagram

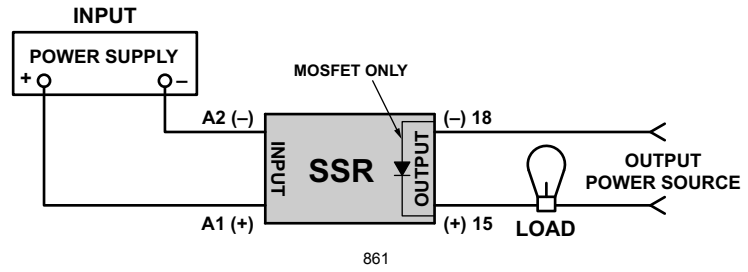





70S2 (V) Relay



70S2 (F) Relay



70S2 (S) Relay



70S2 (M) Relay



70S2 (N) Relay

70S2 Solid-State Relays

70S2—SPST-NO, 3–25 A

Part Number	70S2014	70S202	70S2035	70S2036
<b>Input Characteristics</b>				
Control Voltage Range	3–15 Vdc	9–30 Vdc	3–30 Vdc	
Must Release Voltage	1 Vdc			
Typical Input Current	5–40 mA	5–17 mA	7–16 mA	6–10 mA
Maximum Reverse Control Voltage	3 Vdc			
<b>Output Characteristics</b>				
Switching Device	MOSFET		TRIAC	
Switching Type	DC Switching		AC Zero Cross	
Contact Configuration	SPST-NO			
Output Voltage Range	3–60 Vdc		24–140 Vac	24–280 Vac
Peak Blocking Voltage	105 Vdc		400 Vac	600 Vac
Maximum Rate of Rise Off-State Voltage (dv/dt)	N/A		300 V/us	
Output Current Range (rms)	3–5 A	5 A	25 A	25 A
Minimum Load Current—Maintain On	N/A		100 mA	
Non-Repetitive Surge Current (8.3 ms)	3 A: 5 A (1 s); 5 A: 7 A (1 s)		300 A	
Maximum Off-State Leakage Current (rms)	10 mA		6 mA	
Typical On-State Voltage Drop (rms)	3 A: 1.2 Vdc; 5 A: 1.85 Vdc		1.7 Vac	
Maximum Turn-On Time	75 ms		8.3 ms	
Maximum Turn-Off Time	3 A: 500 ms; 5 A: 75 ms		8.3 ms	

70S2 Specifications (UL 508)

Part Number	70S2014	70S202	70S2035	70S2036
<b>Input Characteristics</b>				
Control Voltage Range	3–15 Vdc	9–30 Vdc	3–30 Vdc	
Must Release Voltage	1 Vdc			
Typical Input Current	5–40 mA	5–17 mA	7–16 mA	6–10 mA
Maximum Reverse Control Voltage	3 Vdc			
<b>Output Characteristics</b>				
Switching Device	MOSFET		TRIAC	
Switching Type	DC Switching		AC Zero Cross	
Contact Configuration	SPST-NO			
Output Voltage Range	3–60 Vdc		24–140 Vac	24–280 Vac
Peak Blocking Voltage	105 Vdc		400 Vac	600 Vac
Maximum Rate of Rise Off-State Voltage (dv/dt)	N/A		300 V/us	
Output Current Range (rms)	3–5 A	5 A	25 A	25 A
Minimum Load Current—Maintain On	N/A		100 mA	
Non-Repetitive Surge Current (8.3 ms)	3 A: 5 A (1 s); 5 A: 7 A (1 s)		300 A	
Maximum Off-State Leakage Current (rms)	10 mA		6 mA	
Typical On-State Voltage Drop (rms)	3 A: 1.2 Vdc; 5 A: 1.85 Vdc		1.7 Vac	
Maximum Turn-On Time	75 ms		8.3 ms	
Maximum Turn-Off Time	3 A: 500 ms; 5 A: 75 ms		8.3 ms	

70S2 Specifications (UL 508) Continued

Part Number	70S2043	70S2044	70S2045	70S205C	70S206C
<b>Input Characteristics</b>					
Control Voltage Range	3 A: 3–32 Vdc; 4/6/10/12 A: 3–30 Vdc			6–30 Vdc	3–30 Vdc
Must Release Voltage	1 Vdc				
Typical Input Current	3 A: 1–19 mA; 4/6/10/12 A: 7–16 mA			6–10 mA	1–17 mA
Maximum Reverse Control Voltage	3 Vdc				
<b>Output Characteristics</b>					
Switching Device	TRIAC				
Switching Type	AC Zero Cross				
Contact Configuration	SPST-NO				
Output Voltage Range	24–140 Vac	24–280 Vac	8–50 Vac	24–280 Vac	
Peak Blocking Voltage	400 Vac	600 Vac	200 Vac	600 Vac	
Maximum Rate of Rise Off-State Voltage (dv/dt)	300 V/us				
Output Current Range (rms)	3–12 A	3–12 A	3 A	12 A	
Minimum Load Current—Maintain On	3/4/6 A: 75 mA; 10/12 A: 100 mA				
Non-Repetitive Surge Current (8.3 ms)	3/4/6 A: 60 A; 10/12 A: 150 A				
Maximum Off-State Leakage Current (rms)	6 mA			10 mA	6 mA
Typical On-State Voltage Drop (rms)	1.6 Vac				
Maximum Turn-On Time	8.3 ms				
Maximum Turn-Off Time	8.3 ms				

Dimensions, in. (mm)

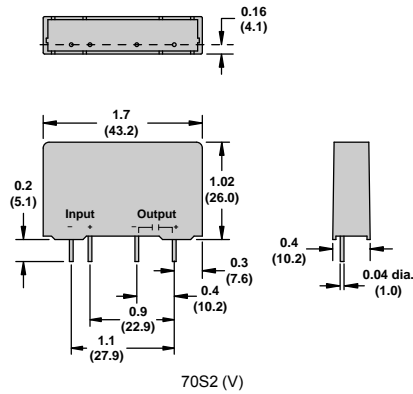
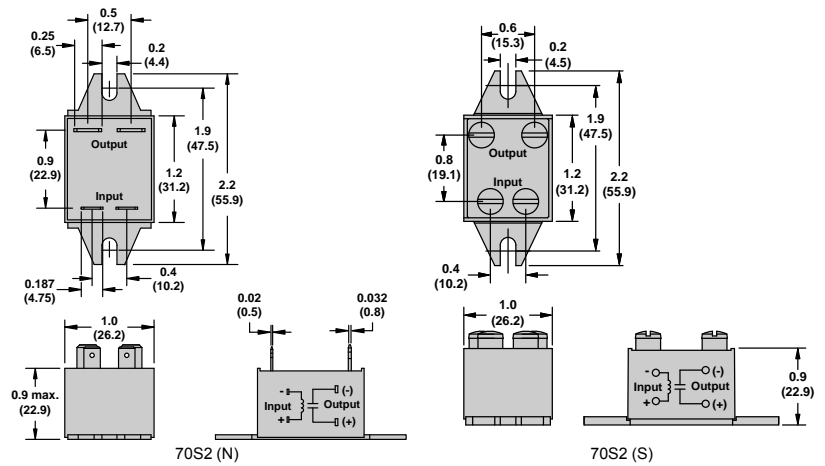
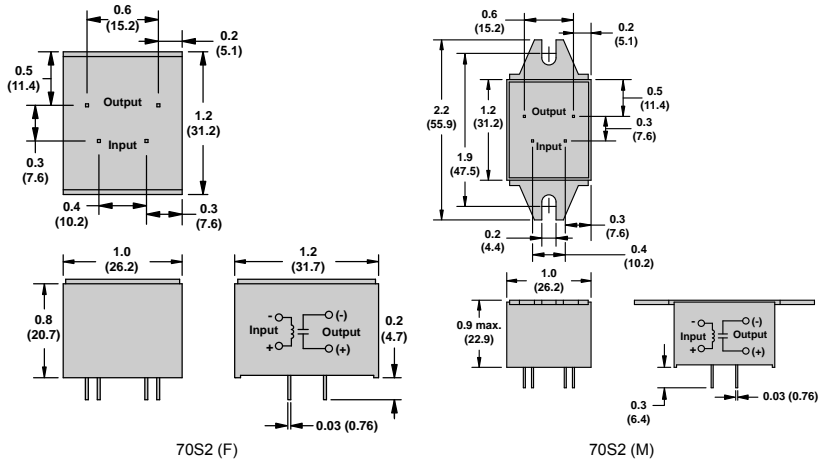

Wiring Diagram

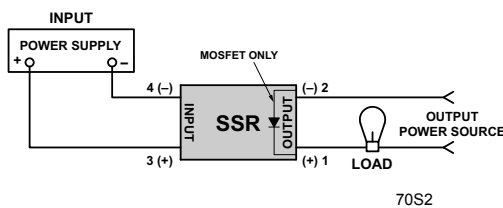

22 mm		45 mm	
input	output	input	output
6 mm <sup>2</sup>	4 mm <sup>2</sup>	10 mm <sup>2</sup>	10 mm <sup>2</sup>
AWG 10	AWG 12	AWG 8	AWG 8

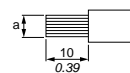



CAD32

### TeSys™ D IEC Style Instantaneous Control Relays

These 600 V relays are approved for use around the world. TeSys D relays are usually mounted on 35 mm DIN track, but can also be mounted directly to a panel. The contacts have NEMA A600 and Q600 ratings, in addition to the standard IEC ratings, making them suitable for use in most any control circuit. Low consumption versions are available for use with low level DC control signals from a computer or a PLC. Adder decks can be added to a basic five pole relay to make it up to an 11 pole relay. The serrated silver-nickel contacts with wiping action provide excellent reliability in 12 or 24 V control circuits. Special auxiliary contacts are available for switching low power down to 5 V at 10 mA. Timer and mechanical latch attachments are available.

Table 23.84: Instantaneous Control Relays

Terminal Type	Number of Contacts	Contact Composition		Catalog Number <sup>[1]</sup>
		Normally Open	Normally Closed	
Screw Clamp	5	5	0	CAD50
		3	2	CAD32
Spring Terminal	5	5	0	CAD503
		3	2	CAD323
Ring Tongue	5	5	0	CAD506
		3	2	CAD326

Table 23.85: Coil Voltage Codes:  
12–240 Vac, 12–72 Vdc, 5–72 Vdc Low Consumption<sup>[2]</sup>

AC 50/60 Hz Coil (for additional voltage code options see page 7 of Catalog 8501CT0101)						
Volts	12	24	48	120	208	240
Code	J7	B7	E7	G7	LE7	U7
DC Coil (coils have built in suppression as standard)						
Volts	12	24	36	48	60	72
Code	JD	BD	CD	ED	ND	SD
DC Low Consumption Coil (coils have built in suppression as standard)						
Volts	5	12	24	48	72	
Code	AL	JL	BL	EL	SL	

Table 23.86: Coil Voltage Codes (cont.):  
277–600 Vac, 110–440 Vdc<sup>[2]</sup>

AC 50/60 Hz Coil (for additional voltage code options see page 7 of Catalog 8501CT0101)				
Volts	277	480	600	
Code	W7	T7	X7	
DC Coil (coils have built in suppression as standard)				
Volts	110	125	220	250 440
Code	FD	GD	MD	UD RD

Table 23.87: Instantaneous Auxiliary Contact Blocks (for use in normal operation environments)

Number of Contacts	Maximum Number per Device Clip-on Mounting		Termination Type	Contact Composition		Catalog Number
	Front	Left Side Only		Normally Open	Normally Closed	
2	1	—	Screw Clamp	2	0	LADN20
				1	1	LADN11
				0	2	LADN02
	—	1 Not for DC devices	Spring Terminal	2	0	LADN203
				1	1	LADN113
				0	2	LADN023
4 <sup>[3]</sup>	1	—	Screw Clamp	2	0	LAD8N20
				1	1	LAD8N11
				0	2	LAD8N02
				4	0	LADN40
				3	1	LADN31
				2	2	LADN22
	—	—	Spring Terminal	1	3	LADN13
				0	4	LADN04
				4	0	LADN403
				3	1	LADN313
				2	2	LADN223
				1	3	LADN133
4 <sup>[3]</sup>	1	—	Screw Clamp	2 <sup>[4]</sup>	2 <sup>[4]</sup>	LADC22
			Spring Terminal	2 <sup>[4]</sup>	2 <sup>[4]</sup>	LADC223

Table 23.88: Instantaneous Auxiliary Contacts with Dust and Damp Protected Contacts (for use in harsh industrial environments)

Number of Contacts	Maximum Number per Device	Contact Composition					Catalog Number
		Sealed	[5]	Normal			
2	1	2	—	—	—	—	LA1DX20
		—	2	—	—	—	LA1DX02
		2	—	2	—	—	LA1DY20
4 <sup>[3]</sup>	1	2	—	—	2	—	LA1DZ40
		2	—	—	1	1	LA1DZ31

### Approvals for TeSys D IEC Style Instantaneous Control Relays



File: E164353  
CCN: NKCR



File: LR43364  
Class: 3211 03



- For replacement AC coils, see TeSys™ D and F Overload Relay Accessories, page . DC coils are not replaceable.

[1] Add the proper voltage code from Table 23.85 or Table 23.86 to the end of the catalog number. For example, CAD50B7.  
 [2] Add the proper voltage code to the end of catalog number.  
 [3] Auxiliary contact blocks with four contacts cannot be used on relays with low consumption coils.  
 [4] Includes 1 N.O. and 1 N.C. overlapping contact.  
 [5] Grounding terminal points (2 terminals jumpered together; see diagram on page 8 of Catalog 8501CT0101).

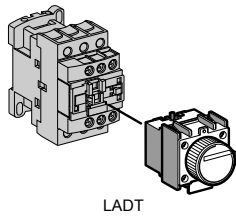

LADT

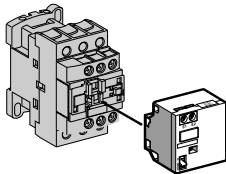

LA6DK

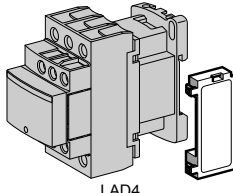

LAD4

## TeSys™ D IEC Style Contact Blocks and Accessories

Table 23.89: Time Delay Auxiliary Contact Blocks

Number and Type of Contacts	Maximum Number per Device	Time Delay Type	Termination Type	Range	Catalog Number
	Front Mounting				
1 N.C. and 1 N.O.	1	On-Delay	Screw Clamp	0.1–3 s [6]	LADT0
				0.1–30 s	LADT2
				10–180 s	LADT4
			Spring Terminal	1–30 s [7]	LADS2
				0.1–3 s [6]	LADT03
		Off-Delay	Screw Clamp	0.1–30 s	LADT23
				10–180 s	LADT43
				1–30 s [7]	LADS23
			Spring Terminal	0.1–3 s [6]	LADR0
				0.1–30 s	LADR2
			10–180 s	LADR4	
			0.1–3 s [6]	LADR03	
			0.1–30 s	LADR23	
			10–180 s	LADR43	

NOTE: For Lockout Cover, see page 7 of catalog 8501CT0101.

Table 23.90: Mechanical Latch Blocks [8]

Unlatching Control	Maximum Number per Device	Catalog Number [9]
	Front Mounting	
Manual or electrical	1	LAD6K10

Table 23.91: Coil Suppressor Modules

These modules clip onto the right hand side of the control relay and the electrical connection is instantly made. Adding an input module is still possible.

### RC Circuits (Resistor-Capacitor)

- Effective protection for circuits highly sensitive to "high frequency" interference.
- Voltage limited to 3 Uc maximum and oscillating frequency limited to 400 Hz maximum.
- Slight increase in drop-out time (1.2 to 2 times the normal time).

For Mounting On:	Operational Voltage	Catalog Number
CAD (Vac)	24 to 48 Vac	LAD4RCE
	110 to 240 Vac	LAD4RCU

### Varistors (Peak Limiting)

- Protection provided by limiting the transient voltage value to 2 Uc maximum.
- Maximum reduction of transient voltage peaks.
- Slight increase in drop-out time (1.1 to 1.5 times the normal time).

CAD (Vac)	Operational Voltage	Catalog Number
CAD (Vac)	24 to 48 Vac	LAD4VE
	50 to 127 Vac	LAD4VG
	110 to 250 Vac	LAD4VU

### Bidirectional Peak Limiting Diode

- Protection provided by limiting the transient voltage value to 2 Uc maximum.
- Maximum reduction of transient voltage peaks.

CAD (Vac)	Operational Voltage	Catalog Number
CAD (Vac)	24 Vac	LAD4TB
	72 Vac	LAD4TS

Table 23.92: Coil Voltage Codes

Volts (Vac/Vdc)	24	32/36	42/48	60/72	100	110/127	220/240
Code	B	C	E	EN	K	F	M

Table 23.93: Dimensions (See Figures at Left)

	CAD (Vac Coil)	in. (mm)			CAD (Vdc Coil or Low Consumption Vdc Coil)	in. (mm)	
		32	323			32	323
b		3.03 (77)	3.90 (99)	b		3.03 (77)	3.90 (99)
c	Without cover or add-on blocks	3.31 (84)	3.31 (84)	c	Without cover or add-on blocks	3.66 (93)	3.66 (93)
	With cover, without add-on blocks	3.39 (86)	3.39 (86)		With cover, without add-on blocks	3.74 (95)	3.74 (95)
c1	with LADN or C (2 or 4 contacts)	4.61 (117)	4.61 (117)	c1	with LADN or C (2 or 4 contacts)	4.96 (126)	4.96 (126)
c2	with LA6DK10	5.08 (129)	5.08 (129)	c2	with LA6DK10	5.43 (138)	5.43 (138)
c3	with LADT, R, S	5.39 (137)	5.39 (137)	c3	with LADT, R, S	5.75 (146)	5.75 (146)
	with LADT, R, S and sealing cover	5.55 (141)	5.55 (141)		with LADT, R, S and sealing cover	5.91 (150)	5.91 (150)

### Dimensions (in./mm)

#### CAD (Vac Coil)

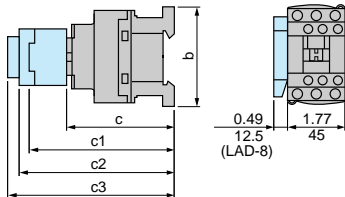

#### CAD (Vdc Coil or Low Consumption Vdc Coil)

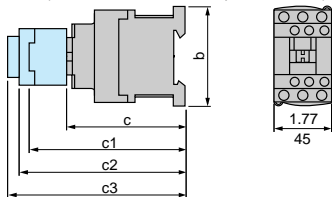

[6] With extended scale from 0.1 to 0.6 s.

[7] With switching time of 40 ms ± 15 ms between opening of the N.C. contact and closing of the N.O. contact.

[8] Power should not be simultaneously applied or maintained to the mechanical latching block and the CAD relay. The duration of the control signal to the mechanical latching block and the CAD relay should be greater than or equal to 100 ms.

[9] Complete the catalog number by adding the coil voltage code from Table 23.92. For example, LADK10B.

## TeSys™ D IEC Style Accessories

Table 23.94: Cabling Accessory

Description		Catalog Number
Mounting Adapter For adapting existing wiring to a new product	Without coil suppression	LAD4BB
	With coil suppression	24 to 48 Vac
		50 to 127 Vac
	110 to 250 Vac	

Table 23.95: Electronic Serial Timer Modules [10]

On-Delay Type		
Mounted using adaptor LAD4BB, to be ordered separately, see listing above.		
Operational Voltage	Time Delay	Catalog Number
24 to 250 Vac	0.1 to 2 s	LA4DT0U
	1.5 to 30 s	LA4DT2U
	25 to 500 s	LA4DT4U

Table 23.96: Auto-Man-Stop Control Modules

For local override operation tests with two-position "Auto-Man" switch and "O-I" switch	
Mounted using adaptor LAD4BB, to be ordered separately, see listing above.	
Operational Voltage	Catalog Number
24 to 100 Vac	LA4DMK

Table 23.97: Accessories (ordered separately)

Description	For Mounting On:	Must be Ordered in Multiples of:	Catalog Number
<b>For Marking</b>			
Sheet of 64 self-adhesive blank labels 8 x 33	CAD, LAD (4 contacts), LA6DK	10	LAD21
Sheet of 112 self-adhesive blank labels 8 x 12	LAD (2 contacts), LADT	10	LAD22
<b>For Protection</b>			
Lockout cover	LADT, LADR	1	LA9D901
Relay cover preventing access to the moving contact carrier	CAD	1	LAD9ET1

Table 23.98: Application Data

Type	CAD (Vac)	CAD (Vdc)	CAD (Vdc) Low Consumption
Rated Insulation Voltage (Ui)	Conforming to IEC 60947-1-1 Overvoltage category III and degree of pollution 3	690 V	690 V
	Conforming to UL, CSA	600 V	600 V
Rated Impulse Withstand Voltage (Uimp)	Conforming to IEC 60947-1-1	6 kV	6 kV
Separation of Electrical Circuits	To IEC 536 and VDE 0106	Reinforced insulation up to 400 V	
Conforming to Standards	IEC 60947-1-1, N-F C 63-140, VDE 0660, BS 4794, EN 60947-5-15		
Approvals	UL: File: E164353 CSA: File: LR43364 CE	CCN: NKCR Class: 3211 03	
Protective Treatment	Conforming to IEC 60068	"TH" (Tropical Finish). See page 23 of Catalog 8501CT0101 for details.	
Degree of Protection	Conforming to VDE 0106	Front face protected against direct finger contact IP 2X	Protection against direct finger contact

[10] For 24 V operation, the relay must be fitted with a 21 V coil (code Z7).



CA2KN22



CA2KN403



CA4KN405



CA3KN407

**TeSys™ K IEC Style Control Relays**

- Mounting on 35 mm DIN 3 track or 4 screw direct mounting.
- Screws in open “ready-to-tighten” position
- NEMA A600, Q600
- IEC AC15, DC13

**Table 23.99: Control Relays**

Control Circuit		Type of Termination	Contact Configuration		Catalog Number [11]	
Supply	Consumption		N.O.	N.C.		
AC	4.5 VA	Screw clamp	4	0	CA2KN40 **	
			3	1	CA2KN31 **	
			2	2	CA2KN22 **	
			Spring Termination	4	0	CA2KN403 **
				3	1	CA2KN313 **
				2	2	CA2KN223 **
		Faston 1 x 6.35 or 2 x 2.8	4	0	CA2KN407 **	
			3	1	CA2KN317 **	
			2	2	CA2KN227 **	
		Solder pins for printed circuit board	4	0	CA2KN405 **	
			3	1	CA2KN315 **	
			2	2	CA2KN225 **	
DC	3 W	Screw clamp	4	0	CA3KN40 **	
			3	1	CA3KN31 **	
			2	2	CA3KN22 **	
		Spring Termination	4	0	CA3KN403 **	
			3	1	CA3KN313 **	
			2	2	CA3KN223 **	
		Faston 1 x 6.35 or 2 x 2.8	4	0	CA3KN407 **	
			3	1	CA3KN317 **	
			2	2	CA3KN227 **	
		Solder pins for printed circuit board	4	0	CA3KN405 **	
			3	1	CA3KN315 **	
			2	2	CA3KN225 **	

**Table 23.100: Low Consumption Control Relays**

Compatible with programmable controller outputs.

- LED indicator incorporated.
- Wide range coil (70 to 130% Uc), suppressor fitted as standard.
- Mounting on 35 mm DIN 3 track or 4 screw direct mounting.
- Screws in open “ready-to-tighten” position.

Control Circuit		Type of Termination	Contact Configuration		Catalog Number [12]
Supply	Consumption		N.O.	N.C.	
DC	1.8 W	Screw clamp	4	0	CA4KN40 ***
			3	1	CA4KN31 ***
			2	2	CA4KN22 ***
		Spring Termination	4	0	CA4KN403 ***
			3	1	CA4KN313 ***
			2	2	CA4KN223 ***
		Faston 1 x 6.35 or 2 x 2.8	4	0	CA4KN407 ***
			3	1	CA4KN317 ***
			2	2	CA4KN227 ***
		Solder pins for printed circuit board	4	0	CA4KN405 ***
			3	1	CA4KN315 ***
			2	2	CA4KN225 ***

[11] Complete the catalog number by adding the proper voltage code from Table 23.101, Table 23.102, Table 23.103, or Table 23.104. For example, CA2KN40G7.

[12] Complete the catalog number by adding the proper voltage code from Table 23.105. For example, CA4KN40BW3.

**Table 23.101: Coil Voltage Codes for CA2K Control Relays (0.8–1.15 Uc) (0.85–1.10 Uc)—12 to 220/230 Vac 50/60 Hz**

Voltage	12 Vac	24 Vac	36 Vac	42 Vac	48 Vac	110 Vac	120 Vac	127 Vac	208 Vac	220/230 Vac
Code	J7	B7	C7	D7	E7	F7	G7	FC7	L7	M7

**NOTE:** Up to and including 240 V, coil with integral suppression device available: add 2 to the code required. Example: **J72**.

**Table 23.102: Coil Voltage Codes for CA2K Control Relays (0.8–1.15 Uc) (0.85–1.10 Uc)—230 to 660/690 Vac 50/60 Hz**

Voltage	230 Vac	230/240 Vac	380/400 Vac	400 Vac	400/415 Vac	440 Vac	480 Vac	500 Vac	660/690 Vac
Code	P7	U7	Q7	V7	N7	R7	T7	S7	Y7

**NOTE:** Up to and including 240 V, coil with integral suppression device available: add 2 to the code required. Example: **J72**.

**Table 23.103: Coil Voltage Codes for CA3K Control Relays (0.8–1.15 Uc)—12 to 72 Vdc**

Voltage	12 Vdc	20 Vdc	24 Vdc	36 Vdc	48 Vdc	60 Vdc	72 Vdc
Code	JD	ZD	BD	CD	ED	ND	SD

**NOTE:** Coil with integral suppression device available: add 3 to the code required. Example: **JD3**.

**Table 23.104: Coil Voltage Codes for CA3K Control Relays (0.8–1.15 Uc)—100 to 250 Vdc**

Voltage	100 Vdc	110 Vdc	125 Vdc	200 Vdc	220 Vdc	230 Vdc	240 Vdc	250 Vdc
Code	KD	FD	GD	LD	MD	MPD	MUD	UD

**NOTE:** Coil with integral suppression device available: add 3 to the code required. Example: **JD3**.

**Table 23.105: Coil Voltage Codes for CA4K, Low Consumption Control Relays (Wide Range Coil: 0.7–1.3 Uc)**

Voltage	12 Vdc	24 Vdc	48 Vdc	72 Vdc
Code	JW3	BW3	EW3	SW3

**Approvals for TeSys K IEC Style Control Relays**



File: E164353  
CCN: NKCR



File: LR43364  
Class: 3211 03



23

RELAYS AND TIMERS

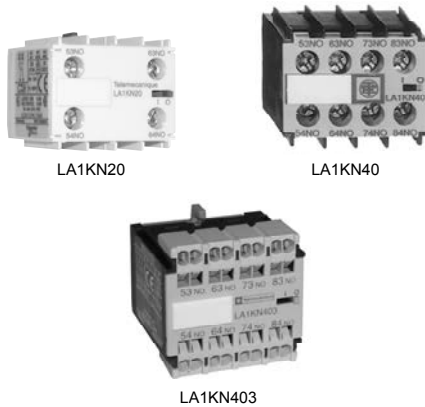

Approximate Dimensions for LA2KT Electronic Time Delay Contact Blocks (in./mm)

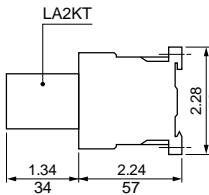

Approximate Dimensions for CA2, CA3, CA4K Control Relays (in./mm) On Panel

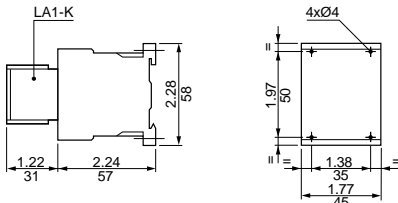

On Printed Circuit Board

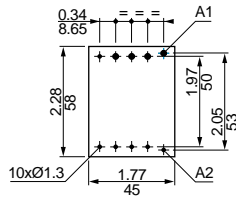

TeSys™ K IEC Style Contact Blocks and Accessories

Table 23.106: Instantaneous Auxiliary Contact Blocks [13][14]

Type of Connection	Clip-on Front Mounting, 1 Block Per Control Relay		Catalog Number
	Contact Configuration		
	N.O.	N.C.	
Screw Clamp	2	0	LA1KN20
	0	2	LA1KN02
	1	1	LA1KN11
	4	0	LA1KN40[15]
	3	1	LA1KN31[15]
	2	2	LA1KN22[15]
	1	3	LA1KN13[15]
	0	4	LA1KN04[15]
Spring Termination	2	0	LA1KN203
	1	1	LA1KN113
	0	2	LA1KN023
	4	0	LA1KN403[15]
	3	1	LA1KN313[15]
	2	2	LA1KN223[15]
	1	3	LA1KN133[15]
	0	4	LA1KN043[15]
Faston 1 x 6.35 or 2 x 2.8	2	0	LA1KN207
	0	2	LA1KN027
	1	1	LA1KN117
	4	0	LA1KN407[15]
	3	1	LA1KN317[15]
	2	2	LA1KN227[15]
	1	3	LA1KN137[15]
	0	4	LA1KN047[15]

Table 23.107: Clip-On Front Mounting, 1 Block per Control Relay

Voltage	Type	Timing Range (s)	Composition C.O.	Catalog No.
AC or DC: 24 to 48	On-delay	1 to 30 s	1	LA2KT2E
AC: 110 to 240	On-delay	1 to 30 s	1	LA2KT2U

Table 23.108: Electronic Time Delay Contact Blocks

Relay output, with common point changeover contact	240 Vac/Vdc, 2 A maximum
Control voltage	0.85–1.1 Uc
Maximum switching capacity	250 VA or 150 W
Operating temperature	–10 to +60°C (+14° F to 140° F)
Reset time	1.5 s during the time delay period, 0.5 s after the time delay.

NOTE: For other electronic timers, see Type JCK60 and JCK70 Timers, page 23-110.

Table 23.109: Accessories (supplied separately)

Description	Sold in lots of	Catalog No.
Marker holder [16]	100	LA9D90
Clip-on markers [16]	25	AB1R* [16]
		AB1G* [16]
Suppressor modules with locating device. No tools required for connection.	5	LA4KE1B [17]
		LA4KE1E [17]
		LA4KE1FC [17]
		LA4KE1UG [17]
		LA4KC1B [18]
		LA4KA1U [19]

Table 23.110: Environment

Conforming to Standards		IEC 947, NF C 63-140, VDE 0660, BS 5424, CE
Approvals		UL, CSA, DEMKO, NEMKO, SEMKO, FI
Protective treatment	Conforming to IEC 68 (DIN 50016)	"TC" (Climateproof)
Degree of protection	Conforming to VDE 0106	Protection against direct finger contact
Ambient air temperature	Storage	–58 to 176 °F (–50 to 80°C)
	Operation	–13 to 122 °F (–25 to 50°C)
Max. operating altitude	Without derating	6562 ft (2000 m)

[13] Clip-on front mounting, 1 block per control relay.  
 [14] Auxiliary contact module not suitable for safety circuits.  
 [15] Not to be used on CA4KN relays.  
 [16] See "Clip-in Marker Strips" in Catalog 8501CT0101 for information on completing the catalog number.  
 [17] Protection by the limitation of the transient voltage to 2 Uc maximum. Maximum reduction of the transient voltage peaks. Slight time delay on drop-out (1.1 to 1.5 times normal).  
 [18] No overvoltage or oscillation frequency. Polarized component. Slight time delay on drop-out (1.1 to 1.5 times normal).  
 [19] Protection by limitation of the transient voltage to 3 Uc max. and limitation of the oscillation frequency. Slight time delay on drop-out (1.2 times to twice normal).



**TeSys™ SK IEC Style Control Relays**

- Miniature size saves space.
- Up to 4 poles.
- Mounts on 35 mm DIN 3 track.



CA2SK11G7



LA1SK11



CA2SKE20

**Table 23.111: IEC Style Industrial Control Relays**

Control Circuit Supply	Consumption	Type of Termination	Contact Configuration		Catalog Number [20]
			N.O.	N.C.	
AC	4.2 VA	Screw clamp	1	1	CA2SK11 ••
			2	0	CA2SK20 ••
DC	2.2 W		1	1	CA3SK11 ••
			2	0	CA3SK20 ••

**Table 23.112: Contact Adder Decks (for CA2SK20 only)**

Type of Termination	Contact Configuration		Catalog Number
	N.O.	N.C.	
Screw clamp	2	0	LA1SK20
	1	1	LA1SK11
	0	2	LA1SK02

**Transient Suppressor Module** dampens the voltage spike that may occur when the relay coil is de-energized. The spike may adversely affect solid state equipment near the relay. The transient suppressor module snaps into a cavity located in the side of the relay. These modules can be used with CA2SK and CA3SK relays.

**Table 23.113: Transient Suppressor Module**

Control Circuit Voltage	Catalog Number
24–48 Vac 50/60 Hz, 24–48 Vdc	LA4SKEIE
110–250 Vac 50/60 Hz, 110–250 Vdc	LA4SKEIU

**Table 23.114: Coil Voltage Codes for Control Relays**

Voltage	12	24	36	48	72	110	120	220	230	240	277	380	400	480
50/60 Hz	—	B7 [21]	—	E7 [21]	—	F7	G7 [21]	M7 [21]	P7	U7 [21]	UE7	Q7	V7	T7 [21]
DC	JD	BD	CD	ED	SD	—	—	—	—	—	—	—	—	—

**IEC Style Alternating Relays** are used to alternate the use of 2 motor circuits. When the coil is energized the first time, one contact closes and will open when the coil is de-energized. When the coil is energized again, the other contact will close and will open when the coil is de-energized. The contacts from these alternators are to be used in the control circuit of the starters that are controlling pump or compressor motors.

**Table 23.115: Alternating Relays**

Coil Voltage (Voltage-Hz)	Type
24–50/60	CA2SKE20 •• [22]

**Table 23.116: Contact Ratings for CA2SK, CA3SK, and CA2SKE20 Relays**

V	AC					Continuous Amperes	DC	
	NEMA Rating	Inductive 35% PF		Break VA	Resistive 75% PF		V	Continuous Amperes
		Make	VA					
120	A600	60	7200	6	10	10	24	3
240		30		3			60	2
480		15		1.5			110	0.8
600		12		1.2			240	0.2

**Approximate Dimensions for CA2SKE Relay**

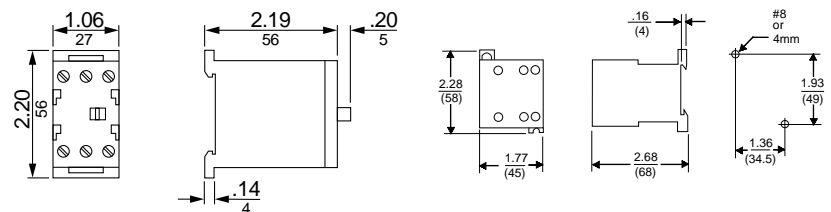

**Approvals for TeSys SK IEC Style Relays**

[20] Use the appropriate voltage code from Table 23.114 to complete the catalog number. For example, CA2SK11G7.  
 [21] Alternating relays CA2SKE available in these voltages only. No other voltages are available.  
 [22] Use the appropriate voltage code from Table 23.114 to complete the catalog number (for example, CA2SK11G7). Only available with voltages indicated in this table.



File: E164353  
CCN: NKCR



File: LR43364  
Class: 3211 03



23

RELAYS AND TIMERS



8501XO40V02 AC Control Relay



8501XMO40V02 AC Master Relay

AC Control and Master Relays Dimensions

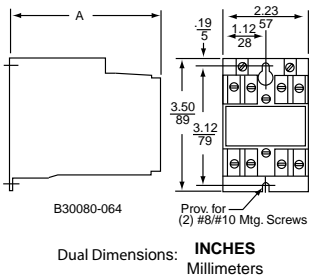

8501XO40XTE1V02 AC Timing Relay

### Square D™ NEMA Style AC Relays

Class 8501 Type X relays combine a rugged, heavy-duty design with modular construction for greater flexibility. They are ideal for applications where long life, high reliability, and ease of maintenance are important. The Type X family offers a complete line of relays and accessories for most control applications. The 8501X relay consists of a standard 4 pole base to which it is possible to add additional contacts, timer, and latch functionality. Instantaneous and Master contacts are converted from N.O. to N.C. by flipping the contact cartridge within the base. The 8501X relay can either be built from individual part numbers or ordered pre-assembled.

#### AC Control Relays

- Straight-through wiring
- Plug-in contact cartridges for easy contact conversion and replacement
- Contact conversion without removing terminal screws or wires
- Self-lifting pressure wire connectors
- Replaceable coil

Table 23.117: AC Control Relays (lots of 1)

No. of N.O. 10 A Convertible Instantaneous Contacts <sup>[1]</sup>	Type <sup>[1][2]</sup>
0	XO00
2	XO20
3	XO30
4	XO40
6	XO60
8	XO80
10	XO1000
12	XO1200

#### AC Master Relays

- 20 ampere contact rating due to use of master contact cartridges.<sup>[3]</sup>
- Provisions for standard cartridges to be used in contact cavities not occupied by master cartridges in 2-8 pole AC relay.

Table 23.118: AC Master Relays

No. of N.O. 20 A Convertible Contacts	Type <sup>[2][4]</sup>
2	XMO20
4	XMO40
6	XMO60

Table 23.119: Dimension A (See Figure at Left) and Weights

No. of Poles	Dim. A		Shipping Weight, lb
	in.	mm	
0-4	3.95	100	2.0
6-8	5.16	131	2.3
10-12	6.36	162	2.7

#### AC Timing Relays

- Easily convertible On or Off Delay
- Two adjustable timing ranges
- Repeat accuracy well above ±10%
- Convertible 1 N.O. and 1 N.C. timed contacts
- Large knob for easy adjustment of time delay
- Off Delay mode times out even after loss of power

Table 23.120: AC Timing Relays (lots of 1)

Timing Mode	No. of N.O. 10 A Convertible Instantaneous Contacts	Timed Convertible Contacts		Timing Relay	
		N.O.	N.C.	0.2-60 s	5-180 s
				Type <sup>[2]</sup>	Type <sup>[2]</sup>
On Delay	0	1	1	XO00XTE1	XO00XTE2
	2	1	1	XO20XTE1	XO20XTE2
	4	1	1	XO40XTE1	XO40XTE2
Off Delay	0	1	1	XO00XTD1	XO00XTD2
	2	1	1	XO20XTD1	XO20XTD2
	4	1	1	XO40XTD1	XO40XTD2

[1] A maximum of 8 N.C. contacts is allowed on 9-12 pole relays.

[2] Voltage code must be specified to order these products. Refer to Table 23.124 and insert the code as shown in Table 23.125.

[3] Maximum of six 8501 Type XC4 master cartridges may be used on only 7 and 8 pole AC devices.

[4] Attachments not permitted on this relay.



8501XO40XLV02 Latching Relay

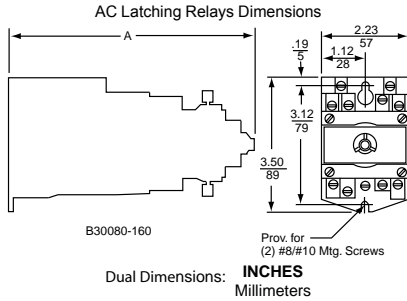

**AC Latching Relays**

- Mechanical latch holds all contacts switched even after removal of power from replaceable latching coil.
- Provides sequence memory in the event of power loss. Ideal for press control, process control, and punch presses.
- Replaceable unlatch coil to switch contacts back to original state.

**Table 23.121: AC Latching Relays (lots of 1)**

N.O. 10 A Convertible Instantaneous Contacts	Latching Relay
	Type [5]
2	XO20XL
3	XO30XL
4	XO40XL
6	XO60XL
8	XO80XL

**Table 23.122: Dimension A (See Figure at Left) and Weights**

No. of Poles	Dim. A		Shipping Weight, lb
	in.	mm	
2-4	6.54	166	2.8
6-8	7.74	197	3.1

- For replacement coils, see Table 23.139.

**Table 23.123: AC Contact Ratings**

Type of Cartridge	V	NEMA Rating	Inductive 35% Power Factor				Continuous Amperes	Resistive 75% Power Factor
			Make		Break			
			A	VA	A	VA		
Standard or Overlapping	120	A600	60	7200	6	720	10	
	240		30		3			
	480		15		1.5			
	600		12		1.2			
Master [6]	—	A600	Same as standard cartridge above except substitute 20 A for the continuous ampere rating					
Logic Reed	—	—	150 Vac, 150 mA, 8 W Maximum					

- For DC ratings, see Table 23.129.

**Table 23.124: Voltage Codes**

AC Voltages - Hz	Code
12-60	V11
24-60	V01
24-50	V12
48-60	V18
48-50	V16
120-60/110-50	V02
208-60	V08
240-60/220-50	V03
277-60	V04
480-60/440-50	V06
600-60/550-50	V07

**Table 23.125: How to Order**

To Order Specify:	Catalog Number		
• Class Number	Class	Type	Voltage Code
• Type Number	8501	XO40	V02
• Voltage Code			

**Approvals for Square D NEMA Style Relays**



File: E78403  
CCN: NKCR



File: 060905  
Class: 3211 03



IEC 60947-1

[5] Voltage code must be specified to order these products. Refer to Table 23.124 and insert the code as shown in Table 23.125.  
[6] Maximum of six 8501 Type XC4 master cartridges may be used on only 7 and 8 pole AC devices.



8501XDO40V53 Control Relay

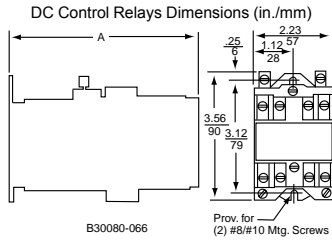

8501XDO40XTE2V53 Timing Relay

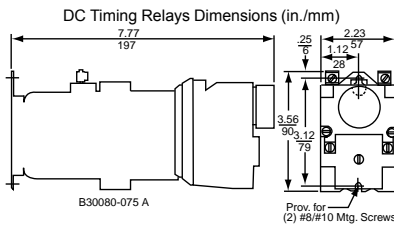

## Square D™ NEMA Style DC Relays

### DC Control Relays

- Replaceable, highly reliable pure DC power plant: no economizing resistors, overlapping contacts or dual-wound coil.
- Uses the same Type XB adder decks and attachments as the AC version.
- Offers all the features of the AC relay.
- Available in up to 8 poles.
- All contact poles are usable since no overlapping contacts are needed.

Table 23.126: DC Control Relays

Normally Open 5 A Convertible Instantaneous Contacts	Control Relay
	Type [7]
0	XDO00
2	XDO20
4	XDO40
6	XDO60
8	XDO80

Table 23.127: Dimension A (See Figure at Left) and Weights

No. of Poles	Dim. A		Shipping Weight
	in.	mm	
0-4	5.17	131	3.1
6-8	6.37	162	3.4
10-12	7.60	193	3.8

### DC Timing Relays

- Easily convertible On Delay or Off Delay.
- Two adjustable timing ranges.
- Repeat accuracy well above ±10%.
- Convertible 1 N.O. and 1 N.C. timed contacts.
- Large knob for easy adjustment of time delay.
- Off Delay mode times out even after loss of power.

Table 23.128: DC Timing Relays

Timing Mode	Normally Open 5 A Convertible Instantaneous Contacts	Timed Convertible Contacts		Timing Relay [7]	
		N.O.	N.C.	0.2-60 s	5-180 s
				Type	Type
On Delay	0	1	1	XDO00XTE1	XDO00XTE2
	2	1	1	XDO20XTE1	XDO20XTE2
	4	1	1	XDO40XTE1	XDO40XTE2
Off Delay	0	1	1	XDO00XTD1	XDO00XTD2
	2	1	1	XDO20XTD1	XDO20XTD2
	4	1	1	XDO40XTD1	XDO40XTD2

Table 23.129: DC Contact Ratings

Type of Cartridge	DC Ratings					
	Volts	Inductive			Resistive	
		NEMA Rating	Make and Break Amperes 138 VA Max.	Continuous Amperes	Make and Break Amperes	Continuous Amperes
Standard	125 250	P600	1.1 0.55	5 5	4 0.8	5 5
Overlapping	125	P150	1.1	5	4	5
Logic Reed	—	—	30 Vdc, 60 mA	—	—	—

- For AC ratings, see Table 23.123.

**NOTE:** Do not use any 8501 Type XC4 Master Cartridges on any DC-operated device.

[7] Voltage code must be specified to order these products. Refer to Table 23.133 and insert the appropriate code as shown in Table 23.134.



8501XDO40XDLV53 Latching Relay

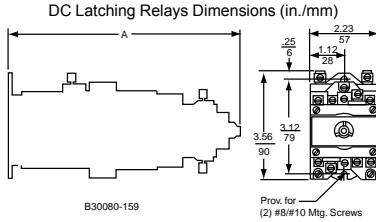

B30080-159



8501XUDO40V53 Utility Relay

**DC Latching Relays**

- Mechanical latch holds all contacts switched even after removal of power from replaceable latching coil.
- Provides sequence memory in the event of power loss.
- Ideal for sequencing applications such as press control, process control and punch presses.
- Replaceable unlatch coil to switch contacts back to original state.

**Table 23.130: DC Latching Relays**

Normally Open 5 A Convertible Instantaneous Contacts	Latching Relay [8]	
	Type	
2	XDO20XDL	
4	XDO40XDL	
6	XDO60XDL	
8	XDO80XDL	

**NOTE:** Unlatch coil is rated for intermittent duty and should be connected through a N.O. contact of the relay if the input signal is maintained. Order one more N.O. contact than the application requires to use as a coil clearing contact.

**Table 23.131: Dimension A (See Figure at Left) and Weights**

No. of Poles	Dim. A		Shipping Weight, lb.
	in.	mm	
2-4	7.76	197	3.9
6-8	8.98	228	4.2

**DC Utility Relays**

Ideal for utility plant applications where reliable performance and a pure DC power plant is required. In addition to the Type XDO relay features, the Type XUDO provides:

- Up to 12 poles N.O. or N.C.
- Nominal 125 Vdc coil, capable of handling 140 Vdc continuously and picking up at 105 Vdc after having been operated at 140 Vdc continuously. Other voltages with comparable operating characteristics are available.
- Enclosed device capable of operating in 145°F ambient.

**Table 23.132: DC Utility Relays**

Number of 5 A Convertible Contacts		Open Type [8]
N.O.	N.C.	
4	0	XUDO40
0	4	XUDO04
8	0	XUDO80
0	8	XUDO08
12	0	XUDO1200
0	12	XUDO0012

**Table 23.133: Voltage Codes—8501 XUDO and XDO Relays**

DC Voltages for 8501 XUDO Relays ONLY	Code	DC Voltages for 8501 XDO Relays	Code
6	V50	6	V50
12	V51	12	V51
24	V53	24	V53
48	V56	32	V54
125	V63	48	V56
250	V67	72	V58
—	—	90	V59
—	—	115/125	V62
—	—	230/250	V66

**Table 23.134: How to Order**

To Order Specify:	Catalog Number		
• Class Number	Class	Type	Voltage Code
• Type Number	8501	XDO40	V53
• Voltage Code			

- For replacement coils, see [Table 23.138](#).
- For UL and CSA approvals, see [Square D NEMA Style AC Relays](#).

[8] Voltage code must be specified to order these products. Refer to [Table 23.133](#) and insert the appropriate code as shown in [Table 23.134](#).

### Attachments and Accessories for Square D™ NEMA Style Relays

Table 23.135: Type X™ Relays

23

RELAYS AND TIMERS

	Description	Type
	<b>Mechanical Latch Attachment</b> —Mounts on any 2 through 8-pole relay (except XMO master relay). The Type XL and XDL latch attachments are identical in size and mounting provisions. The Type XLAC latch attachment has a continuous-duty-rated coil which is replaceable. <b>The Type XDLDC latch attachment has an intermittent-rated coil (replaceable) and should be connected through a N.O. contact of the basic relay if the input signal is maintained to the unlatch coil.</b> AC Latch Attachment DC Latch Attachment	XL [9] XDL[9]
	<b>Pneumatic Timer Attachment</b> —Mounts only on any 0 through 4-pole AC or DC relays (except XMO master relay). It provides 1 N.O. and 1 N.C. convertible timed contacts, which are the same Type XC1 cartridges used on the basic relay. Two timing ranges are available, and conversion from On Delay to Off Delay or vice versa is easy. <b>Off Delay</b> 0.2–60 seconds 5–180 seconds <b>On Delay</b> 0.2–60 seconds 5–180 seconds	XTD1 XTD2 XTE1 XTE2
	<b>Timer Lockout Cover</b> —Fits over the time delay adjustment knob of any Type XT timing attachment. The Lockout Cover is designed to protect the time setting against accidental adjustment. It mounts directly to the timing attachment with two included screws.	XJ1
	<b>Adder Decks</b> —Adder decks are used to expand the number of poles on a relay. The basic 4-pole relay can be easily converted to an 8-pole or 12-pole relay by installing one or two adder decks. The Class 8501 Type XB20 comes with 2 convertible contact cartridges and will accept 2 additional convertible contact cartridges. The Class 8501 Type XB40 comes with 4 convertible contact cartridges. The same Type XB adder deck is used for both the middle and upper decks of the AC or DC relay.	
	With 2 N.O. contact cartridges	XB20
	With 4 N.O. contact cartridges	XB40
	<b>Contact Cartridges</b> —The Type X relay offers 4 Types of contact cartridges. All are color-coded for visual identification of each Type.	
	<b>Standard Cartridge</b> —The standard cartridge, used for most applications, has a black case.	XC1
	<b>Overlapping Cartridge</b> —Same NEMA Type A600 AC rating as standard cartridge and a NEMA Type P150 DC rating. When it is used in the N.O. mode it will close early and when used in the N.C. mode it will open late. If two or more are used together, the N.O. contacts will close before the N.C. contacts open as the relay picks up. Overlap also occurs during dropout. Overlapping cartridge has a red case. May be ordered factory installed: • Substitute 1 N.O. and 1 N.C. overlapping cartridges for 2 standard cartridges. • Substitute 2 N.O. and 2 N.C. overlapping cartridges for 4 standard cartridges. • Substitute 3 N.O. and 3 N.C. overlapping cartridges for 6 standard cartridges. • Substitute 4 N.O. and 4 N.C. overlapping cartridges for 8 standard cartridges.	XC2  <b>Form</b> Y1591 Y1592 Y1593 Y1594
	<b>Master Cartridge</b> —Features the same contact ratings as the Type XC1 standard cartridge except it has a 20 ampere continuous current rating instead of 10 amperes. It can be used in circuits where a master relay is required. Master cartridge has a blue case. <b>Maximum of 6 master cartridges may be used on any 7 and 8-pole AC relays. Do not use any master cartridges on 9-12-pole AC or any DC-operated devices. Note: If master cartridges are added to a standard relay, attachments (latch mechanism, timers, etc.) cannot be used.</b>	XC4
	<b>Mounting Track</b> —The mounting track has pre-punched mounting holes to simplify mounting the track on the control panel. The relay mounting screws are factory installed on the track so that the relays can be hung prior to tightening the screws. 9 in. long for 4 relays 18 in. long for 8 relays 27 in. long for 12 relays 36 in. long for 16 relays	XM4 XM8 XM12 XM16
	<b>Manual Test Tool</b> —Provides a means of manually switching the contacts of a basic relay or timing relay and holding all contacts in their switched state until the tool is removed. This simplifies the checking of control circuits without power on the coil or contacts.	XA1
	<b>Transient Suppressor</b> —Consists of an R-C circuit designed to suppress coil generated transients to approximately 200 percent of peak voltage. It is particularly useful when switching the Type X relay near solid state equipment. It is designed for use on coils up to 120 Vac.	XS1
	<b>NEMA 1 Enclosure</b> —Formed from sheet steel to provide strength and rigidity. Two conduit knockouts are located in both the top and bottom of the enclosure. The enclosure is furnished with self tapping screws for mounting the relay inside the enclosure. Accommodates a single 4 or 8-pole AC or DC relay, 12-pole AC relay, 4-pole AC latching relay, and 4-pole AC timing relay. <b>NOTE:</b> The 4-pole DC latching relay, 4-pole DC timing relay, 8-pole AC and DC latching relays and 12-pole utility auxiliary relay will not fit.	Class 9991 Type UE7

Table 23.136: Mechanical Latch Attachment Voltage Codes

AC Voltage	Code	DC Voltage	Code
24–60	V01	6	V50
24–50	V12	12	V51
120–60/110–50	V02	18	V99
208–60	V08	24	V53
240–60/220–50	V03	48	V56
277–60	V04	72	V58
480–60/440–50	V06	90	V59
600–60/550–50	V07	115/125	V62
		230/250	V66

Table 23.137: How to Order

To Order Specify:	Catalog Number	
<ul style="list-style-type: none"> <li>Class Number</li> <li>Type Number</li> <li>Voltage Code for mechanical latch attachment</li> <li>Form for factory installed overlapping contacts</li> </ul>	Class	Type
	8501	XTE1

[9] See Table 23.136.

**Table 23.138: DC Relay Coil Selection**

Equipment To Be Serviced		Coil Prefix, or Class and Type	Hz	Suffix (The complete coil number consists of prefix or the Class and Type, followed by suffix.)													Coil Burden Watts
Class	Type			6 V	12 V	18 V	24 V	32 V	48 V	64 V	72 V	90 V	110 V	115/125 V	220 V	230/250 V	
8501	XD	9998 XD	—	19	28	34	37	40	46	49	52	55	—	58	—	67	18
	XDL	9998 XDL	—	19	28	34B	37B	40B	46B	49B	52B	55B	—	58B	—	67B	50
	XUD	9998 XUD	—	19	28	—	37	—	46	—	—	—	—	58 [10]	—	67 [11]	16

**Table 23.139: AC Relay Coil Selection**

Equipment To Be Serviced		Coil Prefix, or Class and Type	Hz	Suffix (The complete coil number consists of prefix or the Class and Type, followed by suffix.)											Coil Volt-Amperes		
Class	Type			24 V	110-115 V	120 V	208 V	220 V	240 V	277 V	380 V	440 V	480 V	550 V	600 V	In-rush	Sealed
8501	XO, XMO	9998 X [12]	60	23	—	44	51	52	53	55	—	—	62	—	65	148	23
			50	24	44	—	52	53	—	—	—	62	—	65	—	143	25

[10] 125 Vdc only

[11] Not dual rated—250 Vdc only

[12] To order an unlatch coil, add the letter L to the type number and the letter B to the suffix number. Example: for a 120 V 60 Hz unlatch coil, order a Class 9998 Type XL44B.

### Zelio™ RE17, E22 and RENF22 Modular Timers

The Zelio RE17, RE22 and RENF22 modular timer range is comprised of both 8 A relay and 0.7 A solid state outputs. Thanks to its space saving 17.5 mm design, this relay is ideal for applications that require a lot of control in a small foot print. The RE17 series is designed to attach to a 35 mm DIN rail.

- Multifunction, dual function, or single function
- Multi-range (7 selectable ranges)
- Multivoltage
- Solid state or relay output options



RE17LAMW



RE17LMBM



RE17RLMU

Table 23.140: RE17 Series Timers

Supply Voltage	Timing Ranges	Output Type	Rated Current	Functions	Function Descriptions [1]	Catalog Number
24–240 Vac/ Vdc	0.1 s to 100 h	SPST Solid State	0.7 A	A	Power On delay	RE17LAMW
24–240 Vac	0.1 s to 100 h	SPST Solid State	0.7 A	H	Interval	RE17LHBM
				C	Off delay with control signal	RE17LCBM
				L, Li	Asymmetrical flasher	RE17LLBM
				A, At, B, C, H, Ht, D, Di, Ac, Bw	Multi-function	RE17LMBM
24 Vdc, 24–240 Vac	0.1 s to 100 h	SPDT Relay	8 A	B	Interval with control signal	RE17RBMU
				C	Off delay with control signal	RE17RCMU
				A, At	Power on delay	RE17RAMU
				H, Ht	Interval	RE17RHMU
				L, Li	Asymmetrical flasher	RE17RLMU
				A, At, B, C, H, Ht, D, Di, Ac, Bw	Multi-function	RE17RMMU
				Ad, Ah, N, O, P, Pt, T, Tt, W	Multi-function	RE17RMXMU
				A, At, B, C, H, Ht, D, Di	Multi-function	RE17RMEMU
12 Vdc	0.1 s to 100 h	SPDT Relay	8 A	L, Li	Asymmetrical flasher	RE17RLJU
				A, At, B, C, H, Ht, D, Di, Ac, Bw	Multi-function	RE17RMJU
12–240 Vac	0.1 s to 100 h	SPDT Relay	8 A	A, At, B, C, H, Ht, D, Di, Ac, Bw	Multi-function	RE17RMMW
12–240 Vac	0.1 s to 100 h	SPDT Relay	8 A	A, At, B, C, H, Ht, D, Di, Ac, Bw	Multi-function	RE17RMMWS

[1] For detailed function definitions, see Table 23.147.



**Table 23.141: RE22 Series Timer References**

Timing Ranges	Functions	No. of relay outputs	Voltages	Reference	Weight kg/lb
<b>Single function</b>					
10 selectable timing ranges 1 s, 3 s, 10 s, 30 s, 100 s, 300 s, 30 min, 300 min, 30 h, 300 h	Ac	2	24...240	RE22R2ACMR	0.105/ 0.231
	Qg	2	24...240	RE22R2QGMR	0.105/ 0.231
	Qt	2	24...240	RE22R2QTMR	0.105/ 0.231
7 selectable timing ranges 1 s, 3 s, 10 s, 30 s, 100 s, 300 s, 10 min	K	1	24...240	RE22R1KMR <sup>[2][3]</sup>	0.100/ 0.220
		2	24...240	RE22R2KMR <sup>[2][3]</sup>	0.100/ 0.220
7 selectable timing ranges 0.5 s, 1 s, 3 s, 10 s, 30 s, 100 s, 300 s	Qc	1	24/24...240	RE22R1QCMU	0.080/ 0.176
				RE22R2QEMR	0.090/ 0.198
Single range selection 30 s	Qe	2	24...240	RE22R2QEMR	0.090/ 0.198
		2	380...415	RE22R2QEMT	0.090/ 0.198
<b>Dual function</b>					
10 selectable timing ranges 1 s, 3 s, 10 s, 30 s, 100 s, 300 s, 30 min, 300 min, 30 h, 300 h	A, Aw	1	24...240	RE22R1AMR	0.100/ 0.220
		2	24...240	RE22R2AMR	0.105/ 0.231
	C, Ct	1	24...240	RE22R1CMR	0.100/ 0.220
		2	24...240	RE22R2CMR	0.105/ 0.231
	Ac, Act	1	24...240	RE22R1ACMR	0.100/ 0.220
		1	24...240	RE22R1AKMR	0.100/ 0.220
	D, Dw	1	24...240	RE22R1DMR	0.100/ 0.220
		2	24...240	RE22R2DMR	0.105/ 0.231
	H, Hw	1	24...240	RE22R1HMR	0.100/ 0.220
		2	24...240	RE22R2HMR	0.105/ 0.231
Wt, W	2	24...240	RE22R2MWMR	0.105/ 0.231	
7 selectable timing ranges 0.5 s, 1 s, 3 s, 10 s, 30 s, 100 s, 300 s	K, He	1	24...240	RE22R1MKMR <sup>[2][3]</sup>	0.100/ 0.220
				RE22R1MAMR	0.100/ 0.220
10 selectable timing ranges 1 s, 3 s, 10 s, 30 s, 100 s, 300 s, 30 min, 300 min, 30 h, 300 h	A, At, Aw, Ac, Act, C, Ct, D, Dt, Dw, Di, Dit, Diw, H, Ht, Hw, W, Wt	1	24...240	RE22R1MYMR	0.100/ 0.220
				2	24...240
	A, At, Aw, C, Ct, D, Dt, Dw, Di, Dit, Diw, H, Ht, Hw, Qg, Qgt, Qt, Qtt, W, Wt	1	24...240	RE22R1MLMR	0.100/ 0.220
				2	24...240
<b>Multifunction</b>					
7 selectable timing ranges 1 s, 10 s, 1 min, 10 min, 1 h, 10 h, 100 h	Q	1	24/24...240	RE22R1QMU	0.090/ 0.198
		1	230-380	RE22R1QM0	0.090/ 0.198
<b>Dual function</b>					
7 selectable timing ranges 1 s, 10 s, 1 min, 10 min, 1 h, 10 h, 100 h	A, At	2	24/24...240	RE22R2AMU	0.090/ 0.198
<b>Multifunction</b>					
7 selectable timing ranges 1 s, 10 s, 1 min, 10 min, 1 h, 10 h, 100 h	A, At, B, C, H, Ht, Di, D, Ac, Bw	2	24/24...240	RE22R2MMU	0.090/ 0.198
			12	RE22R2MJU	0.090/ 0.198
	Ad, Ah, N, O,P, Pt, Tl, Tt, W	2	12...240	RE22R2MMW	0.090/ 0.198
			24/24...240	RE22R2MXMU	0.090/ 0.198

**Approvals for RE17 Timers**



File: E173076  
CCN: NRNT, NRNT7



File: 248382  
Class: 3211-06



IEC 61812-1

RoHS Compliant

[2] The diagnostic button is not available for the K function related references (RE22R1KMR, RE22R2KMR, and RE22R1MKMR).  
[3] 1 or 2 relay outputs: 5 A - 250 V.



RE48ATM12MW



RE48AMH13MW



RUZC3M



RE48ASOC11AR



RE48ASOC8SOLD



RE48ASOC11SOLD



RE48ASETMOV



RE48AIPCOV

### Zelio™ RE48 Panel Mount Timers

The Zelio RE48 panel mount timer range is comprised of 5 A relay outputs. The unit can be mounted either on a panel or on a DIN rail with the optional octal socket. Thanks to the large selector knob, the user can quickly and easily see the current value selected and change it if needed.

- Time unit selector knob
- Multifunction, single function, or dual function
- 1.2 second to 300 hour timing range
- Wide input voltage range
- 5 A relay outputs
- Panel-mounted or plug-in
- LED indication

Table 23.142: RE48 Series Timers

Supply Voltage	Timing Ranges	Pin Configuration	Output Type	Rated Current	Functions	Function Descriptions [4]	Catalog Number
24–240 Vac/Vdc	1.2 s to 300 h	8–Pin Octal	DPDT Relay	5 A	A	Power On delay	RE48ATM12MW
					A1, A2, H1, H2	Delay On Energization, Pulse-on Energization	RE48AMH13MW
24–240 Vac/Vdc	1.2 s to 300 h	11–Pin Octal	DPDT Relay	5 A	L, Li	Asymmetrical flasher	RE48ACV12MW
					A, B, C, Di	Multi-function	RE48AML12MW

Table 23.143: Sockets (sold in lots of 10)

Description	Connection	Compatibility	Catalog Number
Mixed 8–Pin DIN Rail Mountable Socket	Box lug connector, DIN rail mount	RE48ATM12MW, RE48AMH13MW	RUZC2M
Mixed 11–Pin DIN Rail Mountable Socket		RE48ACV12MW, RE48AML12MW	RUZC3M
Mixed 11–Pin Mountable Socket	Box lug connector	RE48ACV12MW, RE48AML12MW	RE48ASOC11SOLD
Mixed 8–Pin Solder Connector	Solder connectors	RE48ATM12MW, RE48AMH13MW	RE48ASOC8SOLD
Mixed 11–Pin Solder Connector	Solder connectors	RE48ACV12MW, RE48AML12MW	RE48ASOC11SOLD

Table 23.144: Accessories (sold in lots of 10)

Description	Compatibility	Catalog Number
Setting protective cover	RE48 Series Timers	RE48ASETMOV
Protective cover IP64		RE48AIPCOV

### Approvals for RE48 Timers



File: E173076  
CCN: NRNT2, NRNT8



File: 248382  
Class: 3211 07



IEC 61812-1

RoHS Compliant

[4] For detailed function definitions, see Table 23.147.

### Zelio™ REXL Miniature Plug-In Timers

The Zelio REXL miniature plug-in timer range is comprised of DPDT and 4PDT single On-delay function timers. The unit is designed to be mounted in a socket in a panel. Thanks to the large selector knob, the user can quickly and easily see the current value selected and change it if needed. Features include:

- Miniature and plug-in (21 x 27 mm / 0.827 x 1.062 in.)
- Single function: function A = delay on energization
- Rated current at 5 A
- 7 timing ranges (0.1 s to 100 h)
- Multivoltage
- Excellent immunity to interference
- Power on and relay energized indication by 2 LEDs



REXL2TM



REXL4TM



RXZE2M114M



RXZE2S114M

Table 23.145: REXL Series Timers

Supply Voltage	Timing Ranges	Pin Configuration	Output Type	Rated Current	Functions	Function Descriptions [5]	Catalog Number
12 Vdc	0.1 s to 100 h	8-Pin Quick Connect (Blade)	DPDT Relay	5 A	A	Power On delay	REXL2TMJD
24 Vdc	0.1 s to 100 h	8-Pin Quick Connect (Blade)	DPDT Relay	5 A	A	Power On delay	REXL2TMBD
24 Vac	0.1 s to 100 h	8-Pin Quick Connect (Blade)	DPDT Relay	5 A	A	Power On delay	REXL2TMB7
120 Vac	0.1 s to 100 h	8-Pin Quick Connect (Blade)	DPDT Relay	5 A	A	Power On delay	REXL2TMF7
230 Vac	0.1 s to 100 h	8-Pin Quick Connect (Blade)	DPDT Relay	5 A	A	Power On delay	REXL2TMP7
12 Vdc	0.1 s to 100 h	14-Pin Quick Connect (Blade)	4PDT Relay	5 A	A	Power On delay	REXL4TMJD
24 Vdc [6]	0.1 s to 100 h	14-Pin Quick Connect (Blade)	4PDT Relay	5 A	A	Power On delay	REXL4TMBD
24 Vac [6]	0.1 s to 100 h	14-Pin Quick Connect (Blade)	4PDT Relay	5 A	A	Power On delay	REXL4TMB7
120 Vac	0.1 s to 100 h	14-Pin Quick Connect (Blade)	4PDT Relay	5 A	A	Power On delay	REXL4TMF7
230 Vac	0.1 s to 100 h	14-Pin Quick Connect (Blade)	4PDT Relay	5 A	A	Power On delay	REXL4TMP7

Table 23.146: Sockets (sold in lots of 10)

Contact Terminal Arrangement	Connection	For Use with Relays	Catalog Number
Mixed	Box lug connector	REXL2TM** REXL4TM**	RXZE2M114M
	Box lug connector	REXL2TM**	RXZES108M
Separate	Box lug connector	REXL4TM**	RXZE2S114M

### Approvals for REXL Timers



File: E173076  
CCN: NRNT2,  
NRNT8



File: 248382  
Class: 3211 07



IEC 61812-1

RoHS Compliant

Table 23.147: Timer Function Description

Function	Function Description [7]	Timer
A	Power on delay relay	RE17, RE48, REXL
A1, A2	Delay on energization	RE48
Ac	On-delay and off-delay relay with control signal	RE17
Ad	Pulse delayed relay with control signal	RE17
At	Power on delay relay (summation) with control signal	RE17
B	Interval relay with control signal	RE17, RE48
Bw	Double interval relay with control signal	RE17
C	Off-delay relay with control signal	RE17, RE48
D	Symmetrical flasher relay (starting pulse off)	RE17
Di	Symmetrical flasher relay (starting pulse on)	RE17, RE48
H	Interval relay	RE17
H1, H2	Pulse-on energization	RE48
Ht	Interval relay (summation) with control signal	RE17
L	Asymmetrical flasher relay (starting pulse off)	RE17, RE48
Li	Asymmetrical flasher relay (starting pulse on)	RE17, RE48
N	Retriggerable interval relay with control signal on	RE17
O	Retriggerable interval delayed relay with control signal on	RE17
P	Pulse delayed relay with fixed pulse length	RE17
Pt	Pulse delayed relay (summation and fixed pulse length) with control signal off	RE17
T	Bistable relay with control signal on	RE17
Tt	Retriggerable bistable relay with control signal on	RE17
W	Interval relay with control signal off	RE17

[5] For detailed function definitions, see Table 23.147.

[6] For 48 Vdc supply, additional resistor 560 ohms 2 W / 24 Vdc. For 48 Vac, additional resistor 390 ohms 4 W / 24 Vac.

[7] See catalog 9050CT0001 for timing diagrams and detailed descriptions.

820 Series Time Delay and Sensor Relays

820 Series—SPDT, 15 A; DPDT, 15 A



23

RELAYS AND TIMERS



821 Relay



822 Relay

Input Voltage	Functions Available	Timing Range	Contact Configuration	Rated Current	Standard Part Number
12–240 Vac/Vdc	A,B,C,D,E,F,G,H,I,J	10 ms to 10 days SPDT	SPDT	15 A	821TD10HUNI
			DPDT	15 A (2 pairs of contacts)	822TD10HUNI

820 Specifications

Part Number	821TD10HUNI	822TD10HUNI
<b>Input Characteristics</b>		
Input Voltage Range	12–240 Vac/Vdc	12–240 Vac/Vdc
Operating Voltage (% of Nominal)	85% of 12 V to 110% of 240 V	85% of 12 V to 110% of 240 V
Maximum Power Consumption	3 VA 1.7W	3 VA 1.7W
<b>Output Characteristics</b>		
Contact Configuration	SPDT	DPDT
Output Current Rating	15 A	15 A
Contact Material	Silver alloy	Silver alloy
Switching Capability	N/A	
Minimum Switching Requirement	15 A @ 240 Vac, 50/60 Hz, 24 Vdc 1/2 hp @ 120 Vac 1 hp @ 240 Vac Pilot duty B300	15 A @ 240 Vac, 50/60 Hz, 24 Vdc 1/2 hp @ 120 Vac 1 hp @ 240 Vac Pilot duty B300
<b>Timing Characteristics</b>		
Functions Available	Multifunction	Multifunction
Time Scales	8	8
Time Ranges	100 ms to 1 s 1 s to 10 s 0.1 min to 1 min 1 min to 10 min 0.1 hr to 1 hr 1 hr to 10 hr 0.1 day to 1 day 1 day to 10 days	100 ms to 1 s 1 s to 10 s 0.1 min to 1 min 1 min to 10 min 0.1 hr to 1 hr 1 hr to 10 hr 0.1 day to 1 day 1 day to 10 days
Tolerance	5% of mechanical setting	5% of mechanical setting
Repeatability at Constant Voltage and Temperature	0.2%	0.2%
Reset Time	150 ms maximum	150 ms maximum
Trigger Pulse Length	50 ms minimum	50 ms minimum

Dimensions, in. (mm)

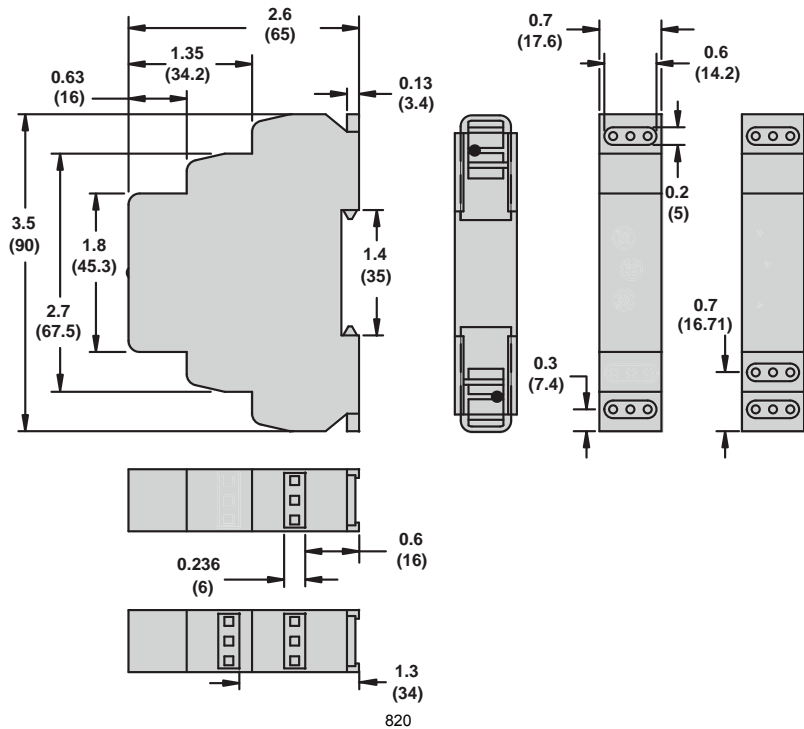

**Wiring Diagram**

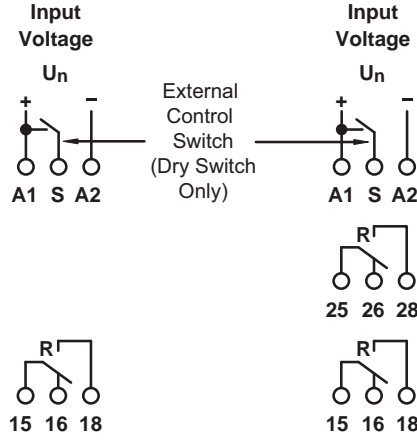

- 15—Common
- 16—Normally Closed
- 18—Normally Open
  
- 25—Common
- 26—Normally Closed
- 28—Normally Open

821TD10H-UNI

822TD10H-UNI

**TDR782 Series Time Delay and Sensor Relays**  
TDR782 Series—DPDT, 5 A; 4PDT, 3 A



TDR782 Relay

Input Voltage	Functions Available	Timing Range	Contact Configuration	Rated Current	Standard Part Number
<b>AC</b>					
24 Vac	A (On-Delay)	100 ms to 100 hr	4PDT	3 A	TDR782XDXA-24A
			DPDT	5 A	TDR782XBXA-24A
110 Vac	A (On-Delay)	100 ms to 100 hr	4PDT	3 A	TDR782XDXA-110A
			DPDT	5 A	TDR782XBXA-110A
230 Vac	A (On-Delay)	100 ms to 100 hr	4PDT	3 A	TDR782XDXA-230A
<b>DC</b>					
12 Vdc	A (On-Delay)	100 ms to 100 hr	4PDT	3 A	TDR782XDXA-12D
24 Vdc	A (On-Delay)	100 ms to 100 hr	4PDT	3 A	TDR782XDXA-24D
			DPDT	5 A	TDR782XBXA-24D

**TDR782 Specifications**

Part Number	TDR782XDXA	TDR782XBXA
<b>Input Characteristics</b>		
Input Voltage Range	24, 110/120, 230/240 Vac 12, 24 Vdc	24, 110/120, 230/240 Vac 12, 24 Vdc
Operating Voltage	85–115% of nominal 90–110% of nominal	85–115% of nominal 90–110% of nominal
Maximum Power Consumption	1.7 VA @ 24 Vac 2.6 VA @ 120 Vac 3 VA @ 230 Vac 1.5 W @ 12 Vdc 1.2 W @ 24 Vdc	1.7 VA @ 24 Vac 2.6 VA @ 120 Vac 3 VA @ 230 Vac 1.5 W @ 12 Vdc 1.2 W @ 24 Vdc
<b>Output Characteristics</b>		
Contact Configuration	DPDT	4PDT
Output Current Rating	5 A	3 A
Contact Material	Silver alloy	Silver alloy
Maximum Inrush Current	10 A @ < 100 ms	10 A @ < 100 ms
Minimum Switching Requirement	100 mA at 5 Vac/Vdc	100 mA at 5 Vac/Vdc
<b>Timing Characteristics</b>		
Functions Available	Multifunction	Multifunction
Time Scales	7	7
Time Ranges	100 ms to 1 s 1 s to 10 s 0.1 min to 1 min 1 min to 10 min 0.1 hr to 1 hr 1 hr to 10 hr 10 hr to 100 hr	100 ms to 1 s 1 s to 10 s 0.1 min to 1 min 1 min to 10 min 0.1 hr to 1 hr 1 hr to 10 hr 10 hr to 100 hr
Tolerance	5% of mechanical setting	5% of mechanical setting
Repeatability at Constant Voltage and Temperature	0.5%	0.5%
Reset Time	50 ms maximum	50 ms maximum
Temperature Drift	0.05% /°C	0.05% /°C

Dimensions, in. (mm)

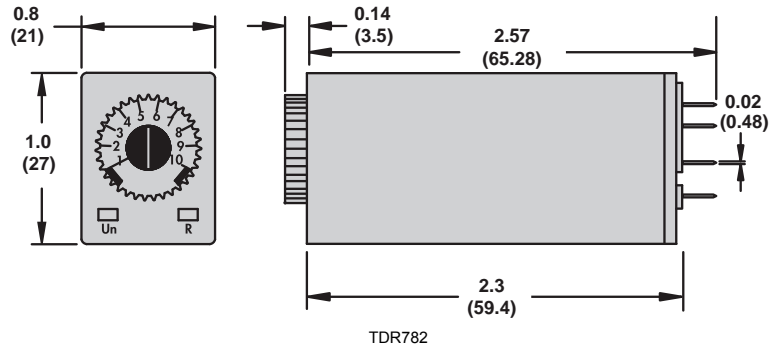

Wiring Diagram

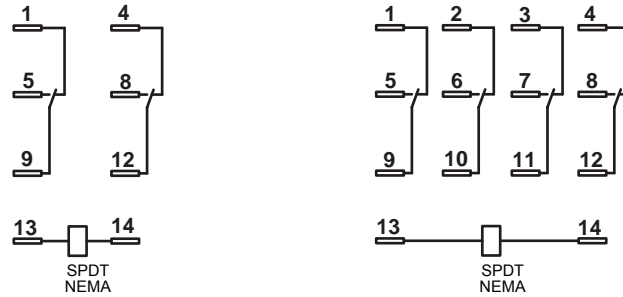

Relay Accessories

Description	Function	For Use With Relays	Packaging Quantities	Standard Part Number
Socket	Mounts directly to the DIN rail or panel	TDR782XBX	10	70-782EL8-1
		TDR782XBX TDR782XDX	10	70-782E14-1
	DIN or panel mounting with rising elevator box terminals	TDR782XBX	10	70782E141
		TDR782XDX		
	DIN or panel mounting with screw terminals and clamping plates	TDR782XBX	10	70-782D14-1
		TDR782XDX		
Solder terminals for chassis mounting		TDR782XBX	10	704611
		TDR782XDX		
Printed circuit terminals	TDR782XBX	10	703781	
	TDR782XDX			
Metal Retention Clip	Helps secure the relay in the socket	TDR782**	10	16-TDR782SC

Socket Accessories

Description	Function	For Use With Sockets	Packaging Quantities	Standard Part Number
Metal DIN Rail, 1 m (39.3 in.)	Quick installation and removal of sockets	See table above	10	16-700DIN
DIN Rail End Clip	Holds sockets firmly in place on the DIN rail	—	10	16-DCLIP-1
ID Tags	Allows for identification of circuits in multi-relay applications	70-782EL8-1	10	16-782FT-1
		70-782E14-1		
		70782E141		



TDRPRO Relay

**TDRPRO Series Time Delay and Sensor Relays**  
TDRPRO Series —SPDT, 12 A; DPDT, 12 A

Input Voltage	Timing Range	Functions Available	Contact Configuration	Rated Current	Standard Part Number
12–240 Vac/Vdc	100 ms to 9990 hr	A, B, C, D, E, F, G, H, I, J	DPDT	12 A	TDRPRO-5100
		A, B, C, D, E, F, G, H, I, J	SPDT	12 A	TDRPRO-5101
		A, B, C	DPDT	12 A	TDRPRO-5102

**TDRPRO Specifications**

Part Number	TDRPRO-5100	TDRPRO-5101	TDRPRO-5102
<b>Input Characteristics</b>			
Input Voltage Range	12–240 Vac/Vdc	12–240 Vac/Vdc	12–240 Vac/Vdc
Operating Voltage	85–115% of nominal	85–115% of nominal	85–115% of nominal
Maximum Power Consumption (AC)	2.5 VA	2.5 VA	2.5 VA
Maximum Power Consumption (DC)	2 W	2 W	2 W
<b>Output Characteristics</b>			
Contact Configuration	DPDT	SPDT	DPDT
Output Current Rating	12 A	12 A	12 A
Contact Material	Silver alloy	Silver alloy	Silver alloy
Switching Capabilities	12 A, 240 Vac, 50/60 Hz, 30 Vdc 1/3 hp @ 120 Vac 1/2 hp @ 240 Vac Pilot duty B300	12 A, 240 Vac, 50/60 Hz, 30 Vdc 1/3 hp @ 120 Vac 1/2 hp @ 240 Vac Pilot duty B300	12 A, 240 Vac, 50/60 Hz, 30 Vdc 1/3 hp @ 120 Vac 1/2 hp @ 240 Vac Pilot duty B300
Minimum Switching Requirement	100 mA	100 mA	100 mA
<b>Timing Characteristics</b>			
Functions Available	A, B, C, D, E, F, G, H, I, J	A, B, C, D, E, F, G, H, I, J	A, B, C
Time Scales	7	7	7
Time Ranges	0–999 by 0.1 s 0–999 by 1 s 0–999 by 0.1 min 0–999 by 1 min 0–999 by 0.1 hr 0–999 by 1 hr 0–999 by 10 hr	0–999 by 0.1 s 0–999 by 1 s 0–999 by 0.1 min 0–999 by 1 min 0–999 by 0.1 hr 0–999 by 1 hr 0–999 by 10 hr	0–999 by 0.1 s 0–999 by 1 s 0–999 by 0.1 min 0–999 by 1 min 0–999 by 0.1 hr 0–999 by 1 hr 0–999 by 10 hr
Repeatability of the Time Delay at Constant Voltage and Temperature	0.1%	0.1%	0.1%
Reset Time	150 ms	150 ms	150 ms
Operate Time <sup>[8]</sup>	25 ms maximum	25 ms maximum	25 ms maximum
Release Time <sup>[8]</sup>	25 ms maximum	25 ms maximum	25 ms maximum

**Dimensions, in. (mm)**

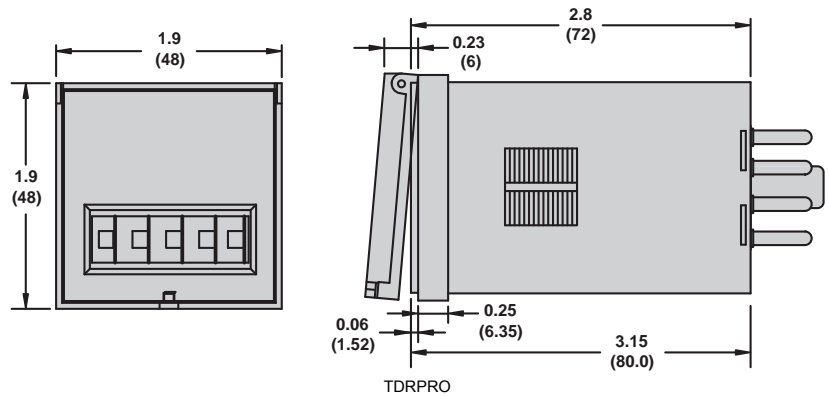

**Wiring Diagrams**

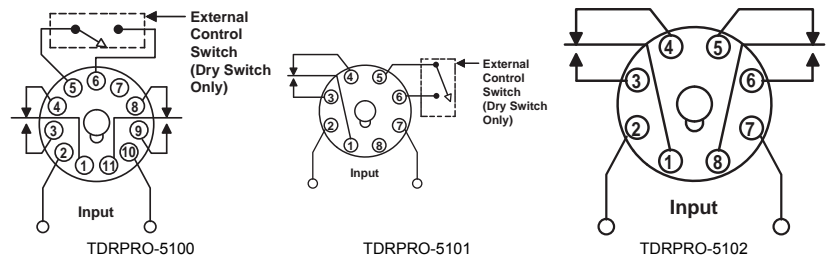

[8] After the time delay period expires, or upon application of the trigger signal (depending on the selected function).

## Relay Accessories

Description	Function	For Use With Relays	Packaging Quantities	Standard Part Number
Socket	Mounting directly to DIN Rail or Panel	TDRPRO-5101, TDRPRO-5102	10	70-750DL8-1
	Panel Mounting with Screw Terminals and Clamping Plates		10	701691
	DIN or Panel Mounting with Elevator Terminals	TDRPRO-5101	10	70750E81
	DIN or Panel Mounting with Screw Terminals and Clamping Plates		10	704641
	Mounting directly to DIN Rail or Panel	TDRPRO-5100	10	70-750DL11-1
	DIN or Panel Mounting with Elevator Terminals		10	70750E111
	DIN or Panel Mounting with Screw Terminals and Clamping Plates		10	704651
	Panel Mounting with Screw Terminals and Clamping Plates		10	701701
Metal Retention Clip	Helping secure the relay in the socket	TDRPRO	10	16TDRPROSC

## Socket Accessories

Description	Function	For Use With Sockets	Packaging Quantities	Standard Part Number
Metal DIN Rail, 1 m (39.3 in.)	Quick installation and removal of sockets	Compatible with all sockets listed in the table above.	10	16-700DIN
DIN Rail End Clip	Holds sockets firmly in place on the DIN rail		10	16-DCLIP-1
ID Tags	Identification of circuits in multi-relay applications	70-750E8-1, 70-750EL8-1, 70-750DL8-1, 70-750E11-1, 70-750EL11, 70-750DL11-1	10	16750/782FT1
Insulated Coil Bus Jumper System	Wireless socket connection	70-750E8-1, 70-750EL8-1, 70-750DL8-1, 70-750E11-1, 70-750EL11, 70-750DL11-1	10	16750/788CBJ1





9050JCK46V20

**Square D™ JCK General Purpose Plug-In Timers**

Square D 9050JCK timing relays are designed to provide low-cost timing in a plug-in housing. The Types JCK11 through 59 provide ±1% repeat accuracy. The Types JCK60 and 70 offer ±0.1% repeat accuracy. These timers are directly interchangeable with many other 8 and 11 pin octal base timers.

- Up to ±0.1% repeat accuracy
- Timing from 0.05 seconds to 999 hours
- Available in 7 timing modes
- DPDT contacts (2 N.O. and 2 N.C.)
- 10 A contact rating
- Transient protected
- Hold down spring available
- Variable or fixed time delay
- Horsepower rated
- RoHS compliant

**Table 23.148: Variable Time Delay**

Knob Adjustable Timing Range	On Delay <sup>[1]</sup>	Off Delay <sup>[2]</sup>	Off Delay with Power Trigger <sup>[1]</sup>	Interval <sup>[1]</sup>	One Shot <sup>[2]</sup> <sup>[4]</sup>	One Shot with Power Trigger <sup>[1]</sup>	Repeat Cycle <sup>[3]</sup>
0.1–10 seconds	JCK11	JCK21	JCK21PT	JCK31	JCK41	JCK41PT	JCK51
0.3–30 seconds	JCK12	JCK22	JCK22PT	JCK32	JCK42	JCK42PT	JCK52
0.6–60 seconds	JCK13	JCK23	JCK23PT	JCK33	JCK43	JCK43PT	JCK53
1.2–120 seconds	JCK14	JCK24	JCK24PT	JCK34	JCK44	JCK44PT	JCK54
1.8–180 seconds	JCK15	JCK25	JCK25PT	JCK35	JCK45	JCK45PT	JCK55
0.1–10 minutes	JCK16	JCK26	JCK26PT	JCK36	JCK46	JCK46PT	JCK56
0.3–30 minutes	JCK17	JCK27	JCK27PT	JCK37	JCK47	JCK47PT	JCK57
0.6–60 minutes	JCK18	JCK28	JCK28PT	JCK38	JCK48	JCK48PT	JCK58
1.2–120 minutes	JCK19	JCK29	JCK29PT	JCK39	JCK49	JCK49PT	JCK59

**Table 23.149: Fixed Time Delay**

Timing Mode	Type <sup>[1]</sup> <sup>[4]</sup> <sup>[5]</sup>	Timing Range (seconds)
On Delay	JCK1F(XXXX)	0.1 to 180
		181 to 3600
Off Delay <sup>[2]</sup>	JCK2F(XXXX)	0.1 to 180
		181 to 3600
Off Delay with Power Trigger	JCK2F(XXXX)PT	0.1 to 180
		181 to 3600
Interval	JCK3F(XXXX)	0.1 to 180
		181 to 3600
One Shot <sup>[2]</sup>	JCK4F(XXXX)	0.1 to 180
		181 to 3600
One Shot with Power Trigger	JCK4F(XXXX)PT	0.1 to 180
		181 to 3600
Repeat Cycle	JCK5F(XXXX)	0.1 to 180
		181 to 3600

**Table 23.150: Voltage Codes**

Voltage	Code
12 Vdc	V36
24 Vac/Vdc	V14
48 Vac/Vdc	V17
120 Vac/110 Vdc	V20
240–50/60 Vac	V24

**Table 23.151: How to Order**

To Order Specify:	Catalog Number		
	Class	Type	Voltage Code
<ul style="list-style-type: none"> <li>• Class Number</li> <li>• Type Number</li> <li>• Voltage Code</li> </ul>	9050	JCK11	V20

[1] Voltage code must be specified to order this product. Refer to the standard voltage codes listed in Table 23.150 and insert as shown in Table 23.151.  
 [2] Initiating contact can be up to 50 feet from the timer.  
 [3] Two dials are provided for independently adjustable repeat cycle timing ranges.  
 [4] (XXXX) denotes the timing period in seconds.  
 Example: Class 9050 Type JCK1F60 is an On Delay timer fixed at 60 seconds.  
 [5] Fixed repeat cycle timers can be supplied with the same or different On-Time and Off-Time.

**Type JCK60 and JCK70 Timers**

**NOTE:** Type JCK60 and JCK70 Timers are rated for AC supply voltage only. They are not rated for DC coil.

**Type JCK60**

This On-Delay timer uses four push button thumbwheels to set the time delay. One switch is used for the range. The remaining three are used for the time setting.



9050JCK60V14



9050JCK70V14

**Table 23.152: Selection**

Timing Modes	Timing Ranges		Type
On Delay	0.01s	0.05–9.99 seconds	JCK60 <sup>[6]</sup>
	0.1s	00.1–99.9 seconds	
	S	001–999 seconds	
	0.1m	00.1–99.9 minutes	
	M	001–999 minutes	
	0.1h	00.1–99.9 hours	
	H	001–999 hours	

**Type JCK70**

This multifunction multirange time delay relay uses five push button thumbwheel switches. Three switches are used for the time delay, one switch is used for the timing range, and the other switch is used to select the timing mode.

**Table 23.153: Selection**

Timing Modes	Timing Ranges	Type
On Delay Interval Off Delay One Shot Repeat Cycle-Off <sup>[7]</sup> Repeat Cycle-On On/Off Delay 1 Shot Falling Edge Watchdog Trigger On Delay	Same as JCK60	JCK70 <sup>[6]</sup>

**Table 23.154: Sockets**

Contact Terminal Arrangement	Connection	For Use with Relays	Sold in Lots of	Catalog Number <sup>[8]</sup>
Mixed <sup>[9]</sup>	Screw Connector	JCK11–19 JCK31–39 JCK51–59 JCK60 JCK1 F JCK3 F JCK5 F	1	8501NR51
		JCK21–29 JCK41–49 JCK70 JCK2F JCK4F	10	8501NR51B
		JCK21–29 JCK41–49 JCK70 JCK2F JCK4F	1	8501NR61
		JCK21–29 JCK41–49 JCK70 JCK2F JCK4F	10	8501NR61B
Separate <sup>[10]</sup>	Screw Connector	JCK11–19 JCK31–39 JCK51–59 JCK60 JCK1 F JCK3 F JCK5 F	1	8501NR52
		JCK21–29 JCK41–49 JCK70 JCK2F JCK4F	10	8501NR52B
		JCK21–29 JCK41–49 JCK70 JCK2F JCK4F	1	8501NR62
		JCK21–29 JCK41–49 JCK70 JCK2F JCK4F	10	8501NR62B

**Table 23.155: Accessories (sold in lots of 10)**

Description	For Use With	Sold in Lots of	Catalog Number
Metal Restraining Strap	8501NR51 sockets	1	8501NH7
	8501NR52 sockets		
	8501NR61 sockets		
	8501NR62 sockets		



8501NR61



8501NR52



8501NH7

**Approvals for 9050JCK Timers**



File: E3190  
CCN: NLDX2



File: E3190  
CCN:  
NLDX,  
NLDX7<sup>[11]</sup>



File:  
260367  
Class:  
3211 07



RoHS  
Compliant

[6] Voltage code must be specified to order this product. Refer to the standard voltage codes listed in Table 23.150 and insert as shown in Table 23.151.

[7] The repeat cycle mode uses the same on-time and off-time.

[8] Please note that the B suffix only designates quantities of 10 and is not printed on the socket.

[9] The inputs and outputs are mixed on both sides.

[10] The inputs and outputs are on separate sides.

[11] When used with the appropriate 8501NR socket.

**Zelio™ Current Measurement Relays**

Zelio Current Measurement Relays are designed to measure under and overcurrent conditions, without external sensors. Current measurement relays enable continuous monitoring of the operation of electrical and mechanical loads such as motors and heaters. They are DIN rail mountable and the control status is indicated by an LED.

**RM17JC Current Control Relay**

- Monitors AC currents
- Designed to monitor overcurrent
- Equipped with an integrated current transformer

**RM35JA Current Control Relays**

- Selection between overcurrent or undercurrent
- Automatic DC or AC recognition
- Selectable memory function



RM17JC00MW



RM35JA31MW



RM35JA32MW

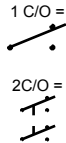

**Table 23.156: Zelio Current Measurement Relays**

Supply Voltage	Measurement Range		Output 5 A	Width		Catalog Number
	Range/IT	Terminals		Inches	mm	
24–240 Vac/dc	2–20 A	N/A	1 C/O	0.69	17.50	RM17JC00MW
	2–20 mA	E1-M	2 C/O	1.38	35.00	RM35JA31MW
	10–100 mA	E2-M				
	50–500 mA	E3-M				
	0.15–1.5 A	E1-M				
	0.5–5 A	E2-M				
1.5–15 A	E3-M	RM35JA32MW				

**Table 23.157: Output Characteristics and Measurement Circuit Characteristics**

Type of Relay	RM17JC00MW	RM35JA31MW	RM35JA32MW
Setting accuracy	Plus or minus 10% of the full scale value		
Repeat accuracy (with constant parameters)	Plus or minus 0.5%		
Hysteresis	15% of the threshold setting, fixed	5 to 50% of the threshold setting, adjustable	
Time delay accuracy (with constant parameters)	N/A	Plus or minus 2%	
Time delay on pick-up	500 ms	300 ms	
Conforming to standards	NF EN 60255-6		
Ambient air temperature around the device	Storage	-40 to 158 degrees F (-40 to +70°C)	
	Operational	-4 to 122 degrees F (-20 to +50°C)	

**Approvals for Zelio Current Measurement Relays**



File: E173076  
CNN: NRNT,  
NRNT7



File: 248382  
Class: 3211 07



CE: 73/23/EEC  
and EMC 89/  
336/EEC

GL, C-Tick,  
GOST, RoHS

**Approximate Dimensions**

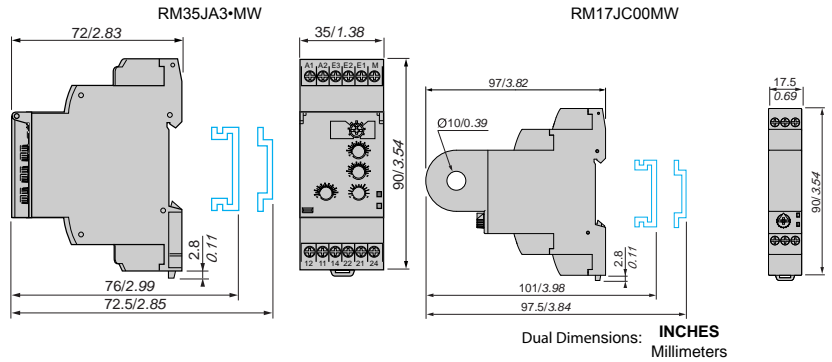

[1] Above 15 A, a current transformer can be connected (for RM35JA3-MW). See page 57 of catalog 8430CT0601 for suggested wiring.

**Zelio™ Phase Measurement Relays**

Zelio Phase Measurement Relays monitor their own power supply. Relay status is indicated by an LED and they are DIN rail mountable.

RM17TG-0 measurement and control relays are for monitoring of 3-phase supplies for the correct sequencing of phases L1, L2, and L3, as well as the total loss of one or more phases.



RM17TG-0



RM17TE00



RM17TA00



RM35TM-MW



RM35TF30

**Table 23.158: 3-Phase Supply Control Relays**

Supply Voltage	Detection Threshold	Output 5 A	Width		Catalog Number
			inches	mm	
208–480 Vac	<100 Vac	1 C/O	0.69	17.50	RM17TG00
208–440 Vac		2 C/O			RM17TG20

**Table 23.159: Multifunction 3-Phase Supply Control Relays**

Supply Voltage	Voltage Range	Output 5 A	Width		Catalog Number
			inch	mm	
208–480 Vac	Selectable voltages: 208, 220, 380, 400, 415, 440, 480	1 C/O	0.69	17.50	RM17TT00
					RM17TA00
					RM17TU00
					RM17TE00

**Table 23.160: RM17TT, RM17TA, RM17TU, and RM17TE Multifunction Control Relays monitor the following on 3-phase supplies:**

Function	RM17TT	RM17TA	RM17TU	RM17TE
Sequence of phases L1, L2 and L3	Yes	Yes	Yes	Yes
Phase failure with regeneration (0.7 x selected voltage range)	Yes	Yes	Yes	Yes
Asymmetry (phase imbalance)	No	Yes	No	Yes
Undervoltage	No	No	Yes	No
Overvoltage and undervoltage	No	No	No	Yes

**Table 23.161: 3-Phase Supply and Motor Temperature Control Relays**

Supply Voltage	Measurement Range	Output 5 A	Width		Catalog Number
			inch	mm	
220–480 Vac	208–480 Vac	2 N.O.	1.38	35.00	RM35TM50MW
					RM35TM250MW

**Table 23.162: RM35TM Control Relays monitor the following on 3-phase supplies:**

Function	RM35TM50MW	RM35TM250MW
Sequence of phases L1, L2 and L3	Yes	Yes
Phase failure	Yes	Yes
Motor temperature via PTC probe	Yes	Yes
Selection (with or without memory)	No	Yes
Test-reset button	No	Yes

RM35TF30 measurement and control relay is for monitoring of phase sequence, phase failure, asymmetry, undervoltage and overvoltage in window mode.

**Table 23.163: Multifunction 3-Phase Supply Control Relays**

Supply Voltage	Measurement Range	Output 5 A	Width		Catalog Number
			inch	mm	
220–480 Vac	194–528 Vac	2 C/O	1.38	35.00	RM35TF30

**Approvals for Zelio Phase Measurement Relays**



File: E173076  
CNN: NRNT,  
NRNT7



File: 248382  
Class: 3211 07



CE: 73/23/EEC  
and EMC 89/  
336/EEC

GL, C-Tick,  
GOST, RoHS

**Approximate Dimensions**

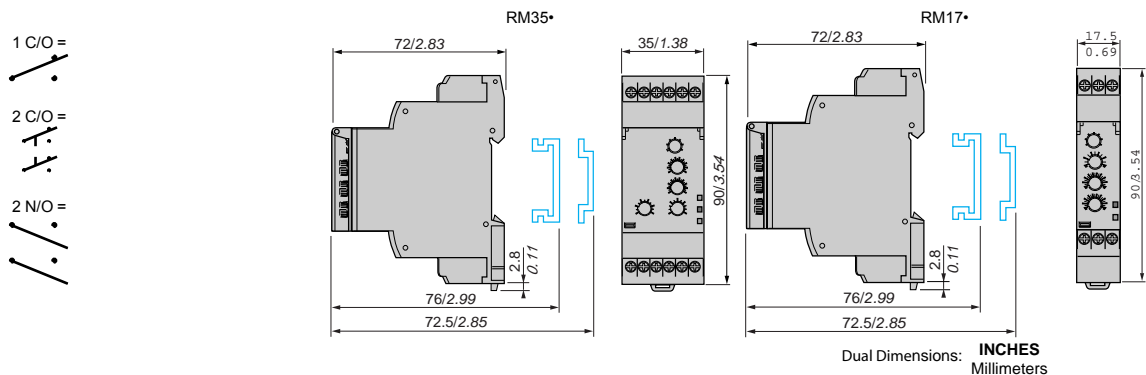

**Zelio™ Voltage Measurement Relays**

Zelio Voltage Measurement Relays are DIN rail mountable and relay status is indicated by an LED. Single phase and DC voltage measurement and control relays RM17UAS\*\* and RM17UBE\*\* monitor:

- Overvoltage
- Undervoltage
- Overvoltage and undervoltage
- Nominal voltages



**Table 23.164: Single-phase and DC voltage control relays**

Supply Voltage	Ranges Controlled	Output 5 A	Width		Catalog Number
			in.	mm	
12 Vdc	9–15 Vdc	1 C/O	0.69	17.50	RM17UAS14[2]
24–48 Vac/Vdc	20–80 Vac/Vdc				RM17UAS16[2]
110–240 Vac/Vdc	65–260 Vac/Vdc				RM17UAS15[2]
24–48 Vac/Vdc	20–80 Vac/Vdc				RM17UBE16[3]
110–240 Vac/Vdc	65–260 Vac/Vdc				RM17UBE15[3]

Multifunction voltage control relays RM35UA1•MW monitor both AC and DC voltages.

- Automatic Vdc or Vac recognition
- Selection between overvoltage and undervoltage

**Table 23.165: Multifunction voltage control relays**

Supply Voltage	Measurement Range		Output 5 A	Width		Catalog Number
	Range[4]	Terminals		in.	mm	
24–240 Vac/Vdc	0.05–0.5 V	E1-M	2 C/O	1.38	35.00	RM35UA11MW
	0.3–3 V	E2-M				
	0.5–5 V	E3-M				
	1–10 V	E1-M				RM35UA12MW
	5–50 V	E2-M				
	10–100 V	E3-M				
	15–150 V	E1-M				RM35UA13MW
	30–300 V	E2-M				
	60–600 V	E3-M				

3-phase voltage control relays monitor:

- Failure of one or more phases
- Voltage between phases
- Absence of neutral
- Voltage between phases and neutral
- Overvoltage and undervoltage

**Table 23.166: Three-phase voltage control relays**

Rated 3-Phase Supply Voltage Vac	Measurement Range	Output 5 A	Width		Catalog Number
			in.	mm	
220–480 phase-phase	195–528 Vac	1 C/O + 1 C/O 1 per threshold	1.38	35.00	RM35UB330[5]
120–277 phase-neutral	183–528 Vac	1 C/O	0.69	17.50	RM17UB310[5]
120–277 phase-neutral	114–329 Vac	1 C/O + 1 C/O 1 per threshold	1.38	35.00	RM35UB3N30[4]

**Approvals for Zelio Voltage Measurement Relays**

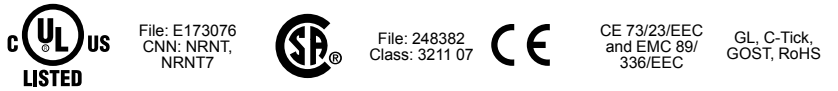

**Approximate Dimensions**

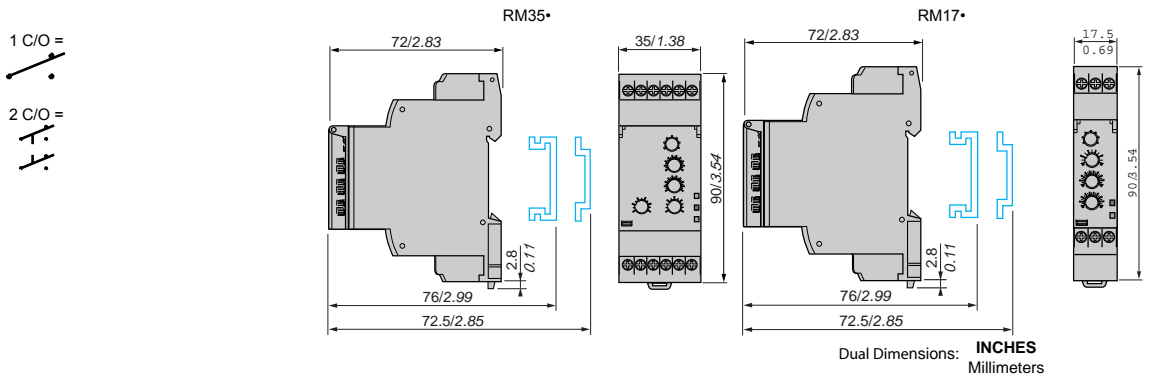

[2] Provides overvoltage or undervoltage protection.  
 [3] Provides overvoltage and undervoltage protection in window mode.  
 [4] Provides overvoltage and undervoltage protection between phases and neutral and absence of neutral.  
 [5] Provides overvoltage and undervoltage protection between phases.



RM35LM33MW



RM35LV14MW



RM79696043



LA9RM201



RM79696006



## Zelio™ Level Control Relays and Zelio™ Pump Control Relays

Zelio level control relays control one or two levels with fill or empty function. The settings are protected by a sealable cover, control status is indicated by an LED, and they are DIN rail mountable. RM35LM is designed to control levels of conductive liquid, and RM35LV is designed to control levels of other materials.

### Application examples for RM35LM:

- Detecting pump seal failures
- Spring, town, industrial and sea water
- Metallic salt, acid or base solutions
- Liquid fertilizers
- Non-concentrated alcohol (<40%)

### Application examples for RM35LV:

- Liquids in the food-processing industry: milk, beer, coffee, etc.
- Chemically pure water
- Fuels, liquid gasses (inflammable)
- Oil, concentrated alcohol (>40%)
- Ethylene, glycol, paraffin, varnish and paints

**Table 23.167: Level Control Relays**

Time Delay on Crossing the Threshold	Function	Output Relay	Supply Voltage 50/60 Hz	Measurement Ranges	Catalog Number
0.1–5 seconds, 0 + 10%	Detection by resistive probes	2 C/O, 5 A	24–240 Vac/Vdc	250–5 k	RM35LM33MW
				5 k–100 k	
	Detection by discrete sensors	1 C/O, 5 A		50 k–1 M	RM35LV14MW
				—	

**Table 23.168: Probes**

Application	No. of probes	Operating temperature		Max. Pressure kg/cm <sup>2</sup>	Catalog Number
		°F	°C		
Recommended for drink vending machines and where installation space is limited (stainless steel) <sup>[6]</sup>	3	176	80	2	RM79696044
Suitable for boilers, pressure vessels, and under high temperature conditions (1) (304 stainless steel) <sup>[6]</sup>	1	392	25	200	RM79696014

**Table 23.169: Probes**

Description	Catalog Number
Protected probe for mounting by suspension, protective shell PUC (S7) Electrode: stainless steel	RM79696043
Liquid level control probe, suspended by cable, maximum operating temperature 212 °F (100 °C) <sup>[7]</sup>	LA9RM201

**Table 23.170: Electrode Holders**

Description	Material	Catalog Number
Electrode for use up to 662°F (350°C)	Stainless steel isolated by ceramic	RM79696006

[6] 3/8 in. BSP mounting thread with hexagonal head. Use a 24 mm spanner for tightening.

[7] 3/8 in. BSP mounting head.

Refer to Catalog [DIA5ED2160501EN](#)

**Pump Control Relay**

Zelio pump control relay RM35BA10 can operate on a single-phase or 3-phase supply. It incorporates three functions in a signal unit:

- Over and under current measurement
- Phase presence control
- Single or three phase

It has two operating modes which are designed to control a pump via two external signal inputs (Y1 Y2). These two signals are controlled by volt-free contacts. Control inputs Y1 and Y2 can be connected to:

- Level sensor
- Level relay
- Pressure sensor
- Push button



RM35BA10

1 C/O =



2 C/O =



**Table 23.171: Pump Control Relay**

Description	Current Range Controlled	Supply Voltage	Output	Catalog Number
Pump Control Relay	1–10 A	208–480 Vac, 3 phase	1 C/O 5 A	RM35BA10
		230, single-phase		

**Approvals for Zelio Level Control and Pump Control Relays**



File: E173076  
CNN: NRNT,  
NRNT7



File: 248382  
Class: 3211 07



CE 73/23/EEC  
and EMC 89/  
336/EEC

GL, C-Tick,  
GOST, RoHS

**Approximate Dimensions (mm/in.)**

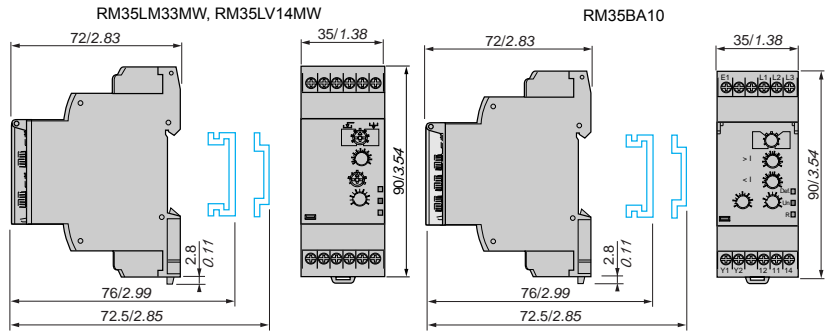



RM35S0MW



RM35HZ21FM



RM35AT-0MW

**Zelio™ Speed, Frequency, & Temp. Control Relays**

Zelio speed control relay RM35SOMW monitors underspeed and overspeed conditions, with or without memory, with inhibition by an external contact. It operates with either N.O. or N.C. sensors. Adjustable time between impulses is 0.05 s to 10 min. Power-on inhibition time is adjustable from 0.6 to 60 s. Inhibition is controlled by an external contact. Settings are protected by a sealable cover, control status is indicated by an LED, and it is DIN rail mountable.

**Table 23.172: Speed Control Relay**

Function	Time Delay	Measurement Input	Supply	Output	Catalog Number
Under-speed	0.05 s to 10 min	3-wire PNP or NPN proximity sensor	24–240 Vac/ Vdc	1 C/O 5 A	RM35S0MW
Over-speed		Namur type proximity sensor 0–30 V voltage Volt-free contact			

Zelio frequency control relay RM35HZ monitors its own supply voltage. Settings are protected by a sealable cover, control status is indicated by an LED, and it is DIN rail mountable.

**Table 23.173: Frequency Control Relay**

Function	Controlled	Supply Voltage	Output	Catalog Number
Over frequency and under frequency (50 or 60 Hz)	40–60 Hz (50 Hz) / 50–70 Hz (60 Hz)	120–277 Vac	1 C/O + 1 C/O 5 A	RM35HZ21FM

Zelio temperature control relays are designed for monitoring the temperature in elevator (lift) rooms, in compliance with directive EN81. For use with PT100 input (customer supplied). Features adjustable control, control status indicated by an LED, and is DIN rail mountable.

**Table 23.174: Temperature Control Relays**

Function	Supply Voltage	Vac	Output	Catalog Number
Over temperature 93 to 114°F (34 to 46°C)	24–240 Vac/Vdc	—	1 C/O 5 A	RM35ATL0MW
Under temperature 30 to 51°F (-1 to 11°C)		—	2 N.O. 5 A	RM35ATR5MW
Over temperature 93 to 114 °F (34 to 46°C) Under temperature 30 to 51°F (-1 to 11°C)		208–480 Vac	2 N.O. 5 A	RM35ATW5MW
Phase sequence Phase failure				

**Approvals for Zelio Speed, Frequency, and Temperature Control Relays**



File: E173076  
CNN: NRNT,  
NRNT7



File: 248382  
Class: 3211 07



CE: 73/23/EEC  
and EMC 89/  
336/EEC

GL, C-Tick,  
GOST, RoHS

**Approximate Dimensions (mm/in.)**

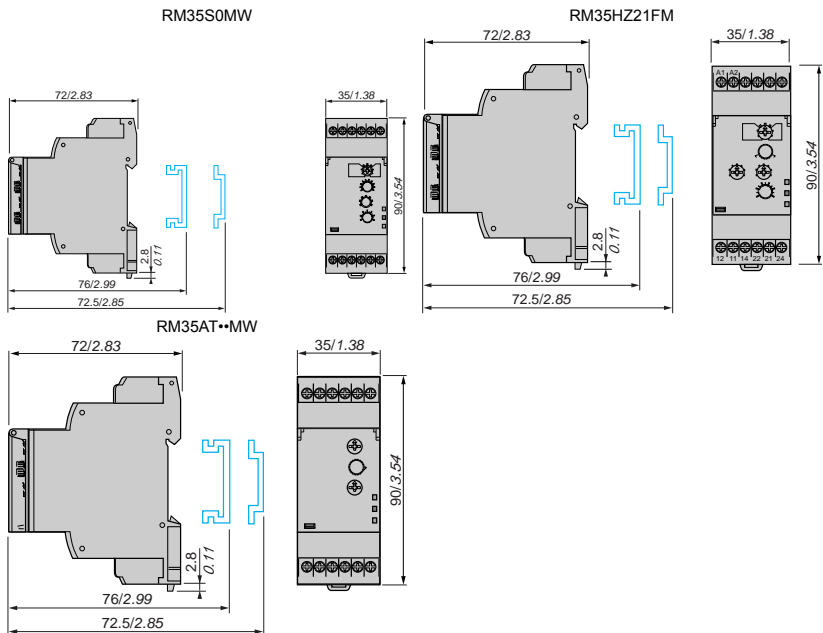
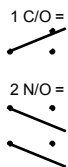





ABL8MEM12020



ABL8REM24030

### Phaseo™ DC Power Supply

Phaseo switch mode power supplies are totally electronic and their output voltage is regulated. They offer:

- Compact size
- High degree of output voltage stability

For use with Universal power supplies, see optional function modules in catalog DIA3ED207041EN-US, which offer a set of solutions to meet the needs for continuity of service such as:

- Immunity to microbreaks
- Voltage holding during power outages
- Voltage holding during power supply equipment failure

#### Table 23.175: Modular, Single Phase

Meets all the needs of simple automation systems with power ratings from 7 to 60 W and an output voltage of 5 Vdc, 12 Vdc, or 24 Vdc.

Input Voltage (Vac)	Output Voltage (Vdc)	Nominal Current (I)	Protection Reset	Catalog Number	
100–240	5	4	Auto	ABL8MEM05040	
	12	2		ABL8MEM12020	
	24			0.3	ABL8MEM24003
				0.6	ABL8MEM24006
				1.2	ABL8MEM24012
				2.5	ABL7RM24025

#### Table 23.176: Optimum, Single Phase

The low-cost solution for applications supplied at 12 Vdc, 24 Vdc, or 48 Vdc and requiring currents between 3 and 5 A.

Input Voltage (Vac)	Output Voltage (Vdc)	Nominal Current (I)	Protection Reset	Catalog Number
100–240	12	5	Auto	ABL7RP1205
	24	3		ABL8REM24030
		5		ABL8REM24050
		2.5		ABL7RP4803

#### Table 23.177: Universal, Single Phase

Adapts to the majority of power distribution systems with power ratings from 72 to 480 W at 24 Vdc. The same power supply can be connected phase-to-neutral (N-L1) or phase-to-phase (L1-L2) for line supplies ranging from 100 to 500 Vac. Energy reserve, diagnostics, and choice of manual or auto reset are integrated into these units.

Input Voltage (Vac)	Output Voltage (Vdc)	Nominal Current (I)	Auto-Protection Reset	Catalog Number
100–120 / 200–500	24	3	Auto/Manual	ABL8RPS24030
		5		ABL8RPS24050
		10		ABL8RPS24100
100–120 / 200–240	24	20	Auto/Manual	ABL8RPM24200

#### Table 23.178: Universal, Three Phase

This three-phase, 480 to 960 W, 24 Vdc output offering is particularly suited for complex machines and processes. Energy reserve, diagnostics, and choice of manual or auto reset are integrated into these units.

Input Voltage (Vac)	Output Voltage (Vdc)	Nominal Current (I)	Auto-Protection Reset	Catalog Number
380–500	24	20	Auto/Manual	ABL8WPS24200
		40		ABL8WPS24400

#### Table 23.179: Dedicated, Single Phase

Designed for integration into repetitive equipment with power ratings from 60 to 240 W and an output voltage of 12 Vdc or 24 Vdc.

Input Voltage (Vac)	Output Voltage (Vdc)	Nominal Current (I)	Protection Reset	Catalog Number
100–240 <sup>[1]</sup>	12	5	Auto	ABL1REM12050
	24	2.5		ABL1REM24025
		4.2		ABL1REM24042
100–120 / 200–240 <sup>[2]</sup>	24	6.2	Auto	ABL1REM24062
		10		ABL1REM24100
100–240 <sup>[1]</sup>	12	8.3	Auto	ABL1RPM12083
	24	4.2		ABL1RPM24042
100–120 / 200–240 <sup>[2]</sup>	24	6.2	Auto	ABL1RPM24062
		10		ABL1RPM24100

#### Approvals for Phaseo DC Power Supply

 File: E164867  
 CCN: NMTR, NMTR7

 File: E164867  
 CCN: NMTR2, NMTR8

 File: 238438  
 Class: 5311-87, 5311-07

 RoHS Compliant

- SEMI F47 Compliant for most units
- For additional information, refer to Catalog DIA3ED207041EN-US.

[1] Compatible input voltage 120-370 Vdc not indicated on the product.  
 [2] Compatible input voltage 180-370 Vdc not indicated on the product.

**Zelio™ Analog Interface Modules**

The Zelio Analog range of converters is designed to convert signals emitted by sensors or electrical measurement devices into standard electrical signals that are compatible with automation platforms and controllers. They also allow the connection distance between a sensor and a measurement device to be increased, for example, between a thermocouple and a programmable controller



RMTJ40BD



RMTK90BD



RMPT70BD



RMPT13BD



RMCN22BD

**Table 23.180: Converters for Type J and K thermocouples—supply voltage 24 Vdc ± 20%, non-isolated**

Type	Temperature Range		Switchable Output Signals	Catalog Number
	°F	°C		
Type J	32–302	0–150	0–10 V, 0–20 mA, 4–20 mA	RMTJ40BD
	32–572	0–300	0–10 V, 0–20 mA, 4–20 mA	RMTJ60BD
	32–1112	0–600	0–10 V, 0–20 mA, 4–20 mA	RMTJ80BD
Type K	32–1112	0–600	0–10 V, 0–20 mA, 4–20 mA	RMTK80BD
	32–2192	0–1200	0–10 V, 0–20 mA, 4–20 mA	RMTK90BD

**Table 23.181: Converters for Universal Pt100 probes—supply voltage 24 Vdc ± 20%, non-isolated**

Type	Temperature Range		Switchable Output Signals	Catalog Number
	°F	°C		
Pt100 2-wire, 3-wire, and 4-wire	- 40–104	- 40–40	0–10 V, 0–20 mA, 4–20 mA	RMPT10BD
	- 148–212	- 100–100	0–10 V, 0–20 mA, 4–20 mA	RMPT20BD
	32–212	0–100	0–10 V, 0–20 mA, 4–20 mA	RMPT30BD
	32–482	0–250	0–10 V, 0–20 mA, 4–20 mA	RMPT50BD
	32–932	0–500	0–10 V, 0–20 mA, 4–20 mA	RMPT70BD

**Table 23.182: Converters for Optimum Pt100 probes<sup>[1]</sup>—supply voltage 24 Vdc ± 20%, non-isolated**

Type	Temperature Range		Switchable Output Signals	Catalog Number
	°F	°C		
Pt100 2-wire, 3-wire, and 4-wire	- 40–104	- 40–40	0–10 V or 4–20 mA	RMPT13BD
	- 148–212	- 100–100	0–10 V or 4–20 mA	RMPT23BD
	32–212	0–100	0–10 V or 4–20 mA	RMPT33BD
	32–482	0–250	0–10 V or 4–20 mA	RMPT53BD
	32–932	0–500	0–10 V or 4–20 mA	RMPT73BD

**Table 23.183: Universal Voltage/Current Converters**

Type	Input Signal	Output Signal	Catalog Number
Supply voltage 24 Vdc ± 20%, non-isolated	0–10 V or 4–20 mA	0–10 V or 4–20 mA	RMCN22BD
Supply voltage 24 Vdc ± 20%, isolated	0–10 V, ± 10 V, 0–20 mA, 4–20 mA	Switchable: 0–10 V, ± 10 V, 0–20 mA, 4–20 mA	RMCL55BD
	0–50 V, 0–300 V, 0–500 V DC or AC, 50/60 Hz	Switchable: 0–10 V, 0–20 mA, 4–20 mA	RMCV60BD
	0–1.5 A, 0–5 A, 0–15 A DC or AC, 50/60 Hz	0–10 V, 0–20 mA, 4–20 mA	RMCA61BD

**Approvals for Zelio Analog Interface Modules**



File: E164353  
CCN: NKCR



File: 044087\_S\_000  
Class: 32T1 07



IEC 60947-1

RoHS Compliant

**Table 23.184: How to Order**

To Order Specify:	Catalog Number
• Catalog Number	RMCN22BD

[1] Converters dedicated to Zelio Logic smart relays.



ABS2EA02EM



ABS2SA01MB

### Solid State Interface Modules

ABS solid state relay interface modules are for discrete digital input or output control signals exchanged in automated equipment. Features include:

- High operating rate
- 5 separate character places for marking
- Silent operation
- LED indication of the control signal state
- 35 mm DIN 3 or 32 mm DIN 1 track mountable

**Table 23.185: Solid State Interface Input Modules**

Input Module Catalog No.	Input Module Catalog Number				
	ABS2EC01EA	ABS2EC01EB	ABS2EC01EE	ABS2EA02EF	ABS2EA02EM
Dimensions (WxDxH) [2]	Inches: 0.37 x 2.78 x 2.91			mm: 9.5 x 70.5 x 74	
<b>Control Circuit Characteristics</b>					
Rated Voltage US	5 Vdc	24 Vdc	48 Vdc	120/127 60Hz	230/240 60Hz
Maximum Voltage	6 (TTL)	28.8 Vdc	57.6 Vdc	140 Vac	264 Vac
Maximum Current at Us	13.6 mA	12 mA	10.5 mA	17 mA	15 mA
Internal Protection Against Reverse Polarity	Yes	Yes	Yes	N/A	N/A
<b>Output Circuit Characteristics</b>					
Rated Operational Voltage Ve	5 to 48 Vdc	5 to 48 Vdc	5 to 48 Vdc	5 to 48 Vdc	5 to 48 Vdc
Min./Max. Voltage	2/60 Vdc	2/60 Vdc	2/60 Vdc	2/60 Vdc	2/60 Vdc
Min./Max. Switching Current	1/50 mA	1/50 mA	1/50 mA	1/50 mA	1/50 mA
Rated Insulation Voltage	Conforming to IEC 60947-1: 300 V Conforming to IEC 0110: 250 V group C				
Approvals	UL E164353, CSA 044087_S_000, IEC 60947-1				

**Table 23.186: Solid State Interface Output Modules**

	Output Module Catalog Number			
	ABS2SC01EB	ABS2SC02EB	ABS2SA01MB	ABS2SA02MB
Dimensions (W x D x H) [2]	Inches: 0.69 x 2.78 x 2.91		mm: 17.5 x 70.5 x 74	
<b>Control Circuit Characteristics</b>				
Rated Voltage Us	24 Vdc	24 Vdc	24 Vdc	24 Vdc
Maximum Voltage	28.8 Vdc	28.8 Vdc	28.8 Vdc	28.8 Vdc
Maximum Current at Us	12 mA	12 mA	13.6 mA	13.6 mA
Internal Protection against reverse polarity	Yes	Yes	Yes	Yes
<b>Output Circuit Characteristics</b>				
Rated Operational Voltage Ve	5 to 48 Vdc	5 to 48 Vdc	24 to 240 Vac	24 to 240 Vac
Maximum Voltage	57.6 Vdc	57.6 Vdc	264 Vac	264 Vac
Internal Protection against reverse polarity	Yes	Yes	Yes	Yes
External Protection	3.15 A external fuse fast blow (Ik <= 1 kA AC and Ik <= 100 A DC)			
Rated insulation voltage	Conforming to IEC 60947-1: 300 V Conforming to VDE 0110: 250 V group C			
Approvals	UL E164353, CSA 044087_S_000, IEC 60947-1			

- For Mounting Track, see [Mounting Track, End Clamps, Jumpers, Fanning Strips, page](#) .

**Table 23.187: How to Order**

To Order Specify:	Catalog Number
• Catalog Number	ABS2EC01EA

[2] Dimensions mounted on DIN 3 (7.5 mm high) track.

Refer to Catalog DIA3ED2090304EN-US

Electromechanical Interface Modules

ABR electromechanical relay modules are for discrete digital input or output control signals exchanged in automated equipment. Features include:

- High contact reliability
- LED indication of the control signal state
- 5 separate character places for marking
- 35 mm DIN 3 or 32 mm DIN 1 track mountable

23

RELAYS AND TIMERS



ABR1E411F



ABR2E112E



ABR1S111F



ABR2S102B

Table 23.188: Input Modules

Coil Voltage	Options	1 N.O. Contact	1 C.O. Contact	2 N.O. Contacts
		Catalog Number	Catalog Number	Catalog Number
24 Vac/Vdc	Manual Operator and LED Indication	ABR1E118B <sup>[3]</sup>	ABR1E318B <sup>[3]</sup>	ABR1E418B <sup>[3]</sup>
48 Vac/Vdc		ABR1E118E <sup>[3]</sup>	ABR1E318E <sup>[3]</sup>	ABR1E418E <sup>[3]</sup>
110–125 Vdc		ABR1E112F <sup>[3]</sup>	ABR1E312F <sup>[3]</sup>	ABR1E412F <sup>[3]</sup>
110–127 Vac 50/60 Hz		ABR1E111F <sup>[3]</sup>	ABR1E311F <sup>[3]</sup>	ABR1E411F <sup>[3]</sup>
230–240 Vac 50/60 Hz		ABR1E111M <sup>[3]</sup>	ABR1E311M <sup>[3]</sup>	ABR1E411M <sup>[3]</sup>
230–240 Vac 50/60 Hz	Manual Operator	ABR1E101M <sup>[3]</sup>	ABR1E301M <sup>[3]</sup>	—
24 Vdc	LED Indication	ABR2E112B	—	—
48 Vdc		ABR2E112E	—	—
120–127 Vac 60 Hz		ABR2E116F	—	—
230–240 Vac 50/60 Hz		ABR2E111M	—	—
24 Vdc		—	ABR2EB312B	—

Table 23.189: Output Modules

Coil Voltage	Options	1 N.O. Contact	1 C.O. Contact	2 N.O. Contacts	1 N.C. & 1 N.O. Contact
		Catalog Number	Catalog Number	Catalog Number	Catalog Number
24 Vdc	Manual Operator	ABR1S102B <sup>[3]</sup>	ABR1S302B <sup>[3]</sup>	ABR1S402B <sup>[3]</sup>	ABR1S602B <sup>[3]</sup>
24 Vac/Vdc	Manual Operator and LED Indication	ABR1S118B <sup>[3]</sup>	ABR1S318B <sup>[3]</sup>	ABR1S418B <sup>[3]</sup>	ABR1S618B <sup>[3]</sup>
48 Vac/Vdc		ABR1S118E <sup>[3]</sup>	ABR1S318E <sup>[3]</sup>	ABR1S418E <sup>[3]</sup>	ABR1S618E <sup>[3]</sup>
110–127 Vac 50/60 Hz		ABR1S111F <sup>[3]</sup>	ABR1S311F <sup>[3]</sup>	ABR1S411F <sup>[3]</sup>	ABR1S611F <sup>[3]</sup>
24 Vdc	LED Indication	ABR2S112B	—	—	—
48 Vdc		—	ABR2SB312B	—	—
24 Vdc		—	ABR2S102B	—	—

Table 23.190: Coil Data: ABR1E, ABR2E

Relay		ABR1E					ABR2E			
		24 Vac/Vdc	48 Vac/Vdc	127 Vdc	127 Vac	240 Vac	24 Vdc	48 Vdc	127 Vac	240 Vac
Coil Voltage U <sub>e</sub>	V	24	48	127	127	240	24	48	127	240
Maximum Voltage	V	30	53	137	140	255	28.8	56	140	264
Pick-up Voltage	V	17	38	97	93	195	16.9	37.3	97	186
Minimum Sealed Current	mA	5.2	5.4	1.5	2.4	2	2	2	2.5	2.5
Maximum Sealed Current	mA	62	36	15	8	7	19.5	11	16	15

Table 23.191: Coil Data: ABR2EB, ABR1S, ABR2S, ABR2SB

Relay		ABR2EB	ABR1S			ABR2S	ABR2SB
		24 Vdc	24 Vdc	48 Vac/Vdc	127 Vac	24	24
Coil Voltage U <sub>e</sub>	V	24 Vdc	24 Vdc	48 Vac/Vdc	127 Vac	24	24
Maximum Voltage	V	28.8	30	53	140	28.8	28.8
Pick-up Voltage	V	16.9	17	38	83	16.9	16.9
Minimum Sealed Current	mA	2	6.6	6.2	5.4	2	2
Maximum Sealed Current	mA	29	62	62	36	8	29

Table 23.192: Contact Ratings

Relay		ABR1E	ABR2E	ABR2EB	ABR1S	ABR2S	ABR2SB
Rated Voltage U <sub>e</sub>	Vac	250	115	48	250	230	48
Rated Voltage U <sub>e</sub>	Vdc	125	100	48	125	120	48
Thermal Current I <sub>th</sub>	A	2	1	0.05	5	5	0.05
Break Rating (AC14)	A	1	0.5	1	1	1	—
Break Rating (DC13)	A	1	1	1	1	1.5	—

Table 23.193: Dimensions

Modules	Approximate Dimensions (WxDxH) <sup>[4]</sup>	
	in.	mm
ABR1E, ABR2EB, ABR2SB	0.69 x 2.91 x 2.78	17.5 x 74 x 70.5
ABR2E	0.37 x 2.91 x 2.78	9.5 x 74 x 70.5
ABR2S1	0.47 x 2.91 x 2.78	12 x 74 x 70.5

Approvals	
ABR1E, ABR2E	UL E164353, CSA 044087_S_000, IEC 60947-1
ABR1S, ABR2S	UL E164353, CSA 044087_S_000, IEC 60947-1

- ABR1 relays are RoHS compliant.
- For Mounting Track, see page .

[3] RoHS Compliant  
[4] Dimensions mounted on DIN 3 (7.5 mm high) track.

# Section 24

## Terminal Blocks

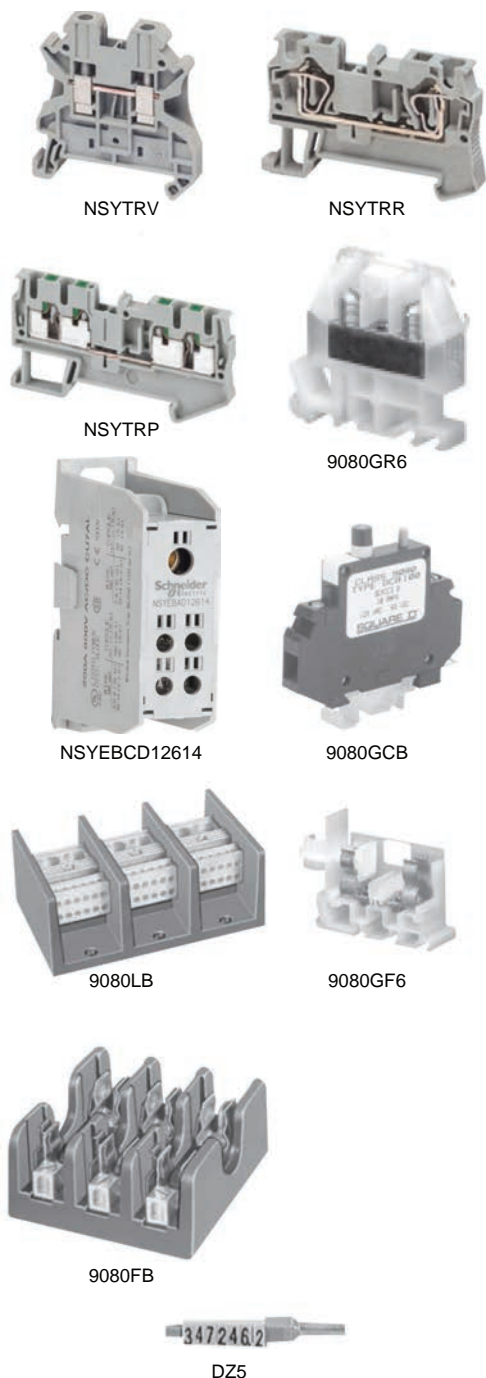







<b>Selection Guide</b>	<b>24-1</b>
Terminal Block Selection Guide	24-1
<b>IEC Style Terminal Blocks</b>	<b>24-3</b>
Spring Terminal Blocks	24-3
Passthrough	24-3
Grounding	24-4
Double and Triple Deck, Grounding, Component Carriers, Blade Isolators	24-5
Miniature Spring Passthrough and Grounding	24-6
Screw Terminal Blocks	24-7
Passthrough and Grounding	24-7
Lug/Lug, Double and Triple Deck Passthrough, Grounding	24-9
Blade Isolators, Component Carriers, Fused, Measuring, Grounding	24-10
Miniature Passthrough and Hybrid Passthrough	24-11
Push-in Terminal Blocks	24-12
Passthrough and Grounding	24-13
Double Deck Passthrough, Blade Isolators, Component Carriers	24-15
Accessories	24-16
Lineage Marking Accessories	24-16
Lineage Labeling System	24-17
Mounting Track and End Clamps	24-18
<b>NEMA Style Terminal Blocks</b>	<b>24-19</b>
Type G Terminal Blocks	24-19
Selection Guide	24-19
Terminal Block Assemblies	24-21
Type G Terminal Block Accessories	24-22
Mounting Track, End Clamps, Jumpers, Fanning Strips	24-22
Marking Accessories	24-23
<b>Thermal-Magnetic Circuit Protectors</b>	<b>24-24</b>
Type GCB Circuit Protectors	24-24
Type GB2 Circuit Protectors	24-25
<b>Power Distribution Blocks</b>	<b>24-26</b>
IEC NSYEB Power Distribution Blocks	24-26
Enclosed Power Distribution Blocks	24-26
NEMA Type LB Power Distribution Blocks	24-27
Open Power Distribution Blocks	24-27
<b>Fuseholders</b>	<b>24-28</b>
Type FB Fuseholders	24-28
TeSys DF Fuseholders	24-29
<b>Cable Ends</b>	<b>24-30</b>
DZ5 and AZ5 Cable Ends	24-30
AR1 and AT1 Cable End Accessories	24-31
<b>Advanteg TELEFAST™ 2</b>	<b>24-32</b>
Prewired Connection System	24-32

TERMINAL BLOCKS

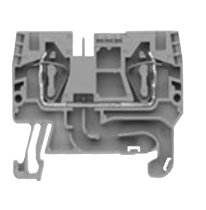
24

Terminal Block Panorama

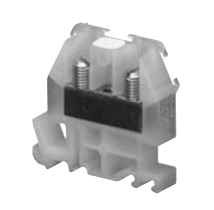









Table 24.1: Product Panorama

					
Product Family	NSYTRV	NSYTRR	NSYTRP	NSYTRH	9080G
Type of product	IEC screw technology	IEC spring technology	IEC push-in technology	IEC hybrid (screw and insulation displacement connection)	NEMA screw technology
Mounting	DIN 3	DIN 3	DIN 3	DIN 3	DIN 3 and Square D track <sup>[1]</sup>
Maximum rated voltage (V)	600	600	600	600	600 <sup>[2]</sup>
Maximum rated current per UL (A)	285	85	30	15	255
Ambient air temperature	-40 to +266 °F (-40 to 130 °C)				
Approvals <sup>[3]</sup>	 UL File E87739 CCN XCFR2	UL File E87739 CCN XCFR2	UL File E87729 CCN XCFR2	UL File E87729 CCN XCFR2	UL File E60616 CCN XCFR2
	 CSA File 25644 Class 6228-01	CSA File 25644 Class 6228-01	CSA File 25644 Class 6228-01	CSA File 25644 Class 6228-01	CSA File 25644 Class 6228-01
Color	Gray Blue Orange Red Green White Black Yellow Brown Green/Yellow	Gray Blue Orange Green/Yellow	Gray Blue Orange Green/Yellow	Gray Green/Yellow	Natural (White) Black Blue Green Gray Orange Red Yellow Brown
Conforming to Standards	RoHS CE	RoHS CE	RoHS CE	RoHS CE	RoHS CE

[1] 9080GK6 can be mounted directly to a panel or on Square D track.  
 [2] 9080GT6 is 120 V.  
 [3] Refer to catalogs 9080CT1301 and 9080CT9601 for a complete list of certifications.

**Passthrough**

**Table 24.2: Spring Passthrough Blocks**

Description	Maximum Voltage	Maximum Current	Block			End Barrier <sup>[1]</sup>		
			Color	Catalog Number	Std. Pack <sup>[2]</sup>	Color	Catalog Number	Std. Pack <sup>[2]</sup>
 Two Terminals Solid or Stranded Copper Wire 28–12 AWG 5.2 mm (0.21 in.) wide	600 V	20 A	Grey	NSYTRR22	50	Grey	NSYTRACR22	50
			Blue	NSYTRR22BL		Blue	NSYTRACR22BL	
			Orange	NSYTRR22AR		Grey	NSYTRACR22	
 Three Terminals Solid or Stranded Copper Wire 28–12 AWG 5.2 mm (0.21 in.) wide	600 V	20 A	Grey	NSYTRR23	50	Grey	NSYTRACR23	50
			Blue	NSYTRR23BL		Blue	NSYTRACR23BL	
			Orange	NSYTRR23AR		Grey	NSYTRACR23	
 Four Terminals Solid or Stranded Copper Wire 28–12 AWG 5.2 mm (0.21 in.) wide	600 V	20 A	Grey	NSYTRR24	50	Grey	NSYTRACR24	50
			Blue	NSYTRR24BL		Blue	NSYTRACR24BL	
			Orange	NSYTRR24AR		Grey	NSYTRACR24	
 Two Terminals Solid or Stranded Copper Wire 28–10 AWG 6.2 mm (0.24 in.) wide	600 V	30 A	Grey	NSYTRR42	50	Grey	NSYTRACR42	50
			Blue	NSYTRR42BL		Grey	NSYTRACR42	
			Orange	NSYTRR42AR		Grey	NSYTRACR42	
 Three Terminals Solid or Stranded Copper Wire 28–10 AWG 6.2 mm (0.24 in.) wide	600 V	30 A	Grey	NSYTRR43	50	Grey	NSYTRACR43	50
			Blue	NSYTRR43BL		Grey	NSYTRACR43	
 Four Terminals Solid or Stranded Copper Wire 28–10 AWG 6.2 mm (0.24 in.) wide	600 V	30 A	Grey	NSYTRR44	50	Grey	NSYTRACR44	50
			Blue	NSYTRR44BL		Grey	NSYTRACR44	
 Two Terminals Solid or Stranded Copper Wire 28–8 AWG 8.2 mm (0.32 in.) wide	600 V	50 A	Grey	NSYTRR62	50	Grey	NSYTRACR62	50
			Blue	NSYTRR62BL		Grey	NSYTRACR62	
 Three Terminals Solid or Stranded Copper Wire 24–8 AWG 8.2 mm (0.32 in.) wide	600 V	50 A	Grey	NSYTRR63	50	Grey	NSYTRACR63	50
 Two Terminals Solid or Stranded Copper Wire 16–6 AWG 10.2 mm (0.40 in.) wide	600 V	66 A	Grey	NSYTRR102	50	Grey	NSYTRACRR102	50
			Blue	NSYTRR102BL		Grey	NSYTRACRR102	
 Two Terminals Solid or Stranded Copper Wire 16–4 AWG 12.2 mm (0.48 in.) wide	600 V	85 A	Grey	NSYTRR162	50	Grey	NSYTRACR162	50
			Blue	NSYTRR162BL		Grey	NSYTRACR162	

**NOTE:** For a complete listing of these products, see catalog **9080CT1301**.



File:  
E87739  
CCN:  
XCFR2



File:  
256444  
Class:  
6228-01



RoHS  
Compliant

For track and accessories, see **Mounting Track and End Clamps**, page 24-18.

[1] One end-barrier is required for each assembly of like blocks.  
 [2] Orders must specify the standard package quantity (Std. Pack) or multiples of that quantity.

## Grounding

Table 24.3: Spring Grounding Blocks

Description	Block			End Barrier [3]		
	Color	Catalog Number	Std. Pack [4]	Color	Catalog Number	Std. Pack [4]
 Grounding Block Two Terminals Solid or Stranded Copper Wire 28–12 AWG 5.2 mm (0.21 in.) wide	Green / Yellow	NSYTRR22PE	50	Grey	NSYTRACR22	50
 Grounding Block Three Terminals Solid or Stranded Copper Wire 28–12 AWG 5.2 mm (0.21 in.) wide	Green / Yellow	NSYTRR23PE	50	Grey	NSYTRACR23	50
 Grounding Block Four Terminals Solid or Stranded Copper Wire 28–12 AWG 5.2 mm (0.21 in.) wide	Green / Yellow	NSYTRR24PE	50	Grey	NSYTRACR24	50
 Grounding Block Two Terminals Solid or Stranded Copper Wire 28–10 AWG 6.2 mm (0.24 in.) wide	Green / Yellow	NSYTRR42PE	50	Grey	NSYTRACR42	50
 Grounding Block Three Terminals Solid or Stranded Copper Wire 28–10 AWG 6.2 mm (0.24 in.) wide	Green / Yellow	NSYTRR43PE	50	Grey	NSYTRACR43	50
 Grounding Block Four Terminals Solid or Stranded Copper Wire 28–10 AWG 6.2 mm (0.24 in.) wide	Green / Yellow	NSYTRR44PE	50	Grey	NSYTRACR44	50
 Grounding Block Two Terminals Solid or Stranded Copper Wire 24–8 AWG 8.2 mm (0.32 in.) wide	Green / Yellow	NSYTRR62PE	50	Grey	NSYTRACR62	50
 Grounding Block Two Terminals Solid or Stranded Copper Wire 16–6 AWG 10.2 mm (0.40 in.) wide	Green / Yellow	NSYTRR102PE	50	Grey	NSYTRACR102	50
 Grounding Block Two Terminals Solid or Stranded Copper Wire 16–4 AWG 12.2 mm (0.48 in.) wide	Green / Yellow	NSYTRR162PE	50	Grey	NSYTRACR162	10

NOTE: For a complete listing of these products, see catalog 9080CT1301.



File:  
E87739  
CCN:  
XCFR2



File:  
256444  
Class:  
6228-01



RoHS  
Compliant

For track and accessories, see [Mounting Track and End Clamps](#), page 24-18.



[3] One end-barrier is required for each assembly of like blocks.

[4] Orders must specify the standard package quantity (Std. Pack) or multiples of that quantity.





**Double and Triple Deck, Grounding, Component Carriers, Blade Isolators**



**Table 24.4: Spring Double and Triple Deck Passthrough**

Description	Max. Voltage	Max. Current [5]	Block			End Barrier [6]		
			Color	Catalog Number	Std. Pack [7]	Color	Catalog Number	Std. Pack [7]
 5.2 mm (0.21 in.) wide	600 V	20 A	Grey	NSYTRR24D	50	Grey	NSYTRACRE24	50
			Blue	NSYTRR24DBL		Grey	NSYTRACRE24	
 6.2 mm (0.24 in.) wide	600 V	30 A	Grey	NSYTRR44D	50	Grey	NSYTRACRE44	50
			Blue	NSYTRR44DBL		Grey	NSYTRACRE44	
 5.2 mm (0.21 in.) wide	600 V	20 A	Grey	NSYTRR26T	50	Grey	NSYTRACRE26	50
			Blue	NSYTRR26TBL		Grey	NSYTRACRE26	



**Table 24.5: Spring Grounding Double Deck**

Description	Block			End Barrier [6]		
	Color	Catalog Number	Std. Pack [7]	Color	Catalog Number	Std. Pack [7]
 5.2 mm (0.21 in.) wide	Green/Yellow	NSYTRR24DPE	50	Grey	NSYTRACRE24	50
 6.2 mm (0.24 in.) wide	Green/Yellow	NSYTRR44DPE	50	Grey	NSYTRACRE44	50

**Table 24.6: Spring Component Carriers**

Description	Max. Voltage	Max. Current [5]	Color	Catalog Number	Std. Pack [7]	End Barrier [6]				
						Color	Catalog Number	Std. Pack [7]		
 5.2 mm (0.21 in.) wide	300 V	16 A	Grey	NSYTRR22TB	50	Grey	NSYTRACR23	50		
				Depends on fuse or diode used	Black				NSYTRASF520	10
					Black				NSYTRASF520M	10
					Black				NSYTRASF520B	10
				Grey	NSYTRASV1				10	
				Grey	NSYTRASV2				10	
 5.2 mm (0.21 in.) wide	300 V	16 A	Grey	NSYTRR23TB	50	Grey	NSYTRACR24	50		
				Depends on fuse or diode used	Black				NSYTRASF520	10
					Black				NSYTRASF520M	10
					Black				NSYTRASF520B	10
				Grey	NSYTRASV1				10	
				Grey	NSYTRASV2				10	

**Table 24.7: Spring Blade Isolators**

Description	Max. Voltage	Max. Current [5]	Block			End Barrier [6]		
			Color	Catalog Number	Std. Pack [7]	Color	Catalog Number	Std. Pack [7]
 5.2 mm (0.21 in.) wide	600 V	16 A	Grey	NSYTRR22SC	50	Grey	NSYTRACR23	50
			Orange	NSYTRR22SCAR		Grey	NSYTACR23	
 5.2 mm (0.21 in.) wide	600 V	16 A	Grey	NSYTRR23SC	50	Grey	NSYTACR24	50
			Orange	NSYTRR23SCAR		Grey	NSYTACR24	
 5.2 mm (0.21 in.) wide	300 V	10 A	Grey	NSYTRR24SCD	50	Not required for this block.		

**NOTE:** For a complete listing of these products, see catalog 9080CT1301.



File: E87739  
CCN: XCFR2



File: 256444  
Class: 6228-01



RoHS Compliant

For track and accessories, see [Mounting Track and End Clamps](#), page 24-18.

[5] These maximum current values assume the use of insulated copper conductors with 167 °F (75 °C) temperature rating and are calculated based on NEC Article 310, Table 310-16. In most cases this value is the maximum ampacity of the wire which has the greatest current carrying capacity. The actual allowable current for a particular application depends on the size, insulation class, and other characteristics of the wire used. The UL ratings are shown. The CSA rating may be higher or lower. Refer to the catalog for CSA ratings.

[6] One end-barrier is required for each assembly of like blocks.

[7] Orders must specify the standard package quantity (Std. Pack) or multiples of that quantity.

## Miniature Spring Passthrough and Grounding

Table 24.8: Miniature Spring Passthrough DIN Rail Mounting



Description	Maximum Voltage	Maximum Current [8]	Block			End Barrier [9]		
			Color	Catalog Number	Std. Pack [10]	Color	Catalog Number	Std. Pack [10]
 5.2 mm (0.21 in.) wide Two Terminals Solid or Stranded Copper Wire 28–12 AWG Mount on DIN Rail 15 x 7.2 mm	600 V	20 A	Grey	NSYTRR22M	50	Grey	NSYTRACRM22	50
			Blue	NSYTRR22MBL		Grey	NSYTRACRM22	
 10.4 mm (0.41 in.) wide Four Terminals Solid or Stranded Copper Wire 28–12 AWG Mount on DIN Rail 15 x 7.2 mm	600 V	20 A	Grey	NSYTRR24M	50	Grey	NSYTRACRM22	50
			Blue	NSYTRR24MBL		Grey	NSYTRACRM22	

Table 24.9: Miniature Spring Grounding Type



Description	Block			End Barrier [9]		
	Color	Catalog Number	Std. Pack [10]	Color	Catalog Number	Std. Pack [10]
 5.2 mm (0.21 in.) wide Grounding Block, Two Terminals, Solid or Stranded Copper Wire 28–12 AWG Mount on DIN Rail 15 x 7.2 mm	Green/Yellow	NSYTRR22MPE	50	Grey	NSYTRACRM22	50

Table 24.10: Miniature Spring Passthrough Direct Mounting and for Micro-Perforated Mounting Plates

Description	Maximum Voltage	Maximum Current [8]	Block			End Barrier [9]		
			Color	Catalog Number	Std. Pack [10]	Color	Catalog Number	Std. Pack [10]
 5.2 mm (0.21 in.) wide Direct Mounting (Flange) Two Terminals Solid or Stranded Copper Wire 28–12 AWG	600 V	20 A	Grey	NSYTRR22MF	50	Grey	NSYTRACRM22	50
			Blue	NSYTRR22MFBL		Grey	NSYTRACRM22	
			Grey	NSYTRR22MFF [11]		Grey	NSYTRACRM22 or NSYTRACRMF22 [11]	
 10.4 mm (0.41 in.) wide Direct Mounting (Flange) Four Terminals Solid or Stranded Copper Wire 28–12 AWG	600 V	20 A	Grey	NSYTRR24MF	50	Grey	NSYTRACRM22	50
			Blue	NSYTRR24MFBL		Grey	NSYTRACRM22	
			Grey	NSYTRR24MFF [11]		Grey	NSYTRACRM22 or NSYTRACRMF22 [11]	
 5.2 mm (0.21 in.) wide For Micro-Perforated Mounting Plates Two Terminals Solid or Stranded Copper Wire 28–12 AWG	600 V	20 A	Grey	NSYTRR22MP	50	Grey	NSYTRACRM22	50
			Blue	NSYTRR22MPBL		Grey	NSYTRACRM22	
 10.4 mm (0.41 in.) wide For Micro-Perforated Mounting Plates Four Terminals Solid or Stranded Copper Wire 28–12 AWG	600 V	20 A	Grey	NSYTRR24MP	50	Grey	NSYTRACRM22	50
			Blue	NSYTRR24MBL		Grey	NSYTRACRM22	

NOTE: For a complete listing of these products, see catalog 9080CT1301.



File: E87739, CCN: XCFR2



File: 256444, Class: 6228-01



RoHS Compliant

For track and accessories, see [Mounting Track and End Clamps](#), page 24-18.

[8] These maximum current values assume the use of insulated copper conductors with 167 °F (75 °C) temperature rating and are calculated based on NEC Article 310, Table 310-16. In most cases this value is the maximum ampacity of the wire which has the greatest current carrying capacity. The actual allowable current for a particular application depends on the size, insulation class, and other characteristics of the wire used. The UL ratings are shown. The CSA rating may be higher or lower. Refer to the catalog for CSA ratings.

[9] One end-barrier is required for each assembly of like blocks.

[10] Orders must specify the standard package quantity (Std. Pack) or multiples of that quantity.

[11] With flange. Can only be used at the end of a group of terminals.

**Passthrough and Grounding**

**Table 24.11: Screw Type Passthrough Blocks**

Description	Maximum Voltage	Maximum Current [12]	Block			End Barrier [13]		
			Color	Catalog Number	Std. Pack [14]	Color	Catalog Number	Std. Pack [14]
 5.2 mm (0.21 in.) wide Two Terminals Solid or Stranded Copper Wire 26–12 AWG	600 V	20 A	Grey	NSYTRV22	50	Grey	NSYTRAC22	50
			Blue	NSYTRV22BL		Blue	NSYTRAC22BL	
			Orange	NSYTRV22AR		Grey	NSYTRAC22	
			Red	NSYTRV22RD		Grey	NSYTRAC22	
			White	NSYTRV22WH		Grey	NSYTRAC22	
 6.2 mm (0.24 in.) wide Two Terminals Solid or Stranded Copper Wire 26–10 AWG	600 V	00 A	Grey	NSYTRV42	50	Grey	NSYTRAC22	50
			Blue	NSYTRV42BL		Blue	NSYTRAC22BL	
			Orange	NSYTRV42AR		Grey	NSYTRAC22	
			Red	NSYTRV42RD		Grey	NSYTRAC22	
			Green	NSYTRV42GN		Grey	NSYTRAC22	
			White	NSYTRV42WH		Grey	NSYTRAC22	
			Black	NSYTRV42BK		Grey	NSYTRAC22	
			Brown	NSYTRV42BR		Grey	NSYTRAC22	
			Yellow	NSYTRV42YE		Grey	NSYTRAC22	
			 8.2 mm (0.32 in.) wide Two Terminals Solid or Stranded Copper Wire 24–8 AWG	600 V		50 A	Grey	
Blue	NSYTRV62BL	Blue			NSYTRAC22BL			
 10.2 mm (0.40 in.) wide Two Terminals Solid or Stranded Copper Wire 20–6 AWG	600 V	65 A	Grey	NSYTRV102	50	Grey	NSYTRAC22	50
			Blue	NSYTRV102BL		Blue	NSYTRAC22BL	
 12.2 mm (0.48 in.) wide Two Terminals Solid or Stranded Copper Wire 16–4 AWG	600 V	85 A	Grey	NSYTRV162	50	Grey	NSYTRAC162	50
			Blue	NSYTRV162BL		Grey	NSYTRAC162	
 16 mm (0.63 in.) wide Two Terminals Solid or Stranded Copper Wire 14–1/0 AWG	600 V	150 A	Grey	NSYTRV352	50	Not required for these blocks.		
			Blue	NSYTRV352BL				
 20 mm (0.79 in.) wide Two Terminals Solid or Stranded Copper Wire 6–1/0 AWG	600 V	150 A	Grey	NSYTRV502	50	Not required for these blocks.		
			Blue	NSYTRV502BL				

TERMINAL BLOCKS

24

**NOTE:** For a complete listing of these products, see catalog [9080CT1301](#).



File: E87739; CCN: XCFR2



File: 256444; Class: 6228-01



RoHS Compliant

For track and accessories, see [page 24-18](#).

[12] These maximum current values assume the use of insulated copper conductors with 167 °F (75 °C) temperature rating and are calculated based on NEC Article 310, Table 310-16. In most cases this value is the maximum ampacity of the wire which has the greatest current carrying capacity. The actual allowable current for a particular application depends on the size, insulation class, and other characteristics of the wire used. The UL ratings are shown. The CSA rating may be higher or lower. Refer to the catalog for CSA ratings.

[13] One end-barrier is required for each assembly of like blocks.

[14] Orders must specify the standard package quantity (Std. Pack) or multiples of that quantity.

Table 24.12: Screw Type Grounding Blocks

Description	Block			End Barrier [15]		
	Color	Catalog Number	Std. Pack [16]	Color	Catalog Number	Std. Pack [16]
 5.2 mm (0.21 in.) wide Two Terminals, Solid or Stranded Copper Wire, 26–12 AWG	Green/Yellow	NSYTRV22PE	50	Grey	NSYTRAC22	50
 6.2 mm (0.24 in.) wide Two Terminals, Solid or Stranded Copper Wire, 26–10 AWG	Green/Yellow	NSYTRV42PE	50	Grey	NSYTRAC22	50
 8.2 mm (0.32 in.) wide Two Terminals, Solid or Stranded Copper Wire, 24–8 AWG	Green/Yellow	NSYTRV62PE	50	Grey	NSYTRAC22	50
 10.2 mm (0.40 in.) wide Two Terminals, Solid or Stranded Copper Wire, 20–6 AWG	Green/Yellow	NSYTRV102PE	50	Grey	NSYTRAC22	50
 12.2 mm (0.48 in.) wide Grounding Block, Two Terminals, Solid or Stranded Copper Wire, 16–4 AWG	Green/Yellow	NSYTRV162PE	50	Grey	NSYTRAC162	50
 16 mm (0.63 in.) wide Two Terminals, Solid or Stranded Copper Wire, 14–1/0 AWG	Green/Yellow	NSYTRV352PE	50	Not required for this block.		
 20 mm (0.79 in.) wide Two Terminals, Solid or Stranded Copper Wire, 6–1/0 AWG	Green/Yellow	NSYTRV502PE	50	Not required for this block.		

**NOTE:** For a complete listing of these products, see catalog 9080CT1301.



File: E87739; CCN: XCFR2



File: 256444; Class: 6228-01



RoHS Compliant





For track and accessories, see page 24-18.

[15] One end-barrier is required for each assembly of like blocks.

[16] Orders must specify the standard package quantity (Std. Pack) or multiples of that quantity.

**Lug/Lug, Double and Triple Deck Passthrough, Grounding**





**Table 24.13: Passthrough, Lug/Lug, and Lug/Clamp**

Description	Block				Partition Cover		
	Maximum Current <sup>[17]</sup>	Color	Catalog Number	Std. Pack <sup>[18]</sup>	Color	Catalog Number	Std. Pack <sup>[18]</sup>
 20.3 mm (0.80 in.) wide Passthrough Solid or Stranded Copper Wire 4–3/0 AWG Screw thread M8 Maximum Voltage–600 V	192 A	Grey	NSYTRV702	10	Not required for this block.		
 40 mm (1.58 in.) wide Lug to Lug Solid or Stranded Copper Wire 2–4/0 AWG Screw thread M12 Maximum Voltage–600 V	230 A	Grey	NSYTRV952BB	10	Grey	NSYTRAC952	10
 40 mm (1.58 in.) wide Solid or Stranded Copper Wire 2–4/0 AWG Screw thread M12 Maximum Voltage–600 V	230 A	Grey	NSYTRV952BC	10	Grey	NSYTRAC952	10
 46 mm (1.81 in.) wide Lug to Lug Solid or Stranded Copper Wire 2–300 AWG/kcmil Screw thread M12 Maximum Voltage–600 V	285 A	Grey	NSYTRV1502BB	10	Grey	NSYTRAC952	10

**Table 24.14: Screw Type Double and Triple Deck Passthrough**

Description	Maximum Voltage	Maximum Current <sup>[17]</sup>	Block			End Barrier <sup>[19]</sup>		
			Color	Catalog Number	Std. Pack <sup>[18]</sup>	Color	Catalog Number	Std. Pack <sup>[18]</sup>
 6.2 mm (0.24 in.) wide Double Deck, One Pole, Three Terminals Solid or Stranded Copper Wire 26–10 AWG	150 V	30 A	Grey	NSYTRV43	50	Grey	NSYTRAC23	50
			Blue	NSYTRV43BL		Grey	NSYTRAC23	
 6.2 mm (0.24 in.) wide Double Deck, One Pole, Four Terminals Solid or Stranded Copper Wire 26–10 AWG	150 V	30 A	Grey	NSYTRV44	50	Grey	NSYTRAC24	50
			Blue	NSYTRV44BL		Grey	NSYTRAC24	
 5.2 mm (0.21 in.) wide Double Deck, Two Poles, Four Terminals Solid or Stranded Copper Wire 26–12 AWG	600 V	20 A	Grey	NSYTRV24D	50	Grey	NSYTRACE24	50
			Blue	NSYTRV24DBL		Grey	NSYTRACE24	
 6.2 mm (0.24 in.) wide Double Deck, Two Poles, Four Terminals Solid or Stranded Copper Wire 26–10 AWG	600 V	30 A	Grey	NSYTRV44D	50	Grey	NSYTRACE24	50
			Blue	NSYTRV44DBL		Grey	NSYTRACE24	
 5.2 mm (0.21 in.) wide Triple Deck, Three Poles, Six Terminals Solid or Stranded Copper Wire 26–10 AWG	600 V	20 A	Grey	NSYTRV26T	50	Grey	NSYTRACE26	50

**Table 24.15: Screw Type Grounding Double Deck**

Description	Block			End Barrier <sup>[19]</sup>		
	Color	Catalog Number	Std. Pack <sup>[18]</sup>	Color	Catalog Number	Std. Pack <sup>[18]</sup>
 6.2 mm (0.24 in.) wide Grounding Block, One Pole, Three Terminals Solid or Stranded Copper Wire 26–12 AWG	Green/Yellow	NSYTRV43PE	50	Grey	NSYTRAC23	50
 6.2 mm (0.24 in.) wide Grounding Block, One Pole, Four Terminals Solid or Stranded Copper Wire 26–12 AWG	Green/Yellow	NSYTRV44PE	50	Grey	NSYTRAC24	50
 5.2 mm (0.21 in.) wide Grounding Block, One Pole, Four Terminals Solid or Stranded Copper Wire 26–12 AWG	Green/Yellow	NSYTRV24DPE	50	Grey	NSYTRACE24	50
 6.2 mm (0.24 in.) wide Grounding Block, One Pole, Four Terminals Solid or Stranded Copper Wire 26–10 AWG	Green/Yellow	NSYTRV44DPE	50	Grey	NSYTRACE24	50

**NOTE:** For a complete listing of these products, see catalog 9080CT1301.



File: E87739  
CCN: XCFR2



File: 256444  
Class: 6228-01



RoHS Compliant

For track and accessories, see page 24-18.

[17] These maximum current values assume the use of insulated copper conductors with 167 °F (75 °C) temperature rating and are calculated based on NEC Article 310, Table 310-16. In most cases this value is the maximum ampacity of the wire which has the greatest current carrying capacity. The actual allowable current for a particular application depends on the size, insulation class, and other characteristics of the wire used. The UL ratings are shown. The CSA rating may be higher or lower. Refer to the catalog for CSA ratings.

[18] Orders must specify the standard package quantity (Std. Pack) or multiples of that quantity.

[19] One end-barrier is required for each assembly of like blocks.

Blade Isolators, Component Carriers, Fused, Measuring,  
Grounding

Table 24.16: Screw Type Blade Isolators



Description	Maximum Voltage	Maximum Current [20]	Block			End Barrier [21]		
			Color	Catalog Number	Std. Pack [22]	Color	Catalog Number	Std. Pack [22]
 6.2 mm (0.24 in.) wide Blade Isolator Two Terminals Solid or Stranded Copper Wire 26–10 AWG	600 V	16 A	Grey	NSYTRV42SC	50	Not required for this block.		
			Grey with Test Points	NSYTRV42ST				
			Orange with Test Points	NSYTRV42STAR				
 6.2 mm (0.24 in.) wide Blade Isolator Double Deck Four Terminals Solid or Stranded Copper Wire 26–10 AWG	300 V	30 A	Grey	NSYTRV42SCD	50	Grey	NSYTRACE24	50

Table 24.17: Screw Type Component Carrier







Description	Maximum Voltage	Maximum Current [20]	Color	Catalog Number	Std. Pack [22]	End Barrier [21]					
 6.2 mm (0.24 in.) wide Component Carrier Two Terminals Solid or Stranded Copper Wire 26–10 AWG	600 V	16 A	Grey	NSYTRV42TB	50	Not required for this block					
							Depends on fuse or diode used	Black	NSYTRASF520	10	Not required
								Black	NSYTRASF520M	10	
								Black	NSYTRASF520B	10	
							Grey	NSYTRASV1	10	Not required	
							Grey	NSYTRASV2	10		

Table 24.18: Fused Terminal Blocks

Description	Maximum Voltage	Maximum Current [20]	Color	Catalog Number	Std. Pack [22]	End Barrier [21]			
						Color	Catalog Number	Std. Pack [22]	
 12 mm (0.47 in.) wide Fuse Block For G-fuse cartridge 5x20 mm Solid or Stranded Copper Wire 24–6 AWG Maximum Voltage 300 V Maximum Current 20 A [20]	600 V	16 A	Without Indicator Lamp	Black	NSYTRV162SF	50	Not required for this block.		
 8.2 mm (0.32 in.) wide Lever-Type Fuse For G-fuse cartridge 5x20 mm Solid or Stranded Copper Wire 26–10 AWG Maximum Voltage 600 V Maximum Current 12 A [20]			Without Indicator Lamp	Black	NSYTRV42SF5	50	Not required for this block.		
			With Light Indicator, 12–30 V AC/DC [23]	Black	NSYTRV42SF5LD	50			
 10.2 mm (0.40 in.) wide Lever-Type Fuse For G-fuse cartridge 6.3x32 mm Solid or Stranded Copper Wire 26–8 AWG Maximum Voltage 600 V Maximum Current 10 A [20]	Without Indicator Lamp	Black	NSYTRV42SF6	50	Not required for this block.				
	With Light Indicator, 110–250 V AC/DC [23]	Black	NSYTRV42SF5LA	50					
	With Light Indicator, 12–30 V AC/DC [23]	Black	NSYTRV42SF6LD	50					
 10.2 mm (0.40 in.) wide Lever-Type Fuse For G-fuse cartridge 6.3x32 mm Solid or Stranded Copper Wire 26–8 AWG Maximum Voltage 600 V Maximum Current 10 A [20]	Without Indicator Lamp	Black	NSYTRV42SF6	50	Not required for this block.				
	With Light Indicator, 110–250 V AC/DC [23]	Black	NSYTRV42SF6LA	50					

These measuring transducer terminal blocks with screw connection technology are characterized by easy operation and clarity. All switching statuses are clearly visible. The extensive range of flexible accessories saves cost and time when executing transducer test circuit tasks.

Table 24.19: Measuring and Grounding Terminal Blocks

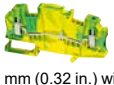
Description	Maximum Voltage	Maximum Current [20]	Block			End Barrier [21]					
			Color	Catalog Number	Std. Pack [22]	Color	Catalog Number	Std. Pack [22]			
 8.2 mm (0.32 in.) wide Blade Isolator Double Deck Solid or Stranded Copper Wire 24–8 AWG	600 V	30 A	Grey	NSYTRV62TTD	50	Not required for this block.					
 8.2 mm (0.32 in.) wide Passthrough Two Terminals Solid or Stranded Copper Wire 24–8 AWG									Grey	NSYTRACT22	50
 8.2 mm (0.32 in.) wide Grounding Block Two Terminals Solid or Stranded Copper Wire 24–8 AWG									N/A	N/A	Green/Yellow

NOTE: For a complete listing of these products, see catalog 9080CT1301.



File:  
E87739  
CCN:  
XCFR2



File:  
256444  
Class:  
6228-01



RoHS  
Compliant

For track and accessories, see [Mounting Track and End Clamps](#), page 24-18.

[20] These maximum current values assume the use of insulated copper conductors with 167 °F (75 °C) temperature rating and are calculated based on NEC Article 310, Table 310-16. In most cases this value is the maximum ampacity of the wire which has the greatest current carrying capacity. The actual allowable current for a particular application depends on the size, insulation class, and other characteristics of the wire used. The UL ratings are shown. The CSA rating may be higher or lower. Refer to the catalog for CSA ratings.



[21] One end-barrier is required for each assembly of like blocks.

[22] Orders must specify the standard package quantity (Std. Pack) or multiples of that quantity.



[23] When voltage is applied within the minimum and maximum limits, the LED will illuminate.

**Miniature Passthrough and Hybrid Passthrough**

**Table 24.20: Screw Type Miniature Passthrough**

Description	Maximum Voltage	Maximum Current [24]	Block			End Barrier [25]		
			Color	Catalog Number	Std. Pack [26]	Color	Catalog Number	Std. Pack [26]
 5.2 mm (0.21 in.) wide Two Terminals Solid or Stranded Copper Wire 24–12 AWG Mount on DIN rail, 5 x 5 mm	600 V	20 A	Grey	NSYTRV22M	50	Grey	NSYTRACM22	50
			Blue	NSYTRV22MBL		Grey	NSYTRACM22	
 6.2 mm (0.24 in.) wide Two Terminals Solid or Stranded Copper Wire 24–10 AWG Mount on DIN rail, 5 x 5 mm	600 V	30 A	Grey	NSYTRV42M	50	Grey	NSYTRACM22	50
			Blue	NSYTRV42MBL		Grey	NSYTRACM22	

**Table 24.21: Screw Type Miniature Grounding Blocks**

Description	Block			End Barrier [25]		
	Color	Catalog Number	Std. Pack [26]	Color	Catalog Number	Std. Pack [26]
 5.2 mm (0.21 in.) wide Grounding Block Two Terminals Solid or Stranded Copper Wire 24–12 AWG Mount on DIN rail, 5 x 5 mm	Green/Yellow	NSYTRV22MPE	50	Grey	NSYTRACM22	50
 6.2 mm (0.24 in.) wide Grounding Block Two Terminals Solid or Stranded Copper Wire 24–10 AWG Mount on DIN rail, 5 x 5 mm	Green/Yellow	NSYTRV42MPE	50	Grey	NSYTRACM22	50

**NOTE:** For a complete listing of these products, see catalog [9080CT1301](#).



File:  
E87739  
CCN:  
XCFR2



File:  
256444  
Class:  
6228-01



RoHS  
Compliant

For track and accessories, see [Mounting Track and End Clamps, page 24-18](#).

[24] These maximum current values assume the use of insulated copper conductors with 167 °F (75 °C) temperature rating and are calculated based on NEC Article 310, Table 310-16. In most cases this value is the maximum ampacity of the wire which has the greatest current carrying capacity. The actual allowable current for a particular application depends on the size, insulation class, and other characteristics of the wire used. The UL ratings are shown. The CSA rating may be higher or lower. Refer to the catalog for CSA ratings.

[25] One end-barrier is required for each assembly of like blocks.

[26] Orders must specify the standard package quantity (Std. Pack) or multiples of that quantity.

Table 24.22: Hybrid Blocks—Screw and Insulation Displacement Connection (IDC) Passthrough





Description	Maximum Voltage	Maximum Current [27]	Block			End Barrier [28]		
			Color	Catalog Number	Std. Pack [29]	Color	Catalog Number	Std. Pack [29]
 Two Terminals Solid or Stranded Copper Wire 24–16 AWG 5.2 mm (0.21 in.) wide	600 V	10 A	Grey	NSYTRH12	50	Grey	NSYTRACH12	50
 Three Terminals Solid or Stranded Copper Wire 24–16 AWG 5.2 mm (0.21 in.) wide	600 V	10 A	Grey	NSYTRH13	50	Grey	NSYTRACH13	50
 Three Terminals Solid or Stranded Copper Wire 20–14 AWG 6.2 mm (0.24 in.) wide	600 V	15 A	Grey	NSYTRH22	50	Grey	NSYTRACH22	50

Table 24.23: Hybrid Grounding Block—Screw and Insulation Displacement Connection (IDC) Passthrough

Description	Block			End Barrier [28]		
	Color	Catalog Number	Std. Pack [29]	Color	Catalog Number	Std. Pack [29]
 Grounding Block Two Terminals Solid or Stranded Copper Wire 24–16 AWG 5.2 mm (0.21 in.) wide	Green/Yellow	NSYTRH12PE	50	Grey	NSYTRACH12	50

NOTE: For a complete listing of these products, see catalog 9080CT1301.



File:  
E87739  
CCN:  
XCFR2



File:  
256444  
Class:  
6228-01



RoHS  
Compliant

For track and accessories, see [Mounting Track and End Clamps](#), page 24-18.

[27] These maximum current values assume the use of insulated copper conductors with 167 °F (75 °C) temperature rating and are calculated based on NEC Article 310, Table 310-16. In most cases this value is the maximum ampacity of the wire which has the greatest current carrying capacity. The actual allowable current for a particular application depends on the size, insulation class, and other characteristics of the wire used. The UL ratings are shown. The CSA rating may be higher or lower. Refer to the catalog for CSA ratings.

[28] One end-barrier is required for each assembly of like blocks.





[29] Orders must specify the standard package quantity (Std. Pack) or multiples of that quantity.



**Passthrough and Grounding**

Push-in technology terminal blocks feature simple handling and direct, tool-free connections. When pushing in solid wires or wires with ferrules, the contact spring is automatically opened and ensures the required pressure force against the current bar.

**Table 24.24: Push-in Passthrough Blocks**

Description	Maximum Voltage	Maximum Current [30]	Block			End Barrier [31]		
			Color	Catalog Number	Std. Pack [32]	Color	Catalog Number	Std. Pack [32]
 Two Terminals Solid or Stranded Copper Wire 24–12 AWG 5.2 mm (0.21 in.) wide	600 V	20 A	Grey	NSYTRP22	50	Grey	NSYTRACR22	50
			Blue	NSYTRP22BL		Blue	NSYTRACR22BL	
			Orange	NSYTRP22AR		Grey	NSYTRACR22	
 Three Terminals Solid or Stranded Copper Wire 24–12 AWG 5.2 mm (0.21 in.) wide	600 V	20 A	Grey	NSYTRP23	50	Grey	NSYTRACR23	50
			Blue	NSYTRP23BL		Blue	NSYTRACR23BL	
			Orange	NSYTRP23AR		Grey	NSYTRACR23	
 Four Terminals Solid or Stranded Copper Wire 24–12 AWG 5.2 mm (0.21 in.) wide	600 V	20 A	Grey	NSYTRP24	50	Grey	NSYTRACR24	50
			Blue	NSYTRP24BL		Blue	NSYTRACR24BL	
 Two Terminals Solid or Stranded Copper Wire 24–10 AWG 6.2 mm (0.24 in.) wide	600 V	30 A	Grey	NSYTRP42	50	Grey	NSYTRACR42	50
			Blue	NSYTRP42BL		Grey	NSYTRACR42	
 Three Terminals Solid or Stranded Copper Wire 24–10 AWG 6.2 mm (0.24 in.) wide	600 V	30 A	Grey	NSYTRP43	50	Grey	NSYTRACP43	50
			Blue	NSYTRP43BL		Grey	NSYTRACP43	
 Four Terminals Solid or Stranded Copper Wire 24–10 AWG 6.2 mm (0.24 in.) wide	600 V	30 A	Grey	NSYTRP44	50	Grey	NSYTRACP44	50
			Blue	NSYTRP44BL		Grey	NSYTRACP44	

**NOTE:** For a complete listing of these products, see catalog [9080CT1301](#).



File:  
E87739  
CCN:  
XCFR2



File:  
256444  
Class:  
6228-01



RoHS  
Compliant







For track and accessories, see [Mounting Track and End Clamps, page 24-18](#).

TERMINAL BLOCKS

24

[30] These maximum current values assume the use of insulated copper conductors with 167 °F (75 °C) temperature rating and are calculated based on NEC Article 310, Table 310-16. In most cases this value is the maximum ampacity of the wire which has the greatest current carrying capacity. The actual allowable current for a particular application depends on the size, insulation class, and other characteristics of the wire used. The UL ratings are shown. The CSA rating may be higher or lower. Refer to the catalog for CSA ratings.  
 [31] One end-barrier is required for each assembly of like blocks.  
 [32] Orders must specify the standard package quantity (Std. Pack) or multiples of that quantity.

Table 24.25: Push-in Grounding Blocks

Description	Block			End Barrier [33]		
	Color	Catalog Number	Std. Pack [34]	Color	Catalog Number	Std. Pack [34]
 5.2 mm (0.21 in.) wide Grounding Block Two Terminals Solid or Stranded Copper Wire 24–12 AWG	Green/Yellow	NSYTRP22PE	50	Grey	NSYTRACR22	50
 5.2 mm (0.21 in.) wide Grounding Block Three Terminals Solid or Stranded Copper Wire 24–12 AWG	Green/Yellow	NSYTRP23PE	50	Grey	NSYTRACR23	50
 5.2 mm (0.21 in.) wide Grounding Block Four Terminals Solid or Stranded Copper Wire 24–12 AWG	Green/Yellow	NSYTRP24PE	50	Grey	NSYTRACR24	50
 6.2 mm (0.24 in.) wide Grounding Block Two Terminals Solid or Stranded Copper Wire 24–10 AWG	Green/Yellow	NSYTRP42PE	50	Grey	NSYTRACR42	50
 6.2 mm (0.24 in.) wide Grounding Block Three Terminals Solid or Stranded Copper Wire 24–10 AWG	Green/Yellow	NSYTRP43PE	50	Grey	NSYTRACP43	50
 6.2 mm (0.24 in.) wide Grounding Block Four Terminals Solid or Stranded Copper Wire 24–10 AWG	Green/Yellow	NSYTRP44PE	50	Grey	NSYTRACP44	50

NOTE: For a complete listing of these products, see catalog 9080CT1301.



File:  
E87739  
CCN:  
XCFR2



File:  
702070  
Class:  
6228-01



RoHS  
Compliant



For track and accessories, see [Mounting Track and End Clamps](#), page 24-18.

[33] One end-barrier is required for each assembly of like blocks.



[34] Orders must specify the standard package quantity (Std. Pack) or multiples of that quantity.

**Double Deck Passthrough, Blade Isolators, Component Carriers**



**Table 24.26: Push-in Double Deck Passthrough and Grounding Terminal Blocks**

Description	Maximum Voltage	Maximum Current [35]	Block			End Barrier [36]		
			Color	Catalog Number	Std. Pack [37]	Color	Catalog Number	Std. Pack [37]
 Double Deck Passthrough Four Terminals Solid or Stranded Copper Wire 26–12 AWG 5.2 mm (0.21 in.) wide	600 V	20 A	Grey	NSYTRP24D	50	Grey	NSYTRACRE24	50
			Blue	NSYTRP24DBL		Grey	NSYTRACRE24	
 Double Deck Grounding Block Four Terminals Solid or Stranded Copper Wire 26–12 AWG 5.2 mm (0.21 in.) wide	N/A	N/A	Green/Yellow	NSYTRP24DPE	50	Grey	NSYTRACRE24	50

**Table 24.27: Push-in Blade Isolators**

Description	Maximum Voltage	Maximum Current [35]	Block			End Barrier [36]		
			Color	Catalog Number	Std. Pack [37]	Color	Catalog Number	Std. Pack [37]
 Blade Isolator Two Terminals Solid or Stranded Copper Wire 26–12 AWG 5.2 mm (0.21 in.) wide	300 V	20 A	Grey	NSYTRP22SC	50	Grey	NSYTRACPK22	50
 Blade Isolator Three Terminals Solid or Stranded Copper Wire 26–12 AWG 5.2 mm (0.21 in.) wide	300 V	20 A	Grey	NSYTRP23SC	50	Grey	NSYTRACPK23	50
 Blade Isolator Four Terminals Solid or Stranded Copper Wire 26–12 AWG 5.2 mm (0.21 in.) wide	300 V	20 A	Grey	NSYTRP24SC	50	Grey	NSYTRACPK24	50

**Table 24.28: Push-In Type Component Carriers**

Description	Maximum Voltage	Maximum Current [35]	Color	Catalog Number	Std. Pack [37]	End Barrier [36]				
						Color	Catalog Number	Std. Pack [37]		
 Component Carrier Two Terminals Solid or Stranded Copper Wire 26–12 AWG 5.2 mm (0.21 in.) wide	300 A	20 A	Grey	NSYTRP22TB	50	Grey	NSYTRACPK22	50		
				Depends on fuse or diode used	Black				NSYTRASF520	10
					Black				NSYTRASF520M	10
					Black				NSYTRASF520B	10
					Grey				NSYTRASV1	10
Grey	NSYTRASV2	10								
 Component Carrier Two Terminals Solid or Stranded Copper Wire 24–12 AWG 6.2 mm (0.24 in.) wide	300 A	20 A	Grey	NSYTRP42TB	50	Grey	NSYTRACR42	50		
				Depends on fuse or diode used	Black				NSYTRASF520	10
					Black				NSYTRASF520M	10
					Black				NSYTRASF520B	10
					Grey				NSYTRASV1	10
Grey	NSYTRASV2	10								

**NOTE:** For a complete listing of these products, see catalog 9080CT1301.



File:  
E87739  
CCN:  
XCFR2



File:  
256444  
Class:  
6228-01



RoHS  
Compliant

For track and accessories, see Mounting Track and End Clamps, page 24-18.







[35] These maximum current values assume the use of insulated copper conductors with 167 °F (75 °C) temperature rating and are calculated based on NEC Article 310, Table 310-16. In most cases this value is the maximum ampacity of the wire which has the greatest current carrying capacity. The actual allowable current for a particular application depends on the size, insulation class, and other characteristics of the wire used. The UL ratings are shown. The CSA rating may be higher or lower. Refer to the catalog for CSA ratings.

[36] One end-barrier is required for each assembly of like blocks.

[37] Orders must specify the standard package quantity (Std. Pack) or multiples of that quantity.

## Linearity Marking Accessories

Table 24.29: Markers

Description	Marking	Catalog Number	Std Pack <sup>[38]</sup>
 <p>Black horizontal markings on white background For 5.2 mm (0.21 in.) wide blocks Lateral sides for NSYTRV terminal blocks Central shaft for NSYTRR / NSYTRP / NSYTRH terminal blocks</p>	1 to 10	NSYTRAB510	10
	11 to 20	NSYTRAB520	10
	21 to 30	NSYTRAB530	10
	31 to 40	NSYTRAB540	10
	41 to 50	NSYTRAB550	10
	51 to 60	NSYTRAB560	10
	61 to 70	NSYTRAB570	10
	71 to 80	NSYTRAB580	10
	81 to 90	NSYTRAB590	10
	91 to 100	NSYTRAB5100	10
	1 to 100	NSYTRAB51100	1
 <p>Black horizontal markings on white background For 6.2 mm (0.24 in.) wide blocks Lateral sides for NSYTRV terminal blocks Central shaft for NSYTRR / NSYTRP / NSYTRH terminal blocks</p>	L1, L2, L3, N, PE	NSYTRAB5L1N	10
	1 to 10	NSYTRAB610	10
	11 to 20	NSYTRAB620	10
	21 to 30	NSYTRAB630	10
	31 to 40	NSYTRAB640	10
	41 to 50	NSYTRAB650	10
	51 to 60	NSYTRAB660	10
	61 to 70	NSYTRAB670	10
	71 to 80	NSYTRAB680	10
	81 to 90	NSYTRAB690	10
	91 to 100	NSYTRAB6100	10
 <p>Black horizontal markings on white background For 8.2 mm (0.32 in.) wide blocks Lateral sides for NSYTRV terminal blocks Central shaft for NSYTRR / NSYTRP / NSYTRH terminal blocks</p>	1 to 100	NSYTRAB61100	1
	L1, L2, L3, N, PE	NSYTRAB6L1N	10
	1 to 10	NSYTRAB810	10
	11 to 20	NSYTRAB820	10
	21 to 30	NSYTRAB830	10
	31 to 40	NSYTRAB840	10
	41 to 50	NSYTRAB850	10
	51 to 60	NSYTRAB860	10
	61 to 70	NSYTRAB870	10
	71 to 80	NSYTRAB880	10
	81 to 90	NSYTRAB890	10
91 to 100	NSYTRAB8100	10	
 <p>Black horizontal markings on white background For 10.2 mm (0.40 in.) wide blocks Lateral sides for NSYTRV terminal blocks Central shaft for NSYTRR / NSYTRP / NSYTRH terminal blocks</p>	1 to 100	—	—
	L1, L2, L3, N, PE	—	—
	1 to 10	NSYTRAB1010	10
	11 to 20	NSYTRAB1020	10
	21 to 30	NSYTRAB1030	10
	31 to 40	NSYTRAB1040	10
	41 to 50	NSYTRAB1050	10
	51 to 60	NSYTRAB1060	10
	61 to 70	NSYTRAB1070	10
	71 to 80	NSYTRAB1080	10
	81 to 90	NSYTRAB1090	10
91 to 100	NSYTRAB10100	10	
 <p>Flat markers Black horizontal markings on white background Lateral sides for NSYTRV terminal blocks Central shaft for NSYTRR / NSYTRP / NSYTRH terminal block</p>	1 to 100	—	—
	L1, L2, L3, N, PE	—	—
	1 to 10	NSYTRABF510	10
	11 to 20	NSYTRABF520	10
	21 to 30	NSYTRABF530	10
	31 to 40	NSYTRABF540	10
	41 to 50	NSYTRABF550	10
	51 to 60	—	—
	61 to 70	—	—
	71 to 80	—	—
	81 to 90	—	—
91 to 100	—	—	
1 to 100	—	—	
 <p>Flat markers Black horizontal markings on white background For 6.2 mm (0.24 in.) wide blocks Lateral sides for NSYTRV terminal blocks Central shaft for NSYTRR / NSYTRP / NSYTRH terminal blocks</p>	L1, L2, L3, N, PE	—	—
	1 to 10	NSYTRABF610	10
	11 to 20	NSYTRABF620	10
	21 to 30	NSYTRABF630	10
	31 to 40	NSYTRABF640	10
	41 to 50	NSYTRABF650	10
	51 to 60	—	—
	61 to 70	—	—
	71 to 80	—	—
	81 to 90	—	—
	91 to 100	—	—
1 to 100	—	—	
 <p>Flat markers Black horizontal markings on white background For 8.2 mm (0.32 in.) wide blocks Lateral sides for NSYTRV terminal blocks Central shaft for NSYTRR / NSYTRP / NSYTRH terminal block</p>	L1, L2, L3, N, PE	—	—

**NOTE:** Refer to catalog 9080CT1301 for additional labeling options.

[38] For blocks 12.2 mm (0.48 in.) or wider, the strip must be broken and the individual marking characters used.

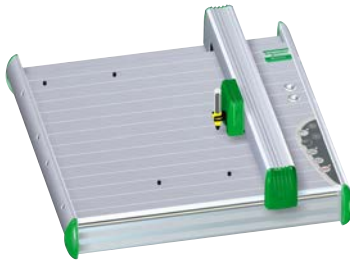







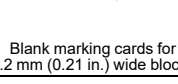

NSYTRAPLOT

**Linergy Labeling System**

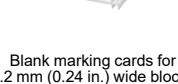
This high-speed plotting device enables custom marking of Linergy IEC terminal block labels.

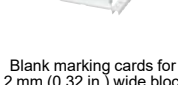
- A flexible plotter tht labels marking elements quickly and easily
- Rugged construction in stylish aluminum
- Easy-to-change fixtures to suit a variety of marking elements
- Auto calibration, no adjustment necessary
- Includes NSYTRA BMP1/ BMP2 adapter plates, 0.25 and 0.35 black pens, Spacial print software, power supply, connecting cable, and user manual.

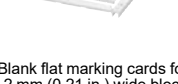
**Table 24.30: Blank Markers**

Description	Catalog Number	Std. Pack
 Blank marking cards for 5.2 mm (0.21 in.) wide blocks	72 characters (6 strips) NSYTRABPV5	10
 Plotter adapter for marking cards	NSYTRABMP1	1
 Blank marking cards for 6.2 mm (0.24 in.) wide blocks	60 characters (6 strips) NSYTRABPV6	10
 Plotter adapter for marking cards	NSYTRABMP1	1
 Blank marking cards for 8.2 mm (0.32 in.) wide blocks	42 characters (6 strips) NSYTRABPV8	10
 Plotter adapter for marking cards	NSYTRABMP1	1
 Blank flat marking cards for 5.2 mm (0.21 in.) wide blocks	72 characters (6 strips) NSYTRABFPV5	10
 Plotter adapter for marking cards	NSYTRABMP2	1
 Blank flat marking cards for 6.2 mm (0.24 in.) wide blocks	60 characters (6 strips) NSYTRABFPV6	10
 Plotter adapter for marking cards	NSYTRABMP2	1





RoHS Compliant

**NOTE:** Refer to catalog 9080CT1301 for additional labeling options.

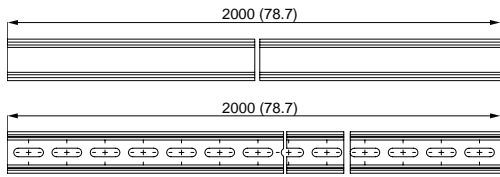
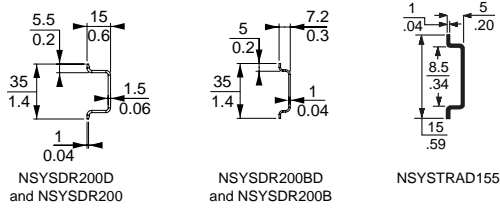
Mounting Track and End Clamps

Table 24.31: DIN 3 Track—78.74 inches (2 meter) length



Description	Length		Catalog Number	Std. Pack [1]
	In.	mm		
<b>DIN 3</b>				
Symmetrical rail 35x15 mm depth, 1.5 mm thick galvanized steel, Prepunched	78.74	2000	NSYSDR200D	20
Symmetrical rail 35x15 mm depth, 1.5 mm thick galvanized steel, No mounting holes	78.74	2000	NSYSDR200	20
Symmetrical rail 35x7.2 mm depth, 1 mm thick galvanized steel, Prepunched	78.74	2000	NSYSDR200BD	20
Symmetrical rail 35x7.2 mm depth, 1 mm thick galvanized steel, No mounting holes	78.74	2000	NSYSDR200B	20
<b>DIN 2</b>				
Symmetrical rail 15x5 mm depth, 1 mm thick galvanized steel, Prepunched	78.74	2000	NSYTRAD155	5
<b>End Clamps</b>				
 Plastic clip-on end clamp for 35 mm DIN 3 track	0.21	5.2	NSYTRAAB35	50
 Plastic clip-on end clamp with screw for 35 mm DIN 3 track	0.37	9.5	NSYTRAABV35	50
 Plastic clip-on end clamp for 15 mm DIN 2 track	0.21	5.2	NSYTRAAB15	50
 Polycarbonate end clamp for 35 mm DIN 3 track	0.31	8	9080MHA10	50

RoHS Compliant

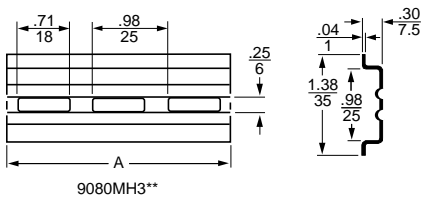
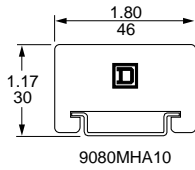







Table 24.32: DIN 3 Track – Various Lengths

Description	Length		Class 9080 Type	Std. [1] Pack	
	In.	mm			
Galvanized steel, no mounting holes	3	0.08	9080MH203	10	
	6	0.15	9080MH206		
	7	0.18	9080MH207		
	8	0.20	9080MH208		
	12	0.30	9080MH212		
	16	0.41	9080MH216		
	19.68	500	9080MH220		
	39.37	1000	9080MH239		
	78.74	2000	9080MH279		
	3	0.08	9080MH303		
	4	0.10	9080MH304		
	5	0.13	9080MH305		
	6	0.15	9080MH306		
	7	0.18	9080MH307		
Symmetrical rail 35 x 7.5 mm (1.38 in. x 0.295 in.) in compliance with EN 50022 standard (DIN 46277-3). Galvanized steel, prepunched	8	0.20	9080MH308		
	9	0.23	9080MH309		
	10	0.25	9080MH310		
	11	0.28	9080MH311		
	12	0.30	9080MH312		
	13	0.33	9080MH313		
	14	0.36	9080MH314		
	15	0.38	9080MH315		
	16	0.41	9080MH316		
	17	0.43	9080MH317		
	18	0.46	9080MH318		
	19.68	500	9080MH320		
	39.37	1000	9080MH339		
	78.74	2000	9080MH379		
High rise track	Aluminum	39.37	1000	9080MH439	2

[1] Orders must specify the standard package quantity (Std. Pack) or multiples of that quantity.

**Selection Guide**

**Table 24.33: Type G Selection Guide**

Description	Maximum Voltage	Maximum Current [1]	Blocks			End Barriers [2]		Blocks per ft	Maximum Wire Combinations	
			Color	Type	Std. Pack [3]	Type	Std. Pack [3]		Copper Wire (stranded or solid)	
 Solderless Box Lug for #22 to #8 AWG wire. Mounts on standard 9080GH track or 35 mm DIN 3 track. Fingersafe per DIN 60529.	600 V	60 A	Natural	GR6	50	GM6B	10	34	1 #8	1-4 #16 1-5 #18 1-8 #20 1-10 #22
			Black	GRB6		GMB6B				
			Blue	GRL6		GML6B				
			Green	GRG6		GMG6B				
			Gray	GRE6		GME6B				
			Orange	GRS6		GMS6B				
			Red	GRR6		GMR6B				
			Yellow	GRY6		GMY6B				
			Brown	GRN6		GMN6B				
 Similar to a 9080GR6 except with a 9080GH91 banana test plug adapter installed. Fingersafe per DIN 60529.	600 V	60 A	Natural	GR6T	50	GM6B	10	1-3 #12 1-4 #14		
 Solderless Box Lug for #22 to #10 AWG wire. Can be mounted directly to a panel or can be mounted on 9080GH track.	600 V	40 A	Natural	GK6	50	GK6B	50	34	1-4 #16 1 #10 1-2 #12 1-2 #14	1-4 #16 1-5 #18 1-8 #20 1-10 #22
			Black	GKB6						
			Blue	GKL6						
			Green	GKG6						
			Gray	GKE6						
			Orange	GKS6						
			Red	GKR6						
Yellow	GKY6									
 High Density Solderless Box Lug for #22 to #10 AWG wire. Mounts on standard 9080GH track or 35 mm DIN 3 track. Fingersafe per DIN 60529.	600 V	30 A	Natural	GM6	50	GM6B	10	51	1 #10 1 #12 1 #14 1-2 #16	1-2 #18 1-5 #20 1-8 #22 1-2 #16
			Black	GMB6		GMB6B				
			Blue	GML6		GML6B				
			Green	GMG6		GMG6B				
			Gray	GME6		GME6B				
			Orange	GMS6		GMS6B				
			Red	GMR6		GMR6B				
			Yellow	GMY6		GMY6B				
			Brown	GMN6		GMN6B				
 Solderless Box Lug for #18 to #4 AWG wire. Mounts on standard 9080GH track or 35 mm DIN 3 track.	600 V	85 A	Natural	GC6	50	GC6B	10	28	1 #4 1 #6 1-2 #8 1-4 #10	1-5 #12 1-6 #14 1-6 #16 1-8 #18
 Solderless Box Lug for #12 to #1/0 AWG wire. Mounts on standard 9080GH track or 35 mm DIN 3 track.	600 V	170 A	Natural	GD6	10	GD6B	10	17	1 1/0 1 #1 1 #2 1-2 #4	1-3 #6 1-5 #8 1-6 #10 1-7 #12
 Solderless Box Lug for #6 AWG to 250 kcmil wire. [4] Mounts on standard 9080GH track or 35 mm DIN 3 track.	600 V	255 A	Natural	GE6	10	None Required		10	1 250 kcmil [4]	
									1 4/0	1 #1
									1 3/0	1 #2
									1 2/0	1 #4
									1 #6	



File: E60616  
CCN: XCFR2



File: 062144  
Class:3211-07



RoHS Compliant

For standard or custom assemblies, see [Terminal Block Assemblies, page 24-21](#).

For mounting track and accessories, see [Mounting Track, End Clamps, Jumpers, Fanning Strips, page 24-22](#).

For DIN 3 track and end clamps, see [Mounting Track and End Clamps, page 24-18](#).

**Table 24.34: How to Order**

To Order Specify	Catalog Number	
• Class Number	Class	Type
• Type Number	9080	GR6

[1] These maximum current values assume the use of insulated copper conductors with 75 °C (167 °F) temperature rating, temperature rating, and are calculated based on NEC Article 310, Table 310-16. In most cases this value is the maximum ampacity of that wire or combination of wires (as listed in the above table) which has the greatest current carrying capacity. The actual allowable current for a particular application depends on the number, size, insulation class, and other characteristics of the wires used. The lower of the UL and CSA ratings are shown.









[2] One end-barrier is required for each assembly of like blocks.

[3] Orders must specify standard package quantity or multiples of that quantity.

[4] Terminals are tin plated, making them suitable for use with either copper or aluminum wire.

Selection Guide

Table 24.35: Type G Selection Guide

Description	Maximum Voltage	Maximum Current [5]	Blocks		End Barriers [6]		Blocks per ft	Maximum Wire Combinations	
			Type	Std. Pack [7]	Type	Std. Pack [7]		Copper Wire (stranded or solid)	
 Self-Lifting Pressure Wire Connector for #18 to #12 AWG wire. Mounts on standard 9080GH track or 35 mm DIN 3 track.	600 V	40 A	GP6	50	GP6B	10	32	1 or 2 1 or 2 1 or 2 1 or 2	#12 #14 #16 #18
 Flat Terminal Connector for #22 to #12 AWG wire. Screws are #6-32 x 5/16 in. for ring or spade lugs, 5/16 in. wide maximum. Mounts on standard 9080GH track or 35 mm DIN 3 track. Fingersafe per DIN 60529.	600 V	40 A	GA6	50	GP6B	10	32	1 or 2 Conductors Per Screw #12-22	
 Circuit Isolating Switch [8] with self-lifting pressure connectors for #18 to #10 AWG wire. Mounts on standard 9080GH track or 35 mm DIN 3 track.	600 V	30 A	GG6	10	GF6B	10	16	1 1 1 1-4 1-4	#10 #12 #14 #16 #18
 Slip-on Connectors for #22 to #12 AWG wire. Tabs accept 0.250 x 0.032 in. slip-on connectors. Mounts on standard 9080GH track or 35 mm DIN 3 track.	600 V	20 A	GS6	10	GF6B	10	16	1-2 1-2 1-2 1-2 1-2 1-2	#12 #14 #16 #18 #20 #22
 Transient Voltage Suppressors [9] with box lug connectors for #18 to #10 AWG wire. Mounts on standard 9080GH track or 35 mm DIN 3 track. See the figure below.	120 V	—	GT6	5	GT6B	10	24	1 1 1 1-2 1-4	#10 #12 #14 #16 #18
 Fuse Block for 1/32 in. Dia. x 1-1/2 in. ferrule fuse with self-lifting pressure connectors. Fuse puller is included as standard. Fuses are not included. Mounts on standard 9080GH track or 35 mm DIN 3 track. Fingersafe per DIN 60529.	600 V	30 A	GF6	10	GF6B	10	16	1 1 1 1-4 1-4	#10 #12 #14 #16 #18
 Fuse Puller [10]	—	—	GH63	50	N/A		N/A	N/A	
 Blown Fuse Indicator/ Pullers are neon pilot lights which plug on to the fuse in a standard Type GF6 fuse block.	120-240 V	—	GLP3	10	N/A		N/A	N/A	
	277-600 V	—	GLP6	10	N/A		N/A	N/A	

24 TERMINAL BLOCKS

For standard or custom assemblies, see [Terminal Block Assemblies, page 24-21](#).  
For mounting track and accessories, see [Mounting Track, End Clamps, Jumpers, Fanning Strips, page 24-22](#).  
For DIN 3 track and end clamps, see [Mounting Track and End Clamps, page 24-18](#).

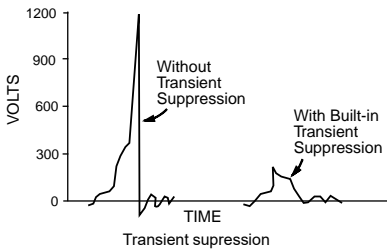

Table 24.36: How to Order

To Order Specify	Catalog Number	
• Class Number	9080	Type
• Type Number		GP6

Terminal Blocks:



File: E60616  
CCN: XCFR2



File: 062144  
Class: 3211-07



RoHS Compliant

Blown Fuse Indicator:



File: E63698  
CCN: JDV5



File: 025490  
Class: 3211-07

RoHS Compliant

[5] These maximum current values assume the use of insulated copper conductors with 75 °C (167 °F) temperature rating, and are calculated based on NEC Article 310, Table 310-16. In most cases this value is the maximum ampacity of that wire or combination of wires (as listed in the above table) which has the greatest current carrying capacity. The actual allowable current for a particular application depends on the number, size, insulation class, and other characteristics of the wires used. The lower of the UL and CSA ratings are shown.  
[6] One end-barrier is required for each assembly of like sections.  
[7] Orders must specify standard package quantity or multiples of that quantity.  
[8] Not intended to make or break a live circuit. Power must be disconnected from the circuit before operation of the switch.  
[9] Modules have RC circuitry for suppressing transient voltage, generated when opening a coil circuit, to approximately 200% of the peak line voltage, when used with 120 V coils. Type GT6 is suitable for use with Square D Class 8501 Type X, K, R and C relays or Square D Type S starters and contactors, Sizes 00-2.  
[10] Fuse puller is supplied as standard with Class 9080 Type GF6 fuse block. The 9080GH63 is a replacement fuse puller.



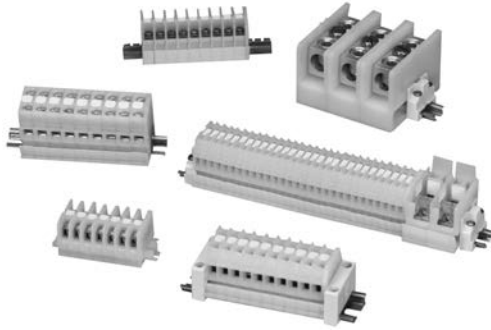

**Terminal Block Assemblies**  
**Custom Terminal Block Assemblies**

Order an assembly built as required for the application. As standard, custom assemblies use 9080GH mounting track with screw on end clamps. Other options are available from the table below.

**One terminal block type:** The number of blocks in the assembly is added to the end of the catalog number of the desired block. Example: an assembly of **25** 9080GR6 blocks would be **9080GR625**.

**More than one terminal block type in an assembly:** A detailed drawing or sketch of the desired assembly must accompany the order.

**Table 24.37: Custom Terminal Block Assembly Options**

Option	Suffix	Example
Substitute slip-in end clamps	<b>C</b>	9080GR625C
Substitute snap-off channel	<b>B</b>	9080GR625BC [11]
For direct mount assembly of 9080GK6 blocks	<b>D</b>	9080GK67D
Add a blank vinyl marking strip	<b>M</b>	9080GR625M
Add pre-marked (1–25 only) marking strip	<b>MPO</b>	9080GR625MPO
Mount on 35 mm DIN 3 track instead of 9080GH track	<b>T</b>	9080GR625T



**Table 24.38: How to Order**

To Order Specify	Catalog Number	
	Class	Type
<ul style="list-style-type: none"> <li>• Class Number</li> <li>• Type Number</li> </ul>	9080	GA612

[11] The 9080GH10 screw-on end clamp is **not** recommended for use with snap-off channel. It is recommended that the 9080GH11 slip-in end clamp be used. Therefore, when the suffix **B** is used, it should be followed by the suffix **C**.





Mounting Track, End Clamps, Jumpers, Fanning Strips

Table 24.39: 3/4 in. Mounting Track

	Style	Length (in.)	Type	Std. Pack [12]		
 Standard Track		3	GH103	5		
		4	GH104	5		
		5	GH105	5		
		6	GH106	5		
		7	GH107	5		
		8	GH108	5		
		9	GH109	5		
		10	GH110	5		
		12	GH112	5		
		13	GH113	5		
		14	GH114	5		
		15	GH115	5		
		16	GH116	5		
		18	GH118	5		
		24	GH124	5		
		36	GH136	5		
		48	GH148	5		
		72	GH172	5		
		 Snap-Off Track		36	GH236	20
				48	GH248	20
72	GH272			20		
 High Rise		36	GH336	2		

**NOTE:** For additional track and appropriate end clamps, see [Mounting Track and End Clamps](#), page 24-18.









Table 24.40: End Clamps, Jumpers, and Fanning Strips

Description	Type	Std. Pack [12]	
<b>End Clamps</b>			
 Screw-on End Clamp (Not recommended for use on snap-off mounting track)	GH10	50	
 Slip-in End Clamp (Not for use with 9080 GE6, GK6 blocks)	GH11	50	
<b>Jumpers</b>			
	2-pole jumper for GM6	GH700	20
	6-pole jumper for GM6	GH710	10
	6-pole jumper for GK6, GR6	GH73	10
	2-pole jumper for GC6	GH74	10
	6-pole jumper for GC6	GH75	10
	2-pole jumper for GD6	GH76	10
	2-pole jumper for GA6, GP6	GH78	10
6-pole jumper for GA6, GP6	GH79	10	
<b>Fanning Strips</b>			
 Snap-together fanning strip section for GK6, GR6 blocks	GH52	10	

[12] Orders must specify the standard package quantity (Std. Pack) or multiples of that quantity.

**Marking Accessories**

**Table 24.41: Marking and Additional Accessories**

Description	Type	Std. Pack [13]	
 25 ft blank vinyl marking strip	GH220	1	
 Vinyl marking strip numbered 1-25	For GK6, GR6	GH21	5
	For GA6, GP6	GH22	5
	For GM6	GH230	5
 Blank pin-feed marking tabs—6 x 20 (total 120) marking tabs for GD6, GR6, and GT6 blocks	GH200	20	
 Pre-marked 01 to 50 (2 sets) plus 20 various marking tabs (total 120 marking tabs) for GD6, GR6, and GT6 blocks	GH210	5	
 Marking strip end plug for GK6, GR6, GM6, GA6, GP6, GC6, GD6, GE6, and GT6 blocks	GH60	50	
 Transition barrier between GK6 and all other G blocks	GH61	50	
 Cover for GR6 or GR6T blocks	GH62	50	
 Angle bracket kit—for mounting 9080GH or MH track to panel at 45° angle. Includes 2 brackets and hardware for mounting the track to the brackets	MH82	1	

TERMINAL BLOCKS

24

**Table 24.42: How to Order**

To Order Specify	Catalog Number	
<ul style="list-style-type: none"> <li>• Class Number</li> <li>• Type Number</li> </ul>	Class	Type
	9080	GH10

[13] Orders must specify the standard package quantity (Std. Pack) or multiples of that quantity.



GCB100

Thermal-Magnetic Circuit Protectors

Table 24.43: 9080GCB Thermal-Magnetic Circuit Protectors

Maximum Current [1]	Internal Resistance Ω	Maximum Voltage	Catalog Number	
0.1	133	250 Vac 65 Vdc	GCB01	
0.5	6.6		GCB05	
0.8	2.55		GCB08	
1.0	1.97		GCB10	
1.2	1.22		GCB12	
1.5	0.86		GCB15	
2.0	0.49		GCB20	
2.5	0.31		GCB25	
3.0	0.20		GCB30	
4.0	0.10		GCB40	
5.0	0.08		GCB50	
7.0	0.03		GCB70	
10.0	<0.02		125 Vac 65 Vdc	GCB100
15.0	<0.02			GCB150

Table 24.44: Inrush Ratio Correction Table

NOTE: For resistive loads, use inrush correction factor of 1.0.

Inrush Ratio	1:1 to 1:4	1:5	1:6	1:7	1:8
Factor	1.3	1.4	1.5	1.6	1.7

Table 24.45: Ambient Temperature Correction Table

Ambient Temperature	70°F (21.1°C)	100°F (37.8°C)	120°F (48.9°C)	140°F (60°C)	160°F (71.1°C)	180°F (82.2°C)	200°F (93.3°C)
Factor	1.0	1.1	1.2	1.3	1.4	1.5	1.6

Table 24.46: Tripping Times in Seconds at 70 °F (21.1 °C)

NOTE: When several protectors are channel mounted adjacent to each other, the "no trip" current will be 80% of rated current at 70 °F.

Percent Rated Current	100%	200%	300%	400%	500%	600%	1000%	2000% and greater
Tripping Time (s)	no trip	10–40	38	1.5–9	0.8–6	0.003–4	0.003–2	Max. 0.02

Selection

To properly select a Class 9080 Type GCB circuit protector, follow these steps:

- Determine the inrush correction factor from Table 24.44.
- Determine the temperature correction factor from Table 24.45.
- Determine the sealed current of the load that is being protected.
- Multiply the sealed current by the two correction factors and choose the closest circuit protector.

NOTE: Choosing a circuit protector with a value lower than the calculated value might cause nuisance tripping, while choosing the larger might provide a protector that will not properly protect the load .



File: E233026  
CCN:QVNU2



File: 025490  
Class: 3211-07



Example: Solenoid with sealed current of 0.75 A, an inrush ratio of 1:6, and in an ambient temperature of 85°F: 0.75 x 1.5 x 1.05 = 1.18. Choose the 1.2 A protector.

Tripping Time: Tripping time of the circuit protector is determined from Table 24.46. Divide the circuit protector value by the temperature correction factor from Table 24.45 to determine actual rated current referenced in Table 24.46.

Table 24.47: How to Order

To Order Specify	Catalog Number	
• Class Number	Class	Type
• Type Number	9080	GH10

[1] These maximum current values assume the use of insulated copper conductors with 167 °F (75 °C) temperature rating and are calculated based on NEC Article 310, Table 310-16. In most cases this value is the maximum ampacity of the wire which has the greatest current carrying capacity. The actual allowable current for a particular application depends on the size, insulation class, and other characteristics of the wire used. The UL ratings are shown. The CSA rating may be higher or lower. Refer to the catalog for CSA ratings.

**Thermal-Magnetic Circuit Protectors**

**Table 24.48: GB2 Thermal-Magnetic Circuit Protectors**



GB2CB06



GB2CD

Description	Max. Voltage	Thermal Rating	Catalog Number [1]	Description	Max. Voltage	Thermal Rating	Catalog Number [1]
One pole Thermal Magnetic Circuit Protector 	300 Vac	0.5 A	GB2CB05	Two pole Thermal Magnetic Circuit Protector 	300 Vac	0.5 A	GB2CD05
		1 A	GB2CB06			1 A	GB2CD06
		2 A	GB2CB07			2 A	GB2CD07
		3 A	GB2CB08			3 A	GB2CD08
		4 A	GB2CB09			4 A	GB2CD09
		5 A	GB2CB10			5 A	GB2CD10
		6 A	GB2CB12			6 A	GB2CD12
		8 A	GB2CB14			8 A	GB2CD14
		10 A	GB2CB16			10 A	GB2CD16
		12 A	GB2CB20			12 A	GB2CD20



File: 081630  
Class: 3215-30



IEC 157-1  
VDE 0660

[1] Must order in multiples of 6.

- Finger safe from the front, for isolation of live parts
- Up to 760 A, to meet a wide range of application needs
- Short-Circuit Current Rating up to 100 kA with fuses, not limited by the 10 kA default
- Panel or 35 mm DIN rail mount, for application flexibility
- Gangable to create multipole configurations
- Flexible stranded wire compliant, expands usability
- The UL Listed blocks meet feeder circuit spacing requirements.
- For the short-circuit current ratings, wire classes, tightening torques, dimensions, and more, see catalog 9080CT9603.

24

TERMINAL BLOCKS



NSYEBAD11611



NSYEBAD12611



NSYEBAP13618



NSYEBP2

Enclosed Power Distribution Blocks

Table 24.49: Power Distribution Blocks with AL Lugs (accepts CU or AL conductors)

Wire Range		Mounting	Current Rating	Type
Line Side	Load Side			
CU (1) 14-2 AWG (2.5-35 mm <sup>2</sup> )	CU (1) 14-2 AWG (2.5-35 mm <sup>2</sup> )	35 mm DIN rail or panel mount	CU 115A	NSYEBAD11611
CU (1) 14-2 AWG (2.5-35 mm <sup>2</sup> )	CU (4) 14-10 AWG (2.5-6 mm <sup>2</sup> )	35 mm DIN rail or panel mount	CU 115A	NSYEBAD11614
CU (1) 14 AWG-3/0 (2.5-70 mm <sup>2</sup> ) AL (1) 6 AWG-3/0	CU (1) 14 AWG-3/0 (2.5-70 mm <sup>2</sup> ) AL (1) 6 AWG-3/0	35 mm DIN rail	CU 200 A AL 155 A	NSYEBAD12611
CU (1) 14 AWG-3/0 (2.5-70 mm <sup>2</sup> ) AL (1) 6 AWG-3/0	CU (1) 14 AWG-3/0 (2.5-70 mm <sup>2</sup> ) AL (1) 6 AWG-3/0	Panel mount	CU 200 A AL 155 A	NSYEBAP12611
CU (1) 14 AWG-3/0 (2.5-70 mm <sup>2</sup> ) AL (1) 6 AWG-3/0	CU (4) 14-2 AWG (2.5-35 mm <sup>2</sup> ) AL (4) 6-2 AWG	35 mm DIN rail	CU 200 A AL 155 A	NSYEBAD12614
CU (1) 14 AWG-3/0 (2.5-70 mm <sup>2</sup> ) AL (1) 6 AWG-3/0	CU (4) 14-2 AWG (2.5-35 mm <sup>2</sup> ) AL (4) 6-2 AWG	Panel mount	CU 200 A AL 155 A	NSYEBAP12614
CU (1) 6 AWG-400 kcmil (16-185 mm <sup>2</sup> ) CU (1) 14 AWG-3/0 (2.5-70 mm <sup>2</sup> ) AL (1) 6 AWG-400 kcmil AL (1) 6 AWG-3/0	CU (8) 14-2 AWG (2.5-35 mm <sup>2</sup> ) AL (8) 6-2 AWG	35 mm DIN rail	CU 335 A AL 270 A	NSYEBAD13618
CU (1) 6 AWG-400 kcmil (16-185 mm <sup>2</sup> ) CU (1) 14 AWG-3/0 (2.5-70 mm <sup>2</sup> ) AL (1) 6 AWG-400 kcmil AL (1) 6 AWG-3/0	CU (8) 14-2 AWG (2.5-35 mm <sup>2</sup> ) AL (8) 6-2 AWG	Panel mount	CU 335 A AL 270 A	NSYEBAP13618
CU (2) 6 AWG-250 kcmil (16-120 mm <sup>2</sup> ) AL (2) 6 AWG-250 kcmil	CU (2) 6 AWG-250 kcmil (16-120 mm <sup>2</sup> ) AL (2) 6 AWG-250 kcmil	35 mm DIN rail	CU 510 A AL 410 A	NSYEBAD25622
CU (2) 6 AWG-250 kcmil (16-120 mm <sup>2</sup> ) AL (2) 6 AWG-250 kcmil	CU (2) 6 AWG-250 kcmil (16-120 mm <sup>2</sup> ) AL (2) 6 AWG-250 kcmil	Panel mount	CU 510 A AL 410 A	NSYEBAP25622
CU (2) 4 AWG-500 kcmil (25-240 mm <sup>2</sup> ) AL (2) 4 AWG-500 kcmil	CU (2) 4 AWG-500 kcmil (25-240 mm <sup>2</sup> ) AL (2) 4 AWG-500 kcmil	Panel mount	CU 760 A AL 620 A	NSYEBAD27622
CU (2) 4 AWG-500 kcmil (25-240 mm <sup>2</sup> ) AL (2) 4 AWG-500 kcmil	CU (8) 14 AWG-2/0 (2.5-50 mm <sup>2</sup> ) AL (8) 6 AWG-2/0 kcmil	Panel mount	CU 760 A AL 620 A	NSYEBAP27628

Table 24.50: Power Distribution Blocks with CU Lugs (accepts only CU conductors)

Wire Range		Mounting	Current Rating	Type
Line Side	Load Side			
CU (1) 14 AWG-3/0 (2.5-70 mm <sup>2</sup> )	CU (1) 14 AWG-3/0 (2.5-70 mm <sup>2</sup> )	35 mm DIN rail	CU 200 A	NSYEBAD12611
CU (1) 14 AWG-3/0 (2.5-70 mm <sup>2</sup> )	CU (1) 14 AWG-3/0 (2.5-70 mm <sup>2</sup> )	Panel mount	CU 200 A	NSYEBAP12611
CU (1) 14 AWG-3/0 (2.5-70 mm <sup>2</sup> )	CU (4) 14-2 AWG (2.5-35 mm <sup>2</sup> )	35 mm DIN rail	CU 200 A	NSYEBAD12614
CU (1) 14 AWG-3/0 (2.5-70 mm <sup>2</sup> )	CU (4) 14-2 AWG (2.5-35 mm <sup>2</sup> )	Panel mount	CU 200 A	NSYEBAP12614
CU (1) 6 AWG-400 kcmil (16-185 mm <sup>2</sup> ) CU (1) 14 AWG-3/0 (2.5-70 mm <sup>2</sup> )	CU (8) 14-2 AWG (2.5-35 mm <sup>2</sup> )	35 mm DIN rail	CU 335 A	NSYEBAD13618
CU (1) 6 AWG-400 kcmil (16-185 mm <sup>2</sup> ) CU (1) 14 AWG-3/0 (2.5-70 mm <sup>2</sup> )	CU (8) 14-2 AWG (2.5-35 mm <sup>2</sup> )	Panel mount	CU 335 A	NSYEBAP13618
CU (2) 6 AWG-250 kcmil (16-120 mm <sup>2</sup> )	CU (2) 6 AWG-250 kcmil (16-120 mm <sup>2</sup> )	35 mm DIN rail	CU 510 A	NSYEBAD25622
CU (2) 6 AWG-250 kcmil (16-120 mm <sup>2</sup> )	CU (2) 6 AWG-250 kcmil (16-120 mm <sup>2</sup> )	Panel mount	CU 510 A	NSYEBAP25622
CU (2) 4 AWG-500 kcmil (25-240 mm <sup>2</sup> )	CU (8) 14 AWG-2/0 (2.5-50 mm <sup>2</sup> )	Panel mount	CU 760 A	NSYEBAD27628

Table 24.51: Terminal Plugs (for plugging unused openings)

Plug Size	For use with	Type
2 AWG	NSYEB**13618	NSYEBP2
2/0 AWG	NSYEB**13618, NSYEB**27628	NSYEBP20
250 kcmil	NSYEB**25622	NSYEBP250
400 kcmil	NSYEB**13618	NSYEBP400
500 kcmil	NSYEBAP27622, NSYEB**27628	NSYEBP500



UL E323110 QPQS  
All except  
NSYEB\*\*13618 and  
NSYEB\*\*25622



File: 70361  
Class: 6228-01

RoHS  
Compliant



UL E60616 XCFR2  
NSYEB\*\*13618  
NSYEB\*\*25622



CE Marked

UL 94V-0 flammability rating

**Open Power Distribution Blocks**

**Table 24.52: Aluminum Power Distribution Blocks**

Lug Wire Range [1]		Aluminum [2]		
Main	Branch	One Pole Type	Two Pole Type	Three Pole Type
(1) #14-2/0	(1) #14-2/0	LBA162101	LBA262101	LBA362101
(1) #6-350 kcmil	(1) #6-350 kcmil	LBA163101	LBA263101	LBA363101
(1) #4-600 kcmil	(1) #4-600 kcmil	LBA164101	N/A	LBA364101
(2) #4-350 kcmil	(2) #4-350 kcmil	LBA165202	LBA265202	LBA365202
(2) #6-500 kcmil	(2) #4-500 kcmil	LBA1652021	LBA2652021	LBA3652021
(1) #14-2/0	(4) #14-4	LBA162104	LBA262104	LBA362104
(1) #14-2/0	(6) #14-4	N/A	N/A	LBA362106
(1) #6-400 kcmil	(4) #14-2	LBA163104	LBA263104	LBA363104
(1) #6-400 kcmil	(6) #14-2	LBA163106	LBA263106	LBA363106
(1) #6-400 kcmil	(8) #14-2	LBA164108	LBA264108	LBA364108
(1) #4-500 kcmil	(6) #14-2/0	LBA165106	LBA265106	LBA365106
(1) #4-500 kcmil	(12) #14-2	LBA165112	LBA265112	LBA365112
(2) #14-2/0	(6) #14-4	LBA163206	LBA263206	LBA363206
(2) #6-500 kcmil	(8) #14-2/0	LBA165208	LBA265208	LBA365208
(2) #6-500 kcmil	(12) #14-4	LBA165212	LBA265212	LBA365212



LBA365212



LBA161104



LBC165212

**Table 24.53: Miniature Aluminum Power Distribution Blocks**

Lug Wire Range [1]		Aluminum [2]		
Main	Branch	One Pole Type	Two Pole Type	Three Pole Type
(1) #14-2	(1) #14-2	LBA161101	N/A	LBA361101
(1) #14-2	(4) #18-10	LBA161104	LBA261104	LBA361104

**Table 24.54: Copper Power Distribution Blocks**

Lug Wire Range [1]		Copper [3]		
Main	Branch	One Pole Type	Two Pole Type	Three Pole Type
(1) #18-1/0	(1) #18-1/0	LBC162101	N/A	LBC362101
(1) #6-250 kcmil	(1) #6-250 kcmil	LBC163101	N/A	LBC363101
(1) #14-2/0	(4) #14-4	LBC162104	LBC262104	LBC362104
(1) #4-500 kcmil	(6) #14-2	LBC163106	LBC263106	LBC363106
(2) #14-2/0	(6) #14-4	LBC163206	LBC263206	LBC363206
(2) #4-500 kcmil	(8) #14-2/0	LBC165208	N/A	LBC365208
(2) #6-500 kcmil	(12) #14-2	LBC165212	N/A	LBC365212



File: E60616  
CCN: XCFR2



File: 70361  
Class: 6228-01



RoHS  
Compliant

**Table 24.55: Clear Plastic Covers (0.045 in. thick)**

For LBA Type [4]	Type	Dim. A	Dim. B
LBA161...	LB11	0.824	2.31
LBA261...	LB12	1.459	2.31
LBA361	LB13	2.094	2.31
LBA162..., LBC162	LB21	1.062	2.750
LBA262..., LBC262	LB22	1.875	2.750
LBA362..., LBC362 [5]	LB23	2.688	2.750
LBA163..., LBC163	LB31	1.782	3.813
LBA263..., LBC263	LB32	3.313	3.813
LBA363..., LBC363	LB33	4.844	3.813
LBA164...	LB41	2.125	4.563
LBA264...	LB42	4.000	4.563
LBA364...	LB43	5.875	4.563
LBA165..., LBC165	LB51	2.719	5.313
LBA265..., LBC265	LB52	5.656	5.313
LBA365..., LBC365	LB53	8.375	5.313

**Table 24.56: How to Order**

To Order Specify	Catalog Number
• Class Number	9080
• Type Number	LBA162101

**Application Information**

Voltage Rating-Class B and C-600 V

Blocks are rated based on NEC Table 310-16 using 167 °F (75 °C) wire  
Aluminum blocks are tin-plated high conductive aluminum. Copper blocks are tin-plated high conductive copper.

Housing material:

- Miniature Blocks are made from high impact thermoplastic rated at 257 °F (125 °C) max. and -40 °F (-40 °C) min.
- Full Size Blocks are made from general purpose phenolic rated at 302 °F (150 °C) max. and -40 °F (-40 °C) min.

All blocks have a flammability rating of UL 94V-0.

For the short-circuit current ratings and dimensions, see catalog 9080CT9603.

[1] Lugs suitable for use with 75 °C (167 °F) conductors.

[2] Aluminum blocks will accept either aluminum or copper conductors.

[3] Copper blocks will accept copper conductors only.

[4] These covers must be ordered in multiples of 5. Each cover comes with two self-tapping screws.

[5] Will not work on a 9080LBA362106 block.

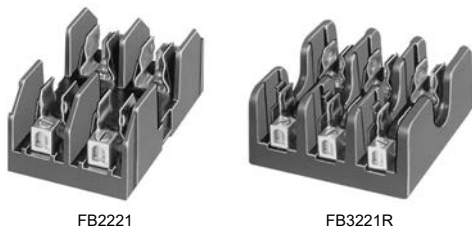

FB2221

FB3221R

**Application Information**

Clip material:

- All 30 and 60 A fuse clips are copper alloy tin plated.
- All 100 and 200 A fuse clips are one piece aluminum with copper spring tin plated.
- All Class H, R and J fuses are standard with reinforced fuse clips.

Lug termination:

- All 30 A blocks have pressure wire connectors.
- All 60, 100 and 200 A blocks have box lug connectors.

**Fuseholders and Track Adapter**

**Table 24.57: 250 V—Classes H and R**

Rating (A) [1]	No. of Poles	Class H	Class R [2][3]	Lug Wire Range
		Type	Type	
30 [4]	1	FB1211	FB1211R	#14–10 Cu
	2	FB2211	FB2211R	
	3	FB3211	FB3211R	
60 [4]	1		FB1221R	#14–2 Cu or Al
	2		FB2221R	

**Table 24.58: 600 V—Classes H and R**

Rating (A) [1]	No. of Poles	Class H	Class R [2][3]	Lug Wire Range
		Type	Type	
30 [5]	1	FB1611		#14–10 Cu
	2	FB2611		
	3	FB3611	FB3611R	
60 [5]	1		FB1621R	#14–2 Cu or Al
	3		FB3621R	
100 [5]	3		FB3631R	#6–2/0 Cu or Al

**Table 24.59: 600 V Series—Miniature Fuse Dimension (13/32 x 1-1/2 in.)**

Rating (A) [1]	No. of Poles	Type M	Class CC [2][3]	Lug Wire Range
		Type	Type	
30 [4]	1	FB1611M	FB1611CC	#14–10 Cu
	2	FB2611M	FB2611CC	
	3	FB3611M	FB3611CC	

**Table 24.60: 600 V—Class H Only (Copper Only)**

Rating (A) [1]	No. of Poles	Class H	Lug Wire Range
		Type	
30 [5]	1	FB1611	#14–10 Cu
	2	FB2611	
	3	FB3611	
100 [5]	3	FB3631C	#6–2/0 Cu

**Table 24.61: 600 V—Class J**



Rating (A) [1]	No. of Poles	Class J [2]	Lug Wire Range
		Type	
30 [5]	2	FB2611J	#2–14 AWG Cu—Al
	3	FB3611J	
	3	FB3621J	

**Table 24.62: Track Adapter**

Description	Type	Std. Pack [6]
 <p>35 mm DIN 3 Track Adapter For 9080 FB*211, FB*211R, FB*611M, and FB*611CC Fuseholders</p>	FBDIN3	100

**Table 24.63: Fuse Sizes—(Diameter x Length)**

A	Class H/R—300 V	Class H/R—600 V	Class M/CC—600 V	Class J—600 V
30	9/16 x 2 in.	13/16 x 5 in.	13/32 x 1-1/2 in.	13/16 x 2-1/4 in.
60	13/16 x 3 in.	1-1/16 x 5-1/2 in.	N/A	1-1/16 x 2-3/8 in.
100	1 x 7-7/8 in.	1 x 7-7/8 in.	N/A	N/A
200	1-1/2 x 7-1/8 in.	1-3/4 x 9-5/8 in.	N/A	N/A

	File: E40747 CCN: IZLT2	Type M fuseholders
	File: E40747 CCN: IZLT	Types H, R, J, and CC
	File: 70360 Class: 6225–01	

Flammability rating of all FB fuse blocks is UL 94V-0. RoHS Compliant

**Table 24.64: How to Order**

To Order Specify	Catalog Number
• Class Number	9080
• Type Number	FB1211

[1] Specified wire ranges are based on 167 °F (75 °C) wire. Wires with temperature ratings other than 167 °F (75 °C) are approved while observing NEC Article 310 wire tables for allowable ampacities of insulated conductors.

[2] Class R, J and CC fuse blocks are tested and approved for 200,000 AIC in accordance with UL 512.

[3] Class R and CC fuseholders accept current limiting Class R & CC fuses only.

[4] Base is high impact thermoplastic—maximum operating temperature 257 °F (125 °C).

[5] Base is general purpose phenolic—maximum operating temperature 302 °F (150 °C).

[6] Orders must specify the standard package quantity (Std. Pack) or multiples of that quantity.





DFCC1 (Left) and DFCC3V (Right)

**Modular Fuseholders**

**Table 24.65: Modular Fuse Holders, TeSys DF [1]**

Rated Thermal Current	Type of Fuse	Composition	Blown Fuse Indicator	Standard Pack Quantity	Catalog Number
30 A	Class CC	1 Pole	No	1 Pole	<a href="#">DFCC1</a>
			Yes		<a href="#">DFCC1V</a>
		2 Pole	No	2 Pole	<a href="#">DFCC2</a>
			Yes		<a href="#">DFCC2V</a>
		3 Pole	No	3 Pole	<a href="#">DFCC3</a>
			Yes		<a href="#">DFCC3V</a>

File: E310269, CCN: IZLT

[1] For additional fuse holders and information, refer to Catalog [9080CT0801](#).

With and Without Marking Flags, Dual Wire

Conform to NF C 63-023 Standard  
Mark and terminate wires simultaneously

Strip the wire, insert it into the cable end and crimp it.  
Up to 7 markers can be used.

Table 24.66: Without Marking Flag

Wire Size		Sleeve color	Dimensions (mm)				Catalog Number [1][2]	Std. Pack [3]
AWG	mm <sup>2</sup>		A	B	C	D		
26	0.25	Yellow	11	6.2	1.2	2.2	DZ5CE002L6 DZ5CE002	
			13	8.2				
24	0.34	Green	11	6.2	1.2	2.2	DZ5CE003L6 DZ5CE003	
			13	8.2				
22	0.50	White	11	6.2	1.4	3	DZ5CE005L6[4] DZ5CE005[4] DZ5CE005L12	
			13	8.2				
			16.8	12				
20	0.75	Blue	11	6.2	1.6	3.1	DZ5CE007L6[4] DZ5CE007[4]	
			13	8.2				
18	1.00	Red	11.5	6.2	1.8	3.4	DZ5CE010L6[4] DZ5CE010[4] DZ5CE010L12	
			13.5	8.2				
			16.8	12				
16	1.50	Black	11.5	6.2	2.1	4	DZ5CE015L6[4] DZ5CE015[4] DZ5CE0153[4]	
			13.5	8.2				
			22.8	17.7				
14	2.00	Yellow	14.5	8.2	2.35	4.2	DZ5CE020	
14	2.50	Gray	14.5	8.2	2.7	4.6	DZ5CE025[4] DZ5CE0253[4]	
			24	17.7				
12	4.00	Orange	17.3	9.8	3.3	5.5	DZ5CE042[4] DZ5CE043[4]	
			25.5	17.5				
10	6.00	Green	20	11.5	3.95	7	DZ5CE062 DZ5CE063	
			26	17.5				

Table 24.67: With Marking Flag

26	0.25	Yellow	13	8.2	1.2	2.2	DZ5CA002 DZ5CA003	1000
24	0.34	Green			1.4	3	DZ5CA005[4]	
22	0.50	White	13.5	8.2	1.6	3.1	DZ5CA007[4]	1000
20	0.75	Blue			1.8	3.4	DZ5CA010[4]	
18	1.00	Red	14.5	8.2	2.1	4	DZ5CA015[4]	1000
16	1.50	Black			2.7	4.6	DZ5CA025[4]	
14	2.50	Gray						

Table 24.68: Marking Flag Optional [5]

12	4.00	Orange	19.5	11.5	3.3	5.5	DZ5CA042[4]	1000
			25.5	17.5	3.3	5.5	DZ5CA043[4]	
10	6.00	Green	20	11.5	3.95	7	DZ5CA062	1000
			26	17.5	3.95	7	DZ5CA063	
8	10.00	Brown	21.5	12	4.95	8.4	DZ5CA102	100
			27	17.5	4.95	8.4	DZ5CA103	
			23.5	12	6.35	9.8	DZ5CA162	
6	16.00	White	29	17.5	6.35	9.8	DZ5CA163	100
			30	17.5	8.15	12	DZ5CA253	
4	25.00	Black	30	16	9	13.5	DZ5CA352	20
			39	25	9	13.5	DZ5CA353	
2	35.00	Red	36	20	11	15.7	DZ5CA502	20
			41	25	11	15.7	DZ5CA503	

Table 24.69: Dual Wire Cable Ends

			A	B	C	D	E	
22	0.50	White	13	8	1.4	2.5	4.7	AZ5DE005
					1.6	2.8	5.0	AZ5DE007
18	1.00	Red	13.5	8	1.8	3.4	5.4	AZ5DE010
					2.1	3.6	6.6	AZ5DE015
16	1.50	Black						
14	2.50	Gray	24	10	2.7	4.2	7.8	AZ5DE025

RoHS Compliant



DZ5CE005

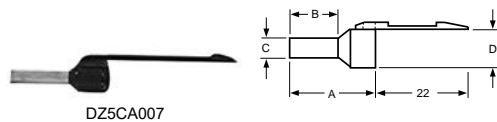
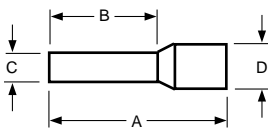

DZ5CA007

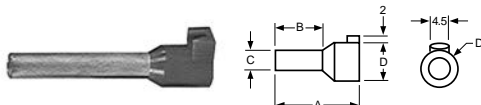
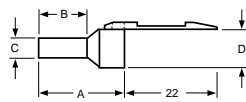

DZ5CA042

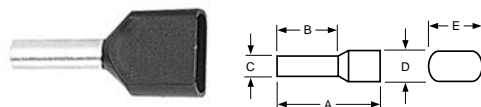
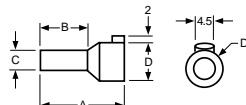

AZ5DE010

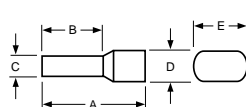

[1] Bold faced catalog numbers are stocked in the United States.

[2] CE Marked.

[3] Orders must specify the standard package quantity (Std. Pack) or multiples of that quantity.

[4] These catalog numbers are UL Component Recognized (File E164872 CCN ZMMT2) provided the AT1PA crimping tool is used to crimp the cable end.

[5] Will accept an AR1SC03 cable marker.

**Cable End Markers and Tools**

**Table 24.70: Cable End Markers & Accessories**

Style	Catalog Number	Std. Pack [6]
Adjustable collar type marker holder for #14 to #2 wire	AR1SC01	100
Clip-on marker holder for #18 to #16 wire (7 markers max.)	AR1SC02	
Cable end marker tags for DZ5CA042 to DZ5CA253	AR1SC03	1
Card of 200 yellow markers with black numeral 0 thru 9	AR1MA01[7]	1
Card of 200 yellow markers with black letters A thru Z	AR1MB01 [7]	1
Card of 200 black markers with a white 0 marked on them	AR1MC010	200
Card of 200 brown markers with a white 1 marked on them	AR1MC011	200
Card of 200 red markers with a black 2 marked on them	AR1MC012	200
Card of 200 orange markers with a black 3 marked on them	AR1MC013	200
Card of 200 yellow markers with a black 4 marked on them	AR1MC014	200
Card of 200 green markers with a black 5 marked on them	AR1MC015	200
Card of 200 blue markers with a black 6 marked on them	AR1MC016	200
Card of 200 violet markers with a black 7 marked on them	AR1MC017	200
Card of 200 gray markers with a black 8 marked on them	AR1MC018	200
Card of 200 white markers with a black 9 marked on them	AR1MC019	200
Card of 200 blank yellow markers	AR1MA0196	1
Card of 200 blank green markers	AR1MA0197	1
Card of 200 yellow markers with a black + marked on them	AR1MA0198	1
Card of 200 yellow markers with a black — marked on them	AR1MA0199	1
Complete set of numeral markers 0 thru 9, plus one card each of the "+", "-", yellow blanks, and green blanks/one AT1PA1 positioning tool. Each kit has 200 of each item.	AR1MA01	1
Complete set of letter markers A thru Z, plus one card each of the "+", "-", yellow blanks, and green blanks/one AT1PA1 positioning tool. Each kit has 200 of each item.	AR1MB01	1

**Table 24.71: Cable End Tools**

Description	Catalog Number
Cable end marker positioning tool	AT1PA1
Automatic stripping and cutting tool for 0.8 mm to 4 mm cable, adjustable stripping length	AT1PA7
Crimping tool for cable ends 0.5 mm <sup>2</sup> to 16 mm <sup>2</sup>	AT1PA2
Crimping tool for cable ends 10 mm <sup>2</sup> to 35 mm <sup>2</sup>	AT1PA4
Organizing case for cable ends—holds stripping tool and cable ends (not supplied)	AT1HB2

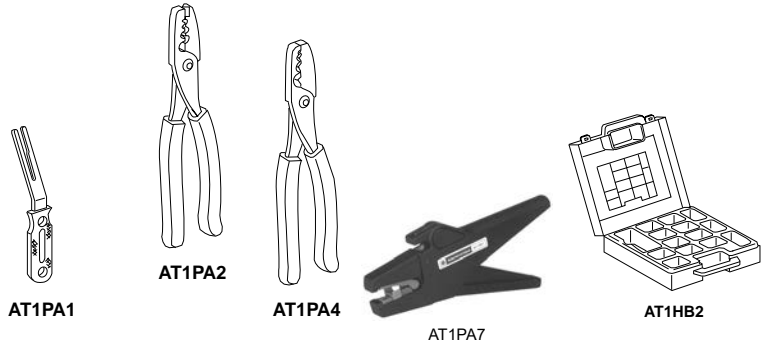
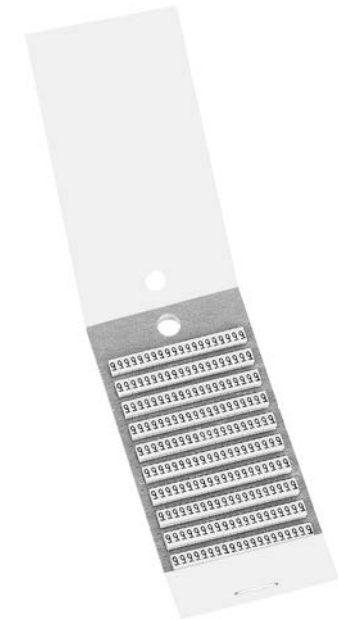

[6] Orders must specify the standard package quantity (Std. Pack) or multiples of that quantity.  
 [7] Complete the catalog number by adding the number or letter desired.  
 Examples: AR1 MA015 is a card of 200 yellow markers with a black 5 marked on them.  
 R1 MB01T is a card of 200 yellow markers with a black T marked on them.

**TELEFAST™ 2 Prewired Connection System**

The TELEFAST 2 system is a set of products for the rapid connection of I/O modules (24 Vdc discrete, analog and counters) to Various control circuit components. These components act as a substitute for screw terminal blocks, remotely locating and partly eliminating the single wire connections. The system connects only to channels with HE10 and SUB-D connectors, or to standard terminal blocks with a cabled connector.

Variations within the listing of modules include those with and without relays (electromechanical and solid state), analog and counter modules, and special function modules.

Pre-wired cables available allow you to connect directly to:

- Schneider Electric (Modicon™ family)
  - Premium PAC
  - TSX Micro PLC
  - TSX Series 7
  - Twido PLC
  - Quantum PAC
  - Compact
  - April S5000/7000
  - NUM1020/1060-M340 PAC-M580 PAC-M221 PLC
- Siemens
  - S7 – 200/300/400
  - S5 – 95U to 155U
- Allen-Bradley
  - SLC500

In addition, other accessories include:

- I/O simulators
- Continuity blocks
- Label marking software
- Splitter bases (16, 23, and 32 channels)
- Mounting kits
- Detachable terminal strips
- Wiring pass-through connectors
- Fuses

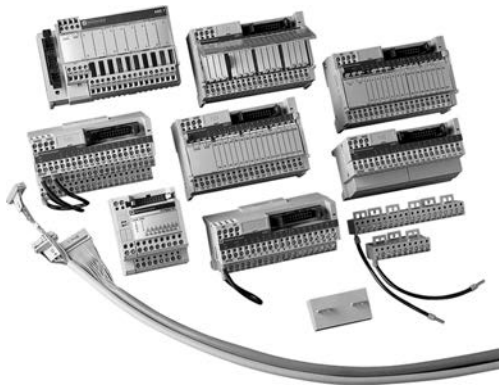

**Advantys Telefast 2 Product Features**

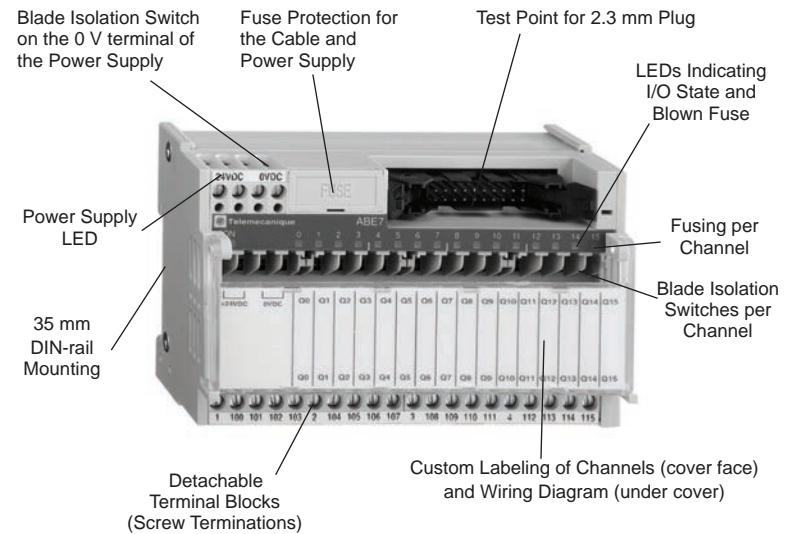

**NOTE:** Not all features are available on all modules.

# Section 25

## Machine Safety Products

<b>Preventa™ Machine Safety Products</b>	<b>25-1</b>
Introduction	25-2
Safety Relays—XPS	25-2
Modular Safety Controllers—XPSMCM	25-2
Light Curtains—XUSL	25-2
Safety Interlock Switches—XCS	25-2
Non-Contact Safety Interlock Switches—XCSDM	25-2
Safety Limit Switches—XCS	25-2
Cable Pull Switches—XY2	25-2
Other products for use in safety-related systems	25-2
<b>Safety Chain Solutions and Preventa™ XPS/XPSMCM Safety Relays</b>	<b>25-3</b>
For Monitoring Safety Functions	25-3
Safety Chain Solutions and Functions	25-3
XPS Safety Relays	25-3
XPSMCM Modular Safety Controllers	25-3
<b>Light Curtains</b>	<b>25-5</b>
For point of operation or perimeter guarding	25-5
XUSL Light Curtains	25-5
<b>Safety Interlock Switches</b>	<b>25-6</b>
Safety Interlock Switch Products	25-6
XCS Safety Interlock Switches	25-6
XCSDM Non-Contact Safety Interlock Switches	25-6
XCSR Contactless RFID Safety Sensors	25-7
<b>Safety Switches</b>	<b>25-7</b>
Safety Limit and Cable Pull Switches	25-7
Safety Limit Switches	25-7
XY2 Cable Pull Switches for Emergency Stop Operation	25-8



XPS Safety Relay



XPSMCM Modular Safety Controller



XUSL Light Curtain



XCSDM Non-Contact Safety Interlock Switches



XYZCED Double Cable Pull Switches

MACHINE SAFETY PRODUCTS

25

## Introduction

Many different architectures for safety related solutions are available in Schneider Electric's product offering, from safety relays to safety PLCs. The architecture can determine what SIL level or performance level can be achieved with the safety related solution. Various architectures may have inherent benefits such as simple selection or increased levels of diagnostics, but their cost effectiveness can depend on the size and complexity of the safety related system and the features and functions required.

### Safety Relays—XPS

To tie the whole safety system together, XPS safety relays are used to monitor the safety inputs, outputs, and feedback from the system to determine when the system is safe to start and when the system should be shut down.

### Modular Safety Controllers—XPSMCM

Modular safety controllers are used in applications where multiple safety relays would be required to control the safety-related system, or where the interaction between the individual safety relays would require significant inter-wiring. Ethernet based communication allows you to provide status to the control system without additional I/O wiring. The simple-to-use software allows you to easily develop the safety-related control system, providing a cost effective solution.

### Light Curtains—XUSL

Some machine operations may not allow gates or guards to be used, and other applications require high visibility of the process or easy accessibility. For these applications, XUSL light curtains may be the best choice and are available in many protected heights, minimum object sensitivities, and configurations.

### Safety Interlock Switches—XCS

To protect operators, maintenance, and other personnel, safety systems may require the interlocking of mechanical gates or guards. We provide both locking and non-locking mechanical XCS safety interlock switches in many body styles and contact arrangements.

### Non-Contact Safety Interlock Switches—XCSDM

For certain applications, such as food and beverage, no contact between the safety interlock switch and its actuating key is desired, so we provide several different types of XCSDM non-contact safety interlock switches.

### Safety Limit Switches—XCS

In some applications, the position of components is important to the safety of the machine. Devices such as safety interlocks or light curtains are impractical. These applications are ideal for safety limit switches. They can also be used on gates and guards to verify a closed position or a fully open or overtravel position.

### Cable Pull Switches—XY2

In most applications, emergency stopping is required to shut the machine down in case an emergency or problem arises. Where an individual emergency stop is required, the XB4/XB5 emergency stop push buttons are available in various types, sizes, and nameplates. On large machines or conveyors, a high number of emergency stop operators may need to be installed. As more individual e-stop buttons are required, using an XY2 cable pull switch becomes a more economical solution based on ease of use, installation time, and cost effectiveness.

### Other products for use in safety-related systems

We offer many other products that are suitable for use in safety-related circuits, such as:

- XB4/XB5 emergency stop push buttons—See Section 19, [XB4–XB5 Common Operators](#), page 19-8
- XV tower lights—See Section 19, [XVC Tower Lights and Accessories](#), page 19-118
- TeSys contactors and relays—See Section 18, [Contactors and Relays](#), page 18-2
- Limit switches with positive/direct opening N.C. contacts—See Section 21, [Limit Switches](#), page 21-2

All of the machine safety products in this section are designed to work together to allow you to meet your various safety requirements. When properly applied, these products will allow you to meet SIL 3 per IEC 61508, Category 4 per ISO 13849-1, and performance level “e” per ISO 13849-1, and help you meet domestic and international safety requirements, standards, and codes.

The following pages give an overview of our wide offering of machine safety products. [MKTED208051EN-US](#) gives a detailed description of our offering, including safety PLCs, safety controllers, safety relays, safety interlocks, light curtains, safety interlocks, non contact safety interlocks, and cable pull switches. This catalog also provides additional information on domestic and international safety standards and codes, and additional information to help you develop safety systems for the protection of personnel.

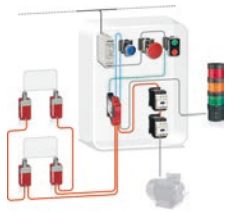

Guard Monitoring with Safety Module, Limit Switch, and Contactor



XPS Safety Relay

## Safety Chain Solutions and Functions

Machine builders are looking to improve machine safety without compromising production targets in dynamic industrial environments. Safety has a direct impact on user productivity and company reputation. However, building the right level of safety on your machine can be difficult due to regulations, a large portfolio of offers, and being sure you have the right safety application knowledge.

Schneider Electric is a complete safety chain provider. Schneider Electric's safety chains cover all the safety functionality and scalability you need to improve efficiency and profitability. The Preventa range offers an extensive selection of safety products, compliant with international standards, to provide the most comprehensive protection for personnel and equipment.

Learn more about our complete machine safety chain solutions in catalog [DIA3ED2140902EN](#), available at [www.schneider-electric.com](http://www.schneider-electric.com). This catalog contains a list of machine safety solutions, including sensors, operators, and logic devices designed to meet a variety of specific needs and performance levels for typical machine safety applications.

## XPS Safety Relays

XPS safety relays monitor various safety inputs, start sequences, and feedback from starters and relays to allow machinery operation only when all safety controls are in their appropriate state and are functioning properly. Inputs can be from emergency stop push buttons, cable pull switches, limit switches, light curtains, safety interlock switches, or two hand control stations.

XPS safety relays give users increased functionality and flexibility when designing equipment to meet safety requirements and standards in the U.S., for the European Safety Directive, IEC safety requirements and meet Category 4 of EN/ISO 13849-1. Most devices can be configured for single or dual channel inputs, and for either monitored start, non-monitored start, or automatic start. Removable wiring terminals or non-removable wiring terminals are available on most module types.

The XPS product family complements our broad safety product offering with modules for many specific safety functions and applications, as well as devices for use in general types of applications. There are even devices whose safety functions can be configured at the time of installation.

### Preventa XPS Includes the Following Types of Safety Relay Modules:

- Specific purpose modules such as limit switch monitoring, zero speed, timing, two-hand control, press control, and others
- Multifunctional configurable devices with multiple sets of inputs whose functions can be configured from 15 pre-defined functions, allowing greater flexibility and functionality
- Broad range of devices for emergency stop applications
- Expansion modules to increase the number of safety outputs
- Many devices compatible with light curtains

### Features and Benefits

- LEDs are provided to indicate power, input, output, and feedback loop status.
- Solid state outputs provide compatibility with system controllers for diagnostics, troubleshooting, and correct system operation.
- Most devices are available with either removable or non-removable terminals.
- Most devices are available with a monitored start function to detect welded contacts or incorrect status in the start function and also to detect tampering with the start circuit.
- Dual voltage devices are available for use with either 120 V or 24 V power to reduce your inventory and increase flexibility.

## XPSMCM Modular Safety Controllers

XPSMCM Modular Safety Controllers are designed to monitor multiple safety functions on and around a machine to minimize the risk of people accessing dangerous moving parts. This modular safety controller is designed for monitoring safety functions such as:

- Emergency stop
- Guard monitoring
- Perimeter guarding
- Position monitoring
- Speed monitoring
- Enabling movement

This is achieved with input devices such as:

- Emergency stop push buttons
- Safety guard and limit switches
- Safety foot switches
- Safety light curtains and laser scanners
- Safety mats
- Safety encoders and proximity sensors
- Two-hand control stations
- Enabling switches



XPSMCM Safety Modular Controller

### XPSMCM System Applications

XPSMCM systems offer numerous advantages compared to traditional safety modules, such as:

- The ability to design expansion module hardware architecture and layout according to the machine specification. This reduces the number of components, the footprint, and wiring.
- Simplification of input and output wiring by software configuration combining multiple functions
- Machine scalability from 8 inputs and 2 outputs up to 128 inputs, 16 outputs, and 32 diagnostic status outputs with the expansion modules connected directly to the controller or distributed among 6 islands
- A wide range of communication expansion modules
- Intuitive software for logical configuration, offline simulation, and online visualization, testing, and commissioning
- Simplification of machine maintenance through a removable memory card, which can be used to transfer the configuration to a new controller without software

### XPSMCM System Components

An XPSMCM system is composed of:

- A safety controller CPU, which can be used as standalone or together with expansion modules
- Safe expansion modules: digital input modules, solid state and relay output modules, or mixed input/output modules
- Safe speed monitoring modules for proximity sensors and safety encoders: Sin/Cos, HTL, TTL
- Safe communication expansion modules for safe island creation
- Non-safe communication modules: interfaces to machine network (Modbus TCP and Ethernet IP)
- A memory card, available for saving configuration data for ease of maintenance and controller setup
- Backplane expansion connectors for connecting the modules to the safety controller CPU

### Configuration Software

The XPSMCM modular safety controller is supported by [SoSafe Configurable](#) software. This software is available as a free download at: <https://www.schneider-electric.com> The software uses a simple drag and drop function block approach to configuration and has a library of configurable safety and logical functions, as well as easy to use tools for:

- Online configuration monitoring
- Offline simulation
- Configuration validation
- Hardware device scanner
- Printable schematics and documentation

SoSafe Configurable software supports quick and easy setup of the machine.



New!

## XUSL Light Curtains

### XUSLM4 Light Curtains

The XUSLM4 Type 4 Safety Light Curtains with integrated muting provide efficient protection of machine operators with uninterrupted automation processes.

The XUSLM4 Safety Light Curtains come in basic or advanced models and can be fitted with a range of available muting arm options to fit your specific application. This optimized range of light curtains has embedded safety functions such as Automatic or Manual start/restart and External Device Monitoring (EDM) allowing a standalone operation without a safety interface.

The XUSLM4 Safety Light Curtains from Telemecanique Sensors are available in Body and Hand detection models in different protected heights



XUSLM4 Light Curtains

### XUSL Type 2 and 4 Light Curtains

XUSL Type 2 and 4 light curtains provide point of operation protection for large areas without the need for gates or guards. They allow excellent visibility of the machine or process and free access to the machine while providing protection for personnel. Light curtains are made up of an array of infrared light beams to form a protected area. Whenever one or more of the light beams is broken, the light curtain sends a stop signal to the machine safety control circuit.

### XUSL2E and XUSL4E Light Curtains

XUSL2E and XUSL4E light curtains for point of operation safeguarding are available in either single or multiple segment configurations. Choose the one that best meets your application requirements. These versions are available in either 14 mm or 30 mm minimum object sensitivity (MOS).

Slim and rugged design results in an esthetically pleasing small mounting footprint suitable for aggressive environments.

Two box light curtains are ideal for installations where it is desirable to mount and wire only two components, transmitter and receiver. These devices are self-contained and the receiver provides the safety outputs.

#### Features and Benefits

- 14 and 30 mm minimum object sensitivity (MOS)
- 14 mm MOS protection heights: 160 - 1810 mm (6.3 - 71.3 in.)
- 14 mm MOS sensing range: 6.0 m (19.68 ft.)
- 30 mm MOS protection heights: 160 - 1810 mm (6.3 - 71.3 in.)
- 30 mm MOS sensing range: 8 m or 20 m (26.2 or 65.6 ft.)
- 29 x 31.5 mm housing size (1.1 x 1.2 in.)
- 24 Vdc supply voltage
- Female connector cables sold separately (5 m, 10 m, 15 m, and 30 m)
- Cascadable devices available - up to 3 segments



XUSL Light Curtain

## XCS Safety Interlock Switches

### For Gate or Guard Interlocking



XCSA Safety Interlock Switch



XCSMP

XCS safety interlock switches verify that the doors, gates, or guards are closed before a process which could be harmful to personnel can start up. The hazards to personnel can be mechanical, electrical, hydraulic, pneumatic, chemical, or thermal. The various sizes and shapes of safety interlock switches are designed for a wide variety of applications. These mechanical devices have two components: a switch and an actuating key. When the gate or guard is closed, the actuating key attached to the gate or guard is inserted into the switch, closing the safety contacts, allowing the machine to be started. When the gate or guard is opened, the actuating key is removed from the switch, and the safety interlock switch contacts open.

XCS safety interlock switches are designed to meet demanding requirements in the US and Europe, as well as the rest of the world. The flexibility of the XCS line allows one XCS device to perform the same functions as several competitor's devices. This means that fewer XCS devices may be required to cover your needs.

Specifically designed for the protection of machine operators, maintenance and other personnel, the XCS switches can be used in a wide range of applications where a gate, door or guard is a part of the safety related system.

#### Features and Benefits

- Simple, rapid installation saves time and labor
- Device flexibility reduces stock requirements
- Wide variety of body styles, contact arrangement, and operators meet a variety of application requirements
- Bodies available in metal or plastic
- Switches are interchangeable between new and older devices, as well as with competitor's devices
- A variety of actuating keys are suitable for all applications
- Pre-wired devices and many connector options available to make wiring and installation easier

#### The Following Types of Safety Interlocks are Available:

- Non-locking
- Locking with push button or key release
- Locking by electrical solenoid
- Rotary shaft operation, for use on hinges of doors
- Rotary lever for hinged guards
- Pre-wired compact body

## XCSDM Non-Contact Safety Interlock Switches

### For Non-Contact Gate or Guard Interlocking

XCSDM non-contact safety interlock switches are designed for the same functions as mechanical safety interlock switches. The difference is that the non-contact safety interlock switches are magnetically coded devices and require no contact between the switch and coded magnet. This is a benefit where door or guard mis-alignment is an issue, or where the machine designer does not want to use a mechanical device.

#### Benefits of Non-contact Devices:

- Food, beverage and pharmaceutical applications require that no contaminants be trapped in or around devices.
- Non-contact devices have no inherent operating force and are well-suited for applications such as lightweight or plexiglass doors, where cracking or breakage is prevalent with standard mechanical safety interlock switches.
- Wash down applications where a standard mechanical safety interlock switch would be more difficult to clean, especially in the actuating key receptacle.
- Where small size is critical or a slim profile is desired

#### Features and Benefits of XCSDMC, XCSDMP, and XCSDMR

- Tolerates gate or guard alignment problems
- Wider temperature range for a plastic bodied device than any competitor's products
- Multiple coded-magnet approach directions allow for maximum flexibility of mounting options
- Suitable for Category 4 safety circuits when used with a safety relay or safety controller.
- Available with or without LEDs

#### Features and Benefits of XCSDM3 and XCSDM4

- Meets SIL 2 and 3 per IEC 61508, Category 3 and 4 per EN 954-1 and EN/ISO 13849-1 and performance level "e" per EN/ISO 13849-1 without the need for a safety relay or safety controller
- Connector and cabled versions available
- Multicolor LEDs for diagnostics and status
- Multiple coded-magnet approach directions allow for maximum flexibility of mounting options



XCSDMP



XCSDM4

*New!*

### XCSR Contactless RFID Safety Sensors

The XCSR contactless RFID safety sensor from Telemecanique Sensors provides industrial companies with the highest level of safety-certified sensor protection, allowing employers to effectively seal off areas in the work zone that are dangerous. The design of the new XCSR safety sensor safeguards employees against tampering with the protection system.

The XCSR contactless RFID safety sensor is TÜV certified with a Cat4/PLe – SIL3 rating.

The XCSR contactless RFID safety sensor is virtually tamper-proof. The ready-to-use transponder and reader are factory-paired and sold together with a unique, high-level coding which is virtually impossible to bypass or disrupt. Once this highly effective safety system is in place, its functionality can't be altered.

The XCSR contactless RFID safety sensor offers three different connection types to fit virtually any type of industrial environment. All three connection types are configured with unique codes and provide a PLe/Cat4 – SIL3 level of protection. The three connection types offered are as follows:

- **Standalone:** The standalone model of the new XCSR contactless RFID safety sensor allows direct connection to contactors. It has integrated safety functions, such as monitoring of the contactors and manual or automatic start and restart functions.
- **Series:** The series model of the new XCSR RFID safety sensor allows direct connection to a simple safety relay and series diagnosis through a diagnostic module. There is no programming software needed. The series model comes with integrated M12 series connectors and eliminates the need of T or Y connectors.
- **Single:** The single model of the new XCSR RFID safety sensor allows point-to-point connections to a safety controller.



XCSR RFID Safety Sensor

### Safety Limit Switches

#### XCS Safety Limit Switches

Preventa XCS safety limit switches are used in machine safety systems for a wide variety of safety related functions, including end of travel notification, overtravel indication, safety related positioning of machinery/tooling or component parts, as well as interlocking gates and guards. They are often used in conjunction with safety interlock switches for mechanical and electrical redundancy on doors and guards.

#### Features and Benefits

- Meet US and European safety standards requiring that switches used in safety related applications have positive opening contacts
- Tamper resistant covers over mounting screw and head adjustment to reduce potential for tampering
- Red color allows easy visibility and identification of safety related limit switches
- Two body styles available:
  - Compact, pre-wired with cable
  - Compact, with conduit entry



XCS Safety Limit Switch

#### XCSP/XCSD Safety Limit Switches

The XCSP (plastic body) and XCSD (metal body) safety limit switches are identical in size and features. The only difference is the enclosure and conduit entry. XCSP and XCSD safety limit switches are for use in safety related applications including end of travel notification, overtravel indication, safety related positioning of machinery/tooling or component parts, as well as interlocking gates and guards.

#### Features and Benefits

- Positive opening contacts standard in all devices
- Snap acting contacts
- Slow make/slow break contacts
- Several head types available
- Metal and Plastic body styles available
- Several conduit types available
- Tamper resistant cover

#### XCSM Safety Limit Switches

The XCSM safety limit switches come pre-wired in multiple lengths of electrical cable for simplified installation. The XCSM safety limit switches are for use in safety related applications including end of travel notification, overtravel indication, safety related positioning of machinery/tooling or component parts, as well as interlocking gates and guards.

#### Features and Benefits

- Positive opening contacts standard in all devices
- Snap acting contacts
- Slow make/slow break contacts
- Several head types available
- Metal body
- Pre-wired in various cable lengths
- Tamper resistant cover

New!

## XY2 Cable Pull Switches for Emergency Stop Operation

XY2 cable pull switches provide emergency stop signaling at any point along a cable up to 656 feet in length. This is preferable to installing many individual emergency stop push button stations along a conveyor or around the machine, providing a more cost effective solution. Typical applications include conveyor systems, packaging, textiles, transfer machines, presses, woodworking equipment and paint lines.

Operation is based on the taut cable principle. The cable must be tight and have appropriate tension applied to set or reset the switch. Once cable tension has been set, the device will open the N.C. control contacts if either the cable is pulled or if it becomes slack due to stretching or breakage of the cable.

Normal stop versions are used where a momentary, non-emergency signal is required at any point along a cable.

### Features and Benefits

- Cable lengths: XY2CED: 656 ft.; XY2CE 230 ft.; XY2CH and XY2CJ 98 ft.
- Emergency stop versions (available in XY2CED, XY2CE, XY2CH, and XY2CJ)
  - The N.C. contact opens the control circuit and mechanically latches, and will remain latched in the open position until an operator manually resets it
  - Emergency stop versions have positive/direct opening contacts as standard
  - Device will not reset if out of adjustment
- Normal stop versions (available in XY2CE and XY2CH)
  - Normal stop versions are used where a momentary, non-emergency signal is required
  - Normal stop versions do not latch contacts open or include positive opening contacts
  - Normal stop versions are provided with snap action contacts for momentary stop
- Adjustable tripping force (XY2CE and XY2CED)
- Available with 2 N.O. and 2 N.C. contacts (XY2CE and XY2CED) or
- Available with 2 N.C. and 1 N.O. contacts (XY2CH and XY2CJ)
- Two viewing windows to aid in adjusting the switch (XY2CH)
- Manual tripping force adjustment (XY2CE and XY2CED)
- Adjustment indicator (XY2CE, XY2CH, and XY2CED)
- Traction force indicator (XY2CE, XY2CH, and XY2CED)
- Left, right, and straight cable mount, depending on unit
- UL NSID certified for emergency stop
- Protection level IP65 and IP66 (XY2CED)
- Compliant up to PLe/Cat4–SiI3 safety levels (XY2CED)

### XY2CED Features

- Operating temperature range: -13 °F to 158 °F (-25°C to +70°C)
- Suitable for protected outdoor use
- Silicon bellows (extreme temperatures) or nitril as standard bellows
- Different types of reset button (booted, flush, key)
- With or without pilot light
- Cable entries: Compatible ISO M20 and Pg 13.5 cable glands or threaded ½ in. NPT
- Contact blocks : 2 blocks [ N.C. + N.O. ]
- Protection level: IP65 and IP66
- Certifications
  - CE
  - UL-NISD
  - CSA
  - CCC
- Compliant up to PLe/Cat 4 – SIL3 safety levels (with appropriate safety interface)



XY2 Cable Pulls

# Section 26

## AC Drives and Soft Starters



Altivar™ 212



Altivar™ 320



Altivar™ 340



Altivar™ 680/980  
Low Harmonic



Altivar™ 650



Altivar™ 930



Altistart™ 22  
Soft Starters



Altistart™ 48  
Soft Starters

### Drives Overview 26-2

Open AC Drives	26-2
Overview of Altivar™ 12 / 312	26-2
Overview of Altivar™ 320	26-3
Overview of Altivar™ 340	26-4
Overview of Altivar™ 71 and Altivar™ Process 900	26-5
Overview of Altivar™ 212 / 61 and Altivar™ Process 600	26-6
Open AC Soft Starters	26-7
Overview of Altistart™ 01 / 22 / 48	26-7
Enclosed AC Drives and Soft Starters	26-8
Overview of S-Flex™ and Altistart™ Enclosed 22 / Enclosed 48	26-8
Overview of Altivar™ 680/980 Process, 660/960 Process, and Altivar™ 1260	26-9
North American Drive Systems	26-10
Overview of Altivar™ Outdoor 630/930	26-10

### AC Drives Selection Tables 26-10

Altivar™ 212	26-10
Altivar™ 12	26-12
Altivar™ 312	26-13
Altivar™ 320	26-15
Altivar™ 340	26-17
Altivar™ 61	26-18
Altivar™ 71	26-19
Altivar™ 61 / 71 Options	26-22
Altivar™ Process 630/650	26-24
Altivar™ Process 930/950	26-25
Altivar™ 600/900 Accessories	26-26

### Enclosed Building Drives Selection Tables 26-27

S-Flex™ 212 AC Drives	26-27
-----------------------	-------

### AC Soft Starters 26-28

Altistart™ Soft Starters	26-28
Altistart™ 22 Soft Starters	26-28
Altistart™ 48 Soft Starters	26-29



### Enclosed Soft Starter 26-30

Enclosed Altistart™ 22 Motor Controllers	26-30
--	-------



### AC Drives and Soft Starter Support 26-32

Support, Training, and Documentation	26-32
--------------------------------------	-------

Overview of Altivar™ 12 / 312

Type of Motor Control		Simple Machines	
Key Application/Market Segment		<ul style="list-style-type: none"> <li>Conveyors</li> <li>Mixers</li> <li>Gate control</li> <li>Machine movement</li> </ul>	<ul style="list-style-type: none"> <li>Small pumps and fans</li> <li>Positive displacement pumps</li> <li>Material handling</li> </ul>
<b>Drives</b>		<b>Altivar 12</b>	<b>Altivar 312</b>
			
Distribution voltage ranges for 50/60 Hz line supply		Single-phase 100–120 V Single-phase 200–240 V Three-phase 200–230 V	Single-phase 200–240 V Three-phase 200–240 V Three-phase 380–500 V Three-phase 525–600 V
Horsepower ratings for three-phase motors		1/4–1 hp, 115/230 V single-phase input 1/4–3 hp, 208/230 V single-phase input 1/4–5 hp, 208/230 V	1/4–3 hp, 208/230 V single-phase input 1/4–20 hp, 208/230 V 1/2–20 hp, 400/480 V 1–20 hp, 525/600 V
		Output frequency	0.5–400 Hz
		Output frequency	0.5–500 Hz
		<b>Type of Control</b>	
Drives	Asynchronous motor	Sensorless flux vector control Kn2 quadratic ratio for pump and fan	Sensorless flux vector control, volts per hertz, Energy saving ratio
	Synchronous motor	—	—
	Transient overtorque	150% to 170% of nominal motor torque	170% to 200% of the nominal motor torque
Functions		40	50
Number of Functions		40	50
Number of I/O	Analog inputs	1	3
	Analog outputs	1	1
	Logic inputs	4	6
	Logic/Relay outputs	1 L.O., 1 N.O./1 N.C. relay contacts	2: 1 N.O./1 N.C. + 1 N.O. relay contacts
Communication	Integrated	Modbus™	Modbus™ and CANOpen
	Available as an option	—	<ul style="list-style-type: none"> <li>DeviceNet</li> <li>Profibus DP</li> <li>CANOpen Daisy Chain</li> <li>Ethernet TCP/IP (gateway)</li> <li>FIPIO (gateway)</li> </ul>
Other Option Cards		—	—
Enclosure Rating		IP20	IP20, Type 1 with optional kit, Type 12 available with ATV31C
Standards and Certifications		EC/EN 61800-5-1, IEC/EN 61800-3 (Environments 1 and 2, categories C1 and C3) CE, UL, CSA, C-Tick, NOM, GOST	EN 50178, EN 61800-3, EN 55011 - EN 55002: class A, class B with option, C-TICK, UL, N998, CE, CSA

**Overview of Altivar™ 320**

Type of Motor Control		Complex Machines	
Key Application/Market Segment		<ul style="list-style-type: none"> <li>• Material handling</li> <li>• Packaging</li> <li>• Textiles</li> <li>• Mechanical actuators</li> <li>• Material working</li> <li>• Hoisting</li> </ul>	
Drives		<b>Altivar 320●●●●●C</b>	<b>Altivar 320●●●●●B</b>
			
Distribution voltage ranges for 50/60 Hz line supply		Single-phase 200–240 V Three-phase 200–240 V Three-phase 380–500 V Three-phase 525–600 V	Single-phase 200–240 V Three-phase 380–500 V
Horsepower ratings for three-phase motors		1/4–3 hp, 200/240 V single-phase input 1/4–20 hp, 200/240 V three-phase input 1/2–5 hp, 380/500 V three-phase input 1–20 hp, 525/600 V three-phase input	1/4–3 hp, 200/240 V single-phase input 1/2–20 hp, 380/500 V three-phase input
		Output frequency 0.1–599 Hz	
		<b>Type of Control</b>	
Drives		Asynchronous motor U/F ratio (2 points, 5 points, energy saving, quadratic), Flux vector control without sensor (Standard and Energy saving)	
		Synchronous motor Vector control without sensor	
		Transient overtorque Up to 200% T <sub>n</sub> in an open loop	
Functions		>150 + ATVLogic	
Number of Functions			
		Analog inputs 3: 1 Bipolar differential ±10 V, 1 with Voltage ±10 V, and 1 with current (0–20 mA)	
		Analog outputs 1: Configurable as voltage (0–10 V) or current (0–20 mA)	
Number of I/O		Logic inputs 6: 4 configurable (positive or negative logic), 1 with PTC probe input, 1 x 20 kHz pulse input	
		Logic/Relay outputs Logic output—1: Configurable as voltage or current Relay outputs—2: 1 with NO/NC contacts and 1 with NC contact	
Communication		Integrated Single port compatible with CANopen and Modbus serial line	
		Available as an option Ethernet IP; Modbus TCP; CANopen RJ45 Daisy Chain, Sub-D, and screw terminals; PROFINET; Profibus DP V1; EtherCAT; DeviceNet; POWERLINK	
Other Option Cards		—	
Enclosure Rating		IP20	IP20
Standards and Certifications		IEC 61800-5-1; IEC 61800-3 (environments 1 and 2, category C2); UL61800–5–1; EN 954–1 category 3; ISO/EN 13849–1/2 category 3 (PLe); IEC 61508 (parts 1 & 2) SIL 2; EN 50495E; IEC 60721–3–3, classes 3C3 and 3S2; CSA C22.2 No. 274; CE, UL, CSA, RCM, EAC, ATEX	

Overview of Altivar™ 340

Type of Motor Control		Complex Machines		
Key Application/Market Segment		<ul style="list-style-type: none"> <li>• Material handling</li> <li>• Packaging</li> <li>• Textiles</li> <li>• Mechanical actuators</li> <li>• Material working</li> <li>• Hoisting</li> </ul>		
Drives		Altivar 340●●●●●●	Altivar 340●●●N4E	
Distribution voltage ranges for 50/60 Hz line supply		Three-phase 380–480 V		
Horsepower ratings for three-phase motors		1–30 hp	1–30 hp	40–100 hp
Output frequency		0.1–599 Hz		
Type of Control				
Drives	Asynchronous motor	Voltage vector control without sensor, Current vector control with sensor, U/F 5 points, Energy saving mode		
	Synchronous motor	Open-loop synchronous motor control (with and without stall monitoring), closed-loop synchronous motor control, synchronous reluctance motor control		
	Transient overtorque	Up to 200% Tn in an open loop	Up to 180% Tn in open or closed loop control	
Functions		>150		
Number of Functions		>150		
Number of I/O	Analog inputs	2: 1 configurable (voltage/current/thermal probe) and 1 with bipolar differential ±10 Vdc		3: Configurable as voltage (0–±10 Vdc) or current (0–20 mA / 4–20 mA), including 2 for probes (PTC, PT100, PT1000, or KTY84)
	Analog outputs	1: Configurable as voltage (0–10 Vdc) or current (x–20 mA)		2: Configurable as voltage (0–10 Vdc) or current (x–20 mA)
	Logic inputs	5 + 2: 5 configurable (positive or negative logic) and 2 which can be configured as digital input or output		8: Configurable (positive or negative logic)
	Logic/Relay outputs	Logic outputs—2: Assignable Relay outputs—2: 1 with NO/NC contacts and 1 with NC contacts		Logic outputs—1: Assignable Relay outputs—3: 1 with NO/NC and 2 with NO contacts
Communication	Integrated	2 ports for Modbus serial line	Dual port for Ethernet IP/Modbus TCP, 2 ports for Modbus serial line	
	Available as an option	<ul style="list-style-type: none"> <li>• CANopen RJ45 Daisy Chain</li> <li>• Sub-D and screw terminals</li> <li>• PROFINET</li> <li>• Profibus DP V1</li> <li>• EtherCAT</li> <li>• DeviceNet</li> </ul>		
Other Option Cards		—		
Enclosure Rating		IP20	IP20	IP20
Standards and Certifications		UL61800-5-1, EN/IEC 61800-3, Environment 1 category C2, EN/IEC 61800-3, Environment 2 category C3, EN/IEC 61800-5-1, IEC 60721-3-3, classes 3C3 and 3S3, IEC 61508, IEC 13849-1, Green Premium, Reach/RoHS, CSA C22.2 No. 274 Ce, UL, CSA, TUV, Green Premium, RoHS, EU, China		





**Overview of Altivar™ 71 and Altivar™ Process 900**

Type of Motor Control		Complex, High-power Machines	
Key Application/Market Segment		<ul style="list-style-type: none"> <li>Material handling</li> <li>High performance movement and regulation</li> <li>Lifts, cranes, hoists</li> <li>Extruders, shredders</li> <li>Presses</li> </ul>	<ul style="list-style-type: none"> <li>Material handling</li> <li>Artificial lift</li> <li>High performance movement and regulation</li> <li>Lifts, cranes, hoists</li> <li>Extruders, shredders</li> <li>Presses</li> <li>Positive displacement pumps</li> </ul>
Drives		<b>Altivar 71</b>	<b>Altivar Process 900</b> <sup>New!</sup>
			
Distribution voltage ranges for 50/60 Hz line supply		Single-phase 230–240 V Three-phase 200–240 V Three-phase 380–480 V Three-phase 500–690 V	Three-phase 200–240 V Three-phase 380–480 V Three-phase 500–600 V Three-phase 500–690 V
Horsepower ratings for three-phase motors		1–30 hp, 208/230 V single-phase input 1/2–100 hp, 200/230 V 1–1800 hp, 400/480 V 2–2100 hp, 575/690 V	1–100 hp, 208/230 V 1–500 hp, 400/480 V 1–100 hp, 400/480 V (ATV950) 3–100 hp, 500/600 V 3–125 hp, 500/690 V
		Output frequency 0.5–599 Hz up to 50 hp 0.5–500 Hz from 50 hp to 700 hp	0.5–599 Hz
<b>Type of Control</b>			
Drives	Asynchronous motor	Sensorless flux vector control (with or without sensor), volts per hertz ratio (2 or 5 points), ENA system, synchronous motor vector control with or without speed feedback	Voltage vector control, current vector control closed loop, 5-segment V/F profile, energy saving, synchronous reluctance motor
	Synchronous motor	Vector control with or without speed feedback	Open loop synchronous motor, closed-loop synchronous motor, open-loop synchronous motor variable torque
	Transient overtorque	220% of the nominal motor torque for 2 seconds 170% for 60 seconds	Normal duty: 120% overcurrent for 60 s. Heavy duty: 150% overcurrent for 60 s.
	Functions Number of Functions	> 150	45+
Number of I/O	Analog inputs	2–4	3–5
	Analog outputs	—	2
	Logic inputs	6–20	8–14
	Logic/Relay outputs	2–4	3–6
	Safety function inputs	—	2
Communication	Integrated	Modbus™ and CANopen	Modbus™ and Ethernet IP /Modbus TCP dual port
	Available as an option	-Profibus DP [V1] -DeviceNet -Modbus TCP/IP -EtherNet/IP and Modbus/TCP Dual port	- CANopen: Daisy Chain RJ45, Sub-D and screw terminals - Profibus - Profibus DP V1 - DeviceNet - EtherCAT
Other Option Cards		Encoder interface cards, I/O extension cards, IMC programmable card	I/O extension cards, Encoder input cards, Resolver input cards
Enclosure Rating		IP20, Type 1 with optional kit	Type 1, Type 12 (ATV950 only)
Standards and Certifications		IEC/EN 61800-5-1, IEC/EN 61800-3 (environments 1 and 2, C1 to C3), EN 55011, EN 55022, IEC/EN 61000-4-2/4-3/4-4/4-5/4-6/4-11, CE, UL, CSA, DNV, C-TICK, NOM 117, GOST, ABS	UL 508C, UL File E116875, CSA, TUV, REACH, UL50, EN/IEC 61800-3, EN/IEC 61800-3 environment 1 category C2, EN/IEC 61800-3 environment 2 category C3, EN/IEC 61800-5-1, IEC 61000-3-12, IEC 60721-3, IEC 61508



Overview of Altivar™ 212 / 61 and Altivar™ Process 600

Type of Motor Control		Centrifugal Pumps and Fans		Pumps and Fans
Key Application/Market Segment		<ul style="list-style-type: none"> <li>• Pumps</li> <li>• Fans</li> </ul>	<ul style="list-style-type: none"> <li>• Pumps</li> <li>• Fans</li> </ul>	<ul style="list-style-type: none"> <li>• Pumps</li> <li>• Fans</li> <li>• General purpose applications in:                             <ul style="list-style-type: none"> <li>– Water &amp; Wastewater</li> <li>– Oil &amp; Gas</li> <li>– Mineral, Mining &amp; Metals</li> <li>– Food &amp; Beverage</li> </ul> </li> </ul>
Drives		Altivar 212	Altivar 61	Altivar Process 600 <i>New!</i>
				
Distribution voltage ranges for 50/60 Hz line supply		Three-phase 200–240 V Three-phase 380–480 V	Three-phase 500–690 V	Three-phase 200–240 V Three-phase 380–480 V Three-phase 500–600 V Three-phase 500–690 V
Horsepower ratings for three-phase motors		1–40 hp, 208/230 V 1–100 hp, 400/480 V	2–900 hp, 575/690 V	1–100 hp, 208/230 V 1–500 hp, 400/480 V 1–100 hp, 400/480 V (ATV650) 3–100 hp, 500/600 V 3–125 hp, 500/690 V
Drives	Output frequency	0–200 Hz	0.5–500 Hz from 50–900 hp	0.1–500 Hz
	<b>Type of Control</b>			
	Asynchronous motor	Volts per hertz or sensorless flux vector control	Volts per hertz ratio (2 or 5 points) or sensorless flux vector control, energy-saving ratio	Voltage/frequency: quadratic, 2 point or 5 points, or optimized for energy savings
	Synchronous motor	Permanent magnet motor control without speed feedback	Vector control without speed feedback	Vector control for permanent magnet motors
Transient overtorque		Transient overload: 110% of the nominal drive current for 60 seconds	170% of the nominal motor torque for 2 seconds 110% for 60 seconds	Normal Duty: 110% of the nominal motor torque for 60 s. Heavy Duty: 150% of the nominal motor torque for 60 s.
Functions		50	> 100	>30 pump dedicated functions, additional for fan and material handling applications
Number of I/O	Analog inputs	2	2–4	3–5
	Analog outputs	1	—	2
	Logic inputs	3	6–20	6–12
	Logic/Relay outputs	2: 1 N.O./1 N.C. and 1 N.O. relay contacts	2–4	3–6
	Safety function inputs	—	—	2
Communication	Integrated	Modbus™, Apogee P1, BACnet, Metasys® N2	Modbus™ and CANopen	Modbus/Ethernet TCP and Modbus Serial Link
	Available as an option	- LonWorks	<ul style="list-style-type: none"> <li>• Apogee FLN ( P1)</li> <li>• BACnet</li> <li>• Modbus/Uni-Telway</li> <li>• LonWorks</li> <li>• EtherNet/IP and Modbus/TCP Dual Port</li> </ul>	<ul style="list-style-type: none"> <li>• Modbus Plus</li> <li>• Interbus S</li> <li>• DeviceNet</li> <li>• Profibus DP [V1]</li> <li>• Metasys N2</li> </ul>
Other Option Cards		—	I/O extension cards, IMC programmable card, Multi-pump cards	I/O extension cards
Enclosure Rating		IP20, Type 1 with optional kit, Type 12 @460 Vac	IP20, Type 1 with optional kit, Type 12 @460 Vac	Type 1, Type 12 (ATV650 only)
Standards and Certifications		EN 50178, IEC/EN 61800-3, EN 55011, 55022: class A, class B with option, CE, UL, C-TICK, N998, UL 1995 Plenum-rated AHRI Certified	IEC/EN 61800-5-1, IEC/EN 61800-3 (environments 1 and 2, C1 to C3), EN 55011, EN 55022, UL 1995 Plenum-rated, IEC/EN 61000-4-2/4-3/4-4/4-5/4-6/4-11, CE, UL, CSA, DNV, C-TICK, NOM 117, GOST, ABS	UL 508C, UL File E116875, CSA, TUV, REACH, UL50, EN/IEC 61800-3, EN/IEC 61800-3 environment 1 category C2, EN/IEC 61800-3 environment 2 category C3, EN/IEC 61800-5-1, IEC 61000-3-12, IEC 60721-3, IEC 61508



**Overview of Altistart™ 01 / 22 / 48**

Type of Motor Control		Simple Machines	Normal-duty Machines	Heavy-duty Machines
Key Application/Market Segment		<ul style="list-style-type: none"> <li>Conveyors</li> <li>Mixers</li> <li>Gate control</li> <li>Machine movement</li> <li>Small pumps and fans</li> <li>Positive displacement pumps</li> </ul>	<ul style="list-style-type: none"> <li>Pumps</li> <li>Fans</li> <li>Turbines</li> <li>Compressors</li> <li>Conveyors</li> <li>Conveyor belts</li> <li>Lifting screws</li> <li>Escalators</li> </ul>	<ul style="list-style-type: none"> <li>Pumps</li> <li>Fans</li> <li>Punch presses</li> <li>Band saws</li> <li>Crushers</li> <li>Centrifuges</li> <li>Conveyors (high inertia loads)</li> </ul>
<b>Soft Starters</b>		<b>Altistart 01</b>	<b>Altistart 22</b>	<b>Altistart 48</b>
				
Distribution voltage ranges for 50/60 Hz line supply		Single-phase 110–480 V Three-phase 110– 690 V	Three-phase 208– 600 Vac	Three-phase 230– 415 V Three-phase 208–690 V
Horsepower ratings for three-phase motors		1/4–2 hp 115/230 V 1/2–30 hp, 208/230 V 1/2–60 hp, 400/480 V 30–75 hp, 575/600 V	3–500 hp	3–1200 hp
Drives	Output frequency	Equals input frequency	—	Equals input frequency
	Type of Control:	Reduced voltage start	Controlled starting and stopping, via voltage and torque	Reduced voltage start Reduced voltage start and torque control stop
	Asynchronous motor			
	Synchronous motor	—	—	—
Typical starts per hour rating	—	6	10	
Functions		1	29	36
Number of I/O	Analog inputs	—	1 PTC probe	1 PTC probe
	Logic inputs	3	3	4
	Relay outputs	1	2 (N.O./N.C)	1
Communication	Integrated	—	Embedded Modbus	Modbus
	Available as an option	Combined with TeSys™ U-Line self-protected starter	—	<ul style="list-style-type: none"> <li>DeviceNet</li> <li>Ethernet TCP/IP</li> <li>Fipio</li> <li>Profibus DP V1</li> </ul>
Other Option Cards		—	—	—
Enclosure Rating		IP20	IP00, IP20	IP20
Standards and Certifications		EC/EN 60947-4/2, C-Tick, CSA, UL, CE, CCC	UL, CSA, CE, GOST, C-TICK, CCC, and RoHS directive	EC/EN 60947-4/2, EMC class A and B, DNV, C-Tick, GOST, CCIB, NOM, UL, CE, CCC, CSA

Overview of S-Flex™ and Altistart™ Enclosed 22 / Enclosed 48

Type of Motor Control	Adjustable Speed Drives Commercial HVAC & Retrofits	Soft Starters Commercial	North America Enclosed Soft Starters
Key Application/Market Segment	<ul style="list-style-type: none"> <li>• Pumps</li> <li>• Fans</li> <li>• Scroll Compressors</li> </ul>	<ul style="list-style-type: none"> <li>• Pumps</li> <li>• Fans</li> <li>• Conveyors</li> <li>• Centrifuges</li> </ul>	<ul style="list-style-type: none"> <li>• Agitators</li> <li>• Mixers</li> <li>• Grinders</li> <li>• Crushers</li> </ul>
Packaged Products	S-Flex (Altivar™ 212)	Altistart Enclosed 22	Altistart Enclosed 48
			 <p>Integrated controls protected within enclosures, optimized with disconnect means, circuit breakers, push buttons, selector switches, control logic, communication and miscellaneous options designed to meet application requirements.</p>
Distribution voltage ranges for 50/60 Hz line supply	208 Vac, 240 Vac, 480 Vac	208 Vac, 230 Vac, 460 Vac, 575 Vac	208 Vac, 240 Vac, 480 Vac, 600 Vac
Horsepower ratings for three-phase motors	<b>Variable torque</b> 1–40 hp, 200/230 V 1–100 hp, 460 V	<b>Type 1 and Type 12:</b> 3–150 hp, 208 V 5–200 hp, 230 V 10–400 hp, 460 V 15–500 hp, 575 V <b>Type 3R or 50 C Rated:</b> 3–125 hp, 208 V 5–150 hp, 230 V 10–400 hp, 460 V 15–500 hp, 575 V	<b>Type 1, Type 12, and Type 3R:</b> 3–200 hp, 208 V 5–250 hp, 230 V 10–500 hp, 480 V 15–600 hp, 575 V
Configurable options	<b>Configurable products:</b> Drive with isolation/bypass Non-bypass Drive input disconnect switch Line contactor Communication options	Basic shunt trip Full featured shunt trip non-reversing isolation Reversion isolation Integral Full Voltage Bypass	<b>Customizable products:</b> Non-reversing Reversing Shunt Trip Extensive options
Enclosure ratings	Type 1 general purpose Type 12 industrial use (Dust-Tight/Drip-Tight) Type 3R outdoor use	Type 1 general purpose Type 12 industrial use (Dust-Tight/Drip-Tight) Type 3R outdoor use	Type 1 general purpose Type 12 dust/drip proof Type 3R outdoor service entrance
Communication	<ul style="list-style-type: none"> <li>• Modbus RJ45 (included as standard)</li> <li>• BACnet (embedded)</li> <li>• LonWorks (option card)</li> <li>• Metasys N2 (embedded)</li> <li>• APOGEE FLN (P1) (embedded)</li> </ul>	<ul style="list-style-type: none"> <li>• Modbus (embedded)</li> </ul>	<ul style="list-style-type: none"> <li>• Modbus (native)</li> <li>• Modbus Plus</li> <li>• Ethernet TCP/IP (gateway)</li> <li>• DeviceNet (gateway)</li> </ul>
Standards and Certifications	UL 508C, Seismic qualification ICC ES AC156 acceptance test protocol	Service Entrance Rating, UL Listed per UL 508 under category NKJH, Conforms to applicable NEMA ICS, NFPA, and IEC standards, Manufactured under ISO9001 standards, Factory modification E10 provides Canadian cUL certification per C22.2, No.14, Seismic qualification	UL 508, cUL/CSA, Seismic qualification ICC ES AC156 acceptance test protocol, ABS

**Overview of Altivar™ 680/980 Process, 660/960 Process, and Altivar™ 1260**

North America Drive Systems															
Key Applications and Market Segment	<ul style="list-style-type: none"> <li>Water Waste Water</li> <li>Regenerative Applications</li> <li>Oil and Gas</li> <li>Mining, Minerals, and Metals</li> <li>Food and Beverage</li> </ul>	<ul style="list-style-type: none"> <li>Water Waste Water</li> <li>Regenerative Applications</li> <li>Oil and Gas</li> <li>Mining, Minerals, and Metals</li> <li>Food and Beverage</li> </ul>	Pumps, fans, and compressors for: <ul style="list-style-type: none"> <li>Water Waste Water</li> <li>Oil and Gas</li> <li>Mining, Minerals, and Metals</li> </ul>												
	<b>Altivar 680/980 Process Drives</b> <i>New!</i>	<b>Altivar 660/960 Process Drives</b>	<b>Altivar 1260 Medium Voltage Drive</b>												
															
Brief Description	<p>The world's first three-level low harmonic drive, Altivar 680/980 drive solutions are designed for pumping or mechanical movement applications where harmonic mitigation and overall size is a priority. The ATV680/980 has embedded, industry-leading harmonic mitigation technology, which results in THDI levels of 2.3%. With its small footprint and capability to be customized, the ATV680/980 is a very flexible low harmonic solution.</p> <p>The ATV680/980 is a more efficient, more compact, and higher performing active rectification drive than any of our competitors by the integration of a common mode suppressing filter, and unique active filter resonance control. The ATV680 is capable of 120% regeneration, while the ATV980 is capable of 180% of nameplate current.</p>	<p>The Altivar 660 Process System provides a wide range of fully tested and ready to connect drive solution. Starting from a compact pre engineered system to a fully engineered complex solution.</p>	<p>The Altivar 1260 combines the latest vector control strategies with the control of 3-level inverters using proven semiconductor technologies commanded via fiber optic cables. Engineered from the inside-out to reduce harmful grid harmonics and put less stress on motor bearings and insulation.</p>												
Special Features	Industry Leading Harmonic Mitigation: 2.3% THDI Common Mode Voltage Suppression Reduction of Bearing Currents Generator Supply Capability	Compact design to save space Dynamic QR Codes 50° C option available Pump curves embedded Multiple options available Process control embedded Embedded web server	Low component count 24/36 pulse rectifier (AFE option available) with 3-level NPC inverter using medium voltage IGBTs. Standard output sine wave filter delivers a motor friendly waveform, which allows long cable lengths and use with standard duty motors. Close-coupled or separately-located rectifier transformer Easy to navigate local human machine interface (HMI) plus a web application for remote monitoring and control Front access with easy to maintain slide out power modules Integrated UPS for control backup Powerful central processor (CPU) with imbedded programmable controller (PLC) Modular and scalable architecture												
Enclosure Ratings	UL Type 12	UL Type 1, UL Type 12, UL Type 3R	NEMA Type 1 (IP21)												
Power Range	125–900 hp, Normal Duty (ND)	<table border="1"> <tr> <td></td> <td>208/340 V</td> <td>460 V</td> </tr> <tr> <td>Type 1</td> <td>1–60 hp</td> <td>1–900 hp, ND</td> </tr> <tr> <td>Type 12</td> <td>1–60 hp</td> <td>1–900 hp, ND</td> </tr> <tr> <td>Type 3R</td> <td>1–60 hp</td> <td>1–125 hp, ND</td> </tr> </table>		208/340 V	460 V	Type 1	1–60 hp	1–900 hp, ND	Type 12	1–60 hp	1–900 hp, ND	Type 3R	1–60 hp	1–125 hp, ND	Top forced air cooling <b>Frame 1:</b> up to 2,400 hp <b>Frame 2:</b> 2,500–4,800 hp <b>Frame 3:</b> 4,900–6,500 hp
	208/340 V	460 V													
Type 1	1–60 hp	1–900 hp, ND													
Type 12	1–60 hp	1–900 hp, ND													
Type 3R	1–60 hp	1–125 hp, ND													
Distribution voltage ranges for 50/60 Hz line supply	480 Vac	208/240 Vac, 480 Vac	4,160 Vac, 3 phase, 60 Hz (drive input) <b>NOTE:</b> Primary side of rectifier transformer can accommodate other voltages												
Standards / Certifications	UL/cUL Listed per UL508A, IEEE519 Compliant (harmonic filter required), Conforms to applicable NEMA ICS, NFPA, and IEC standards. Service entrance available, Manufactured under ISO 9001 standards.	UL/cUL Listed per UL508A, IEEE519 Compliant, Conforms to applicable NEMA ICS, NFPA, and IEC standards. Service entrance available, Manufactured under ISO 9001 standards.	UL/cUL listed per UL347, IEEE 519 Compliant (24 pulse DFE), Conforms to applicable ANSI/IEEE and IEC standards, Manufactured under ISO 9001 standards.												

Contact your local Schneider Electric Field Office for further information

Overview of Altivar™ Outdoor 630/930



Altivar Outdoor 630/930

Key Application/Market Segment	<ul style="list-style-type: none"> <li>Oil and Gas</li> <li>Rod Pump Controls, PCP Controls</li> <li>ESP Controls, HPS Controls</li> <li>Irrigation</li> </ul>
Brief Description	The Altivar Outdoor 630/930 is a UL Type 3R rated drive designed for pumping solutions in outdoor environments, especially oil and gas.
Special Features	<ul style="list-style-type: none"> <li>Door-on-door</li> <li>-50 °C rated</li> <li>Optional cold weather option</li> <li>Wide array of options available</li> <li>Quick lead time</li> </ul>
Enclosure Ratings	Nema Type 3R Outdoor
Power Range	20–250 hp, Heavy Duty
Distribution Voltage Ranges for 50/60 Hz Line Supply	480 Vac
Standards / Certifications	<ul style="list-style-type: none"> <li>UL Listed per UL 508A</li> <li>Conforms to applicable NEMA ICS, NFPA, &amp; IEC standards</li> <li>Service entrance rated</li> <li>Manufactured under ISO 9001 standards</li> </ul>
Contact your local Schneider Electric Field Office for further information	

Altivar™ 212 Drives

The AHRI (Air-Conditioning, Heating, & Refrigeration Institute) certified Altivar 212 drive is for use with three-phase asynchronous and permanent magnet motors for variable torque pump, fan, and scroll compressor applications. Select the Altivar 212 drive using the motor nameplate voltage, the full load ampere rating and the table below. The Altivar 212 drive includes 3 logic inputs, 2 analog inputs, 1 analog output, and 2 relay outputs (with 1 NO and 1 NO/NC contacts). The Altivar 212 drive includes an integrated 4 digit, 7 segment LED display with a 7 button keypad and includes an RJ45 Modbus port plus a four-screw terminal block for BACnet, Modbus, Metasys N2 and Apogee P1 communication protocols. LonWorks™ is available in an option card.



ATV212HU15N4



ATV212W075N4



ATV212HU30M3X



ATV212HD37N4

Table 26.1: Altivar 212 Selection

AC Input Line Voltage	Three-Phase Motor Power [1]		Continuous Output Current A [1]	IP 20[2] Open Style Product	Enclosure Rating	
	HP	kW			Type 1 Conduit Kit Purchase ATV212 and Conduit Kit for Type 1 Installation	Type 12 / IP54[3]
	HP	kW	A [1]	Catalog Number	Catalog Number	Catalog Number
200/240 Vac -15%, +10% Three-Phase	1	0.75	4.6	ATV212H075M3X	VW3A31814	—
	2	1.5	7.5	ATV212HU15M3X	VW3A31814	—
	3	2.2	10.6	ATV212HU22M3X	VW3A31814	—
	4	3	13.7	ATV212HU30M3X	VW3A31815	—
	5	4	18.7	ATV212HU40M3X	VW3A31815	—
	7.5	5.5	24.2	ATV212HU55M3X	VW3A31816	—
	10	7.5	32	ATV212HU75M3X	VW3A31816	—
	15	11	46.2	ATV212HD11M3X	VW3A31817	—
	20	15	61	ATV212HD15M3X	VW3A31817	—
	25	18.5	74.8	ATV212HD18M3X	VW3A31817	—
	30	22	88	ATV212HD22M3X	VW3A9206	—
	40	30	117	ATV212HD30M3X	VW3A9208	—
380/480 Vac -15%, +10% Three-Phase	1	0.75	2.2	ATV212H075N4	VW3A31814	ATV212W075N4
	2	1.5	3.7	ATV212HU15N4	VW3A31814	ATV212WU15N4
	3	2.2	5.1	ATV212HU22N4	VW3A31814	ATV212WU22N4
	4	3	7.2	ATV212HU30N4	VW3A31815	ATV212WU30N4
	5	4	9.1	ATV212HU40N4	VW3A31815	ATV212WU40N4
	7.5	5.5	12	ATV212HU55N4	VW3A31815	ATV212WU55N4
	10	7.5	16	ATV212HU75N4	VW3A31816	ATV212WU75N4
	15	11	22.5	ATV212HD11N4	VW3A31816	ATV212WD11N4
	20	15	30.5	ATV212HD15N4	VW3A31817	ATV212WD15N4
	25	18.5	37	ATV212HD18N4	VW3A31817	ATV212WD18N4
	30	22	43.5	ATV212HD22N4S	VW3A31817	—
	30	22	43.5	ATV212HD22N4	VW3A9206	ATV212WD22N4
	40	30	58.5	ATV212HD30N4	VW3A9206	ATV212WD30N4
	50	37	79	ATV212HD37N4	VW3A9207	ATV212WD37N4
	60	45	94	ATV212HD45N4	VW3A9207	ATV212WD45N4
	75	55	116	ATV212HD55N4	VW3A9208	ATV212WD55N4
	100	75	160	ATV212HD75N4	VW3A9208	ATV212WD75N4

UL File E116875, CSA 2278406, Plenum rated per UL 508C for UL 1995 installations. NOM, CE

[1] These horsepower, wattage and continuous ampere ratings apply to the default switching frequency and maximum 40 °C ambient. Refer to the installation manual for derating curves as a function of switching frequency, ambient temperature, and mounting conditions.

[2] IP20 Altivar 212 drives can be installed as UL Type 1 with an optional conduit box by following the instructions in the Installation Manual.

[3] For ATV212W... drives with Class B EMC filter, add the letter "C" to the end of the standard catalog number.



VW3A1101



VW3A8121



VW3A1101  
VW3A1102  
VW3A1103  
VW3A1104R10



LonWorks Option Card  
VW3A21212

## Altivar™ 212 Accessories

Table 26.2: Altivar 212 Options and Accessories

	Description	For Use on Drives	Catalog Number
<b>User Interface Options</b>			
Remote LCD Display Keypad	8 line, 24 characters per line, plain text, 8 keys, rotary wheel, 60 °C IP54 rated	Altivar 212, 312, 32, 61, and 71	VW3A1101 [4]
Remote LCD Keypad Mounting Accessories	IP54 rated kit for remote mounting LCD keypad on enclosure door. Clear plastic door for use with VW3A1102 for IP65 rating and tamper resistant. Female / Female right-angle RJ45 adaptor, to connect cable and keypad. [5]	VW3A1101	VW3A1102 [4]
		VW3A1102	VW3A1103 [4]
	VW3A1101	VW3A1105 [4]	
	Remote LCD Keypad Mounting Cables — Equipped with two RJ45 connectors	VW3A1101	VW3A1104R10 [6]
	1 meter length 3 meter length 5 meter length 10 meter length	VW3A1101	VW3A1104R30 [6] VW3A1104R50 [6] VW3A1104R100 [6]
Multi-loader	Use to copy configurations between like drives, PC Soft, or SoMove PC Software	Altivar 12, 212, 312, 32, 61, 71, and Altistart 22	VW3A8121
Potentiometer	Operator, mounting collar, 2.5 kilohm, ½ watt potentiometer	Altivar 212	ATVPOT25K
<b>Software</b>			
Altivar and Altistart Programming Cable	For use with the iPad Configuration App. 30-pin Mobile to RS-485 Converter Cable	Altivar 12, 312, 212, and SFLEX, Altistart 22, 48	VW3A8151R20U
SoMove	This software enables the user to configure, set, debug and organize maintenance task for the complete Altivar product line and the Altistart 22 and Altistart 48 soft starters. It can also be used to customize the integrated display terminal menus. It can be used with a direct connection or a Bluetooth® wireless connection. Free download <a href="http://www.schneider-electric.us">www.schneider-electric.us</a>		
USB/RS485 cable: equipped with USB connector and RJ45 connector		Altivar and Altistart	TCSMCNAM3M002P [6]
<b>Communication Option</b>			
LonWorks Communication Card Option	Provides a four-screw terminal block for connection to LonWorks network. Install in place of standard control board that comes mounted in the Altivar 212 drive. The I/O count is reduced to 3LI, 1 AI and 1 NO/NC relay	Altivar 212	VW3A21212
<b>Mounting Kit</b>			
DIN Rail Mounting Kit	For installation on 35 mm wide DIN rail	Altivar 212H075M3X–U22M3X Altivar 212H075N4–U22N4	VW3A31852

[4] IP20 Altivar 212 drives can be installed as UL Type 1 with an optional conduit box by following the instructions in the installation manual.

[5] Not required if using VW3A1102.

[6] For ATV212W... drives with Class B EMC filter, add the letter "C" to the end of the standard catalog number.

Altivar™ 12 Drives

Big function in a small footprint. The Altivar 12 variable frequency drive combines flexibility, reliability, and the most advanced sensorless flux vector technology into very small space. This drive features an integrated communications port, user-friendly navigation wheel on the faceplate, and an optional multi-loader that streamlines set-up by making programming quick and easy. All of this comes with the versatility to handle applications from simple to complex, across industries, and harsh environments.



Altivar 12 Drive

Table 26.3: Altivar 12 Selection

Voltage, +10%, -15%, 50/60 Hz		Motor Power		Nominal Current Rating A (Note 1)	Catalog Number (Note 2)
Input	Output	kW	hp		
11 V Single Phase	230 V Three Phase	0.18	0.25	1.4	ATV12H018F1
		0.37	0.5	2.4	ATV12H037F1
		0.37	0.5	2.4	ATV12P037F1
		0.75	1	4.2	ATV12H075F1
230 V Single Phase	230 V Three Phase	0.18	0.25	1.4	ATV12H018M2
		0.37	0.5	2.4	ATV12H037M2
		0.37	0.5	2.4	ATV12P037M2
		0.55	0.75	3.5	ATV12H055M2
		0.55	0.75	3.5	ATV12P055M2
		0.75	1	4.2	ATV12H075M2
		0.75	1	4.2	ATV12P075M2
		1.5	2	7.5	ATV12HU15M2
		2.2	3	10	ATV12HU22M2
		230 V Three Phase	230 V Three Phase	0.18	0.25
0.37	0.5			2.4	ATV12H037M3
0.37	0.5			2.4	ATV12P037M3
0.75	1			4.2	ATV12H075M3
0.75	1			4.2	ATV12P075M3
1.5	2			7.5	ATV12HU15M3
1.5	2			7.5	ATV12PU15M3
2.2	3			10	ATV12HU22M3
2.2	3			10	ATV12PU22M3
3	-			12.2	ATV12HU30M3
3	-			12.2	ATV12PU30M3
3.7	5			16.7	ATV12HU40M3
3.7	5			16.7	ATV12PU40M3

Altivar™ 12 Accessories

Table 26.4: Altivar 12 Options and Accessories

Description	Part Number	For Use on Drives
Remote Keypad Display for ATV12 (IP54)	VW3A1006	All
Remote Keypad Display for ATV12 (IP65)	VW3A1007	All
Cable for remote mounting: 1 meter	VW3A1104R10	All
Cable for remote mounting: 3 meters	VW3A1104R30	All
Cable for remote mounting: 5 meters	VW3A1104R50	All
Cable for remote mounting: 10 meters	VW3A1104R100	All
EMC Conformity Kit	VW3A9523	ATV12H018F1, H037F1 ATV12H018M2-H075M2 ATV12H018M3-H075M3 ATV12P037F1 ATV12P037M2-P075M2 ATV12P037M3-P075M3
EMC Conformity Kit	VW3A9524	ATV12H075F1 ATV12HU15M2, HU22M2 ATV12HU15M3, HU22M3 ATV12PU15M3, PU22M3
EMC Conformity Kit	VW3A9525	ATV12HU30M3 ATV12HU40M3
EMC Filters for C1, C2, C3	VW3A4416	ATV12H018F1, H037F1 ATV12H018M2-H075M2 ATV12P037F1 ATV12P037M2-P075M2
EMC Filters for C1, C2, C3	VW3A4417	ATV12H075F1 ATV12HU15M2, HU22M2
EMC Filters for C1, C2, C3	VW3A4418	ATV12H018M3-H075M3 ATV12P037M3-P075M3
EMC Filters for C1, C2, C3	VW3A4419	ATV12HU15M3, HU22M3 ATV12PU15M3, PU22M3
15/24 voltage converter	VW3A9317	All
Mounting Plate for 35 mm DIN rail	VW3A9804	ATV12H018F1, H037F1 ATV12H018M2-H075M2 ATV12H018M3-H075M3
Mounting Plate for 35 mm DIN rail	VW3A9805	ATV12H075F1 ATV12HU15M2, HU22M2 ATV12HU15M3, HU22M3

Table 26.5: Altivar 12 Configuration Tools

Description	Part Number	For Use on Drives
Simple Loader: to transfer configuration between like drives. For use with the Altivar product line.	VW3A8120	ATV12, ATV312, ATV61, and ATV71
Multi-loader: to transfer a configuration from a drive or from SoMove via an SD card, and transferring to another drive or to a PC	VW3A8121	ATV12, ATV312, ATV61, and ATV71
Cable: for connection between the MultiLoader and an ATV12 that is in its packaging	VW3A8126	All
USB to RJ45 adaptor: for use in connecting to a PC with a USB port	TCSMCNAM3M002P	Compatible device families: Advantys™ OTB, Altistart™ soft starters, Altivar series including HMI, Altivar controller



**Altivar™ 312 Drives**

The Altivar 312 mid-featured AC drive is designed to make industrial and commercial machines more energy efficient while simplifying its integration into a single control system architecture.

With the highest overtorque and the only drive with a remote graphic keypad in its class, the Altivar 312 mini-drive is ideally suited to the needs of material handling, packaging, food and beverage, and other OEM machines. It also comes standard with integrated communications port for Modbus and CANopen networks, optional cards available for CANopen Daisy Chain, DeviceNet, and Profibus DP, and gateways can be used for Modbus TCP/IP and FIPIO.



**Table 26.6: Altivar 312 Selection**

Input Line Voltage	Three-Phase Motor Power <sup>[7]</sup>		Open Drives <sup>[8]</sup>	
	HP	kW	Continuous Output Current	Catalog Number
			A	
208/230 Vac Single-Phase	0.25	0.18	1.5	ATV312H018M2
	0.5	0.37	3.3	ATV312H037M2
	0.75	0.55	3.7	ATV312H055M2
	1	0.75	4.6	ATV312H075M2
	1.5	1.1	6.9	ATV312HU11M2
	2	1.5	8	ATV312HU15M2
	3	2.2	11	ATV312HU22M2
208/230 Vac Three-Phase	0.25	0.18	1.5	ATV312H018M3
	0.5	0.37	3.3	ATV312H037M3
	0.75	0.55	3.7	ATV312H055M3
	1	0.75	4.8	ATV312H075M3
	1.5	1.1	6.9	ATV312HU11M3
	2	1.5	8	ATV312HU15M3
	3	2.2	11	ATV312HU22M3
	4	3	13.7	ATV312HU30M3
	5	—	17.5	ATV312HU40M3
	7.5	5.5	27.5	ATV312HU55M3
	10	7.5	33	ATV312HU75M3
	15	11	54	ATV312HD11M3
20	15	66	ATV312HD15M3	
400/480 Vac Three-Phase	0.5	0.37	1.5	ATV312H037N4
	0.75	0.55	1.9	ATV312H055N4
	1	0.75	2.3	ATV312H075N4
	1.5	1.1	3	ATV312HU11N4
	2	1.5	4.1	ATV312HU15N4
	3	2.2	5.5	ATV312HU22N4
	4	3	7.1	ATV312HU30N4
	5	—	9.5	ATV312HU40N4
	7.5	5.5	14.3	ATV312HU55N4
	10	7.5	17	ATV312HU75N4
575/600 Vac Three-Phase <sup>[9]</sup>	1	0.75	1.7	ATV312H075S6
	2	1.5	2.7	ATV312HU15S6
	3	2.2	3.9	ATV312HU22S6
	5	3.7/4.0	6.1	ATV312HU40S6
	7.5	5.5	9	ATV312HU55S6
	10	7.5	11	ATV312HU75S6
	15	11	17	ATV312HD11S6
	20	15	22	ATV312HD15S6

<sup>[7]</sup> These horsepower, wattage, and continuous ampere ratings apply to 4 kHz switching frequency and maximum 50 °C ambient. Refer to the installation manual for derating curves as a function of switching frequency, ambient temperature, and mounting conditions.  
<sup>[8]</sup> Open type Altivar 312 Drives can be installed as UL Type 1 with optional conduit box when following instructions in the installation manual.  
<sup>[9]</sup> A minimum 3% line reactor is required on all 575 V drive installations.

Altivar™ 312 Options and Accessories

Table 26.7: Altivar 312 Options and Accessories

Software	Description	For Use on Drives	Catalog Number
SoMove™	This software enables the user to configure, set, debug and organize maintenance task for the complete Altivar product line and the Altistart 22 and Altistart 48 soft starters. It can also be used to customize the integrated display terminal menus. It can be used with a direct connection or a Bluetooth® wireless connection. Free download www.schneider-electric.us		
<b>User Interface Kits</b>			
USB to RJ45 Adaptor Kit	For use in connecting to a PC with a USB port	Advantys™ OTB, Altistart™ soft starters, Altivar series including HMI, Altivar controller	TCSMCNAM3M002P
Remote Keypad Options and Accessories	Remote Keypad Display (IP54)	ATV312, ATV12	VW3A1006
	Remote Keypad Display (IP65)	ATV312, ATV12	VW3A1007
	Remote Keypad Display and Mounting Kit	ATV312	VW3A31101
	Remote Keypad Display	ATV312, ATV61, ATV71	VW3A1101 [10]
Cable for remote mounting LCD graphic keypad. RJ-45 connector on each end.	1 meter	Any ATV61, Any ATV71	VW3A1104R10
	3 meters	Any ATV61, Any ATV71	VW3A1104R30
	5 meters	Any ATV61, Any ATV71	VW3A1104R50
	10 meters	Any ATV61, Any ATV71	VW3A1104R100
Communication Options	Profibus	ATV312	VW3A31207
	CANopen Daisy Chain	ATV312	VW3A31208
	DeviceNet	ATV312	VW3A31209

NOTE: Refer to Catalog MKTED211041EN-US for communication cables.

Table 26.8: Altivar 312 Configuration Tools

Description	Part Number	For Use on Drives
Altivar and Altistart Programming Cable: For use with the iPad Configuration App. 30-Pin Mobile to RS-485 Converter Cable	VW3A8151R20U	Altivar 12, 312, 212, S-FLEX, Altistart 22, 48
Simple Loader: to transfer configuration between like drives. For use with the Altivar product line.	VW3A8120	ATV12, ATV312, ATV32, ATV61, and ATV71
Multi-loader: to copy a configuration from a drive or from SoMove via an SD card, and transferring to another drive or to a PC	VW3A8121	ATV12, ATV312, ATV212, ATV32, ATV61, ATV71, and ATS22

Table 26.9: Altivar 312 Options—Field Installed Kits

Description	For Use on Drives	Catalog Number	
DIN Rail Mount Kit	ATV312H018M2, ATV312H037M2, ATV312H055M2, ATV312H075M2, ATV312H018M3, ATV312H037M3, ATV312H055M3, ATV312H075M3	VW3A9804	
	ATV312HU11M2, ATV312HU15M2, ATV312HU11M3, ATV312HU15M3, ATV312HU22M3, ATV312H037N4, ATV312H055N4, ATV312H075N4, ATV312HU11N4, ATV312HU15N4, ATV312H075S6, ATV312HU15S6	VW3A9805	
Conduit Entrance Kit	ATV312H018M2, ATV312H037M2, ATV312H055M2, ATV312H075M2	VW3A31812	
	ATV312H018M3, ATV312H037M3, ATV312H055M3, ATV312H075M3	VW3A31811	
	ATV312HU11M3, ATV312HU15M3	VW3A31813	
	ATV312HU11M2, ATV312HU15M2, ATV312HU22M3, ATV312H037N4, ATV312H055N4, ATV312H075N4, ATV312HU11N4, ATV312HU15N4, ATV312H075S6, ATV312HU15S6	VW3A31814	
	ATV312HU22M2, ATV312HU30M3, ATV312HU40M3, ATV312HU22N4, ATV312HU30N4, ATV312HU40N4, ATV312HU22S6, ATV312HU40S6	VW3A31815	
	ATV312HU55M3, ATV312HU75M3, ATV312HU55N4, ATV312HU75N4, ATV312HU55S6, ATV312HU75S6	VW3A31816	
	ATV312HD11M3, ATV312HD15M3, ATV312HD11N4, ATV312HD15N4, ATV312HD11S6, ATV312HD15S6	VW3A31817	
230/460 V	See Price Guide 8800PL9701.		
Line Reactors	Open Style	ATV312H075S6	RL00202
		ATV312HU15S6	RL00403
		ATV312HU22S6	RL00803
		ATV312HU40S6	RL00802
		ATV312HU55S6	RL01202
		ATV312HD11S6	RL01802
		ATV312HD15S6	RL02502
		ATV312H075S6	RL00212
	Enclosed (Type 1)	ATV312HU15S6	RL00413
		ATV312HU22S6	RL00813
		ATV312HU40S6	RL00812
		ATV312HU55S6	RL01212
		ATV312HD11S6	RL01812
		ATV312HD15S6	RL02512
		ATV61/71HD18M3X-HD22M3X, ATV61/71HD22N4	VW3A9404
		ATV61/71HD30N4-HD37N4	VW3A9405
Fan Kit	ATV61/71HD30M3X-HD45M3X	VW3A9406	
	ATV61/71HD45N4-HD75N4	VW3A9407	

[10] Refer to 26-14 for remote mounting kit and IP65 option for this keypad.

### Altivar™ 320 Machine

The new benchmark in machine performance. Altivar 320, part of the new Altivar™ Machine range, is a powerful combination of safety, reliability, and simplicity which makes it a versatile choice that reduces costs both during installation and throughout the machine's life cycle. Altivar 320 has a number of out-of-the-box features for building more effective machines.



ATV320HU15M2



ATV320U04M2C

Table 26.10: Altivar 320 Selection

Input Line Voltage <sup>[11]</sup>	HP	kW	Continuous Output Current	Catalog Number	Catalog Number
			A	Compact	Book
208/230 Vac Single-Phase	0.25	0.18	1.5	ATV320U02M2C	ATV320U02M2B
	0.5	0.37	3.3	ATV320U04M2C	ATV320U04M2B
	0.75	0.55	3.7	ATV320U06M2C	ATV320U06M2B
	1	0.75	4.6	ATV320U07M2C	ATV320U07M2B
	1.5	1.1	6.9	ATV320U11M2C	ATV320U11M2B
	2	1.5	8	ATV320U15M2C	ATV320U15M2B
	3	2.2	11	ATV320U22M2C	ATV320U22M2B
208/230 Vac Three-Phase	0.25	0.18	1.5	ATV320U02M3C	—
	0.5	0.37	3.3	ATV320U04M3C	—
	0.75	0.55	3.7	ATV320U06M3C	—
	1	0.75	4.8	ATV320U07M3C	—
	1.5	1.1	6.9	ATV320U11M3C	—
	2	1.5	8	ATV320U15M3C	—
	3	2.2	11	ATV320U22M3C	—
	4	3	13.7	ATV320U30M3C	—
	5	—	17.5	ATV320U40M3C	—
	7.5	5.5	27.5	ATV320U55M3C	—
	10	7.5	33	ATV320U75M3C	—
	15	11	54	ATV320D11M3C	—
20	15	66	ATV320D15M3C	—	
400/480 Vac Three-Phase	0.5	0.37	1.5	ATV320U04N4C	ATV320U04N4B
	0.75	0.55	1.9	ATV320U06N4C	ATV320U06N4B
	1	0.75	2.3	ATV320U07N4C	ATV320U07N4B
	1.5	1.1	3	ATV320U11N4C	ATV320U11N4B
	2	1.5	4.1	ATV320U15N4C	ATV320U15N4B
	3	2.2	5.5	ATV320U22N4C	ATV320U22N4B
	4	3	7.1	ATV320U30N4C	ATV320U30N4B
	5	—	9.5	ATV320U40N4C	ATV320U40N4B
	7.5	5.5	14.3	—	ATV320U55N4B
	10	7.5	17	—	ATV320U75N4B
15	11	27.7	—	ATV320D11N4B	
20	15	33	—	ATV320D15N4B	
575/600 Vac Three-Phase	1	0.75	1.7	ATV320U07S6C	—
	2	1.5	2.7	ATV320U15S6C	—
	3	2.2	3.9	ATV320U22S6C	—
	5	3.7/4.0	6.1	ATV320U40S6C	—
	7.5	5.5	9	ATV320U55S6C	—
	10	7.5	11	ATV320U75S6C	—
15	11	17	ATV320D11S6C	—	
20	15	22	ATV320D15S6C	—	

[11] Reference the ATV320 Getting Started Annex SCCR NVE21777 for SCCR ratings, branch circuit protection, and additional single phase ratings.

## Altivar™ 320 Accessories

Table 26.11: Altivar 320 Accessories

Catalog Number	Description
VW3A1006	Remote display terminal, IP54
VW3A1007	Remote display terminal, IP65
VW3A1104R10	Remote-mounting cord set, 1 m (3.28 ft)
VW3A1104R30	Remote-mounting cord set, 3 m (9.84 ft)
VW3A1104R50	Remote-mounting cord set, 5 m (16.4 ft)
VW3A1104R100	Remote-mounting cord set, 10 m (32.81 ft)
VW3A1101	Remote graphic display terminal
VW3A1105	Female/female RJ45 adapter for use with VW3A1101
VW3A1102	Remote mounting kit for use with VW3A1101
VW3A1103	Door for use with VW3A1102
VW3A1111	Advanced graphic display
VW3A1112	Remote mounting kit for use with VW3A1111
VW3A8120	Simple Loader configuration tool
VW3A8121	Multi-Loader configuration tool
VW3A8126	Cord set for Multi-Loader tool
TCSWAAC13FB	Universal Bluetooth Interface
VW3A3600	Communication module adapter for ATV320 Compact
VW3A3608	CANopen daisy chain communication module, two RJ45 ports
VW3A3618	CANopen daisy chain communication module, 9-pin male SUB-D connector
VW3A3628	CANopen daisy chain communication module, removable 5-position screw connector
VW3CANCARR03	CANopen cable with 2 RJ45 connectors, 0.3 m
VW3CANCARR1	CANopen cable with 2 RJ45 connectors, 1 m
TCSCAR013M120	CANopen end-of-line terminator with RJ45 connector
VW3CANTAP2	IP20 CANopen junction boxes
VW3A3616	Modbus TCP and EtherNet/IP network module
VW3A3607	PROFIBUS DP V1 communication module
VW3A3609	DeviceNet communication module
VW3A3601	EtherCAT communication module
VW3A3619	Ethernet POWERLINK communication module
VW3A3627	ProfiNet communication module
VW3A3620	Speed monitoring module
VW3A9804	DIN Rail Mounting Kit for use with ATV320U02M-C-ATV320U07M-C
VW3A9805	DIN Rail Mounting Kit for use with ATV320U11M-C-ATV320U22M-C, ATV320U04N4C-ATV320U15N4C, ATV320U07S6C, ATV320U15S6C
VW3A95811	UL Type 1 conformity kit for use with ATV320U02M-C-ATV320U07M-C
VW3A95812	UL Type 1 conformity kit for use with ATV320U11M2C-ATV320U22M2C, ATV320U04N4C-ATV320U15N4C, ATV320U07S6C, ATV320U15S6C
VW3A95813	UL Type 1 conformity kit for use with ATV320U11M3C-ATV320U22M3C
VW3A95814	UL Type 1 conformity kit for use with ATV320U22N4C-ATV320U40N4C, ATV320U22S6C, ATV320U40S6C
VW3A95815	UL Type 1 conformity kit for use with ATV320U30M3C-ATV320U40M3C
VW3A95816	UL Type 1 conformity kit for use with ATV320U55M3C-ATV320U75M3C, ATV320U55S6C, ATV320U75S6C
VW3A95817	UL Type 1 conformity kit for use with ATV320U55N4B, ATV320U75N4B
VW3A95818	UL Type 1 conformity kit for use with ATV320D11M3C-ATV320D15M3C, ATV320D11S6C, ATV320D15S6C
VW3A95819	UL Type 1 conformity kit for use with ATV320D11N4B, ATV320D15N4B
VW3A9920	Adapter for mounting the control module at 90° for use with ATV320***M2B, ATV320U04N4B-ATV320U40N4B
VW3A9921	Bracket for GV2/ATV320B direct mounting for use with ATV320***M2B, ATV320U04N4B-ATV320U40N4B
GV2AF5	Adapter plate when using GV2 with ATV320 for use with ATV320***M2B, ATV320U04N4B-ATV320U40N4B
VW3M7101R01	Daisy chain DC bus cord with two connectors for use with ATV320***M2B, ATV320U04N4B-ATV320U40N4B
VW3M7102R150	Daisy chain DC bus cord with one connector and flying leads at one end; Shielded cable for use with ATV320***N4B
VW3M2207	Daisy chain DC bus cord with two connectors Connection kit for VW3M7102R150 Cable for use with ATV320***N4B



Altivar 340 Machine Drives

**Altivar™ 340 Machine**

Stay on top of the Smart Machine Era! Altivar Machine ATV340 is engineered for high performance application requirements by maximizing the machine performance thanks to real time variable speed drive operation, more connectivity, flexibility, and scalable safety. The ATV340 is available from 1 to 100 hp with the ability to control any kind of motor in open and closed loop.

**Table 26.12: Altivar 340 Selection**

Drive	Normal Duty			Heavy Duty			Catalog Number
	hp	kW	Continuous Output Current	hp	kW	Continuous Output Current	
			A			A	
400/480 Vac Three-Phase Modular Drive	1.5	1.1	2.6	1	0.75	2.1	ATV340U07N4
	3	2.2	4.8	2	1.5	3.4	ATV340U15N4
	3	3	6.8	3	2.2	4.8	ATV340U22N4
	5	4	7.6	3	3	6.2	ATV340U30N4
	7.5	5.5	11	5	4	7.6	ATV340U40N4
	10	7.5	14	7.5	5.5	11	ATV340U55N4
	15	11	21	10	7.5	14	ATV340U75N4
	20	15	27	15	11	21	ATV340D11N4
	25	18.5	34	20	15	27	ATV340D15N4
	30	22	40	25	18.5	34	ATV340D18N4
40	30	52	30	22	40	ATV340D22N4	
400/480 Vac Three-Phase Ethernet Drive	1.5	1.1	2.6	1	0.75	2.1	ATV340U07N4E
	3	2.2	4.8	2	1.5	3.4	ATV340U15N4E
	3	3	6.8	3	2.2	4.8	ATV340U22N4E
	5	4	7.6	3	3	6.2	ATV340U30N4E
	7.5	5.5	11	5	4	7.6	ATV340U40N4E
	10	7.5	14	7.5	5.5	11	ATV340U55N4E
	15	11	21	10	7.5	14	ATV340U75N4E
	20	15	27	15	11	21	ATV340D11N4E
	25	18.5	34	20	15	27	ATV340D15N4E
	30	22	40	25	18.5	34	ATV340D18N4E
	40	30	52	30	22	40	ATV340D22N4E
	50	37	74.5	40	30	61.5	ATV340D30N4E
	60	45	88	50	37	74.5	ATV340D37N4E
	75	55	106	60	45	88	ATV340D45N4E
	100	75	145	75	55	106	ATV340D55N4E
125	90	173	100	75	145	ATV340D75N4E	

**Altivar™ 340 Accessories**

**Table 26.13: Altivar 340 Accessories**

Catalog Number	Description
VW3A1111	Advanced graphic display
VW3A1112	Remote mounting kit for use with VW3A1111
VW3A1113	Plain text display terminal
VW3A8120	Simple Loader configuration tool
VW3A8121	Multi-Loader configuration tool
VW3A8126	Cord set for Multi-Loader tool
VW3A3608	CANopen daisy chain communication module, two RJ45 ports
VW3A3618	CANopen daisy chain communication module, 9-pin male SUB-D connector
VW3A3628	CANopen daisy chain communication module, removable 5-position screw connector
VW3CANCARR03	CANopen cable with 2 RJ45 connectors, 0.3 m
VW3CANCARR1	CANopen cable with 2 RJ45 connectors, 1 m
TCSCAR013M120	CANopen end-of-line terminator with RJ45 connector
VW3CANTAP2	IP20 CANopen junction boxes
VW3A3616	Modbus TCP and EtherNet/IP network module
VW3A3607	PROFIBUS DP V1 communication module
VW3A3609	DeviceNet communication module
VW3A3601	EtherCAT communication module
VW3A3619	Ethernet POWERLINK communication module
VW3A3627	ProfNet communication module
VW3A3620	Speed monitoring module
VW3M7101R01	Daisy chain DC bus cord with two connectors for use with ATV320***M2B, ATV320U04N4B-ATV320U40N4B
VW3M7102R150	Daisy chain DC bus cord with one connector and flying leads at one end; Shielded cable for use with ATV320***N4B
VW3M2207	Daisy chain DC bus cord with two connectors Connection kit for VW3M7102R150 Cable for use with ATV320***N4B



Altivar 61 Drive

Altivar™ 61 Three-Phase  
Table 26.14: Altivar 61 Selection

Input Line Voltage	Variable Torque			Catalog Number with LCD Keypad (Stocked)
	Three-Phase Motor Power		Continuous Output Current	
	HP	kW		
500/600 Vac Three Phase	3	2.2	3.9	ATV61HU22S6X [12] [13]
	4	3	5.8	ATV61HU30S6X [12] [13]
	5	4	6.1	ATV61HU40S6X [12] [13]
	7.5	5.5	9	ATV61HU55S6X [12] [13]
	10	7.5	11	ATV61HU75S6X [12] [13]
575/690 Vac Three Phase	15	15	17	ATV61HD15Y [12]
	20	18.5	22	ATV61HD18Y [12]
	25	22	27	ATV61HD22Y [12]
	30	30	32	ATV61HD30Y [12]
	40	37	41	ATV61HD37Y [12]
	50	45	52	ATV61HD45Y [12]
	60	55	62	ATV61HD55Y [12]
	75	75	77	ATV61HD75Y [12]
	100	90	99	ATV61HD90Y [12]
	125	110	125	ATV61HC11Y [12] [14]
	150	132	150	ATV61HC13Y [12] [14]
	—	160	180	ATV61HC16Y [12] [14]
	200	200	220	ATV61HC20Y [12] [14]
	250	250	290	ATV61HC25Y [12] [14] [15]
	350	315	355	ATV61HC31Y [12] [14] [15]
	450	400	420	ATV61HC40Y [12] [14] [15]
	550	500	543	ATV61HC50Y [12] [14] [15]
700	630	675	ATV61HC63Y [12] [14] [15]	
800	800	840	ATV61HC80Y [12] [14] [15]	



[12] Conformal coating is standard.

[13] Product does not contain EMC filter.

[14] An AC 5% line reactor is mandatory.

[15] These products do not contain a dynamic braking transistor. A separate transistor must be added for applications requiring dynamic braking.



### Altivar™ 71 Single-Phase

In an application where it is necessary to use a 240 V single-phase input for a 3-phase motor, the drive must be derated; therefore, the power listed on the drive nameplate will be higher than the power rating on the motor nameplate.

For more information on wire and line reactor sizing, refer to Altivar 61 and 71 Supplementary Ratings (30072-451-38).



Table 26.15: Altivar 71 Selection

Input Line Voltage	With A 3% Line Reactor			Without A 3% Line Reactor			Catalog Number with LCD Keypad [16]	Catalog Number for ATV71 and Type 1 conduit entry kit shipped as one line item. Field installation required (packaged as kit at warehouse).	Catalog Number with LED Keypad (Non-stocked)
	Motor Power		Continuous Output Current	Motor Power		Continuous Output Current			
	HP	kW	A	HP	kW	A			
208/ 240 Vac Single Phase	—	—	—	0.5	0.37	3			
	—	—	—	1	0.75	4.8	ATV71HU15M3 [17]	ATV71HU15M3T1	ATV71HU15M3Z [17]
	—	—	—	2	1.5	8	ATV71HU22M3 [17]	ATV71HU22M3T1	ATV71HU22M3Z [17]
	—	—	—	3	2.2	11	ATV71HU30M3 [17]	ATV71HU30M3T1	ATV71HU30M3Z [17]
	—	3	13.7	—	—	—	ATV71HU40M3 [17]	ATV71HU40M3T1	ATV71HU40M3Z [17]
	5	4	17.5	—	—	—	ATV71HU55M3 [17]	ATV71HU55M3T1	ATV71HU55M3Z [17]
	7.5	5.5	27.5	5	4	17.5	ATV71HU75M3 [17]	ATV71HU75M3T1	ATV71HU75M3Z [17]
	10	7.5	33	7.5	5.5	27.5	ATV71HD15M3X [17][18]	ATV71HD15M3XT1 [18]	ATV71HD15M3XZ [17]
	—	—	—	10	7.5	33	ATV71HD18M3X [17][18]	ATV71HD18M3XT1 [18]	—
	15	11	54	—	—	—	ATV71HD22M3X [17][18]	ATV71HD22M3XT1 [18]	—
	20	15	66	15	11	54	ATV71HD30M3X [17][18]	ATV71HD30M3XT1 [18]	—
	25	18	75	20	15	66	ATV71HD37M3X [17][18]	ATV71HD37M3XT1 [18]	—
	30	22	88	25	18	75	ATV71HD45M3X [17][18]	ATV71HD45M3XT1 [18]	—

[16] These products can be ordered with LonWorks® or BACnet communication option card shipped as one line item. Field installation required. Add "LW" to the end of the part number to receive a LonWorks option card. Add "BN" to the end of the partnumber to receive a BACnet option card.

[17] Option to have product treated for increased protection for dusty and corrosive environments. This product is not stocked. On 0.5 hp to 5 hp at 230 Vac single phase, add "S337" to the end of the catalog number. On 7.5 hp to 25 hp at 230 Vac single phase, add "337" to the end of the catalog number. With this option, exposed copper is tinned, circuit boards are conformal coated in critical areas and plastics are treated to better withstand the corrosive nature of certain oils.

[18] Product does not contain an EMC filter.

Altivar™ 71 Three-Phase



Table 26.16: Altivar 71 Selection

Input Line Voltage	Constant Torque		[19]	Catalog Number ATV71 drive and Type 1 conduit entry kit	Catalog Number with LED Keypad (Non-stocked)	
	Three-Phase Motor Power	Continuous Output Current				
	HP	kW	A			
208/240 Vac Three Phase	0.5	0.37	3			
	1	0.75	4.8			
	2	1.5	8			
	3	2.2	11			
	4	3	13.7			
	5	4	17.5			
	7.5	5.5	27.5			
	10	7.5	33			
	15	11	54			
	20	15	66			
	25	18	75			—
	30	22	88			—
	40	30	120			—
	50	37	144			—
	60	45	176			—
	75	55	221			—
100	75	285			—	

[19] Also possible for use with a synchronous motor. Add "383" to the end of the catalog number.

[20] Option to have product treated for increased protection for dusty and corrosive environments. This product is not stocked. On 0.5 hp to 10 hp at 230 Vac 3 phase and up to 100 hp at 460 V, add "S337" to the end of the catalog number. On 15 hp to 60 hp at 230 Vac 3 phase, add "337" to the end of the catalog number. With this option, exposed copper is tinned, circuit boards are conformal coated in critical areas and plastics are treated to better withstand the corrosive nature of certain oils. This option is standard on 55 kW/75 hp @ 230 Vac 3 phase and higher & 90 kW/125 hp @ 460 Vac and higher.



[21] Product does not contain an EMC filter.

[22] Product ships with a DC choke that must be field mounted. A 5% line reactor may be purchased and installed in place of the DC choke. Add "D" to the end of the catalog number to receive just the AC drive.

[23] Conformal coating is standard.



**Table 26.17: Altivar 71 Selection**

Input Line Voltage	Constant Torque			Catalog Number with LCD Keypad (Stocked)	Catalog Number for ATV71 drive and Type 1 conduit entry kit shipped as one line item. Field installation required (packaged as kit at warehouse).	Catalog Number with LED Keypad (Non-stocked)
	Three-Phase Motor Power		Continuous Output Current			
	HP	kW	A			
400/480 Vac Three Phase	1	0.75	2.3			
	2	1.5	4.1	ATV71HU15N4 [24] [25]	ATV71HU15N4T1	ATV71HU15N4Z
	3	2.2	5.8	ATV71HU22N4 [24] [25]	ATV71HU22N4T1	ATV71HU22N4Z
	4	3	7.8	ATV71HU30N4 [24] [25]	ATV71HU30N4T1	ATV71HU30N4Z
	5	4	10.5	ATV71HU40N4 [24] [25]	ATV71HU40N4T1	ATV71HU40N4Z
	7.5	5.5	14.3	ATV71HU55N4 [24] [25]	ATV71HU55N4T1	ATV71HU55N4Z
	10	7.5	17.6	ATV71HU75N4 [24] [25]	ATV71HU75N4T1	ATV71HU75N4Z
	15	11	27.7	ATV71HD11N4 [24] [25]	ATV71HD11N4T1	ATV71HD11N4Z
	20	15	33	ATV71HD15N4 [24] [25]	ATV71HD15N4T1	ATV71HD15N4Z
	25	18	41	ATV71HD18N4 [24] [25]	ATV71HD18N4T1	ATV71HD18N4Z
	30	22	48	ATV71HD22N4 [24] [25]	ATV71HD22N4T1	ATV71HD22N4Z
	40	30	66	ATV71HD30N4 [24] [25]	ATV71HD30N4T1	ATV71HD30N4Z
	50	37	79	ATV71HD37N4 [24] [25]	ATV71HD37N4T1	ATV71HD37N4Z
	60	45	94	ATV71HD45N4 [24] [25]	ATV71HD45N4T1	ATV71HD45N4Z
	75	55	116	ATV71HD55N4 [24] [25]	ATV71HD55N4T1	ATV71HD55N4Z
	100	75	160	ATV71HD75N4 [24] [25]	ATV71HD75N4T1	ATV71HD75N4Z
	125	90	179	ATV71HD90N4 [26] [25]	ATV71HD90N4T1	—
	150	110	215	ATV71HC11N4 [26] [25]	—	—
	200	130	259	ATV71HC13N4 [26] [25]	—	—
	250	160	314	ATV71HC16N4 [26] [25]	—	—
	300	200	387	ATV71HC20N4 [26] [25] [27]	—	—
	400	250	481	ATV71HC25N4 [26] [25] [27]	—	—
	450	280	550	ATV71HC28N4 [26] [25] [27]	—	—
	500	310	616	ATV71HC31N4 [26] [25] [27]	—	—
	600	400	759	ATV71HC40N4 [26] [25] [27]	—	—
700	500	941	ATV71HC50N4 [26] [25] [27]	—	—	
500/600 Vac Three Phase	2	1.5	2.7	ATV71HU15S6X [28]	—	—
	3	2.2	3.9	ATV71HU22S6X [28]	—	—
	4	3	5.8	ATV71HU30S6X [28]	—	—
	5	4	6.1	ATV71HU40S6X [28]	—	—
	7.5	5.5	9	ATV71HU55S6X [28]	—	—
575/690 Vac Three Phase	10	7.5	11	ATV71HU75S6X [28]	—	—
	15	15	17	ATV71HD15Y [28]	—	—
	20	18.5	22	ATV71HD18Y [28]	—	—
	25	22	27	ATV71HD22Y [28]	—	—
	30	30	32	ATV71HD30Y [28]	—	—
	40	37	41	ATV71HD37Y [28]	—	—
	50	45	52	ATV71HD45Y [28]	—	—
	60	55	62	ATV71HD55Y [28]	—	—
	75	75	77	ATV71HD75Y [28]	—	—
	100	90	99	ATV71HD90Y [28]	—	—
	125	110	125	ATV71HC11Y [28] [29]	—	—
	150	132	150	ATV71HC13Y [28] [29]	—	—
	175	160	180	ATV71HC16Y [28] [29]	—	—
	200	200	220	ATV71HC20Y [28] [29] [27]	—	—
	250	250	290	ATV71HC25Y [28] [29] [27]	—	—
	350	315	355	ATV71HC31Y [28] [29] [27]	—	—
	450	400	420	ATV71HC40Y [28] [29] [27]	—	—
	550	500	543	ATV71HC50Y [28] [29] [27]	—	—
	700	630	675	ATV71HC63Y [28] [29] [27]	—	—

[24] Option to have product treated for increased protection for dusty and corrosive environments. This product is not stocked. Up to 100 hp at 460 V, add "S337" to the end of the catalog number. With this option, exposed copper is tinned, circuit boards are conformal coated in critical areas and plastics are treated to better withstand the corrosive nature of certain oils. This option is standard on 90 kW/125 hp @ 460 Vac and higher.

[25] Also possible for use with a synchronous motor. Add "383" to the end of the catalog number and multiply the listed price by 1.2 to obtain new price.

[26] Product ships with a DC choke that must be field mounted. A 5% line reactor may be purchased and installed in place of the DC choke. Add "D" to the end of the catalog number to receive just the AC drive.

[27] These products do not contain a dynamic braking transistor. A separate transistor must be added for applications requiring dynamic braking.

[28] Conformal coating is standard.

[29] An AC 5% line reactor is mandatory.

Altivar™ 61 / 71 Options

Table 26.18: Altivar 61/71 Options—Field Installed

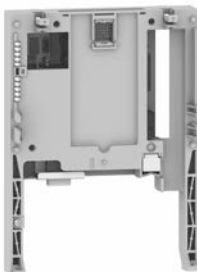
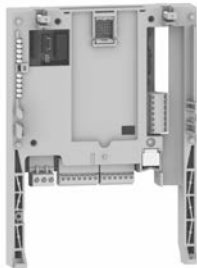
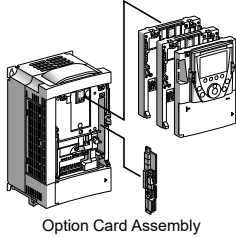
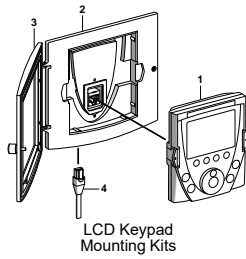

	Description	For Use on Drives	Catalog No.	
Operator Interface	LCD graphic keypad: IP54 rating	any ATV61 any ATV71	VW3A1101	
	Remote mounting kit: includes bezel and mounting hardware		VW3A1102	
	Door for use with remote mount kit for IP65 rating		VW3A1103	
	Cable for remote mounting LCD graphic keypad RJ-45 connector on each end	1 meter	any ATV61 any ATV71	VW3A1104R10
		3 meters		VW3A1104R30
		5 meters		VW3A1104R50
10 meters		VW3A1104R100		
RJ-45 female—female adaptor to connect LCD keypad and cable. Not required if using VW3A1102.		VW3A1105		
Operator, mounting collar, 2.5 kilohm, ½ watt potentiometer	Altivar 61	ATVPOT25K		
SoMove™ Software	This software enables the user to configure, set, debug and organize maintenance task for the complete Altivar product line and the Altistart 22 and Altistart 48 soft starters. It can also be used to customize the integrated display terminal menus. It can be used with a direct connection or a Bluetooth® wireless connection. Free download <a href="http://www.schneider-electric.us">www.schneider-electric.us</a>			
	USB/RS485 cord set (equipped with RJ45 socket)	Altivar AC drives Altistart™ 48 TeSys™ U-line	TCSMCNAM3M002P	
For Wireless Connection	Modbus™ to Bluetooth® Gateway and RS-485	any ATV61 any ATV71	VW3A8114	
I/O Adaptor	115 Vac logic input adaptor adapts 7 logic inputs for use with user supplied 115 Vac signals	any ATV61 any ATV71	VW3A3101	
I/O Extension Option Cards	Basic I/O option card—4 logic inputs, 2 logic outputs, 1 Form C relay output, an input for PTC motor probes, a 24 Vdc output, and a 10 Vdc output	any ATV61 any ATV71	VW3A3201	
	Extended I/O option card—contains all the I/O on the Basic I/O option card plus 2 analog inputs, 2 analog outputs, 1 pulse input		VW3A3202	
CANopen Adapter	This adaptor connects to the RJ-45 port and provides a 9-pin male SUB-D connector conforming to the CANopen standard (CIA DRP 303-1)	any ATV61 any ATV71	VW3CANA71	
CANopen Connector	9-pin female SUB-D with line terminator (can be disabled), 180° cable outlet CAN-H, CAN-L, CAN-GND connection	any ATV61 any ATV71	VW3CANKCDF180T	
Incremental Encoder Interface Option Cards	with RS-422 outputs, 5 Vdc	any ATV71	VW3A3401	
	with RS-422 outputs, 15 Vdc		VW3A3402	
	with open collector outputs, 12 Vdc		VW3A3403	
	with open collector outputs, 15 Vdc		VW3A3404	
	with push-pull outputs, 12 Vdc		VW3A3405	
	with push-pull outputs, 15 Vdc		VW3A3406	
	with push-pull outputs, 24 Vdc		VW3A3407	
	Resolver		VW3A3408 [30]	
	Universal with SinCos, SinCos Hiperface®, SinCos EnDat® or SSI output		VW3A3409 [30]	
Incremental with RS422 outputs and encoder emulation	VW3A3411 [30]			
Communication Option Cards	Modbus / Uni-Telway™ card	any ATV61 any ATV71	VW3A3303	
	Ethernet IP/Modbus TCP-IP daisy chain card		VW3A3320	
	Interbus® S card		VW3A3304	
	Profibus DP card		VW3A3307	
	PROFINET card		VW3A3327	
	Powerlink card		VW3A3321	
	EtherCAT card	VW3A3326		
	Profibus DPV1 card	VW3A3307S371		
	DeviceNet™ card	VW3A3309		
	LonWorks® card	VW3A3312		
	Metasys® N2 card	VW3A3313		
	Apogee® FLN P1 card	VW3A3314		
	BACnet card	VW3A3315		
IMC Option Card	ATV IMC drive controller card [31]	—	VW3A3521	
Controller Inside Option Card	Programmable option card, conforms with IEC61131-3 programming standard.	any ATV61 any ATV71	VW3A3501 [32]	
Water Solutions Control Card	This option card contains a variety of pre-programmed functions and features to manage multi-pump installations.	any ATV61 any ATV71	VW3A3503 [32]	
Simple Loader	Using RJ45 port connections, the configurations of a drive can be downloaded then uploaded to compatible drive.	ATV31, ATV61, and ATV71	VW3A8120	

[30] For use with the ATV71H...383 drive ONLY.

[31] SoMachine is required to use this product.

[32] The drive cannot support the VW3A3503 water solutions card and the VW3A3501 controller inside option card simultaneously.

**Table 26.19: Options—Field Installed (continued)**

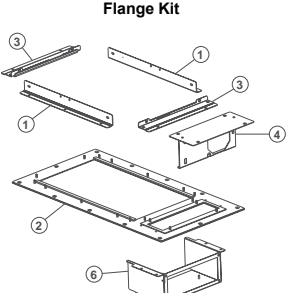
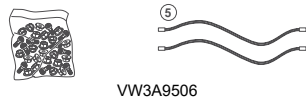
Description		For Use on Drives		Catalog No.																																																			
 <p><b>Flange Kit</b></p> <p>Kit includes: a metal frame, seals, mounting hardware, and a bracket to mount the fan kit so the fan can be accessed from the front of the drive template. Kit used to mount the heatsink of the drive outside of an enclosure.</p>  <p>VW3A9506</p>	ATV61/71H037M3...HU15M3 ATV61/71H075N4...HU22N4 ATV61/71HU22M3...HU40M3 ATV61/71HU30N4...HU40N4 ATV61/71HU55M3 ATV61/71HU55N4, HU75N4 ATV61/71HU75M3 ATV61/71HD11N4 ATV61/71HD11M3X...HD15M3X ATV61/71HD15N4, HD18N4 ATV61/71HD18M3X...HD22M3X ATV61/71HD22N4, ATV61/71HU30Y...HD30Y ATV61/71HD30N4, HD37N4 ATV61/71HD30M3X...HD45M3X ATV61/71HD45N4...HD75N4, ATV61/71HD37Y...HD90Y ATV61HD55M3X...HD75M3X ATV61HD90N4...HC11N4 ATV71HD55M3X, ATV71HD90N4 ATV61HD90M3X, ATV61HC13N4 ATV71HD75M3X, ATV71HC11N4 ATV61HC16N4, ATV61HC20Y, ATV61/71HC11Y...HC16Y, ATV71HC13N4 ATV61HC22N4, ATV71HC16N4 ATV61HC25N4...HC31N4 ATV61HC40Y ATV61/71HC25Y, HC31Y ATV71HC20N4...HC28N4 ATV71HC20Y ATV61HC25N4...HC31N4 with VW3A7101 braking transistor ATV61HC40Y ATV61/71HC25Y, HC31Y ATV71HC20N4...HC28N4 with VW3A7101 braking transistor ATV71HC20Y	VW3A9501 VW3A9502 VW3A9503 VW3A9504 VW3A9505 VW3A9506 VW3A9507 VW3A9508 VW3A9509 VW3A9510 VW3A9511 VW3A9512 VW3A9513 VW3A9514 VW3A9515																																																					
	<p><b>Type 1 Conduit Kit</b></p> <p>Kit includes: a metal box with conduit knockouts. The kit provides conduit landing when wall mounting the drive.</p>	ATV61/71H037M3...HU15M3 ATV61/71H075N4...HU22N4 ATV61/71HU22M3...HU40M3 ATV61/71HU30N4...HU40N4 ATV61/71HU55M3 ATV61/71HU55N4, HU75N4 ATV61/71HU75M3 ATV61/71HD11N4 ATV61/71HD11M3X...HD15M3X ATV61/71HD15N4, HD18N4 ATV61/71HD18M3X...HD22M3X ATV61/71HD22N4 ATV61/71HU30Y...HD30Y ATV61/71HD30N4, HD37N4 ATV61/71HD30M3X...HD45M3X ATV61/71HD45N4...HD75N4 ATV61/71HD37Y...HD90Y ATV61HD55M3X...HD75M3X ATV61HD90N4...HC11N4 ATV71HD55M3X, ATV71HD90N4, ATV61HC11N4 ATV61HD90M3X, ATV61HC13N4 ATV71HD75M3X, ATV71HC11N4 ATV61HC16N4, ATV71HC13N4 ATV61/71HC11Y...HC16Y ATV61HC20Y ATV61HC22N4, ATV71HC16N4 ATV61HC25N4...ATV61HC31N4 ATV71HC20N4...HC28N4 ATV71HC20Y ATV61/71HC25Y, HC31Y ATV61HC40Y ATV61HC25N4...HC31N4 with VW3A7101 braking transistor ATV71HC20N4...HC28N4 with VW3A7101 braking transistor ATV71HC20Y ATV61/71HC25Y, HC31Y ATV61HC40Y	VW3A9201 VW3A9202 VW3A9203 VW3A9204 VW3A9205 VW3A9206 VW3A9207 VW3A9217 VW3A9208 VW3A9209 VW3A9210 VW3A9211 VW3A9212 VW3A9213 VW3A9214																																																				
		<table border="1"> <thead> <tr> <th colspan="2">230 V Drive controllers</th> <th colspan="2">480 V Drive controllers</th> </tr> <tr> <th>ATV61H*** [33]</th> <th>ATV71H***</th> <th>ATV61H***</th> <th>ATV71H***</th> </tr> </thead> <tbody> <tr> <td>075M3</td> <td>037M3</td> <td>075N4</td> <td>075N4</td> </tr> <tr> <td>U15M3</td> <td>075M3</td> <td>U15N4</td> <td>U15N4</td> </tr> <tr> <td>—</td> <td>U15M3</td> <td>U22N4</td> <td>U22N4</td> </tr> <tr> <td>U22M3</td> <td>U22M3</td> <td>U30N4</td> <td>U30N4</td> </tr> <tr> <td>U30M3</td> <td>U30M3</td> <td>U40N4</td> <td>U40N4</td> </tr> <tr> <td>U40M3</td> <td>U40M3</td> <td>—</td> <td>—</td> </tr> <tr> <td>U55M3</td> <td>U55M3</td> <td>U55N4</td> <td>U55N4</td> </tr> <tr> <td>—</td> <td>—</td> <td>U75N4</td> <td>U75N4</td> </tr> <tr> <td>U75M3</td> <td>U75M3</td> <td>D11N4</td> <td>D11N4</td> </tr> <tr> <td>D11M3X</td> <td>D11M3X</td> <td>D15N4</td> <td>D15N4</td> </tr> <tr> <td>D15M3X</td> <td>D15M3X</td> <td>D18N4</td> <td>D18N4</td> </tr> </tbody> </table>	230 V Drive controllers		480 V Drive controllers		ATV61H*** [33]	ATV71H***	ATV61H***	ATV71H***	075M3	037M3	075N4	075N4	U15M3	075M3	U15N4	U15N4	—	U15M3	U22N4	U22N4	U22M3	U22M3	U30N4	U30N4	U30M3	U30M3	U40N4	U40N4	U40M3	U40M3	—	—	U55M3	U55M3	U55N4	U55N4	—	—	U75N4	U75N4	U75M3	U75M3	D11N4	D11N4	D11M3X	D11M3X	D15N4	D15N4	D15M3X	D15M3X	D18N4	D18N4	VW3A9201PF VW3A9292PF VW3A9203PF VW3A9204PF VW3A9205PF
		230 V Drive controllers		480 V Drive controllers																																																			
		ATV61H*** [33]	ATV71H***	ATV61H***	ATV71H***																																																		
		075M3	037M3	075N4	075N4																																																		
		U15M3	075M3	U15N4	U15N4																																																		
		—	U15M3	U22N4	U22N4																																																		
		U22M3	U22M3	U30N4	U30N4																																																		
		U30M3	U30M3	U40N4	U40N4																																																		
		U40M3	U40M3	—	—																																																		
		U55M3	U55M3	U55N4	U55N4																																																		
		—	—	U75N4	U75N4																																																		
		U75M3	U75M3	D11N4	D11N4																																																		
		D11M3X	D11M3X	D15N4	D15N4																																																		
		D15M3X	D15M3X	D18N4	D18N4																																																		

[33] The symbol "\*" indicates the part of the number that varies with controller size or rating.

New!

Altivar™ Process 630/650

Table 26.20: Altivar Process 630/650 Selection



Altivar Process 630

Input Line Voltage	Normal Duty [34]			Heavy Duty [35]			Catalog Number
	Three-phase Motor Power [36]		Continu-ous Output Current [37]	Three-phase Motor Power [36]		Continuous Output Current [37]	
	HP	kW		HP	kW		
208/240 Vac Three Phase	1	0.75	4.6	0.5	0.37	3.3	ATV630U07M3
	2	1.5	8	1	0.75	4.6	ATV630U15M3
	3	2.2	11.2	2	1.5	8	ATV630U22M3
	4	3.0	13.7	3	2.2	11.2	ATV630U30M3
	5	4.0	18.7	4	3	13.7	ATV630U40M3
	7.5	5.5	25.4	5	4	18.7	ATV630U55M3
	10	7.5	32.7	7.5	5.5	25.4	ATV630U75M3
	15	11	46.8	10	7.5	32.7	ATV630D11M3
	20	15	63.4	15	11	46.8	ATV630D15M3
	25	18.5	78.4	20	15	63.4	ATV630D18M3
	30	22	92.6	25	18.5	78.4	ATV630D22M3
	40	30	123	30	22	92.6	ATV630D30M3
	50	37	149	40	30	123	ATV630D37M3
	60	45	176	50	37	149	ATV630D45M3
	75	55	211	60	45	176	ATV630D55M3
	100	75	282	75	55	211	ATV630D75M3
400/480 Vac Three Phase	1	0.75	2.2	0.5	0.37	1.5	ATV630U07N4 ATV650U07N4U
	2	1.5	4	1	0.75	2.2	ATV630U15N4 ATV650U15N4U
	3	2.2	5.6	2	1.5	4	ATV630U22N4 ATV650U22N4U
	4	3	7.2	3	2.2	5.6	ATV630U30N4 ATV650U30N4U
	5	4	9.3	4	3	7.2	ATV630U40N4 ATV650U40N4U
	7.5	5.5	12.7	5	4	9.3	ATV630U55N4 ATV650U55N4U
	10	7.5	16.5	7.5	5.5	12.7	ATV630U75N4 ATV650U75N4U
	15	11	23.5	10	7.5	16.5	ATV630D11N4 ATV650D11N4U
	20	15	31.7	15	11	23.5	ATV630D15N4 ATV650D15N4U
	25	18.5	39.2	20	15	31.7	ATV630D18N4 ATV650D18N4U
	30	22	46.3	25	18.5	39.2	ATV630D22N4 ATV650D22N4U
	40	30	61.5	30	22	46.3	ATV630D30N4 ATV650D30N4U
	50	37	74.5	40	30	61.5	ATV630D37N4 ATV650D37N4U
	60	45	88	50	37	74.5	ATV630D45N4 ATV650D45N4U
	75	55	106	60	45	88	ATV630D55N4 ATV650D55N4U
	100	75	145	75	55	106	ATV630D75N4 ATV650D75N4U
	125	90	173	100	75	145	ATV630D90N4 ATV650D90N4U
	150	110	211	125	90	173	ATV630C11N4
	200	130	250	150	110	180	ATV630C13N4
	250	160	302	200	132	240	ATV630C16N4
350	220	324	250	160	246	ATV630C22N4	
400	250	366	300	220	301	ATV630C25N4	
450	310	461	400	250	375	ATV630C31N4	
690 Vac Three Phase	3	2.2	3.1	2	1.5	2.4	ATV630U22Y6
	—	3	4.2	3	2.2	3.1	ATV630U30Y6
	5	4	5.4	—	3	4.2	ATV630U40Y6
	7.5	5.5	7.2	5	4	5.4	ATV630U55Y6
	10	7.5	9.5	7.5	5.5	7.2	ATV630U75Y6
	15	11	13.5	10	7.5	9.5	ATV630D11Y6
	20	15	18	15	11	13.5	ATV630D15Y6
	25	18	24	20	15	18	ATV630D18Y6
	30	22	29	25	18	24	ATV630D22Y6
	40	30	34	30	22	29	ATV630D30Y6
	50	37	45	40	30	34	ATV630D37Y6
	60	45	55	50	37	45	ATV630D45Y6
	75	55	66	60	45	55	ATV630D55Y6
	100	75	83	75	55	66	ATV630D75Y6
125	90	108	100	75	83	ATV630D90Y6	

[34] Normal duty applications requiring an overload up to 110% for 60 seconds. Typical for variable torque loads.

[35] Heavy duty applications requiring an overload up to 150% for 60 seconds. Typical for constant torque loads.

[36] These values are given for a nominal switching frequency of 4 kHz up to ATV630D45N4, or 2.5 kHz for ATV630D55N4...D90N4 for use in continuous operation. The switching frequency is adjustable from 1...16 kHz for all ratings. Above 2.5 or 4 kHz (depending on the rating), the drive will automatically reduce the switching frequency in the event of an excessive temperature rise. For continuous operation above the nominal switching frequency, derate the nominal drive current (see the derating curves on our website www.schneider-electric.com).

[37] Typical value for the indicated motor power and for the maximum prospective line Isc.

**Altivar™ Process 930/950**

**Table 26.21: Altivar Process 930/950 Selection**



Altivar Process 930

Input Line Voltage	Normal Duty [38]			Heavy Duty [39]			Catalog Number	
	Three-phase Motor Power [40]		Continuous Output Current [41]	Three-phase Motor Power [40]		Continuous Output Current [41]		
	HP	kW		HP	kW			
208/240 Vac Three Phase	1	0.75	4.6	0.5	0.37	3.3	ATV930U07M3	
	2	1.5	8	1	0.75	4.6	ATV930U15M3	
	3	2.2	11.2	2	1.5	8	ATV930U22M3	
	4	3.0	13.7	3	2.2	11.2	ATV930U30M3	
	5	4.0	18.7	4	3	13.7	ATV930U40M3	
	7.5	5.5	25.4	5	4	18.7	ATV930U55M3	
	10	7.5	32.7	7.5	5.5	25.4	ATV930U75M3	
	15	11	46.8	10	7.5	32.7	ATV930D11M3	
	20	15	63.4	15	11	46.8	ATV930D15M3	
	25	18.5	78.4	20	15	63.4	ATV930D18M3	
	30	22	92.6	25	18.5	78.4	ATV930D22M3	
	40	30	123	30	22	92.6	ATV930D30M3	
	50	37	149	40	30	123	ATV930D37M3	
	60	45	176	50	37	149	ATV930D45M3	
	75	55	211	60	45	176	ATV930D55M3	
	100	75	282	75	55	211	ATV930D75M3	
	400/480 Vac Three Phase	1	0.75	2.2	0.5	0.37	1.5	ATV930U07N4 ATV950U07N4U
		2	1.5	4	1	0.75	2.2	ATV930U15N4 ATV950U15N4U
3		2.2	5.6	2	1.5	4	ATV930U22N4 ATV950U22N4U	
4		3	7.2	3	2.2	5.6	ATV930U30N4 ATV950U30N4U	
5		4	9.3	4	3	7.2	ATV930U40N4 ATV950U40N4U	
7.5		5.5	12.7	5	4	9.3	ATV930U55N4 ATV950U55N4U	
10		7.5	16.5	7.5	5.5	12.7	ATV930U75N4 ATV950U75N4U	
15		11	23.5	10	7.5	16.5	ATV930D11N4 ATV950D11N4U	
20		15	31.7	15	11	23.5	ATV930D15N4 ATV950D15N4U	
25		18.5	39.2	20	15	31.7	ATV930D18N4 ATV950D18N4U	
30		22	46.3	25	18.5	39.2	ATV930D22N4 ATV950D22N4U	
40		30	61.5	30	22	46.3	ATV930D30N4 ATV950D30N4U	
50		37	74.5	40	30	61.5	ATV930D37N4 ATV950D45N4U	
60		45	88	50	37	74.5	ATV930D45N4 ATV950D55N4U	
75		55	106	60	45	88	ATV930D55N4 ATV950D55N4U	
100		75	145	75	55	106	ATV930D75N4 ATV950D75N4U	
125		90	173	100	75	145	ATV930D90N4 ATV950D90N4U	
150		110	211	125	90	173	ATV930C11N4C	
200		130	250	150	110	180	ATV930C13N4C	
250		160	302	200	132	240	ATV930C16N4C	
250	160	302	200	132	240	ATV930C16N4		
350	220	324	250	160	246	ATV930C22N4		
400	250	366	300	220	301	ATV930C25N4C		
450	310	461	400	250	375	ATV930C31N4C		
690 Vac Three Phase	3	2.2	3.1	2	1.5	2.4	ATV930U22Y6	
	—	3	4.2	3	2.2	3.1	ATV930U30Y6	
	5	4	5.4	—	3	4.2	ATV930U40Y6	
	7.5	5.5	7.2	5	4	5.4	ATV930U55Y6	
	10	7.5	9.5	7.5	5.5	7.2	ATV930U75Y6	
	15	11	13.5	10	7.5	9.5	ATV930D11Y6	
	20	15	18	15	11	13.5	ATV930D15Y6	
	25	18	24	20	15	18	ATV930D18Y6	
	30	22	29	25	18	24	ATV930D22Y6	
	40	30	34	30	22	29	ATV930D30Y6	
	50	37	45	40	30	34	ATV930D37Y6	
	60	45	55	50	37	45	ATV930D45Y6	
	75	55	66	60	45	55	ATV930D55Y6	
	100	75	83	75	55	66	ATV930D75Y6	
	125	90	108	100	75	83	ATV930D90Y6	

[38] Normal duty applications requiring an overload up to 120% for 60 seconds. Typical for variable torque loads.

[39] Heavy duty applications requiring an overload up to 150% for 60 seconds. Typical for constant torque loads.

[40] These values are given for a nominal switching frequency of 4 kHz up to ATV930D45N4, or 2.5 kHz for ATV930D55N4...D90N4 for use in continuous operation. The switching frequency is adjustable from 1...16 kHz for all ratings. Above 2.5 or 4 kHz (depending on the rating), the drive will automatically reduce the switching frequency in the event of an excessive temperature rise. For continuous operation above the nominal switching frequency, derate the nominal drive current (see the derating curves on our website www.schneider-electric.com).

[41] Typical value for the indicated motor power and for the maximum prospective line Isc.

**Altivar™ 600/900 Accessories**

**Table 26.22: Accessories for Altivar Process 600/900**

Description		Catalog Number	
Operator Interface	Graphic keypad	VW3A1111	
	Door Mounting kit for graphic keypad, Type 12	VW3A1112	
	Remote mounting kit RJ45 connector, IP65	VW3A1115	
	Cable for remote mounting LCD graphic keypad	1 meter	VW3A1104R10
		3 meters	VW3A1104R30
5 meters		VW3A1104R50	
10 meters		VW3A1104R100	
Wireless Connection	Wifer Wi-Fi Module	TCSEGWB13FA0	
I/O Extension Option Cards	Digital and Analog I/O extension module	VW3A3203	
	Output Relays extension module	VW3A3204	
Communication Option Cards	Ethernet/IP Modbus TCP dual port	VW3A3720	
	PROFINET	VW3A3627	
	PROFIBUS DPv1 option card	VW3A3607	
	DeviceNet option card	VW3A3609	
	CANopen	2x RJ45 Daisy Chain	VW3A3608
		SUB-D	VW3A3618
		Screw terminal	VW3A3628
	BACnet MS/TP (ATV600)	VW3A3725	
	Ethernet IP / Modbus TCP dual port with MultiVFD (ATV600)	VW3A3721	
	EtherCAT (ATV900)	VW3A3601	
Encoder Interface Modules	Digital Encoder Interface Module	VW3A3420	
	Analog Encoder Interface Module	VW3A3422	
	Resolver Encoder Interface Module	VW3A3423	
	HTL Encoder Interface Module	VW3A3424	
External Heat Sink Mounting Kit	Frame 1	NSYPTDS1	
	Frame 2	NSYPTDS2	
	Frame 3	NSYPTDS3	
	Frame 4	NSYPTDS4	
	Frame 5	NSYPTDS5	
	Wall Mount kit	NSYAEFPFPTD	
Replacement Cooling Fan Kit	Frame 1	VX5VPS1001	
	Frame 2	VX5VPS2001	
	Frame 3	VX5VPS3001	
	Frame 4	VX5VPS4001	
	Frame 5	VX5VPS5001	
	Frame 6	VX5VPS6001	
	Frame A	VX5VPOA001	
	Frame B/C	VX5VPOBC001	
Common Mode Noise Filters	Frame 1	VW3A5501	
	Frame 2	VW3A5502	
	Frame 3	VW3A5503	
	Frame 4	VW3A5504	
	Frame 5	VW3A5505	
	Frame 6	VW3A5506	

**S-Flex™ Variable Torque AC Drive—208 V, 230 V, and 460 V Ratings**

The AHRI certified S-Flex enclosed drive features the Altivar 212 drive and provides 100 KAIC rating for commercial pump, fan, and scroll compressor applications.

The S-Flex is an economical package that includes a circuit breaker disconnect and option bypass contactors, drive input disconnect switch or line contactor.

The S-Flex is rated as a UL Type 1, 12, and 3R enclosure an ideal for use in residential high rise and mixed-use buildings, commercial office buildings, schools and campus environments.



S-Flex 212 Enclosed Drive Controller Type 1, 12, 3R  
Rated +14 to +104 °F  
(-10 to +40 °C)

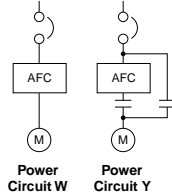

**All S-Flex 212 Enclosed Drives are supplied with:**

- Altivar™ 212 power converter
- Square D™ circuit breaker disconnect (Power Fuses for 460 V version only)
- Coordinated short circuit rating for 100,000 A
- Adjustable Frequency Controller-Off-Bypass selector switch
- Local/Remote configurable on controller
- Power On red LED
- Bypass Run green LED
- Fire/Freezestat interlock for Adjustable Frequency Drive and Bypass mode
- Form C Adjustable Frequency Controller fault auxiliary contact
- Modbus RJ-45 communication port
- Smoke Purge Function
- Bypass Run Auxiliary Contact
- Drive Run Auxiliary Contact
- Full Voltage Bypass Power Circuit with overload relay
- 120 Vac fused control power transformer

**Table 26.23: Output Amperes**

HP	208 V	230 V	460 V
1	4.8	4.2	2.1
2	7.8	6.8	3.4
3	11	9.6	4.8
5	17.5	15.2	7.6
7.5	25.3	22	11
10	32.2	28	14
15	48.3	42	21
20	62.1	54	27
25	78.2	68	34
30	92	80	40
40	120	104	52
50	—	—	65
60	—	—	77
75	—	—	96
100	—	—	124

**Table 26.24: S-Flex 212 Type 1 Enclosed Drive Controller Selection**

Input Line Voltage	HP	kW	Output Current	Catalog Number	
			A		
208 Vac Three-phase	1	0.75	4.8	SFD212CG2YB07D07	
	2	1.5	7.8	SFD212DG2YB07D07	
	3	2.2	11	SFD212EG2YB07D07	
	5	4	17.5	SFD212FG2YB07D07	
	7.5	5.5	25.3	SFD212GG2YB07D07	
	10	7.5	32.2	SFD212HG2YB07D07	
	15	11	48.3	SFD212JG2YB07D07	
	20	15	62.1	SFD212KG2YB07D07	
	25	18.5	78.2	SFD212LG2YB07D07	
	30	22	92	SFD212MG2YB07D07	
	40	30	120	SFD212NG2YB07D07	
	460 Vac Three-phase	1	0.75	2.1	SFD212CG4YB07D07
		2	1.5	3.4	SFD212DG4YB07D07
3		2.2	4.8	SFD212EG4YB07D07	
5		4	7.6	SFD212FG4YB07D07	
7.5		5.5	11	SFD212GG4YB07D07	
10		7.5	14	SFD212HG4YB07D07	
15		11	21	SFD212JG4YB07D07	
20		15	27	SFD212KG4YB07D07	
25		18.5	34	SFD212LG4YB07D07	
30		22	40	SFD212MG4YB07D07	
40		30	52	SFD212NG4YB07D07	
50		37	65	SFD212PG4YB07D07	
60		45	77	SFD212QG4YB07D07	
75	55	96	SFD212RG4YB07D07		
100	75	124	SFD212SG4YB07D07		

**Table 26.25: Additional S-Flex Configurations Available Using Product Selector**  
Example: SFD212CG3YA06X07 (bold text in selection table below)

TYPE (01)	HP (02)	Enclosure (03)	Voltage (04)	Power Circuit (05)	Communication Options (06)	Misc Options (07)
SFD212	C = 1 hp D = 2 hp E = 3 hp F = 5 hp G = 7.5 hp H = 10 hp J = 20 hp K = 30 hp L = 40 hp N = 50 hp (460 V only) Q = 60 hp (460 V only) R = 75 hp (460 V only) S = 100 hp (460 V only)	<b>G = UL Type 1 General Purpose</b> <b>A = UL Type 12K Industrial Use, Dust-Tight/Drip-Tight</b> <b>H = UL Type 3R Outdoor Use</b>	2 = 208 Vac 3 = 230 Vac 4 = 460 Vac	W = Without Bypass Y = Full Voltage Bypass	<b>A06 = BACnet Setup</b> B06 = LonWorks® Card C06 = Metasys® N2 Setup D06 = Apogee™ P1 Setup N06 = Modbus [1]	A07 = Drive Input Disconnect [2] B07 = Line Contactor [2] S07 = Seismic Certification D07 = Full Text Keypad K07 = cUL Marking (Canada) T07 = 50 °C Ambient Operation [3] <b>X07 = AC Line Reactor</b>

**Table 26.26: S-Flex Accessories**

Description	Catalog Number
<b>Software</b>	
SoMove™	This software enables the user to configure, set, debug and organize maintenance task for the complete Altivar product line and the Altistart 22 and Altistart 48 soft starters. It can also be used to customize the integrated display terminal menus. It can be used with a direct connection or a Bluetooth® wireless connection. Free download www.schneider-electric.us
<b>User Interface Kits</b>	
USB to RJ45 Adaptor Kit (For use in connecting to a PC with a USB port)	TCSMCNAM3M002P
EZ-M Mounting Channel, 72 in. length	EZM72MC
Altivar and Altistart Programming cable for iPad 30-Pin mobile to RS-485 Converter, 2 meters	VW3A8151R20U

**NOTE:** See the Instruction Bulletin for set up instructions.

[1] Default selection. For Modbus control, see the Instruction manual.

[2] Options A07 Drive Input disconnect and B07 line contactor are available only when a full voltage bypass option Y is selected. Options A07 and B07 are mutually exclusive.

[3] For UL Type 12 and 3R only.

### Altistart™ 22 Soft Starters

The Altistart 22 is designed for commercial and normal duty industrial applications, it uses both voltage and torque control to provide a soft start and soft stop for three-phase asynchronous motors between 17 A and 590 A. The conformal-coated, printed circuit boards provide enhanced resistance to harsh environments, increasing the service life of installations and lowering maintenance costs.

Select the Altistart 22 soft starter using the nameplate full-load ampere rating of the motor and the table below. The horsepower ratings are for reference only.



Table 26.27: Altistart 22 Selection [1]

208 V	230 V	400 kW	460 V	575 V	Rated A	Softstart Reference [2] or [3]	Dimensions (inches)			Frame Size
							W	H	D	
3	5	5.5	10	15	17	ATS22D17S6,S6U	5.1	9.8	6.6	A
7.5	10	11	20	25	32	ATS22D32S6,S6U	5.1	9.8	6.6	A
— [4]	15	18.5	30	40	47	ATS22D47S6,S6U	5.1	9.8	6.6	A
15	20	22	40	50	63	ATS22D62S6,S6U	5.7	10.9	8.1	B
20	25	30	50	60	75	ATS22D75S6,S6U	5.7	10.9	8.1	B
25	30	37	60	75	88	ATS22D88S6,S6U	5.7	10.9	8.1	B
30	40	45	75	100	110	ATS22C11S6,S6U	5.9	13	9	C
40	50	55	100	125	140	ATS22C14S6,S6U	5.9	13	9	C
50	60	75	125	150	170	ATS22C17S6,S6U	5.9	13	9	C
60	75	90	150	200	210	ATS22C21S6,S6U	8.1	15.6	11.8	D
75	100	110	200	250	250	ATS22C25S6,S6U	8.1	15.6	11.8	D
100	125	132	250	300	320	ATS22C32S6,S6U	8.1	15.6	11.8	D
125	150	160	300	350	410	ATS22C41S6,S6U	8.1	15.6	11.8	D
150	—	220	350	400	480	ATS22C48S6,S6U	11.9	16.8	13.4	E
—	200	250	400	500	590	ATS22C59S6,S6U	11.9	16.8	13.4	E

Table 26.28: Maximum Number of Starts/Stops per Hour

Catalog Number	Number of starts/Stops per Hour
ATS22D17S6U–D88S6U	6 (up to 10 with optional fan)
ATS22C11S6U–C17S6U	4 (up to 10 with optional fan)
ATS22C21S6U–C59S6U	4 (comes with fan)

### Altistart™ 22 Options: Fans and Accessories

Table 26.29: Altistart 22 Accessories Selection

Description	Length	Catalog Number	
<b>Software</b>			
SoMove™	This software enables the user to configure, set, debug and organize maintenance task for the complete Altivar product line and the Altistart 22 and Altistart 48 soft starters. It can also be used to customize the integrated display terminal menus. It can be used with a direct connection or a Bluetooth® wireless connection. Free download www.schneider-electric.us		
<b>User Interface Kits</b>			
Cable	USB/RS485 cord set (equipped with RJ45 socket)	TCSCMCNAM3M002P	
Remote Keypad	IP54/NEMA® 12 keypad	VW3G22101	
	IP65 keypad	VW3G22102 [5]	
Remote Keypad Cords Equipped with 2 RJ45 Connectors	3 FT length	VW3A1104R10	
	9 FT length	VW3A1104R30	
Modbus Serial Link Connection via splitter box and RJ45 connectors	Modbus™ splitter box (with 10 RJ45 Connectors)	LU9GC3	
	Cordsets for Modbus serial link (with 2 RJ45 connectors)	.3 m	VW3A8306R03
		1 m	VW3A8306R10
		3 m	VW3A8306R30
	Modbus T-junction boxes (with integrated cables)	.3 m	VW3A8306TF03
		1 m	VW3A8306TF10
RJ45 Line Terminators (Sold in lots of 2)		VW3A8306RC	
Altivar and Altistart Programming Cable	30-Pin mobile to RS-485 converter	2 m VW3A8151R20U	

Table 26.30: Altistart 22 Fans Selection

Power Supply Voltage For Control	For Use On Altistart	Catalog Number
220 V	ATS22D17–D47S6	VW3G22400
	ATS22D62–D88S6	VW3G22401
	ATS22C11–C17S6	VW3G22402
110 V	ATS22D17–D47S6U	VW3G22U400
	ATS22D62–D88S6U	VW3G22U401
	ATS22C11–C17S6U	VW3G22U402

The ATS22C21S6,S6U..C59S6,S6U units come with an integrated fan. The ATS22D17S6,S6U..C17S6,S6U units are ventilated by means of natural ventilation. For more demanding applications, such as those with a greater number of starts, the Altistart 22 range offers fans as an option. The fans are powered by the Altistart 22 unit and attach to the back of the device. The fan's noise level is less than 60 dBA.

[1] Motor full load amperate (FLA) must not exceed the ampere ratings of the soft starter.

[2] S6 = 208–600 line voltage, 220 V control voltage

[3] S6U = 208–600 line voltage, 110 V control voltage

[4] Value not indicated when there is no corresponding standardized motor.

[5] A remote keypad cord set is required.





### Altistart™ 48 Soft Starters

The Altistart 48 soft starter combines ease of selection with simple installation and high motor control performance. With its exclusive motor Torque Control System, the Altistart 48 helps eliminate uncontrolled motor acceleration and deceleration, a problem inherent with standard voltage—ramp soft starters. The Altistart 48 includes features to help with motor and machine protection and is available for motors ranging from 208 to 575 volts. In addition to a built-in display and programming terminal, a remote keypad option and programming software is available to ease integration and commissioning. The Altistart 48 has a built-in Modbus™ port and is offered with serial communication gateways to such popular networks as Ethernet and DeviceNet™.

#### Open Style Soft Starters 50–60 Hz, Three-Phase, 690 V Maximum

The Altistart 48 soft starter must be selected using the table below, based on nameplate full load ampere rating of the motor. The horsepower ratings shown in table are for reference only.

Table 26.31: Altistart 48 Selection [6]

Standard Duty (Low Inertia Loads) [7] Maximum Horsepower					Altistart Soft Starters	
208 V	230 V	400 V (kW)	460 V	575 V	Rated A	Catalog Number
3	5	5.5	10	15	17	ATS48D17Y
5	7.5	7.5	15	20	22	ATS48D22Y
7.5	10	11	20	25	32	ATS48D32Y
10	—	15	25	30	38	ATS48D38Y
—	15	18.5	30	40	47	ATS48D47Y
15	20	22	40	50	62	ATS48D62Y
20	25	30	50	60	75	ATS48D75Y
25	30	37	60	75	88	ATS48D88Y
30	40	45	75	100	110	ATS48C11Y
40	50	55	100	125	140	ATS48C14Y
50	60	75	125	150	170	ATS48C17Y
60	75	90	150	200	210	ATS48C21Y
75	100	110	200	250	250	ATS48C25Y
100	125	132	250	300	320	ATS48C32Y
125	150	160	300	350	410	ATS48C41Y
150	—	220	350	400	480	ATS48C48Y
—	200	250	400	500	590	ATS48C59Y
200	250	315	500	600	660	ATS48C66Y
250	300	355	600	800	790	ATS48C79Y
350	350	400	800	1000	1000	ATS48M10Y
400	450	500	1000	1200	1200	ATS48M12Y

Table 26.32: Altistart 48 Options

Description	Catalog Number
<b>Software</b>	
SoMove™	This software enables the user to configure, set, debug and organize maintenance task for the complete Altivar product line and the Altistart 22 and Altistart 48 soft starters. It can also be used to customize the integrated display terminal menus. It can be used with a direct connection or a Bluetooth® wireless connection. Free download <a href="http://www.schneider-electric.us">www.schneider-electric.us</a>
<b>User Interface Kits</b>	
Remote Keypad Display Mounting Kit, including: Keypad with 3-character 7-segment display IP65 cover and seal, mounting screws, and 3 meter cable to connect keypad display to Altistart 48	VW3G48101
Cover for power terminals—Set of 6 for ATS48C14Y and ATS48C17Y	LA9F702
Cover for power terminals—Set of 6 for ATS48C21Y, ATS48C25Y, and ATS48C32Y	LA9F703
Modbus Ethernet Gateway	TSXETG100
DeviceNet Gateway	LUFP9
Profibus DP Gateway	LUFP7
FIPIO™ Gateway	LUFP1
1/3 meter connection cable (RJ-45 to RJ-45)	VW3A8306R03
1 meter connection cable (RJ-45 to RJ-45)	VW3A8306R10
3 meter connection cable (RJ-45 to RJ-45)	VW3A8306R30
1/3 meter splitter cable (For RJ-45 daisy chain connection)	VW3A8306TF03
1 meter splitter cable (For RJ-45 daisy chain connection)	VW3A8306TF10
RJ45 terminator (2 per package)	VW3A8306RC
Modbus hub (Eight RJ-45 ports)	LU9GC3
USB to RJ45 Adaptor Kit For use in connecting to a PC with a USB port	TSCMCNAM3M002P
Size M10 Bolt Kit	W808780210111
Size M12 Bolt Kit	W808780220111
Altivar and Altistart Programming Cable. For use with the iPad Configuration App. 30-Pin Mobile to RS-485 Converter Cable	VW3A8151R20U

[6] Motor full load amperage (FLA) must not exceed the ampere rating of the soft starter.  
 [7] Low Inertia—Connected motor load inertia equal or less than 10 times motor rotor inertia.  
 High Inertia—Connected motor load inertia greater than 10 times motor rotor inertia.



### Enclosed Altistart™ 22 Motor Controllers

Enclosed Altistart 22 (ATS22) solid-state combination motor controllers are a pre-engineered, integrated solution for reduced voltage starting and soft stopping of standard three-phase asynchronous induction (squirrel cage) motors. The Enclosed 22 controllers consist of a disconnect means and an ATS22 softstarter in a stand-alone enclosure. Enclosed 22 controllers integrate the ATS22 softstart technology into a combination package for application requirements up to 400 hp at 460 V.

- 3–150 hp, 208 V
- 5–200 hp, 230 V
- 10–400 hp, 460 V
- 15–500 hp, 575V

**Table 26.33: Enclosed Altistart 22 Catalog Number Description**

Field	Digit	Characteristic	Description
—	—	Controller Class	8638 = Fused Disconnect [1] 8639 = Circuit Breaker Disconnect
01	1–3	Controller Style	22F = Altistart 22 with Class J Fuse Clips and Molded Case Switch [1] 22T = Altistart 22 with PowerPact Motor Circuit Protector 22U = Altistart 22 with PowerPact Thermal-Magnetic Circuit Breaker
02	4	Horsepower	A = 3 hp B = 5 hp C = 7.5 hp D = 10 hp E = 15 hp F = 20 hp G = 25 hp H = 30 hp J = 40 hp K = 50 hp L = 60 hp M = 75 hp N = 100 hp P = 125 hp Q = 150 hp R=200 hp S= 250 hp T= 300 hp U=350 hp W= 400 hp X= 500 hp
03	5	Enclosure Type	G = UL Type 1 General Purpose A = UL Type 12K Industrial Use, Dust-Tight/Drip-Tight H = UL Type 3R Outdoor Use
04	6	Voltage	2 = 208 Vac 3 = 230 Vac 4 = 460 Vac 5 = 575 Vac
05	7	Power Circuit	B = Basic Shunt Trip S = Full-Featured Shunt Trip N = Non-Reversing Isolation R = Reversing Isolation Y = Integral Full-Voltage Bypass
06	8–10	Control Options [2] [3]	A06 = Start-Stop Push Buttons B06 = Forward-Off-Reverse C06 = Hand-Off-Auto (HOA) Selector Switch D06 = Stop-Run Selector Switch E06 = Hand-Auto Selector Switch/Start-Stop Push Buttons
07	11–13	Pilot Device Options [2] [3]	A07 = Run Light (Red), Off Light (Green) B07 = Push-to-Test Run Light (Red), Push-to-Test Off Light (Green) C07 = Run Light (Red), Off Light (Green), Tripped Light/Reset (Yellow) D07 = PTT Run Light (Red), PTT Off Light (Green), Tripped Light/Reset (Yellow)
08	14–16	Metering Options	B08 = Elapsed Run Time Meter [3]
09	17–19	Miscellaneous Options	A10 = Floor Mounting Kit [4] B10 = Additional 150 VA [5] C10 = Power-Up On Delay Relay[6] D10 = Emergency Stop Push Button [5] E10 = cUL Label [7] F10 = Auxiliary Run Mode Contacts G10 = Auxiliary FB Bypass Contacts [8] H10 = Auxiliary Auto Mode Contacts [9] J10 = Auxiliary Trip Indication Contacts L10 = ID Engraved Nameplate [5] M10 = 10 Spare Terminal Blocks [5] P10 = Permanent Wire Markers [5] R10 = MOV-Surge Arrestor [5] U10 = Omit Door-Mounted Keypad Display [10] X10 = 50 °C Operation Y10 = Seismic qualification label Z10 = Service Entrance Rating [7] [11] 910 = American Recovery and Reinvestment Act (ARRA) Option

**Table 26.34: Enclosed Altistart 22 Catalog Number Example:**

**863922UCG4BA06A07**

Field	Digit						
	1	2	3	4	5	6	7
8639	22U	C	G	4	B	A06	A07
Controller Class	PowerPact™ Thermal- Magnetic Circuit Breaker	7.5 hp	Type 1 General Purpose	460 Vac	Basic Shunt Trip	Start-Stop Push Button	Run Light (Red), Off Light (Green)

[1] This option is not selectable with power circuit option B05.

[2] Select only one option.

[3] To omit, do not include a selection in the catalog number.

[4] This option is available only for enclosure size D.

[5] This option is not selectable with power circuit option B05

[6] This option is not selectable with power circuit option B05. This option is valid only with the following control options: C06, D06, or E06.

[7] Options E10 and Z10 cannot be used together.

[8] This option is not selectable with power circuit option B05. The contacts are available only when power circuit option Y05 is selected.

[9] The contacts are not available when power circuit option R05 is selected. This option is valid only with the following control options: C06, D06, or E06.

[10] If you select option U10, you must separately order the remote keypad (VW3G22101) and cable (VW3A1104R30) to commission the softstarter. Refer to the *ATS22 User Manual*, BBV51330, for serial communication programming and control capabilities.

[11] Options E10 and Z10 cannot be ordered together.

**Enclosed Altistart 22 Control Options (pick one)**

Mod A06	Start/Stop push buttons Provides black start and red stop push buttons (3-wire control scheme).
Mod B06	Forward-Off-Reverse selector switch Provides three-position selector switch to select between forward, off and reverse. Uses 2-wire control.
Mod C06	Hand-Off-Auto selector switch Provides a three-position selector switch, 2-wire control scheme.
Mod D06	Stop-Run selector switch Provides a two-position selector switch.
Mod E06	Hand-Auto selector switch and Start/Stop push buttons Provides a two-position selector switch and start/stop push buttons (3-wire control).

**Enclosed Altistart 22 Pilot Light Cluster Options (pick one)**

Mod A07	Pilot light cluster #1 Consists of red "RUN" and green "OFF" pilot lights. Provides standard red "RUN (ON)" and green "OFF" pilot lights for status annunciation.
Mod B07	Pilot light cluster #2 Consists of red "RUN" (push-to-test) and green "OFF" (push-to-test) pilot lights. Provides push-to-test type red "RUN (ON)" and standard green "OFF" pilot lights for status annunciation.
Mod C07	Pilot light cluster #3 Consists of red "RUN", green "OFF" and yellow "FAULT" pilot lights. Provides standard red "RUN (ON)", green "OFF" and yellow "FAULT" pilot lights for status annunciation.
Mod D07	Pilot light cluster #4 Consists of red "RUN (ON)" (push-to-test), green "OFF" (push-to-test) and yellow "FAULT" (push-to-test) pilot lights. Provides push-to-test type red "RUN (ON)", standard green "OFF", and push-to-test type yellow "FAULT" for status annunciation.

**Enclosed Altistart 22 Meter Display Options (pick one)**

Mod B08	Elapsed time meter Provides a seven-digit analog, non-resettable elapsed run time meter. Not available on Type 3R Enclosures
---------	---

**Enclosed Altistart 22 Miscellaneous Options (multiple compatible options may be selected)**

Mod A10	Floor mounting kit Only available for size D enclosures.
<b>Rules:</b> Available for power options S05, N05, R05, Y05.	
Mod B10	150 VA additional control power capacity Provides 150 VA additional control VA capacity for customer use.

## Information and Selection of AC Drives

For information and selection, contact your nearest Schneider Electric sales office or visit our website:

[www.schneider-electric.us](http://www.schneider-electric.us)

## Technical Support for AC Drives

### Drive Product Support Group

For support and assistance, contact the Drive Product Support Group. The Drive Product Support Group is staffed from 8:00 am until 8:00 pm Eastern time to assist with diagnosis of product problems. For support with applications or product selection, please contact a drive specialist at your local authorized Schneider Electric Distributor. Click here to locate an Automation and Control distributor near you: [Find Electrical, Automation and Control Distributors](#).

EMERGENCY Technical phone support is available 24 hours a day, 365 days a year.

**Toll Free:** 888-778-2733  
**E-mail:** [drive.products.support@schneider-electric.com](mailto:drive.products.support@schneider-electric.com)  
**Fax:** 919-217-6508

### Services (On-Site)

Square D Services is your single source of service expertise for all major brands of electrical equipment. With our national network of service locations and qualified experts, Square D Services is capable of providing customer-based solutions anywhere in the United States. Services responds to your requests, seven day a week, 24 hours a day.

**Toll Free:** (888-778-2733)

## Customer Training for AC Drives

Schneider Electric offers a variety of instructor-led, skill enhancing and technical product training programs for customers. For a complete list of drives/soft starter training with dates, locations, and pricing, please call:

**Phone:** 978-975-9306  
**Fax:** 978-975-2821

## Packaged Product Documentation for AC Drives

### Standard Documentation

Each adjustable frequency drive or soft starter shipped includes one set of instruction bulletins. Each set of instruction bulletins includes installation, start-up, troubleshooting and wiring diagram information. Separate Approval and/or Record Drawings are not included.

### Approval and Record Drawings

All factory orders for enclosed drives and soft starters come with factory supplied user drawings and are identified by a factory order number. The factory supplied drawing set typically includes:

- Enclosure outline drawing
- Power elementary drawing
- Control elementary drawing
- Interconnection drawing

These drawings are also available in DWG, DXF, IGS, Microcad and PDF formats upon customer request.

### Product Literature

To view or download product literature, visit the Schneider Electric web site:

[www.schneider-electric.us](http://www.schneider-electric.us)

# Section 27

## Automation Products



Modicon Zelio Logic Controller



Modicon M221 PLC



Modicon M241 PLC



Modicon M340 PAC



Lexium 28 Servo Solution



Magelis GTU Universal Panels

### Programmable Controllers

27-2

Modicon™ Zelio™ Logic Controller	27-2
Modicon™ M221 PLC	27-2
Modicon™ M241 PLC	27-2
Modicon™ M251 PLC	27-3
Modicon™ M258 PLC	27-3
EcoStruxure™ Machine Expert	27-3
Modicon™ TSX Micro™ PLC	27-4
PL7™ Application Software	27-4
Modicon™ Unity Momentum PLC	27-4
Modicon M340™ PAC	27-4
Modicon M580™ ePAC	27-4
Modicon Premium™ PAC	27-5
Modicon Quantum™ PAC	27-5
Unity™ Pro Application Software	27-5

### HMI Products

27-6

Magelis™ Small Panels HMI Products	27-6
Magelis™ Advanced Panels HMI Products	27-8
USB Accessories for Magelis HMI Terminals	27-10
Magelis™ Industrial PC Products	27-11

### Software for HMI Products

27-13

Vijeo™ Designer HMI Software	27-13
Vijeo™ Designer	27-13
Vijeo™ Designer Intelligent Data Services	27-13
Vijeo™ Design'Air HMI Application	27-13
Vijeo™ Design'Air Plus	27-14

### SCADA / Distributed I/O Products

27-14

Vijeo Citect SCADA Software	27-14
Vijeo™ Historian	27-14
Modicon™ OTB Distributed I/O System	27-14
Modicon™ STB Distributed I/O Platform	27-15
Modicon™ Telefast™ ABE7 Sub-bases, IP20	27-15
Modicon™ Telefast™ ABE9 Passive Splitter Boxes, IP67	27-15
Modicon™ TM7 I/O Blocks, IP67	27-15
Modicon™ Momentum™ Distributed I/O and PLC	27-16

### Network Products and Systems

27-17

Ethernet TCP/IP Products	27-17
ConneXium™ Ethernet Products	27-17
Transparent Ready™ Solutions	27-18
CANopen Network Products	27-19

### Motion Control / HVAC/R Controllers

27-20

Lexium™ Motion Control Products	27-20
HVAC/R Controllers	27-22



### Modicon™ Zelio™ Logic Controller

For applications that require more flexibility than a simple relay, timer or counter, but are too simple for the smallest Nano PLC, Zelio Logic smart relays are available. Designed to accept and control outputs just like a relay, Zelio Logic features logic programming with Function Block Diagram (FBD) or Ladder Logic Programming using either the front panel or by utilizing ZelioSoft software. For more information, refer to [www.schneider-electric.us](http://www.schneider-electric.us) Zelio Logic or catalog [DIA3ED211202EN](#).

Catalog Number	Description	Inputs	Outputs	Supply Volts
SR2A101FU	SR2 with Display	6 Digital	4 Relay	120 Vac
SR2B121BD	SR2 with Display	8 Digital, 4 Analog	4 Relay	24 Vdc
SR2B121FU	SR2 with Display	8 Digital	4 Relay	120 Vac
SR2D101FU	SR2 without Display	6 Digital	4 Relay	120 Vac
SR3B101BD	SR3 with Display	6 Digital, 4 Analog	4 Relay	24 Vdc
SR3B101FU	SR3 with Display	6 Digital	4 Relay	120 Vac
SR3B261BD	SR3 with Display	16 Digital, 6 Analog	10 Relay	24 Vdc
SR3B261FU	SR3 with Display	16 Digital	10 Relay	120 Vac
SR3XT101FU	SR3 Expansion	6 Digital	4 Relay	—
SR3XT61FU	SR3 Expansion	4 Digital	2 Relay	—

Catalog Number	Description
SR2MEM02	Memory Cartridge
SR2USB01	USB Programming Cable

### Modicon™ M221 PLC

Providing “Best in Class” performance for compact machine automation, the Modicon M221 PLC features intuitive machine programming using [SoMachine Basic software](#), ready-to-use applications and standard function blocks. Its flexible and scalable machine control allows you to easily upgrade to higher performance platforms when necessary. With Ethernet, USB and serial ports, the Modicon M221 PLC provides optimum connectivity for simplified machine integration and maintenance. See catalog [DIA3ED2140110EN](#).



TM221ME16T



TM221CE16R

Catalog Number	Description	Inputs	Outputs	Supply Volts
TM221C16R	Compact PLC 16 I/O Relay	9 Digital, 2 Analog	7 Relay	120 AC
TM221C24R	Compact PLC 24 I/O Relay	14 Digital, 2 Analog	10 Relay	120 AC
TM221C40R	Compact PLC 40 I/O Relay	24 Digital, 2 Analog	16 Relay	120 AC
TM221CE16R	Ethernet Compact PLC 16 I/O Relay	9 Digital, 2 Analog	7 Relay	120 AC
TM221CE16T	Ethernet Compact PLC 16 I/O PNP Transistor	9 Digital, 2 Analog	7 PNP	24 DC
TM221CE24R	Ethernet Compact PLC 24 I/O Relay	14 Digital, 2 Analog	10 Relay	120 AC
TM221CE24T	Ethernet Compact PLC 24 I/O PNP Transistor	14 Digital, 2 Analog	10 PNP	24 DC
TM221CE40R	Ethernet Compact PLC 40 I/O Relay	24 Digital, 2 Analog	16 Relay	120 AC
TM221CE40T	Ethernet Compact PLC 40 I/O PNP Transistor	24 Digital, 2 Analog	16 PNP	24 DC
TM221ME16R	Ethernet Modular PLC 16 I/O Relay	8 Digital, 2 Analog	8 Relay	24 DC
TM221ME16T	Ethernet Modular PLC 16 I/O PNP Transistor	8 Digital, 2 Analog	8 PNP	24 DC

### Modicon™ M241 PLC

Designed for high-performance compact machines, incorporating speed and position control functions—the Modicon M241 PLC features a dual core processor—that provides tremendous processing power and memory size for complex applications. Machine programming is highly intuitive using SoMachine software, function blocks and ready-to-use applications. And, the M241 PLC’s simplified motor control integration and wiring allow for quick start-up and commissioning.

Catalog Number	Communication	Inputs	Outputs	Supply Volts
TM241CE24R	Modbus TCP, EthernetIP, Modbus Serial, Ascii [1]	14 Digital	4 PNP, 6 Relay	24 dc
TM241CE24T		14 Digital	10 PNP	
TM241CE40R		24 Digital	4 PNP, 12 Relay	
TM241CE40T		24 Digital	16 PNP	
TM241CEC24R	Modbus TCP, EthernetIP, Modbus Serial, Ascii, CanOpen, CAN J1939 [1]	14 Digital	4 PNP, 6 Relay	
TM241CEC24T		14 Digital	10 PNP	
TM241CEC24U		14 Digital	10 NPN	

Additional versions available, please see [Modicon M241 Micro PLC](#) or catalog [DIA3ED2140107EN](#) for additional information.



TM241CE40T

[1] NOTE: Profibus DB is available via TM4 expansion module.



TM251MESE

TM251MES3

### Modicon™ M251 PLC

The Modicon M251 PLC provides innovative, high-performance solutions for modular machines and distributed architectures with line control. Its intuitive SoMachine software, ready-to-use applications and function blocks allow you to optimize your programming time. And, its flexible and scalable machine control allows you to change the PLC hardware type to fit the application, using the same programming across the range. The M251 PLC allows you to stay connected everywhere via Ethernet, wireless access, web servers and remote visualization... simplifying machine integration and maintenance. Its integrated Ethernet switch - on a separate channel from the machine control network - allows data exchange with other machines and system networks, while keeping the machine control on a dedicated high-performance local network.

Catalog Number	Description	Com 1	Com 2	Supply Volts
<b>The M251 can be further enhanced using the TM3 (I/O &amp; Safety), TM4 (communication), and TMC (I/O) expansion modules.</b>				
TM251MESE	Dual Channel Ethernet PLC	Dual Port Ethernet	Ethernet as Master	24 dc
TM251MES3	Ethernet and CANopen PLC	Dual Port Ethernet	CANopen as Master	24 dc

Additional versions available, please see our [website](#) and catalog [DIA3ED2140108EN](#) for additional information.

Catalog Number	Description
<b>TM3 I/O Expansion Modules for M221, M241, M251 PLCs. Up to 7 modules per PLC. Add TM3XTRA1 + TM3XREC1 to add 8-14 TM3 modules. Additional TM3 modules are available.</b>	
TM3AI4	I/O Module 4 Analog Inputs
TM3AI8	I/O Module 8 Analog Inputs
TM3AM6	I/O Module 4 Analog Inputs and 2 Analog Outputs
TM3AQ2	I/O Module 2 Analog Outputs
TMA3Q4	I/O Module 4 Analog Outputs
TMA3DI16	I/O Module 16 Inputs
TM3DI8	I/O Module 8 Inputs
TM3DI8A	I/O Module 8 Inputs 120 Vac
TM3DM8R	I/O Module 8 IO Relays
TM3DQ16R	I/O Module 16 Outputs Relays
TM3DQ16T	I/O Module Outputs Transistor PNP
TM3DQ8R	I/O Module 8 Outputs Relays
TM3DQ8T	I/O Module Outputs Transistor PNP
TM3TI4	I/O Module 4 Inputs Temperature
TM3TI8T	I/O Module 8 Inputs Temperature
TM3XTRA1	I/O Expansion Transmitter for 8-14 TM3 Modules
TM3XREC1	I/O Expansion Receiver for 8-14 TM3 Modules

### Modicon™ M258 PLC

The Modicon M258 logic controller is a compact, high-performance and fully expandable PLC. It forms a part of Flexible Machine Control approach, a key component of Machine Struxure, which brings you maximum flexibility and ensures the most optimized control solution. This PLC is designed for machine manufacturers (OEMs) focusing on applications such as packaging, conveying and storage, textiles and woodworking, etc. It offers high-performance solutions for speed control, counting, axis control, and communication functions. The Modicon M258 logic controller's dual-core processor provides extremely high performance. Core 1 is dedicated exclusively to managing program tasks and offers the maximum resources for real-time execution of the application code. Core 2 is dedicated to executing communication tasks, which have no impact on the application performance. More information is available at [www.schneider-electric.us Modicon M258 PLC](#) and in catalog [DIA6ED2100402EN](#).



### EcoStruxure™ Machine Expert

EcoStruxure™ Machine Expert (formerly known as SoMachine) is the OEM solution software for developing, configuring and commissioning the entire machine in a single software environment, including logic, motion control, HMI and related network automation functions. EcoStruxure™ Machine Expert allows you to program and commission all the elements in Schneider Electric's Flexible and Scalable Control platform, the comprehensive solution-oriented offer for OEMs, which helps you achieve the most optimized control solution for each machine's requirements. Flexible and Scalable Control platforms include:

**Match your controller to the available software package:**

MachineStruxure Product Range	Schneider Electric Software	Software Distribution
Zelio Logic: Smart Relays 10 to 40 I/O	Zelio Soft: Zelio Logic configuration software	Free to Download
Modicon M171 / M172: HVAC Logic Controller	SoMachine HVAC	Available to order
Modicon M221 Nano PLC	SoMachine Basic	Free to Download
Modicon Motion: M221, M241, M251, M258, LMC058, and LMC078	SoMachine NOTE: Vijeo Designer and SoMachine Basic are included	Available to order
Magelis HMI: SCU and XBTGC		
PacDrive Motion Controller	SoMachine Motion	Available to order

SoMachine is a professional, efficient, and open software solution for integrating Vijeo™ Designer. It also integrates the configuring and commissioning tool for motion control devices. It features all six IEC 61131-3 languages, integrated field bus configurators, expert diagnostics and debugging, as well as outstanding capabilities for maintenance and visualization.



More information is available at [www.schneider-electric.us](http://www.schneider-electric.us) [EcoStruxure™ Machine Expert](#) and catalog [DIA3ED2140110EN](#).

### Modicon™ TSX Micro™ PLC

Compact and cost-efficient, this mid-range PLC boasts the power and flexibility OEMs find most desirable. Optional integrated safety relays, half-size I/O and web-enabled modules provide seamless connection to supervisory maintenance systems plus minimize real estate. PCMCIA memory cards preserve your investment when expanding. Communication options include Ethernet and ASi for global access using Open standards. More details are available at [www.schneider-electric.us](http://www.schneider-electric.us) [Modicon TSX Micro PLC](#) and catalog [MKTED204012EN](#).



### PL7™ Application Software

PL7 application software complies with the IEC 61131 standard for programming software. PL7 can be programmed in four IEC languages including two text-based editors (Structured Text and Instruction List), and two graphic-based editors (Sequential Function Chart and Ladder Diagram). PL7 software promotes productivity by using structured programming, which increases reusability, while reducing maintenance costs, and can be used to program both the Micro PLC and the Premium PAC. More information is available at [www.schneider-electric.us](http://www.schneider-electric.us) [PL7 Programming Software](#) and catalog [MKTED208054EN-US](#).



### Modicon™ Unity Momentum PLC

The small footprint and open architecture of the Momentum PLC product line make it extremely versatile for a variety of automation applications. The Unity Momentum PLC is ideal for PC-based control, distributed control, distributed I/O, and traditional, standalone PLC control. The Momentum PLC product line includes I/O bases and communication adapters that are interchangeable and snap together to deliver optimal flexibility throughout the control system life cycle. Using Ethernet as its communications backbone, the Modicon Unity Momentum CPU delivers all the performance benefits of real-time control. The open architecture of the Unity Momentum CPU makes it a universal controller for distributed I/O, compatible with many of the major fieldbus and control network environments. An integral Ethernet port in the Unity Momentum CPU allows users to perform a wide range of functions over Ethernet, including data acquisition, peer-to-peer communications, and I/O scanning. Embedded web pages enable the use of a standard web browser to read status and diagnostic information from the processor. The Unity Momentum CPU not only seamlessly connects I/O and other control devices via open standards; it delivers the performance of a full function, realtime controller for stand-alone and distributed system configurations in one moneysaving unit. Additional information can be found at [www.schneider-electric.com](http://www.schneider-electric.com).



### Modicon M340™ PAC

Our latest midrange PAC is the most integrated ever! Highly requested by industrial OEMs and end users, the all-power-inside concept boasts high-performance processing and small size to create a system that provides flexibility beyond any before. With up to three built-in CPU communication ports, large memory options, sixty-four channel high-density modules, and embedded web servers, the Modicon M340 is a powerful solution for industrial OEMs and end users demanding more productivity in their PACs. The Modicon M340 PAC supports advanced communications such as enhanced Ethernet/IP which support Ethernet/IP, Modbus TCP/IP, and daisy chain loop communications on the same four-port, rack mounted switch module. It will also support DNP3.0 in serial or Ethernet in a rack-mounted RTU module. The Modicon M340 PAC is programmed with Unity Pro software, which allows users to dramatically reduce setup time and effort with features like drag 'n drop CANopen bus setup and standard IEC 61131-3 language selection. Designers gain fast, easy and efficient startups. More details are found on our website or in the latest Modicon M340 catalogs and brochures. More details are available at [www.schneider-electric.us](http://www.schneider-electric.us) [Modicon M340 PAC](#) and catalog [DIA6ED2061001EN-US](#).



### Modicon M580™ ePAC

The Modicon M580 ePAC (Ethernet Programmable Automation Controllers) features openness, flexibility, robustness and sustainability. The M580 ePAC is designed with an Ethernet backbone to optimize connectivity and communications. The microprocessor has three native Ethernet ports on the chip. Schneider Electric collaborated with the supplier to design the microprocessor, and in 2013 the supplier agreed to provide the microprocessor for 20 years, helping to protect customers' long-term investments. The powerful processors offer high levels of computation for complex networked communication, display and control applications. The M580 ePAC is designed for cybersecurity. It has an Achilles Level 2 certification. Achilles Level 2 certification by Würldtech is considered to be the best cybersecurity certification available for PACs. The M580 has other advanced embedded cyber security features that are defined by IEC 62443. This includes, but is not limited to the ability to disable unused services, control of remote access to the PAC and integrity checks of Unity Pro executable files. The M580 ePAC supports X80 common I/O modules which can be easily integrated into its architecture. More details are available at [www.schneider-electric.us](http://www.schneider-electric.us) [Modicon M580 PAC Controller](#).







**Modicon Premium™ PAC**

Ideally suited for discrete manufacturing, complex OEM applications as well as municipality and infrastructure applications, this cost-effective PAC line features integrated functions such as weighing, interpolated motion control, and process loops. Using the built-in Ethernet port, user-customized web page capabilities, and a range of popular open-standard fieldbus connections, the Modicon Premium enables seamless communication with enterprise systems providing low-cost remote maintenance diagnostics. More details are available at [www.schneider-electric.us](http://www.schneider-electric.us) [Modicon Premium PAC](#).



**Modicon Quantum™ PAC**

The Modicon Quantum PAC is our high-end, full function PLC designed for high I/O count industrial applications that require high performance such as Pharmaceutical, Petrochemical, Food and Beverage, Automotive, and others. Quantum also offers true bumpless hot standby. Quantum processors can be programmed with Unity Pro software, and can also support legacy 984 ladder logic programs in the LL984 Unity Pro editor by simply importing the legacy application program. Concept™ application software and ProWORX™ 32 application software are also supported on the Quantum platform. The Unity Quantum's onboard memory can exceed 3 Mbytes, and can have more than 7 Mbytes of extended memory on a PCMCIA card for data and application storage combined. It can also provide over 8 Mbytes of data storage alone. The Quantum PLC also offers Safety PAC versions certified for use in up to SIL3 applications. This includes both standard and hot standby capability as well as redundant I/O. It programs with Unity Pro XLS. The SIL3 offer stresses both high reliability as well as high availability. More details are available at [www.schneider-electric.us](http://www.schneider-electric.us) [Modicon Quantum PAC](#) and catalog [DIA6ED2110705EN-US](#).



**Unity™ Pro Application Software**

Unity Pro software for application development is compliant with IEC 61131-3. It includes the five IEC editors and an LL984 editor to support imported 984 ladder logic from legacy hardware. Unity Pro is compatible with all Industrial midrange and high-end controllers including Modicon Momentum, M340, Premium, M580 and Quantum PACs. Unity Pro provides a collaborative automation environment that enables individuals and teams to work together more effectively, reducing the cost of developing and managing automation solutions. Unity Pro XLS software is used to program the SIL3 Quantum as well as all other Unity-based platforms. Since one software package can program all the platforms, it greatly simplifies development and support issues. It integrates commercial IT technologies like Ethernet, VBA, XML and hyperlinks within the traditional control framework to enable customers to reduce the cost of automating both discrete and batch control applications. More details are available at [www.schneider-electric.us](http://www.schneider-electric.us) [Unity Pro](#) and catalog [MKTED2140504EN](#).

### Magelis™ Small Panels HMI Products

The Magelis XBTN, XBTR, XBTRT, STO and STU Small Panels have been specifically designed to satisfy the requirement for panels that are compact and easy to use. These terminals are easy to configure, and they work seamlessly with other Schneider Electric equipment to provide a complete automation solution, dedicated to simple or compact machines.

#### Magelis XBT N/R/RT

The Magelis XBTN/R/RT small HMI are an ideal solution for simple machines. The XBTN and XBTR models can accommodate up to four lines of twenty characters and are available with a tri-color backlight (green/orange/red). The XBTRT models have a semi-graphical display with resistive touch screen. All models have customizable function keys.

Key features of the Magelis XBTN/R/RT:

- Monochrome alphanumeric display
- Tri-color backlight available on some models (green/orange/red)
- Semi-graphical display and touch screen on the XBTRT models
- Serial communication port for PLC connection
- Powered by 5 Vdc from PLC terminal port or 24 Vdc externally
- Operating temperature: 32—151 °F (0—55 °C)
- Configured by Vijeo Designer Lite
- IP65, NEMA 4X (outdoor use), XBTN/R only
- Certifications include CE, cULus, Class 1 Div 2

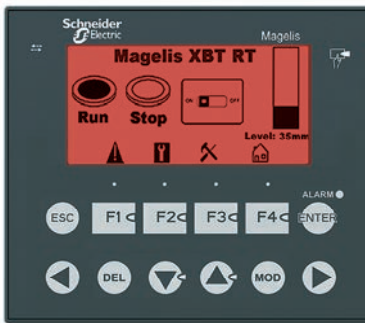
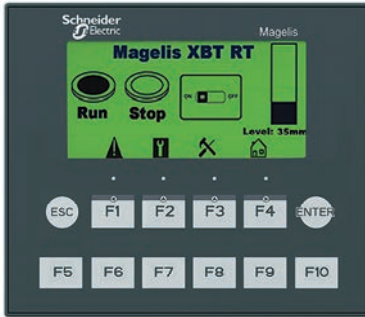

Catalog Number	Screen Type	Keys	Touch Screen	Supply Voltage	Com Port
XBTN200	2x20 Alphanumeric LCD with Green Backlight	4 fixed + 4 customizable	—	5 Vdc (PLC Port)	RS232C/RS485 (RJ45)
XBTN400	4x20 Alphanumeric Matrix LCD (122x32) with Green Backlight	4 fixed + 4 customizable	—	5 Vdc (PLC Port)	RS232C/RS485 (RJ45)
XBTN401	4x20 Alphanumeric Matrix LCD (122x32) with Green/Orange/Red Backlight	4 fixed + 4 customizable	—	24 Vdc (external)	RS232C/RS485 (SUB-D 25)
XBTN410 [1]	4x20 Alphanumeric Matrix LCD (122x32) with Green Backlight	4 fixed + 4 customizable	—	24 Vdc (external)	RS232C/RS485 (SUB-D 25)
XBTNU400	4x20 Alphanumeric Matrix LCD (122x32) with Green Backlight	4 fixed + 4 customizable	—	24 Vdc (external)	RS232C/RS485 (SUB-D 25)
XBTR400	4x20 Alphanumeric Matrix LCD (122x32) with Green Backlight	8 fixed + 12 customizable	—	5 Vdc (PLC Port)	RS232C/RS485 (SUB-D 25)
XBTR410	4x20 Alphanumeric Matrix LCD (122x32) with Green Backlight	8 fixed + 12 customizable	—	24 Vdc (external)	RS232C/RS485 (SUB-D 25)
XBTR411	4x20 Alphanumeric Matrix LCD (122x32) with Green/Orange/Red Backlight	8 fixed + 12 customizable	—	24 Vdc (external)	RS232C/RS485 (SUB-D 25)
XBTRT500	Semi-graphical Matrix LCD (198x80) with Green Backlight	2 fixed + 10 customizable	Yes	5 Vdc (PLC Port)	RS232C/RS485 (RJ45)
XBTRT511	Semi-graphical Matrix LCD (198x80) with Green/Orange/Red Backlight	2 fixed + 10 customizable	Yes	24 Vdc (external)	RS232C/RS485 (RJ45)

[1] Preloaded with application for connection to Tesys model U motor starter.



### Magelis STO

The Magelis STO is a compact, panel-mounted HMI that bring a cost-effective solution to machine builders. With its touch screen, 3.4 inch monochrome display, and multi-color backlight options, it is a great fit for small, compact or simple machines.

Key features of the Magelis STO:

- 3.4 inch monochrome (200x80 pixel) STN LCD display with multi-color backlight
- Resistive touch screen
- One USB v2.0 host type A port + one USB v2.0 mini-B port
- Serial or Ethernet communication port
- Powered by 24 Vdc
- Operating temperature: 32—151 °F (0—55 °C)
- Configured by Vijeo Designer
- IP65, NEMA 4X (indoor use)
- Certifications include CE, cULus, Class 1 Div 2

Catalog Number	Backlight Colors	Com Port	Ethernet
HMISTO501	White, Pink, Red	RS232C for Zelio [2] (removable terminal block)	—
HMISTO511	Green, Orange, Red	RS232C/RS485 (RJ45)	—
HMISTO512	White, Pink, Red	—	Ethernet (RJ45)
HMISTO531	White, Pink, Red	RS232C/RS485 (RJ45)	—
HMISTO532	White, Pink, Red	—	Ethernet (RJ45)

### Magelis STU

The Magelis STU is a compact HMI that is mounted using a 22 mm diameter hole - similar to a push button. This helps reduce overall cost by minimizing the labor for installing the HMI. The STU is a cost-effective solution for machine builders.

Key features of the Magelis STU:

- 3.5 or 5.7 inch TFT color display, QVGA (320 x 240)
- Resistive touch screen
- One USB v2.0 host-type A port + one USB v2.0 mini-B port
- Serial and Ethernet communication ports
- Powered by 24 Vdc
- Operating temperature: 32–122°F (0–50°C)
- Configured by Vijeo Designer
- IP65, NEMA 4X (indoor use)
- Certifications include CE, cULus, Class 1 Div. 2, Marine

Catalog Number	Screen Size	Com Port	Ethernet
HMISTU655	3.5 in. TFT Color (320x240)	RS232C/RS485 (RJ45)	Ethernet (RJ45)
HMISTU855	5.7 in. TFT Color (320x240)	RS232C/RS485 (RJ45)	Ethernet (RJ45)



[2] Enables direct communication with the Zelio Logic SR2/SR3 range of controllers.



### Magis SCU Small HMI Controllers

The ultra-compact range of Magis SCU small HMI controllers is part of Schneider Electric's Flexible Machine Control concept, a key element in MachineStructure™. The Magis SCU HMI Controllers product offer brings together Human Machine Interface and control functions within a single product. This reduces the amount of equipment required and the associated costs throughout the life cycle of the machine. It is mounted using a 22 mm diameter hole, which considerably simplifies installation.

#### Key features of the Magis SCU:

- 3.5 or 5.7 inch TFT color display, QVGA (320 x 240)
- Resistive touch screen
- One USB v2.0 host type A port + one USB v2.0 mini-B port
- Serial, Ethernet and CANopen communication ports
- Removable terminal blocks for I/O connections
- Powered by 24 V dc
- Operating temperature: 32–122°F (0–50°C)
- Configured by SoMachine
- IP65 NEMA 4X (indoor use)
- Certifications include CE, cULus, Class 1 Div. 2

Catalog Number	Screen Size	Digital Inputs	High Speed Counter Inputs	Digital Relay Outputs	Pulse Train Outputs	Analog Inputs	Temperature Inputs	Analog Outputs
HMISCU6A5	3.5 in.	14	2	8	2	—	—	—
HMISCU6B5	3.5 in.	6	2	6	2	2	2	2
HMISCU8A5	5.7 in.	14	2	8	2	—	—	—
HMISCU8B5	5.7 in.	6	2	6	2	2	2	2

See catalog [DIA5ED2130505EN](#) for more information.

### Magis™ Advanced Panels HMI Products

The Magis Advanced Panels are touch screen HMIs that are designed for the most demanding industrial applications. Choose between several platforms and screen sizes for the best cost and performance to suit your needs.

#### Magis GTO Optimized Panels

The Magis GTO Optimized Panels are ideal for OEMs that need a cost-effective solution with enough functionality for demanding applications. The GTO's built-in connectivity includes serial ports, Ethernet, and USB. Via Ethernet, they support a Web server, FTP, e-mail, and remote access from a PC, smart phone, or tablet applications. The panels are designed for industrial environments. A stainless steel version is available that is resistant to high-pressure cleaning (conforming to DIN 40050–9). Key features of the Magis GTO:

- TFT color LCD display with 50,000 hour backlight
- Resistive analog touch screen
- One USB v2.0 host type A port + one USB v2.0 mini-B port
- Powered by 244 V dc
- Configured by Vijeo Designer
- IP65, NEMA 4X (indoor use), IP66K for Stainless Steel models
- Certifications include CE, cULus, Class 1 Div. 2, Marine

See Catalog [DIA5ED2130616EN](#) for more information.



Catalog No.	Screen Size	Stainless Steel	Function Keys	Com Ports	Ethernet	SD Card Socket	Operating Temp
HMIGTO1300	3.5 in. QVGA (320x240)	—	Yes	2 Ports	—	—	32–131 °F (0–55 °C)
HMIGTO1310	3.5 in. QVGA (320x240)	—	Yes	1 Port	1 Port	Yes	32–131 °F (0–55 °C)
HMIGTO2300	5.7 in. QVGA (320x240)	—	—	2 Ports	—	—	32–131 °F (0–55 °C)
HMIGTO2310	5.7 in. QVGA (320x240)	—	—	2 Ports	1 Port	Yes	32–131 °F (0–55 °C)
HMIGTO2315	5.7 in. QVGA (320x240)	Yes	—	2 Ports	1 Port	Yes	32–131 °F (0–55 °C)
HMIGTO3510	7.0 in. WVGA (800x480)	—	Yes	2 Ports	1 Port	Yes	32–131 °F (0–55 °C)
HMIGTO4310	7.5 in. VGA (640x480)	—	—	2 Ports	1 Port	Yes	32–131 °F (0–55 °C)
HMIGTO5310	10.4 in. VGA (640x480)	—	—	2 Ports	1 Port	Yes	32–131 °F (0–55 °C)
HMIGTO5315	10.4 in. VGA (640x480)	Yes	—	2 Ports	1 Port	Yes	32–131 °F (0–55 °C)
HMIGTO6310	12.1 in. SVGA (800x600)	—	—	2 Ports	1 Port	Yes	32–131 °F (0–55 °C)
HMIGTO6315	12.1 in. SVGA (800x600)	Yes	—	2 Ports	1 Port	Yes	32–131 °F (0–55 °C)



### Magelis™ XBTGH Handheld HMI

The Magelis XBTGH is a handheld HMI that enables operator mobility around a machine. It is ideal for machine setup and troubleshooting as well as normal operation. Key Features of the Magelis XBTGH:

- 5.7 in. color TFT LCD display, VGA (640 x 480), 50,000 hour backlight
- Resistive analog touch screen
- Eleven programmable function keys with customizable labels + one enable button
- Emergency stop button with two NC safety contacts and one NO auxiliary contact
- Key switch for turning the HMI on/off
- Three-position grip switch to signal that the operator is ready
- Designed to be held by one hand
- Integrated stylus for touch screen operation
- Connectivity includes one serial port, one Ethernet port, and one USB Type A port

Catalog Number	Description
XBTGTH2460	Handheld HMI with E-stop button
XBTGTH2460B	Handheld HMI without E-stop button
XBTZGJBOX	Junction box for handheld HMI
XBTZGHL3	3 meter cable for handheld HMI
XBTZGHL10	10 meter cable for handheld HMI
XBTZGHL20	20 meter cable for handheld HMI

New!

### Magelis GTU Universal Panels

The Magelis GTU Universal Panels are a high performance HMI product range designed with the uniqueness of modularity that allows you to select and assemble the best combination of display unit and CPU module for the application requirements. Magelis GTU features operator efficiency, simplified installation and flexibility that fits almost any system. This product range includes: display modules (Advanced and Smart) and CPU box modules (Premium and Open).



#### Key features of the Magelis GTU:

##### Premium Box CPU Module:

- Magelis proprietary OS
- SD Card for OS and application
- Second SD Card socket for user data
- 2x USB 2.0 (Type A) and 1x USB 2.0 (mini-B)

##### Open Box CPU Module:

- Window Embedded 7 OS
- CFast Card for OS and application
- SD and CFast Card sockets for user data
- 3x USB 2.0 (Type A) and 1x USB 2.0 (mini-B)
- DVI-D output for external monitor

CPU Box Type	Catalog Number	Operating System	Video Out	Com Ports	Ethernet	USB 2.0 Ports	Memory Card Socket
Premium Box	HMIG3U	Magelis Proprietary OS	—	2 Ports	2 Ports	2x (Type A) 1x (mini-B)	1x SD for system (included) 1x SD socket for user data
Open Box	HMIG5U	Windows Embedded 7	DVI-D	2 Ports	2 Ports	3x (Type A) 1x (mini-B)	1x CFast for system (included) 1x CFast socket for user data 1x SD socket for user data

#### Common Features:

- Modular design, any combination of display module and CPU box
- Two serial and two Ethernet ports for communications
- Powered by 12....24 Vdc
- Operating temperature: 32–140°F (0–60°C)
- Configured by Vijeo Designer
- IP66/67, NEMA 4X (indoor use)
- Certifications include: CE, cULus, Class 1 Div. 2, Marine

#### Smart Display Module:

- 16M color TFT LCD display (4:3 format)
- Resistive analog touch screen, multi-touch capable
- Front panel USB 2.0 ports, 1x (Type A) and 1x (mini-B)
- Sensor for automatic backlight brightness control

#### Advanced Display Module:

- 262k color TFT LCD display (16:9 format)
- Resistive analog touch screen, single touch

Display Type	Catalog No.	Screen Size	Front USB Ports	Brightness Sensor	Built-in Wireless LAN	Multi-touch Capable [3]
Smart Display (4:3) 16 M Colors	HMIDT542	10.4 in. SVGA (800x600)	Yes	Yes	—	Yes
	HMIDT642	12.1 in. XGA (1024x768)	Yes	Yes	—	Yes
	HMIDT643	12.1 in. XGA (1024x768)	Yes	Yes	Yes	Yes
	HMIDT732	15.0 in. XGA (1024x768)	Yes	Yes	—	Yes
Advanced Display (16:9) 262k Colors	HMIDT351	7.0 in. WVGA (800x480)	—	—	—	—
	HMIDT551	10.1 in. WVGA (1280x800)	—	—	—	—
	HMIDT651	12.1 in. WVGA (1280x800)	—	—	—	—

[3] Projects created in Vijeo Designer do not support multi-touch.

## USB Accessories for Magelis HMI Terminals

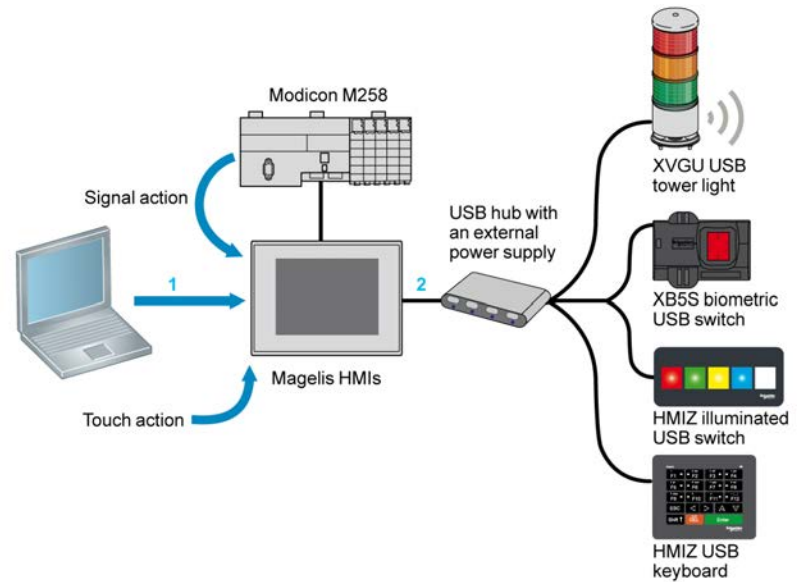

The USB accessories for Magelis are designed to expand the selection range of user applications by offering value-added/differentiated HMI solutions. These innovative USB accessories can be easily installed and operated with HMI terminals.

### Illuminated Switch Panel

The illuminated USB switch is uniquely designed for easy visualization and quick acknowledgement of alarm (wide view angle and brightness). This switch with tactile feedback can also be used as function keys in HMI applications that involve repetitive operations in dirty environments. This keeps the touch panel clean and protected by avoiding continuous finger contact.

Key features of the Illuminated USB Switch:

- Five programmable switches with tactile feedback
  - Programmable six-color LED illumination per switch
  - Connect to the Magelis HMI via USB
  - Mount to the panel through a 22 mm hole
  - Powered by the HMI via the USB cable
  - Configured in Vijeo Designer
  - IP65, NEMA 4X (indoor use)
  - Certifications include CE, cULus, Class 1 Div. 2
- Catalog Number: [HMIZRA1](#)  
See Catalog [DIA5ED2130901EN](#) for more information.

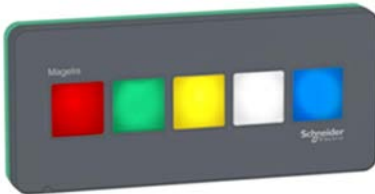



### Keyboard Panel

The USB Keyboard is designed for flexible mounting and easy configuration. The tactile keys are suited for HMI applications with repetitive operations or dirty environments (oil, dust). Functionality of the HMI can be extended with external function keys, status indicator LEDs and both numeric and text data entry.

#### Key features of the USB Keyboard:

- Twenty-key membrane keyboard with tactile feedback
- Includes twelve programmable keys with integrated LEDs
- Connect to the Magelis HMI via USB
- Mount to the panel through a 22 mm hole
- Powered by the HMI via the USB cable
- Configured in Vijeo Designer
- IP65, NEMA 4X (indoor use)
- Certifications include CE, cULus, Class 1 Div. 2  
Catalog Number: [HMIZKB1](#)

See Catalog [DIA5ED2130901EN](#) for more information.

### Biometric Switch

The XB5S Biometric USB Switch of the Harmony® XB5S product range controls and secures access to systems and machines by checking users' authorization through fingerprint recognition.



#### Key features of the Harmony XB5S Biometric Switch:

- Register up to 200 users, two fingerprints per user
- Connect to the Magelis HMI via USB
- Mount to the panel through a 22 mm hole
- Powered by external 24 V dc source
- IP65
- Certifications include CE, cULus  
Catalog Number: [XB5S5B2L2](#)

See Catalog [DIA5ED2130901EN](#) for more information.

### Tower Light

The monolithic USB tower lights of the Harmony XVGU product range have multi-color LEDs that are unique and simple-to-use. The states and patterns are directly set and modified in the HMI application. The XVGU tower lights provide long distance indication of the operating status or sequences of a machine or installation, both visually by illuminated signaling units with 360° visibility, and audibly by a buzzer.



#### Key features of the Harmony XVGU USB Tower Light:

- Unique one-piece LED tower design, 60 mm
- Three transparent signaling layers
- Two-tone buzzer with three level volume control and four colors
- Variety of signal patterns (flashing/non-flashing lights)
- Power and signaling managed by the HMI
- Installation options (on direct base or tube plate)  
Catalog Number: XVGU3SHAV (100 mm length pole with mounting base)

Catalog Number: XVGU3SWV (direct base mounting)

See Catalog [DIA5ED2130901EN](#) for more information.

## Magelis™ Industrial PC Products

### Magelis™ Panel PC

The Magelis Panel PC is a family of panel-mounted all-in-one industrial PCs, certified for automation applications.

Features of the Magelis Panel PCs:

- TFT color LCD display, available in 10.4, 12.1, 15.0, and 19.0 in. screen sizes
- Resistive analog touch screen
- Stainless steel models available
- Variety of CPUs and performance levels
- Options for mass storage (HDD, SSD, memory card, DVD-RW, RAID)
- Variety of Windows operating systems options
- Options for add-in card slots
- Communication options including COM ports, Ethernet, and USB
- Fanless models available
- Supply power, 100...240 V ac or 24 V dc with option for battery back-up
- Vijeo Designer Run-time trial mode pre-installed
- IP65, NEMA 4X (indoor use)
- Certifications include CE, cULus, Class 1 Div. 2





### Magelis™ Box PC

The Magelis Box PC is a family of wall-mounted, Industrial PCs certified for automation applications. The Box PC interfaces seamlessly with a Magelis Display Industrial Monitor.

Key features of the Magelis Box PC:

- Variety of CPUs and performance levels
- Options for mass storage (HDD, SSD, memory card, DVD-RW, RAID)
- Variety of Windows operating system options
- Options for add-in card slots
- Communication options including COM ports, Ethernet and USB
- Fanless models available
- Supply power: 24 V dc with option for battery backup

**New!**

### Magelis™ Simple Box PC

The Magelis S-Box PC is a simpler, more basic alternative to the Magelis Box PC. This cost effective, tested, and validated solution is suitable for repetitive machines and infrastructure applications. These low-maintenance PCs provide a high level of connectivity in a compact design. Remote monitoring capability gives you peace of mind that the system is performing as desired.

Key features of the Magelis S-Box PC:

- CPU options, ATOM N270 (single core) or ATOM N2600 (dual core)
- No moving parts (fanless, solid state disks)
- Windows operating systems options
- Mini PCIe slot for option cards
- Communication options including COM ports, Ethernet, and USB
- DC power supply
- Remote system monitor utility included
- Vijeo Designer Run-time trial mode pre-installed
- Certifications include CE, cULus

The Magelis S-Box PCs are available as catalog items, with pre-configured features such as CPU, RAM, storage type, operating system, and other options. For more information and a list of available catalog numbers, please [www.schneider-electric.com](http://www.schneider-electric.com).

See Catalog [DIA5ED2140501EN](#) for more information.

**New!**

### Magelis™ Rack PC

Magelis Rack PC easily installs into standard 19 inch racks in control room applications. Choose between several platforms for the best cost and performance to suit your needs. The Rack PC can serve as an engineering and SCADA server or an operator station. Supported software includes: Vijeo Designer, Run-time, Vijeo Citect, and PlantStruxure PES Distributed Control System.

**Key features of the Magelis Rack PC:**

- Available in 2U and 4U form factors
- Variety of CPUs and performance levels
- Options for mass storage (HDD, SSD, memory card, DVD-RW, RAID)
- Hot swap drive trays
- Options for add-in card slots
- Windows operating systems options
- Mini PCIe slot for option cards
- Communication options including COM ports, Ethernet, and USB
- Redundant power supply option
- Remote system monitoring utility included
- Vijeo Designer Run-time trial mode pre-installed
- Certifications include CE, cULus

Magelis Rack PCs are available as catalog items, with pre-configured features such as CPU, RAM, storage type, operating system, and other options. For more information and a list of available catalog numbers, please visit [www.schneider-electric.com](http://www.schneider-electric.com).

See Catalog [DIA5ED2140501EN](#) for more information.





New!

### Magelis™ iDisplay Industrial Multi-Touch Monitor

The next generation of Magelis iDisplays features multi-touch monitors enabling the operator to use common gestures such as swiping and pinching in industrial applications. They also provide updated connectivity to seamlessly connect to a Magelis Box PC, Rack PC (or third party PC) via DVD-D (for video) and USB (for touch screen).

#### Key features of the Magelis iDisplay:

- TFT LCD display, 16M colors, XGA (1024 x 768), 4:3 format
  - 50,000 hour backlight
  - Resistive analog touch screen, multi-touch supported
  - Panel mount or VESA mount
  - DVI-D video input from host PC
  - USB connection to host PC for touch screen interface
  - Front panel USB v2.0 host type A port for keyboard, mouse, or memory stick, etc.
  - Powered by 12–24 V dc
  - Operating temperature: 32–140°F (0–60°C)
  - IP66/67, NEMA 4X (indoor use)
  - Certifications include CE, cULus, Class 1 Div. 2, Marine
  - Catalog Numbers: **HMIDID64DTD1**(12.1 in. display); **HMIDID73DTD1**(15.0 in. display)
- See Catalog [DIA5ED2140501EN](#) for more information.



### Vijeo™ Designer HMI Software

#### Vijeo™ Designer

Vijeo Designer is the configuration software for creating operator interface applications for Magelis HMI's and Industrial PCs. It is the ideal design tool for the simplest control application right up to the most complex HMI installations. It offers advanced script functions, recipe management, alarm management, data management, remote access, e-mail and multi-protocol connectivity.

Vijeo Designer features a screen graphics editor, including simple objects, a library of animated objects (bar graphs, meters, charts and tanks), and preconfigured advanced objects (buttons, lamps, numeric and message displays and enumerated lists).

Vijeo Designer has advanced communication support for Schneider Electric products. It also includes drivers for several third-party PLCs and devices.



Catalog Number	Description
VJDSNDTGSV62M	Single license
VJDSUDTGA62M	Single license, with transfer cable
VJGNDTGSV63M	Group license, three stations
VJDTNDTGSV62M	Team license, ten stations
VJDFNDTGSV62M	Facility license, unlimited stations for one site
VJDSNRTMPC	Run-time license for a Magelis IPC

For more information, refer to [www.schneider-electric.us](http://www.schneider-electric.us) [Vijeo Designer HMI Software](#) and catalog [DIA5ED2130614EN](#).

#### Vijeo™ Designer Intelligent Data Services

The Intelligent Data Services (IDS) add-on for Vijeo Designer is a powerful, flexible and innovative software, fully compliant with FDA 21 CFR PART 11. It provides full traceability of the process, enables process variables to be monitored, and allows tracking of all operator actions. IDS software is easily accessible from any Web browser, enabling data collection via Ethernet, providing dashboards and reports generation.

Catalog Number [1]	Description
VJDSNTRCKV62M	IDS run-time license, single station
VJDSNTRPRV62M	IDS report printing add-on
VJDSNTRPKV62M	IDS report printing add-on with run-time license

For more information, refer to [www.schneider-electric.us](http://www.schneider-electric.us) [Vijeo Designer HMI Software](#) and catalog [DIA5ED2130614EN](#).

#### Vijeo™ Design'Air HMI Application

Vijeo Design'Air is an HMI application for Android and iOS tablets and smartphones. This feature enables you to remotely connect to a Magelis HMI terminal over a WiFi network and have a graphical view of the HMI terminal on your tablet and smartphone.

During the design phase, you have the ability to set the HMI terminal to be detectable by Vijeo Design'Air. You can secure access to the HMI by requiring user authentication during login. You can also configure the HMI's accessibility level to view only or full control. In this configuration, the HMI terminal acts as the server, while the tablet or smartphone acts as the client. The server and client communicate over a WiFi wireless, 3G, 4G, or LTE network.

After a connection is established, you can use some of the functionalities of tablets and smartphones to remotely interact with the HMI terminal. For example, you can perform touch or swipe actions to start or stop a process or to navigate between screens. You can also use pinch action to zoom in and out of a screen for better viewing. Download Vijeo Design'Air from Google Play® or the App Store® in iTunes®. For more information,



[1] 62=current version number.

refer to [www.schneider-electric.us](http://www.schneider-electric.us) [Vijeo Designer HMI Software](#) and catalog [DIA5ED2130614EN](#).

### Vijeo™ Design'Air Plus



Vijeo Design'Air Plus is a feature in Vijeo Designer and application for Android and iOS tablets and smartphones. Vijeo Design'Air Plus enables you to create a tablet/smartphone project specifically for the tablet or smartphone display size. At runtime, an operator can access the user application to display data and control automation processes on the tablet or smartphone.

You can use Vijeo Designer's drawing tools to create and edit a visual representation of the automation process. You can draw shapes and parts (such as rectangles, arcs, and pies), Toolchest parts (such as numeric displays, switches, and bar graphs), use the gradient feature to enhance the color of the drawn objects, and set up an Alarm Panel for remote alarm monitoring.

Vijeo Design'Air Plus provides operators with the capability to select a user application, and on successful login, download and launch the tablet/smartphone application. The operator can view and monitor an automation process, and for example, change values in numeric displays and string displays. In the Alarm Panel, the operator can monitor and acknowledge alarms.

Download Vijeo Design'Air Plus from Google Play® or the App Store® in iTunes®.

For more information, refer to [www.schneider-electric.us](http://www.schneider-electric.us) [Vijeo Designer HMI Software](#) and catalog [DIA5ED2130614EN](#).

### Vijeo Citect SCADA Software



**SCADA Expert Vijeo Citect**, is the operating and monitoring component of PlantStruxure™, the new Process Automation system of Schneider Electric. With powerful visualization capabilities and operational features, it delivers actionable insight faster, enabling operators to respond quickly to process disturbances and thereby increase their effectiveness. SCADA Expert Vijeo Citect is now part of StruxureWare, the brand name identifying Schneider Electric's various software applications and suites to drive business performance while conserving enterprise resources. SCADA Expert Vijeo Citect can be tailored to a wide array of industry rigors and demands, and continuously seeks to meet the increasing requirements of emerging industry sectors. Many of the world's leading organizations successfully utilize SCADA Expert Vijeo Citect, as it meets their specific industry needs.

### Vijeo™ Historian



**Plant Operation Vijeo Historian**, is the information management component of PlantStruxure™ architecture. It comprises the historian and portal functionalities of the solution, enabling you to accurately store data while connecting your production and business systems through its active data transfers and simple, easy-to-use reporting. Plant Operation Vijeo Historian is now part of StruxureWare. StruxureWare is the brand name identifying Schneider Electric's various software applications and suites to drive business performance while conserving enterprise resources.

### Modicon™ OTB Distributed I/O System



The open and modular new Modicon OTB distributed I/O system offers an ideal solution for IP20 distributed input/output requirements. Users can create I/O islands managed by a master controller, via a fieldbus or communication network. It includes three communication bases for the various types of fieldbus: CANopen™, Ethernet TCP/IP, or Modbus™ RS 485 serial. Discrete or analog I/O is available.

More information is available in catalog [DIA3ED2040801EN-US](#).

### Modicon™ STB Distributed I/O Platform

The Modicon STB is a highly modular distributed I/O platform, integrated wiring solution, and power management system that delivers effective and targeted control. With an open network adaptable to most major field buses, a flexible “island” I/O structure, and simple configuration via the STBSUP1000 software, Modicon STB is the right choice. The Modicon STB distributed I/O can also be configured directly from Unity™ Pro application software. More information is available at [www.schneider-electric.com](http://www.schneider-electric.com).



### Modicon™ Telefast™ ABE7 Sub-bases, IP20

The Modicon Telefast ABE7 pre-wired system enables connection and adaptation of control signals of industrial PLC cards that are fitted with HE10 connectors. It rationalizes cabling by replacing PLC terminals and traditional terminal blocks—thus improving simplicity and economy. For more information, refer to [Advantysys Telefast ABE7](#) on [Schneider-Electric.us](http://Schneider-Electric.us) and catalog [DIA3ED2160602EN](#).

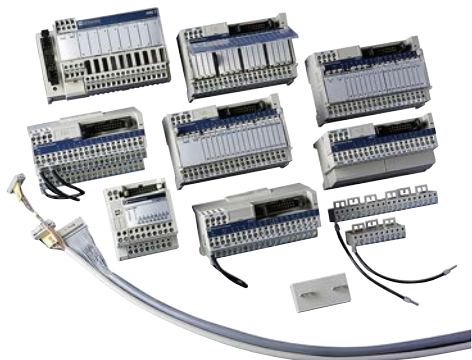

### Modicon™ Telefast™ ABE9 Passive Splitter Boxes, IP67

Modicon Telefast ABE9 splitter boxes eliminate long and difficult cable runs by avoiding the use of intermediate junction boxes. Due to their modularity and size, they are perfect for the requirements of your varying applications. For more information, refer to [Modicon ABE9](#) on [Schneider-Electric.us](http://Schneider-Electric.us) and catalog [DIA3ED2160602EN](#).



### Modicon™ TM7 I/O Blocks, IP67

Compact and flexible, the TM7 IP67 I/O Blocks allow connection of sensors and actuators at the heart of processes or machines in severe environments. The wide range of modules provides solutions to match your exact needs. It includes connectivity to CANopen. For more information, refer to [Modicon TM7 Remote I/O for Harsh Environments](#) on [Schneider-Electric.us](http://Schneider-Electric.us) and catalog [DIA3ED2140405EN](#)





### Modicon™ Momentum™ Distributed I/O and PLC

The small footprint and open architecture of the Momentum PLC product line make it extremely versatile for a variety of automation applications. The Momentum PLC is ideal for PC-based control, distributed control, distributed I/O, and traditional, standalone PLC control. Momentum PLC options and accessories include: I/O bases, processor adapters, option adapters and communication adapters that are interchangeable and snap together to deliver optimal flexibility throughout the control system lifecycle. Using Ethernet as its communications backbone, the Modicon Momentum M1E Processor delivers all the performance benefits of real-time control. The open architecture of the M1E processor makes it a universal controller for distributed I/O, compatible with many of the major fieldbus and control network environments. An integral Ethernet port in the M1E allows users to perform a wide range of functions over Ethernet, including data acquisition, peer-to-peer communications, and I/O scanning. Five embedded web pages enable the use of a standard web browser to read status and diagnostic information from the processor. The most recent addition to the Momentum product offer is the Momentum M1E ConneXium switch. This model combines the power and functionality of the M1E processor with the communication versatility of four Modbus Ethernet TCP/IP ports. The award winning M1E not only seamlessly connects I/O and other control devices via open standards; it delivers the performance of a full function, real-time controller for stand-alone and distributed system configurations in one money-saving unit. For more information, refer to [www.schneider-electric.us](http://www.schneider-electric.us) [Modicon Momentum](#) and catalog [MKTED205061EN-US](#)



**Ethernet TCP/IP Products**

The recognition of Ethernet TCP/IP, both in organizations and on the internet, has made it the communication standard of today. Its wide use is leading to a reduction in connection costs, increased performance and the addition of new functions, which all combine to ensure its durability.

Ethernet TCP/IP meets the connection requirements of every application:

- Twisted pair copper cables for simplicity and low cost
- Optical fiber for immunity to interference and for long distances
- Communication redundancy, inherent in the IP (internet protocol)
- Remote point-to-point access via the telephone network or the Internet for the cost of a local call

Ethernet TCP/IP, a truly open technology, supports all types of communication:

- Web pages
- File transfer
- Industrial messaging

With its high speed, the network no longer limits the performance of the application. The architecture can evolve without any difficulty. The products or devices remain compatible, ensuring the long-term durability of the system.

More information on Ethernet and Ethernet Products is available in catalog [MKTED208054EN-US](#).

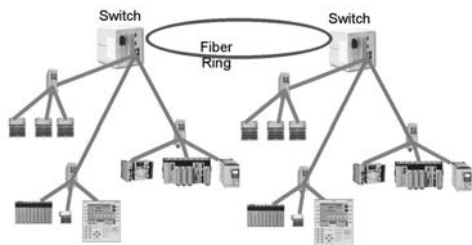

**ConneXium™ Ethernet Products**

The ConneXium line of networking products offers a complete range of Ethernet switches (managed and unmanaged), hubs, transceivers, gateways, cabling, and diagnostic monitoring software for demanding industrial environments. With fiber and redundant capabilities, along with advanced filtering and security features, ConneXium products improve the performance and security of the network. More details can be found at [www.schneider-electric.com](http://www.schneider-electric.com).

### Transparent Ready™ Solutions

Transparent Ready products cover solutions in Industrial automation to electrical Distribution, and are based on universal Ethernet TCP/IP and Web technologies. They provide seamless communication between plant floor devices, like PLCs, drives, and MCCs, with corporate business systems. Use of the open Modbus TCP/IP and EtherNet/IP protocols that are the leading industrial Ethernet protocols, broadens the scope of dedicated machine diagnostics to remote management. Choosing Transparent Ready means opting for flexible, open automation architectures. More details can be found at [www.schneider-electric.com](http://www.schneider-electric.com).

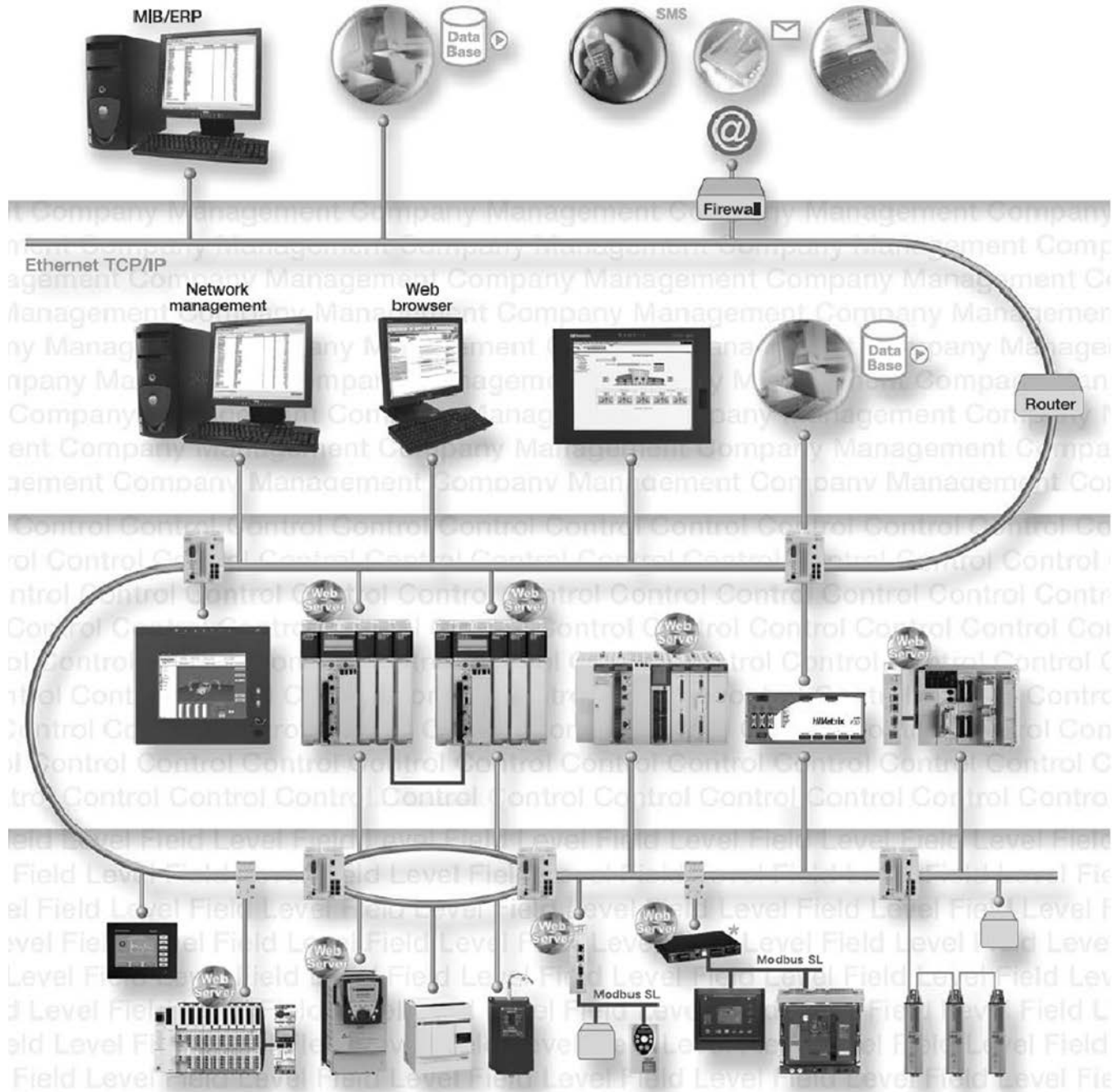

### **CANopen Network Products**

CANopen is an open network that is supported by over 400 companies world wide and promoted by CAN in Automation. CANopen is standardized in the EN50325-4 and in ISO15745-2 for its device description.

The main reason for using a network is the performance and the flexibility to adapt the network exactly to the requirements of the application. CANopen provides a unique feature for the adaptation of the data transmission. Based on the producer/consumer model, CANopen allows for a data transmission broadcast, peer-to-peer, change-of-state and cyclic communication. This means it transmits data only when required or on a specified time base. Process data objects can be individually configured. Parameters can be changed at runtime.

CANopen combines ease of installation with inexpensive devices. CANopen provides an integrated equipotential bonding in the cable. Therefore, an additional cable or stranded copper ribbon to achieve the same potential on all network devices is not necessary. Installation costs are heavily reduced.

More information on CANopen and CANopen Products is available in catalog [MKTED208054EN-US](#).

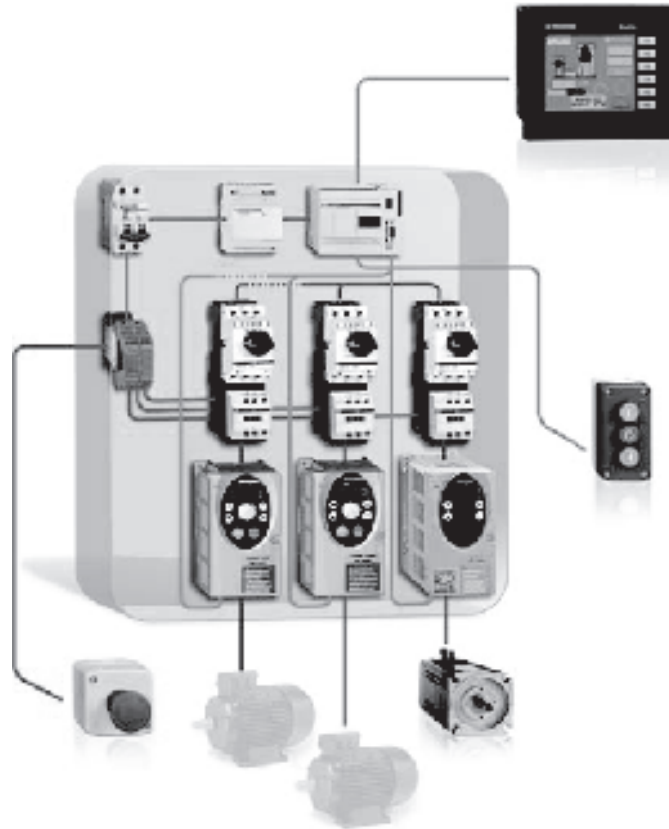

## Lexium™ Motion Control Products

### Lexium ILx Series

The Lexium ILx is an integrated, or combination, drive and motor series. This series comes in 3 different motor versions (DC brushless, stepper, and servo). Safe Torque Off (STO), highly customizable cable entry and communication options combined with detailed user guides, function blocks, and sample code, make this product ideal for use with both our Modicon and 3<sup>rd</sup> party controllers.

**Table 27.1: Lexium ILx Characteristics**

<b>Input Voltage</b>	12–48 Vdc
<b>Motor Size</b>	150–305 W
<b>Control Options</b>	CANopen, Modbus TCP/IP, Ethernet/IP, EtherCAT, Ethernet Powerlink, Modbus RS485, DeviceNet, Profibus DP, Pulse & Direction, & Motion Table

#### Links to Websites and Downloads:

- [Website](#)
- [Lexium CT Commissioning \(Free\) Software](#)
- [Online Configurator](#)
- [ILx eCatalog](#)



Lexium ILA  
Combination Stepper Motor



Lexium ILS  
Combination Stepper Motor



Lexium ILE  
Combination DC Brushless Motor



Lexium 28  
Servo Drive



BCH2 Servo Motor

### Lexium 28 Series

Optimized for easy integration and commissioning through Pulse & Direction, Analog, CanOpen, or CanMotion technology. Thanks to its compact form factor, and Safe Torque Off (STO) capability; the Lexium 28 range of AC-servo drives and motors from Schneider Electric delivers industry-leading performance and value.

**Table 27.2: Lexium 28 Characteristics**

<b>Input Voltage</b>	200/240 Vac
<b>Motor Size</b>	50 W–4, 5 kW
<b>Control Options</b>	CANopen, CANmotion, EtherCat, Pulse & Direction, Analog, & Motion Table

#### Links to Websites and Downloads:

- [Website](#)
- [SoMove Commissioning \(Free\) Software](#)
- [Online Configurator](#)
- [Motion Sizer \(Free\) Software](#)
- [Lexium 28 eCatalog](#)

### Lexium 32 Series

The Lexium 32 servo drive offer is designed to simplify the life cycle of machines. SoMove setup software, a backup memory card, side-by-side mounting, and easily accessible color-coded plug-in connectors all help to make installation, setup, and maintenance easier. The compact size of the servo drives and servo motors provides maximum power in the minimum space, which helps to reduce overall machine size and costs. The ability to use 3<sup>rd</sup> party motors, multiple communication cards, as well as standard encoders, enable adaptation to numerous types of control system architecture for industry. An integrated safety function and access to additional safety functions reduce design times and make it easier to comply with safety standards.

**Table 27.3: Lexium 32 Characteristics**

<b>Input Voltage</b>	Single phase: 115–240 Vdc 3-phase: 208–480 Vac
<b>Motor Size</b>	150 W–7 kW (up to 11 kW with 3 <sup>rd</sup> party motors)
<b>Control Options</b>	CANopen, CANmotion, Modbus TCP, Modbus Serial, EtherCat, Sercos III, Profibus DP, DeviceNet, EtherNet/IP, Pulse & Direction, Analog, & Motion Table

#### Links to Websites and Downloads:

- [Website](#)
- [SoMove Commissioning \(Free\) Software](#)
- [Online Configurator](#)
- [Motion Sizer \(Free\) Software](#)
- [Lexium 32 eCatalog](#)



Lexium 32  
Servo Drive



BMH Servo Motor



BSH Servo Motor





Lexium 32i Integrated Servo

**Lexium 32i Series**

With servo motor and drive integrated in one housing, the Lexium 32i is designed for application areas requiring high precision and advanced motor control. Unlike traditional servo drives that are installed in a cabinet, the Lexium 32i servo drive is installed directly on the machine to help you improve cost, energy, and can reduce cabinet space by up to 60%. Thanks to standard safety functions (STO), communication options, backup memory card, and its modular design the Lexium 32i sets itself apart in the market place to meet the needs of today's machine builders.

**Table 27.4: Lexium 32i Characteristics**

<b>Input Voltage</b>	Single phase: 115–240 Vdc 3-phase: 208–480 Vac
<b>Motor Size</b>	400 W–2.1 kW
<b>Control Options</b>	CANopen, CANmotion, EtherCAT, ProfiNet

**Links to Websites and Downloads:**

- [Website](#)
- [SoMove Commissioning \(Free\) Software](#)
- [Online Configurator](#)
- [Motion Sizer \(Free\) Software](#)
- [Lexium 32i eCatalog](#)

**PacDrive 3**

PacDrive 3 is based upon proven logic motion technology, which unifies PLC, motion, and robotics control functionality on a single hardware platform. With its centralized system architecture, PacDrive 3 is the ideal solution for controlling a broad range of servo-driven production and packaging machines, as well as material handling equipment and robotics, using fully integrated, IEC 61131-3-compliant program structures. More than 80.000 machines worldwide are controlled by PacDrive to this day.

**Links to Websites and Downloads:**

- [Website](#)
- [Motion Sizer \(Free\) Software](#)
- [PacDrive 3 General eCatalog](#)
- [Lexium 62 ILM Integrated Drive eCatalog](#)
- [Lexium 62 Multi-Axis Drive eCatalog](#)
- [PacDrive 3 TM5/TM7 safety PLC & I/O eCatalog](#)
- [PacDrive 3 LMC Motion Controller eCatalog](#)
- [PacDrive 3 Delta Robot eCatalog](#)
- [Lexium SH3/MH3/SHS Servo Motors eCatalog](#)
- [Lexium 52 Stand-Alone Servo Drive eCatalog](#)
- [SoMachine Motion Programming Software Website](#)



PacDrive Family



Lexium P4 DELTA Robot

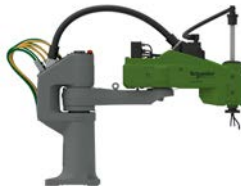

Lexium STS SCARA Robot

## HVAC/R Controllers

### Schneider Electric Modicon M171 Programmable Solution

Modicon M171 logic controller: best-in-class for scalability and energy efficiency, dedicated for HVAC/R and pumping applications. Designed to meet customer's needs by reducing time-to-market, reducing costs, improving machine efficiency, and simplifying integration. Reduce overall time-to-market with our application experts, pre-developed proven architectures, and existing applications (libraries, application function blocks, and baseline examples). Reduce costs through our optimized platforms, embedded webserver, and scalable platforms. Improve overall machine efficiency with integration of variable speed drives, Coefficient of Performance monitoring, and remote interface capabilities. Simplify equipment integration and maintenance through a wide choice of connectivity options scalable to small and large applications, along with an embedded webserver interface.

The M171 programmable platform consists of the **SoMachine™ HVAC** software suite, **M171O**, and **M171P**, a complete range from simple and compact through complex and BMS connected applications.

Key accessories include the plug-in communication modules to facilitate integration with Building Management Systems in residential, commercial, and industrial end-user applications, along with I/O expansion modules, and a variety of remote user interface devices.

#### SoMachine HVAC

**Modicon M171** integrated software development suite allows for intuitive management of every step in the process: developing the application, programming and servicing controllers, configuring communication networks, design of user interface and web pages, and full de-bug and simulation capabilities. Software languages are compliant with IEC 61131-3 programming standards, including Structured Text, Function Block Diagram, Ladder, Instruction List, and Sequential Flow Chart.

#### M171O

The **Modicon M171** optimized logic controller for simple and compact machines is the smallest programmable controller on the market, offering tremendous versatility. Packaging comes standard in either a 4-DIN or 32x74 mm panel mount option, with or without the user interface. Power input can be specified with either 12–24 V or 100–240 Vac, depending on the model. The controller features up to twenty-two I/O, including three analog outputs and five analog inputs. One I/O expansion module and two remote user interface devices can be added to expand capabilities.

#### M171P

The **Modicon M171** performance logic controller for complex and BMS connectable machines provides more processing power, I/Os, connectivity, and an embedded webserver. Packaging comes standard 8 DIN rail-mounted configuration with or without the display and in an alternative Panel mount version, ideally for distributed control systems or as a centralized gateway device. Designed with integrated RS-485 and CAN ports, a connectivity module can be added to expand capabilities with Modbus RTU and TCP, BACnet MSTP and IP, HTTP, CAN, and Modbus ASCII. Power input can be specified to operate with 24 Vac/Vdc or 48 Vdc. The controller features up to twenty-seven I/O, including five analog outputs and six analog inputs. Up to twelve I/O expansion modules and two remote user interface terminals can be added to meet almost any application need.



# Section 28

## Universal Enclosures

### Product Summary 28-2

Spacial™ Steel Enclosures	28-2
Thalassa™ Polyester Enclosures	28-2
ClimaSys™ Thermal Management System	28-3
Our Software Suite	28-3
NEMA and UL Enclosure Ratings	28-3
UL Listing	28-3

### Product Selection 28-4

Spacial™ Steel Enclosures	28-4
Steel Floor-Standing Enclosures	28-4
Stainless Steel Floor-Standing Enclosures	28-6
Steel Wall-Mounting Enclosures	28-7
Thalassa™ Polyester Enclosures	28-8
Polyester Floor-Standing Enclosures	28-8
Polyester Wall-Mounting Enclosures	28-8
ClimaSys™ Thermal Management System	28-9
Ventilation Systems with Filters	28-9
Thermal Control	28-10



Spacial Steel Enclosures



Thalassa Polyester Enclosures



Ventilation Systems with Filters

## Spacial™ Steel Enclosures

### Metal enclosures and boxes



From our small boxes to large modular floor-standing enclosures, with the Spacial range you can find the optimal fit for your applications. Our extensive range of easy-to-use accessories helps you save time during your projects.

Select between steel or stainless steel to better suit the installation environment. In our stainless-steel offer you can find the optimal solution where cleanliness or protection in highly corrosive environments are required.

#### Steel: Indoor non-clean industrial environment

The environment in industrial plants can subject electric and electronic components to dust, splashing oil, and impacts. Such environments require a range of enclosures that are suited to harsh conditions yet are easy to install.

- **Universal range**, for industry.
- **EMC (electromagnetic compatibility) range**, against electromagnetic disturbances (treated with Aluzinc).

#### 304L - 316L stainless steel: Demanding industrial environment

Food and beverage, pharmaceutical, petrochemical, and infrastructure industries have particularly demanding hygiene and corrosion resistance requirements. Our Spacial range is available in two grades of stainless steel:

- **304L stainless steel**, for resistance to corrosion and ease of cleaning (often used in food production environments).
- **316L stainless steel, also known as "marine stainless steel,"** for very high resistance to corrosion (used in saline or chlorinated environments).
- **Range of ATEX enclosures**, for potentially explosive atmospheres.

#### Product family names:

Spacial S3DC: *Steel wall-mounting enclosures*

Spacial SM: *Compact metal enclosures*

Spacial SF: *Modular metal enclosures*

Spacial S3X: *Stainless-steel wall-mounting enclosures*

Spacial SMX: *Stainless-steel monobloc floor-standing enclosures*

Spacial SFX: *Stainless-steel modular enclosures*

## Thalassa™ Polyester Enclosures

### Insulated enclosures and boxes

Without the right protection, harsh environments can expose your installation to chemicals or other substances.

Developed to help protect your equipment in outdoor applications or harsh conditions, our Thalassa offer ranges from boxes to floor-standing enclosures made from fiberglass reinforced polyester.

Our Thalassa industrial boxes in ABS or polycarbonate are strong, easy to install, and designed to be used in highly demanding environments.

#### Insulating polyester and plastic materials (ABS, polycarbonate): Outdoor infrastructures and severe industrial environments

Outdoor infrastructures and electrical installations are exposed to direct sunlight, rain, saline mist, extreme temperatures, oil splashes, chemical and corrosive agents, and are in contact with the public.

- **Universal range**, for industry.
- **Range of ATEX enclosures**, for potentially explosive atmospheres.

#### Product family names:

Thalassa PLM: *Polyester wall-mounting enclosures*

Thalassa PLA: *Polyester floor-standing enclosures*



**ClimaSys™ Thermal Management System**  
**Thermal Management**

Preserving and keeping the right temperature inside your enclosure is vital for maximizing the average service life of your installed devices. With our ClimaSys offer you can find the right solution, be it ventilation, cooling or heating, including control units for temperature, humidity and much more.

**Product family names:**

- ClimaSys CV: *Ventilation systems*
- ClimaSys CR: *Insulated resistance heaters*
- ClimaSys CC: *Thermal control*



**Our Software Suite**

**Spacial.pro**

Spacial.pro allows you to make switchboard proposals based on the standard Spacial™ offer. A full project with several sets of switchboards is quoted in minutes, with automatic creation of the bill of material and 2D drawings for front and side views.

**ProClima**

Calculate the right choice for your thermal management requirements, according to the environment and the electrical/electronic devices installed inside the enclosure.

**Spacial.ref and Thalassa.ref**

These digital rules assist you in selecting the appropriate components for your application from our extensive product range. The tool automates product and accessory selection to help save you time and money.

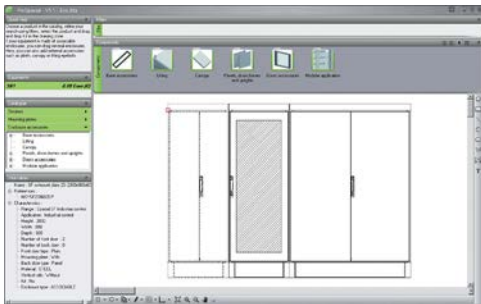

**NEMA and UL Enclosure Ratings**

**Table 28.1: NEMA and UL Enclosure and Component Ratings**

Enclosures		Type of protection [1]												
		1	2	3	3R	3S	4	4X	5	6	6P	12	12K	13
Steel wall-mounting enclosures	S3DC	•	•	• [2]	• [2]		• [2]	• [2]				• [3]	• [3]	• [3]
	CRN	•	• [2]	• [2]	• [2]		• [2]		• [2]			•		•
Stainless-steel wall-mounting enclosures	S3X	•	• [2]	• [2]	• [2]		• [2]	• [2]	• [2]			•	• [3]	• [2]
Steel floor-standing enclosures	SM	•	• [2]	• [2]	• [2]		• [2]		• [2]			•	•	• [2]
Steel modular enclosures	SF	•										•	•	
Stainless-steel floor-standing enclosures	SMX	•	• [2]	• [2]	• [2]		• [2]	• [2]	• [2]			•	•	• [2]
Stainless-steel modular enclosures	SFX	•										•	•	
Thermoplastic boxes	TBS - TBP	•		•		•	•	•						
Polyester modular boxes	PLS	•	•	•	•	•	•	•				•		•
Polyester wall-mounting enclosures	PLM	•	•	•	•	•	•	•				•		•
Polyester floor-standing enclosures	PLA	•	•	• [2]	• [2]		• [2]	• [2]	• [2]			•		•

Components		Type of protection [1]												
		1	2	3	3R	3S	4	4X	5	6	6P	12	12K	13
Ventilation system	CV											•	•	
Thermal regulation system	CC											•	•	

**UL Listing**



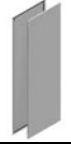

**Table 28.2: UL File Numbers for Enclosures**

Standard Enclosure Type	UL File Number
NSYSM	E103582
NSYSF	E80264
NSYSMX	E103582
NSYSFX	UL Certification pending
NSYSCRN	E103582
NSYSCRNG	E80264
NSYS3DC	E80264
NSYS3X	E103582
NSYSPLA	E103582
NSYSPLM	E103582

[1] In some ranges the classification depends on the model and version. The detailed protection types are indicated in the UL certifications.  
 [2] 1 door  
 [3] 2 doors

Steel Floor-Standing Enclosures

Table 28.3: Spacial Steel Floor-Standing Enclosures

Height: mm (in)	Width: mm (in)	Depth: mm (in)	# Doors	NSYSM Welded [1]			NSYSF Modular [1]			Accessories, Floor-Standing Enclosures			
				Without mounting plate			Without mounting plate		2 Side panels	Mounting plate	Cable-gland plate, 1 entry	Plinth height 100 mm (3.9 in)	
												Front/back	Sides
1200 (47.2)	600 (23.6)	400 (15.7)	1	—	—	—	—	—	—	—	—	—	—
1200 (47.2)	600 (23.6)	600 (23.6)	1	—	—	—	—	—	—	—	—	—	—
1200 (47.2)	800 (31.5)	300 (11.8)	1	NSYSM12830	—	—	—	—	—	—	—	—	—
1200 (47.2)	800 (31.5)	400 (15.7)	1	—	—	—	—	—	—	—	—	—	—
1200 (47.2)	800 (31.5)	600 (23.6)	1	—	—	—	—	—	—	—	—	—	—
1200 (47.2)	1000 (39.4)	300 (11.8)	2	NSYSM1210302D	—	—	—	—	—	—	—	—	—
1200 (47.2)	1200 (47.2)	400 (15.7)	2	NSYSM1212402D	—	—	—	—	—	—	—	—	—
1400 (55.1)	600 (23.6)	300 (11.8)	1	NSYSM14630	—	—	—	—	—	—	—	—	—
1400 (55.1)	600 (23.6)	400 (15.7)	1	NSYSM14640	—	—	—	—	—	—	—	—	—
1400 (55.1)	800 (31.5)	300 (11.8)	1	NSYSM14830	—	—	—	—	—	—	—	—	—
1400 (55.1)	800 (31.5)	400 (15.7)	1	NSYSM14840	—	—	—	—	—	—	—	—	—
1400 (55.1)	1000 (39.4)	400 (15.7)	2	NSYSM1410402D	—	—	—	—	—	—	—	—	—
1400 (55.1)	1200 (47.2)	400 (15.7)	2	NSYSM1412402D	—	—	—	—	—	—	—	—	—
1600 (63.0)	600 (23.6)	300 (11.8)	1	NSYSM16630	—	—	—	—	—	—	—	—	—
1600 (63.0)	600 (23.6)	400 (15.7)	1	NSYSM16640	—	—	—	—	—	—	—	—	—
1600 (63.0)	600 (23.6)	600 (23.6)	1	—	—	—	—	—	—	—	—	—	—
1600 (63.0)	600 (23.6)	800 (31.5)	1	—	—	—	—	—	—	—	—	—	—
1600 (63.0)	800 (31.5)	300 (11.8)	1	NSYSM16830	—	—	—	—	—	—	—	—	—
1600 (63.0)	800 (31.5)	400 (15.7)	1	NSYSM16840	—	—	—	—	—	—	—	—	—
1600 (63.0)	800 (31.5)	600 (23.6)	1	—	—	—	—	—	—	—	—	—	—
1600 (63.0)	800 (31.5)	800 (31.5)	1	—	—	—	—	—	—	—	—	—	—
1600 (63.0)	1000 (39.4)	300 (11.8)	2	NSYSM1610302D	—	—	—	—	—	—	—	—	—
1600 (63.0)	1000 (39.4)	400 (15.7)	2	NSYSM1610402D	—	—	—	—	—	—	—	—	—
1600 (63.0)	1200 (47.2)	300 (11.8)	2	NSYSM1612302D	—	—	—	—	—	—	—	—	—
1600 (63.0)	1200 (47.2)	400 (15.7)	2	NSYSM1612402D	—	—	—	—	—	—	—	—	—
1800 (70.9)	400 (15.7)	400 (15.7)	1	—	—	—	—	—	—	—	—	—	—
1800 (70.9)	400 (15.7)	500 (19.7)	1	—	—	—	—	—	—	—	—	—	—
1800 (70.9)	400 (15.7)	600 (23.6)	1	—	—	—	—	—	—	—	—	—	—
1800 (70.9)	600 (23.6)	300 (11.8)	1	NSYSM18630	—	—	—	—	—	—	—	—	—
1800 (70.9)	600 (23.6)	400 (15.7)	1	NSYSM18640	—	—	—	—	—	—	—	—	—
1800 (70.9)	600 (23.6)	500 (19.7)	1	NSYSM18650	—	—	—	—	—	—	—	—	—
1800 (70.9)	600 (23.6)	600 (23.6)	1	—	—	—	—	—	—	—	—	—	—
1800 (70.9)	600 (23.6)	800 (31.5)	1	—	—	—	—	—	—	—	—	—	—
1800 (70.9)	800 (31.5)	300 (11.8)	1	NSYSM18830	—	—	—	—	—	—	—	—	—
1800 (70.9)	800 (31.5)	400 (15.7)	1	NSYSM18840	—	—	—	—	—	—	—	—	—
1800 (70.9)	800 (31.5)	500 (19.7)	1	NSYSM18850	—	—	—	—	—	—	—	—	—
1800 (70.9)	800 (31.5)	600 (23.6)	1	NSYSM18860	—	—	—	—	—	—	—	—	—
1800 (70.9)	800 (31.5)	600 (23.6)	2	—	—	—	—	—	—	—	—	—	—
1800 (70.9)	1000 (39.4)	400 (15.7)	1	NSYSM181040	—	—	—	—	—	—	—	—	—
1800 (70.9)	1000 (39.4)	400 (15.7)	2	NSYSM1810402D	—	—	—	—	—	—	—	—	—
1800 (70.9)	1000 (39.4)	500 (19.7)	1	—	—	—	—	—	—	—	—	—	—
1800 (70.9)	1000 (39.4)	500 (19.7)	2	NSYSM1810502D	—	—	—	—	—	—	—	—	—
1800 (70.9)	1000 (39.4)	600 (23.6)	1	—	—	—	—	—	—	—	—	—	—
1800 (70.9)	1000 (39.4)	600 (23.6)	2	—	—	—	—	—	—	—	—	—	—
1800 (70.9)	1200 (47.2)	400 (15.7)	2	NSYSM1812402D	—	—	—	—	—	—	—	—	—
1800 (70.9)	1200 (47.2)	500 (19.7)	2	NSYSM1812502D	—	—	—	—	—	—	—	—	—
1800 (70.9)	1200 (47.2)	600 (23.6)	2	—	—	—	—	—	—	—	—	—	—
1800 (70.9)	1600 (63.0)	400 (15.7)	2	NSYSM1816402D	—	—	—	—	—	—	—	—	—
1800 (70.9)	1600 (63.0)	500 (19.7)	2	NSYSM1816502D	—	—	—	—	—	—	—	—	—
2000 (78.7)	300 (11.8)	500 (19.7)	1	—	—	—	—	—	—	—	—	—	—
2000 (78.7)	300 (11.8)	600 (23.6)	1	—	—	—	—	—	—	—	—	—	—
2000 (78.7)	400 (15.7)	400 (15.7)	1	—	—	—	—	—	—	—	—	—	—
2000 (78.7)	400 (15.7)	500 (19.7)	1	—	—	—	—	—	—	—	—	—	—
2000 (78.7)	400 (15.7)	600 (23.6)	1	—	—	—	—	—	—	—	—	—	—
2000 (78.7)	400 (15.7)	800 (31.5)	1	—	—	—	—	—	—	—	—	—	—
2000 (78.7)	600 (23.6)	300 (11.8)	1	NSYSM20630	—	—	—	—	—	—	—	—	—
2000 (78.7)	600 (23.6)	400 (15.7)	1	NSYSM20640	—	—	—	—	—	—	—	—	—
2000 (78.7)	600 (23.6)	500 (19.7)	1	NSYSM20650	—	—	—	—	—	—	—	—	—
2000 (78.7)	600 (23.6)	600 (23.6)	1	—	—	—	—	—	—	—	—	—	—
2000 (78.7)	600 (23.6)	800 (31.5)	1	—	—	—	—	—	—	—	—	—	—
2000 (78.7)	800 (31.5)	300 (11.8)	1	NSYSM20830	—	—	—	—	—	—	—	—	—
2000 (78.7)	800 (31.5)	400 (15.7)	1	NSYSM20840	—	—	—	—	—	—	—	—	—
2000 (78.7)	800 (31.5)	500 (19.7)	1	NSYSM20850	—	—	—	—	—	—	—	—	—
2000 (78.7)	800 (31.5)	600 (23.6)	1	NSYSM20860	—	—	—	—	—	—	—	—	—

[1] See Table 28.2 UL File Numbers for Enclosures, page 28-3.

**Table 28.3 Spacial Steel Floor-Standing Enclosures (cont'd.)**

Height: mm (in)	Width: mm (in)	Depth: mm (in)	# Doors	NSYSM Welded [2]	NSYSF Modular [2]		Accessories, Floor-Standing Enclosures			
				Without mounting plate	Without mounting plate	2 Side panels	Mounting plate	Cable-gland plate, 1 entry	Plinth height 100 mm (3.9 in)	
									Front/back	Sides
2000 (78.7)	800 (31.5)	600 (23.6)	2	—	NSYSF208602D	NSY2SP206	NSYMP208	NSYEC861	NSYSPPF8100	NSYSPPS6100
2000 (78.7)	800 (31.5)	800 (31.5)	1	—	NSYSF20880	NSY2SP208	NSYMP208	NSYEC881	NSYSPPF8100	NSYSPPS8100
2000 (78.7)	1000 (39.4)	400 (15.7)	1	—	NSYSF201040	NSY2SP204	NSYMP2010	NSYEC1041	NSYSPPF10100	NSYSPPS4100
2000 (78.7)	1000 (39.4)	400 (15.7)	2	NSYSM2010402D	NSYSF2010402D	NSY2SP204	NSYMP2010	NSYEC1041	NSYSPPF10100	NSYSPPS4100
2000 (78.7)	1000 (39.4)	500 (19.7)	1	—	NSYSF201050	NSY2SP205	NSYMP2010	NSYEC1051	NSYSPPF10100	NSYSPPS5100
2000 (78.7)	1000 (39.4)	500 (19.7)	2	NSYSM2010502D	NSYSF2010502D	NSY2SP205	NSYMP2010	NSYEC1051	NSYSPPF10100	NSYSPPS5100
2000 (78.7)	1000 (39.4)	600 (23.6)	1	—	NSYSF201060	NSY2SP206	NSYMP2010	NSYEC1061	NSYSPPF10100	NSYSPPS6100
2000 (78.7)	1000 (39.4)	600 (23.6)	2	—	NSYSF2010602D	NSY2SP206	NSYMP2010	NSYEC1061	NSYSPPF10100	NSYSPPS6100
2000 (78.7)	1000 (39.4)	800 (31.5)	1	—	NSYSF201080	NSY2SP208	NSYMP2010	NSYEC1081	NSYSPPF10100	NSYSPPS8100
2000 (78.7)	1200 (47.2)	400 (15.7)	2	NSYSM2012402D	NSYSF2012402D	NSY2SP204	NSYMP2012	NSYEC1241	NSYSPPF12100	NSYSPPS4100
2000 (78.7)	1200 (47.2)	500 (19.7)	2	NSYSM2012502D	NSYSF2012502D	NSY2SP205	NSYMP2012	NSYEC1251	NSYSPPF12100	NSYSPPS5100
2000 (78.7)	1200 (47.2)	600 (23.6)	2	NSYSM2012602D	NSYSF2012602D	NSY2SP206	NSYMP2012	NSYEC1261	NSYSPPF12100	NSYSPPS6100
2000 (78.7)	1200 (47.2)	800 (31.5)	2	—	NSYSF2012802D	NSY2SP208	NSYMP2012	NSYEC1281	NSYSPPF12100	NSYSPPS8100
2000 (78.7)	1600 (63.0)	400 (15.7)	2	NSYSM2016402D	NSYSF206402D	NSY2SP204	NSYMP2016	NSYEC1641	NSYSPPF16100	NSYSPPS4100
2000 (78.7)	1600 (63.0)	500 (19.7)	2	NSYSM2016502D	NSYSF2016502D	NSY2SP205	NSYMP2016	NSYEC1651	NSYSPPF16100	NSYSPPS5100
2000 (78.7)	1600 (63.0)	600 (23.6)	2	NSYSM2016602D	NSYSF2016602D	NSY2SP206	NSYMP2016	NSYEC1661	NSYSPPF16100	NSYSPPS6100
2200 (86.6)	400 (15.7)	600 (23.6)	1	—	NSYSF22460	NSY2SP226	—	NSYEC461	NSYSPPF4100	NSYSPPS6100
2200 (86.6)	600 (23.6)	600 (23.6)	1	—	NSYSF22660	NSY2SP226	NSYMP226	NSYEC661	NSYSPPF6100	NSYSPPS6100
2200 (86.6)	600 (23.6)	800 (31.5)	1	—	NSYSF22680	NSY2SP228	NSYMP226	NSYEC681	NSYSPPF6100	NSYSPPS8100
2200 (86.6)	800 (31.5)	600 (23.6)	1	—	NSYSF22860	NSY2SP226	NSYMP228	NSYEC861	NSYSPPF8100	NSYSPPS6100
2200 (86.6)	800 (31.5)	800 (31.5)	1	—	NSYSF22880	NSY2SP228	NSYMP228	NSYEC881	NSYSPPF8100	NSYSPPS8100
2200 (86.6)	1000 (39.4)	600 (23.6)	1	—	NSYSF221060	NSY2SP226	NSYMP2210	NSYEC1061	NSYSPPF10100	NSYSPPS6100
2200 (86.6)	1200 (47.2)	600 (23.6)	2	—	NSYSF2212602D	NSY2SP226	NSYMP2212	NSYEC1261	NSYSPPF12100	NSYSPPS6100
2200 (86.6)	1200 (47.2)	800 (31.5)	2	—	NSYSF2212802D	NSY2SP228	NSYMP2212	NSYEC1281	NSYSPPF12100	NSYSPPS8100

[2] See Table 28.2 UL File Numbers for Enclosures, page 28-3.

Stainless Steel Floor-Standing Enclosures

Table 28.4: Spacial Stainless Steel Floor-Standing Enclosures



Height: mm (in)	Width: mm (in)	Depth: mm (in)	# Doors	NSYSFX Modular [3]			Accessories, Stainless Steel		
				NSYSMX [3] Without mounting plate	Without mounting plate	2 Side panels	Mounting plate	Plinth height 100 mm (3.9 in)	
									
1400 (55.1)	1000 (39.4)	300 (11.8)	2	NSYSMX141030	—	—	NSYMP1410	NSYSPXF10100H	NSYSPXS3100H
1600 (63.0)	800 (31.5)	400 (15.7)	1	NSYSMX16840	—	—	NSYMP168	NSYSPXF8100H	NSYSPXS4100H
1800 (70.9)	600 (23.6)	400 (15.7)	1	NSYSMX18640	NSYSFX18640	NSY2SPX184	NSYMP186	NSYSPXF6100H	NSYSPXS4100H
1800 (70.9)	800 (31.5)	400 (15.7)	1	NSYSMX18840	NSYSFX18840	NSY2SPX184	NSYMP188	NSYSPXF8100H	NSYSPXS4100H
1800 (70.9)	1200 (47.2)	400 (15.7)	2	NSYSMX181240	NSYSFX181240	NSY2SPX184	NSYMP1812	NSYSPXF12100H	NSYSPXS4100H
1800 (70.9)	1600 (63.0)	400 (15.7)	2	NSYSMX181640	—	—	NSYMP1813	NSYSPXF16100H	NSYSPXS4100H
2000 (78.7)	600 (23.6)	500 (19.7)	1	—	NSYSFX20650	NSY2SPX205	NSYMP206	—	—
2000 (78.7)	800 (31.5)	400 (15.7)	1	—	NSYSFX20840	NSY2SPX204	NSYMP208	—	—
2000 (78.7)	800 (31.5)	500 (19.7)	1	NSYSMX20850	—	—	NSYMP208	NSYSPXF8100H	NSYSPXS5100H
2000 (78.7)	800 (31.5)	600 (23.6)	1	—	NSYSFX20860	NSY2SPX206	NSYMP208	—	—
2000 (78.7)	1000 (39.4)	400 (15.7)	2	NSYSMX201040	—	—	NSYMP2010	NSYSPXF10100H	NSYSPXS4100H
2000 (78.7)	1000 (39.4)	600 (23.6)	2	—	NSYSFX201060	NSY2SPX206	NSYMP2010	—	—
2000 (78.7)	1200 (47.2)	500 (19.7)	2	NSYSMX201250	—	—	NSYMP2012	NSYSPXF12100H	NSYSPXS5100H
2000 (78.7)	1200 (47.2)	600 (23.6)	2	—	NSYSFX201260	NSY2SPX206	NSYMP2012	—	—
2000 (78.7)	1600 (63.0)	600 (23.6)	2	NSYSMX201660	—	—	NSYMP2016	NSYSPXF16100H	NSYSPXS6100H

[3] See Table 28.2 UL File Numbers for Enclosures, page 28-3.



**Steel Wall-Mounting Enclosures**



**Table 28.5: Spacial Steel Wall-Mounting Enclosures**

	Height: mm (in)	Width: mm (in)	Depth: mm (in)	# Doors [4]	Spacial Steel Wall-Mounting Enclosures [5]			Mounting Plate
					CRN/CRNG	S3DC	S3X Stainless steel	
	200 (7.9)	200 (7.9)	150 (5.9)	1	NSYCRN22150 [6]	—	—	NSYMM22
	200 (7.9)	300 (11.8)	150 (5.9)	1	NSYCRN23150 [6]	—	—	NSYMM32
	250 (9.8)	200 (7.9)	150 (5.9)	1	NSYCRN252150	—	—	NSYMM2520
	300 (11.8)	200 (7.9)	150 (5.9)	1	—	NSYS3DC3215	NSYS3X3215	NSYMM32
	300 (11.8)	250 (9.8)	150 (5.9)	1	NSYCRN325150	—	NSYS3X302515	NSYMM3025
	300 (11.8)	250 (9.8)	200 (7.9)	1	NSYCRN325200	—	—	NSYMM3025
	300 (11.8)	300 (11.8)	150 (5.9)	1	NSYCRN33150	NSYS3DC3315	NSYS3X3315	NSYMM33
	300 (11.8)	300 (11.8)	200 (7.9)	1	NSYCRN33200	NSYS3DC3320	—	NSYMM33
	300 (11.8)	400 (15.7)	200 (7.9)	1	NSYCRN34200	—	—	NSYMM43
	300 (11.8)	450 (17.7)	150 (5.9)	1	NSYCRN345150 [6]	—	—	NSYMM3045
	400 (15.7)	300 (11.8)	150 (5.9)	1	NSYCRN43150	NSYS3DC4315	NSYS3X4315	NSYMM43
	400 (15.7)	300 (11.8)	200 (7.9)	1	NSYCRN43200	NSYS3DC4320	NSYS3X4320	NSYMM43
	400 (15.7)	400 (15.7)	200 (7.9)	1	NSYCRN44200	NSYS3DC4420	NSYS3X4420	NSYMM44
	400 (15.7)	600 (23.6)	200 (7.9)	—	—	—	NSYS3X4620	NSYMM46
	400 (15.7)	600 (23.6)	250 (9.8)	1	NSYCRN46250	—	—	NSYMM64
	400 (15.7)	600 (23.6)	300 (11.8)	1	NSYCRN46300	—	—	NSYMM64
	500 (19.7)	400 (15.7)	150 (5.9)	1	NSYCRN54150	—	—	NSYMM54
	500 (19.7)	400 (15.7)	200 (7.9)	1	NSYCRN54200	NSYS3DC5420	NSYS3X5420	NSYMM54
	500 (19.7)	400 (15.7)	250 (9.8)	1	NSYCRN54250	NSYS3DC5425	—	NSYMM54
	500 (19.7)	500 (19.7)	200 (7.9)	1	—	NSYS3DC5520	—	NSYMM55
	500 (19.7)	500 (19.7)	250 (9.8)	1	NSYCRN55250	NSYS3DC5525	—	NSYMM55
	600 (23.6)	400 (15.7)	150 (5.9)	1	NSYCRN64150	—	—	NSYMM64
	600 (23.6)	400 (15.7)	200 (7.9)	1	NSYCRN64200	NSYS3DC6420	NSYS3X6420	NSYMM64
	600 (23.6)	400 (15.7)	250 (9.8)	1	NSYCRN64250	NSYS3DC6425	—	NSYMM64
	600 (23.6)	500 (19.7)	150 (5.9)	1	NSYCRN65150	—	—	NSYMM65
	600 (23.6)	500 (19.7)	200 (7.9)	1	NSYCRN65200	—	—	NSYMM65
	600 (23.6)	500 (19.7)	250 (9.8)	1	NSYCRN65250	—	—	NSYMM65
	600 (23.6)	600 (23.6)	200 (7.9)	1	NSYCRN66200	NSYS3DC6620	—	NSYMM66
	600 (23.6)	600 (23.6)	250 (9.8)	1	NSYCRN66250	NSYS3DC6625	NSYS3X6625	NSYMM66
	600 (23.6)	600 (23.6)	300 (11.8)	1	NSYCRN66300	NSYS3DC6630	—	NSYMM66
	600 (23.6)	800 (31.5)	300 (11.8)	1	NSYCRN68300	—	—	NSYMM86
	700 (27.6)	500 (19.7)	200 (7.9)	1	NSYCRN75200	—	—	NSYMM75
	700 (27.6)	500 (19.7)	250 (9.8)	1	NSYCRN75250	NSYS3DC7525	NSYS3X7525	NSYMM75
	800 (31.5)	600 (23.6)	200 (7.9)	1	NSYCRN86200	NSYS3DC8620	—	NSYMM86
	800 (31.5)	600 (23.6)	250 (9.8)	1	NSYCRN86250	NSYS3DC8625	NSYS3X8625	NSYMM86
	800 (31.5)	600 (23.6)	300 (11.8)	1	NSYCRN86300	NSYS3DC8630	—	NSYMM86
	800 (31.5)	600 (23.6)	400 (15.7)	1	NSYCRNG86400	NSYS3DC8640	—	NSYMM86
	800 (31.5)	800 (31.5)	200 (7.9)	1	NSYCRN88200	—	—	NSYMM88
	800 (31.5)	800 (31.5)	250 (9.8)	1	—	NSYS3DC8825	—	NSYMM88
	800 (31.5)	800 (31.5)	300 (11.8)	1	NSYCRN88300	NSYS3DC8830	NSYS3X8830	NSYMM86
	800 (31.5)	1000 (39.4)	300 (11.8)	2	NSYCRNG810300D	—	—	NSYMM108
	800 (31.5)	1200 (47.2)	300 (11.8)	2	NSYCRNG812300D	—	—	NSYMM128
	1000 (39.4)	600 (23.6)	250 (9.8)	1	NSYCRN106250	NSYS3DC10625	—	NSYMM106
	1000 (39.4)	600 (23.6)	300 (11.8)	1	NSYCRN106300	—	—	NSYMM106
	1000 (39.4)	600 (23.6)	400 (15.7)	1	NSYCRNG106400	—	—	NSYMM106
	1000 (39.4)	800 (31.5)	250 (9.8)	1	NSYCRN108250	NSYS3DC10825	—	NSYMM108
	1000 (39.4)	800 (31.5)	300 (11.8)	1	NSYCRN108300	NSYS3DC10830	NSYS3X10830	NSYMM108
	1000 (39.4)	800 (31.5)	400 (15.7)	1	NSYCRNG108400	NSYS3DC10840	—	NSYMM108
	1000 (39.4)	1000 (39.4)	300 (11.8)	2	NSYCRNG1010300D	NSYS3DC101030	NSYS3X101030	NSYMM1010
	1000 (39.4)	1200 (47.2)	300 (11.8)	2	NSYCRNG1012300D	—	—	NSYMM1210
	1000 (39.4)	1200 (47.2)	400 (15.7)	2	NSYCRNG1012400D	—	—	NSYMM1210
	1200 (47.2)	600 (23.6)	300 (11.8)	1	NSYCRNG126300	—	—	NSYMM126
	1200 (47.2)	600 (23.6)	400 (15.7)	1	NSYCRNG126400	—	—	NSYMM126
	1200 (47.2)	800 (31.5)	300 (11.8)	1	NSYCRNG128300	NSYS3DC12830	NSYS3X12830	NSYMM128
	1200 (47.2)	800 (31.5)	400 (15.7)	1	NSYCRNG128400	NSYS3DC12840	—	NSYMM128
	1200 (47.2)	1000 (39.4)	300 (11.8)	2	NSYCRNG1210300D	NSYS3DC121030	NSYS3X121030	NSYMM1210
	1200 (47.2)	1000 (39.4)	400 (15.7)	2	NSYCRNG1210400D	—	—	NSYMM1210
	1200 (47.2)	1200 (47.2)	300 (11.8)	2	NSYCRNG1212300D	—	—	NSYMM1212
	1200 (47.2)	1200 (47.2)	400 (15.7)	2	NSYCRNG1212400D	—	—	NSYMM1212
	1400 (55.1)	1000 (39.4)	300 (11.8)	2	NSYCRNG1410300D	—	—	NSYMM1410

[4] IP66 with one door, IP55 with two doors  
 [5] See Table 28.2 UL File Numbers for Enclosures, page 28-3.  
 [6] Two cable gland plates, one on top and one on bottom.

Polyester Floor-Standing Enclosures

Table 28.6: Thalassa Polyester Floor-Standing Enclosures

	Height: mm (in)	Width: mm (in)	Depth: mm (in)	# Doors	Sealed Enclosure, IP65 [7]		Enclosures with Open Bottom, IP54 [7]
					Plain door	Transparent door	Plain door
	500 (19.7)	500 (19.7)	320 (12.6)	1	NSYPLA553	NSYPLA553T	NSYPLAZ553
	500 (19.7)	500 (19.7)	420 (16.5)	1	NSYPLA554	NSYPLA554T	NSYPLAZ554
	500 (19.7)	750 (29.5)	320 (12.6)	1	NSYPLA573	NSYPLA573T	NSYPLAZ573
	500 (19.7)	750 (29.5)	420 (16.5)	1	NSYPLA574	NSYPLA574T	NSYPLAZ574
	500 (19.7)	1000 (39.4)	320 (12.6)	2	NSYPLA5103	NSYPLA5103T	NSYPLAZ5103
	500 (19.7)	1000 (39.4)	420 (16.5)	2	NSYPLA5104	NSYPLA5104T	NSYPLAZ5104
	500 (19.7)	1250 (49.2)	320 (12.6)	2	NSYPLA5123	NSYPLA5123T	NSYPLAZ5123
	500 (19.7)	1250 (49.2)	420 (16.5)	2	NSYPLA5124	NSYPLA5124T	NSYPLAZ5124
	750 (29.5)	500 (19.7)	320 (12.6)	1	NSYPLA753	NSYPLA753T	NSYPLAZ753
	750 (29.5)	500 (19.7)	420 (16.5)	1	NSYPLA754	NSYPLA754T	NSYPLAZ754
	750 (29.5)	750 (29.5)	320 (12.6)	1	NSYPLA773	NSYPLA773T	NSYPLAZ773
	750 (29.5)	750 (29.5)	420 (16.5)	1	NSYPLA774	NSYPLA774T	NSYPLAZ774
	750 (29.5)	1000 (39.4)	320 (12.6)	2	NSYPLA7103	NSYPLA7103T	NSYPLAZ7103
	750 (29.5)	1000 (39.4)	420 (16.5)	2	NSYPLA7104	NSYPLA7104T	NSYPLAZ7104
	750 (29.5)	1250 (49.2)	320 (12.6)	2	NSYPLA7123	NSYPLA7123T	NSYPLAZ7123
	750 (29.5)	1250 (49.2)	420 (16.5)	2	NSYPLA7124	NSYPLA7124T	NSYPLAZ7124
	1000 (39.4)	500 (19.7)	320 (12.6)	1	NSYPLA1053	NSYPLA1053T	NSYPLAZ1053
	1000 (39.4)	500 (19.7)	420 (16.5)	1	NSYPLA1054	NSYPLA1054T	NSYPLAZ1054
	1000 (39.4)	750 (29.5)	320 (12.6)	1	NSYPLA1073	NSYPLA1073T	NSYPLAZ1073
	1000 (39.4)	750 (29.5)	420 (16.5)	1	NSYPLA1074	NSYPLA1074T	NSYPLAZ1074
	1000 (39.4)	1000 (39.4)	320 (12.6)	2	NSYPLA10103	NSYPLA10103T	NSYPLAZ10103
	1000 (39.4)	1000 (39.4)	420 (16.5)	2	NSYPLA10104	NSYPLA10104T	NSYPLAZ10104
	1000 (39.4)	1250 (49.2)	320 (12.6)	2	NSYPLA10123	NSYPLA10123T	NSYPLAZ10123
	1000 (39.4)	1250 (49.2)	420 (16.5)	2	NSYPLA10124	NSYPLA10124T	NSYPLAZ10124
	1250 (49.2)	500 (19.7)	320 (12.6)	1	NSYPLA1253	NSYPLA1253T	NSYPLAZ1253
	1250 (49.2)	500 (19.7)	420 (16.5)	1	NSYPLA1254	NSYPLA1254T	NSYPLAZ1254
	1250 (49.2)	750 (29.5)	320 (12.6)	1	NSYPLA1273	NSYPLA1273T	NSYPLAZ1273
	1250 (49.2)	750 (29.5)	420 (16.5)	1	NSYPLA1274	NSYPLA1274T	NSYPLAZ1274
	1250 (49.2)	1000 (39.4)	320 (12.6)	2	NSYPLA12103	NSYPLA12103T	NSYPLAZ12103
	1250 (49.2)	1000 (39.4)	420 (16.5)	2	NSYPLA12104	NSYPLA12104T	NSYPLAZ12104
1500 (59.1)	500 (19.7)	320 (12.6)	1	NSYPLA1553	NSYPLA1553T	NSYPLAZ1553	
1500 (59.1)	500 (19.7)	420 (16.5)	1	NSYPLA1554	NSYPLA1554T	NSYPLAZ1554	
1500 (59.1)	750 (29.5)	320 (12.6)	1	NSYPLA1573	NSYPLA1573T	NSYPLAZ1573	
1500 (59.1)	750 (29.5)	420 (16.5)	1	NSYPLA1574	NSYPLA1574T	NSYPLAZ1574	
1500 (59.1)	1000 (39.4)	320 (12.6)	2	NSYPLA15103	NSYPLA15103T	NSYPLAZ15103	
1500 (59.1)	1000 (39.4)	420 (16.5)	2	NSYPLA15104	NSYPLA15104T	NSYPLAZ15104	
1500 (59.1)	1250 (49.2)	320 (12.6)	2	NSYPLA15123	NSYPLA15123T	NSYPLAZ15123	
1500 (59.1)	1250 (49.2)	420 (16.5)	2	NSYPLA15124	NSYPLA15124T	NSYPLAZ15124	

Polyester Wall-Mounting Enclosures

Table 28.7: Thalassa Polyester Wall-Mounting Enclosures

	Height: mm (in)	Width: mm (in)	Depth: mm (in)	ABS/PC Wall-Mounting Enclosures IP66 [7]		Polyester Wall-Mounting Enclosures IP66 [7]				Polyester Wall-Mounting ATEX Enclosures [7]	Mounting Plate
				Plain door	Transparent door	Plain door	Transparent door	Plain door 3-point closure	Transparent door 3-point closure		
	310 (12.2)	215 (8.5)	160 (6.3)	NSYPLM32	NSYPLM32T	—	—	—	—	—	NSYMM32
	308 (12.1)	255 (10.0)	160 (6.3)	—	—	NSYPLM3025	NSYPLM3025T	—	—	NSYPLMEX3025	NSYMM3025
	430 (16.9)	330 (13.0)	200 (7.9)	—	—	NSYPLM43	NSYPLM43T	NSYPLM43V	NSYPLM43TV	NSYPLMEX43	NSYMM43
	530 (20.9)	430 (16.9)	200 (7.9)	—	—	NSYPLM54	NSYPLM54T	NSYPLM54V	NSYPLM54TV	NSYPLMEX54	NSYMM54
	647 (25.5)	436 (17.2)	250 (9.8)	—	—	NSYPLM64	NSYPLM64T	NSYPLM64V	NSYPLM64TV	NSYPLMEX64	NSYMM64
	747 (29.4)	536 (21.1)	300 (11.8)	—	—	NSYPLM75	NSYPLM75T	NSYPLM75V	NSYPLM75TV	NSYPLMEX75	NSYMM75
	847 (33.3)	636 (25.0)	300 (11.8)	—	—	NSYPLM86	NSYPLM86T	NSYPLM86V	NSYPLM86TV	NSYPLMEX86	NSYMM86
	1056 (41.6)	852 (33.5)	350 (13.8)	—	—	NSYPLM108	NSYPLM108T	—	—	NSYPLMEX108	NSYMM108

[7] See Table 28.2 UL File Numbers for Enclosures, page 28-3.

**Ventilation Systems with Filters**

Specially recommended for installations in which the ambient temperature is lower than the desired temperature inside the enclosure, a high protection rating is required: IP54 or IP55, and the surrounding environment is relatively clean, allowing air to enter the enclosure.

- 38 to 850 m<sup>3</sup>/h.
- Five input voltages: AC: 400/440 V, 230 V, 115 V (50/60 Hz), DC: 48 V and 24 V.
- Broad range of accessories (filters, IP55 and EMC covers, anti-vandalism kit).
- **UL Listing:** E80264



**Table 28.8: Ventilation Systems with Filters**

Fan flow rate (50 Hz)			Voltage	Catalog Number					
Free with filter	With 1 outlet grill	With 2 outlet grills		Fan with filter	Outlet grill	Color kit	IP55	IP55 stainless steel	EMC
				RAL 7035		RAL 7032			
38	25	33	230 V	NSYCVF38M230PF	NSYCAG92LPF	NSYCAG92LPC	—	—	—
38	27	35	115 V	NSYCVF38M115PF					
58	39	47	24 Vdc	NSYCVF38M24DPF					
44	34	41	48 Vdc	NSYCVF38M48DPF	NSYCAG125LPF	NSYCAG125LPC	NSYCAP125LZF	NSYCAG125LXF	NSYCAG125SLE
85	63	71	230 V	NSYCVF85M230PF					
79	65	73	115 V	NSYCVF85M115PF					
80	57	77	24 Vdc	NSYCVF85M24DPF	NSYCAG223LPF	NSYCAG223LPC	NSYCAP223LZF	NSYCAG223LXF	NSYCAP223LE
79	59	68	48 Vdc	NSYCVF85M48DPF					
165	153	161	230 V	NSYCVF165M230PF					
164	153	161	115 V	NSYCVF165M115PF	NSYCAG291LPF	NSYCAG291LPC	NSYCAP291LZF	NSYCAG291LXF	NSYCAP291LE
188	171	179	24 Vdc	NSYCVF165M24DPF					
193	171	179	48 Vdc	NSYCVF165M48DPF					
302	260	268	230 V	NSYCVF300M230PF	NSYCAG291LPC	NSYCAG291LPC	NSYCAP291LZF	NSYCAG291LXF	NSYCAP291LE
302	263	271	115 V	NSYCVF300M115PF					
262	221	229	24 Vdc	NSYCVF300M24DPF					
247	210	218	48 Vdc	NSYCVF300M48DPF	NSYCAG291LPC	NSYCAG291LPC	NSYCAP291LZF	NSYCAG291LXF	NSYCAP291LE
562	473	481	230 V	NSYCVF560M230PF					
582	485	494	115 V	NSYCVF560M115PF					
838	718	728	230 V	NSYCVF850M230PF	NSYCAG291LPC	NSYCAG291LPC	NSYCAP291LZF	NSYCAG291LXF	NSYCAP291LE
983	843	854	115 V	NSYCVF850M115PF					
931	798	809	400/440 V	NSYCVF850M400PF					

Thermal Control

Thermostats control the temperature inside the enclosure and send a signal when maximum or minimum temperature values have been reached.

- Temperature control: adjustable thermostats; single or double.
- Relative humidity control: adjustable humidistat.
- Temperature and relative humidity control: adjustable hygrotherm.



Table 28.9: Control temperature



N.C. thermostat

Control a resistance heater or an alarm	
Setting range	Catalog Number
0 to +60 °C	NSYCCOTH30VID
+32 to +140 °F	NSYCCOTH30VCF



N.O. thermostat

Control a fan or an alarm	
Setting range	Catalog Number
0 to +60 °C	NSYCCOTH30HOF
+32 to +140 °F	NSYCCOTH30HCF



Double thermostat

Control a resistance heater and a fan	
Setting range	Catalog Number
0 to +60 °C	NSYCCOTH30VID
+32 to +140 °F	NSYCCOTH30VCF



Thermostat with inverse contact

Control a resistance heater or a fan	
Setting range	Catalog Number
0 to +60 °C	NSYCCOTH30HOF
+32 to +140 °F	NSYCCOTH30HCF



Electronic thermostat

Control a resistance heater or a fan		
Setting range	Display	Catalog Number
+5 °C to +50 °C	°C or °F	NSYCCOHTH30VID
		NSYCCOHTH120VID
		NSYCCOHTH230VID

7 different operating modes.  
Option of installing one or two external sensors.



Electronic hygrotherm

Control temperature and relative humidity		
Setting range	Display	Catalog Number
+5 °C to +50 °C	°C or °F	NSYCCOHTH30VID
		NSYCCOHTH120VID
		NSYCCOHTH230VID

3 different operating modes.  
Option of installing an external sensor.



Electronic hygrostat

Control relative humidity		
Setting range	Display	Catalog Number
20% to 80%	% RH	NSYCCOHTH230VID

2 different operating modes.



Temperature sensor

PTC external temperature sensor (double insulation)	
Catalog Number	
NSYCCAST	

Table 28.10: Insulated resistance heaters



Insulated resistance heater with fan		
Power (W)	Voltage (V)	Catalog Number
100	120–240 AC	NSYCR100WU2C
10	120–240 AC	NSYCR10WU2C
147	120–240 AC	NSYCR150WU2C
20	120–240 AC	NSYCR20WU2C
55	120–240 AC	NSYCR50WU2C
177	230 AC	NSYCR170W230VVC

Table 28.11: Ultra-thin resistance heaters



Ultra-thin heaters		
Power (W)	Voltage (V)	Catalog Number
10	120	NSYCRS10W120V
10	240	NSYCRS10W240V
25	120	NSYCRS25W120V
25	240	NSYCRS25W240V
50	120	NSYCRS50W120V
50	240	NSYCRS50W240V
100	120	NSYCRS100W120V
100	240	NSYCRS100W240V
200	120	NSYCRS200W120V
200	240	NSYCRS200W240V

Table 28.12: Thermofans



Thermofans		
Power (W)	Voltage (V)	Catalog Number
400/550	230 AC	NSYCRP1W230VTV
400/550	120 AC	NSYCRP1W120VTV

# Section 29

## EcoStruxure™



EcoStruxure™ Power



EcoStruxure™ Building

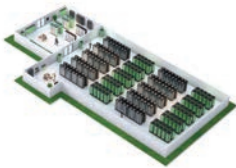

EcoStruxure™ IT



EcoStruxure™ Plant and Machine



EcoStruxure™ Grid

Overview of EcoStruxure™	29-2
EcoStruxure™ Power	29-3
EcoStruxure™ Building	29-4
EcoStruxure™ IT	29-5
EcoStruxure™ Plant and Machine	29-6
EcoStruxure™ Grid	29-7
EcoStruxure™ Energy and Sustainability Services	29-8
All Schneider Electric Services	29-8

**EcoStruxure™: IoT-enabled Architecture and Platform**

EcoStruxure™ is Schneider Electric's IoT-enabled, plug-and-play, open, interoperable architecture and platform, in Homes, Buildings, Data Centers, Infrastructure and Industries.

EcoStruxure delivers one architecture, serving four end markets (Building, Data Center, Industry, Infrastructure), with six domains of expertise: [1]

- EcoStruxure™ Power
- EcoStruxure™ Building
- EcoStruxure™ IT
- EcoStruxure™ Machine
- EcoStruxure™ Plant
- EcoStruxure™ Grid

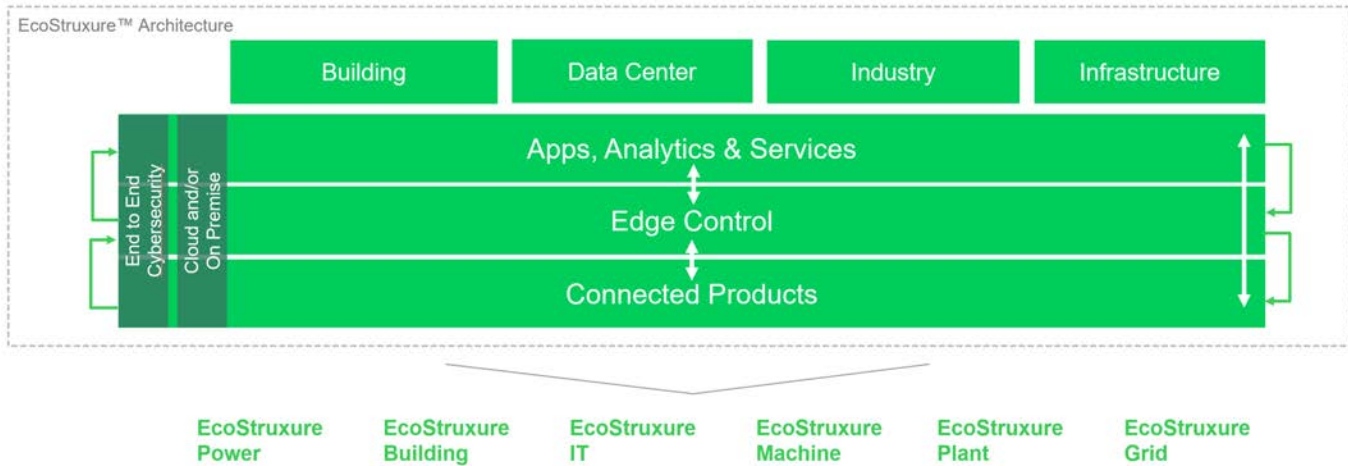

**Apps, Analytics, and Services [1]**

Interoperability is imperative to supporting the diverse hardware and systems in building, data center, industry, and grid end markets. EcoStruxure enables a breadth of agnostic applications, analytics & services for seamless enterprise integration.

**Edge Control [1]**

Mission-critical scenarios can be unpredictable, so control of devices at the edge of the IoT network is a must. This essential capability provides real-time solutions that enable local control at the edge, protecting safety and uptime.

**Connected Products [1]**

The Internet of Things starts with the best things. Our IoT-enabled best-in-class connected products include breakers, drives, UPSs, relays, sensors, and more. Devices with embedded intelligence drive better decision-making throughout operations.

[1] EcoStruxure™ is continually evolving and expanding. The printed Digest may not reflect all available connected products, apps, analytics, and services. Refer to EcoStruxure™ on www.se.com/us for the latest information.

### EcoStruxure™ Power

Schneider Electric's EcoStruxure Power offers advanced power system communication at every level of your operation. Connected products such as Masterpact MTZ circuit breakers are a key component of EcoStruxure Power, providing real-time operations data, smart analytics, and improved safety and security to your facility and processes. Welcome to the future of power distribution. [1]

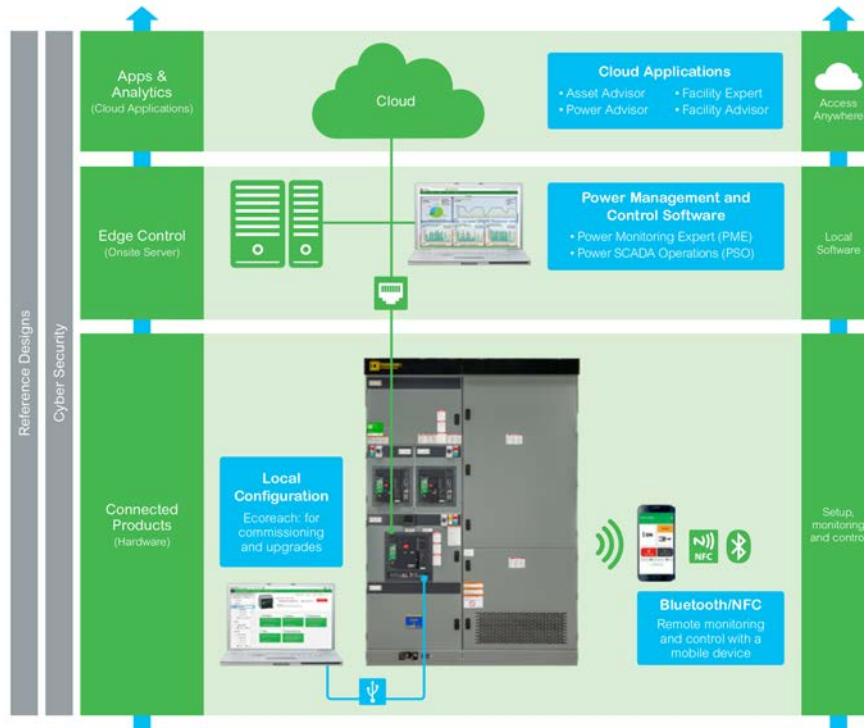

Visit [EcoStruxure™ Power](http://www.schneider-electric.us) on [www.schneider-electric.us](http://www.schneider-electric.us) for the latest information.

#### Apps, Analytics & Services [1]

Get actionable predictive maintenance information that protects your customers, safeguard your reputation and minimizing financial impact.

- EcoStruxure™ Asset Advisor
- EcoStruxure™ Power Advisor
- EcoStruxure™ Facility Advisor
- EcoStruxure™ Resource Advisor

#### Edge Control [1]

Track equipment and maintenance activity to reduce downtime, energy use, and maintenance costs while improving site planning and revealing additional capacity.

- EcoStruxure™ Facility Expert
- EcoStruxure™ Power Monitoring Expert
- EcoStruxure™ Power SCADA Operation
- EcoStruxure™ Substation Operation

#### Connected Products [1]

Monitor power distribution, anticipate needs, pinpoint concerns, and control assets remotely.

- Masterpact™ MTZ Circuit Breakers and Connected Products
- PowerLogic™ Power and Energy Meters
- Enerlin'X Com'X Energy Servers and Data Loggers
- Smart Panels and Smart Systems
- Galaxy Uninterruptible Power Supply (UPS)
- Premset MV Switchgear

[1] EcoStruxure™ is continually evolving and expanding. The Digest may not reflect all available connected products, apps, analytics, and services. Refer to [EcoStruxure™](http://www.schneider-electric.us) on [www.schneider-electric.us](http://www.schneider-electric.us) for the latest information.

## EcoStruxure™ Building

From design, through integration to commissioning, EcoStruxure™ Building brings best-in-class engineering efficiency to your building. Combined with our asset and energy performance services, we enable lifetime efficiency of your building ensuring productivity and comfort for occupants. [1]



Visit [EcoStruxure™ Building](http://EcoStruxure™ Building) on [www.schneider-electric.us](http://www.schneider-electric.us) for the latest information

### Apps, Analytics, and Services [1]

Gain actionable insights via apps, analytics and services based on best-in-class expertise, processes and predictive technology.

- [EcoStruxure™ Resource Advisor](#)
- [EcoStruxure™ Building Advisor](#)
- [EcoStruxure™ Workplace Advisor](#)
- [Connected Services / Field Services](#)

### Edge Control [1]

Simplify integration between buildings and systems with EcoStruxure Building Management.

- [Building Management](#)

### Connected Products [1]

Build a solid foundation with connected devices ranging from valves actuators and controllers, to circuit breakers, sensors and meters.

- [Masterpact™ MTZ](#)
- [PowerLogic™ Power and Energy Meters](#)
- [Altivar™ Drives](#)
- [PowerPact™ Circuit Breakers](#)
- [Smart Panels and Smart Systems](#)
- [Galaxy UPS](#)
- [Smart Devices](#)

[1] EcoStruxure™ is continually evolving and expanding. The Digest may not reflect all available connected products, apps, analytics, and services. Refer to [EcoStruxure™](#) on [www.schneider-electric.us](http://www.schneider-electric.us) for the latest information.



## EcoStruxure™ IT

In a connected world, it's now more important than ever to protect critical information and data. Ensure that your data center's physical infrastructure can adapt quickly to support both future demand driven by IoT and growth (in the cloud and at the edge) without ever compromising availability or operational efficiency. [1]

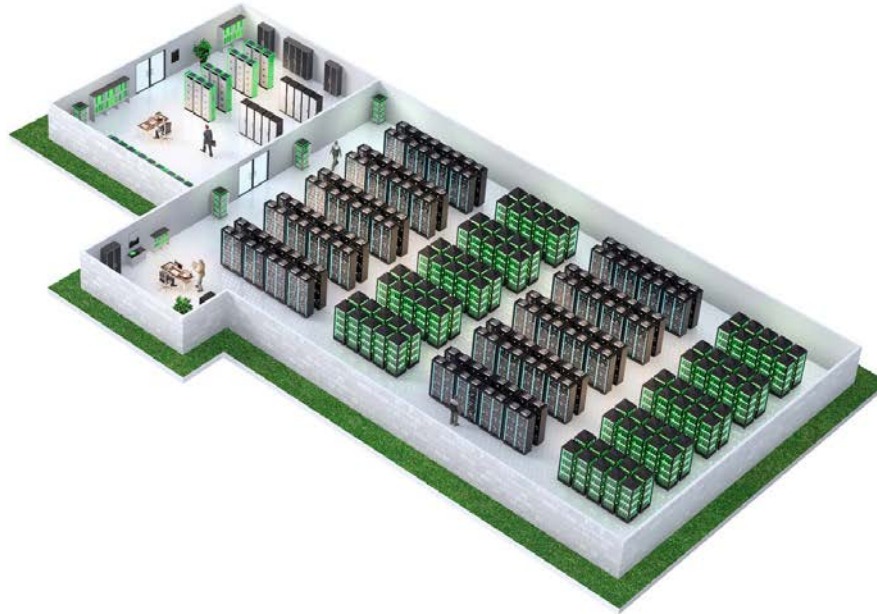

Visit [EcoStruxure™ IT](http://www.schneider-electric.us) on [www.schneider-electric.us](http://www.schneider-electric.us) for the latest information

### Apps, Analytics & Services [1]

Increasing resiliency and visibility through live sensor data, predictive analytics and smart alarming.

- [EcoStruxure™ IT Advisor](#)
- [EcoStruxure™ Asset Advisor](#)

### Edge Control [1]

For real-time monitoring, incident management, analysis and asset utilization.

- [EcoStruxure™ IT Expert](#)

### Connected Products [1]

Connecting the domains of IT, mechanical and power room for resiliency and efficiency.

- Visit [EcoStruxure™ IT](http://www.schneider-electric.us) on [www.schneider-electric.us](http://www.schneider-electric.us) for the latest connected products.

[1] EcoStruxure™ is continually evolving and expanding. The Digest may not reflect all available connected products, apps, analytics, and services. Refer to [EcoStruxure™](http://www.schneider-electric.us) on [www.schneider-electric.us](http://www.schneider-electric.us) for the latest information.

## EcoStruxure™ Plant and Machine

Schneider Electric is leading the digital transformation of industrial automation markets. Delivered through our EcoStruxure architecture, our IIoT technologies, including integrated software, are ready for smart manufacturing and can deliver new business opportunities for plants and machine builders — increasing profitability and productivity.

[1]

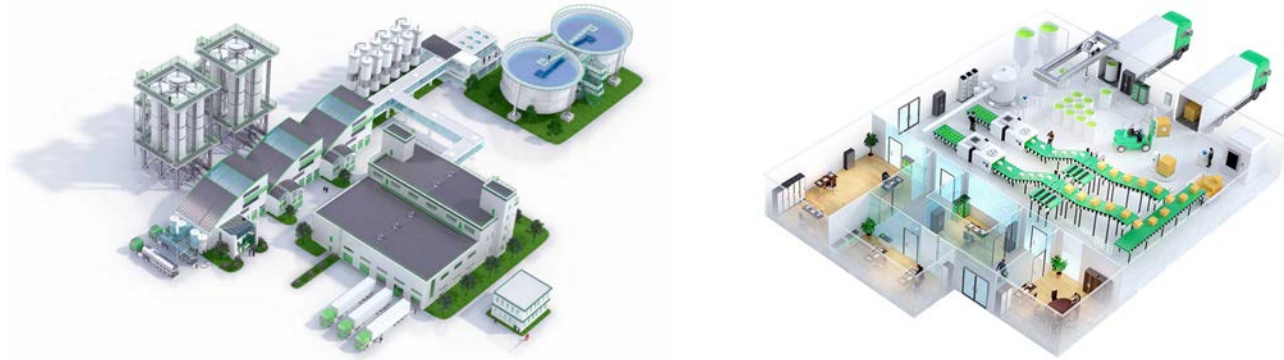

### Apps, Analytics & Software [1]

Our full portfolio of software, apps, and analytics offer tools and information in a format that is easily actionable to turn plant personnel into business decision makers, who can contribute easily to optimizing your system.

- [Asset Performance Monitoring and Control Software](#)
- [Wonderware® System Platform](#)
- [EcoStruxure™ Machine Advisor](#)
- [EcoStruxure™ Secure Connect Advisor](#)
- [EcoStruxure™ Augmented Operator Advisor](#)
- [EcoStruxure™ Mobile Operator Advisor](#)
- [Machine automation software](#)
- [EcoStruxure™ Profit Advisor](#)
- [EcoStruxure™ Control Advisor](#)
- [EcoStruxure™ Maintenance Advisor](#)
- [EcoStruxure™ Asset Advisor](#)
- [EcoStruxure™ Resource Advisor](#)

### Edge Control [1]

Our connected control platforms provide better insight into operations, reduce time to market, reduce process energy consumption and improve productivity.

- [Magelis IIoT Box PCs and Industrial PCs](#)
- [Hybrid Process - Modicon M580 ePAC controller](#)
- [Continuous Process - Foxboro](#)
- [Safety Instrumented System - Triconex](#)
- [Machine automation](#)
- [Building Management](#)

### Connected Products [1]

Our connected products bring intelligence to your system, enabling your assets to provide advanced process data for smarter operations.

- Visit [EcoStruxure™ Plant & Machine](#) on [www.schneider-electric.us](http://www.schneider-electric.us) for the latest connected products.
- [Magelis HMI](#)
- [Sensors & RFID](#)
- [Process Instrumentation](#)
- [TeSys™ Control and Protection](#)
- [Altivar™ Machine variable speed drives](#)
- [Altivar™ Process variable speed drives](#)
- [Harmony Push Buttons, Controllers, and Signaling Products](#)
- [Preventa™ Process and Machine Safety](#)
- [Lexium Servo Drives & Motors](#)

[1] EcoStruxure™ is continually evolving and expanding. The Digest may not reflect all available connected products, apps, analytics, and services. Refer to [EcoStruxure™](#) on [www.schneider-electric.us](http://www.schneider-electric.us) for the latest information.

**EcoStruxure™ Grid**

From seamless local production and integration at the grid edge, to bridging demand and supply, EcoStruxure™ Grid increases your grid's efficiency for sustainable networks. [1]



**Apps, Analytics, and Services [1]**

Smart grid analytics for efficient operations, predictive maintenance and investment plans. A complete services portfolio - from field instruments to control room - to help optimize assets, people, equipment and plant, at every stage of your asset life cycle.

- EcoStruxure™ ADMS
- EcoStruxure™ ArcFM
- EcoStruxure™ Asset Advisor
- EcoStruxure™ Microgrid Advisor
- EcoStruxure™ Smart Metering Advisor
- EcoStruxure™ Resource Advisor
- Field Services

**Edge Control [1]**

Secure, reliable & efficient grid, substation & meter management.

- EcoStruxure™ Substation Operation
- EcoStruxure™ Microgrid Operation
- EcoStruxure™ Advanced Metering Operation

**Connected Products [1]**

Remote control & monitoring insights on mobile tools for safer maintenance and operations.

- Visit EcoStruxure™ Grid on [www.schneider-electric.us](http://www.schneider-electric.us) for the latest connected products.
- Smart Ring Main Unit
- Easergy T300 Remote Terminal Unit
- Easergy Protection relays
- Minera SGrid Transformer

[1] EcoStruxure™ is continually evolving and expanding. The Digest may not reflect all available connected products, apps, analytics, and services. Refer to EcoStruxure™ on [www.schneider-electric.us](http://www.schneider-electric.us) for the latest information.

## EcoStruxure™ Energy and Sustainability Services



Discover our [EcoStruxure™ Energy and Sustainability Services](#) (formerly known as Energy and Sustainability Services), including big data management, to turn this vision into your business reality.

### Active Energy Management: an integrated approach for sustainable growth

Organizations are starting to integrate how they use and buy energy with sustainability initiatives to see additional benefits such as increased efficiency, financial savings and more sustainable operations across their global footprint. We call this market convergence Active Energy Management. Find out how you can look at energy and sustainability holistically and start your journey to Active Energy Management.

## All Schneider Electric Services



Schneider Electric is dedicated to maintaining and improving your system's reliability, productivity, comfort and efficiency, and providing you with power, automation and control, and building life cycle service solutions.

Our customer support services are designed so that you can select the level of expertise and resources you need to keep your processes and infrastructure at peak operational performance, anywhere in the United States, any time you need us. <sup>[1]</sup>

Visit [Services](#) on [www.schneider-electric.us](http://www.schneider-electric.us) for more information:



### Field Services

Schneider Electric Services safely and consistently delivers expert care across your systems, enabling you to operate at peak performance. From power restoration services to modernization and upgrade solutions, we have the expertise to work on any manufacturer's equipment.



### Consulting Services

Our consultants serve as trusted advisers who will provide recommendations to optimize your energy profile to minimize costs, solve complex power system issues to ensure electrical reliability, and provide a strategy to meet future energy requirements.



### Partner Managed Services

Featuring our software suite of managed services which help to improve operations, manage assets, and decrease energy costs in your buildings.



### Integrated Facility Management

Reduce OpEx, avoid unplanned costs, and increase uptime throughout your data center's life cycle.



### EcoStruxure™ Energy and Sustainability Services

We help our clients design a strategy, deliver efficiency in their facilities and sustain results over time through long-term partnerships. As an unbiased, independent consultant, we work with clients in more than 100 countries; from regional companies to the world's largest corporations.



### Natural Disasters Support

When disaster strikes, Schneider Electric is committed to helping customers restore power safely and efficiently, 24 hours a day. If you need assistance, call us at 1-888-272-6841 and enter PIN 987833#

[1] EcoStruxure™ is continually evolving and expanding. The Digest may not reflect all available connected products, apps, analytics, and services. Refer to [EcoStruxure™](#) on [www.schneider-electric.us](http://www.schneider-electric.us) for the latest information.

<b>1,201–15,000 Vac distribution transformers</b>	<b>14-21</b>		
<b>1000 Vdc photovoltaic heavy duty disconnect Switch</b>	<b>3-34</b>		
<b>14-inch-wide NQ main interiors</b>	<b>9-13</b>		
<b>16 mm push buttons</b>	<b>19-12, 19-21–19-23</b>		
accessories, XB6	19-20		
complete devices, XB6	19-12		
selection guide	19-2		
selector switches, keyed	19-18		
selector switches, non-illuminated	19-17		
XB6 accessories	19-20		
XB6 electrical components	19-15		
XB6 operators, illuminated	19-16		
XB6 operators, non-illuminated	19-16		
XB6E monolithic	19-21		
<b>2-pole single phase full voltage starters</b>	<b>16-37</b>		
<b>2-Pole single phase full voltage starters</b>	<b>16-35–16-36</b>		
<b>20-inch-wide NF main lug interiors</b>	<b>9-26</b>		
<b>20-inch-wide NQ main interiors</b>	<b>9-12</b>		
<b>20-inch-wide NQ main lug interiors</b>	<b>9-11</b>		
<b>22 mm push buttons</b>	<b>19-24, 19-30, 19-33, 19-53</b>		
accessories, XB4	19-40		
accessories, XB5	19-60		
accessories, XB7	19-71		
common operators XB4–XB5	19-8		
operators, non-illuminated	19-27		
point of purchase blister packs	19-114		
selection guide	19-3		
XB4 complete devices	19-24, 19-26		
XB4 electrical components	19-35		
XB4 legend holders and inserts	19-38–19-39		
XB4 legend sheets	19-39		
XB4 operators, illuminated	19-33		
XB4 pilot lights	19-32		
XB5 complete devices	19-43		
XB5 electrical components	19-55		
XB5 legend holders and inserts	19-58–19-59		
XB5 operators, emergency stop	19-49		
XB5 operators, illuminated	19-53		
XB5 operators, non-illuminated	19-46		
XB5 pilot lights	19-52		
XB5 selector switches	19-50		
XB5 specialty operators	19-51		
XB5R and XB4R accessories	19-64		
XB5R and XB4R wireless	19-63		
XB7 illuminated with projecting push	19-69		
XB7 legend holders and inserts	19-71		
XB7 mushroom head	19-70		
XB7 pilot lights	19-69		
XB7 push buttons	19-68		
XB7 selector and key switches	19-70		
<b>2SIS</b>	<b>11-14</b>		
<b>2SIS, Premset™</b>	<b>11-14</b>		
<b>3-pole polyphase</b>	<b>16-29</b>		
<b>30 mm control station enclosures</b>	<b>19-111</b>		
<b>30 mm push buttons</b>	<b>19-72</b>		
9001K selector switches	19-75–19-77		
9001SK selector switches	19-85–19-87		
accessories			
caps, knobs, and inserts	19-99		
Type K and SK closing plates	19-98		
Type K and SK interlock	19-101		
Type K and SK mushroom button guards	19-97		
Type K and SK padlock attachments	19-97		
Type K and SK protective boots	19-98		
Type K and SK replacement parts	19-100		
Type K and SK ring nuts	19-100		
Type K and SK screwdriver	19-101		
Type K and SK wrenches	19-101		
common operators Type K and SK	19-9		
operators, Type SK momentary	19-82		
operators, Type SK multifunction	19-83		
point of purchase blister packs	19-114		
potentiometers with dial plate, K	19-77		
potentiometers with dial plate, SK	19-87		
selection guide	19-3		
selector switch guide	19-78		
Type B standard duty control stations	19-111		
Type K heavy duty operators	19-72		
Type K heavy duty pilot lights	19-79		
Type K heavy duty specialty operators	19-80		
Type K, SK legend holders and inserts	19-94		
Type SK corrosion resistant pilot lights	19-88		
Type SK multifunction operators	19-89		
Type SK operators, illuminated	19-84		
<b>30 mm push buttons (square)</b>	<b>19-102</b>		
accessories, Type KX	19-106		
contact blocks	19-104		
selector switches with contacts	19-102		
Type KX legend holders	19-105		
Type KX pilot lights	19-103		
Type KX potentiometers	19-102		
Type KX selectors without contacts	19-104		
Type KX with contacts	19-102		
Type KX without contacts	19-103		
<b>30 mm ultrasonic sensors</b>	<b>20-12</b>		
<b>304L stainless steel enclosures</b>	<b>28-2</b>		
<b>316 grade stainless steel, NEMA Type 3, 3R, 4, 4X, 5, 12</b>	<b>3-12</b>		
<b>316L stainless steel enclosures</b>	<b>28-2</b>		
<b>4-Pole, 2-Phase</b>	<b>16-36</b>		
<b>4-Pole, 2-Phase full voltage starters</b>	<b>16-35–16-36</b>		
<b>400 A</b>			
current-limiting	7-35		
thermal-magnetic	7-35		
<b>500 Vdc circuit breakers</b>			
PowerPact™ H-frame	7-43		
PowerPact™ J-frame	7-43		
<b>800 A–5000 A busway</b>	<b>12-7, 12-9–12-10</b>		
<b>8501NH accessories</b>	<b>23-60, 23-62–23-63, 23-110</b>		
<b>8501NR sockets</b>	<b>23-60, 23-62–23-63, 23-110</b>		
<b>9012G</b>	<b>22-20</b>		
<b>9012G pressure switches</b>			
differential	22-18		
dual stage	22-18		
industrial	22-16		
machine tool	22-17		
<b>9016GAW vacuum switches</b>	<b>22-22</b>		
<b>9016GVG vacuum switches</b>	<b>22-22</b>		
<b>9036D float switches</b>	<b>22-28</b>		
<b>9036FG float switch</b>	<b>22-29</b>		
<b>9036G float switches</b>	<b>22-28</b>		
<b>9037E float switch</b>	<b>22-29</b>		
<b>9037H closed tank float switches</b>	<b>22-31</b>		
<b>9038A mechanical alternators</b>	<b>22-32</b>		
<b>9038C mechanical alternators</b>	<b>22-32</b>		
<b>9038C mechanical alternators with bushing</b>	<b>22-32</b>		
<b>9038D mechanical alternators</b>	<b>22-33</b>		
<hr/>			
<b>A</b>			
<b>ABL1 DC power supplies</b>	<b>23-117</b>		
<b>ABL7 DC power supplies</b>	<b>23-117</b>		
<b>ABL8 DC power supplies</b>	<b>23-117</b>		
<b>ABR electromechanical interface modules</b>	<b>23-118</b>		
<b>ABS solid-state interface modules</b>	<b>23-118</b>		

**AC drives**

Altivar™ 12	26-2, 26-12	safety switch	
Altivar™ 1260 medium voltage	26-9	double throw	3-28
Altivar™ 212	26-6, 26-10	general duty	3-6
Altivar™ 312	26-2, 26-13	solid neutral	16-130
Altivar™ 320	26-3, 26-15	starters	16-127
Altivar™ 340	26-4, 26-17	melting alloy	16-126
Altivar™ 61	26-6, 26-18	TeSys AK5 panel busbar system	18-58
Altivar™ 660/960 process drive systems	26-9	TeSys D	16-18, 16-20, 18-13, 18-15–18-16, 18-21
Altivar™ 680/980 process drive systems	26-9	TeSys F	16-18, 18-13, 18-15, 18-19–18-20, 18-57
Altivar™ 71	26-5, 26-19–26-20	TeSys GV	18-50
Altivar™ Process 600	26-6	TeSys K	18-13
Altivar™ Process 630	26-24	TeSys U	18-22
Altivar™ Process 650	26-24	transient suppression module	16-130
Altivar™ Process 900	26-5	trench duct	13-8
Altivar™ Process 930	26-25	trip unit	7-62, 7-76
Altivar™ Process 950	26-25	Type K and SK 30 mm push button	19-94
documentation	26-32	Type K and SK push buttons	
padlock attachments			19-97
North American drive systems		Type S	
outdoor Altivar™ 630/930	26-10	melting alloy	16-126
S-Flex (Altivar™ 212) enclosed	26-27	ultrasonic sensors	20-10
S-Flex™ (Altivar™ 212)	26-8	<b>accessories and modification kits</b>	<b>16-9</b>
support	26-32	<b>accessories and modification kits, manual starters</b>	<b>16-9</b>
training	26-32	<b>accessories and modifications</b>	<b>16-11</b>
<b>accessories</b>	<b>16-127, 18-57</b>	manual starters and switches	16-11
30 mm push buttons		<b>accessories, TeSys D</b>	<b>18-21</b>
Type K and SK mushroom button guards	19-97	<b>AccuSine PCS+ active harmonic filters</b>	<b>4-45</b>
cabling, TeSys D	16-20, 18-17	<b>AccuSine PFV+ electronic VAR control</b>	<b>4-41</b>
circuit breaker		<b>active harmonic filters, AccuSine PCS+</b>	<b>4-45</b>
Homeline	1-20	<b>adapter, I-Line™ to I-Line™ II</b>	<b>12-9</b>
Homeline™	1-20, 7-22	<b>adjustable rating plugs, Micrologic™ trip units</b>	<b>7-62</b>
mounting base, QO	7-16	<b>Advantys Telefast 2 connection system</b>	<b>24-32</b>
Multi 9™ C60	7-28	<b>alarms and sirens, XVS</b>	<b>19-126</b>
PowerPact™	7-49–7-52	<b>all-in-ones, rainproof</b>	<b>1-34, 1-39</b>
QO/QOB	1-8, 7-15	<b>alternating relays</b>	<b>23-90</b>
trip unit	7-62, 7-76	<b>Altistart™ soft starters</b>	
circuit breaker	1-8, 7-15	Altistart 48™	26-29
combination service entrance device CSED	1-37	Altistart™ 01	26-7
contactors	16-127	Altistart™ 22	26-7–26-8, 26-28
contactors, TeSys D	16-18, 16-20, 18-13, 18-16, 18-21	Altistart™ 22 (Enclosed) motor controller	26-30
contactors, TeSys F	16-18, 18-13, 18-19–18-20, 18-57	Altistart™ 48	26-7–26-8
electronic trip unit	7-62, 7-76	Altistart™ U01	
float switch	22-34	dimensions	18-76
Homeline load center	1-27	<b>Altivar™ AC drives</b>	
hubs and closing plates for CSEDs	1-36	Altivar™ 12	26-2
load center		Altivar™ 212	26-6
QO	1-26	Altivar™ 312	26-2
machine tool pressure switches	22-21	Altivar™ 320	26-3, 26-15
mechanical interlocks	16-131	Altivar™ 340	26-4, 26-17
meter centers, EZM	2-21	Altivar™ 61	26-6
meter sockets	2-3	Altivar™ 71	26-5, 26-19–26-20
miniature circuit breakers, Homeline™	1-20, 7-22	Altivar™ Process 600	26-6
overload relays		Altivar™ Process 630	26-24
melting alloy	16-126	Altivar™ Process 650	26-24
pendant station, XAC	19-134	Altivar™ Process 900	26-5
photoelectric sensors	20-2, 20-4	Altivar™ Process 930	26-25
Powerlink™	9-40–9-41	Altivar™ Process 950	26-25
proximity sensors	20-6–20-7, 20-9	options and accessories	26-11, 26-14, 26-22
push button		<b>Altivar™ Process 950</b>	<b>26-25</b>
XB4	19-40	<b>analog interface modules</b>	
XB4 22 mm legend sheets	19-39	Zelio RMC	23-118
XB4 legend holders and inserts	19-39	Zelio RMP	23-118
XB5R and XB4R	19-64	Zelio RMT	23-118
XB6	19-20	<b>Appleton Powertite receptacle safety switches</b>	<b>3-14</b>
XB6E monolithic	19-23	<b>application data</b>	<b>16-56, 21-4</b>
push buttons		limit switches	21-4
XB7 22 mm	19-71	<b>application data for selection</b>	<b>16-38</b>
QOU miniature circuit breakers	7-19	<b>apps, analytics, &amp; services, EcoStruxure™</b>	<b>29-2</b>

for EcoStruxure™ Building	29-4	rotary handles	7-51
for EcoStruxure™ Grid	29-7	terminal nuts and terminal shields	7-57
for EcoStruxure™ IT	29-5	termination options	7-30
for EcoStruxure™ Machine	29-6	<b>backup power solutions</b>	<b>1-13</b>
for EcoStruxure™ Plant	29-6	<b>BCPM (branch circuit power meter)</b>	<b>4-22</b>
for EcoStruxure™ Power	29-3	<b>beacons</b>	
<b>AR1 cable end markers</b>	<b>24-31</b>	XVB 70 mm	19-115–19-117
<b>arc extinguishing system, Arc Terminator</b>	<b>11-33</b>	XVR pre-wired rotating mirror	19-125
<b>arc flash analysis</b>	<b>4-28</b>	<b>biometric switches</b>	<b>19-66</b>
<b>arc flash limiting circuit breakers</b>	<b>7-73, 11-4, 11-10</b>	<b>blade isolators</b>	<b>24-5, 24-10, 24-15</b>
<b>arc flash mitigation</b>		<b>blown fuse indicators</b>	<b>24-20</b>
V125 arc flash module	5-2–5-3	<b>bodies</b>	<b>21-17</b>
<b>arc resistant switchgear, ArcBlock</b>	<b>11-11</b>	<b>bodies and options</b>	<b>21-33</b>
<b>arc resistant, Model 6 MCC enclosure</b>	<b>17-2</b>	<b>bodies, limit switches</b>	<b>21-17</b>
<b>Arc Terminator, arc extinguishing system</b>	<b>11-33</b>	<b>bolt-on circuit breakers</b>	
<b>arc-fault circuit breaker</b>		Powerlink™ ECB-G3 remotely operated	9-39
QO-CAFI combination	1-5, 7-13	QOB for NQ panelboards	9-14
QO-DF dual function	1-5, 7-13	<b>boric acid fuses, HVL</b>	<b>11-27</b>
<b>ArcBlok arc resistant switchgear</b>	<b>11-11</b>	<b>box lugs</b>	<b>24-19</b>
<b>AT1 cable end tools</b>	<b>24-31</b>	<b>branch devices</b>	
<b>ATEX enclosures for explosive atmosphere</b>	<b>28-2</b>	1Ø NEMA 3R meter centers	2-14
<b>Auto-Man-Stop timer modules</b>	<b>23-89</b>	3Ø NEMA 3R meter centers	2-17
<b>automatic switches</b>		meter center dimensions	2-22
PowerPact™	7-44	meter centers	2-14
<b>automation products</b>	<b>27-8–27-9</b>	QMB fusible branch switches	9-62
CANopen network products	27-19	<b>busbar accessories, TeSys contactors</b>	<b>18-58</b>
ConneXium ethernet products	27-17	<b>busway</b>	<b>12-14</b>
Magelis small panels		EZM center tap mains	2-20
Magelis STO/STU	27-6	EZM main with busway side tap	2-19
Magelis XBT N/R	27-6	I-Line™	12-6
Magelis STO/STU small panels	27-6	I-Line™ II	
Magelis XBT N/R small panels	27-6	800 A–5000 A	12-7, 12-9–12-10
Modicon Premium™ PAC	27-5	electrical data	12-10
Modicon Quantum™ PAC	27-5	straight lengths, fittings, and accessories	12-7, 12-9–12-10
Modicon STB	27-15	surge protective device (SPD) plug-in units	12-11
Modicon Telefast ABE7 sub-bases	27-15	I-Line™ II plug-in units	
Modicon Telefast ABE9 passive splitter boxes	27-15	Class R fuse kits	12-10
Modicon TM7 I/O blocks	27-15	fusible	12-10
Modicon™ M241 PLC	27-2	hooksticks	12-10
Modicon™ M251 PLC	27-3	PowerPact™ H- and J-frame	12-12–12-13, 12-15
Modicon™ M258 PLC	27-3	PowerPact™ L-frame	12-14–12-15
Modicon™ TSX Micro PLC	27-4	PowerPact™ M-frame	12-15
Modicon™ Unity Momentum PLC	27-4	PowerPact™ P-frame	12-16
Modicon™ Zelio Logic controller	27-2	PowerPact™ R-frame	12-17
Transparent Ready solutions	27-18	I-Line™ to I-Line™ II adapter	12-9
<b>auxiliary contact blocks</b>		Power-Zone™ non-segregated bus	12-18
instantaneous	23-87, 23-93	Powerbus™	12-2
time delay	23-88, 23-93	plug-in units	12-3
<b>auxiliary contacts</b>	<b>16-128, 18-14, 23-87</b>	SurgeLogic™ SPD units	6-5
manual and magnetic contactors and starters	16-128	transition section meter centers	2-19
TeSys D and F	16-18, 18-14		
<b>auxiliary gutter, QO™ load centers</b>	<b>1-11</b>		
<b>AZ5 cable ends</b>	<b>24-30</b>		

## B

<b>B-frame, PowerPact™</b>	
automatic molded case switch	7-44
catalog numbering system	7-29
circuit breakers	7-29–7-30
compression lugs	7-55
dimensions and shipping weights	7-81
electrical accessories	7-49
I-Line™ circuit breakers	9-51
interrupting ratings	7-30
locking devices	7-52
mechanical lugs	7-54
power distribution connectors (PDC)	7-56

## C

<b>C60, Multi 9™</b>	
accessories	7-28
UL489 mounting bases	7-16
<b>C60BPR, Multi 9™</b>	
Miniature circuit breakers	7-23
<b>C60H-DCMulti 9™</b>	<b>7-25</b>
<b>C60SP, Multi 9™</b>	
miniature circuit breakers	7-24
<b>cable ends</b>	
markers	24-31
tools	24-31
Type AZ5	24-30
Type DZ5	24-30
<b>cabling accessories</b>	<b>16-20, 18-16</b>
TeSys D	16-20, 18-17

<b>cabling, TeSys D</b>	<b>16-20, 18-17</b>	miniature, QO™	
<b>calculation of rip current rating</b>	<b>16-136</b>	accessories, factory-installed	1-8, 7-15
<b>calculation of trip current rating</b>		for meter mains and all-in-ones	1-36
thermal unit selection	16-136	QOB bolt-on	9-14
<b>cam-lock</b>	<b>10-7</b>	motor protector, H-, J-, and L-frame	18-37
<b>cam-lock tap box</b>	<b>10-7</b>	NF merchandised panelboards	9-28
<b>CANopen network products</b>	<b>27-19</b>	operating mechanisms, door-mounted	8-39
<b>capacitive proximity sensors</b>		sub-feed for NQ factory assembled panelboards	9-17
accessories	20-9	tenant	2-7
<b>capacitor</b>	<b>18-9</b>	<b>circuit breakers, 500 Vdc</b>	
<b>capacitor banks</b>	<b>4-35–4-37, 4-39</b>	PowerPact™ H-frame	7-43
<b>caps</b>		PowerPact™ J-frame	7-43
16 mm push buttons	19-19	<b>circuit breakers, B-frame</b>	
22 mm push buttons	19-40, 19-60	I-Line™	9-51
30 mm push buttons	19-79, 19-84	<b>circuit breakers, F-frame</b>	
<b>catalog numbering system</b>		I-Line™	9-52–9-53
combination starters	17-4	<b>circuit breakers, PowerPact™ B-frame</b>	<b>7-29–7-30</b>
EZM branch devices	2-10	compression lugs	7-55
EZM mains devices	2-10	dimensions and shipping weights	7-81
Model 6 MCC branch feeder units	17-8	electrical accessories	7-49
motor disconnect switches, UL508	8-3	locking devices	7-52
NEMA AC magnetic contactors and starters	16-28	mechanical lugs	7-54
PowerPact™ circuit breakers	7-29	power distribution connectors (PDC)	7-56
TeSys™ D starters, enclosed	18-42	rotary handles	7-51
TeSys™ F contactors and overload relays	18-10	terminal nuts and terminal shields	7-57
TeSys™ N contactors and starters	16-13	<b>circuit breakers, PowerPact™ H-frame</b>	<b>7-29, 7-31</b>
<b>CBGS-0</b>	<b>11-29</b>	500 Vdc	7-43
<b>CBGS-0 switchgear</b>	<b>11-29</b>	compression lugs	7-55
<b>ceiling mounting bracket, transformer</b>	<b>14-13</b>	dimensions and shipping weights	7-81
<b>circuit breaker accessories</b>		electrical accessories	7-49
PowerPact™	7-49–7-52	I-Line™	9-54
<b>circuit breaker enclosures</b>		locking devices	7-52
dimensions, NEMA Type 1, 3R, 7, 9	7-86	mechanical lugs	7-54
dimensions, NEMA Type 4, 4X, 5, 12, and 12K	7-86	Micrologic™ trip units	7-59
insulated groundable neutral assembly	7-85	motor circuit protector (MCP)	7-46–7-47
key interlock systems	2-25	motor operators	7-50
lock-on provision	2-24	motor protector	7-48
pilot light	2-24	plug-in and drawout mounting	7-58
PowerPact™ Q-frame	1-42	power distribution connectors (PDC)	7-56
push button	2-24	rear connections	7-52
QO™ and QOM2	1-42	rotary handles	7-51
selector switch	2-24	terminal nuts and terminal shields	7-57
service ground kits	7-85	<b>circuit breakers, PowerPact™ J-frame</b>	<b>7-29, 7-31</b>
<b>circuit breakers</b>		compression lugs	7-55
ECB-G3 remotely operated	9-39	dimensions and shipping weights	7-81
emergency lighting	9-39	electrical accessories	7-49
for CSEDs	1-36	I-Line™	9-54
instantaneous trip	7-45	locking devices	7-52
LA for I-Line™ panelboards	9-57	mechanical lugs	7-54
Masterpact™ NT/NW universal power	7-73	Micrologic™ trip units	7-59
switchboard/switchgear	11-3	mission critical	7-42, 9-56
miniature, Homeline™		motor circuit protector (MCP)	7-46–7-47
accessories	1-20, 7-22	motor operators	7-50
for meter mains and all-in-ones	1-36	motor protector	7-48
HOM-CAFI combination arc-fault circuit interrupter	1-18, 7-20	plug-in and drawout mounting	7-58
HOM-DF dual function arc-fault circuit interrupter	1-19, 7-20	power distribution connectors (PDC)	7-56
HOM-EPD equipment protection device	1-19, 7-21	rear connections	7-52
HOM-GFI ground-fault circuit interrupter	1-18, 7-21	rotary handles	7-51
HOM-HM high magnetic trip	1-18, 7-20	terminal nuts and terminal shields	7-57
HOMT tandem and quad tandem	1-19, 7-21	<b>circuit breakers, PowerPact™ L-frame</b>	<b>7-29, 7-36</b>
plug-on	1-18, 7-20	500 Vdc	7-43
wire sizes	1-20, 7-22	bus bar hardware	7-57
miniature, Multi 9™		compression lugs	7-55
busbars	7-26–7-27	dimensions and shipping weights	7-81
C60BP and C60BPR	7-23	electrical accessories	7-49
C60H-DC	7-25	I-Line™	9-57
C60SP	7-24	locking devices	7-52
ground fault protector	7-25	mechanical lugs	7-54
selection information	7-5		



Micrologic™ trip units	7-59	<b>circuit protectors, thermal-magnetic</b>	
mission critical	7-42, 9-56	Type GB2	24-25
motor operators	7-50	Type GCB	24-24
motor protector	7-48	<b>Class 5250</b>	<b>13-5</b>
plug-in and drawout mounting	7-58	<b>Class 9991 NEMA 1 enclosure</b>	<b>23-98</b>
power distribution connectors (PDC)	7-56	<b>class H, R, J, L fuse provisions</b>	<b>3-9</b>
rear connections	7-52	<b>class R fuse kits</b>	<b>3-16</b>
rotary handles	7-51	<b>ClimaSys™ thermal management system</b>	
terminal shields	7-57	cooling units	28-3, 28-10
<b>circuit breakers, PowerPact™ M-frame</b>	<b>7-29, 7-38</b>	thermostats	28-3, 28-10
bus bar hardware	7-57	ventilation systems	28-3, 28-9
compression lugs	7-55	<b>closed tank float switches</b>	<b>22-29, 22-31</b>
dimensions and shipping weights	7-81	9038C mechanical alternators with bushing	22-32
electrical accessories	7-49	9038D mechanical alternators	22-33
I-Line™	9-57	<b>coil replacement, definite purpose contactors</b>	<b>16-90</b>
locking devices	7-52	<b>coil suppressor modules</b>	<b>23-88</b>
mechanical lugs	7-54	<b>coil suppressor, TeSys D</b>	<b>16-20, 18-16</b>
phase barriers	7-57	<b>coil suppressors</b>	<b>16-20, 18-16</b>
power distribution connectors (PDC)	7-56	<b>coil voltage codes</b>	<b>16-70</b>
<b>circuit breakers, PowerPact™ P-frame</b>	<b>7-29, 7-39</b>	TeSys D	18-6, 18-9
bus bar hardware	7-57	TeSys F	18-10
compression lugs	7-55	<b>Com'X data loggers and energy servers</b>	<b>4-26, 7-77–7-78</b>
dimensions and shipping weights	7-81	<b>combination</b>	<b>16-77</b>
drawout cradle	7-58	lighting contactors	16-77
I-Line™	9-59	<b>combination arc fault circuit interrupter, QO-CAFI</b>	<b>1-5, 7-13</b>
locking devices	7-52	<b>combination service entrance devices</b>	
mechanical lugs	7-54	all-in-ones, rainproof	1-34, 1-39
Micrologic™ trip units	7-60	meter mains, rainproof	1-32
phase barriers	7-57	solar ready CSED	1-39
power distribution connectors (PDC)	7-56	<b>combination starter units</b>	
rotary handles	7-51	catalog numbering system	17-4
spring charging motors	7-50	<b>combination starters</b>	<b>16-46, 17-4–17-5</b>
termination options	7-58	combination starters	
<b>circuit breakers, PowerPact™ Q-frame</b>	<b>7-29</b>	NEMA style	
enclosures	1-42	interlocks	16-57
I-Line™	9-53	Compac™ 6 fusible switch disconnects	17-7
thermal magnetic circuit breakers	7-34	fusible switch disconnects	17-6
<b>circuit breakers, PowerPact™ R-frame</b>	<b>7-29, 7-40</b>	Model 6 MCC	17-5
compression lugs	7-55	motor circuit protector disconnects	17-5, 17-7
dimensions and shipping weights	7-81	NEMA style	16-46
electrical accessories	7-49	application data	16-56
I-Line™	9-59	control transformers	16-57
locking devices	7-52	dimensions	16-58
mechanical lugs	7-54	fusible	16-47, 16-49
Micrologic™ trip units	7-60	interlocks	16-57
phase barriers	7-57	MCP circuit breaker	16-51
power distribution connectors (PDC)	7-56	non-fusible	16-48
terminal pad kits	7-57	thermal magnetic circuit breaker	16-54–16-55
<b>circuit breakers, QO/QOB miniature</b>		NEMA style oversized enclosure MCP circuit breaker	16-52
accessories	1-8, 7-15	<b>commercial multi-metering</b>	<b>11-5</b>
ring terminals	1-4, 7-12	<b>commercial multi-metering switchboards</b>	<b>11-5</b>
wire sizes	1-4, 7-12	<b>communications</b>	
<b>circuit breakers, QO™ miniature</b>	<b>1-3, 7-11</b>	Com'X 510 data logger	4-26
dimensions and shipping weights	7-80	Com'X 510 energy server	4-26
non-automatic switches	1-7, 7-14	ethernet gateways	4-27
QO-CAFI combination arc-fault	1-5, 7-13	<b>compact general duty</b>	<b>21-28</b>
QO-DF dual function	1-5, 7-13	<b>compact general duty limit switches</b>	<b>21-28</b>
QO-EPD/EPE	1-6, 7-13	<b>compact height switches</b>	<b>11-12</b>
QO-GFI ground fault circuit interrupter	1-5, 7-13	<b>compact height switches MiniBreak</b>	<b>11-12</b>
QO-HID high intensity discharge	1-6, 7-14	<b>compact pilot lights</b>	
QO-HM high magnetic trip	1-7, 7-14	Type J	19-11
QO-K key operated	1-6, 7-14	Type XVL miniature LED	19-10
QO-SWN switch neutral common trip	1-6, 7-14	<b>compact vacuum circuit breaker switchgear</b>	<b>11-14</b>
QOT tandem and replacement tandem	1-4, 7-12	<b>Compac™ 6</b>	
<b>circuit breakers PowerPact™ J-frame</b>		combination starters with MCP disconnects	17-7
500 Vdc	7-43	fusible switch disconnects	17-7
<b>circuit isolating switches</b>	<b>24-20</b>	Model 6 MCC	17-7
<b>circuit monitors, PowerLogic™ CM4000T</b>	<b>4-9</b>	<b>complete devices</b>	
		XB4 22 mm push buttons	19-24, 19-26

XB5 22 mm push buttons	19-43	contactors, non-reversing	18-7
XB6 16 mm push buttons	19-12	contactors, reversing	18-9
<b>complete switches</b>	<b>21-14, 21-28</b>	non-reversing	18-7
<b>complete switches, limit switches</b>	<b>21-14</b>	repair parts	18-52, 18-55
<b>component carriers</b>	<b>24-5, 24-10, 24-15</b>	replacement parts	18-55
<b>compression lugs, PowerPact™</b>	<b>7-55</b>	reversing	18-9
<b>compressor pressure switches</b>	<b>22-23</b>	TeSys F	18-10, 18-15
<b>connected products</b>		accessories	16-18, 18-13, 18-15, 18-19–18-20, 18-57
human machine interface (HMI), Magelis™	27-6, 27-8–27-9	contactors, non-reversing	18-10
<b>connected products, EcoStruxure™</b>	<b>29-2</b>	contactors, reversing	18-10
AC drives, Altivar™	26-2–26-6, 26-9	non-reversing	18-10
circuit breakers		repair parts	18-54, 18-56
Masterpact™ MTZ	7-64	replacement parts	18-56
PowerPact™	7-29	reversing	18-10
data logger, Com'X	4-26, 7-77–7-78	TeSys K	18-2, 18-13
energy server, Com'X	4-26, 7-77–7-78	<b>contactors and accessories</b>	<b>18-13</b>
for EcoStruxure™ Building	29-4	<b>contactors, capacitor</b>	<b>18-9</b>
for EcoStruxure™ Grid	29-7	<b>contactors, non-reversing</b>	<b>18-6–18-7, 18-10</b>
for EcoStruxure™ IT	29-5	<b>contactors, reversing</b>	<b>18-6, 18-9–18-10, 18-18</b>
for EcoStruxure™ Machine	29-6	<b>contactors, TeSys D</b>	<b>16-18, 16-20, 18-13, 18-16, 18-21</b>
for EcoStruxure™ Plant	29-6	<b>contactors, TeSys F</b>	<b>16-18, 18-13, 18-19–18-20, 18-57</b>
for EcoStruxure™ Power interface	29-3	<b>control and measurement relays</b>	<b>23-111</b>
Enerlin'X system	7-75–7-76	<b>control circuit fuse holder</b>	<b>16-130</b>
machine safety, Preventa™	25-2–25-3, 25-5–25-7	contactors	16-130
meters, PowerLogic™ energy and power management	4-2	starters	16-130
motors, Lexium motion control	27-20–27-21	<b>control relays</b>	
programmable automation controllers, PacDrive	27-21	NEMA style, AC	23-94
relays, Easergy™ MiCOM protection	5-16	NEMA style, DC	23-96
remote terminal unit (RTU), Easergy™ T300	5-32	TeSys D IEC style	23-87
robotics	27-21	TeSys K IEC style	23-90
sensors	20-2–20-12	TeSys SK IEC style	23-93
switchboards/switchgear	11-2–11-3, 11-10–11-11	<b>control stations</b>	
switchgear, Premset™ circuit breaker	11-14	9001KY and 9001SKY	19-113
<b>connection components</b>	<b>21-17</b>	point of purchase blister packs	19-114
<b>connection components, limit switches</b>	<b>21-17</b>	Type 9001KY and 9001SKY	19-112
<b>ConneXium ethernet products</b>	<b>27-17</b>	Type B standard duty replacement parts	19-111
<b>construction sites</b>	<b>1-44</b>	Type XAL 22 mm	19-107
<b>consulting services</b>	<b>29-8</b>	<b>control stations and enclosures</b>	
<b>contact adder decks</b>	<b>23-90</b>	9001B standard duty	19-110
<b>contact assemblies</b>	<b>21-17</b>	<b>control transformers</b>	<b>16-57</b>
<b>contact assemblies, limit switches</b>	<b>21-17</b>	<b>control unit, TeSys U</b>	<b>18-22</b>
<b>contact blocks</b>		<b>convertable field-installable kits</b>	<b>1-23</b>
"H" numbers for Type K, SK, and KX	19-93	<b>converters</b>	
hermetically sealed logic reed	19-92	for optimum Pt100 probes	23-118
hermetically sealed power reed	19-92	for Type J and K thermocouples	23-118
TeSys D and F	16-18, 18-14	for universal Pt100 probes	23-118
Type KA	19-90	universal voltage/current	23-118
Type KX push buttons (square)	19-104	<b>convertible main lugs kits</b>	<b>1-10</b>
XAC pendant station	19-133	<b>cooling units for enclosures</b>	<b>28-3, 28-10</b>
<b>contact units for melting alloy overload relays</b>	<b>16-126</b>	<b>corrosion resistant</b>	
<b>contact units, melting alloy</b>	<b>16-126</b>	pilot lights	19-88
<b>contactless RFID safety sensors</b>	<b>25-7</b>	Type SK multifunction operators	19-89
<b>contactors</b>	<b>16-89, 16-92, 16-125, 16-127, 16-129–16-130</b>	<b>cover viewing window for safety switches</b>	<b>3-20</b>
accessories	16-127, 18-15	<b>cover-mounted control units</b>	<b>16-127</b>
contactors, TeSys F	18-57	contactors	16-127
TeSys D	16-20, 18-16	starters	16-127
TeSys F	18-57	<b>covers, panelboard-style for riser panels</b>	<b>1-16</b>
coil suppressor, TeSys D	16-20, 18-16	<b>Crouse-Hinds Arktite receptacle safety switches</b>	<b>3-14</b>
control circuit fuse holder	16-130	<b>Crouse-Hinds Style 2 Hubbellock receptacle</b>	<b>3-14</b>
cover-mounted control units	16-127	<b>CSED combination service entrance devices</b>	
definite purpose	16-89	accessories and hubs	1-37
power pole adders	16-129	circuit breakers	1-36
replacement parts kits	16-125	dimensions	1-38
reversing hoist	16-99	Homeline solar ready plug-on neutral	1-40
TeSys D	18-6, 18-15	knockouts	1-38
accessories	16-18, 16-20, 18-13, 18-15–18-16, 18-21	meter mains and all-in-ones	1-34–1-35, 1-39
capacitor	18-9	rainproof meter mains	1-32
contactors, capacitor	18-9	<b>current measurement relays</b>	
		Zelio RM17JC	23-111

Zelio RM35JA	23-111	TeSys GV manual starters and protectors	18-77, 18-79
<b>current ratings</b>		TeSys K	18-74
limit switches	21-5	TeSys U	18-75–18-76
<b>current transformers</b>		TeSys™ N	16-23
round split-core	4-42	Well-Guard	
selection, VarSet	4-40	pump panels	16-95
solid-core	4-22	XML international	22-15
split-core	4-22	XML international pressure switches	22-15
<b>current-limiting</b>	<b>7-35</b>	XMLK electronic	22-10
<hr/>			
<b>D</b>		<b>DIN/E HVL</b>	<b>11-26</b>
<b>dc circuit breakers</b>	<b>7-25</b>	<b>disconnect switches</b>	
<b>DC circuit breakers</b>		flange mounted and cable operated	8-32
Multi 9™	7-25	LK4 nonfusible and GS2 fusible	8-24
<b>DC power supplies</b>	<b>23-117</b>	photovoltaic	3-34
<b>definite purpose</b>	<b>16-89</b>	<b>disconnects</b>	<b>14-19</b>
contactors	16-89, 16-92	<b>disconnects, transformers</b>	<b>14-19</b>
reversing hoist	16-99	<b>distribution blocks</b>	<b>24-26–24-27</b>
<b>detuned capacitor banks</b>	<b>4-39</b>	<b>distribution section</b>	<b>11-35</b>
<b>DF fuseholders</b>	<b>24-29</b>	<b>double throw safety switches</b>	<b>3-26</b>
<b>differential pressure switches</b>	<b>22-18</b>	200–600 A Types 82,000 and 200 A DTU (Series E, A)	3-25
<b>dimensions</b>	<b>16-102, 16-114, 16-117, 18-75</b>	240 V NEMA Type 1 and 3R	3-26
9012G	22-20	30 (Series T4)	3-25
Altistart™ U01 soft starters	18-76	30–100 A Types DT, DTU (Series F)	3-25
circuit breaker		600 V NEMA Type 1, 3R, 4, 4X, 5, and 12	3-27
ED, EG, EJ, and GJ	7-81	accessories	3-28
Multi 9™ C60	7-80	application data	3-30
PowerPact™ B-, H, J, and L-frame	7-81	fusible and non-fusible	3-25
PowerPact™ M-, P, and R-frame	7-81	Series A, E, and T4 dimensions	3-33
Q-frame, FAL/FHL, LAL/LHL/Q4L	7-80	Series F 30–100 A dimensions	3-32
QO/QOB	7-80	situations requiring fuses	3-30
QOU and QYU	7-80	terminal lug data	3-31
CSED combination service entrance devices	1-38	<b>DPDT Models</b>	
CSED, Homeline solar-ready PoN	1-40	4PDT Models	23-14
current transformers, round split-core	4-42	<b>drives</b>	
definite purpose		Altivar™ 12	26-2, 26-12
contactors	16-92	Altivar™ 1260 medium voltage	26-9
disconnect switch, photovoltaic	3-34	Altivar™ 212	26-10
duplex motor controllers	16-98	Altivar™ 212 AC drives	26-6
EMA Type 4, 4X, 5, 12, 12K circuit breaker enclosures	7-86	Altivar™ 312	26-2, 26-13
enclosed molded case switch	2-24	Altivar™ 320	26-3, 26-15
enclosures	16-114, 16-117	Altivar™ 340	26-4, 26-17
enclosures, QO and Homeline	1-28	Altivar™ 61	26-18
enclosures, QO and Homeline rainproof	1-30	Altivar™ 61 AC drives	26-6
for double throw safety switches, Series A, E, and T4	3-33	Altivar™ 660/960 process drive systems	26-9
for double throw safety switches, Series F	3-32	Altivar™ 680/980 process drive systems	26-9
for high density metering cabinets	4-33	Altivar™ 71	26-19–26-20
for NEMA Type 1 and 3R heavy duty switches	3-22	Altivar™ 71 AC drives	26-5
for NEMA Type 4, 4X, 5, 7, 9 and 12 heavy duty switches	3-23	Altivar™ Process 600	26-6
general duty safety switches	3-7	Altivar™ Process 630	26-24
lighting contactors	16-82–16-87	Altivar™ Process 650	26-24
meter centers	2-8, 2-22	Altivar™ Process 900	26-5
meter mains and all-in-ones	1-39	Altivar™ Process 930	26-25
meter sockets	2-4	enclosed	
NEMA 1 general purpose enclosure	16-6	Altistart™ 22 soft starters	26-8
NEMA 1 general purpose enclosures (flush mount)	16-6	Altistart™ 48 soft starters	26-8
NEMA 4 watertight die cast zinc enclosure	16-6	S-Flex (Altivar™ 212)	26-27
NEMA Type 1, 3R, 7, 9 circuit breaker enclosures	7-86	S-Flex™ (Altivar™ 212)	26-8
pressure switches		North American drive systems	
9012G	22-20	Altivar™ 1260 medium voltage	26-9
dimensions		Altivar™ 660/960 process drive systems	26-9
9012G	22-20	Altivar™ 680/980 process drive systems	26-9
XMLK electronic	22-10	outdoor Altivar™ 630/930	26-10
XML international	22-15	<b>dry type medium voltage transformers</b>	<b>14-21–14-22</b>
XMLK electronic	22-10	<b>dual function miniature circuit breaker, QO-DF</b>	<b>1-5, 7-13</b>
TeSys D	18-60–18-61, 18-64, 18-66, 18-68, 18-71	<b>dual stage pressure switches</b>	<b>22-18</b>
TeSys F	18-62, 18-70	<b>duplex</b>	<b>16-96–16-97</b>
		motor controllers	16-96–16-97
		<b>duplex motor controllers</b>	<b>16-98</b>
		<b>DVCAS</b>	<b>11-30</b>

<b>DVCAS switchgear</b>	<b>11-30</b>
<b>DZ5 cable ends</b>	<b>24-30</b>

**E**

<b>Easergy™ T300 RTUs</b>	<b>5-32</b>
communication gateway, HU250	5-33
power supplies	5-34
switch controller, SC150	5-33
transformer monitor, LV150	5-33
<b>EBA (external brick assembly) SPDs</b>	<b>6-3</b>
replacement modules	6-3
<b>ECOFIT 50/51 protection relays</b>	<b>5-2, 5-4</b>
<b>EcoStruxure™</b>	
apps, analytics, & services	29-3–29-7
EcoStruxure™ Machine Expert	27-3
Power Monitoring Expert software	4-4
PowerSCADA Operation software	4-6
connected products	29-3–29-7
AC drives, Altivar™	26-2–26-6, 26-9
circuit breakers, Masterpact™ MTZ	7-64
circuit breakers, PowerPact™	7-29
data logger, Com'X	4-26, 7-77–7-78
energy server, Com'X	4-26, 7-77–7-78
human machine interface (HMI), Magelis™	27-6, 27-8–27-9
interface, Enerlin'X for Micrologic™	7-75–7-76
machine safety, Preventa™	25-2–25-3, 25-5–25-7
meters, PowerLogic™ energy and power management	4-2
motors, Lexium motion control	27-20–27-21
programmable automation controllers, PacDrive	27-21
relays, Easergy™ MiCOM protection	5-16
remote terminal units (RTU), Easergy™ T300	5-32
robotics	27-21
sensors	20-2–20-12
switchboards/switchgear	11-2–11-3, 11-10–11-11
switchgear, Premset™ circuit breaker	11-14
edge control	29-3–29-7
PCs, industrial / box, Magelis™	27-11–27-13
PLC / PAC, Modicon™	27-2
IoT-enabled Architecture and Platform	29-2
<b>EcoStruxure™ Building</b>	<b>29-4</b>
<b>EcoStruxure™ Grid</b>	<b>29-7</b>
<b>EcoStruxure™ IT</b>	<b>29-5</b>
<b>EcoStruxure™ Machine</b>	<b>29-6</b>
<b>EcoStruxure™ Plant</b>	<b>29-6</b>
<b>EcoStruxure™ Power</b>	<b>29-3</b>
<b>EcoStruxure™ services</b>	<b>29-8</b>
<b>EDB, EGB, and EJB circuit breakers</b>	<b>9-28</b>
<b>edge control, EcoStruxure™</b>	<b>29-2</b>
for EcoStruxure™ Building	29-4
for EcoStruxure™ Grid	29-7
for EcoStruxure™ IT	29-5
for EcoStruxure™ Machine	29-6
for EcoStruxure™ Plant	29-6
for EcoStruxure™ Power	29-3
PCs, industrial / box, Magelis™	27-11–27-13
<b>EE medium voltage dry type transformers</b>	<b>14-21</b>
<b>electrical components</b>	<b>19-35, 19-55</b>
XB4	19-35
XB5	19-55
<b>electrical interlock kits</b>	<b>3-16</b>
safety switches	3-16
<b>electrical ratings</b>	
pressure switches, 9012 and 9016	22-19
<b>electrode holders</b>	<b>23-114</b>
<b>electromechanical interface modules</b>	<b>23-118</b>
<b>electronic pressure sensors</b>	
XMPE	22-4

XMLG	22-4
XMLK	22-4
XMLP	22-4
XMLR	22-4
<b>electronic timers</b>	<b>16-21, 16-23–16-27, 18-17</b>
TeSys D	16-23–16-27, 18-17
TeSys N	16-21
<b>electronic VAR control, AccuSine PFV+</b>	<b>4-41</b>
<b>EM4900 multi-circuit meters</b>	<b>4-24</b>
<b>EMA (external modular assembly)</b>	<b>6-2</b>
<b>EMA (external modular assembly) SPDs</b>	<b>6-2–6-3</b>
replacement modules	6-3
<b>emergency stop operators</b>	
XB4 22 mm	19-29
XB5 22 mm	19-49
<b>enclosed combination starters</b>	<b>18-46</b>
<b>enclosed drives</b>	
Altistart™ 22 soft starters	26-8
Altistart™ 48 soft starters	26-8
S-Flex (Altivar™ 212)	26-27
S-Flex™ (Altivar™ 212)	26-8
<b>enclosed power distribution blocks</b>	<b>24-26</b>
<b>enclosed starters, TeSys D</b>	<b>18-41, 18-44, 18-46</b>
<b>enclosures</b>	<b>16-111–16-114, 16-117</b>
dimensions	16-114, 16-117
flush mounting selection table	16-112
molded case switch dimensions	2-24
NEMA 1 selection table	16-112
NEMA 12/3R outdoor applications	16-113
NEMA type 1 and flush mounting	16-112
NEMA type 3R, 4, 4X, and 12	16-111
NEMA types 1, 4, and oversize	16-113
rainproof	
knockouts, QO and Homeline	1-30
transformer	14-24
Type XAP	19-108
<b>enclosures, circuit breaker</b>	
accessories	7-85
dimensions	7-86
LA/LH/Q4	7-84
lock-on provisions	2-24
PowerPact™ B-frame NEMA 7, 9	7-84
PowerPact™ H-frame	7-82
PowerPact™ J-frame	7-82
PowerPact™ J-frame NEMA 7, 9	7-84
PowerPact™ L-frame	7-82
PowerPact™ M-frame	7-82
PowerPact™ P-frame	7-82
PowerPact™ Q-frame	7-82
stainless steel front	2-24
<b>enclosures, universal</b>	
ATEX for explosive atmospheres	28-2
ClimaSys™ thermal management system	28-3, 28-9–28-10
IP54 polyester floor-standing	28-8
IP65 polyester floor-standing	28-8
IP66 polyester wall-mounting	28-8
NEMA ratings	28-3
polyester	
floor-standing	28-8
floor-standing open bottom	28-8
floor-standing sealed	28-8
insulated floor-standing	28-2
insulated wall-mounting	28-2
wall-mounting	28-8
Spacial™	
accessories	28-4, 28-6–28-7
floor-standing	28-2, 28-4, 28-6
wall-mounting	28-2, 28-7
stainless steel	

304L	28-2	<b>flange mounted and cable operated</b>	<b>8-32</b>
316L	28-2	<b>flat terminal connectors</b>	<b>24-20</b>
floor-standing	28-2, 28-6	<b>float switches</b>	<b>22-34</b>
wall-mounting	28-2, 28-7	accessories	22-34
steel		renewal parts	22-34
floor-standing	28-4	<b>floor-standing enclosures</b>	<b>28-2, 28-4, 28-6</b>
wall-mounting	28-2, 28-7	<b>flush mounting selection table</b>	<b>16-112</b>
Thalassa™		<b>foot switches, heavy duty industrial</b>	<b>19-139</b>
accessories	28-8	<b>for QO, NQ, and Homeline loadcenters</b>	<b>6-12</b>
floor-standing	28-2, 28-8	<b>fractional horsepower</b>	<b>16-4</b>
wall-mounting	28-2, 28-8	manual starters	16-4
UL ratings	28-3	melting alloy type thermal overload relay	16-4
<b>end clamps</b>		<b>frequency control relays, Zelio RM35HZ</b>	<b>23-114</b>
IEC style	24-18	<b>full voltage contactors</b>	
NEMA style	24-22	NEMA rstyle	
<b>energy efficient transformers</b>		general information	16-29
1,201–15,000 Volts	14-21	NEMA style	
<b>Enerlin'X system for Micrologic</b>	<b>7-75–7-76</b>	3-pole polyphase	16-29
<b>equipment grounding kits for safety switches</b>	<b>3-18</b>	solid state overload relay protection, Motor Logic	16-33
<b>ethernet gateways</b>	<b>4-27</b>	<b>full voltage contactors &amp; starters</b>	<b>16-118</b>
<b>exploded view</b>	<b>21-26</b>	<b>full voltage contactors &amp; starters and solid state overload relays</b>	<b>16-120</b>
<b>external modular assembly (EMA) SPDs</b>	<b>6-2</b>	factory modifications (forms)	16-120
<b>external reset mechanisms</b>	<b>16-110</b>	<b>full voltage contactors and starters</b>	
<b>externally mounted</b>	<b>6-2</b>	factory modifications (forms)	16-118
<b>externally mounted surge protective devices (SPD)</b>	<b>6-2</b>	NEMA style	
<b>extra capacity single phase starters</b>	<b>16-37</b>	application data for selection	16-38
full voltage starters	16-37	NEMA style dimensions	16-42
<b>EZ Meter-Pak™ meter centers</b>		NEMA style enclosure dimensions	16-39–16-41
1Ø 3W 120/240 indoor/rainproof	2-12	<b>full voltage reversing contactors</b>	<b>16-60</b>
3Ø 4W indoor / rainproof	2-15	<b>full voltage reversing contactors and starters</b>	
accessories	2-21	NEMA style	16-60
branch devices	2-10	dimensions	16-64–16-65
configuration	2-10	solid-state overload relay protection Motor Logic	16-62
general information	2-9	<b>full voltage reversing vacuum contactors</b>	
mains devices	2-10	NEMA style approximate dimensions	16-66
mains devices, busway side tap	2-19	<b>full voltage starters</b>	<b>16-33, 16-37</b>
tenant circuit breakers	2-21	2-Pole single phase	16-35–16-36
		4-Pole, 2-Phase	16-35–16-36
		extra capacity single phase starters	16-37
		full voltage starters	16-37
		full voltage starters	
		extra capacity single phase starters	16-37
		NEMA style	16-33
		2-pole single phase	16-37
		Types SBSB with auxiliary load terminals	16-37
		<b>full voltage vacuum contactors</b>	<b>16-43–16-44</b>
		general information	16-43–16-44
		<b>full voltage vacuum starters</b>	<b>16-45</b>
		<b>fuse block</b>	<b>16-132</b>
		<b>fuse block, replacement parts kits</b>	<b>16-132</b>
		<b>fuse blocks</b>	<b>24-20</b>
		<b>fuse kits safety switches, class R</b>	<b>3-16</b>
		<b>fuse pullers</b>	<b>24-20</b>
		<b>fuse selection tables</b>	
		boric acid fuses, HVL	11-27
		DIN/E HVL	11-26
		<b>fused HVL/cc</b>	<b>11-34</b>
		load interrupter switch	11-34
		<b>fuseholders</b>	<b>24-28</b>
		LS1	18-50
		modular	24-29
		TeSys DF	24-29
		Type FB	24-28
		<b>Fusellogic</b>	<b>11-16, 11-22</b>
		<b>fusible</b>	<b>16-47, 16-49</b>
		<b>fusible and non-fusible safety switches</b>	<b>3-25</b>
		<b>fusible disconnect switch type</b>	<b>16-67</b>
		<b>fusible switch disconnects</b>	<b>17-6</b>

**F**

**F-frame**

I-Line™ circuit breakers 9-52–9-53

**factory assembled panelboards**

I-Line™ 9-61  
 NF 9-31  
 NQ feed-through lugs 9-18  
 NQ sub-feed lugs 9-17  
 QMB fusible 9-63

**factory modifications**

machine tool pressure switches 22-21

**factory modifications (forms)** 16-118, 16-120

full voltage contactors & starters 16-118  
 full voltage contactors & starters and solid state overload relays 16-120

**factory-installed accessories**

PowerPact™ circuit breakers 7-49

**fanning strips** 24-22

**fast capacitor banks** 4-39

**FB**

fuseholders 24-28  
 track adapter 24-28

**feed-through lugs**

NQ panelboards 9-18

**fiberglass reinforced polyester enclosures, NEMA Type 4X** 3-12

**field services** 29-8

**Fingersafe™ cover for QOU circuit breaker** 7-19

**fittings** 13-7

trench duct 13-7

## G

<b>gas-insulated</b>	<b>11-28–11-29</b>
<b>GB2 circuit protectors</b>	<b>24-25</b>
<b>GCB circuit protectors</b>	<b>24-24</b>
<b>general</b>	<b>16-133</b>
<b>general duty safety switches</b>	
dimensions	3-7
<b>general information</b>	<b>16-29, 16-43–16-44</b>
full voltage vacuum contactors	16-43–16-44
<b>general purpose (NEMA Type 1)</b>	<b>13-2</b>
wireway	13-2
<b>general purpose dry type transformers</b>	<b>14-3</b>
<b>general purpose plug-in timers</b>	<b>23-109</b>
<b>general purpose relays</b>	<b>23-2, 23-60, 23-66</b>
<b>general thermal unit selection</b>	<b>16-133</b>
<b>GHA</b>	<b>11-28</b>
<b>GHA switchgear</b>	<b>11-28</b>
<b>ground fault</b>	
HOM-GFI	1-18, 7-21
Micrologic™ add-on module (GFM)	7-79
QO-GFI ground fault circuit interrupter	1-5, 7-13
QOB bolt-on GFI	9-14
<b>ground fault circuit interrupter, QO-GFI</b>	<b>1-5, 7-13</b>
<b>GV manual starters and protectors</b>	<b>18-32</b>
<b>GV2P</b>	
pre-assembled kits, with LC1D	18-35

## H

<b>H-frame, PowerPact™</b>	
500 Vdc circuit breakers	7-43
automatic molded case switch	7-44
busway plug-in units, I-Line™	12-12–12-13, 12-15
catalog numbering system	7-29
circuit breakers	7-29, 7-31
compression lugs	7-55
dimensions and shipping weights	7-81
electrical accessories	7-49
enclosures	7-82
I-Line™ circuit breakers	9-54
interrupting ratings	7-31
locking devices	7-52
mechanical lugs	7-54
Micrologic™ trip units	7-59
motor circuit protectors (MCP)	7-46–7-47
motor operators	7-50
motor protector circuit breaker	7-48
motor protector circuit breakers	7-48
plug-in and drawout mounting	7-58
power distribution connectors (PDC)	7-56
rotary handles	7-51
terminal nuts and terminal shields	7-57
termination options	7-31
<b>harmonic mitigation solutions</b>	<b>4-34</b>
<b>hazardous locations, Class 9001</b>	<b>19-92</b>
<b>HCR-U</b>	<b>11-36</b>
<b>HDM (high density metering)</b>	<b>4-33</b>
<b>heads for miniature and compact bodies</b>	<b>21-16</b>
<b>heavy duty</b>	<b>21-32</b>
limit switches	21-38
<b>heavy duty safety switches</b>	<b>3-8</b>
316 grade stainless steel, NEMA Type 3, 3R, 4, 4X, 5, 12	3-12
applications	3-12
fiberglass reinforced polyester enclosures, NEMA Type 4X	3-12
NEMA Type 4, 4X, 5, 7, 9 and 12 dimensions	3-23
<b>high ampere QOU circuit breakers</b>	<b>7-18</b>

<b>high density metering (HDM)</b>	<b>4-33</b>
<b>high intensity discharge circuit breaker QO-HID</b>	<b>1-6, 7-14</b>
<b>HMI products</b>	<b>27-6</b>
advanced panels, Magelis™	27-8
handheld, Magelis™ XBTGH	27-9
optimized panels, Magelis™ GTO	27-8
small controllers, Magelis™ SCU	27-8
small panels, Magelis™ XBT-, STO, STU	27-6
universal panels, Magelis™ GTU	27-9
<b>HMIGTO</b>	<b>27-8–27-9</b>
<b>HMIhuman machine interface</b>	<b>16-105</b>
<b>Homeline load centers</b>	
convertable field-installable kits	1-23
indoor, main circuit breaker	1-21
indoor, main lugs	1-21
plug-on circuit breakers	1-18, 7-20
<b>Homeline miniature circuit breaker</b>	<b>1-20</b>
<b>Homeline miniature circuit breaker accessories</b>	<b>1-20</b>
<b>Homeline™</b>	
surge protective devices (SPD)	1-27, 6-12
<b>Homeline™ load centers</b>	
manufactured housing load centers	1-11
<b>Homeline™ plug-on circuit breakers</b>	<b>1-18, 7-4, 7-20</b>
combination arc-fault circuit interrupter HOM-CAFI	1-18, 7-20
dual function arc-fault circuit interrupter HOM-DF	1-19, 7-20
equipment protection device HOM-EPD	1-19, 7-21
ground-fault circuit interrupter HOM-GFI	1-18, 7-21
high magnetic HOM-HM	1-18, 7-20
tandem and quad tandem HOMT	1-19, 7-21
wire sizes	1-20, 7-22
<b>horizontal ganged meter sockets</b>	<b>2-3</b>
<b>horsepower and voltage</b>	<b>16-137</b>
<b>horsepower and voltage thermal unit selection</b>	<b>16-137</b>
<b>Hubbellock receptacle safety switches</b>	<b>3-15</b>
<b>hubs</b>	
bolt-on for QO and Homeline load centers	1-30
<b>hubs for CSEDs</b>	<b>1-37</b>
<b>HVL</b>	<b>11-22</b>
<b>HVL medium voltage metal-enclosed</b>	<b>11-22</b>
<b>HVL metal-enclosed load interrupter switchgear</b>	<b>11-22</b>
<b>HVL switches, Power-Dry, Power-Cast, transformer connections</b>	<b>11-24</b>
<b>HVL switchgear quick ship program</b>	<b>11-23</b>
<b>HVL/cc</b>	
medium voltage metal-enclosed switchgear	11-15
metal-enclosed load interrupter switchgear	11-15
switchgear	11-17
switchgear quick ship program	11-17
<b>hybrid VAR compensator (HVC)</b>	<b>4-44</b>

## I

<b>I-Line</b>	
SurgeLogic™ SPD units	6-5
<b>I-Line distribution</b>	<b>11-34</b>
<b>I-Line distribution bus</b>	<b>11-6</b>
<b>I-Line distribution section</b>	<b>11-8</b>
<b>I-Line™ busway</b>	
standard components and accessories	12-6
<b>I-Line™ II busway</b>	
electrical data	12-10
plug-in units	
fusible	12-10
PowerPact™ H- and J-frame	12-12–12-13, 12-15
PowerPact™ L-frame	12-14–12-15
PowerPact™ M-frame	12-15
PowerPact™ P-frame	12-16
PowerPact™ R-frame	12-17

straight lengths, fittings, and accessories	12-7, 12-9–12-10	<b>integrated power center</b>	<b>10-6</b>
surge protective device (SPD) plug-in units	12-11	submetering	10-7
<b>I-Line™ panelboards</b>		<b>integrated power center 2</b>	<b>10-8</b>
F-frame circuit breakers	9-52–9-53	layout, pricing, lead time	10-8
factory assembled	9-61	shipping	10-8
LA circuit breakers	9-57	<b>Integrated Power Center 2</b>	<b>10-7</b>
merchandised accessories	9-48	IPC2	10-7
merchandised combo, interior boxes and fronts	9-43	<b>integrated power center 2 transformer combo</b>	<b>10-8</b>
merchandised types HCM, HCP-SU, HCR-U	9-44	<b>integrated power center 2, IPC2</b>	<b>10-2</b>
PowerPact™ B-frame circuit breakers	9-51	<b>Integrated Power Center,</b>	<b>10-2</b>
PowerPact™ H-frame circuit breakers	9-54	<b>integrated power center, IPC</b>	<b>10-6</b>
PowerPact™ J-frame circuit breakers	9-54	layout, lead time, pricing	10-7
PowerPact™ J-frame mission critical	9-56	shipping	10-7
PowerPact™ L- and M-frame circuit breakers	9-57	<b>interface modules</b>	<b>16-21, 16-23–16-27, 18-17, 23-118</b>
PowerPact™ L-frame mission critical	9-56	analog	23-118
PowerPact™ P- and R-frame circuit breakers	9-59	electromechanical	23-118
PowerPact™ Q-frame circuit breakers	9-53	solid-state	23-118
series ratings	9-6, 9-9	TeSys D	16-23–16-27, 18-17
terminal data	9-65	TeSys N	16-21
<b>I-Line™ to I-Line™ II adapter</b>	<b>12-9</b>	<b>interface relays</b>	
<b>IEC control relays</b>	<b>23-87, 23-90, 23-93</b>	Zelio RSB	23-3
<b>IEC style disconnect switches</b>		Zelio RSL	23-2
LK4 nonfusible and GS2 fusible	8-24	Zelio RXG	23-4
<b>iEM3000 energy meters</b>	<b>4-17</b>	<b>interlocks</b>	<b>16-57</b>
<b>IG2000 Series</b>	<b>15-3</b>	<b>internal barrier kits for safety switches</b>	<b>3-16</b>
<b>IG2000CBM</b>	<b>15-3</b>	<b>internally mounted, new construction and retrofit</b>	<b>6-4</b>
<b>IG2000P</b>	<b>15-3</b>	<b>interrupting ratings</b>	<b>7-35</b>
<b>illuminated operators</b>	<b>19-33, 19-53</b>	<b>ION power and energy meters</b>	<b>4-7</b>
22 mm push buttons	19-33, 19-53	<b>IoT, EcoStruxure™ architecture &amp; platform</b>	<b>29-2</b>
<b>indoor load centers</b>		<b>IP54 polyester floor-standing enclosures</b>	<b>28-8</b>
dimensions	1-28	<b>IP65 polyester floor-standing enclosures</b>	<b>28-8</b>
knockouts	1-28	<b>IP66 polyester wall-mounting enclosures</b>	<b>28-8</b>
rainproof knockouts	1-30	<b>IPaCS equipment</b>	<b>10-2</b>
<b>indoor main circuit breakers</b>		integrated power and control solutions	10-2
1Ø, QO plug-on neutral CAFI load center	1-10	<b>IPC, integrated power center</b>	<b>10-6</b>
1Ø3W, QO load centers	1-9	<b>IPC, Integrated Power Center</b>	<b>10-2</b>
3Ø4W and 3Ø4W, QO load centers	1-17	<b>IPC2</b>	<b>10-7</b>
convertible QOM1 kits	1-10, 1-22	Integrated Power Center 2	10-7
<b>indoor main lugs</b>		transformer combo	10-3
1Ø, QO plug-on neutral CAFI load center	1-10	<b>IPC2, integrated power center 2</b>	<b>10-2</b>
QO load centers 3Ø4W and 3Ø4W	1-17	<b>Iso-Gard</b>	<b>15-2</b>
<b>indoor meter centers</b>	<b>2-15</b>	line isolation monitor	15-2
<b>indoor, main circuit breaker</b>	<b>1-21</b>	<b>Iso-gard LIM</b>	<b>15-2</b>
<b>indoor, main lugs</b>	<b>1-21</b>	<b>isolated alarm contacts</b>	<b>16-130</b>
<b>indoor, main lugs, Homeline load centers</b>	<b>1-21</b>	melting alloy overload relays	16-130
<b>inductive proximity sensors</b>	<b>20-6</b>	<b>isolated power panels</b>	<b>15-2, 15-4</b>
accessories	20-9	<b>isolated power panels medical products</b>	<b>15-4</b>
OsiSense XS	20-5, 20-7–20-8		
<b>industrial control transformers</b>	<b>14-14</b>		
<b>industrial energy efficiency</b>	<b>4-28</b>		
<b>industrial format</b>	<b>21-30</b>		
<b>industrial format limit switches</b>	<b>21-30</b>		
<b>industrial limit switches</b>	<b>21-38</b>		
<b>industrial pressure switches</b>	<b>22-16</b>		
<b>industrial relays</b>	<b>23-87, 23-94</b>		
IEC style	23-87, 23-90, 23-93		
NEMA style	23-94		
<b>industrial snap</b>	<b>21-6</b>		
<b>industrial snap switches</b>	<b>21-6</b>		
<b>Insta-Kits accessories for enclosed combination starter</b>	<b>18-46</b>		
<b>insulated enclosures and boxes</b>	<b>28-2</b>		
<b>insulated groundable neutral assembly</b>	<b>7-85</b>		
<b>integral horsepower</b>	<b>16-8</b>		
manual starters	16-8		
<b>integrated facility management services</b>	<b>29-8</b>		
<b>integrated power and control solutions</b>			
IPaCS equipment	10-2		
power solutions integrated equipment			
overview	10-2		

**J**

<b>J-frame, PowerPact™</b>			
500 Vdc circuit breakers			7-43
automatic molded case switch			7-44
busway plug-in units, I-Line™	12-12–12-13, 12-15		
catalog numbering system			7-29
circuit breakers			7-29, 7-31
compression lugs			7-55
dimensions and shipping weights			7-81
electrical accessories			7-49
enclosures			7-82
I-Line™ circuit breakers			9-54
interrupting ratings			7-31
locking devices			7-52
mechanical lugs			7-54
Micrologic™ trip units			7-59
mission critical circuit breakers			7-42, 9-56
motor circuit protectors (MCP)			7-46–7-47
motor operators			7-50

motor protector circuit breaker	7-48
plug-in and drawout mounting	7-58
power distribution connectors (PDC)	7-56
rotary handles	7-51
terminal nuts and terminal shields	7-57
termination options	7-31
<b>jumper strap kit, melting alloy</b>	<b>16-126</b>
<b>jumpers</b>	<b>24-22</b>

**K**

<b>key interlock systems</b>	<b>2-25</b>
ordering	2-25
<b>key interlock systems for safety switches</b>	<b>3-19</b>
<b>key operated circuit breaker, QO-K</b>	<b>1-6, 7-14</b>
<b>knockouts</b>	
CSED combination service entrance devices	1-38
CSED, Homeline solar-ready PoN	1-40
enclosures, QO and Homeline	1-28
enclosures, QO and Homeline rainproof	1-30
meter centers, MP Meter-Pak™	2-8
meter mains and all-in-ones	1-39
meter sockets	2-4
<b>Krydon enclosures, NEMA Type 4X</b>	<b>3-13</b>

**L**

<b>L-frame</b>	
400 A	
thermal-magnetic	7-35
<b>L-frame, PowerPact™</b>	
500 Vdc circuit breakers	7-43
automatic molded case switch	7-44
bus bar connections	7-57
busway plug-in units, I-Line™	12-14–12-15
catalog numbering system	7-29
circuit breakers	7-29, 7-36
compression lugs	7-55
dimensions and shipping weights	7-81
electrical accessories	7-49
enclosures	7-82
I-Line™ circuit breakers	9-57
interrupting ratings	7-36
locking devices	7-52
mechanical lugs	7-54
Micrologic™ trip units	7-59
mission critical circuit breakers	7-42, 9-56
motor operators	7-50
motor protector circuit breaker	7-48
motor protector circuit breakers	7-48
plug-in and drawout mounting	7-58
power distribution connectors (PDC)	7-56
rotary handles	7-51
terminal shields	7-57
termination options	7-36
<b>L-L enhanced (L-L) SPDs</b>	<b>6-3</b>
<b>L-L enhanced MA (L-N, L-G) SPDs</b>	<b>6-3</b>
<b>LA circuit breakers</b>	<b>9-57</b>
<b>LA/LH</b>	
500 A	
current-limiting	7-35
<b>LA/LH-frame</b>	
400 A	
thermal-magnetic	7-35
<b>LAL adjustable instantaneous-trip circuit breaker</b>	<b>7-48</b>
<b>latching relays</b>	
NEMA style, AC	23-94

NEMA style, DC	23-96
<b>LB distribution blocks</b>	<b>24-27</b>
<b>LC1D</b>	
pre-assembled kits, with GV2P	18-35
<b>legend holders and inserts</b>	
30 mm push buttons, Types K and SK	19-94
Type KX push buttons (square)	19-105
XAC pendant stations	19-134
XB4 22 mm push buttons	19-38–19-39
XB5 22 mm push buttons	19-58–19-59
XB6 16 mm push buttons	19-20
<b>legend sheets</b>	
XB4 22 mm push buttons	19-39
<b>level control relays, Zelio RM35L***MW</b>	<b>23-114</b>
<b>levers for miniature and compact bodies</b>	<b>21-16</b>
<b>Lexium motion control</b>	<b>27-20–27-21</b>
<b>light curtains</b>	
XUSL Type 2	25-5
XUSL Type 4	25-5
XUSL2E	25-5
XUSL4E	25-5
XUSLM4	25-5
<b>light modules, standard and shallow depth</b>	<b>19-91</b>
<b>lighting contactor</b>	
multipole lighting	16-74
<b>lighting contactors</b>	<b>16-74–16-75, 16-77, 16-79–16-81</b>
combination	16-77
dimensions	16-82–16-87
mechanically held ASCO Type 920	9-64
modifications	16-79–16-81
<b>limit switches</b>	<b>21-4–21-5, 21-8, 21-32, 21-43</b>
application data	21-4
bodies	21-17
compact general duty	21-28
complete switches	21-14
connection components	21-17
contact assemblies	21-17
heads for miniature and compact bodies	21-16
heavy duty	21-32, 21-38
industrial	21-38
industrial format	21-30
industrial snap	21-6
levers for miniature and compact bodies	21-16
mill and foundry	21-43
miniature	21-8, 21-10
modular	21-10, 21-12
oiltight	21-43
selection	21-8
severe duty	21-43
specifications	21-8
standard, classic	21-26
without enclosures	21-6
XCK	21-12
XCKJ	
bodies and options	21-33
operating heads	21-34
operating heads, replacement parts, and levers	21-35
precision switches with direct acting contacts	21-32
XCKL	
complete switches	21-28
XCKL, XCKM	21-26
XCMD	21-10
<b>line isolation monitor</b>	<b>15-2</b>
Iso-Gard	15-2
<b>Line Isolation Monitor</b>	<b>15-2–15-3</b>
<b>Linergy</b>	
labeling system	24-17
marking accessories	24-16



<b>Link150 Ethernet gateway</b>	<b>4-27</b>	<b>Magelis XBT N/R small panels</b>	<b>27-6</b>
<b>Linnk150</b>		<b>magnetic coils</b>	<b>16-123</b>
ethernet gateways	4-27	<b>main circuit breaker kits</b>	<b>1-10, 1-22</b>
<b>LK4 nonfusable and GS2 fusible</b>	<b>8-24</b>	<b>main circuit breaker, 1Ø3W indoor</b>	<b>1-9</b>
<b>load centers</b>	<b>1-9, 1-14–1-15, 1-17</b>	<b>main circuit breaker, 1Ø3W rainproof</b>	<b>1-14–1-15</b>
main circuit breaker kits, 1Ø	1-10, 1-22	<b>main circuit breaker, 3Ø4W and 3Ø4W indoor</b>	<b>1-17</b>
main lugs, 3Ø4W and 3Ø4W	1-17	<b>main circuit breaker, 3Ø4W and 3Ø4W rainproof</b>	<b>1-17</b>
QO PoN CAFI	1-10	<b>main circuit breakers</b>	
<b>load centers value pack</b>	<b>1-25</b>	1Ø, QO plug-on neutral CAFI load center	1-10
<b>load centers value pack, QO and Homeline load centers</b>	<b>1-25</b>	1Ø3W, QO load centers, indoor	1-9
<b>load interrupter switch</b>	<b>11-34</b>	1Ø3W, QO load centers, rainproof	1-14–1-15
fused HVL/cc	11-34	3Ø4W and 3Ø4W, QO load centers, indoor	1-17
<b>load interrupter switchgear</b>	<b>11-22</b>	3Ø4W and 3Ø4W, QO load centers, rainproof	1-17
<b>lock-on provisions</b>		kits for convertible QOM1 load centers	1-10, 1-22
circuit breaker enclosure	2-24	<b>main devices, meter centers</b>	<b>2-15</b>
<b>lock-on provisions for safety switches</b>	<b>3-19</b>	<b>main lugs</b>	
<b>low voltage switchgear</b>	<b>11-10</b>	QO load centers 3Ø4W and 3Ø4W	1-17
arc resistant	11-11	QO PoN CAFI	1-10
Power-Zone	11-10–11-11	<b>manual and magnetic contactors and starters</b>	<b>16-128</b>
<b>LS1</b>	<b>18-50</b>	auxiliary contacts	16-128
<b>LS1 fuseholders</b>	<b>18-50</b>	<b>manual starters</b>	<b>16-4, 16-8–16-9</b>
<b>LTMCU compact display</b>	<b>16-105</b>	accessories and modification kits	16-9
<b>LTME expansion module</b>	<b>16-105</b>	dimensions for open type	16-6
<b>LTMR controller</b>	<b>16-104</b>	fractional horsepower	16-4
<b>lug kits</b>	<b>3-20</b>	melting alloy type thermal overload relay	16-4
<b>lug-lug</b>	<b>10-7</b>	integral horsepower	16-8
<b>lug-lug tap box</b>	<b>10-7</b>	integral horsepower dimensions	16-10
<b>lugs</b>		manual switches	
kits, 1Ø field-installed main	1-10	dimensions for open type	16-6
main, QO load centers 3Ø4W and 3Ø4W	1-17	NEMA 1 general purpose enclosure dimensions	16-6
main, QO PoN CAFI load centers 1Ø	1-10	NEMA 1 general purpose enclosure dimensions	16-6
safety switches	3-20	reversing and two speed	16-9
		watertight die cast zinc enclosure dimensions	16-6
		<b>manual starters and switches</b>	<b>16-11</b>
		accessories and modifications	16-11
		<b>manual switches</b>	<b>16-5</b>
		non-reversing	16-5
		reversing	16-5
		two speed	16-5
		watertight die cast zinc enclosure dimensions	16-6
		<b>manufactured housing load centers</b>	<b>1-11</b>
		<b>marking accessories for terminal blocks</b>	
		IEC style	24-16–24-17
		NEMA style	24-23
		<b>master relays, NEMA style, AC</b>	<b>23-94</b>
		<b>Masterclad</b>	<b>11-32</b>
		medium voltage Metalclad switchgear	11-32
		Metalclad Arc Terminator	
		Metalclad Arc Resistant	11-33
		<b>Masterpact™</b>	
		MTZ circuit breakers	7-9, 7-64
		selection guide	7-9
		NT/NW circuit breakers	7-10, 7-73
		ratings	7-73
		remote racking	7-73
		selection guide	7-10
		switchboard/switchgear	11-2–11-3, 11-10–11-11
		trip units, Micrologic™	11-11
		<b>MCP circuit breaker</b>	<b>16-51, 16-69</b>
		<b>mechanical alternators</b>	<b>22-32–22-33</b>
		<b>mechanical interlock accessories</b>	<b>16-131</b>
		<b>mechanical interlocks</b>	<b>16-131</b>
		<b>mechanical latch blocks</b>	<b>23-88</b>
		<b>mechanical lugs, PowerPact™</b>	<b>7-54</b>
		<b>medical products</b>	
		isolated power panels	15-4
		<b>medium voltage metal-enclosed</b>	
		CBGS-0	11-29
		DVCAS	11-30

**M**

<b>M-frame, PowerPact™</b>	
bus bar connections	7-57
busway plug-in units, I-Line™	12-15
catalog numbering system	7-29
circuit breakers	7-29, 7-38
compression lugs	7-55
dimensions and shipping weights	7-81
electrical accessories	7-49
enclosures	7-82
I-Line™ circuit breakers	9-57
interrupting ratings	7-38
locking devices	7-52
mechanical lugs	7-54
phase barriers	7-57
power distribution connectors (PDC)	7-56
termination options	7-38
<b>machine drives</b>	
Altivar™ 320	26-3, 26-15
Altivar™ 340	26-4, 26-17
<b>machine safety products</b>	<b>25-1</b>
<b>machine tool</b>	<b>22-17, 22-21</b>
<b>machine tool pressure switches</b>	<b>22-17, 22-21</b>
<b>Mag-Gard circuit breaker</b>	<b>16-69</b>
<b>Mag-Gard combo starter</b>	<b>16-51</b>
<b>Magelis advanced panels</b>	<b>27-8–27-9</b>
<b>Magelis display</b>	<b>16-105</b>
<b>Magelis Display</b>	<b>16-105</b>
<b>Magelis small panels</b>	
Magelis STO/STU	27-6
Magelis XBT N/R	27-6
<b>Magelis STO/STU</b>	<b>27-6</b>
<b>Magelis STO/STU small panels</b>	<b>27-6</b>
<b>Magelis XBT N/R</b>	<b>27-6</b>

gas-insulated	11-28–11-29	power and energy meter selection	4-19
GHA	11-28	PowerLogic™	
HVL	11-22	BCPM (branch circuit power meters)	4-22
HVL/cc	11-15	CM4000 circuit monitor	4-9
MiniBreak	11-12	displays CM4000	4-9
wind farm applications	11-30	EM4200 Enercept, energy	4-20
<b>medium voltage Metalclad switchgear</b>	<b>11-32</b>	EM4900 multi-circuit	4-24
<b>medium voltage motor controllers</b>	<b>11-37</b>	ION6200 power and energy	4-14
Motorpact	11-37	ION7400 utility feeder meter	4-10
<b>medium voltage transformers</b>	<b>14-21–14-23</b>	ION9000 power and energy	4-7
<b>melting alloy overload relay</b>	<b>16-100</b>	PM3000 power and energy	4-16
accessories	16-126	PM5000 power meters	4-14
<b>melting alloy overload relay jumper strap kits</b>	<b>16-126</b>	PM8000 power and energy	4-12
<b>melting alloy overload relays</b>	<b>16-130</b>	selection, power quality	4-13
isolated alarm contacts	16-130	series 3500 power and energy	4-15
<b>melting alloy type thermal overload relay</b>	<b>16-4</b>	SMD (submeter display)	4-26
<b>merchandised panelboards</b>		stand-alone submetering	4-20
I-Line™ accessories	9-48	PowerLogic™ EM4800 and EM4000	4-21
I-Line™ combo	9-43	<b>MiCOM protection relays</b>	<b>5-2, 5-16</b>
I-Line™, Types HCM, HCP-SU, HCR-U	9-44	busbar differential applications	5-23
NF		characteristics	5-16
20-inch-wide main lug interiors	9-26	distance applications	5-24
accessories	9-33	generator applications	5-22
NQ		line differential applications	5-25
14-inch-wide main interiors	9-13	motor applications	5-20
20-inch-wide main interiors	9-12	railway applications	5-26
20-inch-wide main lug interiors	9-11	self-powered applications	5-18
accessories	9-20	substation applications	5-18
application data	9-36	transformer applications	5-21
<b>merchandised service selection</b>	<b>11-8</b>	<b>Micrologic</b>	<b>11-11</b>
<b>merchandised units</b>	<b>17-4</b>	trip units	11-11
<b>merchandised units Model 6 MCC</b>	<b>17-4</b>	<b>Micrologic™ add-on ground-fault module (GFM)</b>	<b>7-79</b>
<b>metal enclosures, Spacial™</b>	<b>28-2, 28-4, 28-6–28-7</b>	<b>Micrologic™ electronic trip units</b>	
<b>metal-enclosed load interrupter switchgear</b>	<b>11-15</b>	accessories	7-62, 7-76
<b>Metalclad Arc Resistant</b>	<b>11-33</b>	adjustable rating plugs	7-62
<b>Metalclad Arc Terminator</b>		Enerlin'X system	7-75–7-76
Metalclad Arc Resistant	11-33	neutral current transformers	7-62
<b>Metalclad switchgear</b>	<b>11-32</b>	PowerPact™ H- J- and L-frame	7-59
<b>meter centers</b>		PowerPact™ P and R-frame	7-60
1Ø 3W 120/240 indoor/rainproof	2-12	rating plugs	7-62
1Ø branch devices	2-14	<b>mill and foundry</b>	<b>21-43</b>
3Ø 4W indoor / rainproof	2-15	<b>mill and foundry limit switches</b>	<b>21-43</b>
accessories	2-21	<b>Mini-Vario and Vario™ assembled and enclosed switches</b>	<b>8-3</b>
branch devices	2-17	<b>miniature circuit breakers</b>	
busway transition section	2-19	ground fault protector, Multi 9™	7-25
dimensions	2-22	QOU low ampere	7-17
EZ Meter-Pak™	2-9	QOU-HM	7-17
general information	2-9	<b>miniature circuit breakers, Homeline™</b>	<b>1-18, 7-20</b>
indoor	2-15	HOM-CAFI combination arc-fault circuit interrupter	1-18, 7-20
knockouts	2-8	HOM-DF dual function arc-fault circuit interrupter	1-19, 7-20
main devices	2-15	HOM-EPD equipment protection device	1-19, 7-21
MP Meter-Pak™	2-5	HOM-GFI ground-fault circuit interrupter	1-18, 7-21
NEMA 3R construction	2-14	HOM-HM high magnetic trip	1-18, 7-20
rainproof	2-15	HOMT tandem and quad tandem	1-19, 7-21
ring and ringless type	2-5	selection information	7-4
<b>meter door selection</b>	<b>11-8</b>	wire sizes	1-20, 7-22
<b>meter mains</b>		<b>miniature circuit breakers, Multi 9™</b>	
test block bypass, EUSERC	2-3	accessories	7-28
<b>meter mains, rainproof</b>	<b>1-32</b>	C60BR and C60 BPR	7-23
<b>meter sockets</b>	<b>2-3–2-4</b>	C60H-DC	7-25
accessories	2-3	C60SP	7-24
dimensions	2-4	ground fault protector	7-25
horizontal ganged	2-3	selection information	7-5
ring and ringless type, individual	2-2	<b>miniature circuit breakers, QO/QOB</b>	
test block bypass sockets	2-3	accessories	1-8, 7-15
<b>meters</b>		ring terminals	1-4, 7-12
high density metering (HDM)	4-33	wire sizes	1-4, 7-12
multi-circuit energy	4-21	<b>miniature circuit breakers, QO™</b>	<b>1-3, 7-11</b>

accessories, factory-installed	1-8, 7-15	TeSys™ BV4	18-38
non-automatic switches	1-7, 7-14	<b>motor circuit protector disconnects</b>	<b>17-5, 17-7</b>
QO-CAFI combination arc-fault	1-5, 7-13	<b>motor circuit protectors</b>	
QO-DF dual function	1-5, 7-13	motor circuit protection	18-37
QO-EPD/EPE	1-6, 7-13	TeSys BV4	18-37
QO-GFI ground fault circuit interrupter	1-5, 7-13	<b>motor control centers</b>	
QO-HID high intensity discharge	1-6, 7-14	Model 6	
QO-HM high magnetic trip	1-7, 7-14	arc resistant	17-2
QO-K key operated	1-6, 7-14	structure features	17-2
QO-SWN switch neutral common trip	1-6, 7-14	unit features	17-3
QOB bolt-on	9-14	SurgeLogic™ SPD units	6-5
QOT tandem and replacement tandem	1-4, 7-12	<b>motor controllers</b>	<b>16-96–16-97</b>
selection information	7-2–7-3	Altistart™ 22 (Enclosed)	26-30
<b>miniature limit switches</b>	<b>21-8</b>	duplex	16-96–16-97
<b>miniature plug-in timers</b>	<b>23-103</b>	<b>motor disconnect switches</b>	
<b>miniature relays, Square D Type R</b>	<b>23-63</b>	Mini-Vario and Vario™ assembled and enclosed switches	8-3
<b>MiniBreak</b>	<b>11-12</b>	<b>Motor Logic</b>	
compact height switches	11-12	solid state overload relay accessories	16-129
<b>MiniBreak compact height</b>		<b>motor management system</b>	<b>16-103</b>
switch enclosure	11-12	LTMCU compact display	16-105
<b>mission critical circuit breakers</b>		LTME expansion module	16-105
PowerPact™ J-frame	7-42, 9-56	LTMR controller	16-104
PowerPact™ L-frame	7-42, 9-56	Magelis display	16-105
<b>Model 6 MCC</b>	<b>17-5</b>	SoMove Software configuration	16-107
arc resistant	17-2	<b>motor management systems</b>	
blank doors	17-8	HMIhuman machine interface	16-105
branch feeder units, catalog numbering system	17-8	<b>motor operators</b>	
combination starters	17-5	PowerPact™ H-frame	7-50
fusible switch disconnects	17-6	PowerPact™ J-frame	7-50
motor circuit protector disconnects	17-5	PowerPact™ L-frame	7-50
Compac™ 6 combination starter units	17-7	<b>motor protection</b>	
merchandised units	17-4	H-frame motor circuit protectors (MCP)	7-46–7-47
structure features	17-2	H-frame motor protector circuit breakers	18-37
unit features	17-3	instantaneous trip circuit breakers	7-45
<b>Model III</b>		J-frame motor circuit protectors (MCP)	7-46–7-47
distribution section	11-35	J-frame motor protector circuit breakers	18-37
package unit substations	11-34	L-frame motor protector circuit breakers	18-37
unit substations	11-34	LAL adjustable instantaneous-trip	7-48
<b>Modicon</b>		locked rotor indicating codes	7-45
Zelio™ logic controller	27-2	PowerPact™ H- and J-frame MCP	7-46–7-47
<b>Modicon M340™ PAC</b>	<b>27-4</b>	PowerPact™ H-frame	
<b>Modicon M580™ ePAC</b>	<b>27-4</b>	motor protector circuit breakers	7-48
<b>Modicon Premium™ PAC</b>	<b>27-5</b>	PowerPact™ H-frame motor protector	7-48
<b>Modicon Quantum™ PAC</b>	<b>27-5</b>	PowerPact™ J-frame motor protector	7-48
<b>Modicon STB</b>	<b>27-15</b>	PowerPact™ L-frame	
<b>Modicon Telefast ABE7 sub-bases</b>	<b>27-15</b>	motor protector circuit breakers	7-48
<b>Modicon Telefast ABE9 passive splitter boxes</b>	<b>27-15</b>	PowerPact™ L-frame motor protector	7-48
<b>Modicon TM7 I/O blocks</b>	<b>27-15</b>	<b>motor starters</b>	<b>18-22</b>
<b>Modicon™</b>		TeSys U	18-22, 18-51
M221 PLC	27-2	TeSys U-Line	
M241 PLC	27-2	power bases	16-12
M251 PLC	27-3	<b>Motorpact</b>	<b>11-37</b>
M258 PLC	27-3	medium voltage motor controllers	11-37
TSX Micro PLC	27-4	<b>mounting bases</b>	
Unity Momentum PLC	27-4	Multi 9™ UL489 C60, 240 Vac max.	7-16
<b>modifications</b>	<b>16-79–16-81</b>	QO	7-16
lighting contactors	16-79–16-81	<b>mounting options, PowerPact™</b>	<b>7-58</b>
<b>modular panelboard system</b>	<b>10-2, 10-6</b>	<b>mounting track</b>	
<b>modular panelboard system, MPS</b>	<b>10-6</b>	3/4 inch track	24-22
layout, lead time, pricing	10-7	DIN 2	24-18
shipping	10-7	DIN 3	24-18
<b>modular timers</b>	<b>23-100</b>	end clamps	24-18, 24-22
<b>molded case circuit breakers</b>		<b>MP Meter-Pak™ meter centers</b>	
dimensions	7-80	dimensions and knockouts	2-8
<b>molded case switches</b>		ring and ringless	2-5
PowerPact™	7-44	<b>MPS, modular panelboard system</b>	<b>10-2, 10-6</b>
<b>molded-case circuit breakers</b>	<b>7-6–7-8</b>	<b>MTZ circuit breakers</b>	
<b>motor circuit protection selection</b>		Masterpact™	11-3, 11-10–11-11

switchboard/switchgear	11-3, 11-10–11-11
<b>Multi 9™</b>	
busbars	7-26–7-27
C60 accessories	7-28
C60 UL 489A (DC)	7-25
C60BP and C60BPR miniature circuit breakers	7-23
C60SP miniature circuit breakers	7-24
ground fault protector	7-25
miniature circuit breaker	7-25
mounting bases, UL489 C60, 240 Vac max.	7-16
<b>multi circuit energy meter</b>	<b>4-21</b>
<b>multifunction operators, Type SK</b>	<b>19-89</b>
<b>multipole lighting</b>	<b>16-74</b>
<b>multipole lighting contactor</b>	<b>16-74</b>
<b>MV controllers</b>	<b>11-37</b>

**N**

<b>NEMA 1 enclosure, Class 9991</b>	<b>23-98</b>
<b>NEMA 1 selection table</b>	<b>16-112</b>
<b>NEMA 12/3R outdoor applications</b>	<b>16-113</b>
<b>NEMA 7 and 9 safety switches</b>	<b>3-13</b>
<b>NEMA and UL universal enclosure ratings</b>	<b>28-3</b>
<b>NEMA rstyle</b>	
general information	16-29
<b>NEMA style</b>	<b>16-33, 16-46, 16-60</b>
2-pole single phase	16-37
3-pole polyphase	16-29
application data	16-56
application data for selection	16-38
coil voltage codes	16-70
combination starters	16-46
control transformers	16-57
dimensions	16-102
full voltage reversing contactors	16-60
full voltage vacuum contactors	16-43
fusible	16-47, 16-49
fusible disconnect switch type	16-67
interlocks	16-57
Mag-Gard circuit breaker	16-69
MCP circuit breaker	16-51, 16-69
melting alloy	16-100
non-fusible	16-48
non-fusible and fusible disconnect switch type	16-68
overload relays	16-110
solid state overload relay	16-101
solid state overload relay protection, Motor Logic	16-33
solid-state overload relay protection Motor Logic	16-62
thermal magnetic circuit breaker	16-54–16-55, 16-70–16-71
Types SBSB with auxiliary load terminals	16-37
<b>NEMA style approximate dimensions</b>	<b>16-66</b>
<b>NEMA style oversized enclosure MCP circuit breaker</b>	<b>16-52</b>
<b>NEMA style relays, Square D Type X</b>	<b>23-94</b>
<b>NEMA type 1 and 3R</b>	
dimensions for heavy duty safety switches	3-22
<b>NEMA type 1 and flush mounting</b>	<b>16-112</b>
enclosures	16-112
<b>NEMA type 3R, 4, 4X, and 12</b>	<b>16-111</b>
enclosures	16-111
<b>NEMA types 1, 4, and oversize</b>	<b>16-113</b>
enclosures	16-113
<b>network access points, ZBRN1 and ZBRN2</b>	<b>19-65</b>
<b>network products and systems</b>	<b>27-17</b>
<b>neutral current transformers, Micrologic™ trip units</b>	<b>7-62</b>
<b>NF panelboards</b>	<b>9-28, 9-65</b>
20-inch-wide merchandised	9-26
accessories	9-33
common features	9-31

factory assembled	9-31
merchandised, circuit breakers	9-28
series ratings	9-6
terminal data	9-65
<b>Night-Master combination lighting contactors</b>	<b>16-78</b>
<b>non-automatic switches, QOU</b>	<b>7-18</b>
<b>non-fusible</b>	<b>16-48</b>
<b>non-fusible and fusible disconnect switch type</b>	<b>16-68</b>
<b>non-reversing</b>	<b>16-5, 18-7, 18-10</b>
<b>non-reversing manual switches</b>	<b>16-5</b>
<b>non-segregated phase bus, Power-Zone™</b>	<b>12-18</b>
<b>non-ventilated and transformer house transformers</b>	<b>14-13</b>
<b>NQ panelboards</b>	<b>9-65</b>
14-inch-wide merchandised	9-13
20-inch-wide merchandised	9-11–9-12
accessories	9-20
application data	9-36
feed-through lugs	9-18
QOB bolt-on circuit breakers	9-14
series ratings	9-2
sub-feed circuit breakers	9-17
sub-feed lugs	9-17
terminal data	9-65
<b>NQOD and NQ panelboard circuit breakers</b>	<b>1-3, 7-11</b>
<b>NQOD distribution bus</b>	<b>11-6</b>
<b>NSYEB distribution blocks</b>	<b>24-26</b>
<b>NT/NW universal power circuit breakers</b>	<b>7-73</b>
<b>NW/NT universal power circuit breakers</b>	
trip units, Micrologic™	11-11

**O**

<b>OEM/assembler kits</b>	<b>6-7</b>
<b>oiltight</b>	<b>21-43</b>
limit switches	21-43
<b>oiltight (NEMA Type 12)</b>	<b>13-3</b>
wireway	13-3
<b>open bottom polyester enclosures</b>	<b>28-8</b>
<b>open drives</b>	
Altivar™ 12	26-2
Altivar™ 12 AC drives	26-12
Altivar™ 212	26-6, 26-10
Altivar™ 312	26-2
Altivar™ 312 AC drives	26-13
Altivar™ 61	26-6
Altivar™ 61 AC drives	26-18
Altivar™ 71	26-5, 26-19–26-20
Altivar™ Process 600	26-6
Altivar™ Process 630	26-24
Altivar™ Process 650	26-24
Altivar™ Process 900	26-5
Altivar™ Process 930	26-25
Altivar™ Process 950	26-25
<b>open tank float switches</b>	<b>22-28–22-29</b>
9038A mechanical alternators	22-32
<b>operating heads</b>	<b>21-34</b>
<b>operating heads, replacement parts, and levers</b>	<b>21-35</b>
<b>operating mechanisms</b>	<b>8-2</b>
door mounted for circuit breakers	8-39
<b>operators</b>	
common, Type K, SK	19-9
common, XB4 and XB5	19-8
corrosion resistant 30 mm	19-82
corrosion resistant illuminated, Type SK	19-84
corrosion resistant, multifunction	19-83
corrosion resistant, Type SK	19-89
emergency stop, XB4 22 mm	19-29
emergency stop, XB5 22 mm	19-49

Type BW pendant stations	19-132	NQ	
Type K heavy duty specialty	19-80	14-inch-wide main interiors	9-13
Type KX (square)	19-102	20-inch-wide main interiors	9-12
Type XAC pendant stations	19-133	20-inch-wide main lug interiors	9-11
XB4 specialty	19-31	accessories	9-20
XB5 specialty	19-51	application data	9-36
<b>options</b>		feed-through lugs	9-18
surge protective devices (SPDs)		QOB bolt-on circuit breakers	9-14
EMA (external modular assembly)	6-2	series ratings	9-2
<b>order form for 9003K2 cam switch</b>	<b>19-143–19-144</b>	sub-feed circuit breakers	9-17
<b>OsiSense</b>		sub-feed lugs	9-17
inductive proximity sensors		<b>panels</b>	
XS basic and basic plus	20-8	construction sites	1-44
XS basic plus, accessories	20-9	recreational vehicle parks	1-44
XS rectangular	20-5	<b>partner managed services</b>	<b>29-8</b>
XS tubular general purpose	20-6–20-7	<b>pendant stations</b>	
photoelectric sensors		general purpose	19-133
compact, XUK and XUX	20-4	Type BW	19-132
optical forks, XUVR / XUVA	20-3	XAC pistol grip	19-133
tubular, XUB	20-2	<b>phase barriers, PowerPact™</b>	<b>7-57</b>
<b>outdoor meter mains</b>	<b>1-35</b>	<b>phase measurement relays, Zelio RM17T*00</b>	<b>23-112</b>
<b>overload relay</b>		<b>Phaseo</b>	
bimetallic, adapted	16-110	ABL1 DC power supplies	23-117
<b>overload relay accessories</b>	<b>18-21</b>	ABL7 DC power supplies	23-117
<b>overload relays</b>		ABL8 DC power supplies	23-117
accessories		<b>photoelectric sensors</b>	
melting alloy	16-126	compact, XUK and XUX	20-4
accessories, TeSys D	18-21	optical fork, XUVR / XUVA	20-3
enclosed combination starters	18-46	tubular, XUB	20-2
TeSys D	16-16, 18-8	<b>photovoltaic heavy duty disconnect Switch, 1000 Vdc</b>	<b>3-34</b>
TeSys F	18-10	<b>pilot lights</b>	
		Type J compact	19-11
		Type K heavy duty	19-79
		Type KX (square)	19-103
		Type SK corrosion resistant	19-88
		Type XVL compact	19-10
		XB4	19-32
		XB5	19-52
		XB6E	19-21
		XB7	19-69
		<b>PL7™ application software</b>	<b>27-4</b>
		<b>PLC programmable logic controllers</b>	<b>27-2–27-4</b>
		<b>plug-in control relays</b>	
		792 Control Series	23-14
		<b>plug-in relays</b>	
		Square D Type R	23-62
		Zelio RPM	23-9
		Zelio RUM	23-11
		Zelio RXM	23-6
		<b>plug-on circuit breakers</b>	
		combination arc-fault circuit interrupter HOM-CAFI	1-18, 7-20
		dual function arc-fault circuit interrupter HOM-DF	1-19, 7-20
		equipment protection device HOM-EPD	1-19, 7-21
		ground-fault circuit interrupter HOM-GFI	1-18, 7-21
		high magnetic HOM-HM	1-18, 7-20
		Homeline	1-18, 7-20
		QO™	1-3, 7-11
		tandem and quad tandem HOMET	1-19, 7-21
		wire sizes for Homeline	1-20, 7-22
		<b>plug-on neutral (PoN) CSEDs, solar-ready</b>	<b>1-40</b>
		<b>plug-on neutral CSED, solar-ready, Homeline</b>	<b>1-40</b>
		<b>PM3000 power and energy meters</b>	<b>4-16</b>
		<b>polyester enclosures</b>	<b>28-2, 28-8</b>
		<b>potentiometers</b>	
		Type 9001K 30 mm	19-77
		Type 9001SK 30 mm	19-87
		Type KX 30 mm (square)	19-102
		Type XB4 22 mm	19-31

**P**

**P-frame, PowerPact™**

automatic molded case switch	7-44
bus bar connections	7-57
busway plug-in units, I-Line™	12-16
catalog numbering system	7-29
circuit breakers	7-29, 7-39
compression lugs	7-55
dimensions and shipping weights	7-81
drawout cradle	7-58
electrical accessories	7-49
enclosures	7-82
I-Line™ circuit breakers	9-59
interrupting ratings	7-39
mechanical lugs	7-54
Micrologic™ trip units	7-60
phase barriers	7-57
power distribution connectors (PDC)	7-56
rotary handles	7-51
spring charging motors	7-50
termination options	7-39, 7-58
<b>PAC programmable automation controllers</b>	<b>27-4–27-5, 27-21</b>
<b>package unit substations</b>	<b>11-34</b>
<b>padlock attachments</b>	
PowerPact™ circuit breakers	7-52
QO™ circuit breakers	1-8, 7-15
Type K and SK push button	19-97
<b>panel busbar system</b>	<b>18-59</b>
<b>panel mount timers</b>	<b>23-102</b>
<b>panelboards</b>	<b>9-22</b>
I-Line™ series ratings	9-6
NF	
20-inch-wide main lug interiors	9-26
accessories	9-33
series ratings	9-6

Type XB5 22 mm	19-51	Com'X data loggers and energy servers	4-26
<b>power and energy meters</b>		EM4900 multi-circuit	4-24
iEM3000 energy meters	4-17	energy meter	4-20
LVCT series ct	4-15	engineering services	4-28
METSECTR series rope-style ct	4-15	factory assembled equipment	4-31
PowerLogic™ branch circuit power meter (BCPM)	4-22	high density metering (HDM)	4-33
PowerLogic™ EM4800 and EM4000 multi-circuit	4-21	industrial energy efficiency	4-28
PowerLogic™ EM4900 series multi-circuit meters	4-24	ION9000 power and energy meters	4-7
PowerLogic™ energy meter	4-20	multi-circuit energy meters	4-21
PowerLogic™ ION6200	4-14	power and energy meter selection table	4-19
PowerLogic™ PM5000	4-14	power and energy meters	
PowerLogic™ PM8000	4-12	ION6200	4-14
PowerLogic™ submeter display (SMD)	4-26	PM8000	4-12
selection table	4-19	series 5000 power meters	4-14
series 3500	4-15	power quality meter selection table	4-13
<b>power base, TeSys U</b>	<b>18-22</b>	SCADA software	4-6
<b>power bases</b>	<b>16-12</b>	series 4000 displays	4-9
<b>power distribution blocks</b>	<b>24-27</b>	submeter display (SMD)	4-26
<b>power distribution connectors (PDC), PowerPact™</b>	<b>7-56</b>	system integration	4-28, 4-31
<b>power energy meters</b>		total energy control	4-28
PowerLogic™ Series 4000 circuit monitor (CM4000T)	4-9	<b>PowerPact™</b>	
<b>power monitoring software</b>		H- and J-frame circuit breakers	
EcoStruxure™ Power Monitoring Expert	4-4	switchboard/switchgear	11-3
EcoStruxure™ PowerSCADA Operation	4-6	<b>PowerPact™ B-frame</b>	
<b>power outlet panels</b>		automatic molded case switch	7-44
for construction sites	1-44	catalog numbering system	7-29
<b>power pole adders</b>	<b>16-129</b>	circuit breakers	7-29–7-30
contactors	16-129	compression lugs	7-55
starters	16-129	dimensions and shipping weights	7-81
<b>power quality meters</b>		electrical accessories	7-49
PowerLogic™ ION9000	4-7	I-Line™ circuit breakers	9-51
PowerLogic™ PM8000	4-12	interrupting ratings	7-30
selection table	4-13	locking devices	7-52
<b>power relays</b>		mechanical lugs	7-54
Square D Type C	23-65	power distribution connectors (PDC)	7-56
Zelio RPF	23-13	rotary handles	7-51
<b>power solutions integrated equipment</b>	<b>10-2</b>	terminal nuts and terminal shields	7-57
IPaCS equipment	10-2	termination options	7-30
<b>power supplies</b>	<b>23-117</b>	<b>PowerPact™ H-frame</b>	
Easergy™ RTU backup power supplies	5-34	500 Vdc circuit breakers	7-43
<b>power system automation</b>	<b>4-28</b>	automatic molded case switch	7-44
<b>Power-Cast</b>	<b>11-24</b>	busway plug-in units, I-Line™	12-12–12-13, 12-15
<b>Power-Style</b>	<b>11-2</b>	catalog numbering system	7-29
commercial multi-metering	11-5	circuit breakers	7-29, 7-31
commercial multi-metering switchboards	11-5	compression lugs	7-55
QED-2		dimensions and shipping weights	7-81
switchboard	11-2	electrical accessories	7-49
QED-6	11-3	enclosures	7-82
switchboard	11-3	I-Line™ circuit breakers	9-54
<b>Power-Zone</b>	<b>11-11</b>	interrupting ratings	7-31
low voltage switchgear	11-10–11-11	locking devices	7-52
Model III		mechanical lugs	7-54
distribution section	11-35	Micrologic™ electronic trip units	7-59
package unit substations	11-34	motor circuit protectors (MCP)	7-46–7-47
unit substations	11-34	motor operators	7-50
<b>Power-Zone™ non-segregated busway</b>	<b>12-18</b>	motor protector circuit breaker	7-48
<b>Powerbus™ busway</b>	<b>12-2–12-3</b>	plug-in and drawout mounting	7-58
metering and communication options	12-2	power distribution connectors (PDC)	7-56
plug-in units	12-3	rotary handles	7-51
straight lengths and fittings	12-2	terminal nuts and terminal shields	7-57
<b>Powerlink™</b>		termination options	7-31
accessories	9-40–9-41	<b>PowerPact™ J-frame</b>	
ECB-G3 circuit breakers	9-39	500 Vdc circuit breakers	7-43
energy management (EM) lighting control	9-42	automatic molded case switch	7-44
G3 lighting control systems	9-38	busway plug-in units, I-Line™	12-12–12-13, 12-15
<b>PowerLogic™</b>		catalog numbering system	7-29
arc flash analysis	4-28	circuit breakers	7-29
branch circuit power meters (BCPM)	4-22	compression lugs	7-55
CM4000 circuit monitor	4-9		

dimensions and shipping weights	7-81	power distribution connectors (PDC)	7-56
electrical accessories	7-49	rotary handles	7-51
enclosures	7-82	spring charging motors	7-50
I-Line™ circuit breakers	9-54	termination options	7-39
locking devices	7-52	<b>PowerPact™ Q-frame</b>	
mechanical lugs	7-54	automatic molded case switch	7-44
Micrologic™ electronic trip units	7-59	catalog numbering system	7-29
mission critical circuit breakers	7-42, 9-56	circuit breakers	7-29, 7-34
motor circuit protectors (MCP)	7-46–7-47	enclosures	7-82
motor operators	7-50	I-Line™ circuit breakers	9-53
motor protector circuit breaker	7-48	interrupting ratings	7-34
plug-in and drawout mounting	7-58	locking devices	7-52
power distribution connectors (PDC)	7-56	termination options	7-34
rotary handles	7-51	<b>PowerPact™ R-frame</b>	
terminal nuts and terminal shields	7-57	automatic molded case switch	7-44
<b>PowerPact™ L-frame</b>	<b>7-42</b>	busway plug-in units, I-Line™	12-17
500 Vdc circuit breakers	7-43	circuit breakers	7-40
automatic molded case switch	7-44	compression lugs	7-55
bus bar connections	7-57	dimensions and shipping weights	7-81
busway plug-in units, I-Line™	12-14–12-15	electrical accessories	7-49
catalog numbering system	7-29	I-Line™ circuit breakers	9-59
circuit breakers	7-29, 7-36	interrupting ratings	7-40
compression lugs	7-55	locking devices	7-52
dimensions and shipping weights	7-81	mechanical lugs	7-54
electrical accessories	7-49	Micrologic™ electronic trip units	7-60
enclosures	7-82	phase barriers	7-57
I-Line™ circuit breakers	9-57	power distribution connectors (PDC)	7-56
interrupting ratings	7-36	terminal pad kits	7-57
locking devices	7-52	termination options	7-40
mechanical lugs	7-54	<b>precision switches with direct acting contacts</b>	<b>21-32</b>
Micrologic™ electronic trip units	7-59	<b>Premset™</b>	<b>11-14</b>
mission critical circuit breakers	9-56	<b>Premset™ vacuum circuit breaker switchgear</b>	<b>11-14</b>
motor operators	7-50	<b>pressure sensors</b>	
motor protector circuit breaker	7-48	XMLG electronic	22-4
plug-in and drawout mounting	7-58	<b>pressure sensors, electronic</b>	
power distribution connectors (PDC)	7-56	XMEP	22-4
rotary handles	7-51	XMLG	22-4
termination options	7-36	XMLK	22-4
<b>PowerPact™ M-frame</b>		XMLP	22-4
bus bar connections	7-57	XMLR	22-4
busway plug-in units, I-Line™	12-15	<b>pressure sensors, XMLK electronic</b>	<b>22-9</b>
catalog numbering system	7-29	<b>pressure switches</b>	<b>22-26</b>
circuit breakers	7-29, 7-38	9012G	22-20
compression lugs	7-55	differential pressure	22-18
dimensions and shipping weights	7-81	dimensions	
electrical accessories	7-49	9012G	22-20
enclosures	7-82	pressure switches	
I-Line™ circuit breakers	9-57	XML international	22-15
interrupting ratings	7-38	XML international	22-15
locking devices	7-52	XML international pressure switches	22-15
mechanical lugs	7-54	XMLK electronic	22-10
power distribution connectors (PDC)	7-56	dual stage	22-18
termination options	7-38	industrial	22-16
<b>PowerPact™ P-frame</b>	<b>7-52</b>	machine tool	22-17, 22-21
automatic molded case switch	7-44	Pumptrol	22-26
bus bar connections	7-57	renewal parts	22-34
busway plug-in units, I-Line™	12-16	XML industrial	22-13
catalog numbering system	7-29	XML international	22-15
circuit breakers	7-29, 7-39	XMLG electronic	22-4
compression lugs	7-55	XMLK electronic	22-9–22-10
dimensions and shipping weights	7-81	<b>pressure switches, 9012 and 9016</b>	<b>22-19</b>
electrical accessories	7-49	<b>pressure transmitters, XMLG electronic</b>	<b>22-4</b>
enclosures	7-82	<b>pressure wire connectors</b>	<b>24-20</b>
I-Line™ circuit breakers	9-59	<b>pressure, vacuum, and float switches</b>	<b>22-34</b>
interrupting ratings	7-39	<b>Preventa™ machine safety products</b>	<b>25-1</b>
mechanical lugs	7-54	<b>probes</b>	<b>23-114</b>
Micrologic™ electronic trip units	7-60	<b>ProClima software</b>	<b>28-3</b>
plug-in and drawout mounting	7-58	<b>programmable automation controllers, PacDrive</b>	<b>27-21</b>

<b>programmable controllers</b>	<b>27-2</b>	XB7 selector switches and key switches	19-70
<b>protection modules</b>		<b>push buttons, 30 mm</b>	<b>19-8, 19-72</b>
RUW	23-10, 23-12	9001K selector switches	19-75-19-77
RXM	23-8, 23-10	9001SK selector switches	19-85-19-87
RZM	23-3-23-4	accessories	
<b>proximity sensors</b>	<b>20-9</b>	caps, knobs, and inserts	19-99
accessories, XS	20-7	Type K and SK closing plates	19-98
accessories, XS basic plus	20-9	Type K and SK interlock	19-101
capacitive dc	20-9	Type K and SK mushroom button guards	19-97
rectangular plastic, XS	20-5	Type K and SK padlock attachments	19-97
tubular basic and basic plus, XS	20-8	Type K and SK protective boots	19-98
tubular general purpose, XS	20-6	Type K and SK replacement parts	19-100
tubular short case, XS	20-7	Type K and SK ring nuts	19-100
<b>pump control relays, Zelio RM35BA10</b>	<b>23-114</b>	Type K and SK screwdriver	19-101
<b>pump panels</b>	<b>16-95</b>	Type K and SK wrenches	19-101
Well-Guard	16-93-16-94	common operators, Type K and SK	19-9
<b>Pumptrol</b>	<b>22-26</b>	operators, Type SK illuminated	19-84
compressor pressure switches	22-23	operators, Type SK momentary	19-82
pressure switches	22-26	operators, Type SK multifunction	19-83
water pump pressure switches	22-24	potentiometers with dial plate, K	19-77
<b>push buttons, 16 mm</b>		potentiometers with dial plate, SK	19-87
complete devices, XB6	19-12	selector switch guide	19-78
XB6 accessories	19-20	Type B standard duty control stations	19-111
XB6 electrical components	19-15	Type K heavy duty operators	19-72
XB6 illuminated operators	19-16	Type K heavy duty pilot lights	19-79
XB6 keyed selector switches	19-18	Type K heavy duty specialty operators	19-80
XB6 legend holders and inserts	19-20	Type K, SK legend holders and inserts	19-94
XB6 non-illuminated operators	19-16	Type SK corrosion resistant pilot lights	19-88
XB6 push button caps	19-19	Type SK multifunction operators	19-89
XB6 selector switches, non-illuminated	19-17	<b>push buttons, 30 mm (square)</b>	
XB6E accessories	19-23	accessories, Type KX	19-106
XB6E flush, spring return push buttons	19-21	pilot lights, Type KX	19-103
XB6E illuminated push buttons, latching	19-22	selector switches with contacts	19-102
XB6E illuminated push buttons, spring return	19-22	Type KX legend holders	19-105
XB6E pilot lights	19-21	Type KX potentiometers	19-102
XB6E selector switches	19-23	Type KX selectors without contacts	19-104
<b>push buttons, 22 mm</b>	<b>19-8</b>	Type KX with contacts	19-102
access points	19-65	Type KX without contacts	19-103
accessories, XB4	19-40		
accessories, XB5	19-60		
accessories, XB5R and XB4R	19-64		
accessories, XB7	19-71		
common operators, XB4-XB5	19-8		
XB4 complete devices	19-24, 19-26		
XB4 electrical components	19-35		
XB4 emergency stop operators	19-29		
XB4 illuminated operators	19-33		
XB4 legend holders and inserts	19-38-19-39		
XB4 legend sheets	19-39		
XB4 operators	19-27		
XB4 pilot lights	19-32		
XB4 selector switches	19-30		
XB4 specialty operators	19-31		
XB4R metal wireless, batteryless	19-63		
XB5 complete devices	19-43		
XB5 electrical components	19-55		
XB5 emergency stop operators	19-49		
XB5 legend holders and inserts	19-58-19-59		
XB5 operators, illuminated	19-53		
XB5 operators, non-illuminated	19-46		
XB5 pilot lights	19-52		
XB5 selector switches	19-50		
XB5 specialty operators	19-51		
XB5R plastic wireless, batteryless	19-63		
XB7 illuminated push buttons with projecting push	19-69		
XB7 legend holders and inserts	19-71		
XB7 mushroom head	19-70		
XB7 pilot lights	19-69		
XB7 push buttons	19-68		
		<b>Q</b>	
		<b>Q-frame, PowerPact™</b>	
		automatic molded case switch	7-44
		catalog numbering system	7-29
		circuit breakers	7-29, 7-34
		enclosures	7-82
		I-Line™ circuit breakers	9-53
		interrupting ratings	7-34
		locking devices	7-52
		termination options	7-34
		<b>QED-2</b>	<b>11-2</b>
		switchboard	11-2
		<b>QED-6</b>	<b>11-3</b>
		switchboard	11-3
		<b>QED-6 rear-connected switchboards</b>	<b>11-3</b>
		<b>QED-6 switchboards</b>	<b>11-3</b>
		<b>QED-S Power-Style</b>	
		switchboards	11-2
		<b>QMB</b>	
		SurgeLogic SPD units	6-5
		<b>QMB branch switches</b>	
		terminal data	9-65
		<b>QMB fusible branch switches</b>	<b>9-62</b>
		<b>QMB panelboards</b>	
		factory assembled, fusible	9-63
		<b>QO and Homeline load centers</b>	
		dimensions	1-28
		dimensions and knockouts	1-30



enclosure dimensions, QO and Homeline	1-28
indoor dimensions	1-28
indoor load centers	
dimensions	1-28
knockouts	1-28
knockouts for enclosures	1-28
load centers value pack	1-25
QO and Homeline load centers	
indoor dimensions	1-28
indoor load centers	
dimensions	1-28
rainproof dimensions	1-30
rainproof knockouts	1-30
rainproof, bolt-on hubs	1-30
riser panels	1-16
<b>QO and QOB miniature circuit breaker accessories</b>	<b>1-8</b>
<b>QO and QOB miniature circuit breaker accessories</b>	<b>7-15</b>
<b>QO load centers</b>	
accessories	1-26
backup power solutions	1-13
convertible main lugs kits	1-10
kits for main circuit breaker QOM1 frame	1-10, 1-22
main circuit breaker, 1Ø3W indoor	1-9
main circuit breaker, 1Ø3W rainproof	1-14–1-15
main circuit breaker, 3Ø4W and 3Ø4W indoor	1-17
main circuit breaker, 3Ø4W and 3Ø4W rainproof	1-17
rainproof, main lugs, main circuit breaker	1-12
rainproof, metallic enclosure	1-14–1-15
rainproof, non-metallic enclosure	1-14–1-15
<b>QO miniature circuit breaker</b>	<b>1-8</b>
<b>QO miniature circuit breakers</b>	
solid neutral assemblies	7-16
<b>QO miniature circuit breaker</b>	<b>7-15</b>
<b>QO OEM mounting bases, UL Listed and CSA approved</b>	<b>7-16</b>
<b>QO PoN CAFI load centers</b>	
main circuit breaker, 1Ø indoor	1-10
<b>QO/QOB miniature circuit breakers</b>	
accessories	1-8, 7-15
ring terminals	1-4, 7-12
wire sizes	1-4, 7-12
<b>QO™</b>	
surge protective devices (SPD)	1-27, 6-12
<b>QO™ distribution panels</b>	<b>9-52</b>
<b>QO™ enclosures</b>	<b>1-42</b>
<b>QO™ load centers</b>	
auxiliary gutter	1-11
service upgrade panels	1-11
special applications	1-11
tap kit	1-11
<b>QO™ miniature circuit breakers</b>	<b>1-3, 7-11</b>
dimensions	7-80
non-automatic switches	1-7, 7-14
QO-CAFI combination arc-fault	1-5, 7-13
QO-DF dual function	1-5, 7-13
QO-EPD/EPE	1-6, 7-13
QO-GFI ground fault circuit interrupter	1-5, 7-13
QO-HID high intensity discharge	1-6, 7-14
QO-HM high magnetic trip	1-7, 7-14
QO-K key operated	1-6, 7-14
QO-SWN switch neutral common trip	1-6, 7-14
QOB bolt-on	9-14
QOT tandem and replacement tandem	1-4, 7-12
<b>QOU</b>	
accessories	7-19
high ampere miniature circuit breakers	7-18
low ampere miniature circuit breakers	7-17
non-automatic switches	7-18
QOU-HM miniature circuit breakers	7-17
QOUQ quick-connect terminals	7-19

<b>QOU miniature circuit breakers</b>	
solid neutral assemblies	7-16
<b>quick-connect terminals, QOUQ</b>	<b>7-19</b>
<b>Qwik-Open™</b>	<b>1-3, 7-11</b>
<b>QYU UL1077 recognized supplementary protectors</b>	<b>7-17</b>

## R

<b>R-frame, PowerPact™</b>	
automatic molded case switch	7-44
busway plug-in units, I-Line™	12-17
catalog numbering system	7-29
circuit breakers	7-29, 7-40
compression lugs	7-55
dimensions and shipping weights	7-81
electrical accessories	7-49
I-Line™ circuit breakers	9-59
interrupting ratings	7-40
locking devices	7-52
mechanical lugs	7-54
Micrologic™ trip units	7-60
phase barriers	7-57
power distribution connectors (PDC)	7-56
terminal pad kits	7-57
termination options	7-40
<b>rainproof main circuit breakers</b>	
1Ø3W, QO load centers	1-14–1-15
3Ø4W and 3Ø4W, QO load centers	1-17
<b>rainproof main lugs</b>	
QO load centers 3Ø4W and 3Ø4W	1-17
<b>rainproof meter centers</b>	<b>2-15</b>
<b>rainproof, main lugs, main circuit breaker</b>	<b>1-12</b>
<b>rainproof, metallic enclosure</b>	<b>1-14–1-15</b>
<b>rainproof, non-metallic enclosure</b>	<b>1-14–1-15</b>
<b>raintight (NEMA Type 3R)</b>	<b>13-4</b>
wireway	13-4
<b>raintight trough (NEMA Type 3R)</b>	<b>13-4</b>
wireway	13-4
<b>rating plugs, Micrologic™ trip units</b>	<b>7-62</b>
<b>ratings</b>	
safety switch, SCCR	3-5
safety switches, SCCR	3-11
<b>RE17 timers</b>	<b>23-100</b>
<b>RE48 timers</b>	<b>23-102</b>
<b>ReactiVar™</b>	
harmonic mitigation solutions	4-34
reactive power compensation	4-34
<b>reactive power compensation solutions</b>	<b>4-34</b>
<b>receptacle Crouse-Hinds Style 2 Hubbellock</b>	<b>3-14</b>
<b>recreational vehicle parks</b>	<b>1-44</b>
<b>relays</b>	
control and measurement	23-111
general purpose	23-2, 23-60, 23-66
industrial	23-87, 23-94
MiCOM protection relays	5-16
point of purchase blister packs	19-114
Sepam™ relay applications	5-11
solid-state	23-68
system protection	5-2, 5-6–5-8, 5-11, 5-16, 5-18, 5-20–5-26
arc flash	5-3
retrofit (ECOFIT 50/51)	5-4
Sepam™ relay applications	5-10, 5-12–5-15
Sepam™ series 20, 40, and 80	5-5, 5-8–5-9
<b>Remote Alarm Indicator</b>	<b>15-2–15-3</b>
IG2000CBM	15-3
IG2000P	15-3
<b>remote terminal units (RTUs)</b>	
Easergy T300	5-33–5-34

Easergy™ T300	5-32
SAGE 1410	5-30
SAGE 1430	5-30
SAGE 1450	5-31
SAGE 2400	5-28
SAGE 3030 Magnum	5-29
SAGE 4400	5-29
SAGE RTUs, introduction	5-27
<b>renewal parts</b>	
pressure, vacuum, and float switches	22-34
<b>repair parts</b>	<b>18-55–18-56</b>
<b>replacement modules</b>	<b>6-3</b>
<b>replacement modules, surge protective devices (SPD)</b>	<b>6-3</b>
EBA (external brick assembly) SPDs	6-3
EMA (external modular assembly) SPDs	6-3
L-L enhanced (L-L) SPDs	6-3
L-L enhanced MA (L-N, L-G) SPDs	6-3
<b>replacement parts</b>	
30 mm enclosures	19-110–19-111
pendant stations	19-132, 19-134
Type K and SK operators	19-100
<b>replacement parts kits</b>	<b>16-125–16-126</b>
contact units for melting alloy overload relays	16-126
contactors	16-125
fuse block	16-132
jumper strap kit, melting alloy	16-126
starter accessories	16-126
starters	16-125
universal baseplate for starters	16-126
<b>replacement parts kits relays</b>	<b>16-125</b>
<b>residential surge protective devices (SPD)</b>	
for QO, NQ, and Homeline loadcenters	6-12
whole house	6-11
<b>residential whole house</b>	<b>6-11</b>
<b>reversing</b>	<b>16-5, 18-9–18-10</b>
<b>reversing and two speed</b>	<b>16-9</b>
manual starters	16-9
<b>reversing combination starters</b>	
NEMA style	
coil voltage codes	16-70
dimensions	16-72–16-73
fusible disconnect switch type	16-67
Mag-Gard circuit breaker	16-69
MCP circuit breaker	16-69
non-fusible and fusible disconnect switch type	16-68
thermal magnetic circuit breaker	16-70–16-71
<b>reversing hoist</b>	<b>16-99</b>
<b>reversing manual switches</b>	<b>16-5</b>
<b>REXL timers</b>	<b>23-103</b>
<b>RFID safety sensors</b>	<b>25-7</b>
<b>RGZ</b>	
accessories	23-4
sockets	23-4
<b>ring and ringless type meter centers</b>	<b>2-5</b>
<b>ring and ringless type, individual meter sockets</b>	<b>2-2</b>
<b>ring terminals for QO/QOB</b>	<b>1-4, 7-12</b>
<b>riser panel, panelboard-style covers</b>	<b>1-16</b>
<b>riser panels</b>	<b>1-16</b>
<b>riser panels, QO load centers</b>	<b>1-16</b>
<b>RM17JC current measurement relays</b>	<b>23-111</b>
<b>RM17T•00 phase measurement relays</b>	<b>23-112</b>
<b>RM17UAS voltage measurement relays</b>	<b>23-113</b>
<b>RM17UB voltage measurement relays</b>	<b>23-113</b>
<b>RM17UBE voltage measurement relays</b>	<b>23-113</b>
<b>RM35AT temperature control relays</b>	<b>23-114</b>
<b>RM35BA10 pump control relays</b>	<b>23-114</b>
<b>RM35HZ frequency control relays</b>	<b>23-114</b>
<b>RM35JA current measurement relays</b>	<b>23-111</b>

<b>RM35L•••MW level control relays</b>	<b>23-114</b>
<b>RM35S speed control relays</b>	<b>23-114</b>
<b>RM35UA1•MW voltage measurement relays</b>	<b>23-113</b>
<b>RM35UB voltage measurement relays</b>	<b>23-113</b>
<b>RMC analog interface modules</b>	<b>23-118</b>
<b>RMP analog interface modules</b>	<b>23-118</b>
<b>RMT analog interface modules</b>	<b>23-118</b>
<b>robotics</b>	<b>27-21</b>
<b>rotary handles, PowerPact™ circuit breakers</b>	<b>7-51</b>
<b>RPF power relays</b>	<b>23-13–23-14</b>
<b>RPM plug-in relays</b>	<b>23-9</b>
<b>RPZ</b>	
accessories	23-10
sockets	23-10
<b>RSB interface relays</b>	<b>23-3</b>
<b>RSL interface relays</b>	<b>23-2</b>
<b>RSLZ</b>	
accessories	23-2
sockets	23-2
<b>RSZ</b>	
accessories	23-3, 23-63
sockets	23-3
<b>RTUs (remote terminal units)</b>	
Easergy T300	5-33
power supplies	5-34
Easergy™ T300	5-32
SAGE	5-27–5-31
<b>RUM plug-in relays</b>	<b>23-11</b>
<b>RUW</b>	
protection modules	23-10, 23-12
timer modules	23-10, 23-12
<b>RUZ</b>	<b>23-102</b>
accessories	23-12
sockets	23-12
<b>RXG interface relays</b>	<b>23-4</b>
<b>RXM</b>	
plug-in relays	23-6
protection modules	23-8, 23-10
<b>RXZ</b>	<b>23-103</b>
accessories	23-8
sockets	23-8, 23-63
<b>RZM protection modules</b>	<b>23-3–23-4</b>

## S

<b>safety chain solutions</b>	<b>25-3</b>
<b>safety controllers, XPSMCM</b>	<b>25-3</b>
<b>safety interlock switches</b>	
XCS	25-6
XCSDM non-contact	25-6
<b>safety limit switches</b>	
XCS	25-7
XCSDM	25-7
XCSP/XCSD	25-7
<b>safety relays, XPS</b>	<b>25-3</b>
<b>safety switches</b>	<b>3-16, 3-20</b>
Appleton Powertite receptacle	3-14
class H, R, J, L fuse provisions	3-9
class R fuse kits	3-16
cover viewing window	3-20
Crouse-Hinds Arktite receptacle	3-14
double throw	3-25–3-26
electrical interlock kits	3-16
equipment grounding kits	3-18
fusible and non-fusible	3-25
general duty	3-4
heavy duty	3-8
316 grade stainless steel, NEMA Type 3, 3R, 4, 4X, 5, 12	3-12

applications	3-12	<b>service upgrade panels</b>	<b>1-11</b>
fiberglass reinforced polyester enclosures, NEMA Type 4X	3-12	<b>Servicepak power outlet</b>	
Hubbelock receptacle	3-15	panels	
internal barrier kits	3-16	construction sites	1-44
key interlock systems	3-19	recreational vehicle parks	1-44
Krydon enclosures, NEMA Type 4X	3-13	<b>services</b>	
light duty	3-3	AC drives	26-32
lock-on provisions	3-19	all Schneider Electric services	29-8
lug kits	3-20	consulting services	29-8
NEMA 7 and 9	3-13	EcoStruxure™	29-8
ratings	3-11	field services	29-8
single throw fusible	3-4	<b>servo motors</b>	<b>27-20–27-21</b>
single throw non-fusible	3-11	<b>severe duty</b>	<b>21-43</b>
<b>SAGE remote terminal units (RTUs)</b>		limit switches	21-43
product matrix	5-27	<b>shielded solid insulation system</b>	<b>11-14</b>
SAGE 1410	5-30	<b>shipping</b>	
SAGE 1430	5-30	integrated power center 2	10-8
SAGE 1450	5-31	integrated power center, IPC	10-7
SAGE 2400	5-28	modular panelboard system, MPS	10-7
SAGE 3030 Magnum	5-29	<b>sine wave tracking module (SWT) for SPD</b>	<b>6-2</b>
SAGE 4400	5-29	<b>single throw non-fusible safety switches</b>	<b>3-11</b>
<b>SB/SF switchboards</b>	<b>11-6</b>	<b>sirens and electronic alarms, XVS</b>	<b>19-126</b>
<b>SCADA</b>	<b>27-14</b>	<b>slip-on connectors</b>	<b>24-20</b>
<b>SCADA software</b>	<b>4-6</b>	<b>slow trip</b>	<b>16-133</b>
<b>Schneider Electric services</b>	<b>29-8</b>	<b>slow trip, thermal unit selection</b>	<b>16-133</b>
<b>sealed non-ventilated and transformer house</b>	<b>14-13</b>	<b>smart home, Wiser Energy</b>	<b>1-41</b>
<b>selection guides</b>		<b>sockets</b>	<b>23-102–23-103</b>
control stations	19-4	8501NR	23-60, 23-62–23-63, 23-110
disconnect switches	8-2	RGZ	23-4
limit switches	21-8	RPZ	23-10
Masterpact™ circuit breakers	7-9–7-10	RSLZ	23-2
operating mechanisms	8-2	RSZ	23-3
pilot lights	19-2	RUZ	23-12, 23-102
power and energy meters	4-13, 4-19	RXZ	23-8, 23-63, 23-103
push buttons	19-2–19-3	SSLZ	23-70
tower lights and beacons	19-5–19-6	<b>soft starters</b>	
<b>selection information</b>	<b>7-4</b>	Altistart 48™	26-8, 26-29
miniature circuit breakers	7-2–7-5	Altistart™ 01	26-7
molded-case circuit breakers	7-6–7-8	Altistart™ 22	26-7–26-8, 26-28
<b>selector switches</b>	<b>19-30</b>	Altistart™ 22 (Enclosed)	26-30
22 mm push buttons	19-30	Altistart™ 48	26-7
9001K 2-position, 30 mm	19-75	Altistart™ ATSU01 and TeSys™ U	18-51
9001K 3-position, 30 mm	19-76	<b>software</b>	
9001K 4-position, 30 mm	19-77	EcoStruxure™ Machine Expert	27-3
9001SK 2-position, 30 mm	19-85	PL7™ application	27-4
9001SK 3-position, 30 mm	19-86	ProClima	28-3
9001SK 4-position, 30 mm	19-87	SoMachine™	27-3
guide for Type K, KX, and SK, 30 mm	19-78	Spacial.pro	28-3
point of purchase blister packs	19-114	Spacial.ref	28-3
Type K, KX, and SK	19-78	Thalassa.ref	28-3
Type KX (square) 30 mm	19-104	Unity Pro	27-5
Type KX (square) with contacts	19-102	Vijeo Citect	27-14
<b>sensor plugs, Micrologic™ trip units</b>	<b>7-62</b>	<b>Software for HMI Products</b>	<b>27-13</b>
<b>SEPAM protection relays</b>		<b>solar ready CSED</b>	<b>1-39</b>
characteristics	5-7	<b>solid neutral</b>	<b>16-130</b>
model functions	5-6	<b>solid neutral accessories</b>	<b>16-130</b>
<b>Sepam™ protection relays</b>	<b>5-2, 5-5</b>	<b>solid neutral assemblies</b>	<b>7-16</b>
applications	5-10–5-15	<b>solid state overload relay</b>	<b>16-101</b>
series 20	5-8	<b>solid state overload relay accessories</b>	<b>16-129</b>
series 40	5-8	<b>solid state overload relay protection, Motor Logic</b>	<b>16-33</b>
series 80	5-9	<b>solid-state interface modules</b>	<b>23-118</b>
<b>separate enclosures</b>	<b>16-111</b>	<b>solid-state overload relay protection Motor Logic</b>	<b>16-62</b>
<b>serial timer modules</b>	<b>23-89</b>	<b>solid-state relays</b>	<b>23-68</b>
<b>series ratings</b>		Zelio SSL	23-70
I-Line™ panelboards	9-6, 9-9	Zelio SSM	23-70
NF panelboards	9-6	Zelio SSP	23-70
NQ panelboards	9-2	<b>SoMachine™ software suite</b>	<b>27-3</b>
<b>service ground kits</b>	<b>7-85</b>	<b>SoMove Software</b>	

TeSys T	16-107	EMA (external modular assembly)	6-2
<b>Spacial.pro software</b>	<b>28-3</b>	externally mounted	6-2
<b>Spacial.ref software</b>	<b>28-3</b>	flush mount kits	6-2
<b>Spacial™ stainless steel enclosures</b>	<b>28-6–28-7</b>	for CSEDs and load centers	1-27
<b>Spacial™ steel enclosures</b>	<b>28-2, 28-4, 28-7</b>	internally mounted, new construction and retrofit	6-4
<b>SPD</b>		remote monitor option	6-2
for CSEDs and load centers	1-27	replacement modules	6-3
OEM/assembler kits	6-7	residential whole house	6-11
replacement modules	6-3	sine wave tracking module (SWT) for SPD	6-2
<b>special application QO load centers specifications</b>	<b>1-11</b>	SurgeLogic HWA SPDs	6-9
limit switches	21-8	SurgeLogic™ XDSE	6-8
<b>speed control relays, Zelio RM35S</b>	<b>23-114</b>	XR nipple-mounted	6-9
<b>Speed-D</b>	<b>11-6</b>	<b>SurgeLogic HWA SPDs</b>	<b>6-9</b>
SB/SF switchboards	11-6	<b>SurgeLogic surge protective devices (SPD)</b>	<b>6-6</b>
<b>Speed-D switchboards</b>	<b>11-6</b>	<b>SurgeLogic™ SPD units</b>	<b>6-5</b>
<b>SPQ</b>		<b>switch enclosure</b>	<b>11-12</b>
cam-lock tap box	10-7	<b>switch enclosure, MiniBreak compact height</b>	<b>11-12</b>
lug-lug tap box	10-7	<b>switchboard</b>	<b>11-2–11-3</b>
<b>spring-charging motors</b>		<b>switchboards</b>	<b>11-2</b>
PowerPact™ P-frame	7-50	Power-Style	11-2
<b>Square D</b>		QED-2	11-2
Type C relays	23-65	<b>switches</b>	
Type JCK timers	23-109	9001K selector	19-75
Type K relays	23-60	biometric	19-66
Type R relays	23-62–23-63	foot, heavy duty industrial	19-139
Type X relays	23-94	industrial snap	21-6
<b>SSL solid-state relays</b>	<b>23-70</b>	PowerPact™ automatic molded case	7-44
<b>SSLZ sockets</b>	<b>23-70</b>	QO™ non-automatic	1-7, 7-14
<b>SSM solid-state relays</b>	<b>23-70</b>	rotary cam, Type K	19-141
<b>SSP solid-state relays</b>	<b>23-70</b>	rotary cam, Type K ordering instructions	19-142–19-144
<b>stainless steel enclosures</b>		safety, general duty	3-4
304L	28-2	safety, light duty	3-3
316L	28-2	XB6 keyed selector	19-18
<b>stainless steel enclosures, Spacial™</b>	<b>28-6–28-7</b>	XB6 non-illuminated selector	19-17
<b>standard capacitor banks</b>	<b>4-36–4-37</b>	XB6E selector	19-23
<b>standard, classic</b>	<b>21-26</b>	<b>switchgear</b>	<b>11-17</b>
<b>standby power connection solutions</b>	<b>10-2, 10-7</b>	gas-insulated	11-28–11-29
<b>starter accessories</b>	<b>16-126</b>	medium voltage metal-enclosed	
replacement parts kits	16-126	CBGS-0	11-29
<b>starters</b>	<b>16-125, 16-127, 16-129–16-130</b>	DVCAS	11-30
accessories	16-127	gas-insulated	11-28–11-29
baseplate	16-126	GHA	11-28
melting alloy	16-126	HVL	11-22
universal baseplate	16-126	HVL/cc	11-15
control circuit fuse holder	16-130	MiniBreak	11-12
cover-mounted control units	16-127	wind farm applications	11-30
GV manual starters and protectors	18-32	switchgear	
power pole adders	16-129	gas-insulated	11-28–11-29
replacement parts kits	16-125	medium voltage metal-enclosed	
<b>steel enclosures, Spacial™</b>	<b>28-7</b>	gas-insulated	11-28–11-29
<b>stepper motors</b>	<b>27-20–27-21</b>	wind farm applications	11-30
<b>sub-feed circuit breakers</b>		wind farm applications	11-30
cabinet data	9-41	wind farm applications	11-30
NQ panelboards	9-17	<b>switchgear quick ship program</b>	<b>11-17</b>
<b>sub-feed lugs</b>		<b>switchgear, low voltage metal-enclosed drawout</b>	<b>11-10</b>
NQ panelboards	9-17	<b>system protection</b>	
<b>submeter display (SMD)</b>	<b>4-26</b>	arc flash mitigation V125	5-2–5-3
<b>submetering integrated power center</b>	<b>10-7</b>	ECOFIT 50/51 relays	5-2, 5-4
<b>sump application float switches</b>	<b>22-28–22-29</b>	MiCOM digital relays	5-2, 5-16, 5-18, 5-20–5-26
<b>supplementary protectors</b>		SEPAM digital relays	5-6–5-7
QYU UL 1077	7-17	Sepam™ digital relays	5-2, 5-5, 5-8–5-15
<b>supplementary protectors, Multi 9™</b>			
busbars	7-26–7-27		
<b>support</b>			
drives, AC	26-32		
natural disasters support	29-8		
<b>surge protective devices (SPD)</b>	<b>1-27, 6-12</b>		
		<b>T</b>	
		<b>tables 1148</b>	<b>16-138</b>
		<b>tables 1148, thermal unit selection</b>	<b>16-138</b>
		<b>tandem QOT miniature circuit breakers</b>	<b>1-4, 7-12</b>
		<b>tap box</b>	

cam-lock	10-7	<b>terminal lug data for double throw safety switches</b>	<b>3-31</b>
lug-lug	10-7	<b>terminal shields, PowerPact™</b>	<b>7-57</b>
<b>tap kit, QO™ load centers</b>	<b>1-11</b>	<b>test block bypass sockets, meter sockets</b>	<b>2-3</b>
<b>tees</b>		<b>TeSys</b>	
trench duct	13-8	DF fuseholders	24-29
<b>Telefast 2 connection system</b>	<b>24-32</b>	Type D relays	23-87
<b>temperature control relays, Zelio RM35AT</b>	<b>23-114</b>	Type K relays	23-90
<b>tenant circuit breakers</b>	<b>2-7</b>	Type SK relays	23-93
<b>terminal accessories, PowerPact™</b>	<b>7-57</b>	<b>TeSys AK5</b>	
<b>terminal block, tie point</b>	<b>16-130</b>	panel busbar system	18-59
<b>terminal blocks</b>		<b>TeSys AK5 panel busbar system</b>	<b>18-58</b>
custom assemblies	24-21	<b>TeSys D 16-16, 16-20, 16-23–16-27, 18-6–18-9, 18-13, 18-16–18-17, 18-21, 18-71</b>	
end clamps	24-18, 24-22	AC coils	18-52
fanning strips	24-22	accessories	16-18, 16-20, 18-13, 18-15–18-16, 18-21
IEC hybrid	24-1	auxiliary contacts	16-18, 18-14
IEC push-in	24-1	cabling accessories	16-20, 18-16
blade isolators	24-15	capacitor	18-9
component carriers	24-15	coil suppressors	16-20, 18-16
double deck grounding	24-15	contactors, capacitor	18-9
double deck passthrough	24-15	contactors, non-reversing	18-6–18-7
grounding	24-13	contactors, reversing	18-6, 18-9, 18-18
passthrough	24-13	dimensions	18-60
IEC screw style	24-1	electronic timers	16-23–16-27, 18-17
blade isolators	24-10	interface modules	16-23–16-27, 18-17
component carriers	24-10	non-reversing	18-7
double deck grounding	24-9	repair parts	18-52, 18-55
double deck passthrough	24-9	reversing	18-9
fused	24-10	<b>TeSys D and F</b>	<b>16-18, 18-14</b>
grounding	24-7, 24-10	<b>TeSys F</b>	<b>18-10, 18-13, 18-19, 18-57</b>
hybrid	24-11	AC coils	18-54
hybrid grounding	24-11	accessories	16-18, 18-13, 18-15, 18-19–18-20, 18-57
lug-clamp	24-9	auxiliary contacts	16-18, 18-14
lug-lug	24-9	contactors, non-reversing	18-10
measuring	24-10	contactors, reversing	18-10
miniature grounding	24-11	non-reversing	18-10
miniature passthrough	24-11	overload relay accessories	18-21
passthrough	24-7, 24-9	repair parts	18-54, 18-56
triple deck passthrough	24-9	reversing	18-10
IEC spring style	24-1, 24-3	<b>TeSys GV</b>	<b>18-50</b>
blade isolators	24-5	<b>TeSys GV manual starters and protectors</b>	<b>18-77, 18-79</b>
component carriers	24-5	accessories	18-33, 18-35, 18-50
double deck grounding	24-5	dimensions	18-77, 18-79
double deck passthrough	24-5	<b>TeSys K</b>	<b>18-2, 18-13</b>
grounding	24-4	contactors and accessories	18-13
miniature passthrough DIN mount	24-6	<b>TeSys N</b>	<b>16-21</b>
miniature passthrough direct mount	24-6	electronic timers	16-21
miniature passthrough for mounting plates	24-6	interface modules	16-21
passthrough	24-3	<b>TeSys T</b>	
triple deck passthrough	24-5	HMIhuman machine interface	16-105
jumpers	24-22	LTMCU compact display	16-105
marking accessories	24-16–24-17, 24-23	LTME expansion module	16-105
mounting track	24-18, 24-22	LTMR controller	16-104
NEMA screw style	24-1	Magelis Display	16-105
NEMA style, Type G	24-19, 24-21	motor management system	16-103
blown fuse indicators	24-20	LTMCU compact display	16-105
circuit isolating switches	24-20	LTME expansion module	16-105
flat terminal connectors	24-20	LTMR controller	16-104
fuse blocks	24-20	Magelis display	16-105
fuse pullers	24-20	motor management systems	
pressure wire connectors	24-20	HMIhuman machine interface	16-105
slip-on connectors	24-20	SoMove Software configuration	16-107
transient voltage suppressors	24-20	<b>TeSys U</b>	<b>18-22, 18-51, 18-75</b>
solderless box lugs	24-19	dimensions	18-75–18-76
standard assemblies	24-21	motor starters	18-22
<b>terminal data</b>	<b>9-65</b>	soft starters	18-51
I-Line™ panelboards	9-65	<b>TeSys U-Line</b>	
NF panelboards	9-65	power bases	16-12
NQ panelboards	9-65	<b>Thalassa.ref software</b>	<b>28-3</b>
QMB branch switches	9-65		

<b>Thalassa™ polyester enclosures</b>	<b>28-2</b>	<b>Transparent Ready solutions</b>	<b>27-18</b>
accessories	28-8	<b>trench duct</b>	<b>13-7–13-8</b>
floor-standing	28-8	accessories	13-8
wall-mounting	28-8	crosses	13-8
<b>thermal magnetic circuit breaker</b>	<b>16-54–16-55, 16-70–16-71</b>	elbows	13-8
<b>thermal magnetic circuit breakers</b>		fittings	13-7
PowerPact™ B-frame	7-30	tees	13-8
PowerPact™ H-frame	7-31	<b>trench duct wire management</b>	<b>13-8</b>
PowerPact™ J-frame	7-31	<b>trip units</b>	<b>11-11</b>
PowerPact™ Q-frame	7-34	Micrologic	11-11
<b>thermal overload relays</b>		PowerPact™ H- J- and L-frame	7-59
NEMA style		PowerPact™ P and R-frame	7-60
bimetallic, adapted	16-110	<b>two speed</b>	<b>16-5</b>
dimensions	16-102	<b>two-speed</b>	
melting alloy	16-100	manual switches	16-5
solid state overload relay	16-101	<b>Type 1 surge protective devices (SPD)</b>	<b>6-2</b>
<b>thermal unit selection</b>	<b>16-133, 16-136</b>	<b>Type B standard duty control stations</b>	
calculation of rip current rating	16-136	replacement parts	19-111
general	16-133	<b>Type C power relays</b>	<b>23-65</b>
horsepower and voltage	16-137	<b>Type JCK timers</b>	<b>23-109</b>
slow trip	16-133	<b>type k</b>	<b>16-5</b>
tables 1148	16-138	<b>Type K heavy duty operators</b>	<b>19-72</b>
<b>thermal units, mounting</b>	<b>16-137</b>	<b>Type K heavy duty pilot lights</b>	<b>19-79</b>
<b>thermal-magnetic</b>	<b>7-35</b>	<b>Type K rotary cam switches</b>	<b>19-141–19-142</b>
<b>thermal-magnetic circuit protectors</b>	<b>24-24–24-25</b>	<b>Type K universal relays</b>	<b>23-60</b>
<b>thermostats for enclosures</b>	<b>28-3, 28-10</b>	<b>Type K, SK common operators</b>	<b>19-9</b>
<b>tie point terminal block</b>	<b>16-130</b>	<b>Type KX square multifunction operators</b>	<b>19-102</b>
<b>timer modules, RUW</b>	<b>23-10, 23-12</b>	<b>Type R miniature relays</b>	<b>23-63</b>
<b>timers</b>	<b>23-100, 23-109</b>	<b>Type R plug-in relays</b>	<b>23-62</b>
general purpose plug-in	23-109	<b>Type S</b>	
miniature plug-in	23-103	accessories	
modular	23-100	baseplate	16-126
panel mount	23-102	melting alloy	16-126
Square D Type JCK	23-109	universal baseplate	16-126
Zelio RE17	23-100	<b>Type SK corrosion resistant pilot lights</b>	<b>19-88</b>
Zelio RE48	23-102	<b>Type W non-reversing vacuum starters</b>	<b>16-45</b>
Zelio REXL	23-103	<b>Type X</b>	
<b>timing relays</b>		adder decks	23-98
NEMA style, AC	23-94	cartridges	
NEMA style, DC	23-96	contact	23-98
<b>tower lights and beacons</b>		master	23-98
point of purchase blister packs	19-114	overlapping	23-98
selection guide	19-5–19-6	standard	23-98
XVB 70 mm beacons	19-115–19-117	manual test tool	23-98
XVC 40, 60, and 100 mm tower lights	19-118	mechanical latch attachment	23-98
XVGU multi-color USB tower lights	19-124	mounting track	23-98
XVR pre-wired rotating mirror beacons	19-125	NEMA relays	23-94
<b>track adapter, Type FB</b>	<b>24-28</b>	pneumatic timer attachment	23-98
<b>transformer combo</b>	<b>10-3</b>	timer lockout cover	23-98
IPC2	10-3	transient suppressor	23-98
<b>transformer connections</b>	<b>11-24</b>	<b>Types SBSD with auxiliary load terminals</b>	<b>16-37</b>
<b>transformer section</b>	<b>11-35</b>		
<b>transformers</b>	<b>11-24</b>		
1,201–15,000 Vac			
single-phase indoor	14-21–14-23		
three-phase indoor	14-21–14-22		
disconnects	14-19		
dry type	14-21		
EE medium voltage, dry type	14-21		
general purpose dry type	14-3		
industrial control	14-14		
Power-Cast	11-24		
sealed non-ventilated and transformer house	14-13		
Uni-Cast	11-24		
<b>transient suppression module</b>	<b>16-130</b>		
<b>transient suppression module accessories</b>	<b>16-130</b>		
<b>transient suppressor modules</b>	<b>23-90</b>		
<b>transient voltage suppressors</b>	<b>24-20</b>		
<b>transition section meter centers</b>	<b>2-19</b>		

**U**

<b>UL and NEMA universal enclosure ratings</b>	<b>28-3</b>
<b>UL Listing</b>	
universal enclosures	28-3
<b>ultrasonic sensors</b>	
30 mm	20-12
Virtu™ VM1 and VM18	20-11
XUV and XXV	20-10
<b>Uni-Cast</b>	<b>11-24</b>
transformer connections	11-24
transformers	11-24
<b>unit substation</b>	
distribution section	11-36
transformer section	11-35
<b>unit substations</b>	<b>11-34</b>

<b>Unity Pro</b>	<b>27-5</b>
<b>Unity Pro application software</b>	<b>27-5</b>
<b>universal baseplate</b>	<b>16-126</b>
<b>universal enclosures</b>	
UL Listing	28-3
<b>universal relays, Square D Type K</b>	<b>23-60</b>
<b>utility relays, NEMA style, DC</b>	<b>23-96</b>

**V**

<b>vacuum circuit breaker</b>	<b>11-32</b>
<b>vacuum switches</b>	<b>22-22</b>
renewal parts	22-34
<b>value packs</b>	<b>1-25</b>
<b>VAR compensator (HVC) hybrid</b>	<b>4-44</b>
<b>Vario manual motor control switches</b>	<b>8-5</b>
<b>Vario™ assembled and enclosed switches</b>	<b>8-3</b>
<b>VarSet</b>	
automatic capacitor banks	
fast capacitor	4-39
capacitor banks	
capacitor	4-35
detuned capacitor banks	
standard capacitor	4-37
standard capacitor banks	
standard capacitor	4-36
<b>ventilation systems for enclosures</b>	<b>28-3, 28-9</b>
<b>Vijeo Citect</b>	<b>27-14</b>
<b>Vijeo Citect software</b>	<b>27-14</b>
<b>Vijeo™ software</b>	<b>27-13</b>
<b>VM ultrasonic sensors</b>	<b>20-11</b>
<b>VM1 and VM18 ultrasonic sensors</b>	<b>20-11</b>
<b>voltage measurement relays</b>	
Zelio RM17UAS	23-113
Zelio RM17UB	23-113
Zelio RM17UBE	23-113
Zelio RM35UA1-MW	23-113
Zelio RM35UB	23-113

**W**

<b>wall duct</b>	<b>13-5</b>
accessories	13-5–13-6
Class 5250	13-5
components	13-5
wire management	13-5
<b>wall mounting bracket, transformer</b>	<b>14-13</b>
<b>wall-mounting enclosures</b>	<b>28-2, 28-7–28-8</b>
<b>water pump pressure switches</b>	<b>22-24</b>
<b>Well-Guard</b>	<b>16-93–16-94</b>
pump panels	16-95
<b>Well-Guard pump panels</b>	<b>16-93–16-94</b>
<b>whole house</b>	<b>6-11</b>
<b>wind farm applications</b>	<b>11-30</b>
<b>wire management</b>	<b>13-2, 13-5</b>
wall duct	13-5
wireway	13-2
<b>wire sizes for QO/QOB miniature circuit breakers</b>	<b>1-4, 7-12</b>
<b>wireless push buttons</b>	<b>19-63</b>
<b>wireway</b>	<b>13-2–13-4</b>
general purpose (NEMA Type 1)	13-2
oiltight (NEMA Type 12)	13-3
raintight (NEMA Type 3R)	13-4
raintight trough (NEMA Type 3R)	13-4
wire management	13-2
<b>Wiser Energy</b>	<b>1-41</b>
<b>without enclosures</b>	<b>21-6</b>
<b>worksheets</b>	

9003K2 Type K2 cam switch	19-142–19-143
Type SKYP pendant stations	19-138
Type XACA pendant stations	19-136

**X**

<b>XAL 22 mm control stations</b>	<b>19-107</b>
<b>XAP enclosures and accessories</b>	<b>19-108</b>
<b>XB4</b>	<b>19-24, 19-35</b>
electrical components	19-35
emergency stop operators	19-29
illuminated operators	19-33
selector switches	19-30
specialty operators	19-31
<b>XB4 22 mm</b>	
accessories	19-40
common operators	19-8
illuminated operators	19-33
legend holders and inserts	19-38–19-39
legend sheets	19-39
operators	19-27
pilot lights	19-32
<b>XB4R wireless metal push buttons</b>	<b>19-63</b>
<b>XB5</b>	<b>19-43, 19-55</b>
complete devices	19-43
electrical components	19-55
specialty operators	19-51
<b>XB5 22 mm</b>	
accessories and legend sheets	19-60
common operators	19-8
electrical components	19-55
emergency stop operators	19-49
legend holders and inserts	19-59
operators, illuminated	19-53
operators, non-illuminated	19-46
pilot lights	19-52
selector switches	19-50
specialty operators	19-51
XB5 legend holders and inserts	19-58
<b>XB5R wireless plastic push buttons</b>	<b>19-63</b>
<b>XB6</b>	
accessories	19-20
push button caps	19-19
<b>XB6 16 mm</b>	
complete devices	19-12
electrical components	19-15
keyed selector switches	19-18
legend holders and inserts	19-20
operators, illuminated	19-16
selector switches, non-illuminated	19-17
<b>XB6 16 mm push buttons</b>	
operators, non-illuminated	19-16
<b>XB6E</b>	
accessories	19-23
flush, spring return push buttons	19-21
illuminated push buttons, latching	19-22
illuminated push buttons, spring return	19-22
pilot lights	19-21
selector switches	19-23
<b>XB7 22 mm</b>	
illuminated push buttons with projecting push	19-69
legend holders and inserts	19-71
mushroom head push buttons	19-70
pilot lights	19-69
push buttons	19-68
selector and key switches	19-70
<b>XCK limit switches</b>	<b>21-12</b>
<b>XCK... limit switches</b>	<b>21-19</b>

<b>XCKJ</b>			
bodies and options	21-33	SSL relays	23-70
operating heads	21-34	SSM relays	23-70
operating heads, replacement parts, and levers	21-35	SSP relays	23-70
precision switches with direct acting contacts	21-32	temperature control relays	23-114
<b>XCKJ industrial format EN 50041</b>	<b>21-30</b>	voltage measurement relays	23-113
<b>XCKJ precision switches with direct acting contacts</b>			
limit switches	21-32		
<b>XCKL</b>			
complete switches	21-28		
exploded view	21-26		
<b>XCKL Components</b>	<b>21-29</b>		
<b>XCKL, XCKM</b>	<b>21-26</b>		
<b>XCKM limit switches</b>	<b>21-26</b>		
<b>XCMD</b>	<b>21-10</b>		
<b>XCMD limit switches</b>	<b>21-10</b>		
<b>XCS safety interlock switches</b>	<b>25-6</b>		
<b>XCS safety limit switches</b>	<b>25-7</b>		
<b>XCSDM non-contact safety interlock switches</b>	<b>25-6</b>		
<b>XCSM safety limit switches</b>	<b>25-7</b>		
<b>XCSP/XCSD safety limit switches</b>	<b>25-7</b>		
<b>XCSR</b>	<b>25-7</b>		
<b>XML electronic pressure sensors</b>	<b>22-4</b>		
<b>XML industrial pressure switches</b>	<b>22-13</b>		
<b>XML international</b>	<b>22-15</b>		
<b>XML international pressure switches</b>	<b>22-15</b>		
<b>XMLG electronic</b>	<b>22-4</b>		
<b>XMLG electronic pressure transmitters</b>	<b>22-4</b>		
<b>XMLK electronic</b>	<b>22-9-22-10</b>		
<b>XMLK electronic pressure transmitters</b>	<b>22-9</b>		
<b>XPS safety relays</b>	<b>25-3</b>		
<b>XPSMCM modular safety controllers</b>	<b>25-3</b>		
<b>XR nipple-mounted</b>	<b>6-9</b>		
<b>XS basic and basic plus proximity sensors</b>	<b>20-8</b>		
<b>XS basic series proximity sensors</b>	<b>20-5-20-7</b>		
<b>XUB tubular photoelectric sensors</b>	<b>20-2</b>		
<b>XUK and XUX compact photoelectric sensors</b>	<b>20-4</b>		
<b>XUV and XXV ultrasonic sensors</b>	<b>20-10, 20-12</b>		
<b>XUVR / XUVA optical fork photoelectric sensors</b>	<b>20-3</b>		
<b>XVB 70 mm beacons</b>	<b>19-115-19-117</b>		
<b>XVC 40, 60, and 100 mm tower lights</b>	<b>19-118</b>		
<b>XVGU multi-color USB tower lights</b>	<b>19-124</b>		
<b>XVR pre-wired rotating mirror beacons</b>	<b>19-125</b>		
<b>XY2 cable pull switches</b>	<b>25-8</b>		

**Z**

<b>ZBRN1 and ZBRN2 access points</b>	<b>19-65</b>
<b>ZCK... limit switches</b>	<b>21-19</b>
<b>Zelio</b>	
analog interface modules	23-118
frequency control relays	23-114
level control relays	23-114
pump control relays	23-114
RE17 timers	23-100
RE48 timers	23-102
REXL timers	23-103
RM17JC current measurement relays	23-111
RM17T-00 phase measurement relays	23-112
RM35JA current measurement relays	23-111
RPF relays	23-13
RPM relays	23-9
RSB relays	23-3
RSL relays	23-2
RUM relays	23-11
RXG relays	23-4
RXM relays	23-6
speed control relays	23-114



A					
A100 – A400L	1-37, 2-3	AL30FD	9-29	ATV212WU15N4 – ATV212WU75N4	26-10
A5J	2-3	AL400L61K3	2-21, 7-54	ATV312H018M2 – ATV312H075S6	26-13
AA	21-45	AL400L61K4	7-54	ATV312HD11M3 – ATV312HD15S6	26-13
AAP	1-37, 2-3	AL600LF52K3	7-54	ATV312HU11M2 – ATV312HU75S6	26-13
AB	21-45	AL600LS52K3	7-54	ATV320D11M3C – ATV320D15S6C	26-15
AB1G ( )	16-107, 23-92	AL600LS52K4	7-54	ATV320U02M2B – ATV320U75S6C	26-15
AB1R ( )	16-107, 23-92	AL800M23K	7-54	ATV340D11N4 – ATV340U75N4	26-17
ABL1REM12050 – ABL1RPM24100	23-117	AL800M23K4	7-54	ATV340D11N4E – ATV340U75N4E	26-17
ABL7RM24025	23-117	AL800P6K	7-54	ATV61HC11Y – ATV61HC80Y	26-18
ABL7RP1205	23-117	AL800P6K4	7-54	ATV61HD15Y – ATV61HD90Y	26-18
ABL7RP4803	23-117	AL800P7K	7-54	ATV61HU22S6X – ATV61HU75S6X	26-18
ABL8MEM05040 – ABL8MEM24012	23-117	AL800P7K4	7-54	ATV630C11N4 – ATV630U75Y6	26-24
ABL8REM24030	23-117	AL800SN	7-83, 7-85	ATV650D11N4U – ATV650U75N4U	26-24
ABL8REM24050	23-117	AM	21-45	ATV71H037M3	26-20
ABL8RPM24200	23-117	AM1DL201	18-59	ATV71H037M3T1	26-20
ABL8RPS24030	23-117	AM1DP200	18-15	ATV71H037M3Z	26-20
ABL8RPS24030	7-76	AO	21-45	ATV71H075M3 – ATV71H075M3Z	26-19 – 26-20
ABL8RPS24050	23-117	AP2308G10ST – AP2340G10ST	12-7	ATV71H075N4 – ATV71H075N4Z	26-21
ABL8RPS24050	7-76	AP2508G10ST – AP2540G10ST	12-7	ATV71HC11N4 – ATV71HC63Y	26-21
ABL8RPS24100	23-117	AP30210 – AP306LT ( )	12-6	ATV71HD11M3X – ATV71HD75M3X	26-20
ABL8RPS24100	7-76	AP50210 – AP506LT ( )	12-6	ATV71HD11M3XT1 – ATV71HD75M3XT1	26-20
ABL8WPS24200	23-117	APJ10487	3-14	ATV71HD11N4 – ATV71HD90Y	26-21
ABL8WPS24400	23-117	APJ3485	3-14	ATV71HD15M3X – ATV71HD45M3X	26-19 – 26-20
ABR1E101M – ABR1S618E	23-120	APJ6485	3-14	ATV71HD15M3XT1 – ATV71HD45M3XT1	26-19
ABR2E111M – ABR2SB312B	23-120	APP2D1	18-58	ATV71HU15M3 – ATV71HU75M3Z	26-19 – 26-20
ABS2EA02EF	23-119	APP2D1D	18-58	ATV71HU15M3T1 – ATV71HU75M3T1	26-19 – 26-20
ABS2EA02EM	23-119	APP2D2	18-58	ATV71HU15N4 – ATV71HU75S6X	26-21
ABS2EC01EA	23-119	APP2D2D	18-58	ATV930C11N4C – ATV930U75Y6	26-25
ABS2EC01EB	23-119	APP2ER	18-58	ATV950D11N4U – ATV950U75N4U	26-25
ABS2EC01EE	23-119	APP2R2A	18-58	ATVPOT25K	26-11, 26-22
ABS2SA01MB	23-119	APP2R2AS	18-58	AV025046CV5F1N	4-39
ABS2SA02MB	23-119	APP2R2C	18-58	AV030046BV5F1N	4-39
ABS2SC01EB	23-119	APP2R2E	18-58	AV035046CV5F1N	4-39
ABS2SC02EB	23-119	APP2R4A	18-58	AV040046AV8F1N	4-39
ACF13EC – ACF88WF	12-8	APP2R4AS	18-58	AV045046CV5F2N	4-39
ACF38EC – ACF63WF	12-7	APP2R4C	18-58	AV050046AV8F2N	4-39
ACP	1-37, 2-3	APP2R4E	18-58	AV055046CV5F2N	4-39
ACP1034CD	3-14	APP2R4H1	18-58	AV060046AV8F2N	4-39
ACP2EC – ACP4WF	12-6	APP2R4H2	18-58	AV065046CV5F2N	4-39
ACP3034BC	3-14	APP2R4H3	18-58	AV070046AV8F2NN	4-39
ACP6034BC	3-14	APP2R4H4	18-58	AV075046CV5F2N	4-39
ACPA	2-3	AR	21-45	AV080046AV8F2N	4-39
ACPLA	1-37, 2-3	AR1MA01 – AR1MA0199	24-31	AZ5DE005 – AZ5DE025	24-30
ACPLA	2-3	AR1MB01 – AR1MC019	24-31		
AF2308G10ST – AF2340GLFM22	12-7	AR1SC01 – AR1SC03	24-31		
AF2508G10ST – AF2540GLFM22	12-7	ARP00026	1-37		
AH	21-45	ARP00026	2-3, 2-7, 2-21		
AK	21-45	ARP00118	2-3		
AK5JB1410	18-59	ARP00129	2-3		
AK5JB143	18-59	ARP00427	2-3		
AK5JB144	18-59	ASILUFC5	18-25		
AK5JB145	18-59	ASILUFC51	18-25		
AK5JB146	18-59	ASLSCR120	19-114		
AK5JB149	18-59	ASLSCR24	19-114		
AK5PA231	18-59	ASLSPR120	19-114		
AK5PA232	18-59	ASLSPR24	19-114		
AK5PA232S	18-59	AT045046AVBF2N	4-40		
AK5PC33	18-59	AT060046AVBF2N	4-40		
AK5PC33L	18-59	AT090046AVBF3N	4-40		
AK5PE27	18-59	AT120046AVBF3N	4-40		
AL0306F	8-35	AT1HB2	24-31		
AL100FD	9-29	AT1PA1 – AT1PA7	24-31		
AL10F	8-35	ATS22C11S6,S6U – ATS22D88S6,S6U	26-28		
AL1200P24K	7-54	ATS48C11Y – ATS48D88Y	26-29		
AL1200P25K	7-54	ATS48M10Y	26-29		
AL1200P25K4	7-54	ATS48M12Y	26-29		
AL1200P6KU	7-54	ATSU01N206LT	18-51		
AL1200P6KU4	7-54	ATSU01N209LT	18-51		
AL1200P7KU	7-54	ATSU01N212LT	18-51		
AL1200P7KU4	7-54	ATSU01N222LT	18-51		
AL1200R53K	7-54	ATSU01N232LT	18-51		
AL150HD	7-54	ATV12H018F1 – ATV12H075M3	26-12		
AL1650	21-45	ATV12HU15M2 – ATV12HU40M3	26-12		
AL16501	21-45	ATV12P037F1 – ATV12P075M3	26-12		
AL175JD	7-54	ATV12PU15M3 – ATV12PU40M3	26-12		
AL1802	21-45	ATV212H075M3X	26-10		
AL20DTF	3-21	ATV212H075N4	26-10		
AL2500RK	7-54	ATV212HD11M3X – ATV212HD75N4	26-10		
AL250JD	7-54	ATV212HU15M3X – ATV212HU75N4	26-10		
AL2820	21-45	ATV212W075N4	26-10		
		ATV212WD11N4 – ATV212WD75N4	26-10		

BH20512 ..... 21-32, 21-45  
 BH2053 ..... 21-32, 21-45  
 BH2056 ..... 21-32, 21-45  
 BH20912 ..... 21-32  
 BH2093 ..... 21-32  
 BH2096 ..... 21-32  
 BJL16015 – BJL16125 ..... 7-30  
 BJL2600S12 – BJL3600S12 ..... 7-44  
 BJL26015 – BJL26125 ..... 7-30  
 BJL36015 – BJL36125 ..... 7-30  
 BJL46015 – BJL46125 ..... 7-30  
 BKL16015 – BKL26030 ..... 7-30  
 BMK2Q400 ..... 1-37  
 BMXXCAUSBH018 ..... 19-124  
 BT045046AVBF2N ..... 4-40  
 BT060046AVBF2N ..... 4-40  
 BT090046AVBF3N ..... 4-40  
 BT120046AVBF3N ..... 4-40  
 BV025046CV5F1N ..... 4-39  
 BV030046BV5F1N ..... 4-39  
 BV035046CV5F2N ..... 4-39  
 BV040046AV8F2N ..... 4-39  
 BV045046CV5F2N ..... 4-39  
 BV050046AV8F2N ..... 4-39  
 BV055046CV5F2N ..... 4-39  
 BV060046AV8F2N ..... 4-39  
 BV065046CV5F2N ..... 4-39  
 BV070046AV8F2N ..... 4-39  
 BV075046CV5F3N ..... 4-39  
 BV080046AV8F3N ..... 4-39  
 BV4T002D – BV4T080D ..... 18-38  
 BV4T002J – BV4T080J ..... 18-38  
 BV4T115D ..... 18-38  
 BV4T115J ..... 18-38

**C**

C125RB ..... 1-32  
 C25S3HNV ..... 14-13  
 C2M200S ..... 1-32  
 C4L200S ..... 1-32  
 CA2KN22( ) – CA2KN407( ) ..... 23-90  
 CA2SK11 ..... 16-81  
 CA2SK11( ) ..... 23-93  
 CA2SK20( ) ..... 23-93  
 CA2SKE20( ) ..... 23-93  
 CA3KN22( ) – CA3KN407( ) ..... 23-90  
 CA3SK11( ) ..... 23-93  
 CA3SK20( ) ..... 23-93  
 CA4KN22( ) – CA4KN407( ) ..... 23-90  
 CAB12 ..... 4-9  
 CAB30 ..... 4-9  
 CAB4 ..... 4-9  
 CAD32 – CAD506 ..... 23-87  
 CBL008 ..... 4-26  
 CBL016 ..... 4-26  
 CBL017 ..... 4-26  
 CBL018 ..... 4-26  
 CBL019 ..... 4-26  
 CBL020 ..... 4-26  
 CBL021 ..... 4-26  
 CBL022 ..... 4-26  
 CBL023 ..... 4-26  
 CBL024 ..... 4-26  
 CBL031 ..... 4-26  
 CBL033 ..... 4-26  
 CF2308G10ST – CF2350GLFM21 ..... 12-7  
 CF2508G10ST – CF2550GLFM21 ..... 12-7  
 CL0306F ..... 3-20  
 CL0306F ..... 8-35  
 CL10F ..... 3-20  
 CL10F ..... 8-35  
 CL20F ..... 3-20  
 CL40F ..... 3-20  
 CL60F ..... 3-20  
 CLUSRETOOL ..... 7-72  
 CLUSTOOLSK ..... 7-72  
 CM200S ..... 1-32  
 CM4000T ..... 4-9  
 CMB363 ..... 14-8, 14-13  
 CMB364 ..... 14-8, 14-13

CMB380 ..... 14-8, 14-13  
 CMB381 ..... 14-8, 14-13  
 CMDLC ..... 4-9  
 CMDVF ..... 4-9  
 CMEK4 ..... 1-37  
 CP2308G10ST – CP2350G10ST ..... 12-7  
 CP2508G10ST – CP2550G10ST ..... 12-7  
 CP30210 – CP306LT( ) ..... 12-6  
 CP50210 – CP506LT( ) ..... 12-6  
 CU100FD ..... 9-29  
 CU1200P24K ..... 7-54  
 CU1200P25K ..... 7-54  
 CU1200P25K4 ..... 7-54  
 CU1200R53K ..... 7-54  
 CU12L400CB ..... 1-35  
 CU12L400CN ..... 1-35  
 CU12L400FB ..... 1-35  
 CU12L400FN ..... 1-35  
 CU150HD ..... 7-54  
 CU250JD ..... 7-54  
 CU250P1K ..... 7-54  
 CU400L61K3 ..... 7-54  
 CU400L61K4 ..... 7-54  
 CU600LF52K3 ..... 7-54  
 CU600LS52K3 ..... 7-54  
 CU600LS52K4 ..... 7-54  
 CU800M23K ..... 7-54  
 CU800M23K4 ..... 7-54  
 CU816D400CB ..... 1-35  
 CU816D400CN ..... 1-35  
 CUM400CB ..... 1-35  
 CVMT ..... 4-9  
 CYA060HD ..... 7-55  
 CYA1200R5 ..... 7-55  
 CYA1200R7 ..... 7-55  
 CYA150HD ..... 7-55  
 CYA150JD ..... 7-55  
 CYA250J3 ..... 7-55  
 CYA400L31K3 ..... 7-55  
 CYA400L31K4 ..... 7-55  
 CYA400L51K3 ..... 7-55  
 CYA400L51K4 ..... 7-55  
 CYA400P5 ..... 7-55  
 CYA600L32K3 ..... 7-55  
 CYA600L32K4 ..... 7-55  
 CYA600L52K3 ..... 7-55  
 CYA600L52K4 ..... 7-55  
 CYA600P5 ..... 7-55  
 CYA800P7 ..... 7-55

**D**

D211N – D326N ..... 3-4, 3-7  
 D211NRB – D324NRB ..... 3-4, 3-7  
 D225NR – D326NR ..... 3-4, 3-7  
 D325NT – D326NT ..... 3-4, 3-7  
 D325NTR – D326NTR ..... 3-4, 3-7  
 DA1TT090 – DA1TT170 ..... 16-106  
 DASKGS100 ..... 14-9  
 DASKGS1000 – DASKGS2000 ..... 14-9  
 DASKGS250 – DASKGS600 ..... 14-9  
 DASKP100 ..... 14-9  
 DASKP1000 ..... 14-9  
 DASKP1200 ..... 14-9  
 DASKP250 – DASKP600 ..... 14-9  
 DE9RA1012 ..... 21-28  
 DFCC1 – DFCC3V ..... 24-29  
 DL1BDB1 – DL1BDG8 ..... 19-117  
 DL1BEB – DL1BEJ ..... 19-117  
 DL1BEM – DL1BKG8 ..... 19-117  
 DL1BLB – DL1BLM ..... 19-117  
 DL1CB006 ..... 19-41, 19-61, 19-71, 19-134  
 DL1CE012 ..... 19-41, 19-61, 19-134  
 DL1CE024 ..... 19-41, 19-61, 19-71, 19-134  
 DL1CE048 ..... 19-134  
 DL1CE130 ..... 19-41, 19-61, 19-71, 19-134  
 DL1CF110 ..... 19-41, 19-61, 19-71, 19-134  
 DL1CF220 ..... 19-41, 19-61, 19-71  
 DL1CJUS0063 – DL1CJUS1205 ..... 19-134  
 DPDT ..... 23-38  
 DR2SC0030 – DR2SC4700 ..... 18-56

DR5TE4S ..... 18-54  
 DR5TE4U ..... 18-54  
 DR5TF4V ..... 18-54  
 DRK30 ..... 3-4  
 DRK40 ..... 3-4  
 DRK600 ..... 3-4  
 DS200EK2D ..... 3-28  
 DS468GKD ..... 3-28  
 DT100SG ..... 3-28  
 DT223 ..... 3-26, 3-32  
 DT223RB ..... 3-26, 3-32  
 DT30SG ..... 3-28  
 DT30SN ..... 3-28  
 DT321 ..... 3-26, 3-32  
 DT321RB ..... 3-26, 3-32  
 DT322 ..... 3-26, 3-32  
 DT322RB ..... 3-26, 3-32  
 DT323 ..... 3-26, 3-32  
 DT323RB ..... 3-26, 3-32  
 DT361 ..... 3-27, 3-32  
 DT361RB ..... 3-27, 3-32  
 DT362 ..... 3-27, 3-32  
 DT362RB ..... 3-27, 3-32  
 DT363 ..... 3-27, 3-32  
 DT363RB ..... 3-27, 3-32  
 DT600NKD ..... 3-28  
 DTU222 ..... 3-26, 3-32  
 DTU223 ..... 3-26, 3-32  
 DTU223RB ..... 3-26, 3-32  
 DTU224NRB ..... 3-26, 3-33  
 DTU321 ..... 3-26, 3-32  
 DTU322 ..... 3-26, 3-32  
 DTU323 ..... 3-26, 3-32  
 DTU323RB ..... 3-26, 3-32  
 DTU324N ..... 3-26, 3-33  
 DTU324NRB ..... 3-26, 3-33  
 DTU326 ..... 3-26, 3-33  
 DTU326R ..... 3-26, 3-33  
 DTU361 ..... 3-27, 3-32  
 DTU361RB ..... 3-27, 3-32  
 DTU362 ..... 3-27, 3-32  
 DTU362AWK ..... 3-27, 3-32  
 DTU362DS ..... 3-27, 3-32  
 DTU362RB ..... 3-27, 3-32  
 DTU363 ..... 3-27, 3-32  
 DTU363AWK ..... 3-27, 3-32  
 DTU363DS ..... 3-27, 3-32  
 DTU363RB ..... 3-27, 3-32  
 DTU366 ..... 3-27, 3-33  
 DTU366AWK ..... 3-27, 3-33  
 DTU366R ..... 3-27, 3-33  
 DTU426 ..... 3-26, 3-33  
 DTU426R ..... 3-26, 3-33  
 DTU462 ..... 3-27, 3-32  
 DTU462AWK ..... 3-27, 3-32  
 DTU462DS ..... 3-27, 3-32  
 DTU463 ..... 3-27, 3-32  
 DTU463AWK ..... 3-27, 3-33  
 DTU463DS ..... 3-27, 3-32  
 DTU466 ..... 3-27, 3-33  
 DTU466R ..... 3-27, 3-33  
 DTU662AWK ..... 3-27, 32  
 DTU663AWK ..... 3-27, 32  
 DU221RB ..... 3-5, 3-7  
 DU222RB ..... 3-5, 3-7  
 DU321 ..... 3-5, 3-7  
 DU321RB ..... 3-5, 3-7  
 DU322 ..... 3-5, 3-7  
 DU322RB ..... 3-5, 3-7  
 DU323 ..... 3-5, 3-7  
 DU323RB ..... 3-5, 3-7  
 DU324 ..... 3-5, 3-7  
 DU324RB ..... 3-5, 3-7  
 DU325 ..... 3-5, 3-7  
 DU326 ..... 3-5, 3-7  
 DX1AP25 ..... 18-21  
 DZ2FF1 ..... 18-12, 18-20  
 DZ2FG1 ..... 18-20  
 DZ2FH1 ..... 18-20  
 DZ2FJ1 ..... 18-20  
 DZ2FK1 ..... 18-20

DZ2FL( )	18-20
DZ2FX1	18-20
DZ5CA002 – DZ5CA503	24-30
DZ5CE002 – DZ5CE010L12	24-30

**E**

E8951	4-26
EBX210	4-27
EBXAANT5M	4-27
EBXAGPRS	4-27
EBXAGPRSSIM	4-27
EBXAUSBWIFI	4-27
ECB14015G3 – ECB34020G3	9-39
ECB142020G3EL	9-39
ECB2HT	9-29
ECB3HT	9-29
ECT075050SC – ECT300800SC	4-22
EDB14015 – EDB34125	9-28
EDB14015EPD – EDB14050EPD	9-28
EDPA	9-29, 9-34
EDPAF	9-29, 9-34
EE100S3534H	14-7
EE100S3H	14-7
EE100S3HB	14-7
EE100S3HF	14-7
EE100S60H	14-7
EE100S61H	14-7
EE15S3534H	14-7
EE15S3H	14-7
EE15S3HB	14-7
EE15S3HF	14-7
EE15S60H	14-7
EE15S61H	14-7
EE167S3534H	14-7
EE167S3H	14-7
EE167S60H	14-7
EE167S61H	14-7
EE250S3534H	14-7
EE250S3H	14-7
EE25S3534H	14-7
EE25S3H	14-7
EE25S3HB	14-7
EE25S3HF	14-7
EE25S60H	14-7
EE25S61H	14-7
EE333S3534H	14-7
EE333S3H	14-7
EE37S3534H	14-7
EE37S3H	14-7
EE37S3HB	14-7
EE37S3HF	14-7
EE37S60H	14-7
EE37S61H	14-7
EE50S3534H	14-7
EE50S3H	14-7
EE50S3HB	14-7
EE50S3HF	14-7
EE50S60H	14-7
EE50S61H	14-7
EE75S3534H	14-7
EE75S3H	14-7
EE75S3HB	14-7
EE75S3HF	14-7
EE75S60H	14-7
EE75S61H	14-7
EGB14015EPD – EGB14050EPD	9-28
EGB14020 – EGB34125	9-28
EGX150	4-28
EIK031	3-16
EIK032	3-16
EIK1	3-16
EIK2	3-16
EIK40601	3-16
EIK40602	3-16
EJB14015 – EJB34125	9-28
EJB14015EPD – EJB14050EPD	9-28
ELM150HD	7-79
ELM250JD	7-79
EM4236	4-20
EMB1010	4-20

EMB1021	4-20
EMB1032	4-20
EMB2010	4-20
EMB2021	4-20
EMB2032	4-20
EMB2043	4-20
EMB2083	4-20
EMB3010	4-20
EMB3021	4-20
EMB3032	4-20
EMB3043	4-20
EMB3083	4-20
EMB3084	4-20
EMB3164	4-20
EMBOND	4-20
EMCB	4-20
EMCT010	4-20
EMCT021	4-20
EMCT032	4-20
EMCT043	4-20
EMCT083	4-20
EMCT084	4-20
EMCT164	4-20
EME1010	4-20
EME1021	4-20
EME1032	4-20
EME2010	4-20
EME2021	4-20
EME2032	4-20
EME2043	4-20
EME2083	4-20
EME3010	4-20
EME3021	4-20
EME3032	4-20
EME3043	4-20
EME3083	4-20
EME3084	4-20
EME3164	4-20
EMFP1	4-20
EMFP2	4-20
EMFP3	4-20
EMS58585	5-34
EMS58586	5-34
EMS58587	5-34
EMS58588	5-34
EMS59000	5-33
EMS59201	5-33
EMS59202	5-33
EMS59300	5-33
EMT1225CB	2-3
EMT3225CB	2-3
EVCP060D5IP00	4-42, 4-46
EVCP060D5IP31	4-42, 4-46
EVCP060D5IP54	4-42, 4-46
EVCP060D5N12	4-42, 4-46
EVCP060D5N2	4-42, 4-46
EVCP120D5IP00	4-42, 4-46
EVCP120D5IP31	4-42, 4-46
EVCP120D5IP54	4-42, 4-46
EVCP120D5N12	4-42, 4-46
EVCP120D5N2	4-42, 4-46
EVCP200D5IP00	4-42, 4-46
EVCP200D5IP31	4-42, 4-46
EVCP200D5IP54	4-42, 4-46
EVCP200D5N1	4-46
EVCP200D5N12	4-42, 4-46
EVCP200D5N2	4-42, 4-46
EVCP300D5IP00	4-42, 4-46
EVCP300D5IP31	4-42, 4-46
EVCP300D5IP54	4-42, 4-46
EVCP300D5N1	4-46
EVCP300D5N12	4-42, 4-46
EVCP300D5N2	4-42, 4-46
EX112T1814H	14-4
EX112T211H	14-4
EX112T212H	14-4
EX112T239H	14-4
EX112T3H	14-4
EX112T3HB	14-5
EX112T3HBCU	14-5
EX112T3HCU	14-4

EX112T3HCUNLP	14-6
EX112T3HF	14-5
EX112T3HFCU	14-5
EX112T3HFCUNLP	14-6
EX112T3HFNLP	14-6
EX112T3HNLP	14-6
EX112T65H	14-4
EX112T6HCT	14-5
EX150T1814H	14-4
EX150T211H	14-4
EX150T212H	14-4
EX150T239H	14-4
EX150T3H	14-4
EX150T3HB	14-5
EX150T3HBCU	14-5
EX150T3HCU	14-4
EX150T3HCUNLP	14-6
EX150T3HF	14-5
EX150T3HFCU	14-5
EX150T3HFCUNLP	14-6
EX150T3HFNLP	14-6
EX150T3HNLP	14-6
EX150T65H	14-4
EX150T6HCT	14-5
EX15T1814H	14-4
EX15T211H	14-4
EX15T212H	14-4
EX15T239H	14-4
EX15T3H	14-4
EX15T3HB	14-5
EX15T3HBCU	14-5
EX15T3HCU	14-4
EX15T3HCUNLP	14-6
EX15T3HF	14-5
EX15T3HFCU	14-5
EX15T3HFCUNLP	14-6
EX15T3HFNLP	14-6
EX15T3HNLP	14-6
EX15T65H	14-4
EX15T6HCT	14-5
EX225T1814H	14-4
EX225T211H	14-4
EX225T212H	14-4
EX225T239H	14-4
EX225T3H	14-4
EX225T3HB	14-5
EX225T3HBCU	14-5
EX225T3HCU	14-4
EX225T3HCUNLP	14-6
EX225T3HF	14-5
EX225T3HFCU	14-5
EX225T3HFCUNLP	14-6
EX225T3HFNLP	14-6
EX225T3HNLP	14-6
EX225T65H	14-4
EX225T6HCT	14-5
EX300T1814H	14-4
EX300T211H	14-4
EX300T212H	14-4
EX300T239H	14-4
EX300T3H	14-4
EX300T3HCU	14-4
EX300T3HF	14-5
EX300T3HFCU	14-5
EX300T65H	14-4
EX300T68HB	14-5
EX300T68HBCU	14-5
EX300T6HCT	14-5
EX30T1814H	14-4
EX30T211H	14-4
EX30T212H	14-4
EX30T239H	14-4
EX30T3H	14-4
EX30T3HB	14-5
EX30T3HBCU	14-5
EX30T3HCU	14-4
EX30T3HCUNLP	14-6
EX30T3HF	14-5
EX30T3HFCU	14-5
EX30T3HFCUNLP	14-6
EX30T3HFNLP	14-6

EX30T3HNLP .....	14-6	EZM1600TB .....	2-12	EZMH115125CUX – EZMH115225CU .....	2-14
EX30T65H .....	14-4	EZM1800CB – EZM1800FS .....	2-12	EZMH116125 – EZMH116225 .....	2-14
EX30T6HCT .....	14-5	EZM1800CUB – EZM1800TBU .....	2-13	EZMH116125CUX .....	2-14
EX45T1814H .....	14-4	EZM1800FSU .....	2-12	EZMH312225 – EZMH316225 .....	2-17
EX45T211H .....	14-4	EZM1800TB .....	2-12	EZMH312225CUX – EZMH316125CUX .....	2-17
EX45T212H .....	14-4	EZM1800TBCU .....	2-12	EZMH315225CU – EZMH316225CU .....	2-17
EX45T239H .....	14-4	EZM1CORNER .....	2-21	EZMH316225CA .....	2-17
EX45T3H .....	14-4	EZM1ELBOW .....	2-21	EZMK1114400 – EZMK112400 .....	2-14
EX45T3HB .....	14-5	EZM1EXT .....	2-21	EZMK311400 – EZMK332400 .....	2-18
EX45T3HBCU .....	14-5	EZM1EXT6 .....	2-21	EZML111225 – EZML116125 .....	2-14
EX45T3HCU .....	14-4	EZM1TRANL .....	2-21	EZML111225CU – EZML114225CU .....	2-14
EX45T3HCUNLP .....	14-6	EZM1TRANR .....	2-21	EZML111225D – EZML114225D .....	2-14
EX45T3HF .....	14-5	EZM31000CB .....	2-15	EZML113125CUX – EZML116125CUX .....	2-14
EX45T3HFCU .....	14-5	EZM31000CBNBBTL – EZM31000CBNFBTR .....	2-19	EZML311400 – EZML332400 .....	2-18
EX45T3HFCUNLP .....	14-6	EZM31000CUB – EZM3800CUB .....	2-16	EZML312225 – EZML334225 .....	2-17
EX45T3HFNLP .....	14-6	EZM31000GCBA40 – EZM31000JCBC40 .....	2-20	EZML312225CU – EZML334225CU .....	2-17
EX45T3HNLP .....	14-6	EZM31200FSB – EZM31200FST .....	2-15	EZML312225D – EZML334225D .....	2-17
EX45T65H .....	14-4	EZM31200FSE .....	2-16	EZML313125CUX – EZML316125CUX .....	2-17
EX45T6HCT .....	14-5	EZM31200FSNBBTL – EZM31200FSNFBTR .....	2-19	EZMR112225 – EZMR116225 .....	2-14
EX500T211H .....	14-4	EZM31200GBNBBTL – EZM31200GBNFBTR .....	2-19	EZMR112225CUX – EZMR116125CUX .....	2-14
EX500T212H .....	14-4	EZM31200GCBA30 – EZM31200JCBA40 .....	2-20	EZMR115225CU .....	2-14
EX500T239H .....	14-4	EZM31200GCBE .....	2-16	EZMR312225 – EZMR334225 .....	2-17
EX500T63HCT .....	14-5	EZM31200GCBEMS – EZM31200JCBEMS .....	2-16	EZMR312225CUX – EZMR316125CUX .....	2-17
EX500T68H .....	14-4	EZM31200GCBT – EZM31200GCBU .....	2-15	EZMR315225CU – EZMR334225CU .....	2-17
EX500T68HB .....	14-5	EZM31200GCBTMS – EZM31200JCBTMS .....	2-15	EZMR316225CA .....	2-17
EX500T68HBCU .....	14-5	EZM31200GCBUMS – EZM31200JCBUMS .....	2-15	EZMSCAP .....	2-21
EX500T68HCU .....	14-4	EZM31200JBNBBTL – EZM31200JBNFBTR .....	2-19	EZMSK2 .....	2-21
EX500T68HF .....	14-5	EZM31200JCBE .....	2-16	EZMT111225 – EZMT113225 .....	2-14
EX500T68HFCU .....	14-5	EZM31200JCBT – EZM31200JCUB .....	2-15	EZMT112225 .....	2-14
EX500T76H .....	14-4	EZM31200TBU .....	2-16	EZMT311225 – EZMT333225 .....	2-17
EX500T79H .....	14-4	EZM312225 – EZM316225 .....	2-17		
EX750T63HCT .....	14-5	EZM312225CUX – EZM316125CUX .....	2-17		
EX750T68H .....	14-4	EZM313125M10 – EZM316125M10 .....	2-17	<b>F</b>	
EX750T68HCU .....	14-4	EZM315225CU – EZM316225CU .....	2-17	F36060(C)U44A .....	7-40
EX750T68HF .....	14-5	EZM31600GCB – EZM31600JCBC .....	2-15	FA100FSS .....	2-24
EX750T68HFCU .....	14-5	EZM31600GCBEMS – EZM31600JCBCMS .....	2-15	FK400 .....	1-37
EX750T79H .....	14-4	EZM31600GCBU – EZM31600JCUB .....	2-15	FPK03 .....	3-6, 3-17
EX75T1814H .....	14-4	EZM31600GCBUMS – EZM31600JCBUMS .....	2-15	FPK0610 .....	3-6, 3-17
EX75T211H .....	14-4	EZM31600TB .....	2-15		
EX75T212H .....	14-4	EZM316225CA .....	2-17	<b>G</b>	
EX75T239H .....	14-4	EZM32000CB – EZM32000TB .....	2-15	G1414 – G19103 .....	13-8
EX75T3H .....	14-4	EZM32000CBMS .....	2-15	GB2CB05 – GB2CB20 .....	24-25
EX75T3HB .....	14-5	EZM32000CUB .....	2-15	GB2CD05 – GB2CD20 .....	24-25
EX75T3HBCU .....	14-5	EZM32000CUBUMS .....	2-15	GFI2PA .....	1-8
EX75T3HCU .....	14-4	EZM33225TB – EZM3800TB .....	2-15	GFI2PA .....	7-15
EX75T3HCUNLP .....	14-6	EZM3400CB – EZM3800CB .....	2-15	GFM150HD .....	7-79
EX75T3HF .....	14-5	EZM3400CBNBBTL – EZM3400CBNFBTR .....	2-19	GFM250JD .....	7-79
EX75T3HFCU .....	14-5	EZM3400CUB – EZM3600CUB .....	2-16	GFM25CT .....	7-79
EX75T3HFCUNLP .....	14-6	EZM3400FS – EZM3800FS .....	2-15	GK2AF01 .....	18-33
EX75T3HFNLP .....	14-6	EZM3400FSNBBTL – EZM3400FSNFBTR .....	2-19	GS1AD010 .....	8-26
EX75T3HNLP .....	14-6	EZM3400FSU – EZM3800FSU .....	2-16	GS1AD10 .....	8-26
EX75T65H .....	14-4	EZM3400TBU – EZM3800TBU .....	2-16	GS1AM101 .....	8-26
EX75T6HCT .....	14-5	EZM3600CBNBBTL – EZM3600CBNFBTR .....	2-19	GS1AM110 .....	8-26
EXB510 .....	4-27	EZM3600FSNBBTL – EZM3600FSNFBTR .....	2-19	GS1AU203 .....	8-26
EXBAUSBZIGBEE .....	4-27	EZM3600FSU .....	2-16	GS1AU303 .....	8-26
EZM11000CB .....	2-12	EZM3600GCBA40 .....	2-20	GS1AU403 .....	8-26
EZM11000CUB .....	2-13	EZM3600GCBC40 – EZM3600JCBA40 .....	2-20	GS1AU503 .....	8-26
EZM11200FSB – EZM11200FST .....	2-12	EZM3800CBNBBTL – EZM3800CBNFBTR .....	2-19	GS1AU803 .....	8-26
EZM11200FSE – EZM11200TBU .....	2-13	EZM3800FSNBBTL – EZM3800FSNFBTR .....	2-19	GS1AW306 .....	8-27
EZM11200GCBE – EZM11200JCBE .....	2-13	EZM3800GCBA20 – EZM3800GCBC30 .....	2-20	GS1AW403 .....	8-27
EZM11200GCBEMS – EZM11200JCBEMS .....	2-13	EZM3800JCBA30 .....	2-20	GS1AW406 .....	8-27
EZM11200GCBT – EZM11200JCUB .....	2-12	EZM3800JCBA40 .....	2-20	GS1AW503 .....	8-27
EZM11200GCBTMS – EZM11200JCBUMS .....	2-12	EZM3800TBCU .....	2-15	GS1AW506 .....	8-27
EZM112225 – EZM116225 .....	2-14	EZM3BTB – EZM6BTB .....	2-22	GS1AW603 .....	8-27
EZM112225CUX – EZM116125CUX .....	2-14	EZM3BUSLB – EZM3BUSRF .....	2-19	GS1AW606 .....	8-27
EZM11600GCBC – EZM11600JCUB .....	2-12	EZM3CORNER .....	2-21	GS1AW903 .....	8-27
EZM11600GCBCMS – EZM11600JCBUMS .....	2-12	EZM3ELBOW .....	2-21	GS1DDU3 .....	8-26 – 8-27
EZM11600TB .....	2-12	EZM3EXT .....	2-21	GS1DU3 .....	8-26 – 8-27
EZM12000CB – EZM12000TB .....	2-12	EZM3EXT6 .....	2-21	GS1JU3 .....	8-27
EZM12000CBMS .....	2-12	EZM3TRANL .....	2-21	GS2AD030N .....	8-26
EZM12000CUB .....	2-12	EZM3TRANR .....	2-21	GS2AD040N .....	8-26
EZM12000CUBUMS .....	2-12	EZM600FTLK3 .....	2-21	GS2AE2 .....	8-25 – 8-26
EZM1200ULL .....	2-22	EZM72MC .....	26-27	GS2AE21 .....	8-25 – 8-26
EZM1225TB – EZM1400TB .....	2-12	EZM72MC .....	2-21	GS2AE23 .....	8-25
EZM125QOA .....	2-7, 2-21	EZMCAAP .....	2-21	GS2AE5 .....	8-26
EZM1400CB – EZM1400FS .....	2-12	EZMCTMKIT .....	2-22	GS2AE51 .....	8-26
EZM1400CUB – EZM1400TBU .....	2-13	EZMH112225 – EZMH113225 .....	2-14	GS2AE6 .....	8-25
EZM1600CB – EZM1600FS .....	2-12	EZMH112225CUX – EZMH113225CUX .....	2-14	GS2AE61 .....	8-25
EZM1600CUB – EZM1600FSE .....	2-13	EZMH114125 – EZMH114225 .....	2-14	GS2AE8 .....	8-26
EZM1600FSU .....	2-12	EZMH114125CUX – EZMH114225CUX .....	2-14	GS2AE81 .....	8-26
EZM1600FTLK3 .....	2-21	EZMH115125 – EZMH115225 .....	2-14		

GS2AEH12	8-24	8-26
GS2AESB		8-25
GS2AH110		8-26
GS2AH120		8-26
GS2AH120F		8-27
GS2AH130	8-25	8-26
GS2AH140	8-25	8-26
GS2AH144F		8-27
GS2AH150	8-25	8-26
GS2AH160	8-25	8-26
GS2AH170		8-25
GS2AH180		8-25
GS2AH180F		8-27
GS2AH36F		8-27
GS2AH410		8-26
GS2AH4120F		8-27
GS2AH4144F		8-27
GS2AH4180F		8-27
GS2AH420		8-26
GS2AH430	8-25	8-26
GS2AH440	8-25	8-26
GS2AH460F		8-27
GS2AH60F		8-27
GS2AM101		8-25
GS2AM110		8-25
GS2AP43		8-26
GS2AP53		8-26
GS2AP73		8-26
GS2EEU3	8-26	8-27
GS2EU3N	8-26	8-27
GS2GU3N	8-26	8-27
GS2JU3N	8-26	8-27
GS2MU3N	8-26	8-27
GS2QU3N	8-26	8-27
GS2SU3	8-26	8-27
GS2TU3	8-26	8-27
GTK03	3-6,	3-18
GTK03C		3-18
GTK0610	3-6,	3-18
GTK0610C		3-18
GV1F03		18-33
GV1G02		18-33
GV1G09		18-33
GV1G10		18-33
GV1L3		18-33
GV2AF01		18-33
GV2AF02		18-33
GV2AF3		18-33
GV2AF4		18-33
GV2AF5		26-16
GV2AK00		18-33
GV2APN01		18-33
GV2APN02		18-33
GV2APN04		18-33
GV2E01		18-34
GV2G05		18-33
GV2G245	18-25,	18-33
GV2G254	18-25,	18-33
GV2G272	18-25,	18-33
GV2G345	18-25,	18-33
GV2G354	18-25,	18-33
GV2G445	18-25,	18-33
GV2G454	18-25,	18-33
GV2G472	18-25,	18-33
GV2G554	18-25,	18-33
GV2GH7		18-33
GV2K011		18-33
GV2K021		18-33
GV2K031		18-33
GV2K04		18-34
GV2MC01		18-33
GV2MC02		18-33
GV2ME01 – GV2ME32		18-32
GV2MP01		18-33
GV2MP02		18-33
GV2MP03		18-33
GV2MP04		18-33
GV2P01 – GV3P65		18-32
GV2P02KD09B7 – GV2P22KD25G7		18-35
GV2SN13		18-34
GV2SN14		18-34

GV2SN15		18-34
GV2SN17		18-34
GV2SN23		18-34
GV2SN24		18-34
GV2SN25		18-34
GV2SN27		18-34
GV2SN33		18-34
GV2SN34		18-34
GV2SN35		18-34
GV2SN37		18-34
GV2V01		18-33
GV2V03		18-36
GV3APN01		18-36
GV3APN02		18-36
GV3APN04		18-36
GV3G264		18-36
GV3G364		18-36
GV3G66		18-36
GV3S		18-36
GV7AB11		18-36
GV7AC01 – GV7V01		18-37
GV7AC03	18-15,	18-37
GV7AD111		18-36
GV7AD112		18-36
GV7AE11		18-36
GV7AS055		18-36
GV7AS107		18-36
GV7AS207		18-36
GV7AS387		18-36
GV7AS525		18-36
GV7AU055		18-36
GV7AU107		18-36
GV7AU207		18-36
GV7AU387		18-36
GV7AU525		18-36
GV7RE20 – GV7RE220		18-32
GV7RS20 – GV7RS220		18-32
GVA( )025 – GVA( )505		18-35
GVAD0101		18-36
GVAD0110		18-36
GVAD1001		18-36
GVAD1010		18-36
GVAE1		18-36
GVAE11		18-36
GVAE20		18-36
GVAM11		18-36
GVAN11		18-36
GVAN20		18-36
GVAPA2	18-33,	18-36
GVAPB54		18-37
GVAPB65		18-37
GVAPH02		18-33
GVAPH03		18-36
GVAPK11		18-33
GVAPK12		18-36
GVAPL01	18-33,	18-36, 18-39
GVAPR54		18-37
GVAPR65		18-37

**H**

H( )A26015( ) – H( )A26150( )		9-53
H( )A36015 – H( )A36150		9-53
H( )A36060U31X – H( )A36150U54X		9-54
H( )L36030M38X – H( )L36100M38X		7-48
H100XFA	3-13,	3-23
H100XFA1212		3-13
H12LKE2		3-21
H150F	7-82,	7-86
H150R	7-82,	7-86
H150S	7-82,	7-86
H2212AWK	3-8,	3-23
H221A	3-8,	3-23
H221AWK		3-8
H221DS	3-8,	3-23
H221N	3-8,	3-22
H221NRB	3-8,	3-22
H222AWK		3-8
H222DS	3-8,	3-23
H222N	3-8,	3-22
H222NRB	3-8,	3-22

H223A		3-8
H223AWK		3-8
H223DS	3-8,	3-23
H223N	3-8,	3-22
H223NRB	3-8,	3-22
H224A	3-8,	3-23
H224AWK	3-8,	3-23
H224DS	3-8,	3-23
H224N	3-8,	3-22
H224NRB	3-8,	3-22
H225		3-8
H225AWK		3-8
H225DS		3-8
H225N		3-8
H225NAWK		3-8
H225NDS		3-8
H225NR		3-8
H225R		3-8
H225XJG	3-13,	3-23
H225XJGAA		3-13
H226		3-8
H226AWK		3-8
H226DS		3-8
H226N		3-8
H226NAWK		3-8
H226NDS		3-8
H226NR		3-8
H226R		3-8
H227		3-8
H227AWK		3-8
H227N		3-8
H227NAWK		3-8
H227NR		3-8
H227R		3-8
H228		3-8
H228AWK		3-8
H228N		3-8
H228NAWK		3-8
H228NR		3-8
H228R		3-8
H265	3-9,	3-22
H265AWK		3-9
H265DS		3-9
H265R	3-9,	3-22
H266	3-9,	3-22
H266AWK		3-9
H266DS		3-9
H266R	3-9,	3-22
H267	3-9,	3-22
H267AWK		3-9
H267R	3-9,	3-22
H268	3-9,	3-22
H268AWK		3-9
H268R	3-9,	3-22
H2PHLA		7-52
H321A		3-8
H321AWK		3-8
H321DS	3-8,	3-23
H321N	3-8,	3-22
H321NRB	3-8,	3-22
H322A		3-8
H322AWK		3-8
H322DS	3-8,	3-23
H322N	3-8,	3-22
H322NRB	3-8,	3-22
H323A		3-8
H323AWK		3-8
H323DS	3-8,	3-23
H323N	3-8,	3-22
H323NRB	3-8,	3-22
H324A	3-8,	3-23
H324AWK	3-8,	3-23
H324DS	3-8,	3-23
H324N	3-8,	3-22
H324NRB	3-8,	3-22
H325		3-8
H325AWK		3-8
H325DS		3-8
H325N		3-8
H325NAWK		3-8
H325NDS		3-8

H325NR	3-8	H364N	3-9	HC4212DEX (F or S)	9-48
H325R	3-8	H364NA	3-9	HC4250DB – HC4486DB	9-46
H326	3-8	H364NAWK	3-9	HC4250WP	9-48
H326AWK	3-8	H364NDS	3-9	HC4259DB	9-46
H326DS	3-8	H364NRB	3-9	HC4259WP	9-48
H326N	3-8	H364RB	3-9	HC4268DB	9-46
H326NAWK	3-8	H364SS	3-12, 3-23	HC4268WP	9-48
H326NDS	3-8	H365	3-9	HC4286DB	9-46
H326NR	3-8	H365AWK	3-9	HC4286WP	9-48
H326R	3-8	H365DS	3-9	HC4406DEX (F or S)	9-48
H327	3-8	H365N	3-9	HC4412DEX (F or S)	9-48
H327AWK	3-8	H365NAWK	3-9	HC4486WP	9-48
H327N	3-8	H365NDS	3-9	HC4SN , HCW4SN	9-47
H327NAWK	3-8	H365NR	3-9	HC6SN , HCW6SN	9-47
H327NR	3-8	H365R	3-9	HC8SN , HCW8SN	9-47
H327R	3-8	H365SS	3-12	HCM14482N – HCM50918	9-44
H328	3-8	H366	3-9	HCM14644M	9-45
H328AWK	3-8	H366AWK	3-9	HCM18642MN	9-45
H328N	3-8	H366DS	3-9	HCM18736MP	9-45
H328NAWK	3-8	H366N	3-9	HCM18738MP	9-45
H328NR	3-8	H366NAWK	3-9	HCM23734M	9-45
H328R	3-8	H366NDS	3-9	HCM27732MN	9-45
H361	3-9	H366NR	3-9	HCM36916MP	9-45
H3612	3-9	H366R	3-9	HCM36918MP	9-45
H3612A	3-9	H366SS	3-12	HCM400VCA	9-48
H3612AWK	3-9	H367	3-9	HCM41914M	9-45
H3612RB	3-9	H367AWK	3-9	HCM600VCA	9-48
H361A	3-9	H367N	3-9	HCM64T( )	9-44 – 9-45
H361AWA	3-14, 3-23	H367NAWK	3-9	HCM64T( )D	9-44 – 9-45
H361AWC	3-14, 3-23	H367NR	3-9	HCM73T( )	9-44 – 9-45
H361AWK	3-9	H367R	3-9	HCM73T( )D	9-44 – 9-45
H361DF	3-12, 3-23	H368	3-9	HCM800VCA	9-48
H361DS	3-9, 3-23	H368AWK	3-9	HCM91T( )	9-44 – 9-45
H361DSWA	3-14, 3-23	H368N	3-9	HCM91T( )D	9-44 – 9-45
H361DSWC	3-14, 3-23	H368NAWK	3-9	HCP145012N – HCP50868	9-46
H361DX	3-13, 3-23	H368NR	3-9	HCP54868SU	9-45
H361N	3-9	H368R	3-9	HCPSU8SN	9-47
H361NRB	3-9	H461	3-9, 3-22	HCPSU8SNCW	9-47
H361RB	3-9	H461AWK	3-9	HCR12SNCTW	9-47
H361SS	3-12, 3-23	H461DS	3-9	HCR548612U	9-46
H361WA	3-14, 3-22	H462	3-9, 3-22	HCR86T( )	9-46
H361WC	3-14, 3-22	H462AWK	3-9, 3-23	HCR86T( )D	9-46
H362	3-9	H462DS	3-9, 3-23	HCW1200VCA	9-48
H362A	3-9	H463	3-9, 3-22	HCW1200VCA	9-47
H362AWA	3-14, 3-23	H463AWK	3-9, 3-23	HCW400VCA	9-48
H362AWC	3-14, 3-23	H463DS	3-9, 3-23	HCW50T( ) – HCW86T( )D	9-46
H362AWH	3-15, 3-23	H464	3-9, 3-22	HCW600VCA	9-48
H362AWK	3-9, 3-23	H464AWK	3-9, 3-23	HCW800VCA	9-48
H362DF	3-12, 3-23	H464DS	3-9, 3-23	HCWM12SN	9-47
H362DS	3-9, 3-23	H465	3-9, 3-22	HD100S	7-82, 7-86
H362DSWA	3-14, 3-23	H465AWK	3-9, 3-23	HDA261501 – HDA261506	9-55
H362DSWC	3-14, 3-23	H466	3-9, 3-22	HDL26015 – HDL26150	7-32
H362DX	3-13, 3-23	H60XFA	3-13, 3-23	HDL26015C – HDL26150C	7-32
H362N	3-9	H60XFA1212	3-13	HDL36015 – HDL36150	7-32
H362NRB	3-9	H663AWK	3-9, 3-23	HDL36015C – HDL36150C	7-32
H362RB	3-9	H663DS	3-9, 3-23	HDL36060CU31X – HDL36150U54X	7-33
H362SS	3-12, 3-23	H664AWK	3-9, 3-23	HDMCT050S1	4-34
H362WA	3-14, 3-22	H664DS	3-9, 3-23	HDMCT100S1	4-34
H362WC	3-14, 3-22	H82254	3-26, 3-33	HDMCT125S1	4-34
H362WH	3-15, 3-22	H82344	3-27, 3-33	HDMCT150S1	4-34
H363	3-9	H82354	3-26, 3-33	HDMCT200S1	4-34
H363A	3-9	H82444	3-27, 3-33	HDMCT250S1	4-34
H363AWA	3-14, 3-23	H82454	3-26, 3-33	HDMCT400S1	4-34
H363AWC	3-14, 3-23	H8LKE2	3-21	HEPD50	1-27, 6-12
H363AWK	3-9	HC2609DEX (F or S)	9-48	HEPD58MKF	6-12
H363DF	3-12, 3-23	HC2686DB	9-45	HEPD80	1-27, 6-11 – 6-12
H363DS	3-9, 3-23	HC2686T( )4P	9-45	HEPD80MKF	1-27
H363DSWA	3-14, 3-23	HC2686T( )JHR	9-45	HF13E – HF19SH	12-8
H363DSWC	3-14, 3-23	HC2886WP	9-45	HF24E – HF88SH	12-8
H363DX	3-13, 3-23	HC2SN	9-47	HF38F – HF63SH	12-7
H363N	3-9	HC3209EX (F or S)	9-48	HF67E	12-7 – 12-8
H363NRB	3-9	HC3248B	9-44	HFV	12-7 – 12-8
H363RB	3-9	HC3248WVP	9-44	HFVS1	12-7 – 12-8
H363SS	3-12, 3-23	HC3264B	9-44 – 9-45	HFVS2	12-7 – 12-8
H363WA	3-14, 3-22	HC3264WVP	9-44 – 9-45	HFVS8	12-8
H363WC	3-14, 3-22	HC3273B	9-44 – 9-45	HGL26000S15	7-44
H364	3-9	HC3273DB9	9-45	HGL26015 – HGL26150	7-32
H364A	3-9	HC3273WVP	9-44 – 9-45	HGL26015C – HGL26150C	7-32
H364AWK	3-9	HC3291B	9-44 – 9-45	HGL36000S15	7-44
H364DF	3-12, 3-23	HC3291DB9	9-45	HGL36015 – HGL36150	7-32
H364DS	3-9	HC3291WVP	9-44 – 9-45	HGL36015C – HGL36150C	7-32

HGL36030M38X	7-46, 7-48, 18-37	HOM120PDF	7-20	HOM240GFI	1-18, 7-21
HGL36050M38X – HGL36150M38X	7-46, 7-48, 18-37	HOM1224L125PC	1-21	HOM2448L125PGC	1-21
HGL36060CU31X – HGL36150U54X	7-33	HOM1224L125PGC	1-21	HOM2448L125PQGC	1-23
HGL37030D87 – HLL37070D87	7-43	HOM1224L125PGCVP	1-25	HOM2448L125PRB	1-24
HJL26015 – HJL26150	7-32	HOM1224L125PRB	1-24	HOM2448M100PC	1-21 – 1-22
HJL26015C – HJL26150C	7-32	HOM1224M100PC	1-21 – 1-22	HOM2448M100PCVP	1-25
HJL36015 – HJL36150	7-32	HOM1224M100PRB	1-24	HOM2448M125PC	1-21 – 1-22
HJL36015C – HJL36150C	7-32	HOM1224M125PRBVP	1-25	HOM2448M125PRB	1-24
HJL36030M38X – HJL36150M38X	7-46, 7-48, 18-37	HOM125	1-18, 1-36	HOM245	1-18, 1-36
HJL36060CU31X – HJL36150U54X	7-33	HOM125	7-20	HOM245	7-20
HL1MA12C( ) – HR1MA24C( )	6-5	HOM12L225PRB	1-24	HOM24L70RB	1-24
HLA26000S15	9-55	HOM12M200PRB	1-24	HOM250	1-18, 1-36
HLA36000S15	9-55	HOM130	1-18, 1-36	HOM250	7-20
HLL26000S15	7-44	HOM130	7-20	HOM250EPD	1-19
HLL26015 – HLL26150	7-32	HOM140	1-18, 1-36	HOM250EPD	7-21
HLL26015C – HLL26150C	7-32	HOM140	7-20	HOM250GFI	1-18, 7-21
HLL26025 – HLL26080	16-55	HOM1427X2242M200PC	1-13	HOM250PSPD	1-27, 6-12
HLL26030 – HLL26080	16-55	HOM1428X2244M200PC	1-21 – 1-22	HOM260	1-18, 1-36
HLL36000S15	7-44	HOM150	1-18, 1-36	HOM260	7-20
HLL36015	7-32, 16-55	HOM150	7-20	HOM270	1-18, 1-36
HLL36015C – HLL36150	7-32	HOM1632L125PC	1-21	HOM270	7-20
HLL36020 – HLL36025	16-55	HOM1632L225PGC	1-21	HOM280	1-18, 1-36
HLL36020 – HLL36150C	7-32	HOM1632L225PRB	1-24	HOM280	7-20
HLL36025 – HLL36030	16-55	HOM1HT	1-20	HOM290	1-18, 1-36
HLL36030M38X	18-37	HOM1HT	7-22	HOM290	7-20
HLL36030M38X – HLL36150M38X	7-46, 7-48	HOM1PA	1-20, 7-22	HOM2HBD	1-20
HLL36035 – HLL36060	16-55	HOM1RK	1-27	HOM2HBD	7-22
HLL36045 – HLL36070	16-55	HOM2040L125PC	1-21	HOM2PAHA	1-20
HLL36050M38X	18-37	HOM2040L125PGC	1-21	HOM2PAHA	7-22
HLL36060CU31X – HLL36150U54X	7-33	HOM2040L125PRB	1-24	HOM2PALA	1-20, 7-22
HLL36070 – HLL36090	16-55	HOM2040L225PGC	1-21	HOM2PAVHA	1-20, 7-22
HLL36080 – HLL36150	16-55	HOM2040L225PRB	1-24	HOM3060L125PC	1-21
HLL36100	7-32, 16-55	HOM2040M100PC	1-21 – 1-22	HOM3060L125PQGC	1-23
HLL36100M38X	18-37	HOM2040M100PC1AVP	1-25	HOM3060L225PC	1-21
HLL36100M38X	7-48	HOM2040M100PCVP	1-25	HOM3060L225PGC	1-21
HLL36150M38X	18-37	HOM2040M100PRB	1-24	HOM3060L225PGCVP	1-25
HLN1BL	9-47	HOM2040M200PC	1-21 – 1-22	HOM3060L225PQGC	1-23
HLN4BL	9-47	HOM2040M200PCVP	1-25	HOM3060L225PRB	1-24
HLN4EBL	9-47	HOM2040M200PRB	1-24	HOM3060M100PC	1-21 – 1-22
HLO1	1-8, 7-15, 7-19, 9-13, 9-21	HOM2100	1-18, 1-36	HOM3060M125PC	1-21 – 1-22
HLW1BL	9-47	HOM2100	7-20	HOM3060M150PC	1-21 – 1-22
HLW4BL	9-47	HOM2110	1-18, 1-36	HOM3060M150PCVP	1-25
HLW4EBL	9-47	HOM2110	7-20	HOM3060M150PRB	1-24
HMIDID64DTD1	27-13	HOM2125	1-18, 1-36	HOM3060M200PC	1-21 – 1-22
HMIDID73DTD1	27-13	HOM2125	7-20	HOM3060M200PC1AVP	1-25
HMIDT351 – HMIDT732	27-9	HOM215	1-18	HOM3060M200PCAFVP	1-25
HMIG3U	27-9	HOM215	7-20	HOM3060M200PCEP	1-23
HMIG5U	27-9	HOM21500BB	1-18, 1-36	HOM3060M200PCVP	1-25
HMIGTO1300 – HMIGTO6315	27-8	HOM21500BB	7-20	HOM3060M200PQC	1-23
HMISCU6A5 – HMISCU8B5	27-8	HOM215CAFI	1-18	HOM3060M200PRB	1-24
HMISTO501 – HMISTO532	27-7	HOM215CAFI	7-20	HOM3060M200PRBVP	1-25
HMISTU655 – HMISTU855	27-7	HOM215EPD	1-19	HOM4080L225PC	1-21
HMIZKB1	27-11	HOM215EPD	7-21	HOM4080L225PGC	1-21
HMIZRA1	27-10	HOM215GFI	1-18, 7-21	HOM4080L225PQGC	1-23
HNM1BL	9-47	HOM2175BB	1-18, 1-36	HOM4080L225PRB	1-24
HNM4BL	9-47	HOM2175BB	7-20	HOM4080M200PC	1-21 – 1-22
HOM115	1-18, 1-36, 7-20	HOM2175SB	1-27, 6-12	HOM4080M200PC1AVP	1-25
HOM115CAFI	1-18, 7-20	HOM220	1-18	HOM4080M200PCAFVP	1-25
HOM115DF	1-19	HOM220	7-20	HOM4080M200PCVP	1-25
HOM115DF	7-20	HOM2200BB	1-18, 1-36	HOM4080M200PQC	1-23
HOM115EPD	1-19	HOM2200BB	7-20	HOM4080M200PRB	1-24
HOM115EPD	7-21	HOM220CAFI	1-18	HOM4284L225PC	1-21
HOM115GFI	1-18	HOM220CAFI	7-20	HOM4284L225PGC	1-21
HOM115GFI	7-21	HOM220EPD	1-19	HOM4284L225PQGC	1-23
HOM115HM	1-18	HOM220EPD	7-21	HOM4284L225PRB	1-24
HOM115HM	7-20	HOM220GFI	1-18, 7-21	HOM4284M200PC	1-21 – 1-22
HOM115PCAFI	1-18, 7-20	HOM225	1-18	HOM4284M200PQC	1-23
HOM115PDF	1-19	HOM225	7-20	HOM4284M225PC	1-21 – 1-22
HOM120	1-18, 1-36	HOM225EPD	1-19	HOM48L125GC	1-21
HOM120	7-20	HOM225EPD	7-21	HOM48L125GRB	1-24
HOM120CAFI	1-18	HOM230	1-18, 1-36	HOM4RK2HA	1-27
HOM120CAFI	7-20	HOM230	7-20	HOM4RK2LA	1-27
HOM120DF	1-19	HOM230EPD	1-19	HOM5RK	1-27
HOM120DF	7-20	HOM230EPD	7-21	HOM60120L225PC	1-21
HOM120EPD	1-19	HOM230GFI	1-18, 7-21	HOM60120M200C	1-21 – 1-22
HOM120EPD	7-21	HOM235	1-18, 1-36	HOM612L100RB	1-24
HOM120GFI	1-18, 7-21	HOM235	7-20	HOM816L125PC	1-21
HOM120HM	1-18	HOM240	1-18, 1-36	HOM816L125PGC	1-21
HOM120HM	7-20	HOM240	7-20	HOM816L125PRB	1-24
HOM120PCAFI	1-18, 7-20	HOM240EPD	1-19	HOM816M100PC	1-21 – 1-22
HOM120PDF	1-19	HOM240EPD	7-21	HOM816M100PRB	1-24

HOM816M125PRB .....	1-24	HU3612RB .....	3-10	HU463DS .....	3-10, 3-24
HOM816M150PFTRB .....	1-24	HU361A .....	3-10	HU464 .....	3-10, 3-22
HOM816M200PFTRB .....	1-24	HU361AEI .....	3-10	HU464AWK .....	3-10, 3-24
HOMC30UFL .....	1-23	HU361AWA .....	3-14, 3-23	HU464DS .....	3-10, 3-24
HOMCGK2C .....	1-27	HU361AWC .....	3-14, 3-23	HU465 .....	3-10, 3-22
HOMCRBGK1C .....	1-27	HU361AWK .....	3-10	HU465AWK .....	3-10, 3-24
HOMEC250SPA .....	1-42	HU361AWKEI .....	3-10	HU466 .....	3-10, 3-22
HOMELEC1PA .....	1-20	HU361DF .....	3-12, 3-24	HU661AWK .....	3-10, 3-24
HOMELEC1PA .....	7-22	HU361DS .....	3-10, 3-23	HU661DS .....	3-10, 3-24
HOMELEC2PALA .....	1-20	HU361DSEI .....	3-10	HU662AWK .....	3-10, 3-24
HOMELEC2PALA .....	7-22	HU361DSWA .....	3-14, 3-23	HU662DS .....	3-10, 3-24
HOMFP .....	1-27, 1-37	HU361DSWC .....	3-14, 3-23	HU663AWK .....	3-10, 3-24
HOML2125 .....	1-20, 7-22	HU361DX .....	3-13, 3-24	HU663DS .....	3-10, 3-24
HOML2225 .....	1-20, 7-22	HU361EI .....	3-10	HU664AWK .....	3-10, 3-24
HOMQPA .....	1-20, 7-22	HU361RB .....	3-10, 3-22	HU664DS .....	3-10, 3-24
HOMRBGK2C .....	1-27	HU361RBEI .....	3-10	HVDSA3 – HVDSA10 .....	11-26
HOMT1515 .....	1-19, 7-21	HU361SS .....	3-12, 3-24	HVL305BG – HVL317BW .....	11-24
HOMT1515215 .....	1-19	HU361WA .....	3-14, 3-22	HVL405BGL – HVL515DEWR2H .....	11-25
HOMT1515215 .....	7-21	HU361WC .....	3-14, 3-22	HVL505BGL – HVL515BWRH .....	11-26
HOMT1515220 .....	1-19	HU362 .....	3-10, 3-22	HVLC .....	11-26
HOMT1515220 .....	7-21	HU362A .....	3-10	HVLC2 .....	11-26
HOMT1515225 .....	1-19	HU362AWA .....	3-14, 3-24	HVLRCA14305D .....	11-19, 11-22
HOMT1515225 .....	7-21	HU362AWC .....	3-14, 3-24	HVLRCA14305N – HVLRCCB20315N .....	11-18
HOMT1515230 .....	1-19	HU362AWH .....	3-15, 3-24	HVLRCA14315D .....	11-19
HOMT1515230 .....	7-21	HU362AWK .....	3-10	HVLRCA14405DGL – HVLRCCB14405DGL .....	11-20
HOMT1515240 .....	1-19	HU362DF .....	3-12, 3-24	HVLRCA14505DGL – HVLRCA20515DGR .....	11-21
HOMT1515240 .....	7-21	HU362DS .....	3-10, 3-24	HVLRCA14A .....	11-19, 11-22
HOMT1515250 .....	1-19	HU362DSEI .....	3-10	HVLRCA20305D – HVLRCCB20A .....	11-19
HOMT1515250 .....	7-21	HU362DSWA .....	3-14, 3-24	HVLRCCB14405DGR – HVLRCCB20415DGR .....	11-20
HOMT1520 .....	1-19, 7-21	HU362DSWC .....	3-14, 3-24	HVLRCCB14505DGL – HVLRCCB20515DGR .....	11-21
HOMT2020 .....	1-19, 7-21	HU362DX .....	3-13, 3-24	HVLRCCDSA10 – HVLRCCDSA9 .....	11-20
HOMT2020220 .....	1-19	HU362RB .....	3-10, 3-22	HVLRCCDSA6 .....	11-20, 11-22
HOMT2020220 .....	7-21	HU362SS .....	3-12, 3-24	HVLRCCMBA14A14 .....	11-19, 11-22
HOMT2020225 .....	1-19	HU362WA .....	3-14, 3-22	HVLRCCMBA14A20 – HVLRCCMB20B20 .....	11-19
HOMT2020225 .....	7-21	HU362WC .....	3-14, 3-22	HVLRCC-X3 .....	11-20
HOMT2020230 .....	1-19	HU362WH .....	3-15, 3-22	HVLX3 .....	11-26
HOMT2020230 .....	7-21	HU363 .....	3-10, 3-22	HVMB .....	11-26
HOMT2020240 .....	1-19	HU363A .....	3-10	HVMB305200 .....	11-11 – 11-12
HOMT2020240 .....	7-21	HU363AWA .....	3-14, 3-24	HVMB305200U .....	11-11
HOMT2020250 .....	1-19	HU363AWC .....	3-14, 3-24	HVMH1 .....	11-11
HOMT2020250 .....	7-21	HU363AWK .....	3-10	HVMH2 .....	11-11
HOMT3015 .....	1-19, 7-21	HU363DF .....	3-12, 3-24	HVMK1 .....	11-11 – 11-12
HOMT3020 .....	1-19, 7-21	HU363DS .....	3-10, 3-24	HVMSA3 .....	11-11
HOMTHT .....	1-20	HU363DSWA .....	3-14, 3-24	HVMSA6 .....	11-11
HOMTHT .....	7-22	HU363DSWC .....	3-14, 3-24	HVMX1 .....	11-11 – 11-12
HP2F – HP5SH .....	12-6	HU363DX .....	3-13, 3-24		
HPAFD .....	9-29, 9-40	HU363RB .....	3-10, 3-22		
HQO206AB .....	9-51	HU363SS .....	3-12, 3-24		
HQO206AC .....	9-51	HU363WA .....	3-14, 3-22		
HQO206BC .....	9-51	HU363WC .....	3-14, 3-22		
HQO306 .....	9-51	HU364 .....	3-10, 3-22		
HR2IMA12C .....	6-5	HU364A .....	3-10		
HR2IMA16C( ) – HR9IMA18C( ) .....	6-5	HU364AWK .....	3-10		
HRA36000S15 .....	9-55	HU364DF .....	3-12, 3-24		
HRK1020 .....	3-4, 3-12, 3-16, 9-61, 12-10	HU364DS .....	3-10, 3-24		
HRK30 .....	9-61	HU364RB .....	3-10, 3-22		
HRK4060 .....	3-16	HU364SS .....	3-12, 3-24		
HRL36030M38X – HRL36150M38X .....	7-46, 7-48, 18-37	HU365 .....	3-10, 3-22		
HRL36060CU31X – HRL36060CU54X .....	7-33	HU365AWK .....	3-10		
HRL36060U31X – HRL36060U54X .....	7-33	HU365DS .....	3-10		
HRL36100CU31X – HRL36100CU54X .....	7-33	HU365R .....	3-10, 3-22		
HRL36100U31X – HRL36100U54X .....	7-33	HU365SS .....	3-12		
HRL36150CU31X – HRL36150CU54X .....	7-33	HU366 .....	3-10, 3-22		
HRL36150U31X – HRL36150U54X .....	7-33	HU366AWK .....	3-10		
HU265 .....	3-10, 3-22	HU366DS .....	3-10		
HU265AWK .....	3-10	HU366R .....	3-10, 3-22		
HU265DS .....	3-10	HU366SS .....	3-12		
HU265R .....	3-10, 3-22	HU367 .....	3-10, 3-22		
HU266 .....	3-10, 3-22	HU367AWK .....	3-10, 3-24		
HU266AWK .....	3-10	HU367R .....	3-10, 3-22		
HU266DS .....	3-10	HU368 .....	3-10, 3-22		
HU266R .....	3-10, 3-22	HU368AWK .....	3-10, 3-24		
HU267 .....	3-10, 3-22	HU368R .....	3-10, 3-22		
HU267AWK .....	3-10, 3-23	HU461 .....	3-10, 3-22		
HU267R .....	3-10, 3-22	HU461AWK .....	3-10, 3-24		
HU268 .....	3-10, 3-22	HU461DS .....	3-10, 3-24		
HU268AWK .....	3-10, 3-23	HU462 .....	3-10, 3-22		
HU268R .....	3-10, 3-22	HU462AWK .....	3-10, 3-24		
HU361 .....	3-10, 3-22	HU462DS .....	3-10, 3-24		
HU3612A .....	3-10	HU463 .....	3-10, 3-22		
HU3612AWK .....	3-10	HU463AWK .....	3-10, 3-24		

**I**

IOC44 .....	4-9
IOX .....	4-9
IOX0404 .....	4-9
IOX08 .....	4-9
IOX2411 .....	4-9

**J**

J( )A26150( ) – J( )A26250( ) .....	9-53
J( )A36150 – J( )A36250 .....	9-53
J( )A36250U31X – J( )A36250U54X .....	9-54
J( )L36250M38X – L( )L36600M38X .....	7-48
J225X .....	7-84, 7-86
J225Y .....	7-84, 7-86
J250AWK .....	7-82, 7-86
J250DS .....	7-82, 7-86
J250F .....	7-82, 7-86
J250R .....	7-82, 7-86
J250S .....	7-82, 7-86
J250SS .....	7-82, 7-86
JCK11 – JCK59 .....	23-109
JCK2F( ) – JCK5F( ) .....	23-109
JCK60 .....	23-110
JCK70 .....	23-110
JD250S .....	7-82
JDA34250WU31X – JDA34250WU54X .....	9-55
JDL26150 – JDL26250 .....	7-32
JDL26150C – JDL26250C .....	7-32
JDL34250WU31X – JDL34250WU54X .....	7-42
JDL36150 – JDL36250 .....	7-32
JDL36150C – JDL36250C .....	7-32
JDL36250CU31X – JDL36250CU54X .....	7-33
JDL36250U31X – JDL36250U54X .....	7-33



JGA34250WU31X – JGA34250WU54X	9-55
JGL26000S17	7-44
JGL26000S25	7-44
JGL26150 – JGL26250	7-32
JGL26150C – JGL26250C	7-32
JGL34250WU31X – JGL34250WU54X	7-42
JGL36000S17	7-44
JGL36000S25	7-44
JGL36150 – JGL36250	7-32
JGL36150C – JGL36250C	7-32
JGL36250CU31X – JGL36250U54X	7-33
JGL36250M38X	18-37
JGL36250M38X	7-46, 7-48
JGL37100D81 – JGL37250D82	7-43
JJA34250WU31X – JJA34250WU54X	9-55
JJL26150 – JJL26250	7-32
JJL26150C – JJL26250C	7-32
JJL34250WU31X – JLL34250WU54X	7-42
JJL36150 – JJL36250	7-32
JJL36150C – JJL36250C	7-32
JJL36250CU31X – JLL36250U54X	7-33
JJL36250M38X	7-46, 7-48, 18-37
JLA26000S17	9-55
JLA26000S25	9-55
JLA34250WU31X – JLA34250WU54X	9-55
JLA36000S17	9-55
JLA36000S25	9-55
JLL26000S17	7-44
JLL26000S25	7-44
JLL26150 – JLL26250	7-32
JLL26150C – JLL26250C	7-32
JLL36000S17	7-44
JLL36000S25	7-44
JLL36150 – JLL36250	7-32, 16-55
JLL36150C – JLL36250C	7-32
JLL36250	16-55
JLL36250M38X	18-37
JLL36250M38X	7-46, 7-48
JLL37100D81 – JLL37250D82	7-43
JRA36000S17	9-55
JRA36000S25	9-55
JRL36000S17	7-44
JRL36000S25	7-44
JRL36150 – JRL36250	7-32
JRL36150C – JRL36250C	7-32
JRL36250CU31X – JRL36250U54X	7-33
JRL36250M38X	7-46, 7-48, 18-37

**K**

KAC1BZ	8-6
KAD1PZ	8-3, 8-6
KADIXZ	8-6
KAE1BZ	8-6
KAF1PZ	8-6
KAF1XZ	8-6
KAF2PZ	8-6
KAF2XZ	8-6
KAF3PZ	8-6
KAG2XZ	8-6
KBD1PZ	8-6
KBF1PZ	8-6
KBF2PZ	8-6
KBF3PZ	8-6
KCC1LZ	8-6
KCC1YZ	8-3, 8-6
KCD1PZ	8-3, 8-6
KCD1YZ	8-6
KCE1LZ	8-6
KCE1YZ	8-6
KCF1PZ	8-6
KCF1YZ	8-6
KCF2PZ	8-6
KCF2YZ	8-6
KCF3PZ	8-6
KCG2YZ	8-6
KDD1PZ	8-6
KDF1PZ	8-6
KDF2PZ	8-6
KDF3PZ	8-6
KFP	1-26

KZ32 – KZ74	8-7
KZ100	8-7
KZ101	8-7
KZ103	8-7
KZ13	8-7
KZ14	8-7
KZ15	8-7
KZ16	8-7
KZ32	8-3
KZ62	8-6
KZ65	8-6
KZ66	8-6
KZ67	8-6
KZ76	8-7
KZ77	8-7
KZ81	8-7
KZ83	8-3, 8-7

**L**

L( )A36250U31X – L( )A36600U54X	9-56
L100WDR2M4 – L100WS2M3	21-44
L111N	3-3, 3-7
L1200S	7-83, 7-86
L211N	3-3, 3-7
L300WDR2M4 – L300WS2M3	21-44
L525WDL2M57 – L525WDR2M59	21-44
L600AWK	7-83, 7-86
L600AWKMC	7-83, 7-86
L600AWKVW	7-86
LA1DX02	23-87
LA1DX20	16-18, 18-14, 23-87
LA1DY20	16-18, 18-14, 23-87
LA1DZ31	16-18, 18-14, 23-87
LA1DZ40	16-18, 18-14, 23-87
LA1KN02	18-13, 23-92
LA1KN023 – LA1KN403	23-92
LA1KN027	18-13, 23-92
LA1KN04	18-13, 23-92
LA1KN047	18-13, 23-92
LA1KN11	18-13, 23-92
LA1KN117	18-13, 23-92
LA1KN13	18-13, 23-92
LA1KN137	18-13, 23-92
LA1KN20	18-13, 23-92
LA1KN207	18-13, 23-92
LA1KN22	18-13, 23-92
LA1KN227	18-13, 23-92
LA1KN31	18-13, 23-92
LA1KN317	18-13, 23-92
LA1KN40	18-13, 23-92
LA1KN407	18-13, 23-92
LA1SK02	23-93
LA1SK11	23-93
LA1SK20	23-93
LA26125( ) – LA26400( )	9-56
LA2KT2E	18-13, 23-92
LA2KT2U	18-13, 23-92
LA36125 – LA36400	9-56
LA400AWK	7-84, 7-86
LA400DS	7-84, 7-86
LA400F	7-84, 7-86
LA400LS	7-86
LA400R	7-84, 7-86
LA400S	7-84, 7-86
LA4DA2E	18-16
LA4DA2G	18-16
LA4DA2N	18-16
LA4DA2U	18-16
LA4DB2B	18-17
LA4DB2S	18-17
LA4DB3B	18-17
LA4DB3S	18-17
LA4DC3U	18-16
LA4DE2E	18-16
LA4DE2U	18-16
LA4DE3E	18-16
LA4DE3G	18-16
LA4DE3U	18-16
LA4DFB	16-21, 18-17

LA4DFE	18-17
LA4DLB	16-21, 18-17
LA4DLE	18-17
LA4DMK	18-17, 23-89
LA4DT0U	16-21, 18-17, 23-89
LA4DT2U	16-21, 18-17, 23-89
LA4DT4U	16-21, 18-17, 23-89
LA4DWB	16-21, 18-17
LA4KA1U	18-13, 23-92
LA4KC1B	18-13, 23-92
LA4KC1E	18-13, 23-92
LA4KE1B	18-13, 23-92
LA4KE1E	18-13, 23-92
LA4KE1FC	18-13, 23-92
LA4KE1UG	18-13, 23-92
LA4SKEIE	23-93
LA4SKEIU	23-93
LA5D115450	18-15
LA5D11550	18-15
LA5D1158031	18-15
LA5D115804	18-15
LA5D15050	18-15
LA5D150803	18-15
LA5F115450 – LA5F800803	18-57
LA5F11550 – LA5F80050	18-57
LA5FF431	18-57
LA5FF441	18-57
LA5FG431	18-57
LA5FG441	18-57
LA5FH431	18-57
LA5FH441	18-57
LA6DK20	18-14
LA7D03	18-21
LA7D3064	18-21
LA7D901	18-21
LA7D902	18-21
LA7D903	18-21
LA7F401 – LA7F407	18-21
LA7F701 – LA7F902	18-21
LA7K0064	18-13
LA8D324	18-50
LA9CA06GX	18-47
LA9CA06VT	18-47
LA9D09966	18-15
LA9D09980	18-20
LA9D09981	18-20
LA9D11502	18-18
LA9D115603	18-15
LA9D11567	18-15
LA9D11569	18-18
LA9D11570	18-18
LA9D1263	18-15
LA9D2561	18-15
LA9D3260	18-15
LA9D4002	18-18
LA9D50978	18-18
LA9D511	18-15
LA9D65A69	16-19, 18-18
LA9D8002	18-18
LA9D8067	18-15
LA9D8069	18-18
LA9D8070	18-18
LA9D80961	18-15
LA9D80962	18-15
LA9D80963	18-15
LA9D80978	18-18
LA9D90	18-13, 23-92
LA9D901	23-89
LA9D92	18-15
LA9D93	18-15
LA9E01	18-13
LA9E02	18-13
LA9F103	18-20
LA9F15076	16-19, 18-12, 18-19
LA9F15077	18-19
LA9F15082	18-19
LA9F22576	18-12, 18-19
LA9F22577	18-19
LA9F22582	18-19
LA9F701	18-20 – 18-21
LA9F702	18-20 – 18-21, 26-29

LA9F703	18-20 – 18-21, 26-29	LAD4CM	16-19, 18-18	LADT9R1V	18-18
LA9F704	18-20	LAD4D3U	16-20, 18-16	LAL26125 – LAL36400	7-35
LA9F705	18-21	LAD4DDL	16-20, 18-16	LC( )K06( )J3	18-2
LA9F706	18-20	LAD4RC3E	16-20, 18-16	LC( )K09( )J3	18-2
LA9F707	18-20	LAD4RC3G	16-20, 18-16	LC( )K12( )J3	18-2
LA9F708	18-20	LAD4RC3N	18-16	LC1D09	18-7
LA9F709	18-20	LAD4RC3U	16-20, 18-16	LC1D098	18-7
LA9F980	18-20	LAD4RCE	16-20, 18-16, 23-88	LC1D115	18-7, 18-15
LA9FF4F	18-19	LAD4RCG	16-20, 18-16	LC1D115004	18-7
LA9FF601	18-15	LAD4RCU	16-20, 18-16, 23-88	LC1D12	18-7
LA9FF602	18-15	LAD4T3B	16-20, 18-17	LC1D128	18-7
LA9FF970	16-19, 18-12, 18-19	LAD4T3G	16-20, 18-17	LC1D150	18-7, 18-15
LA9FF976	16-19, 18-12, 18-19	LAD4T3R	18-17	LC1D18	18-7
LA9FF977	18-19	LAD4T3S	18-17	LC1D188	18-7
LA9FF982	18-19	LAD4T3U	16-20, 18-17	LC1D25	18-7
LA9FG4F	18-19	LAD4TB	16-20, 18-17, 23-88	LC1D258	18-7
LA9FG4G	18-19	LAD4TBDL	18-17	LC1D32	18-7
LA9FG601	18-15	LAD4TGDL	18-17	LC1D38	18-7
LA9FG602	18-15	LAD4TS	18-17	LC1D40A	18-7
LA9FG970	18-12, 18-19	LAD4TSDL	18-17	LC1D50A	18-7
LA9FG976	18-12, 18-19	LAD4TUDL	18-17	LC1D65A	18-7
LA9FG977	18-19	LAD4TXDL	18-17	LC1D80	18-7, 18-67
LA9FG982	18-19	LAD4V3E	16-20, 18-16	LC1D80004	18-7
LA9FH4F	18-19	LAD4V3G	16-20, 18-16	LC1D80008	18-7
LA9FH4G	18-19	LAD4V3U	16-20, 18-16	LC1D95	18-7, 18-67
LA9FH4H	18-19	LAD4VE	16-20, 18-16, 23-88	LC1DFK	18-9
LA9FH601	18-15	LAD4VG	16-20, 18-16, 23-88	LC1DGK	18-9
LA9FH602	18-15	LAD4VU	16-20, 18-16, 23-88	LC1DLK	18-9
LA9FH976	18-12, 18-19	LAD5C11	18-33	LC1DMK	18-9
LA9FH977	18-19	LAD5C12	18-33	LC1DT20	18-7
LA9FH982	18-19	LAD5C31	18-36	LC1DT25	18-7
LA9FJ4F	18-19	LAD5C32	18-36	LC1DT32	18-7
LA9FJ4G	18-19	LAD6K10	16-18, 18-14, 23-88	LC1DT40	18-7
LA9FJ4H	18-19	LAD703	18-21	LC1DT60A	18-7
LA9FJ4J	18-19	LAD7305	18-21	LC1DT80A	18-7
LA9FJ970	16-19, 18-12, 18-19	LAD7B10	18-21	LC1DVK12	18-9
LA9FJ976	16-19, 18-12, 18-19	LAD7B106	18-21	LC1F115	18-11 – 18-12
LA9FJ977	18-19	LAD7B205	18-21	LC1F1154 – LC1F7804	18-11
LA9FJ982	18-19	LAD7C1	18-21	LC1F115G6	18-12
LA9FK4F	18-19	LAD7C2	18-21	LC1F150	18-11 – 18-12
LA9FK4G	18-19	LAD7X3	18-15	LC1F185	18-11 – 18-12
LA9FK4H	18-19	LAD8N02 – LADN403	23-87	LC1F225	18-11 – 18-12
LA9FK4J	18-19	LAD8N11	16-18, 18-14, 23-87	LC1F265	18-11 – 18-12
LA9FK4K	18-19	LAD8N20	16-18, 18-14, 23-87	LC1F330	18-11 – 18-12
LA9FK601	18-15	LAD90	18-15	LC1F400	18-11 – 18-12
LA9FK602	18-15	LAD92560	18-15	LC1F500	18-11 – 18-12
LA9FK976	16-19, 18-12, 18-19	LAD96560	18-15	LC1F630	18-11 – 18-12
LA9FK977	18-19	LAD96570	18-36	LC1F780	18-11 – 18-12
LA9FK982	18-19	LAD9ET1	23-89	LC1F800	18-11 – 18-12
LA9FL4F	18-19	LAD9ET1S	18-17	LC1K0601	18-2
LA9FL4G	18-19	LAD9ET3S	18-17	LC1K0610	18-2
LA9FL4H	18-19	LAD9ET4S	18-17	LC1K09004	18-5
LA9FL4J	18-19	LAD9FP3	18-15	LC1K09008	18-5
LA9FL4K	18-19	LAD9P3	18-15	LC1K0901	18-2
LA9FL4L	18-19	LAD9P32	18-15	LC1K0910	18-2
LA9FL601	18-15	LAD9P33	18-15	LC1K12004	18-5
LA9FL602	18-15	LAD9R1	16-19, 18-19	LC1K1201	18-2
LA9FL970	16-19, 18-12, 18-19	LAD9R1V	16-19, 18-19	LC1K1210	18-2
LA9FL976	16-19, 18-12, 18-19	LAD9R3	16-19, 18-19	LC2D09	18-9
LA9FL977	18-19	LADC22	16-18, 18-12, 18-14, 23-87	LC2D115	18-9
LA9FL982	18-19	LADN01	16-18, 18-12, 18-14	LC2D115004	18-9
LA9FX970	18-19	LADN02	16-18, 18-14, 23-87	LC2D12	18-9
LA9FX971	18-19	LADN04	16-18, 18-12, 18-14, 23-87	LC2D150	18-9
LA9K0969	18-13	LADN10	16-18, 18-12, 18-14	LC2D18	18-9
LA9K0970	18-13	LADN11	16-18, 18-12, 18-14, 23-87	LC2D25	18-9
LA9RM201	23-114	LADN13	16-18, 18-12, 18-14, 23-87	LC2D32	18-9
LAD21 – LAD22	23-89	LADN20	16-18, 18-12, 18-14, 23-87	LC2D38	18-9
LAD31	18-33	LADN22	16-18, 18-12, 18-14, 23-87	LC2D40A	18-9
LAD311	18-33, 18-58	LADN31	16-18, 18-12, 18-14, 23-87	LC2D50A	18-9
LAD32	18-58	LADN40	16-18, 18-12, 18-14, 23-87	LC2D95	18-9
LAD322	18-58	LADR0	16-18, 18-14, 23-88	LC2DT20	18-9
LAD324	18-58	LADR03 – LADR43	23-88	LC2DT25	18-9
LAD331	18-58	LADR2	16-18, 18-14, 23-88	LC2DT32	18-9
LAD341	18-58	LADR4	16-18, 18-14, 23-88	LC2DT40	18-9
LAD351	18-58	LADS2	16-18, 18-14, 23-88	LC2K0601	18-3
LAD3B	18-58	LADS23	23-88	LC2K0610	18-3
LAD4BB	16-20, 18-17, 23-89	LADT0	16-18, 18-14, 23-88	LC2K09004	18-5
LAD4BB3	16-20, 18-17	LADT03 – LADT43	23-88	LC2K0901	18-3
LAD4BBVE	16-20, 18-17, 23-89	LADT2	16-18, 18-14, 23-88	LC2K0910	18-3
LAD4BBVG	16-20, 18-17, 23-89	LADT4	16-18, 18-14, 23-88	LC2K12004	18-5
LAD4BBVU	16-20, 18-17, 23-89	LADT9R1	18-18	LC2K1201	18-3

L2K1210	18-3	LJB42	13-3	LJB85B	13-2 - 13-3
LDA34250WU31X - LDA34600WU54X	9-55	LJB42R	13-3	LJB86R	13-3
LDB101 - LDB1090LS	13-2	LJB43	13-3	LJB890C	13-3
LDB10A - LDB10TF	13-2	LJB44	13-3	LJB890LCCW - LJB890LCW	13-3
LDB10C	13-2	LJB445LI	13-3	LJB890LI - LJB890LT	13-3
LDB121 - LDB1290LS	13-2	LJB445LO	13-3	LJB8A	13-3
LDB12A - LDB12TF	13-2	LJB445LT	13-3	LJB8BH	13-3
LDB21 - LDB290LS	13-2	LJB45	13-3	LJB8C	13-3
LDB2A - LDB2TF	13-2	LJB45B	13-2 - 13-3	LJB8CF	13-3
LDB41 - LDB490LS	13-2	LJB45BKM	13-2 - 13-3	LJB8CFL	13-3
LDB4A - LDB4TF	13-2	LJB490C	13-3	LJB8CP	13-3
LDB61 - LDB690LS	13-2	LJB490LCCW	13-3	LJB8DH	13-3
LDB6A - LDB6TF	13-2	LJB490LCW	13-3	LJB8FF	13-3
LDB81 - LDB890LS	13-2	LJB490LI	13-3	LJB8JB	13-3
LDB8A - LDB8TF	13-2	LJB490LO	13-3	LJB8S	13-3
LDL34250WU31X - LDL44600WU54X	7-42	LJB490LOT	13-3	LJB8SB	13-3
LDL36250CU31X - LDL46400CU54X	7-37	LJB490LT	13-3	LJB8TF	13-3
LDL36250U31X - LDL46600U54X	7-36	LJB4A	13-3	LJB8TO	13-3
LDRB410M - LDRB4WH	13-4	LJB4BB2C	13-2 - 13-3	LJB8TT	13-3
LDRB610M - LDRB6WH	13-4	LJB4BB3C	13-2 - 13-3	LJB8X	13-3
LDRB810M - LDRB8WH	13-4	LJB4BH	13-3	LJL34250WU31X - LJL44600WU54X	7-42
LE1D093A62O( ) - LE2D803A72O( )	18-42	LJB4C	13-3	LJL36250CU31X - LJL46400CU54X	7-37
LE1D096A62O( ) - LE1D096A72O( )	18-45	LJB4CF	13-3	LJL36250U31X - LJL46600U54X	7-36
LE1D098B62O( ) - LE1D099E72O( )	18-44	LJB4CFL	13-3	LJL36400M38X	18-37
LE1D118E62O( ) - LE1D188B72O( )	18-44	LJB4CP	13-3	LJL36400M38X	7-46, 7-48
LE1D126A62O( ) - LE1D186A72O( )	18-45	LJB4DH	13-3	LJL36400U31X	1-35
LE1D256A62O( ) - LE1D256A72O( )	18-45	LJB4FF	13-3	LJL36600M38X	18-37
LE1D258C62O( ) - LE1D329F72O( )	18-44	LJB4JB	13-3	LJL36600M38X	7-46, 7-48
LE1D326A62O( ) - LE1D326A72O( )	18-45	LJB4S	13-3	LK100AN	1-11 - 1-12, 1-21, 1-25 - 1-27, 1-37
LE1D406A62O( ) - LE1D406A72O( )	18-45	LJB4SB	13-3	LK125AN	1-26 - 1-27
LE1D408C62O( ) - LE1D409F72O( )	18-44	LJB4TF	13-3	LK150AN	1-26
LE1D508D62O( ) - LE1D509G72O( )	18-44	LJB4TO	13-3	LK225AN	1-26 - 1-27
LE1D658D62O( ) - LE1D659G72O( )	18-44	LJB4TT	13-3	LK225ANHOM	1-26 - 1-27
LE1D808E62O( ) - LE1D809G72O( )	18-44	LJB4X	13-3	LK4AD10N	8-25
LE2D096A62O( ) - LE2D096A72O( )	18-45	LJB601	13-3	LK4AD20N	8-25
LE2D098B62O( ) - LE2D099E72O( )	18-44	LJB602	13-3	LK4AD30N	8-25
LE2D118E62O( ) - LE2D188B72O( )	18-44	LJB603	13-3	LK4AE12CN	8-25
LE2D119H62O( ) - LE2D186A72O( )	18-45	LJB606	13-3	LK4AE41CN	8-24
LE2D256A62O( ) - LE2D256A72O( )	18-45	LJB61	13-3	LK4AH0110CN	8-24
LE2D258C62O( ) - LE2D259E72O( )	18-44	LJB610	13-3	LK4AH0120CN	8-24
LE2D326A62O( ) - LE2D329F72O( )	18-45	LJB61CCW	13-3	LK4AH0410CN	8-24
LE2D328C62O( ) - LE2D328C72O( )	18-44	LJB61CW	13-3	LK4AH0420CN	8-24
LE2D406A62O( ) - LE2D409F72O( )	18-45	LJB62	13-3	LK4AH110CN	8-25
LE2D408C62O( ) - LE2D408C72O( )	18-44	LJB63	13-3	LK4AH1120CN	8-25
LE2D508D62O( ) - LE2D508D72O( )	18-44	LJB64	13-3	LK4AH410CN	8-25
LE2D509G62O( ) - LE2D509G72O( )	18-45	LJB645LI	13-3	LK4AH420CN	8-25
LE2D658D62O( ) - LE2D658D72O( )	18-44	LJB645LO	13-3	LK4AP33BN	8-25
LE2D659G62O( ) - LE2D659G72O( )	18-45	LJB645LT	13-3	LK4AP33TN	8-25
LE2D808E62O( ) - LE2D808E72O( )	18-44	LJB64R	13-3	LK4AP3CN	8-25
LE2D809G62O( ) - LE2D809G72O( )	18-45	LJB65	13-3	LK4AP53BN	8-25
LGA34250WU31X - LGA34600WU54X	9-55	LJB65B	13-2 - 13-3	LK4AP53TN	8-25
LGA36000S40X	9-55	LJB65BKM	13-2 - 13-3	LK4AP63N	8-25
LGA36000S60X	9-55	LJB690C	13-3	LK4AP83N	8-25
LGL34250WU31X - LGL44600WU54X	7-42	LJB690LCCW	13-3	LK4DU3CN	8-24
LGL36000S40X - LGL46000S60X	7-44	LJB690LCW	13-3	LK4DUKB1	8-24
LGL36250CU31X - LGL46400CU54X	7-37	LJB690LI	13-3	LK4DUKB4	8-24
LGL36250U31X - LGL46600U54X	7-36	LJB690LO	13-3	LK4DUKR1	8-24
LGL36400M38X	18-37	LJB690LOT	13-3	LK4DUKR4	8-24
LGL36400M38X	7-46, 7-48	LJB690LT	13-3	LK4GU3CN	8-24, 8-27
LGL36600M38X	18-37	LJB6A	13-3	LK4GUKB1	8-24
LGL36600M38X	7-46, 7-48	LJB6BB2C	13-2 - 13-3	LK4GUKB4	8-24
LGL37030D27 - LGL47120D42	7-43	LJB6BB3C	13-2 - 13-3	LK4GUKR1	8-24
LHE26000( ) - LHE36000( )	2-24	LJB6BH	13-3	LK4GUKR4	8-24
LHL26125 - LHL36400	7-35	LJB6C	13-3	LK4JU3CN	8-24
LJA34250WU31X - LJA34600WU54X	9-55	LJB6CF	13-3	LK4JU3N	8-24, 8-27
LJB12606 - LJB12690LT	13-3	LJB6CFL	13-3	LK4JUKB1	8-24
LJB126A - LJB126X	13-3	LJB6CP	13-3	LK4JUKB4	8-24
LJB201 - LJB210	13-3	LJB6DH	13-3	LK4JUKR1	8-24
LJB21CCW - LJB21CW	13-3	LJB6FF	13-3	LK4JUKR4	8-24
LJB22 - LJB25	13-3	LJB6JB	13-3	LK4MU3N	8-24, 8-27
LJB245LI - LJB245LT	13-3	LJB6S	13-3	LK4QU3N	8-24, 8-27
LJB290C - LJB290LT	13-3	LJB6SB	13-3	LK4SU3N	8-24, 8-27
LJB2A - LJB2X	13-3	LJB6TF	13-3	LK4TU3N	8-24, 8-27
LJB401	13-3	LJB6TO	13-3	LK4UU3N	8-24, 8-27
LJB402	13-3	LJB6TT	13-3	LK4WU3N	8-24, 8-27
LJB403	13-3	LJB6X	13-3	LK70AN	1-26 - 1-27
LJB406	13-3	LJB806	13-3	LLA34250WU31X - LLA34600WU54X	9-55
LJB41	13-3	LJB81 - LJB84	13-3	LLA36000S40X - LRA36000S60X	9-55
LJB410	13-3	LJB810	13-3	LLL34250WU31X - LLL44400WU54X	7-42
LJB41CCW	13-3	LJB845LI - LJB845LT	13-3	LLL36000S40X - LLL46000S60X	7-44
LJB41CW	13-3	LJB85	13-3	LLL36045D31 - LLL47120D42	7-43

**Product Locator Index**

Alphanumeric Listing



www.se.com/us

LLL36250CU31X – LLL46400CU54X	7-37	LR3D10L	16-16, 16-119, 18-8	LRD04L	16-16, 16-119, 18-8
LLL36250U31X – LLL46600U54X	7-36	LR3D10L6	16-119	LRD04L6	16-119
LLL36400M38X	18-37	LR3D12	16-16, 18-8	LRD05	16-16, 18-8
LLL36400M38X	7-46, 7-48	LR3D12L	16-16, 16-119, 18-8	LRD05L	16-16, 16-119, 18-8
LLL36400U33XLLL36600U33X	16-55	LR3D12L6	16-119	LRD05L6	16-119
LLL36600M38X	18-37	LR3D14	16-16, 18-8	LRD06	16-16, 18-8
LLL36600M38X	7-46, 7-48	LR3D14L	16-16, 16-119, 18-8	LRD06L	16-16, 16-119, 18-8
LLL36600U33X MJL36800	16-55	LR3D14L6	16-119	LRD06L6	16-119
LP1K0601	18-2	LR3D16	16-16, 18-8	LRD07	16-16, 18-8
LP1K0610	18-2	LR3D16L	16-16, 16-119	LRD07L	16-16, 16-119, 18-8
LP1K09004	18-5	LR3D16L6	16-119	LRD07L6	16-119
LP1K09008	18-5	LR3D21	16-16, 18-8	LRD08	16-16, 18-8
LP1K0901	18-2	LR3D21L	16-16, 16-119, 18-8	LRD08L	16-16, 16-119, 18-8
LP1K0910	18-2	LR3D21L6	16-119	LRD08L6	16-119
LP1K12004	18-5	LR3D22	16-16, 18-8	LRD10	16-16, 18-8
LP1K1201	18-2	LR3D22L	16-16, 16-119, 18-8	LRD10L	16-16, 16-119, 18-8
LP1K1210	18-2	LR3D22L6	16-119	LRD10L6	16-119
LP2K0601	18-4	LR3D313	16-16, 18-8	LRD12	16-16, 18-8
LP2K0610	18-4	LR3D318	16-16, 18-8	LRD12L	16-16, 16-119, 18-8
LP2K09004	18-5	LR3D32	16-16, 18-8	LRD12L6	16-119
LP2K0901	18-4	LR3D325	16-16, 18-8	LRD14	16-16, 18-8
LP2K0910	18-4	LR3D32L	16-119, 18-8	LRD14L	16-16, 16-119, 18-8
LP2K12004	18-5	LR3D32L6	16-119	LRD14L6	16-119
LP2K1201	18-4	LR3D332	16-16, 18-8	LRD16	16-16, 18-8
LP2K1210	18-4	LR3D3322	18-8	LRD16L	16-16, 16-119, 18-8
LP4K0601	18-2	LR3D3353	18-8	LRD16L6	16-119
LP4K0610	18-2	LR3D3355	18-8	LRD21	16-16, 18-8
LP4K09004	18-5	LR3D3357	18-8	LRD21L	16-16, 16-119, 18-8
LP4K09008	18-5	LR3D3359	18-8	LRD21L6	16-119
LP4K0901	18-2	LR3D3361	18-8	LRD22	16-16, 18-8
LP4K0910	18-2	LR3D3363	18-8	LRD22L	16-16, 16-119, 18-8
LP4K12004	18-5	LR3D340	16-16, 18-8	LRD22L6	16-119
LP4K1201	18-2	LR3D35	18-8	LRD313	16-16, 18-8
LP4K1210	18-2	LR3D350	16-16, 18-8	LRD313L	16-16, 18-8
LP5K0601	18-4	LR3D352	18-8	LRD318	16-16, 18-8
LP5K0610	18-4	LR3D3553	18-8	LRD318L	16-16, 18-8
LP5K09004	18-5	LR3D3555	18-8	LRD32	16-16, 18-8
LP5K0901	18-4	LR3D3557	18-8	LRD325	16-16, 18-8
LP5K0910	18-4	LR3D3559	18-8	LRD325L	16-16, 18-8
LP5K12004	18-5	LR3D3561	18-8	LRD32L	16-119, 18-8
LP5K1201	18-4	LR3D3563	18-8	LRD32L6	16-119
LP5K1210	18-4	LR3D365	18-8	LRD332	16-16, 18-8
LR2D3522	18-8	LR9D01	16-16, 18-8	LRD3322	18-8
LR2D3553	18-8	LR9D02	16-16, 18-8	LRD332L	16-16, 18-8
LR2D3555	18-8	LR9D08	16-16, 18-8	LRD3353	18-8
LR2D3557	18-8	LR9D110S	18-8	LRD3355	18-8
LR2D3559	18-8	LR9D32	16-16, 18-8	LRD3357	18-8
LR2D3561	18-8	LR9D5367	18-8	LRD3359	18-8
LR2D3563	18-8	LR9D5369	18-8	LRD3361	18-8
LR2K0301	18-3	LR9D5567	18-8	LRD3363	18-8
LR2K0302	18-3	LR9D5569	18-8	LRD3365	18-8
LR2K0303	18-3	LR9D67	18-8	LRD340	16-16, 18-8
LR2K0304	18-3	LR9D69	18-8	LRD340L	16-16, 18-8
LR2K0305	18-3	LR9F5357	18-11	LRD35	18-8
LR2K0306	18-3	LR9F5363	18-11	LRD350	16-16, 18-8
LR2K0307	18-3	LR9F5367	18-11	LRD350L	16-16, 18-8
LR2K0308	18-3	LR9F5369	18-11	LRD365	18-8
LR2K0310	18-3	LR9F5371	18-11	LRD365L	18-8
LR2K0312	18-3	LR9F5557	18-11	LRD4365	18-8
LR2K0314	18-3	LR9F5563	18-11	LRD4367	18-8
LR2K0316	18-3	LR9F5567	18-11	LRD4369	18-8
LR2K0321	18-3	LR9F5569	18-11	LRL36000S40X – LRL46000S60X	7-44
LR3D01	16-16, 18-8	LR9F5571	18-11	LRL36250CU31X – LRL46400CU54X	7-37
LR3D02	16-16, 18-8	LR9F57	18-11	LRL36250U31X – LRL46600U54X	7-36
LR3D03	16-16, 18-8	LR9F63	18-11	LRL36400M38X	18-37
LR3D04	16-16, 18-8	LR9F67	18-11	LRL36400M38X	7-46, 7-48
LR3D04L	16-16, 16-119, 18-8	LR9F69	18-11	LRL36600M38X	18-37
LR3D04L6	16-119	LR9F71	18-11	LRL36600M38X	7-46, 7-48
LR3D05	16-16, 18-8	LR9F7375	18-11	LS1D30	18-50
LR3D05L	16-16, 16-119, 18-8	LR9F7379	18-11	LS1D303	18-50
LR3D05L6	16-119	LR9F7381	18-11	LS1D32	18-50
LR3D06	16-16, 18-8	LR9F75	18-11	LS1D323	18-50
LR3D06L	16-16, 16-119, 18-8	LR9F7575	18-11	LSDL	1-26 – 1-27
LR3D06L6	16-119	LR9F7579	18-11	LT6CT1001	16-106
LR3D07	16-16, 18-8	LR9F7581	18-11	LT6CT2001	16-106
LR3D07L	16-16, 16-119, 18-8	LR9F79	18-11	LT6CT4001	16-106
LR3D07L6	16-119	LR9F81	18-11	LT6CT8001	16-106
LR3D08	16-16, 18-8	LRD01	16-16, 18-8	LTM9CE180T	16-107
LR3D08L	16-16, 16-119, 18-8	LRD02	16-16, 18-8	LTM9KCU	16-105
LR3D08L6	16-119	LRD03	16-16, 18-8	LTMCC004	16-107
LR3D10	16-16, 18-8	LRD04	16-16, 18-8	LTMCU	16-105

ALPHA-NUMERIC LISTING

LTMEV40BD	16-105	LULC07	18-25	LV833659SP	7-68
LTMEV40FM	16-105	LULC08	18-25	LV833660SP	7-68
LTMR08CBD – LTMR27PFM	16-104	LULC09	18-25	LV833661SP	7-68
LTSL3P	7-57	LULC14	18-25	LV833662SP	7-68
LTSL4P	7-57	LULC15	18-25	LV833663SP	7-68
LTSM3P	7-57	LV26950	8-39	LV833664SP	7-68
LTSM4P	7-57	LV426801 – LV426952	7-49	LV833718SP	7-72
LTS53P	7-57	LV426905 – LV426993	7-52	LV833857SP	7-72
LU2B12	18-24	LV426911	7-57	LV833859SP	7-72
LU2B32	18-24	LV426912	7-57	LV833895SP	7-72
LU9APN43	18-25	LV426913	7-57	LV833982SP	7-66
LU9APN44	18-25	LV426920	18-39	LV833983SP	7-66
LU9BN11C	18-25	LV426930	7-51	LV833984SP	7-66
LU9BN11L	18-25	LV426931	7-51	LV834035SP	7-70
LU9ET1S	18-17	LV426932	7-51	LV834036SP	7-70
LU9GC3	26-28 – 26-29	LV426933	7-51	LV834037SP	7-70
LU9MR1	18-24	LV426935	18-39	LV836390SP	7-66
LU9MR1C	18-24	LV426936	18-39	LV836391SP	7-66
LU9MRL	18-25	LV426937	18-39	LV839289SP	7-69
LU9R03	16-107	LV426962	7-57	LV839290SP	7-69
LU9R10	16-107	LV426963	7-57	LV839291SP	7-71
LU9SP0	18-24	LV426964	7-54	LV839292SP	7-71
LUA1C11	16-12, 18-22	LV426965	7-54	LV839293SP	7-71
LUA1C20	16-12, 18-22	LV426966	7-54	LV839294SP	7-71
LUA4F11	18-25	LV426967	7-54	LV839295SP	7-71
LUA4F12	18-25	LV426973	7-54	LV839296SP	7-69
LUA8E20	18-25	LV426974	7-54	LV839297SP	7-69
LUALB1	18-24	LV426975	7-54	LV839298SP	7-69
LUALF1	18-24	LV426986	7-55	LV839453SP	7-66
LUB 12	18-51	LV426987	7-55	LV839454SP	7-66
LUB 32	18-51	LV426988	7-55	LV847053SP	7-66
LUB12	18-22	LV426989	7-55	LV847074SP	7-68 – 7-69, 7-71
LUB120	18-22	LV426992	18-40	LV847075SP	7-69
LUB32	18-22	LV426997	18-39	LV847076SP	7-69
LUB320	18-22	LV426998	18-39	LV847077SP	7-69
LUB32NR	16-12	LV426999	18-39	LV847080SP	7-69
LUC ( )18BL	18-51	LV429226	7-57	LV847081SP	7-69
LUC ( )05BL	18-51	LV434000	7-75	LV847092SP	7-72
LUC ( )12BL	18-51	LV434001	7-68, 7-75	LV847093SP	7-68
LUC ( )18BL	18-51	LV434002	7-68, 7-75	LV847098SP	7-72
LUC ( )32BL	18-51	LV434063	7-68, 7-75	LV847821SP	7-66
LUCA05 ( )	16-12, 18-22, 18-24	LV434128	7-68, 7-75	LV847822SP	7-66
LUCA12 ( )	16-12, 18-22, 18-24	LV434195	7-76	LV847823SP	7-66
LUCA18 ( )	16-12, 18-22, 18-24	LV434196	7-76	LV847824SP	7-66
LUCA1X ( )	16-12, 18-22, 18-24	LV434197	7-76	LV847825SP	7-66
LUCA32 ( )	16-12, 18-22, 18-24	LV434198	7-76	LV847826SP	7-66
LUCAX6 ( )	16-12, 18-22, 18-24	LV434211	7-76	LV847849SP	7-68 – 7-69, 7-71
LUCB05 ( )	16-12, 18-22, 18-24	LV454440	7-62, 7-76	LV847850SP	7-69
LUCB12 ( )	16-12, 18-22, 18-24	LV454441	7-62, 7-76	LV847888SP	7-71
LUCB18 ( )	16-12, 18-22, 18-24	LV454442	7-62, 7-76	LV847889SP	7-71
LUCB1X ( )	16-12, 18-22, 18-24	LV454443	7-62, 7-76	LV847890SP	7-71
LUCB32 ( )	16-12, 18-22, 18-24	LV454444	7-62, 7-76	LV847891SP	7-71
LUCBX6 ( )	16-12, 18-22, 18-24	LV833033SP	7-68	LV847893SP	7-71
LUCC05 ( )	16-12, 18-22, 18-24	LV833034SP	7-68	LV847894SP	7-71
LUCC12 ( )	16-12, 18-22, 18-24	LV833035SP	7-68	LV847895SP	7-71
LUCC18 ( )	16-12, 18-22, 18-24	LV833036SP	7-68	LV847896SP	7-71
LUCC1X ( )	16-12, 18-22, 18-24	LV833037SP	7-68	LV847897SP	7-71
LUC32 ( )	16-12, 18-22, 18-24	LV833038SP	7-68	LV847904SP	7-68
LUC3X6 ( )	16-12, 18-22, 18-24	LV833091SP	7-66	LV847914SP	7-69, 7-72
LUCD05 ( )	16-12, 18-22, 18-24	LV833092SP	7-66	LV847915SP	7-69
LUCD12 ( )	16-12, 18-22, 18-24	LV833093SP	7-66	LV847916SP	7-69
LUCD18 ( )	16-12, 18-22, 18-24	LV833094SP	7-66	LV847926SP	7-69
LUCD1X ( )	16-12, 18-22, 18-24	LV833095SP	7-66	LV847930SP	7-69
LUCD32 ( )	16-12, 18-22, 18-24	LV833098SP	7-68 – 7-69, 7-71	LV847940SP	7-72
LUCDX6 ( )	16-12, 18-22, 18-24	LV833099SP	7-69	LV847944SP	7-72
LUCM05BL	18-24	LV833118SP	7-68	LV848182SP	7-70
LUCM12BL	18-24	LV833170SP	7-69	LV848202SP	7-71
LUCM18BL	18-24	LV833171SP	7-69	LV848203SP	7-71
LUCM1XBL	18-24	LV833172SP	7-69, 7-72	LV848477SP	7-69
LUCM32BL	18-24	LV833176SP	7-71	LV848478SP	7-69
LUCMX6BL	18-24	LV833177SP	7-71	LV848534SP	7-69
LUFC00	18-24	LV833179SP	7-71	LV848535SP	7-72
LUFDA10	18-24	LV833185SP	7-71	LV848556SP	7-72
LUFDH11	18-24	LV833186SP	7-71	LV848557SP	7-72
LUFN02	16-12, 18-22	LV833187SP	7-71	LV848560SP	7-69
LUFN11	16-12, 18-22	LV833188SP	7-71	LV848601SP	7-72
LUFN20	16-12, 18-22	LV833209SP	7-69	LV848603SP	7-72
LUFN1 – LUFN9	26-29	LV833210SP	7-69	LV848604SP	7-72
LUFV2	18-24	LV833576SP	7-70	LV848608SP	7-69
LUFW10	18-24	LV833579SP	7-70	LV848609SP	7-69
LULC033	18-25	LV833593SP	7-66	LV848610SP	7-69

LV848614SP	7-69	LX1D8C7	18-53	LX4FK( )	18-56
LV848823SP	7-66	LX1D8D5	18-53	LX4FL( )	18-56
LV848824SP	7-66	LX1D8D7	18-53	LX4FX( )	18-56
LV848825SP	7-66	LX1D8E5	18-53	LX58TS	9-36
LV848826SP	7-66	LX1D8E6	18-53	LX62TS	9-36
LV848827SP	7-66	LX1D8E7	18-53	LX9FF( )	18-53
LV848891SP	7-70	LX1D8F5	18-53	LX9FG( )	18-53
LV848892SP	7-68	LX1D8F6	18-53	LX9FH( )	18-53
LV848906SP	7-70	LX1D8F7	18-53	LX9FJ( )	18-53, 18-56
LV848907SP	7-70	LX1D8FC5	18-53	LX9FK( )	18-53, 18-56
LV850002	7-65	LX1D8FC7	18-53	LX9FL( )	18-53
LV850003	7-65	LX1D8FE5	18-53	LXD1B7	18-52
LV850004	7-65	LX1D8FE7	18-53	LXD1C7	18-52
LV850005	7-65	LX1D8G6	18-53	LXD1CC7	18-52
LV850006	7-65	LX1D8G7	18-53	LXD1D7	18-52
LV850007	7-65	LX1D8L6	18-53	LXD1E7	18-52
LV850009	7-65	LX1D8L7	18-53	LXD1EE7	18-52
LV850011	7-65	LX1D8M5	18-53	LXD1F7	18-52
LV850012	7-65	LX1D8M6	18-53	LXD1FC7	18-52
LV850045	7-65	LX1D8M7	18-53	LXD1FE7	18-52
LV850054SP	7-66	LX1D8N5	18-53	LXD1G7	18-52
LV850056SP	7-68	LX1D8N7	18-53	LXD1J7	18-52
LV850061SP	7-68, 7-76	LX1D8P5	18-53	LXD1K7	18-52
LV850062	7-76	LX1D8P7	18-53	LXD1L7	18-52
LV850062SP	7-68	LX1D8Q5	18-53	LXD1LE7	18-52
LV850063SP	7-68, 7-76	LX1D8Q6	18-53	LXD1M7	18-52
LV850064SP	7-68, 7-76	LX1D8Q7	18-53	LXD1N7	18-52
LV850067SP	7-66	LX1D8R5	18-53	LXD1P7	18-52
LV851001SP	7-68, 7-75	LX1D8R6	18-53	LXD1Q7	18-52
LV851100SP	7-68, 7-75	LX1D8R7	18-53	LXD1R7	18-52
LV851120SP	7-68, 7-76	LX1D8S5	18-53	LXD1SC7	18-52
LV851200SP	7-68, 7-75	LX1D8S6	18-53	LXD1T7	18-52
LV851220SP	7-68, 7-76	LX1D8T6	18-53	LXD1U7	18-52
LV864917SP	7-69	LX1D8T7	18-53	LXD1V7	18-52
LV864922SP	7-69	LX1D8U5	18-53	LXD1W7	18-52
LX1D6B5	18-53	LX1D8U6	18-53	LXD1X7	18-52
LX1D6B6	18-53	LX1D8U7	18-53	LXD1Z7	18-52
LX1D6B7	18-53	LX1D8V5	18-53	LXD3B7	18-53
LX1D6C5	18-53	LX1D8V7	18-53	LXD3C7	18-53
LX1D6D5	18-53	LX1D8W6	18-53	LXD3D7	18-53
LX1D6D7	18-53	LX1D8W7	18-53	LXD3E7	18-53
LX1D6E5	18-53	LX1FH( )	18-53	LXD3F7	18-53
LX1D6E6	18-53	LX1FJ( )	18-53	LXD3FC7	18-53
LX1D6E7	18-53	LX1FK( )	18-53	LXD3FE7	18-53
LX1D6F5	18-53	LX1FL( )	18-53	LXD3G7	18-53
LX1D6F6	18-53	LX1FX( )	18-53	LXD3J5	18-53
LX1D6F7	18-53	LX40TS	9-36	LXD3K7	18-53
LX1D6G5	18-53	LX45TS	9-36	LXD3L7	18-53
LX1D6G6	18-53	LX4D7BD	18-55	LXD3LE7	18-53
LX1D6G7	18-53	LX4D7BW	18-55	LXD3M7	18-53
LX1D6L6	18-53	LX4D7CD	18-55	LXD3N7	18-53
LX1D6LE7	18-53	LX4D7CW	18-55	LXD3P7	18-53
LX1D6M5	18-53	LX4D7ED	18-55	LXD3Q7	18-53
LX1D6M6	18-53	LX4D7EW	18-55	LXD3R7	18-53
LX1D6M7	18-53	LX4D7FD	18-55	LXD3S7	18-53
LX1D6N5	18-53	LX4D7FW	18-55	LXD3SC7	18-53
LX1D6N7	18-53	LX4D7GD	18-55	LXD3T7	18-53
LX1D6P5	18-53	LX4D7JD	18-55	LXD3U7	18-53
LX1D6P7	18-53	LX4D7JW	18-55	LXD3V7	18-53
LX1D6Q5	18-53	LX4D7MD	18-55	LXD3W7	18-53
LX1D6Q6	18-53	LX4D7MW	18-55	LXD3X7	18-53
LX1D6Q7	18-53	LX4D7ND	18-55	LXD3Y7	18-53
LX1D6R5	18-53	LX4D7RD	18-55	LXD3YC7	18-53
LX1D6R6	18-53	LX4D7SD	18-55		
LX1D6R7	18-53	LX4D7SW	18-55		
LX1D6S5	18-53	LX4D7UD	18-55		
LX1D6S6	18-53	LX4D7XD	18-55		
LX1D6T6	18-53	LX4D8BD	18-55		
LX1D6U5	18-53	LX4D8ED	18-55		
LX1D6U6	18-53	LX4D8FD	18-55		
LX1D6U7	18-53	LX4D8GD	18-55		
LX1D6V5	18-53	LX4D8MD	18-55		
LX1D6V7	18-53	LX4D8ND	18-55		
LX1D6W5	18-53	LX4D8RD	18-55		
LX1D6W6	18-53	LX4D8SD	18-55		
LX1D6X6	18-53	LX4D8UD	18-55		
LX1D6Y5	18-53	LX4F8( )	18-53, 18-56		
LX1D8B5	18-53	LX4FF( )	18-56		
LX1D8B6	18-53	LX4FG( )	18-56		
LX1D8B7	18-53	LX4FH( )	18-56		
LX1D8C5	18-53	LX4FJ( )	18-56		
				<b>M</b>	
				M800AWK	7-83, 7-86
				M800DS	7-83, 7-86
				M800R	7-83, 7-86
				M800S	7-83, 7-86
				M800SS	7-83, 7-86
				M9A17400	7-28
				M9A26924	7-28
				M9A26927	7-28
				M9A26946	7-28
				M9A26947	7-28
				M9A26948	7-28
				M9A26960	7-28
				M9A26961	7-28
				M9A27107	7-28
				M9A27108	7-28

M9F21101 – M9F23463	7-24	MH32	9-11 – 9-12, 9-26 – 9-27	NC50NQVF	1-14
M9F42101 – M9F54163	7-23	MH32WVP	9-11 – 9-12, 9-26 – 9-27	NC50NQVS	1-14
M9PAF	7-28	MH38	9-11 – 9-12, 9-26 – 9-27	NC50V( )	9-11, 9-26
M9R12225 – M9R81263	7-25	MH38WVP	9-11 – 9-12, 9-26 – 9-27	NC50V( )JHR	9-11, 9-26
M9R81425	7-25 – 7-26	MH44	9-11 – 9-12, 9-26 – 9-27	NC56( )	9-12, 9-27
M9R81440 – M9R84491	7-25	MH44WVP	9-11 – 9-12, 9-26 – 9-27	NC56( )JHR	9-12, 9-27
M9U11106 – M9U31263	7-25	MH50	9-11 – 9-12, 9-26 – 9-27	NC56V( )	9-26
M9XCA137 – M9XUTC18	7-26	MH50 (box)	1-14	NC56V( )JHR	9-26
MA11MA12 – MA91MA18	6-3	MH50WVP	9-11 – 9-12, 9-26 – 9-27	NC59TS	9-37
MCC21MA12 – MCC81MA24	6-5	MH56	9-12, 9-26 – 9-27, 9-33	NC62( )	9-11 – 9-12, 9-27
MD3304X	8-8	MH56WVP	9-12, 9-26 – 9-27	NC62( )JHR	9-12, 9-26 – 9-27
MD3604X	8-8	MH62	9-11 – 9-12, 9-26 – 9-27	NC62NQVF	1-14
MDS30P	8-8	MH62 (Box)	1-14	NC62NQVS	1-14
MDSAN11	8-8, 8-25	MH62WP	9-11 – 9-12, 9-26 – 9-27	NC62V( )	9-11 – 9-12, 9-27
MDSAN20	8-8, 8-25	MH68	9-11, 9-27, 9-33	NC62V( )JHR	9-11 – 9-12, 9-27
METSECAB1	4-12	MH68WVP	9-11, 9-27	NC65TS	9-37
METSECAB10	4-10, 4-12	MH74	9-12, 9-26 – 9-27	NC68V( )	9-11 – 9-12, 9-27
METSECAB3	4-12	MH74WVP	9-12, 9-26 – 9-27	NC68V( )JHR	9-11 – 9-12, 9-27
METSECT80200	4-22	MH80	9-12, 9-26, 9-33	NC71TS	9-37
METSECT80400	4-22	MH80WVP	9-11 – 9-12	NC74( )	9-27
METSECT80600	4-22	MH86	9-26 – 9-27	NC74( )JHR	9-27
METSEEM3502	4-15	MH86WVP	9-26 – 9-27	NC74V( )	9-12, 9-26
METSEEM3502A	4-15	MHT2DH20	9-34	NC74V( )JHR	9-12, 9-26
METSEEM3550	4-15	MICROTUSEAL	2-21, 7-62	NC80V( )	9-12
METSEEM3550A	4-15	MJA26300( ) – MJA36800	9-57	NC80V( )JHR	9-12
METSEEM3555	4-15	MJL26300 – MJL36800	7-38	NC85TS	9-37
METSEEM3555A	4-15	MM125MB	2-7	NC86V( )	9-26 – 9-27
METSEEM3560	4-15	MM200MB	2-7, 2-21	NC86V( )JHR	9-26 – 9-27
METSEEM3560A	4-15	MMBLC	2-21	NCTWIRING	7-62
METSEEM3561	4-15	MMHB	1-37	NF1000G3	9-40
METSEEM3561A	4-15	MMHB	2-7, 2-21	NF102OE	9-34
METSEEM403316	4-22	MMLK250 – MMLK600	2-7, 2-21	NF102S	9-34
METSEEM403336	4-22	MMLRK	1-37, 2-21	NF120PSG3	9-40
METSEEM408016	4-22	MMSAMK	2-21	NF120PSG3L	9-40
METSEEM408036	4-22	MMSK2	2-7	NF125FTL	9-33
METSEEM480516	4-22	MMSK4	2-7	NF125SFL	9-33
METSEEM483316	4-22	MP12X11PEDEXT	2-7	NF12RDE	9-34
METSEEM488016	4-22	MP12X8PEDEXT	2-7	NF12SBLG3	9-40
METSEEM4904A	4-25	MP22125 – MP86200	2-6	NF12SBRG3	9-40
METSEEM4904E	4-25	MP35X11PED	2-7	NF18RDE	9-34
METSEEM4908A	4-25	MP43X11PED	2-7	NF18SBLG3	9-40
METSEEM4908E	4-25	MP43X8PED	2-7	NF18SBRG3	9-40
METSEEM4914A	4-25	MPH22125 – MPH86200	2-6	NF2000G3	9-40
METSEEM4914E	4-25	MPL32225 – MPL64225	2-6	NF204OE	9-34
METSEEM4928A	4-25	MPR22125 – MPR86200	2-6	NF204S	9-34
METSEEM4928E	4-25	MPPRAF	7-52	NF21SBLG3	9-40
METSEION7400	4-10	MPSF12 – MPSF16	2-7	NF21SBRG3	9-40
METSEION7403	4-10	MPSF23 – MPSF26	2-7	NF240PSG3	9-40
METSEION92030	4-8	MPX81542	9-36 – 9-37	NF240PSG3L	9-40
METSEION92040	4-8	MPZ10S40F – MPZ15S40FSS	14-10	NF250FTL	9-33
METSEPM5110	4-14	MPZ15T2F – MPZ22T2FSS	14-10	NF250SFBH/NF250SFBJ	9-33
METSEPM5330	4-14	MPZ25S40F – MPZ25S40FSS	14-10	NF250SFL	9-33
METSEPM5340	4-14	MPZ30T2F – MPZ30T2FSS	14-10	NF277PSG3	9-40
METSEPM5560	4-14	MPZ3S40F – MPZ7S40FSS	14-10	NF277PSG3L	9-40
METSEPM5563	4-14	MPZB10S40F – MPZB15S40FSS	14-10	NF2HG3	9-40
METSEPM5563RD	4-14	MPZB15T2F – MPZB22T2FSS	14-10	NF3000G3	9-40
METSEPM5RD	4-14	MPZB25S40F – MPZB25S40FSS	14-10	NF400FTL	9-33
METSEPM8000SK	4-12	MPZB30T2F – MPZB30T2FSS	14-10	NF400SFL	9-33
METSEPM8210	4-12	MPZB3S40F – MPZB3S40FSS	14-10	NF418L1	9-26 – 9-27
METSEPM8213	4-12	MPZB5S40F – MPZB5S40FSS	14-10	NF418L1C	9-26 – 9-27
METSEPM8214	4-12	MPZB7S40F – MPZB7S40FSS	14-10	NF430L1	9-26 – 9-27
METSEPM8240	4-12	MTX836	9-36	NF430L1C	9-26 – 9-27
METSEPM8243	4-12	MTX848	9-36	NF430L2	9-26 – 9-27
METSEPM8244	4-12	MTX856	9-36	NF430L2C	9-26 – 9-27
METSEPM89M0024	4-8, 4-10, 4-12	MTX866	9-36	NF430L4	9-26 – 9-27
METSEPM89M2600	4-8, 4-10, 4-12			NF430L4C	9-26 – 9-27
METSEPM89RD96	4-8, 4-10, 4-12			NF430L6C	9-26
METSEPM8HWK	4-12	<b>N</b>		NF442L2	9-26 – 9-27
METSEPM8RDHWK	4-12	N150MH	9-27	NF442L2C	9-26 – 9-27
METSEPMMAK	4-12	N250MJ	9-27	NF442L4	9-26 – 9-27
METSERD192	4-8	N400M	9-27	NF442L4C	9-26 – 9-27
MG26983	7-28	NC26( )	9-11 – 9-12, 9-26 – 9-27	NF442L6C	9-26
MG26984	7-28	NC26( )JHR	9-27, 9-11 – 9-12, 9-26	NF454L2	9-26 – 9-27
MG26985	7-28	NC32( )	9-11 – 9-12, 9-26 – 9-27	NF454L2C	9-26 – 9-27
MG26989	7-28	NC32( )JHR	9-11 – 9-12, 9-26, 9-27	NF466L2	9-26 – 9-27
MGA26300( ) – MGA36800	9-57	NC38( )	9-11 – 9-12, 9-26, 9-27	NF466L2C	9-26 – 9-27
MGL26300 – MGL36800	7-38	NC38( )JHR	9-11 – 9-12, 9-26, 9-27	NF466L4	9-26 – 9-27
MGN26380	7-28	NC44( )	9-11 – 9-12, 9-26, 9-27	NF466L4C	9-26 – 9-27
MGN26381	7-28	NC44( )JHR	9-11 – 9-12, 9-26, 9-27	NF466L6C	9-26
MH26	9-11 – 9-12, 9-26 – 9-27	NC50( )	9-11 – 9-12, 9-26, 9-27	NF484L4	9-26
MH26WVP	9-11 – 9-12, 9-26 – 9-27	NC50( )JHR	9-11 – 9-12, 9-26, 9-27	NF484L4C	9-26

NF484L6C.....	9-26	NQ442L6C.....	9-11	NSY2SP205.....	28-4 – 28-5
NF500G3.....	9-40	NQ454L2.....	9-11 – 9-12	NSY2SP206.....	28-4 – 28-5
NF600SFBH.....	9-33	NQ454L2C.....	9-11 – 9-12	NSY2SP208.....	28-4 – 28-5
NF600SFBJ.....	9-33	NQ472L2.....	9-11 – 9-12	NSY2SP226.....	28-5
NF6RDE.....	9-34	NQ472L2C.....	9-11 – 9-12	NSY2SP228.....	28-5
NF8430L1C.....	9-37	NQ472L4.....	9-11 – 9-12	NSYAEFFPPTD.....	26-26
NF8430M1C.....	9-37	NQ472L4C.....	9-11 – 9-12	NSYCRN106250.....	28-7
NF8430M1HDC.....	9-37	NQ484L2.....	9-11 – 9-12	NSYCRN106300.....	28-7
NF8442L2C.....	9-37	NQ484L2C.....	9-11 – 9-12	NSYCRN108250.....	28-7
NF8442M2JDC.....	9-37	NQ484L4C.....	9-11 – 9-12	NSYCRN108300.....	28-7
NFADAPTERG3.....	9-40	NQ484L6C.....	9-11	NSYCRN22150.....	28-7
NFALV1.....	9-33	NQ6RDE.....	9-21	NSYCRN23150.....	28-7
NFALV2.....	9-33	NQ72L2.....	9-11 – 9-12	NSYCRN252150.....	28-7
NFALV4.....	9-33	NQ72L2C.....	9-11 – 9-12	NSYCRN325150.....	28-7
NFALV6.....	9-33	NQ820B1C.....	9-36	NSYCRN325200.....	28-7
NFASBKG3.....	9-40	NQ830L2C.....	9-36	NSYCRN33150.....	28-7
NFCUM1.....	9-33	NQ8430B1C.....	9-36	NSYCRN33200.....	28-7
NFCUM2.....	9-33	NQ8430L1C.....	9-36	NSYCRN34200.....	28-7
NFCUM4.....	9-33	NQ8442B2C.....	9-36	NSYCRN345150.....	28-7
NFCUM6.....	9-33	NQ8442L2C.....	9-36	NSYCRN43150.....	28-7
NFCUV1.....	9-33	NQ84L2.....	9-11 – 9-12	NSYCRN43200.....	28-7
NFCUV2.....	9-33	NQ84L2C.....	9-11 – 9-12	NSYCRN44200.....	28-7
NFCUV4.....	9-33	NQ84L4C.....	9-11 – 9-12	NSYCRN46250.....	28-7
NFCUV6.....	9-33	NQ84L6C.....	9-11	NSYCRN46300.....	28-7
NFFP15.....	9-34	NQALV1.....	9-20	NSYCRN54150.....	28-7
NFFPCG3.....	9-40	NQALV2.....	9-20	NSYCRN54200.....	28-7
NFICRT418C1C – NFICRT442L6C.....	9-44	NQALV4.....	9-20	NSYCRN54250.....	28-7
NFN1CU.....	9-33	NQALV6.....	9-20	NSYCRN55250.....	28-7
NFN2CU.....	9-33	NQB532.....	9-13	NSYCRN64150.....	28-7
NFN6CU.....	9-33	NQB538.....	9-13	NSYCRN64200.....	28-7
NFNL1.....	9-33	NQB544.....	9-13	NSYCRN64250.....	28-7
NFNL2.....	9-33	NQB550.....	9-13	NSYCRN65150.....	28-7
NFNL4.....	9-33	NQC20FWG.....	1-16	NSYCRN65200.....	28-7
NFSELG3.....	9-40	NQC30FWG.....	1-16	NSYCRN65250.....	28-7
NFSN06.....	9-40	NQC32( ).....	9-13	NSYCRN66200.....	28-7
NFSN10.....	9-40	NQC38( ).....	9-13	NSYCRN66250.....	28-7
NFSN25.....	9-40	NQC44( ).....	9-13	NSYCRN66300.....	28-7
NFSN50.....	9-40	NQC50( ).....	9-13	NSYCRN68300.....	28-7
NJPAF.....	7-52	NQCUM1.....	9-20	NSYCRN75200.....	28-7
NQ102OE.....	9-21	NQCUM2.....	9-20	NSYCRN75250.....	28-7
NQ102S.....	9-21	NQCUM4.....	9-20	NSYCRN86200.....	28-7
NQ12RDE.....	9-21	NQCUM6.....	9-20	NSYCRN86250.....	28-7
NQ18L1.....	9-11 – 9-12	NQCUV1.....	9-20	NSYCRN86300.....	28-7
NQ18L1C.....	9-11 – 9-12	NQCUV2.....	9-20	NSYCRN88200.....	28-7
NQ18L1C14.....	9-13	NQCUV4.....	9-20	NSYCRN88300.....	28-7
NQ18RDE.....	9-21	NQCUV6.....	9-20	NSYCRNG1010300D.....	28-7
NQ204OE.....	9-21	NQFP15.....	9-13, 9-21	NSYCRNG1012300D.....	28-7
NQ204S.....	9-21	NQFTL2H.....	9-20	NSYCRNG1012400D.....	28-7
NQ24RDE.....	9-21	NQFTL2L.....	9-20	NSYCRNG106400.....	28-7
NQ30L1.....	9-11 – 9-12	NQFTL4H.....	9-20	NSYCRNG108400.....	28-7
NQ30L1C.....	9-11 – 9-12	NQFTL4L.....	9-20	NSYCRNG1210300D.....	28-7
NQ30L1C14.....	9-13	NQICRT418C1C – NQICRT442L6C.....	9-44	NSYCRNG1210400D.....	28-7
NQ30L2.....	9-11 – 9-12	NQMB2HJ.....	9-12	NSYCRNG1212300D.....	28-7
NQ30L2C.....	9-11 – 9-12	NQMB2HJ14.....	9-13	NSYCRNG1212400D.....	28-7
NQ30L2C14.....	9-13	NQMB2Q.....	9-12	NSYCRNG126300.....	28-7
NQ30L4.....	9-11 – 9-12	NQMB2Q14.....	9-13	NSYCRNG126400.....	28-7
NQ30L4C.....	9-11 – 9-12	NQMB4LA.....	9-12	NSYCRNG128300.....	28-7
NQ30L6C.....	9-11	NQN1CU.....	9-20	NSYCRNG128400.....	28-7
NQ418L1.....	9-11 – 9-12	NQN2CU.....	9-20	NSYCRNG1410300D.....	28-7
NQ418L1C.....	9-11 – 9-12	NQN6CU.....	9-20	NSYCRNG810300D.....	28-7
NQ418L1C14.....	9-13	NQNL1.....	9-20	NSYCRNG812300D.....	28-7
NQ42L2.....	9-11 – 9-12	NQNL2.....	9-20	NSYCRNG86400.....	28-7
NQ42L2C.....	9-11 – 9-12	NQNL2ACCY.....	9-20	NSYEBAD11611 – NSYEBAD27622.....	24-26
NQ42L2C14.....	9-13	NQNL4.....	9-20	NSYEBAP12611 – NSYEBAP27628.....	24-26
NQ42L4.....	9-11 – 9-12	NQSFB2HJ.....	9-20	NSYEBAD12611 – NSYEBAD25622.....	24-26
NQ42L4C.....	9-11 – 9-12	NQSFB2Q.....	9-20	NSYEBAD12614 – NSYEBAD27628.....	24-26
NQ42L6C.....	9-11	NQSFB4HJ.....	9-20	NSYEBP2 – NSYEBP500.....	24-26
NQ430L1.....	9-11 – 9-12	NQSFB4Q.....	9-20	NSYEC1041.....	28-4 – 28-5
NQ430L1C.....	9-11 – 9-12	NQSFL1.....	9-20	NSYEC1051.....	28-4 – 28-5
NQ430L1C14.....	9-13	NQSFL2.....	9-20	NSYEC1061.....	28-4 – 28-5
NQ430L2.....	9-11 – 9-12	NQSFL4.....	9-20	NSYEC1081.....	28-5
NQ430L2C.....	9-11 – 9-12	NSY2SP124.....	28-4	NSYEC1241.....	28-4 – 28-5
NQ430L2C14.....	9-13	NSY2SP126.....	28-4	NSYEC1251.....	28-4 – 28-5
NQ430L4.....	9-11 – 9-12	NSY2SP144.....	28-4	NSYEC1261.....	28-4 – 28-5
NQ430L4C.....	9-11 – 9-12	NSY2SP166.....	28-4	NSYEC1281.....	28-5
NQ430L6C.....	9-11	NSY2SP168.....	28-4	NSYEC1641.....	28-5
NQ442L2.....	9-11 – 9-12	NSY2SP184.....	28-4	NSYEC1651.....	28-5
NQ442L2C.....	9-11 – 9-12	NSY2SP185.....	28-4	NSYEC1661.....	28-5
NQ442L2C14.....	9-13	NSY2SP186.....	28-4	NSYEC351.....	28-4
NQ442L4.....	9-11 – 9-12	NSY2SP188.....	28-4	NSYEC361.....	28-4
NQ442L4C.....	9-11 – 9-12	NSY2SP204.....	28-4 – 28-5	NSYEC441.....	28-4



NSYEC451.....	28-4	NSYPLA12104T.....	28-8	NSYPLAZ1553.....	28-8
NSYEC461.....	28-4 – 28-5	NSYPLA12123.....	28-8	NSYPLAZ1554.....	28-8
NSYEC481.....	28-4	NSYPLA12123T.....	28-8	NSYPLAZ1573.....	28-8
NSYEC641.....	28-4	NSYPLA12124.....	28-8	NSYPLAZ1574.....	28-8
NSYEC651.....	28-4	NSYPLA12124T.....	28-8	NSYPLAZ5103.....	28-8
NSYEC661.....	28-4 – 28-5	NSYPLA1253.....	28-8	NSYPLAZ5104.....	28-8
NSYEC681.....	28-4 – 28-5	NSYPLA1253T.....	28-8	NSYPLAZ5123.....	28-8
NSYEC841.....	28-4	NSYPLA1254.....	28-8	NSYPLAZ5124.....	28-8
NSYEC851.....	28-4	NSYPLA1254T.....	28-8	NSYPLAZ553.....	28-8
NSYEC861.....	28-4 – 28-5	NSYPLA1273.....	28-8	NSYPLAZ554.....	28-8
NSYEC881.....	28-4 – 28-5	NSYPLA1273T.....	28-8	NSYPLAZ573.....	28-8
NSYMM1010.....	28-7	NSYPLA1274.....	28-8	NSYPLAZ574.....	28-8
NSYMM106.....	28-7	NSYPLA1274T.....	28-8	NSYPLAZ7103.....	28-8
NSYMM108.....	28-7 – 28-8	NSYPLA15103.....	28-8	NSYPLAZ7104.....	28-8
NSYMM1210.....	28-7	NSYPLA15103T.....	28-8	NSYPLAZ7123.....	28-8
NSYMM1212.....	28-7	NSYPLA15104.....	28-8	NSYPLAZ7124.....	28-8
NSYMM126.....	28-7	NSYPLA15104T.....	28-8	NSYPLAZ753.....	28-8
NSYMM128.....	28-7	NSYPLA15123.....	28-8	NSYPLAZ754.....	28-8
NSYMM1410.....	28-7	NSYPLA15123T.....	28-8	NSYPLAZ773.....	28-8
NSYMM22.....	28-7	NSYPLA15124.....	28-8	NSYPLAZ774.....	28-8
NSYMM2520.....	28-7	NSYPLA15124T.....	28-8	NSYPLM108.....	28-8
NSYMM3025.....	28-7 – 28-8	NSYPLA1553.....	28-8	NSYPLM108T.....	28-8
NSYMM3045.....	28-7	NSYPLA1553T.....	28-8	NSYPLM3025.....	28-8
NSYMM32.....	28-7 – 28-8	NSYPLA1554.....	28-8	NSYPLM3025T.....	28-8
NSYMM33.....	28-7	NSYPLA1554T.....	28-8	NSYPLM32.....	28-8
NSYMM43.....	28-7 – 28-8	NSYPLA1573.....	28-8	NSYPLM32T.....	28-8
NSYMM44.....	28-7	NSYPLA1573T.....	28-8	NSYPLM43.....	28-8
NSYMM46.....	28-7	NSYPLA1574.....	28-8	NSYPLM43T.....	28-8
NSYMM54.....	28-7 – 28-8	NSYPLA1574T.....	28-8	NSYPLM43TV.....	28-8
NSYMM55.....	28-7	NSYPLA5103.....	28-8	NSYPLM43V.....	28-8
NSYMM64.....	28-7 – 28-8	NSYPLA5103T.....	28-8	NSYPLM54.....	28-8
NSYMM65.....	28-7	NSYPLA5104.....	28-8	NSYPLM54T.....	28-8
NSYMM66.....	28-7	NSYPLA5104T.....	28-8	NSYPLM54TV.....	28-8
NSYMM75.....	28-7 – 28-8	NSYPLA5123.....	28-8	NSYPLM54V.....	28-8
NSYMM86.....	28-7 – 28-8	NSYPLA5123T.....	28-8	NSYPLM64.....	28-8
NSYMM88.....	28-7	NSYPLA5124.....	28-8	NSYPLM64T.....	28-8
NSYMP1210.....	28-4	NSYPLA5124T.....	28-8	NSYPLM64TV.....	28-8
NSYMP1212.....	28-4	NSYPLA553.....	28-8	NSYPLM64V.....	28-8
NSYMP126.....	28-4	NSYPLA553T.....	28-8	NSYPLM75.....	28-8
NSYMP128.....	28-4	NSYPLA554.....	28-8	NSYPLM75T.....	28-8
NSYMP1410.....	28-4	NSYPLA554T.....	28-8	NSYPLM75TV.....	28-8
NSYMP1412.....	28-4	NSYPLA573.....	28-8	NSYPLM75V.....	28-8
NSYMP146.....	28-4	NSYPLA573T.....	28-8	NSYPLM86.....	28-8
NSYMP148.....	28-4	NSYPLA574.....	28-8	NSYPLM86T.....	28-8
NSYMP1610.....	28-4	NSYPLA574T.....	28-8	NSYPLM86TV.....	28-8
NSYMP1612.....	28-4	NSYPLA7103.....	28-8	NSYPLM86V.....	28-8
NSYMP166.....	28-4	NSYPLA7103T.....	28-8	NSYPLMEX108.....	28-8
NSYMP168.....	28-4	NSYPLA7104.....	28-8	NSYPLMEX3025.....	28-8
NSYMP1810.....	28-4	NSYPLA7104T.....	28-8	NSYPLMEX43.....	28-8
NSYMP1812.....	28-4	NSYPLA7123.....	28-8	NSYPLMEX54.....	28-8
NSYMP1816.....	28-4	NSYPLA7123T.....	28-8	NSYPLMEX64.....	28-8
NSYMP186.....	28-4	NSYPLA7124.....	28-8	NSYPLMEX75.....	28-8
NSYMP188.....	28-4	NSYPLA7124T.....	28-8	NSYPLMEX86.....	28-8
NSYMP2010.....	28-5	NSYPLA753.....	28-8	NSYPTDS1 – NSYPTDS5.....	26-26
NSYMP2012.....	28-5	NSYPLA753T.....	28-8	NSYS3DC101030.....	28-7
NSYMP2016.....	28-5	NSYPLA754.....	28-8	NSYS3DC10625.....	28-7
NSYMP206.....	28-4	NSYPLA754T.....	28-8	NSYS3DC10825.....	28-7
NSYMP208.....	28-4 – 28-5	NSYPLA773.....	28-8	NSYS3DC10830.....	28-7
NSYMP2210.....	28-5	NSYPLA773T.....	28-8	NSYS3DC10840.....	28-7
NSYMP2212.....	28-5	NSYPLA774.....	28-8	NSYS3DC121030.....	28-7
NSYMP226.....	28-5	NSYPLA774T.....	28-8	NSYS3DC12830.....	28-7
NSYMP228.....	28-5	NSYPLAZ10103.....	28-8	NSYS3DC12840.....	28-7
NSYPLA10103.....	28-8	NSYPLAZ10104.....	28-8	NSYS3DC3215.....	28-7
NSYPLA10103T.....	28-8	NSYPLAZ10123.....	28-8	NSYS3DC3315.....	28-7
NSYPLA10104.....	28-8	NSYPLAZ10124.....	28-8	NSYS3DC3320.....	28-7
NSYPLA10104T.....	28-8	NSYPLAZ1053.....	28-8	NSYS3DC4315.....	28-7
NSYPLA10123.....	28-8	NSYPLAZ1054.....	28-8	NSYS3DC4320.....	28-7
NSYPLA10123T.....	28-8	NSYPLAZ1073.....	28-8	NSYS3DC4420.....	28-7
NSYPLA10124.....	28-8	NSYPLAZ1074.....	28-8	NSYS3DC5420.....	28-7
NSYPLA10124T.....	28-8	NSYPLAZ12103.....	28-8	NSYS3DC5425.....	28-7
NSYPLA1053.....	28-8	NSYPLAZ12104.....	28-8	NSYS3DC5520.....	28-7
NSYPLA1053T.....	28-8	NSYPLAZ12123.....	28-8	NSYS3DC5525.....	28-7
NSYPLA1054.....	28-8	NSYPLAZ12124.....	28-8	NSYS3DC6420.....	28-7
NSYPLA1054T.....	28-8	NSYPLAZ1253.....	28-8	NSYS3DC6425.....	28-7
NSYPLA1073.....	28-8	NSYPLAZ1254.....	28-8	NSYS3DC6620.....	28-7
NSYPLA1073T.....	28-8	NSYPLAZ1273.....	28-8	NSYS3DC6625.....	28-7
NSYPLA1074.....	28-8	NSYPLAZ1274.....	28-8	NSYS3DC6630.....	28-7
NSYPLA1074T.....	28-8	NSYPLAZ15103.....	28-8	NSYS3DC7525.....	28-7
NSYPLA12103.....	28-8	NSYPLAZ15104.....	28-8	NSYS3DC8620.....	28-7
NSYPLA12103T.....	28-8	NSYPLAZ15123.....	28-8	NSYS3DC8625.....	28-7
NSYPLA12104.....	28-8	NSYPLAZ15124.....	28-8	NSYS3DC8630.....	28-7

NSYS3DC8640	28-7	NSYSF22460	28-5	NSYTRACR24	24-3 – 24-5, 24-13 – 24-14
NSYS3DC8825	28-7	NSYSF22660	28-5	NSYTRACR24BL	24-3, 24-13
NSYS3DC8830	28-7	NSYSF22680	28-5	NSYTRACR42	24-3 – 24-4, 24-13 – 24-15
NSYS3X101030	28-7	NSYSF22860	28-5	NSYTRACR43 – NSYTRACR162	24-3 – 24-4
NSYS3X10830	28-7	NSYSF22880	28-5	NSYTRACR63	24-3
NSYS3X121030	28-7	NSYSM1210302D	28-4	NSYTRACRE24	24-5, 24-15
NSYS3X12830	28-7	NSYSM1212402D	28-4	NSYTRACRE26 – NSYTRACRE44	24-5
NSYS3X302515	28-7	NSYSM12830	28-4	NSYTRACRM22 – NSYTRACRMF22	24-6
NSYS3X3215	28-7	NSYSM1410402D	28-4	NSYTRACRR102	24-3
NSYS3X3315	28-7	NSYSM1412402D	28-4	NSYTRACT22 – NSYTRV62TTPE	24-10
NSYS3X4315	28-7	NSYSM14630	28-4	NSYTRASF520 – NSYTRASF520M	24-5, 24-10, 24-15
NSYS3X4320	28-7	NSYSM14640	28-4	NSYTRASV1 – NSYTRASV2	24-5, 24-10, 24-15
NSYS3X4420	28-7	NSYSM14830	28-4	NSYTRH12 – NSYTRH22	24-12
NSYS3X4620	28-7	NSYSM14840	28-4	NSYTRP22 – NSYTRP44	24-13
NSYS3X5420	28-7	NSYSM1610302D	28-4	NSYTRP22AR – NSYTRP44BL	24-13
NSYS3X6420	28-7	NSYSM1610402D	28-4	NSYTRP22PE – NSYTRP44PE	24-14
NSYS3X6625	28-7	NSYSM1612302D	28-4	NSYTRP22SC – NSYTRP42TB	24-15
NSYS3X7525	28-7	NSYSM1612402D	28-4	NSYTRR22 – NSYTRR162BL	24-3
NSYS3X8625	28-7	NSYSM16630	28-4	NSYTRR22M – NSYTRR22MPE	24-6
NSYS3X8830	28-7	NSYSM16640	28-4	NSYTRR22PE – NSYTRR162PE	24-4
NSYS3X8830 – NSYS3X8830	24-18	NSYSM16830	28-4	NSYTRR22SC – NSYTRR44DPE	24-5
NSYS3X12640	28-4	NSYSM16840	28-4	NSYTRR23PE – NSYTRR62PE	24-4
NSYS3X12660	28-4	NSYSM181040	28-4	NSYTRR24M – NSYTRR24MP	24-6
NSYS3X12840	28-4	NSYSM1810402D	28-4	NSYTRV102PE – NSYTRV502PE	24-8
NSYS3X12860	28-4	NSYSM1810502D	28-4	NSYTRV22M – NSYTRV42MPE	24-11
NSYS3X14640	28-4	NSYSM1812402D	28-4	NSYTRV24D – NSYTRV952BC	24-9
NSYS3X14840	28-4	NSYSM1812502D	28-4	NSYTRV42 – NSYTRV502BL	24-7
NSYS3X16660	28-4	NSYSM1816402D	28-4	NTMPRRT	7-74
NSYS3X16680	28-4	NSYSM1816502D	28-4	NTX836	9-37
NSYS3X16860	28-4	NSYSM18630	28-4	NTX848	9-37
NSYS3X16880	28-4	NSYSM18640	28-4	NTX856	9-37
NSYS3X181040	28-4	NSYSM18650	28-4	NTX866	9-37
NSYS3X1810402D	28-4	NSYSM18830	28-4	NWCELLKEY	7-72
NSYS3X181050	28-4	NSYSM18840	28-4	NWMPRRT	7-74
NSYS3X181060	28-4	NSYSM18850	28-4	NWNTMPRRT	7-74
NSYS3X1810602D	28-4	NSYSM18860	28-4		
NSYS3X1812402D	28-4	NSYSM2010402D	28-5		
NSYS3X1812502D	28-4	NSYSM2010502D	28-5		
NSYS3X1812602D	28-4	NSYSM2012402D	28-5		
NSYS3X18440	28-4	NSYSM2012502D	28-5		
NSYS3X18450	28-4	NSYSM2012602D	28-5		
NSYS3X18460	28-4	NSYSM2016402D	28-5		
NSYS3X18640	28-4	NSYSM2016502D	28-5		
NSYS3X18650	28-4	NSYSM2016602D	28-5		
NSYS3X18660	28-4	NSYSM20630	28-4		
NSYS3X18840	28-4	NSYSM20640	28-4		
NSYS3X18850	28-4	NSYSM20650	28-4		
NSYS3X18860	28-4	NSYSM20830	28-4		
NSYS3X188602D	28-4	NSYSM20840	28-4		
NSYS3X201040	28-5	NSYSM20850	28-4		
NSYS3X2010402D	28-5	NSYSM20860	28-4		
NSYS3X201050	28-5	NSYSPPF10100	28-4 – 28-5		
NSYS3X2010502D	28-5	NSYSPPF12100	28-4 – 28-5		
NSYS3X201060	28-5	NSYSPPF16100	28-4 – 28-5		
NSYS3X2010602D	28-5	NSYSPPF3100	28-4		
NSYS3X201080	28-5	NSYSPPF4100	28-4 – 28-5		
NSYS3X2012402D	28-5	NSYSPPF6100	28-4 – 28-5		
NSYS3X2012502D	28-5	NSYSPPF8100	28-4 – 28-5		
NSYS3X2012602D	28-5	NSYSPPS3100	28-4		
NSYS3X2012802D	28-5	NSYSPPS4100	28-4 – 28-5		
NSYS3X2016502D	28-5	NSYSPPS5100	28-4 – 28-5		
NSYS3X2016602D	28-5	NSYSPPS6100	28-4 – 28-5		
NSYS3X20350	28-4	NSYSPPS8100	28-4 – 28-5		
NSYS3X20360	28-4	NSYTACR23 – NSYTACR24	24-5		
NSYS3X20440	28-4	NSYTAA15 – NSYTADR155	24-18		
NSYS3X20450	28-4	NSYTRAB1010 – NSYTRAB890	24-16		
NSYS3X20460	28-4	NSYTRABF510 – NSYTRABF650	24-16		
NSYS3X20480	28-4	NSYTRABFPV5 – NSYTRABFPV8	24-17		
NSYS3X20640	28-4	NSYTRAC22 – NSYTRAC162	24-7 – 24-8		
NSYS3X206402D	28-5	NSYTRAC22BL	24-7		
NSYS3X20650	28-4	NSYTRAC23 – NSYTRAC26	24-9		
NSYS3X20660	28-4	NSYTRACE24	24-9 – 24-10		
NSYS3X20680	28-4	NSYTRACH12 – NSYTRACH22	24-12		
NSYS3X20840	28-4	NSYTRACM22	24-11		
NSYS3X20850	28-4	NSYTRACP43	24-13 – 24-14		
NSYS3X20860	28-4	NSYTRACP44	24-13 – 24-14		
NSYS3X208602D	28-5	NSYTRACPK22 – NSYTRACPK24	24-15		
NSYS3X20880	28-5	NSYTRACR22 – NSYTRACR22BL	24-3 – 24-4, 24-13 – 24-14		
NSYS3X221060	28-5	NSYTRACR23	24-3, 24-13		
NSYS3X2212602D	28-5	NSYTRACR23	24-3 – 24-5, 24-13 – 24-14		
NSYS3X2212802D	28-5	NSYTRACR23BL	24-3, 24-13		
				<b>O</b>	
				OCK400	1-37
				OHBL	1-37
				OHBS	1-37
				<b>P</b>	
				P ( )A36025(C)U31A	9-58
				P ( )A36025(C)U33A	9-58
				P ( )A36025(C)U41A	9-58
				P ( )A36025(C)U43A	9-58
				P ( )A36025(C)U44A	9-58
				P ( )A36025(C)U63AE1	9-58
				P ( )A36025(C)U64AE1	9-58
				P ( )A36025(C)U73AE1	9-58
				P ( )A36025(C)U74AE1	9-59
				P ( )A36040(C)U31A	9-58
				P ( )A36040(C)U33A	9-58
				P ( )A36040(C)U41A	9-58
				P ( )A36040(C)U43A	9-58
				P ( )A36040(C)U44A	9-58
				P ( )A36040(C)U63AE1	9-58
				P ( )A36040(C)U64AE1	9-58
				P ( )A36040(C)U73AE1	9-58
				P ( )A36040(C)U74AE1	9-59
				P ( )A36060	9-58
				P ( )A36060(C)U31A	9-58
				P ( )A36060(C)U33A	9-58
				P ( )A36060(C)U41A	9-58
				P ( )A36060(C)U43A	9-58
				P ( )A36060(C)U44A	9-58
				P ( )A36060(C)U63AE1	9-58
				P ( )A36060(C)U64AE1	9-58
				P ( )A36060(C)U73AE1	9-58
				P ( )A36060(C)U74AE1	9-59
				P ( )A36080	9-58
				P ( )A36080(C)U31A	9-58
				P ( )A36080(C)U33A	9-58
				P ( )A36080(C)U41A	9-58
				P ( )A36080(C)U43A	9-58
				P ( )A36080(C)U44A	9-58
				P ( )A36080(C)U63AE1	9-58
				P ( )A36080(C)U64AE1	9-58
				P ( )A36080(C)U73AE1	9-58

P (JA36080(C)U74AE1.....	9-59	PBLD36400GNU31X – PBLD36600GU53X .....	12-14	PCSPCTFCL120056 .....	4-43
P (JA36100.....	9-58	PBLG36250GNU31X – PBLG36600GU53X .....	12-14	PCSPCTFCL12005R.....	4-44
P (JA36100U31A.....	9-58	PBLJ36250GNU31X – PBLJ36600GU53X .....	12-14	PCSPCTFCL150016.....	4-43
P (JA36100U33A.....	9-58	PBLL36250GNU31X – PBLL36600GU53X .....	12-14	PCSPCTFCL15001R.....	4-44
P (JA36100U41A.....	9-58	PBLR36250GNU31X – PBLR36600GU53X .....	12-14	PCSPCTFCL150054.....	4-43
P (JA36100U43A.....	9-58	BPEDU4A100COOL2120M( ) .....		PCSPCTFCL150056.....	4-43
P (JA36100U44A.....	9-58	BPEDU4A100COOS5460M( ) .....	12-5	PCSPCTFCL15005R.....	4-44
P (JA36100U63AE1.....	9-58	BPEDU4A100FOOL2120M( ) .....		PCSPCTFCL16001R.....	4-44
P (JA36100U64AE1.....	9-58	BPEDU4A100FOOL630M( ) .....	12-5	PCSPCTFCL160054.....	4-43
P (JA36100U73AE1.....	9-58	BPEDU5A100COOL2120M( ) .....		PCSPCTFCL16005R.....	4-44
P (JA36100U74AE1.....	9-59	BPEDU5A100COOL630M( ) .....	12-5	PCSPCTFCL200018.....	4-43
P (JA36120.....	9-58	BPEDU5A100COOS3420M( ) .....		PCSPCTFCL200056.....	4-43
P (JA36120U31A.....	9-58	BPEDU5A100COOS5460M( ) .....	12-5	PCSPCTFCL20005R.....	4-44
P (JA36120U33A.....	9-58	BPEDU5A100FOOL2120M( ) .....		PCSPCTFCL250011.....	4-43
P (JA36120U41A.....	9-58	BPEDU5A100FOOL630M( ) .....	12-5	PCSPCTFCL250056.....	4-43
P (JA36120U43A.....	9-58	BPEDU5B100COOL2120M( ) .....		PCSPCTFCL250058.....	4-43
P (JA36120U44A.....	9-58	BPEDU5B100COOL630M( ) .....	12-5	PCSPCTFCL25005R411.....	4-44
P (JA36120U63AE1.....	9-58	BPEDU5B100COOS3420M( ) .....		PCSPCTFCL300056.....	4-43
P (JA36120U64AE1.....	9-58	BPEDU5B100COOS5460M( ) .....	12-5	PCSPCTFCL30005R.....	4-44
P (JA36120U73AE1.....	9-58	BPEDU5B100FOOL2120M( ) .....		PCSPCTFCL30005R411.....	4-44
P (JA36120U74AE1.....	9-59	BPEDU5B100FOOL630M( ) .....	12-5	PCSPCTFCL400058.....	4-43
P (JL36025(C)U31A – P (JL36025(C)U74AE1.....	7-39	PBPEGX4A100T .....	12-5	PCSPCTFCL40005R411.....	4-44
P (JL36040(C)U31A – P (JL36040(C)U74AE1.....	7-39	PBPEGX5A100T .....	12-5	PCSPCTFCL500058.....	4-43
P (JL36060 – P (JL36060(C)U74AE1.....	7-39	PBPEGX5B100T .....	12-5	PCSPCTFCL50005R411.....	4-44
P (JL36080 – P (JL36080(C)U74AE1.....	7-39	PBPFA3A100 – PBPFA3A100A100 .....	12-3	PCSPCTFCL50005R411.....	4-44
P (JL36100 – P (JL36100(C)U74AE1.....	7-39	PBPFA4A100 – PBPFA4A100A100 .....	12-3	PCSPCTFCL50014.....	4-43
P (JL36120 – P (JL36120(C)U74AE1.....	7-39	PBPFA4B100 .....	12-3	PCSPCTFCL5001R.....	4-44
P1200AWK.....	7-83, 7-86	PBPFA5A100 .....	12-3	PCSPCTFCL50054.....	4-43
P1200R.....	7-83, 7-86	PBPFA5A100A015 – PBPFA5A100A100 .....	12-3	PCSPCTFCL50056.....	4-43
P1200S.....	7-83, 7-86	PBPFA5B100A015 – PBPFA5B100A100 .....	12-3	PCSPCTFCL5005R.....	4-44
PAK1004CGFI.....	1-44	PBIOCVR .....	12-3	PCSPWWMKIT120A.....	4-42
PAK10C1.....	1-44	PBPQO3A100 – PBPQO5A100 .....	12-3	PCSPWWMKIT300A.....	4-42
PAK11C.....	1-44	PBPQOR3A100 – PBPQOR4A100 .....	12-3	PCSPWWMKIT60A.....	4-42
PAK11C1.....	1-44	PBPQOR4A100M115 – PBPQOR4A100M420 .....	12-4	PDC12DG4L3.....	7-56
PAK11CTG.....	1-44	PBPQOR4A100M115B – PBPQOR4A100M420B .....	12-4	PDC12P4.....	7-56
PAK11PG.....	1-44	PBPQOR4B100 .....	12-3	PDC12P44.....	7-56
PAK13CGFI.....	1-44	PBPQOR5A100 – PBPQOR5A100M420B .....	12-3	PDC3BD2.....	7-56
PAK36C1GFI.....	1-44	PBPQOR5B100M115 – PBPQOR5B100M420B .....	12-4	PDC3HD2.....	7-56
PAK41CTG.....	1-44	PBPQOU4A100COOL2120 – .....		PDC3JD20.....	7-56
PAK41PG.....	1-44	PBPQOU4A100COOL630 .....	12-4	PDC5DG20L3.....	7-56
PAK51CGFI.....	1-44	PBPQOU4A100FOOL2120 – .....		PDC6BD6.....	7-56
PAK55CGFI.....	1-44	PBPQOU4A100FOOL630 .....	12-4	PDC6HD6.....	7-56
PAK61PG.....	1-44	PBPQOU5A100COOL2120 – .....		PDC6JD4.....	7-56
PAK72CGFI.....	1-44	PBPQOU5A100COOL630 .....	12-4	PDC6P20.....	7-56
PAK75CTG.....	1-44	PBPQOU5A100FOOL2120 – .....		PDC6P204.....	7-56
PAK75PG.....	1-44	PBPQOU5A100FOOL630 .....	12-4	PHD36015G – PHD36090GN .....	12-12
PAK76CGFI.....	1-44	PBPQOU5B100COOL2120 – .....		PHD36100G – PHD36150GU53X .....	12-12
PB100AEC.....	12-3	PBPQOU5B100COOL630 .....	12-4	PHG36015G – PHG36090GN .....	12-12
PB100FH.....	12-3	PBPQOU5B100FOOL2120 – .....		PHG36100G – PHG36150GN .....	12-12
PB100HFW.....	12-3	PBPQOU5B100FOOL630 .....	12-4	PHG36100GNU31X – PHG36150GU53X .....	12-13
PB100VSB.....	12-3	PBPTB3A100 – PBPTB5A100 .....	12-3	PHJ36015G – PHJ36150GN .....	12-12
PB100WF.....	12-3	PBQ3640G – PBQ4660G .....	12-10	PHJ36060GNU31X – PHJ36150GU53X .....	12-13
PB225AEC.....	12-3	PBTB306 – PBTB506G .....	12-6	PHL36015G – PHL36150GN .....	12-12
PB225FH.....	12-3	PCSPCT7RL1021.....	4-44	PHL36060GNU31X – PHL36150GU53X .....	12-13
PB225HFW.....	12-3	PCSPCT7RL1025.....	4-44	PIU2IMA16 – PIU8IMA24 .....	12-11
PB225VSB.....	12-3	PCSPCT7RL1221.....	4-44	PIU2IMA16 – PIU8IMA24 .....	6-5
PB225WF.....	12-3	PCSPCT7RL1225.....	4-44	PJA26000S10( ) – PJA36000S80 .....	9-57
PB400AEC.....	12-3	PCSPCT7RL1521.....	4-44	PJD36175G – PJD36250GN .....	12-12
PB400FH.....	12-3	PCSPCT7RL1525.....	4-44	PJD36250GNU31X – PJD36250GU53X .....	12-13
PB400HFW.....	12-3	PCSPCT7RL1621.....	4-44	PJG36175G – PJG36250GN .....	12-12
PB400VSB.....	12-3	PCSPCT7RL1625.....	4-44	PJG36250GNU31X – PJG36250GU53X .....	12-13
PB400WF.....	12-3	PCSPCT7RL2011.....	4-44	PJJ36175G – PJJ36250GN .....	12-12
PBCE3A100AST048B – PBCE5B400AST120B .....	12-2	PCSPCT7RL3011.....	4-44	PJJ36250GNU31X – PJJ36250GU53X .....	12-13
PBCF3A100ACRB – PBCF3A100ATBM( )B .....	12-2	PCSPCT7RL3015.....	4-44	PJL26000S10 – PJL36000S80 .....	7-44
PBCF3A225ACRB – PBCF3A225ATBM( )B .....	12-2	PCSPCT7RL4011.....	4-44	PJL36060M88 – PJL36120M70 .....	7-46
PBCF3A400ACRB – PBCF3A400ATBM( )B .....	12-2	PCSPCT7RL4015.....	4-44	PJL36175G – PJL36250GN .....	12-12
PBCF4A100ACRB – PBCF4A100ATBM( )B .....	12-2	PCSPCT7RL5011.....	4-44	PJL36250GNU31X – PJL36250GU53X .....	12-13
PBCF4A225ACRB – PBCF4A225ATBM( )B .....	12-2	PCSPCT7RL5015.....	4-44	PK12GTA.....	1-15
PBCF4A400ACRB – PBCF4A400ATBM( )B .....	12-2	PCSPCT7RL6011.....	4-44	PK15GTA...1-10 – 1-12, 1-16 – 1-17, 1-21 – 1-25, 1-37 .....	1-14
PBCF4B100ACRB – PBCF4B100ATBM( )B .....	12-2	PCSPCT7RL6015.....	4-44	PK15GTA6.....	1-14
PBCF4B225ACRB – PBCF4B225ATBM( )B .....	12-2	PCSPCT7RL7511.....	4-44	PK15GTAL.....	1-9, 1-11, 1-15, 1-26
PBCF4B400ACRB – PBCF4B400ATBM( )B .....	12-2	PCSPCT7RL7515.....	4-44	PK18GTA...1-10 – 1-12, 1-17, 1-21 – 1-22, 1-24 – 1-25 .....	1-25
PBCF5A100ACRB – PBCF5A100ATBM( )B .....	12-2	PCSPCT7RL8011.....	4-44	PK18GTAL.....	1-9, 1-12, 1-21, 1-23, 1-25
PBCF5A225ACRB – PBCF5A225ATBM( )B .....	12-2	PCSPCT7RL8015.....	4-44	PK23GTA.....	1-10 – 1-17, 1-21 – 1-25
PBCF5A400ACRB – PBCF5A400ATBM( )B .....	12-2	PCSPCTFCL100014.....	4-43	PK23GTAL.....	1-9 – 1-12, 1-26, 9-13, 9-21, 9-34
PBCF5B100ACRB – PBCF5B100ATBM( )B .....	12-2	PCSPCTFCL100016.....	4-43	PK27GTA.....	1-10, 1-13, 1-21, 9-13, 9-21, 9-34
PBCF5B225ACRB – PBCF5B225ATBM( )B .....	12-2	PCSPCTFCL10001R.....	4-44	PK27GTACU.....	9-13, 9-21, 9-34
PBCF5B400ACRB – PBCF5B400ATBM( )B .....	12-2	PCSPCTFCL100054.....	4-43	PK2MB.....	1-26
PBHS0408.....	12-3	PCSPCTFCL100056.....	4-43	PK2SCPV.....	1-37
PBHS0815.....	12-3	PCSPCTFCL10005R.....	4-44	PK32DGTA.....	9-47
PBLD36250GNU31X – PBLD36250GU33X .....	12-14	PCSPCTFCL12001R.....	4-44	PK3GTA1.....	1-14 – 1-15, 1-21, 3-6

PK3MB ..... 1-26  
 PK49SP ..... 1-37, 3-18, 9-21  
 PK4DTIM4HA ..... 1-13, 1-26  
 PK4DTIM4LA ..... 1-13, 1-26  
 PK4DTIM4LAL ..... 1-13, 1-26  
 PK4FL ..... 1-26  
 PK4GTA ..... 1-14 – 1-15, 1-17, 1-24  
 PK4MB2HA ..... 1-26  
 PK4MB2LA ..... 1-26  
 PK5RK ..... 1-26  
 PK6FL ..... 1-26 – 1-27  
 PK7GTA ..... 1-13 – 1-15, 1-21, 1-24  
 PK8FL ..... 1-26  
 PK9GTA ..... 1-9 – 1-12, 1-21 – 1-25  
 PKGTAB ..... 1-26, 9-13, 9-21, 9-34  
 PKHB ..... 1-42  
 PKL26000S10 – PKL36000S80 ..... 7-44  
 PKL36100 ..... 16-55  
 PKOGTA2 ..... 3-6, 3-18, 7-82 – 7-85  
 PKOGTA3 ..... 3-6  
 PKOGTA4 ..... 7-83, 7-85  
 PKOGTA7 ..... 3-18  
 PKOGTA8 ..... 3-18  
 PKOGTC2 ..... 3-18  
 PKOGTC3 ..... 3-18  
 PKOGTH150 ..... 7-82, 7-85  
 PKOGTJ250 ..... 7-82, 7-85  
 PKQGA ..... 1-27  
 PKQGFP ..... 1-27  
 PKQGI ..... 1-27  
 PKQGS ..... 1-27  
 PKSB1HA ..... 1-26 – 1-27  
 PKSB1HOMBF ..... 1-27  
 PKSB1LA ..... 1-26 – 1-27  
 PKSB1QOBF ..... 1-26  
 PKSB3 ..... 1-26  
 PKSB3BF ..... 1-26  
 PLL24000S10 – PLL34000S80 ..... 7-44  
 PLL34060M68 – PLL34120M70 ..... 7-46  
 PLL36120 ..... 16-55  
 PNETR6 ..... 6-11  
 PQ3203G – PQ3620G ..... 12-10  
 PQ4203G – PQ4620G ..... 12-10  
 PS080 ..... 4-9  
 PS3220G – PS3620G ..... 12-10  
 PS4220G – PS4620G ..... 12-10  
 PSDS ..... 1-26 – 1-27  
 PSWCENCZZNPEZZ ..... 4-5  
 PSWCWNCZZNPEZZ ..... 4-5  
 PSWCZNCZZSPEZZ ..... 4-5  
 PSWDZNCZZSPEZZ ..... 4-5  
 PSWMBNCZZSPEZZ ..... 4-5  
 PSWMPNCZZSPEZZ ..... 4-5  
 PSWMXNCZZSPEZZ ..... 4-5  
 PSWMZNCZZSPEZZ ..... 4-5  
 PSWSANCZZSPEZZ ..... 4-5  
 PTB302 – PTB502G ..... 12-6  
 PTB316G( ) – PTB516G( ) ..... 12-7  
 PTEL2R ..... 6-11  
 PTMG36300G( ) – PTMG36800GN( ) ..... 12-15  
 PTMG36300GN( ) ..... 12-15  
 PTMJ36300G( ) – PTMJ36800GN( ) ..... 12-15  
 PTPG36040G( ) U31A – PTPG36120GN( ) U44A ..... 12-16  
 PTPJ36040G( ) U31A – PTPJ36120GN( ) U44A ..... 12-16  
 PTQ36080G( ) – PTQ46120G( ) ..... 12-10  
 PTRG36080G( ) U31A – PTRG36160GN( ) U44A ..... 12-17  
 PTRJ36080G( ) U31A – PTRJ36160GN( ) U44A ..... 12-17  
 PTRL36080G( ) U31A – PTRL36160GN( ) U44A ..... 12-17  
 PTT23W – PTT44WG ..... 12-6  
 PVR ..... 6-11

**Q**

Q1100AN ..... 9-21, 9-34  
 Q1150AN ..... 9-21, 9-34  
 Q22200NRB ..... 1-42, 7-83, 7-86  
 Q22200NS ..... 1-42, 7-83, 7-86  
 Q23225NF ..... 7-83, 7-86  
 Q23225NF/S ..... 1-42  
 Q23225NRB ..... 1-42, 7-83, 7-86  
 Q23225NS ..... 7-83, 7-86

Q2FP ..... 1-26  
 Q4L2250 – Q4L3400 ..... 7-35  
 QBA22070( ) ..... 9-52  
 QBA22080( ) ..... 9-52  
 QBA22090( ) ..... 9-52  
 QBA22100( ) ..... 9-52  
 QBA22110( ) ..... 9-52  
 QBA22125( ) ..... 9-52  
 QBA22150( ) ..... 9-52  
 QBA22175( ) ..... 9-52  
 QBA22200( ) ..... 9-52  
 QBA22225( ) ..... 9-52  
 QBA32070( ) ..... 9-52  
 QBA32080( ) ..... 9-52  
 QBA32090( ) ..... 9-52  
 QBA32100( ) ..... 9-52  
 QBA32110( ) ..... 9-52  
 QBA32125( ) ..... 9-52  
 QBA32150( ) ..... 9-52  
 QBA32175( ) ..... 9-52  
 QBA32200( ) ..... 9-52  
 QBA32225( ) ..... 9-52  
 QBL22000S22 ..... 7-44  
 QBL22070 ..... 1-42  
 QBL22070 – QBL32250 ..... 7-34  
 QBL22080 ..... 1-42  
 QBL22090 ..... 1-42  
 QBL22100 ..... 1-42  
 QBL22110 ..... 1-42  
 QBL22125 ..... 1-42  
 QBL22150 ..... 1-42  
 QBL22175 ..... 1-42  
 QBL22200 ..... 1-42  
 QBL22225 ..... 1-42  
 QBL32070 ..... 1-42  
 QBL32080 ..... 1-42  
 QBL32090 ..... 1-42  
 QBL32100 ..... 1-42  
 QBL32110 ..... 1-42  
 QBL32125 ..... 1-42  
 QBL32150 ..... 1-42  
 QBL32175 ..... 1-42  
 QBL32200 ..... 1-42  
 QBL32225 ..... 1-42  
 QBMIK ..... 7-52  
 QBP22070TM – QBP22225TM ..... 2-7, 2-21  
 QBP32070TM – QBP32225TM ..... 2-21  
 QBPA ..... 7-52  
 QBPAF ..... 7-52  
 QC12L200C ..... 1-32  
 QC12L200S ..... 1-32  
 QC2442M150SH ..... 1-34  
 QC2442M200C ..... 1-34  
 QC2442M200CH ..... 1-34  
 QC2442M200S ..... 1-34  
 QC2442M200SH ..... 1-34  
 QC2442M200SHS ..... 1-39  
 QC2442M200SS ..... 1-39  
 QC3040M200S ..... 1-34  
 QC3040M200SH ..... 1-34  
 QC816F100CH ..... 1-32  
 QC816F100SH ..... 1-32  
 QC816F125C ..... 1-32  
 QC816F125S ..... 1-32  
 QC816F125SH ..... 1-32  
 QC816F150C ..... 1-32  
 QC816F150S ..... 1-32  
 QC816F150SH ..... 1-32  
 QC816F150SL ..... 1-32  
 QC816F150SLS ..... 1-39  
 QC816F150SS ..... 1-39  
 QC816F200CH ..... 1-33  
 QC816F200S ..... 1-33  
 QC816F200SH ..... 1-33  
 QC816F200SL ..... 1-33  
 QC816F200SLS ..... 1-39  
 QC816F200SS ..... 1-39  
 QCGK3 ..... 1-37  
 QDA22070( ) ..... 9-52  
 QDA22080( ) ..... 9-52

QDA22090( ) ..... 9-52  
 QDA22100( ) ..... 9-52  
 QDA22110( ) ..... 9-52  
 QDA22125( ) ..... 9-52  
 QDA22150( ) ..... 9-52  
 QDA22175( ) ..... 9-52  
 QDA22200( ) ..... 9-52  
 QDA22225( ) ..... 9-52  
 QDA32070( ) ..... 9-52  
 QDA32080( ) ..... 9-52  
 QDA32090( ) ..... 9-52  
 QDA32100( ) ..... 9-52  
 QDA32110( ) ..... 9-52  
 QDA32125( ) ..... 9-52  
 QDA32150( ) ..... 9-52  
 QDA32175( ) ..... 9-52  
 QDA32200( ) ..... 9-52  
 QDA32225( ) ..... 9-52  
 QDL22070 ..... 1-36, 1-42  
 QDL22070 – QDL32250 ..... 7-34  
 QDL22080 ..... 1-36, 1-42  
 QDL22090 ..... 1-36, 1-42  
 QDL22100 ..... 1-36, 1-42  
 QDL22110 ..... 1-36, 1-42  
 QDL22125 ..... 1-36, 1-42  
 QDL22150 ..... 1-36, 1-42  
 QDL22175 ..... 1-36, 1-42  
 QDL22200 ..... 1-36, 1-42  
 QDL22225 ..... 1-42  
 QDL32070 ..... 1-17, 1-42  
 QDL32080 ..... 1-17, 1-42  
 QDL32090 ..... 1-17, 1-42  
 QDL32100 ..... 1-17, 1-42  
 QDL32110 ..... 1-17, 1-42  
 QDL32125 ..... 1-17, 1-42  
 QDL32150 ..... 1-17, 1-42  
 QDL32175 ..... 1-17, 1-42  
 QDL32200 ..... 1-17, 1-42  
 QDL32225 ..... 1-17, 1-42  
 QDP22070TM – QDP22225TM ..... 2-7, 2-21  
 QDP32070TM – QDP32225TM ..... 2-21  
 QGA22070( ) ..... 9-52  
 QGA22080( ) ..... 9-52  
 QGA22090( ) ..... 9-52  
 QGA22100( ) ..... 9-52  
 QGA22110( ) ..... 9-52  
 QGA22125( ) ..... 9-52  
 QGA22150( ) ..... 9-52  
 QGA22175( ) ..... 9-52  
 QGA22200( ) ..... 9-52  
 QGA22225( ) ..... 9-52  
 QGA32070( ) ..... 9-52  
 QGA32080( ) ..... 9-52  
 QGA32090( ) ..... 9-52  
 QGA32100( ) ..... 9-52  
 QGA32110( ) ..... 9-52  
 QGA32125( ) ..... 9-52  
 QGA32150( ) ..... 9-52  
 QGA32175( ) ..... 9-52  
 QGA32200( ) ..... 9-52  
 QGA32225( ) ..... 9-52  
 QGL22070 ..... 1-42  
 QGL22070 – QGL32250 ..... 7-34  
 QGL22080 ..... 1-42  
 QGL22090 ..... 1-42  
 QGL22100 ..... 1-42  
 QGL22110 ..... 1-42  
 QGL22125 ..... 1-42  
 QGL22150 ..... 1-42  
 QGL22175 ..... 1-42  
 QGL22200 ..... 1-42  
 QGL22225 ..... 1-42  
 QGL32070 ..... 1-17, 1-42  
 QGL32080 ..... 1-17, 1-42  
 QGL32090 ..... 1-17, 1-42  
 QGL32100 ..... 1-17, 1-42  
 QGL32110 ..... 1-17, 1-42  
 QGL32125 ..... 1-17, 1-42  
 QGL32150 ..... 1-17, 1-42  
 QGL32175 ..... 1-17, 1-42  
 QGL32200 ..... 1-17, 1-42

QGL32225.....	1-17, 1-42	QMB225W.....	9-61	QO115VH.....	7-11
QGP22070TM – QGP22225TM.....	2-7, 2-21	QMB225WT3.....	9-61	QO115VHCAFI.....	1-5
QGP32070TM – QGP32225TM.....	2-21	QMB261HW.....	9-61	QO115VHCAFI.....	7-13
QH115.....	1-3	QMB261TW.....	9-61	QO115VHDF.....	1-5, 7-13
QH115 – QH330.....	7-11	QMB262HW.....	9-61	QO115VHGFI.....	1-5, 7-13
QH120.....	1-3	QMB262TW.....	9-61	QO115VHPCAFI.....	1-5
QH125.....	1-3	QMB263HW.....	9-61	QO115VHPCAFI.....	7-13
QH130.....	1-3	QMB263TW.....	9-61	QO115VHPDF.....	1-5
QH215.....	1-3	QMB264W.....	9-61	QO115VHPDF.....	7-13
QH220.....	1-3	QMB300EK.....	9-61	QO116L125PG.....	1-9
QH225.....	1-3	QMB30R – QMB60R.....	12-10	QO116L125PGRB.....	1-12
QH230.....	1-3	QMB321HW.....	9-61	QO116M100P.....	1-10
QH315.....	1-3	QMB321TW.....	9-61	QO116M100PC.....	1-11
QH320.....	1-3	QMB322HW.....	9-61	QO116M100PRB.....	1-12
QH325.....	1-3	QMB322TW.....	9-61	QO120.....	1-3, 1-36
QH330.....	1-3	QMB323HW.....	9-61	QO120.....	7-11
QHB115.....	9-15	QMB323TW.....	9-61	QO120CAFI.....	1-5
QHB120.....	9-15	QMB324W.....	9-61	QO120CAFI.....	7-13
QHB125.....	9-15	QMB325W.....	9-61	QO120DF.....	1-5
QHB130.....	9-15	QMB325WT3.....	9-61	QO120DF.....	7-13
QHB215.....	9-15	QMB326W.....	9-61	QO120EPD.....	1-6
QHB220.....	9-15	QMB326WT3.....	9-61	QO120EPD.....	7-13
QHB225.....	9-15	QMB327WT3.....	9-61	QO120GFI.....	1-5, 7-13
QHB230.....	9-15	QMB361HW.....	9-61	QO120HM.....	1-7
QHB315.....	9-15	QMB361TW.....	9-61	QO120HM.....	7-14
QHB320.....	9-15	QMB362HW.....	9-61	QO120K.....	7-14
QHB325.....	9-15	QMB362T21W.....	9-61	QO120K.....	1-6, 7-13
QHB330.....	9-15	QMB362TW.....	9-61	QO120L125PG.....	1-9
QJA22070( ).....	9-52	QMB363HW.....	9-61	QO120L125PGC.....	1-11
QJA22080( ).....	9-52	QMB363T31W.....	9-61	QO120L125PWG.....	1-16
QJA22090( ).....	9-52	QMB363T32W.....	9-61	QO120M100P.....	1-10
QJA22100( ).....	9-52	QMB363TW.....	9-61	QO120M100PC.....	1-11
QJA22110( ).....	9-52	QMB364W.....	9-61	QO120M100PRB.....	1-12
QJA22125( ).....	9-52	QMB365W.....	9-61	QO120M150P.....	1-10
QJA22150( ).....	9-52	QMB365WT6.....	9-61	QO120M150PRB.....	1-12
QJA22175( ).....	9-52	QMB366W.....	9-61	QO120M200P.....	1-10
QJA22200( ).....	9-52	QMB367W.....	9-61	QO120M200PRB.....	1-12
QJA22225( ).....	9-52	QMB36R.....	9-61	QO120PCAFI.....	1-5
QJA32070( ).....	9-52	QMB4060R.....	9-61	QO120PDF.....	1-5
QJA32080( ).....	9-52	QMB60R.....	9-61	QO120PDF.....	7-13
QJA32090( ).....	9-52	QMB60R and QMB36R.....	9-61	QO120VH.....	1-3, 1-36
QJA32100( ).....	9-52	QMB610EK.....	9-61	QO120VH.....	7-11
QJA32110( ).....	9-52	QMJ361T.....	9-61	QO120VHCAFI.....	1-5
QJA32125( ).....	9-52	QMJ362T.....	9-61	QO120VHCAFI.....	7-13
QJA32150( ).....	9-52	QMJ363H.....	9-61	QO120VHDF.....	1-5, 7-13
QJA32175( ).....	9-52	QMJ363T.....	9-61	QO120VHGFI.....	1-5
QJA32200( ).....	9-52	QMJ364H.....	9-61	QO120VHGFI.....	7-13
QJA32225( ).....	9-52	QMJ364T.....	9-61	QO120VHPCAFI.....	1-5
QJL22070.....	1-42	QMJ365.....	9-61	QO120VHPCAFI.....	7-13
QJL22070 – QJL32250.....	7-34	QMJ366.....	9-61	QO120VHPDF.....	1-5, 7-13
QJL22080.....	1-42	QO110.....	1-3, 1-36, 7-11	QO122X26M200PC.....	1-13
QJL22090.....	1-42	QO110K.....	1-6	QO124L125PG.....	1-9
QJL22100.....	1-42	QO110K.....	7-14	QO124L125PGC.....	1-11
QJL22110.....	1-42	QO112L125PG.....	1-9	QO124L125PGCVP.....	1-25
QJL22125.....	1-42	QO112L125PGC.....	1-11	QO124L125PGRB.....	1-12
QJL22150.....	1-42	QO112L125PGRB.....	1-12	QO124L125PQG.....	1-11
QJL22175.....	1-42	QO112L125PWG.....	1-16	QO124L200PG.....	1-9
QJL22200.....	1-42	QO112L200PG.....	1-9	QO124M100P.....	1-10
QJL22225.....	1-42	QO112L200PGRB.....	1-12	QO124M100PC.....	1-11
QJL32070.....	1-17, 1-42	QO112M100P.....	1-10	QO124M100PCVP.....	1-25
QJL32080.....	1-17, 1-42	QO112M100PC.....	1-11	QO124M100PRB.....	1-12
QJL32090.....	1-17, 1-42	QO112M100PRB.....	1-12	QO124M125P.....	1-10
QJL32100.....	1-17, 1-42	QO115.....	1-3, 1-36	QO124M125PRB.....	1-12
QJL32110.....	1-17, 1-42	QO115.....	7-11	QO124M150P.....	1-10
QJL32125.....	1-17, 1-42	QO115CAFI.....	1-5	QO124M200P.....	1-10
QJL32150.....	1-17, 1-42	QO115CAFI.....	7-13	QO124M200PWG125.....	1-16
QJL32175.....	1-17, 1-42	QO115DF.....	1-5	QO125.....	1-3, 1-36
QJL32200.....	1-17, 1-42	QO115DF.....	7-13	QO125.....	7-11
QJL32225.....	1-17, 1-42	QO115EPD.....	1-6, 7-13	QO125EPD.....	1-6
QJP22070TM – QJP22225TM.....	2-7, 2-21	QO115GFI.....	1-5	QO125EPD.....	7-13
QJP32070TM – QJP32225TM.....	2-21	QO115GFI.....	7-13	QO125GFI.....	1-5, 7-13
QMB100R.....	9-61	QO115HID.....	1-6	QO125HID.....	1-6, 7-14
QMB11MA12 – QMB81MA24.....	6-5	QO115HID.....	7-14	QO125K.....	1-6, 7-14
QMB200EK.....	9-61	QO115HM.....	1-7	QO125VH.....	1-3, 1-36, 7-11
QMB221HW.....	9-61	QO115HM.....	7-14	QO125VHGFI.....	1-5
QMB221TW.....	9-61	QO115K.....	1-6	QO125VHGFI.....	7-13
QMB222HW.....	9-61	QO115K.....	7-14	QO130.....	1-3, 1-36
QMB222TW.....	9-61	QO115PCAFI.....	1-5	QO130.....	7-11
QMB223HW.....	9-61	QO115PCAFI.....	7-13	QO130EPD.....	1-6
QMB223TW.....	9-61	QO115PDF.....	1-5, 7-13	QO130EPD.....	7-13
QMB224W.....	9-61	QO115VH.....	1-3, 1-36	QO130GFI.....	1-5, 7-13

QO130HID	1-6, 7-14	QO1HPL	7-15	QO220SWN	1-6
QO130K	1-6, 7-14	QO1HT	1-8, 7-15, 9-13, 9-21	QO220SWN	7-14
QO130L125PG	1-9	QO1LO	1-8, 1-20, 7-15, 7-22	QO220VH	1-3
QO130L125PQG	1-11	QO1PA	1-8, 7-15, 9-13, 9-21	QO220VH	7-11
QO130L200PG	1-9	QO1PAF	1-8, 9-21	QO220VHCAFI	1-5
QO130L200PGC	1-11	QO1PAF	7-15	QO220VHCAFI	7-13
QO130L200PGRB	1-12	QO1PL	1-8, 9-13, 9-21	QO2225SL	1-8
QO130L200PQG	1-11	QO1PL	7-15	QO2225SL	7-15
QO130L200PWG	1-16	QO1SE	1-26	QO225	1-3
QO130M150P	1-10	QO200	1-3, 1-7	QO225	7-11
QO130M150PC	1-11	QO200	7-11, 7-14	QO225EPD	1-6
QO130M150PRB	1-12	QO2000	1-3, 1-7	QO225EPD	7-13
QO130M200P	1-10	QO2000	7-11, 7-14	QO225GFI	1-5, 7-13
QO130M200PC	1-11	QO2000NRB	1-42, 3-5, 3-7	QO225H	1-3, 7-11
QO130M200PQ	1-11	QO2000NS	1-42, 3-5, 3-7	QO225HID	1-6, 7-14
QO130M200PRB	1-12	QO200TR	1-42, 3-5, 3-7	QO225SWN	1-6
QO130VH	1-3, 1-36, 7-11	QO200TRNM	1-42	QO225SWN	7-14
QO130VHGFI	1-5	QO2020	1-4	QO225VH	1-3
QO130VHGFI	7-13	QO2020	7-12	QO225VH	7-11
QO132L125PG	1-9	QO2030	1-4	QO230	1-3, 1-36, 7-11
QO132M100P	1-10	QO2030	7-12	QO230EPD	1-6
QO132M100PCVP	1-25	QO20303020	1-4	QO230EPD	7-13
QO132M125P	1-10	QO20303020	7-12	QO230GFI	1-5, 7-13
QO135	1-3, 1-36	QO210	1-3	QO230H	1-3, 7-11
QO135	7-11	QO210	7-11	QO230HID	1-6, 7-14
QO140	1-3, 1-36	QO2100	1-3, 1-36	QO230SWN	1-6
QO140	7-11	QO2100BNRB	1-42	QO230SWN	7-14
QO140HID	1-6, 7-14	QO2100H	1-3	QO230VH	1-3, 1-36
QO140L200PG	1-9	QO2100H	7-11	QO230VH	7-11
QO140L200PGRB	1-12	QO2100VH	1-3, 1-36	QO235	1-3, 1-36
QO140M200P	1-10	QO2100VH	7-11	QO235	7-11
QO140M200PC	1-11	QO210SWN	1-6	QO240	1-3, 1-36
QO140M200PRB	1-12	QO210SWN	7-14	QO240 - QO2125	2-7, 2-21, 7-11
QO140M225P	1-10	QO2110	1-3, 1-36, 2-21	QO240EPD	1-6
QO140VH	1-3, 1-36, 7-11	QO2110	7-11	QO240EPD	7-13
QO142L225PG	1-9	QO2110VH	1-3, 1-36, 2-21	QO240GFI	1-5, 7-13
QO142L225PGC	1-11	QO2110VH	7-11	QO240H	1-3, 7-11
QO142L225PGCVP	1-25	QO2125	1-3, 1-36	QO240HID	1-6, 7-14
QO142L225PGRB	1-12	QO2125BNRB	1-42	QO240SWN	1-6
QO142L225PQG	1-11	QO2125SL	1-8	QO240SWN	7-14
QO142M150PC	1-11	QO2125SL	7-15	QO240VH	1-3, 1-36, 2-7, 2-21
QO142M200P	1-10	QO2125VH	1-3, 1-36	QO240VH	7-11
QO142M200PC	1-11	QO2125VH	7-11	QO245	1-3, 1-36
QO142M200PCAFVP	1-25	QO215	1-3	QO245	7-11
QO142M200PCVP	1-25	QO215	7-11	QO245L50TTS	1-14
QO142M200PQ	1-11	QO2150	1-3, 1-36	QO245L60NRNM	1-15
QO142M200PRB	1-12	QO2150	7-11	QO2470F	1-14
QO142M225P	1-10	QO2150VH	1-3, 1-36	QO2470TS	1-14
QO142M225PRB	1-12	QO2150VH	7-11	QO2470RB	1-15
QO145	1-3, 1-36	QO215CAFI	1-5	QO250	1-3, 1-36
QO145	7-11	QO215CAFI	7-13	QO250EPD	1-6
QO148L125GF	1-14	QO215EPD	1-6	QO250EPD	7-13
QO148L125GRB	1-14 - 1-15	QO215EPD	7-13	QO250GFI	1-5, 7-13
QO150	1-3, 1-36	QO215GFI	1-5, 7-13	QO250H	1-3, 7-11
QO150	7-11	QO215H	1-3	QO250HID	1-6
QO150HID	1-6, 7-14	QO215H	7-11	QO250PSPD	1-27, 6-12
QO150VH	1-3, 7-11	QO215HID	1-6, 7-14	QO250SWN	1-6
QO1515	1-4	QO215SWN	1-6	QO250SWN	7-14
QO1515	7-12	QO215SWN	7-14	QO250VH	1-3, 1-36
QO1520	1-4	QO215VH	1-3	QO250VH	7-11
QO1520	7-12	QO215VH	7-11	QO260	1-3, 1-36
QO154L225PG	1-9	QO215VHCAFI	1-5	QO260EPD	1-6
QO154L225PGC	1-11	QO215VHCAFI	7-13	QO260EPD	7-13
QO154L225PQG	1-11	QO2175	1-3, 1-36	QO260GFI	1-5
QO154M200P	1-10	QO2175	7-11	QO260GFI	7-13
QO154M200PC	1-11	QO2175SB	1-27, 6-12	QO260H	1-3, 7-11
QO154M200PQ	1-11	QO2175VH	1-3, 1-36	QO260NATR	1-42
QO160	1-3, 1-36	QO2175VH	7-11	QO260NATS	1-42, 3-5, 3-7
QO160	7-11	QO220	1-3	QO260VH	1-3, 1-36
QO160M200PC	1-10	QO220	7-11	QO260VH	7-11
QO160VH	1-3, 7-11	QO2200	1-3, 1-36	QO270	1-3, 1-36
QO1612M125FTRB	1-15	QO2200	7-11	QO270H	1-3, 7-11
QO170	1-3, 1-36	QO2200VH	1-3, 1-36	QO270VH	1-3, 1-36
QO170	7-11	QO2200VH	7-11	QO270VH	7-11
QO170VH	1-3, 7-11	QO220CAFI	1-5	QO280	1-3, 1-36
QO1816M150FTRB	1-15	QO220CAFI	7-13	QO280H	1-3, 7-11
QO1816M200FTRB	1-15	QO220EPD	1-6	QO280VH	1-3, 1-36
QO1DM10020TRBR	1-13	QO220EPD	7-13	QO280VH	7-11
QO1DM10030TRBR	1-13	QO220GFI	1-5, 7-13	QO290	1-3, 1-36
QO1DM10050TRBR	1-13	QO220H	1-3, 7-11	QO290H	1-3, 7-11
QO1HPL	1-8	QO220HID	1-6, 7-14	QO290VH	1-3, 1-36

QO290VH	7-11	QO340SWN	1-6, 7-14	QOB125GFI	9-14
QO2DTI	1-8, 1-13, 1-26	QO340VH	1-3, 7-11	QOB125HID	9-15
QO2DTI	7-15	QO342L225G	1-17	QOB125K	9-14
QO2DTIM	1-8, 1-13, 1-26	QO342L225GRB	1-17	QOB125VH	9-15
QO2DTIM	7-15	QO342MQ150	1-17	QOB125VHEPD	9-14
QO2L30S	1-14	QO342MQ200	1-17	QOB125VHGFI	9-14
QO2L30TTS	1-14	QO342MQ200RB	1-17	QOB130	9-14
QO2L40RB	1-15	QO342MQ225	1-17	QOB130EPD	9-14
QO2PAF	1-8, 9-21	QO342MQ225RB	1-17	QOB130GFI	9-14
QO2PAF	7-15	QO345	1-3, 7-11	QOB130HID	9-15
QO2TR	1-42	QO350	1-3, 7-11	QOB130K	9-14
QO300	1-3, 1-7	QO350EPD	1-6, 7-13	QOB130VH	9-15
QO300	7-11, 7-14	QO350EPE	1-6, 7-13	QOB130VHEPD	9-14
QO3000	1-3, 1-7	QO35FM30TTF	1-14	QOB130VHGFI	9-14
QO3000	7-14	QO35FM30TTS	1-14	QOB135	9-14
QO3020	1-4, 7-12	QO350GFI	1-5, 7-13	QOB140	9-15
QO310	1-3	QO350SWN	1-6, 7-14	QOB140HID	9-15
QO310	7-11	QO350VH	1-3, 7-11	QOB140VH	9-15
QO3100	1-3	QO360	1-3, 7-11	QOB145	9-15
QO3100	7-11	QO360VH	1-3, 7-11	QOB150	9-15
QO3100BNRB	1-42	QO370	1-3, 7-11	QOB150HID	9-15
QO3100VH	1-3, 7-11	QO370VH	1-3, 7-11	QOB150VH	9-15
QO310SWN	1-6, 7-14	QO380	1-3, 7-11	QOB160	9-15
QO3125SL	1-8, 7-15	QO380VH	1-3, 7-11	QOB160VH	9-15
QO312L125G	1-17	QO390	1-3, 7-11	QOB170	9-15
QO312L125GRB	1-17	QO390VH	1-3, 7-11	QOB170VH	9-15
QO315	1-3, 7-11	QO3HT	1-8, 7-15, 9-13, 9-21	QOB200	9-15
QO315EPD	1-6, 7-13	QO403L60NRB	1-17	QOB2000	9-15
QO315EPE	1-6, 7-13	QO48M30DSGP	1-13	QOB210	9-14
QO315GFI	1-5, 7-13	QO48M60DSGP	1-13	QOB2100	9-15
QO315HID	1-6, 7-14	QO60SL	1-8, 7-15	QOB2100H	9-15
QO315SWN	1-6, 7-14	QO612L100DF	1-14	QOB2100VH	9-15
QO315VH	1-3, 7-11	QO612L100DFCU	1-14	QOB210SWN	9-15
QO318L200G	1-17	QO612L100DTF	1-14	QOB2110	9-15
QO318L200GRB	1-17	QO612L100DTS	1-14	QOB2110VH	9-15
QO320	1-3, 7-11	QO612L100F	1-14	QOB2125	9-15
QO320EPD	1-6	QO612L100RB	1-15	QOB2125SL	9-21
QO320EPD	7-13	QO612L100RBCU	1-15	QOB2125VH	9-15
QO320EPE	1-6	QO612L100TF	1-14	QOB215	9-14
QO320EPE	7-13	QO612L100TRB	1-15	QOB2150VH	9-15
QO320GFI	1-5, 7-13	QO612L100TS	1-14	QOB215EPD	9-14
QO320HID	1-6, 7-14	QO70AN	9-21, 9-34	QOB215GFI	9-14
QO320L125G	1-17	QO816L100DF	1-14	QOB215H	9-14
QO320L125GRB	1-17	QO816L100DFCU	1-14	QOB215HID	9-15
QO320SWN	1-6	QO816L100DTF	1-14	QOB215SWN	9-15
QO320SWN	7-14	QO816L100DTS	1-14	QOB215VH	9-15
QO320VH	1-3	QO816L100F	1-14	QOB220	9-14
QO320VH	7-11	QO816L100RB	1-15	QOB220EPD	9-14
QO324L125G	1-17	QO816L100RBCU	1-15	QOB220GFI	9-14
QO325	1-3	QO816L100TF	1-14	QOB220H	9-14
QO325	7-11	QO816L100TS	1-14	QOB220HID	9-15
QO325HID	1-6, 7-14	QOB110	9-14	QOB220SWN	9-15
QO325SWN	1-6	QOB110K	9-14	QOB220VH	9-15
QO325SWN	7-14	QOB115	9-14	QOB225	9-14
QO325VH	1-3	QOB115CAFI	9-16	QOB225EPD	9-14
QO325VH	7-11	QOB115DF	9-16	QOB225GFI	9-14
QO327M100	1-17	QOB115EPD	9-14	QOB225H	9-15
QO327M100RB	1-17	QOB115GFI	9-14	QOB225SWN	9-15
QO330	1-3	QOB115HID	9-15	QOB225VH	9-15
QO330	7-11	QOB115HM	9-14	QOB230	9-14
QO330EPD	1-6	QOB115K	9-14	QOB230EPD	9-14
QO330EPD	7-13	QOB115VH	9-15	QOB230GFI	9-14
QO330EPE	1-6	QOB115VHCAFI	9-16	QOB230H	9-14
QO330EPE	7-13	QOB115VHDF	9-16	QOB230HID	9-15
QO330GFI	1-5, 7-13	QOB115VHEPD	9-14	QOB230SWN	9-15
QO330HID	1-6, 7-14	QOB115VHGFI	9-14	QOB230VH	9-15
QO330L200G	1-17	QOB120	9-14	QOB235	9-14
QO330L200GRB	1-17	QOB120CAFI	9-16	QOB240	9-15
QO330MQ125	1-17	QOB120DF	9-16	QOB240EPD	9-14
QO330MQ125RB	1-17	QOB120EPD	9-14	QOB240GFI	9-14
QO330MQ150	1-17	QOB120GFI	9-14	QOB240H	9-15
QO330MQ150RB	1-17	QOB120HID	9-15	QOB240HID	9-15
QO330MQ200	1-17	QOB120HM	9-14	QOB240SWN	9-15
QO330MQ200RB	1-17	QOB120K	9-14	QOB240VH	9-15
QO330SWN	1-6, 7-14	QOB120VH	9-15	QOB245	9-15
QO330VH	1-3, 7-11	QOB120VHCAFI	9-16	QOB250	9-15
QO335	1-3, 7-11	QOB120VHDF	9-16	QOB250EPD	9-14
QO340	1-3, 7-11	QOB120VHEPD	9-14	QOB250GFI	9-14
QO340EPD	1-6, 7-13	QOB120VHGFI	9-14	QOB250H	9-15
QO340EPE	1-6, 7-13	QOB125	9-14	QOB250HID	9-15
QO340GFI	1-5, 7-13	QOB125EPD	9-14		

QOB250SWN.....	9-15	QOC24US.....	1-9 – 1-11, 1-17	QON130L200I.....	7-16
QOB250VH.....	9-15	QOC30U125C.....	1-9, 1-11	QON132L125I.....	7-16
QOB260.....	9-15	QOC30UF.....	1-9 – 1-11, 1-17	QON142L225I.....	7-16
QOB260EPD.....	9-14	QOC30UFWG.....	1-16	QON24L70.....	7-16
QOB260GFI.....	9-14	QOC30US.....	1-9 – 1-11, 1-17	QON2L40.....	7-16
QOB260H.....	9-15	QOC32UF.....	1-9 – 1-10	QON2L70.....	7-16
QOB260VH.....	9-15	QOC342MQF.....	1-17	QON312L125.....	7-16
QOB270.....	9-15	QOC342MQS.....	1-17	QON312L125I.....	7-16
QOB270H.....	9-15	QOC40UF.....	1-9 – 1-10	QON318L200.....	7-16
QOB270VH.....	9-15	QOC40US.....	1-9 – 1-10	QON318L200I.....	7-16
QOB280.....	9-15	QOC42UF.....	1-9 – 1-11, 1-17	QON320L125.....	7-16
QOB280H.....	9-15	QOC42US.....	1-9 – 1-11, 1-17	QON320L125I.....	7-16
QOB280VH.....	9-15	QOC54UF.....	1-9 – 1-11	QON324L125.....	7-16
QOB290.....	9-15	QOCGK2C.....	1-13, 1-26	QON324L125I.....	7-16
QOB290H.....	9-15	QOCRBGK1C.....	1-13, 1-26	QON324L200.....	7-16
QOB290VH.....	9-15	QOE250GFINM.....	1-42	QON324L200I.....	7-16
QOB300.....	9-15	QOFF.....	1-26, 1-37	QON330L200.....	7-16
QOB3000.....	9-15	QOFF.....	2-21	QON330L200I.....	7-16
QOB310.....	9-14	QOGFI1PAF.....	1-8, 7-15, 9-21	QON342L225.....	7-16
QOB3100.....	9-15	QOGL20.....	1-15	QON342L225I.....	7-16
QOB3100VH.....	9-15	QOH2100.....	1-3	QON3B.....	7-16
QOB310SWN.....	9-15	QOH2110.....	1-3, 2-21	QON403L60N.....	7-16
QOB3110VH.....	9-15	QOH2110.....	7-11	QON612L100.....	7-16
QOB3125SL.....	9-21	QOH2125.....	1-3	QON816L100.....	7-16
QOB3125VH.....	9-15	QOH240.....	7-11	QONQ30LS400.....	1-14
QOB315.....	9-14	QOH240 – QOH260.....	1-3, 2-7, 2-21	QONQ42LS400.....	1-14
QOB3150VH.....	9-15	QOH245.....	1-3	QONQ42MS300.....	1-14
QOB315EPD.....	9-14	QOH245.....	7-11	QONQ42MS400.....	1-14
QOB315EPE.....	9-14	QOH250.....	1-3	QORBGK2C.....	1-13, 1-26
QOB315GFI.....	9-14	QOH250.....	7-11	QOSAMK.....	1-27
QOB315HID.....	9-15	QOH26.....	1-3	QOT1515.....	1-4, 7-12
QOB315SWN.....	9-15	QOH26.....	7-11	QOT1520.....	1-4, 7-12
QOB315VH.....	9-15	QOH270 – QOH2125.....	1-3, 2-7, 2-21, 7-11	QOT2020.....	1-4, 7-12
QOB320.....	9-14	QOH280.....	1-3	QOTHPA.....	1-8, 7-15
QOB320EPD.....	9-14	QOH290.....	1-3	QOTHT.....	1-8
QOB320EPE.....	9-14	QOHPL.....	1-8	QOTHT.....	7-15
QOB320GFI.....	9-14	QOHPL.....	7-15	QOU110.....	7-17
QOB320HID.....	9-15	QOHT2.....	9-21	QOU1100.....	7-18
QOB320SWN.....	9-15	QOHT3.....	9-21	QOU115.....	7-17
QOB320VH.....	9-15	QOL125.....	1-10, 1-23	QOU115HM.....	7-17
QOB325.....	9-14	QOL125VD.....	1-10, 1-23, 2-22	QOU115VH.....	7-17
QOB325HID.....	9-15	QOL225.....	1-10, 1-23	QOU120.....	7-17
QOB325SWN.....	9-15	QOL3125.....	1-17	QOU120HM.....	7-17
QOB325VH.....	9-15	QOL3225.....	1-17	QOU120VH.....	7-17
QOB330.....	9-14	QOM100VH.....	1-10, 1-22 – 1-23, 1-36	QOU125.....	7-17
QOB330EPD.....	9-14	QOM110VH.....	1-10, 1-22 – 1-23, 1-36	QOU125VH.....	7-17
QOB330EPE.....	9-14	QOM125VH.....	1-10, 1-22 – 1-23, 1-36	QOU130.....	7-17
QOB330GFI.....	9-14	QOM1FP.....	1-26 – 1-27	QOU130VH.....	7-17
QOB330HID.....	9-15	QOM1PA.....	1-20, 1-26 – 1-27, 7-22	QOU135.....	7-17
QOB330SWN.....	9-15	QOM2100MM – QOM2200MM.....	2-7	QOU135VH.....	7-17
QOB330VH.....	9-15	QOM2100MVH – QOM2200MVH.....	2-7	QOU140.....	7-17
QOB335.....	9-14	QOM2100VH.....	1-10, 1-22 – 1-23, 1-36, 1-43	QOU140VH.....	7-17
QOB340.....	9-15	QOM2125VH.....	1-10, 1-22 – 1-23, 1-36, 1-43	QOU14100BAFB.....	7-19
QOB340EPD.....	9-14	QOM2150VH.....	1-10, 1-22 – 1-23, 1-36, 1-43	QOU14100BALB.....	7-19
QOB340EPE.....	9-14	QOM2175VH.....	1-10, 1-22 – 1-23, 1-36, 1-43	QOU14100BARB.....	7-19
QOB340GFI.....	9-14	QOM2200VH.....	1-10, 1-22 – 1-23, 1-36, 1-43	QOU14100CAB.....	7-19
QOB340SWN.....	9-15	QOM22225NRB.....	1-43	QOU14100JBAL.....	7-19
QOB340VH.....	9-15	QOM2225VH.....	1-10, 1-22 – 1-23, 1-36, 1-43	QOU14100JBAL.....	7-19
QOB345.....	9-15	QOM2FP.....	1-26 – 1-27	QOU14100JBAR.....	7-19
QOB350.....	9-15	QOM2PA.....	1-20, 1-26 – 1-27, 7-22	QOU145.....	7-17
QOB350EPD.....	9-14	QOM50VH.....	1-10, 1-22 – 1-23, 1-36	QOU145VH.....	7-17
QOB350EPE.....	9-14	QOM60VH.....	1-10, 1-22 – 1-23, 1-36	QOU150.....	7-17
QOB350GFI.....	9-14	QOM70VH.....	1-10, 1-22 – 1-23, 1-36	QOU150VH.....	7-17
QOB350SWN.....	9-15	QOM80VH.....	1-10, 1-22 – 1-23, 1-36	QOU160.....	7-17
QOB350VH.....	9-15	QOM90VH.....	1-10, 1-22 – 1-23, 1-36	QOU160VH.....	7-17
QOB360.....	9-15	QOMB1.....	7-16	QOU16150BAFB.....	7-19
QOB360VH.....	9-15	QOMB2.....	7-16	QOU16150BALB.....	7-19
QOB370.....	9-15	QOMB3.....	7-16	QOU16150BARB.....	7-19
QOB370VH.....	9-15	QON11224L125I.....	7-16	QOU16150CAB.....	7-19
QOB380.....	9-15	QON112L125I.....	7-16	QOU16150JBAL.....	7-19
QOB380VH.....	9-15	QON11624L125I.....	7-16	QOU170.....	7-17
QOB390.....	9-15	QON116L125I.....	7-16	QOU180.....	7-18
QOB390VH.....	9-15	QON12024L125I.....	7-16	QOU190.....	7-18
QOC12UF.....	1-10	QON120L125I.....	7-16	QOU1CMSB.....	7-19
QOC12US.....	1-10	QON124L125I.....	7-16	QOU1PA.....	7-19
QOC16UF.....	1-9, 1-17	QON124L150I.....	7-16	QOU1PAFLA.....	7-19
QOC16US.....	1-9, 1-17	QON124L200DL.....	7-16	QOU1PL.....	7-19
QOC20U100F.....	1-9 – 1-10	QON124L200I.....	7-16	QOU200.....	7-18
QOC20U100S.....	1-9 – 1-10	QON12L100.....	7-16	QOU2000.....	7-18
QOC20UFWG.....	1-16	QON12L100SF.....	7-16	QOU20001.....	7-18
QOC24UF.....	1-9 – 1-11, 1-17	QON12L200FTL.....	7-16	QOU210.....	7-17



QOU2100 .....	7-18	QU816D400SL .....	1-35	RDB41 – RDB126 .....	13-4
QOU2125 .....	7-18	QUM400CK .....	1-35	RE17LAMW – RE17RMXMU .....	23-100
QOU215 .....	7-17	QUM400CL .....	1-35	RE48ACV12MW – RE48ATM12MW .....	23-102
QOU215H .....	7-17	QYU110 .....	7-17	REC06 – REC30 .....	13-7
QOU215VH .....	7-17	QYU115 .....	7-17	REHU393IP .....	3-34
QOU220 .....	7-17	QYU120 .....	7-17	REHU394IP .....	3-34
QOU220H .....	7-17	QYU125 .....	7-17	REHU493IP .....	3-34
QOU220VH .....	7-17	QYU130 .....	7-17	REHU494IP .....	3-34
QOU225 .....	7-17			REL52801 .....	5-3
QOU225H .....	7-17			REL52804 .....	5-3
QOU225VH .....	7-17			REL52807 .....	5-3
QOU230 .....	7-17			REL52809 .....	5-3
QOU230H .....	7-17			REL52828 .....	5-3
QOU230VH .....	7-17			REL52829 .....	5-3
QOU235 .....	7-17			REL52900 .....	5-3
QOU235VH .....	7-17			REL52901 .....	5-3
QOU240 .....	7-17			REXL2TMB7 – REXL2TMP7 .....	23-103
QOU240VH .....	7-17			REXL4TMB7 – REXL4TMP7 .....	23-103
QOU245 .....	7-17			RFK03 .....	3-23, 16-46, 16-131
QOU245VH .....	7-17			RFK03 .....	8-34
QOU250 .....	7-17			RFK03H .....	3-4, 3-16
QOU250VH .....	7-17			RFK03L .....	3-16
QOU260 .....	7-17			RFK06 .....	3-12 – 3-13, 3-16, 3-28, 16-46, 16-131
QOU260VH .....	7-17			RFK06 .....	8-34
QOU270 .....	7-17			RFK06H .....	3-16, 3-28, 16-46, 16-131
QOU280 .....	7-18			RFK06H .....	8-34
QOU290 .....	7-18			RFK10 .....	3-4, 3-12 – 3-13, 3-16, 3-28
QOU2DTILA .....	7-19			RFK10 .....	8-34
QOU2PAFLA .....	7-19			RG50 .....	13-8
QOU300 .....	7-18			RGZE1S35M – RGZE1S48M .....	23-5
QOU3000 .....	7-18			RGZL520 – RGZR215 .....	23-5
QOU30001 .....	7-18			RHV062100009 – RHV302100033 .....	13-8
QOU310 .....	7-17			RKF26000S12 – RLF36000S30 .....	7-44
QOU3100 .....	7-18			RL00202 – RL02512 .....	26-14
QOU315 .....	7-17			RL3TB .....	7-57
QOU315VH .....	7-17			RL3TB4 .....	7-57
QOU320 .....	7-17			RLTB .....	7-57
QOU320VH .....	7-17			RLTB4 .....	7-57
QOU325 .....	7-17			RM17JC00MW .....	23-111
QOU325VH .....	7-17			RM17TA00 – RM35TM50MW .....	23-112
QOU330 .....	7-17			RM17UAS14 – RM17UBE16 .....	23-113
QOU330VH .....	7-17			RM35ATL0MW .....	23-116
QOU335 .....	7-17			RM35ATR5MW .....	23-116
QOU340 .....	7-17			RM35ATW5MW .....	23-116
QOU345 .....	7-17			RM35BA10 .....	23-115
QOU350 .....	7-17			RM35HZ21FM .....	23-116
QOU360 .....	7-17			RM35JA31MW .....	23-111
QOU370 .....	7-17			RM35JA32MW .....	23-111
QOU380 .....	7-18			RM35LM33MW .....	23-114
QOU390 .....	7-18			RM35LV14MW .....	23-114
QOUCP2 .....	7-19			RM35S0MW .....	23-116
QOUCP2B .....	7-19			RM35UA11MW – RM35UA13MW .....	23-113
QOUCP3 .....	7-19			RM35UB330 – RM35UB3N30 .....	23-113
QOUCP3B .....	7-19			RM79696006 – RM79696044 .....	23-114
QOUCP4 .....	7-19			RMC1000G3120 .....	9-41
QOUCP4B .....	7-19			RMC1000G3240 .....	9-41
QOUCP6 .....	7-19			RMC1000G3277 .....	9-41
QOUCP6B .....	7-19			RMC1000N2G3120 .....	9-41
QOUEC .....	7-19			RMC1000N2G3240 .....	9-41
QOUECB .....	7-19			RMC1000N2G3277 .....	9-41
QOUFR .....	7-19			RMC2000G3120 .....	9-41
QOUFRB .....	7-19			RMC2000G3240 .....	9-41
QOUHFSC1 .....	7-19			RMC2000G3277 .....	9-41
QOUHFSC1B .....	7-19			RMC3000G3120 .....	9-41
QOULFSC1 .....	7-19			RMC3000G3240 .....	9-41
QOULFSC1B .....	7-19			RMC3000G3277 .....	9-41
QOUMF1 .....	7-19			RMC3000G3C120 .....	9-41
QOUMF1B .....	7-19			RMC3000G3C240 .....	9-41
QOUMF2 .....	7-19			RMC3000G3C277 .....	9-41
QOUMF2B .....	7-19			RMC500G3120 .....	9-41
QOUMF3 .....	7-19			RMC500G3240 .....	9-41
QOUMF3B .....	7-19			RMC500G3277 .....	9-41
QOUMFS1 .....	7-19			RMCA61BD – RMTK90BD .....	23-118
QOUMFS1B .....	7-19			RPF2AB7 – RPF2AP7 .....	23-13
QOVRT .....	7-19			RPF2BB7 – RPF2BP7 .....	23-13
QOVRTB .....	7-19			RPM11B7 – RPM43P7 .....	23-9
QU12L400CL .....	1-35			RPM1SOC120A .....	19-114
QU12L400SL .....	1-35			RPM1SOC24D .....	19-114
QU816D400CK .....	1-35			RPZ1DA – RPZ4FA .....	23-10
QU816D400CL .....	1-35			RPZF1 – RPZF4 .....	23-10
QU816D400FL .....	1-35			RPZR235 .....	23-10
		<b>R</b>			
		R( )A36100CU31A .....	9-59		
		R( )A36100CU33A .....	9-59		
		R( )A36100CU41A .....	9-59		
		R( )A36100CU43A .....	9-59		
		R( )A36100CU44A .....	9-59		
		R( )A36100CU63AE1 .....	9-59		
		R( )A36100CU64AE1 .....	9-59		
		R( )A36100CU73AE1 .....	9-59		
		R( )A36100CU74AE1 .....	9-59		
		R( )A36100CU7AE1 .....	9-59		
		R( )A36120 .....	9-59		
		R( )A36120CU31A .....	9-59		
		R( )A36120CU33A .....	9-59		
		R( )A36120CU41A .....	9-59		
		R( )A36120CU43A .....	9-59		
		R( )A36120CU44A .....	9-59		
		R( )A36120CU63AE1 .....	9-59		
		R( )A36120CU64AE1 .....	9-59		
		R( )A36120CU73AE1 .....	9-59		
		R( )A36120CU74AE1 .....	9-59		
		R( )F36060 – R( )F36300 .....	7-40, 7-41		
		R400L .....	1-37		
		RC12L200C .....	1-33		
		RC12L200S .....	1-33		
		RC1624M100S .....	1-34		
		RC1624M125S .....	1-34		
		RC200S .....	1-32		
		RC2040M125CH .....	1-34		
		RC2040M125SH .....	1-34		
		RC2040M150CH .....	1-34		
		RC2040M150SH .....	1-34		
		RC2040M150SHS .....	1-39		
		RC2040M200C .....	1-34		
		RC2040M200CGP .....	1-34		
		RC2040M200CH .....	1-34		
		RC2040M200S .....	1-34		
		RC2040M200SH .....	1-34		
		RC2040M200SHS .....	1-39		
		RC2040M200SS .....	1-39		
		RC2M200S .....	1-32		
		RC2M200SH .....	1-32		
		RC2M200SL .....	1-32		
		RC3040M150SL .....	1-34		
		RC3040M150SLS .....	1-39		
		RC3040M200SL .....	1-34		
		RC3040M200SLS .....	1-39		
		RC3042M200PS .....	1-39		
		RC816D200CH .....	1-33		
		RC816F100CH .....	1-33		
		RC816F100SH .....	1-33		
		RC816F125CH .....	1-33		
		RC816F125SH .....	1-33		
		RC816F150C .....	1-33		
		RC816F150CH .....	1-33		
		RC816F150S .....	1-33		
		RC816F150SH .....	1-33		
		RC816F150SL .....	1-33		
		RC816F150SLS .....	1-39		
		RC816F150SS .....	1-39		
		RC816F200C .....	1-33		
		RC816F200CH .....	1-33		
		RC816F200S .....	1-33		
		RC816F200SH .....	1-33		
		RC816F200SHS .....	1-39		
		RC816F200SL .....	1-33		
		RC816F200SLS .....	1-39		
		RC816F200SS .....	1-39		
		RC8L125S .....	1-33		
		RCGK2 .....	1-37		
		RCM200SL .....	1-32		
		RCP0624 – RCP3024 .....	13-7		

**Product Locator Index**

Alphanumeric Listing



www.se.com/us

RSB1A120B7 – RSB2A080U7	23-3	S29282	7-58	S33875	7-51
RSB1SOC24D	19-114	S29283	7-58	S33928	7-57
RSB2SOC24D	19-114	S29284	7-58	S33929	7-53
RSC16G3120	9-40	S29286	7-58	S33930	9-49
RSC16G3240	9-40	S29287	7-58	S33931	9-49
RSC16G3277	9-40	S29305 – S37422	7-52	S33932	7-53
RSG4	2-21	S29337	7-51	S33933	7-53
RSL1AB4BD – RSL1PVPU	23-2	S29337 + S29345	7-51	S33934	7-53
RSLZ2	23-2, 23-70	S29337 + S29346	7-51	S33935	7-53
RSLZ3	23-2, 23-70	S29338	7-51	S33937	7-62
RSLZ5	23-2, 23-70	S29338 + S29346	7-51	S33982	7-62
RSLZRA1 – RSLZVA4	23-2	S29339	7-51	S33983	7-62
RSZE1S35M – RSZE1S48M	23-3	S29339 + S29345	7-51	S33984	7-62
RSZL300	23-3, 23-5	S29339 + S29346	7-51	S33997	7-53
RSZR215	23-3	S29340	7-51	S33998	7-57
RU3040D400CK	1-36	S29343	7-51	S34036	7-62
RU3040D400CL	1-36	S29346	7-51	S36967	7-57
RU3040D400FK	1-36	S29382 – S33801	7-49	S37423	7-54
RU3040D400FL	1-36	S29433 – S37420	7-50	S37424	7-54
RUMC2( )	23-12	S29445	7-51	S37425	7-57
RUMC21B7	23-11	S29450	8-39	S37426	7-57
RUMC21BD	23-11	S29450 x 2	8-39	S37427	7-57
RUMC21E7 – RUMC33P7	23-11	S32477	7-53	S37428	7-57
RUMC3( )	23-12	S32478	7-53	S37429	7-57
RUMF2( )	23-12	S32514	7-58	S37430	7-57
RUMF21B7 – RUMF33P7	23-11	S32515	7-58	S37432	7-53
RUMF3( )	23-12	S32523	7-58	S37433	7-53
RUW101MW – RUW242P7	23-10, 23-12	S32525	7-58	S37434	7-53
RUZC200	23-12	S32532	7-58	S37436	7-53, 7-58
RUZC2M – RUZC3M	23-12, 23-102	S32533	7-58	S37437	7-53
RUZL420	23-12	S32534	7-58	S37438	7-53
RUZS2	23-12	S32562	7-53, 7-58	S37439	7-53
RUZSC2M	23-12	S32563	7-53, 7-58	S37440	7-53, 7-58
RUZSC3M	23-12	S32597	7-51	S37442	7-58
RUZSF3M	23-12	S32597 + S29346	7-51	S37443	7-58
RXG11B7 – RXG15RD	23-4	S32597 + S32605	7-51	S37444	7-57
RXG21B7 – RXG25RD	23-4	S32598	7-51	S37445	7-57
RXM021BN – RXM041FU7	23-8, 23-10	S32598 + S29346	7-51	S37446	7-57
RXM2AB1B7 – RXM2AB3P7	23-6	S32599	7-51	S37447	7-57
RXM3AB1B7 – RXM3AB2P7	23-6	S32599 + S29346	7-51	S37448	7-57
RXM4AB1B7 – RXM4AB3P7	23-6	S32599 + S32605	7-51	S37449	7-57
RXM4GB1B7 – RXM4GB1P7	23-6	S32600	7-51	S37450	7-57
RXM4GB2B7 – RXM4GB3P7	23-7	S32602	7-51	S41940	7-50 – 7-51
RXM4SOC120A	19-114	S32603	7-51	S41950	7-51
RXM4SOC24D	19-114	S32604	7-51	S42878	7-51
RXV122100018 – RXV302100036	13-8	S32605	7-51	S42888	7-50 – 7-51
RXZ400	23-8	S32606	7-51	S429341	7-51
RXZE2DA	23-8, 23-10	S33091	7-62	S429344	7-51
RXZE2FA	23-8, 23-10	S33092	7-62	S429424	7-63
RXZE2M114	23-8	S33093	7-62	S429441 – S432652	7-50
RXZE2M114M	23-8, 23-103	S33094	7-62	S429478	7-62
RXZE2S108M	23-8	S33095	7-62	S429481	7-62
RXZE2S111M	23-8	S33098	7-58	S429483	7-62
RXZE2S114M	23-8, 23-103	S33099	7-58	S429484	7-62
RXZE2S114S	23-8, 23-64	S33100	7-62	S429521	7-62
RXZES108M	23-103	S33166	7-58, 7-72	S429532	7-63
RXZL420	23-8	S33170	7-58	S430562	7-62
RXZL520	23-8, 23-10, 23-12	S33171	7-58	S430563	7-62
RXZR335	23-8	S33575	7-62	S432459	7-62
RXZS2	23-8	S33576	7-62	S432461	7-62
RZD60	13-7	S33576MK	7-83, 7-85	S432475	7-53
RZM021BN – RZM041FU7	23-3, 23-5	S33592	7-62	S432476	7-53
		S33593	7-62	S432552	7-57
		S33594	7-62	S432553	7-52
		S33595	7-62	S432575	7-62
		S33646	7-57	S434201	7-63, 7-76
		S33659	7-49 – 7-50	S434201BS	7-63, 7-76
		S33660	7-49 – 7-50	S434202	7-63, 7-76
		S33661	7-49 – 7-50	S434202BS	7-63, 7-76
		S33662	7-49 – 7-50	S434203	7-76
		S33664	7-49 – 7-50	S434203BS	7-76
		S33717	7-53	S434204	7-76
		S33718	7-53	S434204BS	7-63, 7-76
		S33763	7-58	S434205	7-63, 7-76
		S33767	7-58, 7-72	S434206	7-62
		S33772	7-58	S434210	7-62
		S33786	7-58	S434212	7-62
		S33788	7-58	S434300	7-62 – 7-63
		S33852	7-58	S434301	7-62 – 7-63
		S33857	7-53, 7-58	S434302	7-63
		S33859	7-58	S434303BS	7-63

**S**

S131A	7-61
S132R	7-61
S133A	7-61
S141A	7-61
S142R	7-61
S143A	7-61
S144A	7-61
S163A	7-61
S164A	7-61
S173A	7-61
S174A	7-61
S29272	7-58
S29273	7-58
S29274	7-58
S29275	7-58
S29278	7-58

ALPHA-NUMERIC LISTING

S434500	7-63	SBAD800R	11-8	SN0310C	3-28
S434501	7-63	SBSAD800	11-8	SN1000MA	7-83, 7-85
S434502	7-63	SBSAD800R	11-8	SN100FA	7-82, 7-85
S434503	7-63	SC12L200F	1-32	SN1200	7-83, 7-85
S434504	7-63	SC12L200S	1-32	SN12125	7-16
S434505	7-63	SC1624M100F	1-34	SN12200	7-16
S434506	7-63	SC1624M100S	1-34	SN20	7-16
S434507	7-63	SC1624M125F	1-34	SN225KA	7-82, 7-84 – 7-85
S434508	7-63	SC1624M125S	1-34	SN30	7-16
S44936	7-52	SC200F	1-37	SN400LA	7-82 – 7-85
S46996	7-53	SC2040M125F	1-34	SN42	7-16
S46998	7-53	SC2040M125PF	1-40	SN800SNI	7-83
S47052	7-62	SC2040M200C	1-34	SNC400LX	7-83, 7-85
S47053	7-62	SC2040M200F	1-34	SNC800LX	7-83, 7-85
S47067	7-62	SC2040M200PF	1-40	SO1020M100S	1-34
S47100	7-74	SC2040M200PS	1-40	SO2040M200S	1-34
S47101	7-71, 7-74	SC2040M200S	1-34	SO2040M200SS	1-39
S47102	7-71, 7-74	SC2636M200FPV	1-34	SR2A101FU	27-2
S47103	7-71, 7-74	SC2636M225FPV	1-34	SR2B121BD	27-2
S47104	7-74	SC3040M200F	1-34	SR2B121FU	27-2
S47105	7-71, 7-74	SC3040M200S	1-34	SR2D101FU	27-2
S47390 – S47398	7-50	SC3040M225F	1-34	SR2MEM02	27-2
S47403	7-63	SC3042M200PF	1-40	SR2USB01	27-2
S47405	7-63	SC3042M200PS	1-40	SR3B101BD	27-2
S47485	7-63	SC3042M225PF	1-40	SR3B101FU	27-2
S47506	7-63	SC40M200S	1-34	SR3B261BD	27-2
S47507	7-63	SC42M200PS	1-40	SR3B261FU	27-2
S47542	7-72	SC816D150C	1-32	SR3XT101FU	27-2
S48182	7-62	SC816D200C	1-32	SR3XT61FU	27-2
S48188	7-63	SC816F150PS	1-40	SRCOV32B	7-71
S48382	7-63	SC816F150S	1-32	SRCOV32T	7-71
S48384	7-63	SC816F200F	1-32	SRCOV40	7-71
S48533	7-63	SC816F200PF	1-40	SRCOV40BFX	7-71
S48818	7-62	SC816F200PS	1-40	SRCTV12	7-58, 7-71
S48819	7-62	SC816F200S	1-32	SRCTV20	7-71
S48820	7-62	SC8L125F	1-32	SRCTV50	7-71
S48823	7-62	SC8L125S	1-32	SRCTV60	7-71
S48824	7-62	SCBRLOCK	1-37	SS03	3-16
S48825	7-62	SD12781	3-15	SS0306SK	8-35
S48836	7-62	SDAG26	1-16	SS06	3-16
S48837	7-62	SDGT30020	1-16	SS06	8-35
S48838	7-62	SDGT300300	1-16	SS10	3-16
S48839	7-62	SDGT300C10C	1-16	SS10	8-35
S48840	7-62	SDGT300C300C	1-16	SS10SK	8-35
S48855	7-62	SDSA1175	1-27, 6-10, 16-80	SS20	3-16
S48856	7-62	SDSA1175T	6-10	SS212AB	11-8
S48896	7-62	SDSA2040	1-27, 6-10	SS212AC	11-8
S48899	7-58, 7-72	SDSA2040D	1-27, 6-10	SS2PL	11-8
S48900	7-72	SDSA3650	6-10, 16-80	SS312	11-8
S48901	7-72	SDSA3650D	6-10	SS4060LI	3-16
S48906	7-72	SDSA4040	6-10	SS4060LO	3-16
S48907	7-62	SDSA4040D	6-10	SS80120LI	3-17
S48908	7-62	SDSB80111	1-27, 6-11	SS80120LO	3-17
S48916	7-62	SF124FR – SF348WS	11-7	SSL1A12BD – SSL1A12NDR	23-70
S48933	7-58, 7-72	SFCF12	7-58, 7-71	SSL1D03BD – SSL1D03ND	23-70
S48934	7-72	SFCF20B	7-71	SSL1D101BD – SSL1D101ND	23-70
S48981	7-62	SFCF20FB	7-71	SSLZRA1 – SSLZVA4	23-70
S6200A0A0B0A0B0R	4-14	SFCF20FT	7-71	SSM1A112B7 – SSM1A112P7	23-71
S6200R1A0B0A0B0R	4-14	SFCF20T	7-71	SSM1A112B7R – SSM1A112P7R	23-71
S6200T1A0B0A0B0R	4-14	SFCF40	7-71	SSM1A16B7 – SSM1A16P7	23-71
S64203	7-63	SFCT30	7-71	SSM1A16B7R – SSM1A16P7R	23-71
S64205	7-63	SFCT30B	7-71	SSM1A312B7 – SSM1A312P7	23-71
S64206	7-63	SFCT50	7-71	SSM1A312B7R – SSM1A312P7R	23-71
S64207	7-63	SFD212CG2YB07D07 – SFD212SG4YB07D07	26-27	SSM1A36BD	23-71
S64208	7-63	SK9795	7-16	SSM1A36BDR	23-71
S64209	7-63	SK9796BW	7-16	SSM1D212BD	23-71
S64210	7-63	SK9797	7-16	SSM1D26BD	23-71
S64273	7-63	SK9801	7-16	SSM1D312BD	23-71
SA10BL	11-8	SK9842	7-16	SSM1D36BD	23-71
SA10LW	11-8	SK9948BW	7-16	SSM2A16BD	23-72
SA26PS	11-8	SL100	9-49	SSM2A16BDR	23-72
SA26PSR	11-8	SL250	9-49	SSM2A36BD	23-72
SA7PL	11-8	SL400	9-49	SSM2A36BDR	23-72
SA8LL	11-8	SL800	9-49	SSP01BIA – SSP03BIA	9-21
SAIF200	4-9	SL800M5	9-49	SSP01BIA08PBQ1 – SSP03BIA24PBQ1	6-6
SAM	4-9	SM900A100000 – SM906A890000	20-12	SSP01EMA12( ) – SSP09EMA32( )	6-2
SASFBH100L – SASFBJ225R	11-8	SM950A100000 – SM956A890000	20-12	SSP01EMA12S( ) – SSP09EMA32S( )	6-2
SASFBH100L( ) – SASFBJ225R( )	11-8	SMCT800 – SMCT6000Y	7-70	SSP01XDSE10A( ) – SSP09XDSE10A( )	6-8
SB124IR – SB348WS	11-7	SMD	4-21, 4-27	SSP3A225B7 – SSP3A250P7R	23-77
SBA15D13MS – SBA30D15MS	11-8	SMDOPN	4-21, 4-27	SSR2( )DINAC( ) – SSR6( )DINDC( )	23-81
SBAD800	11-8	SN0310	3-28	SSR210DINAC22 – SSR665DINAC45	23-81

SSRAH1 – SSRHP25 ..... 23-78  
 STRM ..... 4-9  
 STRV00121 ..... 7-75  
 STRV00910 ..... 7-62  
 STRV00911 ..... 7-62  
 STS3000 ..... 4-9  
 SU2040M200C ..... 1-34  
 SU2X6TRIM ..... 1-37  
 SU3040D300CB ..... 1-36  
 SU3040D300FB ..... 1-36  
 SU3040D400CB ..... 1-36  
 SU3040D400CN ..... 1-36  
 SU3040D400FB ..... 1-36  
 SU3040D400FN ..... 1-36  
 SU3040M200R ..... 1-34  
 SU3040M225R ..... 1-34  
 SU816D150C ..... 1-32  
 SU816D200C ..... 1-32  
 SVW3A8114 ..... 7-62

**T**

T02AN13 ..... 16-14  
 T02AN23 ..... 16-15  
 T02BN13 ..... 16-14  
 T02BN23 ..... 16-15  
 T02CN13 ..... 16-14  
 T02CN23 ..... 16-15  
 T02DN13 ..... 16-14  
 T02DN23 ..... 16-15  
 T02EN13 ..... 16-14  
 T02EN23 ..... 16-15  
 T02FN13 ..... 16-14  
 T02FN23 ..... 16-15  
 T02GN13 ..... 16-14  
 T02GN23 ..... 16-15  
 T02HN13 ..... 16-14  
 T02HN23 ..... 16-15  
 T02JN13 ..... 16-14  
 T02JN23 ..... 16-15  
 T327N ..... 3-4, 3-7  
 T327NR ..... 3-4, 3-7  
 T36AN13 ..... 16-16  
 T36AN23 ..... 16-17  
 T36BN13 ..... 16-16  
 T36BN23 ..... 16-17  
 T36CN13 ..... 16-16  
 T36CN23 ..... 16-17  
 T36DN13 ..... 16-16  
 T36DN23 ..... 16-17  
 T36EN13 ..... 16-16  
 T36EN23 ..... 16-17  
 T36FN13 ..... 16-16  
 T36FN23 ..... 16-17  
 T36GN13 ..... 16-16  
 T36GN23 ..... 16-17  
 T36HN13 ..... 16-16  
 T36JN13 ..... 16-16  
 TCSCARO13M120 ..... 26-16 – 26-17  
 TCSEGW13FA0 ..... 26-26  
 TC5MCNAM3M002P ..... 16-106, 19-131, 26-11 – 26-29  
 TCSWAAC13FB ..... 26-16  
 TDR782XBX – TDR782XDX ..... 23-105  
 TDR782XDAX12D – TDR782XDAX230A ..... 23-105  
 TDRPRO5100 – TDRPRO5102 ..... 23-107  
 TDRPRO51001X – TDRPRO51002 ..... 23-107  
 Three Pole ..... 16-109  
 TIKFD ..... 9-29  
 TM221C16R ..... 27-2  
 TM221C24R ..... 27-2  
 TM221C40R ..... 27-2  
 TM221CE16R – TM221CE40T ..... 27-2  
 TM221ME16R ..... 27-2  
 TM221ME16T ..... 27-2  
 TM241CE24R – TM241CEC24U ..... 27-2  
 TM251MESC ..... 27-3  
 TM251MESE ..... 27-3  
 TM3AI4 ..... 27-3  
 TM3AI8 ..... 27-3  
 TM3AM6 ..... 27-3  
 TM3AQ2 ..... 27-3

TM3DI8 ..... 27-3  
 TM3DI8A ..... 27-3  
 TM3DM8R ..... 27-3  
 TM3DQ16R ..... 27-3  
 TM3DQ16T ..... 27-3  
 TM3DQ8R ..... 27-3  
 TM3DQ8T ..... 27-3  
 TM3TI4 ..... 27-3  
 TM3TI8T ..... 27-3  
 TM3XREC1 ..... 27-3  
 TM3XTRA1 ..... 27-3  
 TMA3DI16 ..... 27-3  
 TMA3Q4 ..... 27-3  
 TRAI1000SC07 ..... 4-41  
 TRAI1200SC07 ..... 4-41  
 TRAI1500SC07 ..... 4-41  
 TRAI2000SC07 ..... 4-41  
 TRAI2000SC11 ..... 4-41  
 TRAI2500SC07 ..... 4-41  
 TRAI2500SC11 ..... 4-41  
 TRAI3000SC07 ..... 4-41  
 TRAI3000SC11 ..... 4-41  
 TRAI3500SC07 ..... 4-41  
 TRAI4000SC07 ..... 4-41  
 TRAI5000SC11 ..... 4-41  
 TRAI6000SC11 ..... 4-41  
 TRV00128 ..... 7-76  
 TRV00217 ..... 7-76  
 TRV00803 – TRV00880 ..... 7-68, 7-76  
 TRV00915 ..... 7-62  
 TRV00917 ..... 7-62  
 TSXCANCA100 ..... 16-107  
 TSXCANCA300 ..... 16-107  
 TSXCANCA50 ..... 16-107  
 TSXCANKCDF180T ..... 16-107  
 TSXCANKCDF90T ..... 16-107  
 TSXCANKCDF90TP ..... 16-107  
 TSXCUSB485 ..... 16-106  
 TSXETG100 ..... 26-29  
 TSXPBSCA100 ..... 16-107  
 TSXPBSCA400 ..... 16-107  
 TVS120XR50S – TVS9HWA80X ..... 6-9  
 TVS12RMU ..... 6-2  
 TVS1IMA12Q( ) – TVS9IMA18O( ) ..... 6-7

**U**

U92197CCCPL ..... 2-2  
 UAK7T ..... 2-2  
 UATRS101B ..... 2-2  
 UATRS202B ..... 2-2  
 UATRS213B ..... 2-2  
 UBHMRS212B ..... 2-2  
 UE7 ..... 23-98  
 UGHTRS101L ..... 2-2  
 UGHTRS111C ..... 2-2  
 UHTRS101B – UHTRS223A ..... 2-2  
 UK7T ..... 2-2  
 URS101BCPL ..... 2-2  
 URS101BDQ ..... 2-2  
 URS212ADQ ..... 2-2  
 URTRS101B ..... 2-2  
 URTRS213B ..... 2-2  
 USMBLK ..... 7-16  
 USMBTC ..... 7-16  
 UT2R1121B ..... 2-3  
 UT2R2122B ..... 2-3  
 UT3R1121B ..... 2-3  
 UT4R1131B ..... 2-3  
 UT4R2352T ..... 2-3  
 UT5R1131B ..... 2-3  
 UT5R2392TU ..... 2-3  
 UT6R1131B ..... 2-3  
 UT6R2392TU ..... 2-3  
 UTH4203T – UTH7300T ..... 2-2  
 UTRS101B – UTRS213B ..... 2-2  
 UTZRS101A ..... 2-2

**V**

V0 ..... 8-5

V01 ..... 8-5  
 V02 ..... 8-5  
 V1 ..... 8-5  
 V2 ..... 8-5  
 V3 ..... 8-5  
 V4 ..... 8-5  
 V5 ..... 8-5  
 V6 ..... 8-5  
 VBD0 ..... 8-4  
 VBD01 ..... 8-4  
 VBD02 ..... 8-4  
 VBD1 ..... 8-4  
 VBD2 ..... 8-4  
 VBDN12 ..... 8-3  
 VBDN20 ..... 8-3  
 VBF0 ..... 8-4  
 VBF01 ..... 8-4  
 VBF02 ..... 8-4  
 VBF1 ..... 8-4  
 VBF2 ..... 8-4  
 VBF3 ..... 8-4  
 VBF4 ..... 8-4  
 VBF5 ..... 8-4  
 VBF6 ..... 8-4  
 VC1GUN ..... 8-4  
 VC2GUN ..... 8-4  
 VC3GUN ..... 8-4  
 VC4GUN ..... 8-4  
 VC5GUN ..... 8-4  
 VC6GUN ..... 8-4  
 VCCD0 ..... 8-4  
 VCCD01 ..... 8-4  
 VCCD02 ..... 8-4  
 VCCD1 ..... 8-4  
 VCCD2 ..... 8-4  
 VCCDN12 ..... 8-3  
 VCCDN20 ..... 8-3  
 VCCF0 ..... 8-4  
 VCCF01 ..... 8-4  
 VCCF02 ..... 8-4  
 VCCF1 ..... 8-4  
 VCCF2 ..... 8-4  
 VCCF3 ..... 8-4  
 VCCF4 ..... 8-4  
 VCCF5 ..... 8-4  
 VCCF6 ..... 8-4  
 VCD0 ..... 8-4  
 VCD01 ..... 8-4  
 VCD02 ..... 8-4  
 VCD1 ..... 8-4  
 VCD2 ..... 8-4  
 VCDN12 ..... 8-3  
 VCDN20 ..... 8-3  
 VCEL02114S1 ..... 14-9  
 VCEL030516H1 ..... 14-9  
 VCEL07512H1 ..... 14-9  
 VCELSK1 – VCELSK4 ..... 14-9  
 VCF0 ..... 8-4  
 VCF01 ..... 8-4  
 VCF02 ..... 8-4  
 VCF1 ..... 8-4  
 VCF2 ..... 8-4  
 VCF3 ..... 8-4  
 VCF4 ..... 8-4  
 VCF5 ..... 8-4  
 VCF6 ..... 8-4  
 VCFN12GE ..... 8-3  
 VCFN20GE ..... 8-3  
 VJDFNDTGSV62M ..... 27-13  
 VJGNDTGSV63M ..... 27-13  
 VJDSNDTGSV62M ..... 27-13  
 VJDSNDTMSV13M ..... 16-105  
 VJDSNRTMPC ..... 27-13  
 VJDSNTRCKV62M – VJDTNDTGSV62M ..... 27-13  
 VLVAF4P66075AA ..... 4-39  
 VLVAF4P66075AB ..... 4-39  
 VLVAF4P66100AA ..... 4-39  
 VLVAF4P66100AB ..... 4-39  
 VLVAF4P66125AA ..... 4-39  
 VLVAF4P66125AB ..... 4-39  
 VLVAF4P66150AA ..... 4-39

VLVAF4P66150AB.....	4-39
VLVAF4P66175AA.....	4-39
VLVAF4P66175AB.....	4-39
VLVAF4P66200AA.....	4-39
VLVAF4P66200AB.....	4-39
VLVAW2N66075AA.....	4-37
VLVAW2N66075AB.....	4-37
VLVAW2N66100AA.....	4-37
VLVAW3N66125AA.....	4-37
VLVAW3N66125AB.....	4-37
VLVAW3N66150AA.....	4-37
VLVAW3N66150AB.....	4-37
VLVAW3N66175AA.....	4-37
VLVAW3N66175AB.....	4-37
VLVAW3N66200AA.....	4-37
VLVAW3N66200AB.....	4-37
VLVAW3N66225AA.....	4-37
VLVAW3N66225AB.....	4-37
VLVAW3N66250AA.....	4-37
VLVAW3N66250AB.....	4-37
VLVAW3N66275AB.....	4-37
VLVAW3N66300AB.....	4-37
VM18CD0000.....	20-11
VM18CD0000Q.....	20-11
VM18CD1000 – VM18CI3000.....	20-11
VM18CD1000Q – VM18CI3000Q.....	20-11
VM18NNC – VM18NNO.....	20-11
VM18NNCQ – VM18NNOQ.....	20-11
VM18NPI0000 – VM18NPI2000.....	20-11
VM18NPI0000Q – VM18NPI2000Q.....	20-11
VM18NPO0000 – VM18NPO2000.....	20-11
VM18NPO0000Q – VM18NPO2000Q.....	20-11
VM18NTO – VM18PNO.....	20-11
VM18NTOQ – VM18PNOQ.....	20-11
VM18PPI0000 – VM18VI3000Q.....	20-11
VM1CD0000 – VM1CI3000Q.....	20-11
VM1NNC – VM1NNOQ.....	20-11
VM1NPI0000 – VM1NPI2000Q.....	20-11
VM1NPO0000 – VM1NPO2000Q.....	20-11
VM1NTO – VM1NTOQ.....	20-11
VM1PNC – VM1PNOQ.....	20-11
VM1PPI0000 – VM1PPO2000Q.....	20-11
VM1PTO – VM1PTOQ.....	20-11
VM1VD0000 – VM1VD3000Q.....	20-11
VM1VI0000 – VM1VI3000Q.....	20-11
VN12.....	8-3
VN20.....	8-3
VVD0.....	8-4
VVD1.....	8-4
VVD2.....	8-4
VVD3.....	8-4
VVD4.....	8-4
VVE0.....	8-4
VVE1.....	8-4
VVE2.....	8-4
VVE3.....	8-4
VVE4.....	8-4
VW3A1006.....	26-12, 26-14, 26-16
VW3A1007.....	26-12, 26-14, 26-16
VW3A1101.....	26-11, 26-14, 26-16, 26-22
VW3A1102.....	26-11, 26-16, 26-22
VW3A1103.....	26-11, 26-16, 26-22
VW3A1104R10.....	16-107, 26-11 – 26-28
VW3A1104R100.....	26-11, 26-14, 26-16, 26-22, 26-26
VW3A1104R30.....	16-107, 26-11 – 26-28
VW3A1104R50.....	16-107, 26-11 – 26-28
VW3A1105.....	26-11, 26-16, 26-22
VW3A1111.....	26-16 – 26-17, 26-26
VW3A1112.....	26-16 – 26-17, 26-26
VW3A1113.....	26-17
VW3A1115 – VW3A5506.....	26-26
VW3A21212.....	26-11
VW3A3101 – VW3A3309.....	26-22
VW3A31101 – VW3A31813.....	26-14
VW3A31814 – VW3A31817.....	26-10, 26-14
VW3A31852.....	26-11
VW3A3307S371.....	26-22
VW3A3600 – VW3A9921.....	26-16
VW3A3601.....	26-16 – 26-17, 26-26
VW3A3607.....	26-16 – 26-17, 26-26
VW3A3608.....	26-16 – 26-17, 26-26

VW3A3609.....	26-16 – 26-17, 26-26
VW3A3616.....	26-16 – 26-17
VW3A3618.....	26-16 – 26-17, 26-26
VW3A3619.....	26-16 – 26-17
VW3A3620.....	26-16 – 26-17
VW3A3627.....	26-16 – 26-17, 26-26
VW3A3628.....	26-16 – 26-17, 26-26
VW3A4416 – VW3A9525.....	26-12
VW3A8106.....	16-106
VW3A8120.....	26-12, 26-14, 26-16 – 26-17, 26-22
VW3A8121.....	26-11 – 26-12, 26-14, 26-16 – 26-17
VW3A8126.....	26-12, 26-16 – 26-17
VW3A8151R20U.....	26-11, 26-14, 26-27 – 26-29
VW3A8306D30.....	4-28
VW3A8306DRC.....	7-76
VW3A8306R.....	16-107
VW3A8306R03.....	16-107, 26-11 – 26-28
VW3A8306R10.....	16-107, 26-11 – 26-28
VW3A8306R30.....	16-107, 26-11 – 26-28
VW3A8306RC.....	26-28 – 26-29
VW3A8306RC.....	7-76
VW3A8306TF03.....	16-107, 26-11 – 26-28
VW3A8306TF10.....	16-107, 26-11 – 26-28
VW3A9201 – VW3A9515.....	26-23
VW3A9201PF – VW3A9292PF.....	26-23
VW3A9206 – VW3A9208.....	26-10, 26-23
VW3A9404 – VW3A9407.....	26-14
VW3A9804.....	26-12, 26-14, 26-16
VW3A9805.....	26-12, 26-14, 26-16
VW3CANA71 – VW3CANKCDF180T.....	26-22
VW3CANCARR03.....	26-16 – 26-17
VW3CANCARR1.....	26-16 – 26-17
VW3CANTAP2.....	26-16 – 26-17
VW3G22101 – VW3G22U402.....	26-28
VW3G4104.....	18-51
VW3G48101.....	26-29
VW3M2207.....	26-16 – 26-17
VW3M7101R01.....	26-16 – 26-17
VW3M7102R150.....	26-16 – 26-17
VX5VP0A001 – VX5VPS6001.....	26-26
VZ0.....	8-7
VZ01.....	8-7
VZ02.....	8-7
VZ1.....	8-7
VZ10.....	8-7
VZ11.....	8-7
VZ12.....	8-7
VZ13.....	8-7
VZ14.....	8-7
VZ15.....	8-7
VZ16.....	8-7
VZ17.....	8-7
VZ18.....	8-7
VZ2.....	8-7
VZ20.....	8-7
VZ26.....	8-7
VZ27.....	8-7
VZ28.....	8-7
VZ29.....	8-7
VZ3.....	8-7
VZ30.....	8-7
VZ31.....	8-7
VZ4.....	8-7
VZ7.....	8-7
VZ8.....	8-7
VZ9.....	8-7
VZN05.....	8-3
VZN06.....	8-3
VZN08.....	8-3
VZN11.....	8-3
VZN12.....	8-3
VZN14.....	8-3
VZN17.....	8-3
VZN20.....	8-3
VZN26.....	8-3
VZN30.....	8-3

**W**

W808780210111 – W808780220111.....	26-29
WISEREM.....	1-41

WISEREMCTEXT12.....	1-41
WISEREMCTEXT25.....	1-41
WISEREMCTEXT4.....	1-41
WISEREMCTEXT40.....	1-41
WISEREMCTPV.....	1-41
WISEREMPV.....	1-41
WMB361362.....	14-8, 14-13
WMB363364.....	14-8, 14-13
WS363 – WS384.....	14-8

**X**

XA1 – XTE2.....	23-98
XACA009.....	19-134
XACA02H7 – XACA12H7.....	19-133
XACA201 – XACA207.....	19-133
XACA9411 – XACA9419.....	19-134
XACA971 – XACA983.....	19-134
XACB961.....	19-134
XACD21A0101 – XACD21A1241.....	19-133
XACS101 – XACS105.....	19-133
XALACS1 – XALACS2.....	19-114
XALD01H7.....	19-64, 19-107
XALD02H7.....	19-64, 19-107
XALD03H7 – XALD05H7.....	19-107
XALD101H29H7 – XALD351H29H7.....	19-107
XALK01H7.....	19-107
XALK178H7 – XALK198H7.....	19-107
XALZ09.....	19-108
XAPA1100 – XAPA4100.....	19-108
XAPE301 – XAPE905.....	19-109
XAPG19100 – XAPG59400.....	19-108
XAPG19201 – XAPG59505.....	19-109
XAPZ100 – XAPZ316.....	19-108
XARS12D18H – XARSK8L12W.....	19-130
XB4AB1 – XB4AS2.....	19-114
XB4BA21.....	19-8, 19-24
XB4BA25 – XB4BA65.....	19-24
XB4BA3311 – XB4BA4322.....	19-24
XB4BA711237 – XB4BA731327.....	19-24
XB4BA821 – XB4BA962.....	19-31
XB4BC21.....	19-24
XB4BD21.....	19-8, 19-25
XB4BD25 – XB4BG61.....	19-25
XB4BD33.....	19-8, 19-25
XB4BD912R100K.....	19-31
XB4BD912R10K.....	19-31
XB4BD912R1K.....	19-31
XB4BD912R470K.....	19-31
XB4BD912R47K.....	19-31
XB4BD912R4K7.....	19-31
XB4BJ21 – XB4BJ53.....	19-25
XB4BL42.....	19-8, 19-24
XB4BL45.....	19-24
XB4BL73415.....	19-24
XB4BP21 – XB4BP61.....	19-24
XB4BS8442.....	19-25
XB4BS84441.....	19-25
XB4BS8445.....	19-8, 19-25
XB4BS9442.....	19-25
XB4BS9445.....	19-25
XB4BT42.....	19-8
XB4BT842 – XB4BT845.....	19-25
XB4BV31 – XB4BVG6.....	19-26
XB4BVG3.....	19-8, 19-26
XB4BVG4.....	19-8, 19-26
XB4BW11B5 – XB4BW36G5.....	19-26
XB4BW73731B5 – XB4BW73731M5.....	19-24
XB4RFA02.....	19-63
XB4RFB01.....	19-63
XB5A8442.....	19-44
XB5AA21.....	19-8, 19-43
XB5AA25.....	19-43
XB5AA31.....	19-43
XB5AA3311.....	19-43
XB5AA35.....	19-43
XB5AA42.....	19-43
XB5AA4322.....	19-43
XB5AA45 – XB5AA65.....	19-43
XB5AA711237.....	19-43
XB5AA731327.....	19-43

XB5AA831 – XB5AA841	19-51	XB7EV03BP – XB7EV03MP	19-69	XMLZL009 – XMLZL017	22-12
XB5AA84101 – XB5AA84201	19-51	XB7EV08BP – XB7EV08MP	19-69	XMO20 – XMO60	23-94
XB5AA842	19-51	XB7EV68P	19-69	XO00 – XO80	23-94
XB5AA861 – XB5AA862	19-51	XB7EV730P – XB7EV73P	19-69	XO20XL – XO80XL	23-95
XB5AA86102 – XB5AA86202	19-51	XB7EV78P	19-69	XS108B3NAL2 – XS108B3PBM8	20-8
XB5AC21	19-43	XB7NA11	19-68	XS112B3NAL2 – XS112B3PBM12	20-8
XB5AD21	19-8, 19-44	XB7NA3131	19-68	XS118B3NAL2 – XS118B3PBM12	20-8
XB5AD25 – XB5AD53	19-44	XB7ND21 – XB7ND33	19-70	XS130B3NAL2 – XS130B3PBM12	20-8
XB5AD33	19-8, 19-44	XB7NG21 – XB7NG33	19-70	XS506B1NAL2 – XS506B1PBM8	20-7
XB5AD912R100K – XB5AD912R470K	19-51	XB7NH21	19-68	XS508B1NAL2 – XS508B1PBM8	20-7
XB5AD912R10K – XB5AD912R47K	19-51	XB7NH81	19-68	XS512B1NAL2 – XS512B1PBM12	20-7
XB5AD912R1K – XB5AD912R4K7	19-51	XB7NJ08B1 – XB7NJ08M1	19-69	XS518B1NAL2 – XS530B1PBM12	20-7
XB5AG03 – XB5AG61	19-44	XB7NL44	19-68	XS608B1NAL2 – XS608B1PBM12	20-6
XB5AJ21 – XB5AJ53	19-44	XB7NL4534	19-68	XS612B1MAL2 – XS612B1MBU20	20-9
XB5AL42	19-8, 19-43	XB7NS8442 – XB7NS9445	19-70	XS612B1NAL2 – XS612B1PBM12	20-6
XB5AL45	19-43	XB7NT842 – XB7NT845	19-70	XS618B1MAL01B – XS618B1MBL2	20-9
XB5AL73415	19-43	XB7NW33B1 – XB7NW33M1	19-69	XS618B1NAL01B – XS618B1PBM12	20-6
XB5AL84101 – XB5AL84201	19-51	XBFX13	19-41, 19-61	XS630B1MAL01B – XS630B1MBU20	20-9
XB5AP21 – XB5AP61	19-43	XBTGTH2460	27-9	XS630B1NAL01B – XS630B1PBM12	20-6
XB5AS8444 – XB5AS9445	19-44	XBTGTH2460B	27-9	XS7C4A1DPN12 – XS7C4A1MPN12	20-5
XB5AS8445	19-8, 19-44	XBTN200 – XBTN410	27-6	XS8C4A1DPN12 – XS8C4A4PCN12	20-5
XB5AT42	19-8	XBTN410	16-105	XSZB108 – XSZB165	20-7, 20-9
XB5AT842 – XB5AT845	19-44	XBTNU400	27-6	XSZB112 – XSZB130	20-6 – 20-7, 20-9
XB5AV31 – XB5AVM6	19-45	XBTR400 – XBTR411	27-6	XT112S1NAL2 – XT112S1PCM12	20-9
XB5AVG3	19-8, 19-45	XBTRT500 – XBTRT511	27-6	XT118B1NAL2 – XT118B1PCM12	20-9
XB5AVG4	19-8, 19-45	XBTZ938	16-107	XU2M18MA230 – XU2M18MB230K	20-2
XB5AW11B5 – XB5AW16G5	19-45	XBTZGHL10	27-9	XU5M18MA230 – XU9M18MB230K	20-2
XB5AW3135 – XB5AW36G5	19-45	XBTZGHL20	27-9	XUB1APANL2 – XUB1BPBNNM12	20-2
XB5AW73731B5	19-43	XBTZGHL3	27-9	XUB2AKSNL2T – XUB2APBNNM12R	20-2
XB5AW73731G5	19-43	XBTZGJBOX	27-9	XUB2BPANL2R – XUB2BPBNNM12R	20-2
XB5AW73731M5	19-43	XC1S2V03H30	16-94	XUB5APANL2 – XUB5APBNNM12	20-2
XB5DSB	19-51	XC4S2V06H30	16-94	XUB5BPANL2 – XUB5BPBNNM12	20-2
XB5DSG	19-51	XCDR2110N12 – XCDR2527N12	21-15	XUB9APANL2 – XUB9APBNNM12	20-2
XB5DSM	19-51	XCKD2106N12 – XCKD25H0N12	21-14	XUB9BPANL2 – XUB9BPBNNM12	20-2
XB5EVB1 – XB5EVB8	19-45	XCKJ10511H7 – ZCKJ4104H7	21-31	XUDO0012 – XUDO80	23-97
XB5EVG1 – XB5EVG8	19-45	XCKL10011H7 – XCKL10041H7	21-27	XUK1APANL2 – XUK9ARCNL2	20-4
XB5EVM1 – XB5EVM8	19-45	XCKL102H7 – XCKL121H7	21-27	XUVA0505PANM8 – XUVA1515PANM8	20-3
XB5KSB	19-51	XCKL50011H7 – XCKL50041H7	21-27	XUVR0303PANL2 – XUVR1218PBNNM8	20-3
XB5KSG	19-51	XCKL502H7 – XCKL521H7	21-27	XUVU06M3KCNL2	20-10
XB5RFA02	19-63	XCKN2102P20 – XCKN2949P20	21-18	XUVU06M3KSNM8	20-10
XB5RFB01	19-63	XCKP2106N12 – XCKP25H0N12	21-14	XUX0AKSAM12T – XUX9ARCNT16	20-4
XB5RMA04	19-63	XCKS101 – XCKS559	21-19	XUZA118	20-2, 20-10
XB5RMB03	19-63	XCKT2102N12 – XCKT2118N12	21-15	XUZA218	20-2, 20-10
XB5S1B2L2	19-67	XCMD2102L1 – XCMD25F2L1	21-14	XUZZC24	20-2, 20-10
XB5S1B2M12	19-67	XCMN2110L1	21-14	XUZZC50	20-2, 20-10
XB5S2B2L2	19-67	XCNR2102P20 – XCNR2927P20	21-18	XUZZC80	20-2, 20-10
XB5S2B2M12	19-67	XCPR2110N12 – XCPR2527N12	21-15	XVBC00 – XVBC040	19-115
XB5S3B2L2	19-67	XD1S2V03H30	16-94	XVBC12 – XVBC23	19-117
XB5S3B2M12	19-67	XD2S2V03H30	16-94	XVBC21 – XVBC38	19-116
XB5S4B2L2	19-67	XD3S2V06H30	16-94	XVBC4B3 – XVBC4B8	19-116
XB5S4B2M12	19-67	XD4PA12 – XD4PA24	19-31	XVBC4M3 – XVBC4M8	19-116
XB5S5B2L2	19-67	XD4S2V06H30	16-94	XVBC8B3 – XVBC8G8	19-116
XB5S5B2M12	27-11	XD5PA12 – ZB5AD48	19-51	XVBC9B – XVBC9M	19-116
XB6AA11B – XB6AV6GB	19-13	XDO00 – XDO80	23-96	XVBL33 – XVBL38	19-115
XB6AD221B – XB6AD235B	19-14	XDO20XDL – XDO80XDL	23-97	XVBL4B3 – XVBL4M8	19-115
XB6AE1B1B – XB6AE6G5B	19-12	XE1S2V03H30	16-94	XVBL8B3 – XVBL8G8	19-115
XB6AF1B1B – XB6AF6G5B	19-12	XE2NP2151	21-34	XVBZ02 – XVBZ04A	19-117
XB6AGB5B – XB6AGH5B	19-14	XE2SP2151	21-34	XVC1B1K – XVC1M5K	19-118
XB6AW1B1B – XB6AW6G5B	19-12	XE2SP2158	21-34	XVC1B1SK – XVC1M5SK	19-118
XB6CA11B – XB6CV6GB	19-13	XE3S2V06H30	16-94	XVC4B1 – XVC4M5S5	19-118
XB6CD221B – XB6CD235B	19-14	XENG1191 – XENG3791	19-133	XVC6B1 – XVC6B5	19-119
XB6CE1B1B – XB6CE6G5B	19-12	XENP2151	21-28	XVC6B15S – XVC6B5S5	19-119
XB6CF1B1B – XB6CF6G5B	19-12	XESP2021 – XESP2031	21-34	XVC6B15SK – XVC6B55SK	19-119
XB6CGB5B – XB6CGH5B	19-14	XESP2151	21-28	XVC6B1K – XVC6B5K	19-119
XB6CW1B1B – XB6CW6G5B	19-12	XESP2158	21-28	XVC6M1 – XVC6M5	19-119
XB6DA11B – XB6DV6GB	19-13	XF2S2V03H30	16-94	XVC6M15S – XVC6M5S5	19-119
XB6DD221B – XB6DD235B	19-14	XF4S2V06H30	16-94	XVC6M15SK – XVC6M55SK	19-119
XB6DE1B1B – XB6DE6G5B	19-12	XMEP1K0PT130 – XMEP7K5PT730	22-8	XVC6M1K – XVC6M5K	19-119
XB6DGB5B – XB6DGH5B	19-14	XMLA001S2S13 – XMLAM01V2S13	22-14	XVCTL1	19-114
XB6DW1B5B – XB6DW6G5B	19-12	XMLB001S2S13 – XMLBM05A2S13	22-14	XVCZ01 – XVCZ11	19-118
XB6EAA11P – XB6EAV8JP	19-21	XMLC001S2S13 – XMLCM05S2S13	22-14	XVCZ02 – XVCZ12	19-119
XB6EAD221P – XB6EDG232P	19-23	XMLD001S1S13 – XMLDM02V1S13	22-14	XVCZ13 – XVCZ23	19-118, 19-125
XB6EAF1B1P – XB6EAF8J2P	19-22	XMLG001D23 – XMLG025D73	22-4	XVGU3SHAV	19-124
XB6EAW1B1P – XB6EAW8J2P	19-22	XMLG100D23 – XMLG400D73	22-4	XVGU3SWV	19-124
XB6ECA11P – XB6ECA62P	19-21	XMLGM01D23 – XMLGM01D73	22-4	XVLA123 – XVLA335	19-10
XB6ECF1B1P – XB6ECF8J2P	19-22	XMLK006B2C21 – XMLK300P2P73	22-9	XVLX08	19-10
XB6ECV1BP – XB6ECV8JP	19-21	XMLP015RC23F – XMLP100RD73F	22-6	XVLX12	19-10
XB6ECW1B1P – XB6ECW8J2P	19-22	XMLP150PD130 – XMLP6K0PP730	22-7	XVLZ911	19-10
XB6EDA11P – XB6EDA62P	19-21	XMLPM00RC13F – XMLPM60RP23F	22-6	XVLZ912	19-10
XB6EDF1B1P – XB6EDW8J2P	19-22	XMLR0012G2N06 – XMLRM01G2P05	22-11	XVR08B03 – XVR08J06	19-125
XB6EDV1BP – XB6EDV8JP	19-21	XMLZL001 – XMLZL011	22-14	XVR10B03 – XVR10J06	19-125

XVR12B03 – XVR12J06S	19-125
XVR13J04 – XVR13J05	19-125
XVRZ081 – XVRZ082	19-125
XVRZR1 – XVRZR3	19-125
XVS14BMW	19-126
XVST2BMBN – XVST2BMPWP	19-126
XVUC020 – XVUC020Q	19-123
XVUC21B – XVUC21MQP	19-122
XVUC23 – XVUC48	19-121
XVUC9S – XVUC9VP	19-122
XVUZ00 – XVUZ800	19-123
XX2V3A1NFM12 – XX9V3A1H3M12	20-12
XXV18B1NAL2 – XXV18B1PBL2	20-10
XXV18B1NAM12 – XXV18B1PBM12	20-10
XXZPB100	20-10
XXZPM100M12	20-10
XZCC12CFM40B – XZCC12FDM50B	22-12
XZCP0566L2	20-6
XZCP0666L2	20-6
XZCP0941L2	20-2, 20-10
XZCP1041L2	20-2, 20-10
XZCP1141L10	21-32, 22-12
XZCP1141L2	20-2 –20-10, 20-6, 21-32, 22-12
XZCP1141L5	21-32, 22-12
XZCP1241L10 – XZCPV12V12L2	22-12
XZCP1241L2	20-2, 20-6, 20-10, 22-12
XZCP1865L2	20-2, 20-6, 20-10
XZCP1965L2	20-2, 20-6, 20-10
XZCPV0941L2 – XZCPV1965L2	20-10
XZCR1511041C1 – XZCR1512064D2	22-12
<b>Y</b>	
Y1841 – Y1852	21-41
Y1901 – Y1905	21-41
YA060HD	7-55
YA1200R3	7-55
YA1200R5	7-55
YA1200R7	7-55
YA150HD	7-55
YA150JD	7-55
YA2000R3	7-55
YA2000R5	7-55
YA2500R7	7-55
YA250J35	7-55
YA250P3	7-55
YA300P5	7-55
YA400L31K3 – YA400L71K4	7-55
YA400P3	7-55
YA400P7	7-55
YA600L32K3 – YA600L52K4	7-55
YA600P5	7-55
YA800P7	7-55
YP	7-52
YQ	7-52
<b>Z</b>	
ZA2BB2 – ZA2BG5	19-134
ZA2BS834 – ZA2BS944	19-134
ZALVB1 – ZALVB6	19-108
ZALVG1 – ZALVG6	19-108
ZALVM1 – ZALVM6	19-108
ZARB10WS – ZART8LS	19-130
ZARC01 – ZARC18	19-131
ZARC701 – ZARC707	19-131
ZARCFBA01	19-131
ZARCIOT01	19-131
ZB2BE101 – ZB2BE102	19-133
ZB2BV006	19-134
ZB2BY2002 – ZB2BY4101	19-135
ZB2SZ3	19-134
ZB4BA0	19-27
ZB4BA1	19-27
ZB4BA18	19-27, 19-33
ZB4BA2 – ZB4BA435	19-27
ZB4BA38 – ZB4BA68	19-27, 19-33
ZB4BA71115 – ZB4BA71124	19-28
ZB4BA7120	19-28
ZB4BA7121	19-28
ZB4BA72124	19-28
ZB4BA73132 – ZB4BA73135	19-28
ZB4BA7340	19-28
ZB4BA7341	19-28
ZB4BA79	19-28
ZB4BA791	19-28
ZB4BC2 – ZB4BC6	19-29
ZB4BC24 – ZB4BC64	19-29
ZB4BD2 – ZB4BD8	19-30
ZB4BD28 – ZB4BD48	19-31
ZB4BD912 – ZB4BD922	19-31
ZB4BG0 – ZB4BG09	19-30
ZB4BG1 – ZB4BG9	19-30
ZB4BH01 – ZB4BH06	19-28
ZB4BH013 – ZB4BH063	19-33
ZB4BH1 – ZB4BH6	19-28
ZB4BH13 – ZB4BH63	19-33
ZB4BJ2 – ZB4BJ8	19-30
ZB4BK12( )3 – ZB4BK18( )3	19-34
ZB4BL1 – ZB4BL435	19-27
ZB4BL7340	19-28
ZB4BL7341	19-28
ZB4BP1 – ZB4BP68	19-27
ZB4BP1S – ZB4BP6S	19-27
ZB4BPA1 – ZB4BPA6	19-27
ZB4BR2 – ZB4BR6	19-29
ZB4BS12 – ZB4BS964	19-29
ZB4BT2	19-29
ZB4BT84	19-29
ZB4BV01 – ZB4BV07S	19-32
ZB4BV18B1 – ZB4BV18G6	19-32
ZB4BV3	19-32
ZB4BV4	19-32
ZB4BV5	19-32
ZB4BV6	19-32
ZB4BV6120	19-32
ZB4BV624	19-32
ZB4BV8	19-32
ZB4BV9	19-32
ZB4BVB1 – ZB4BVB6	19-32
ZB4BVBG1 – ZB4BVBG6	19-32
ZB4BVG1 – ZB4BVG6	19-32
ZB4BVJ1 – ZB4BVJ6	19-32
ZB4BW031 – ZB4BW081	19-35
ZB4BW0B11 – ZB4BW0G65	19-35
ZB4BW11 – ZB4BW663	19-33
ZB4BW7A1715 – ZB4BW7A3741	19-34
ZB4BW7A9	19-34
ZB4BW7L3740 – ZB4BW7L3741	19-34
ZB4BX2	19-29
ZB4BX84	19-29
ZB4BZ009	19-36, 19-37, 19-64
ZB4BZ021 – ZB4BZ022	19-41
ZB4BZ101 – ZB4BZ141	19-35
ZB4BZ1015 – ZB4BZ1055	19-37, 19-57
ZB4BZ106	19-36, 19-56
ZB4BZ107	19-36, 19-56
ZB4BZ1905	19-41, 19-61
ZB4BZ2005 – ZB4BZ2105	19-41, 19-61
ZB4BZ62 – ZB4BZ64	19-41, 19-61
ZB4BZ905	19-41, 19-61
ZB4RTA1 – ZB4RTA6	19-63
ZB4RTA331	19-63
ZB4RTA432	19-63
ZB4RZA0	19-63
ZB4SZ3	19-41
ZB5AA0 – ZB5AA1	19-46
ZB5AA131 – ZB5AA435	19-47
ZB5AA14 – ZB5AA18	19-46
ZB5AA2 – ZB5AA9	19-46
ZB5AA24 – ZB5AA26	19-46
ZB5AA34 – ZB5AA38	19-46
ZB5AA44 – ZB5AA48	19-46
ZB5AA54 – ZB5AA56	19-46
ZB5AA58	19-46, 19-53
ZB5AA64	19-46
ZB5AA66	19-46
ZB5AA68	19-46, 19-53
ZB5AA71115 – ZB5AA71124	19-48
ZB5AA7120 – ZB5AA7121	19-48
ZB5AA72124	19-48
ZB5AA73132 – ZB5AA73135	19-48
ZB5AA7340 – ZB5AA7341	19-48
ZB5AA791 – ZB5AA791	19-48
ZB5AC2 – ZB5AC6	19-47
ZB5AC24 – ZB5AC64	19-47
ZB5AD2 – ZB5AD8	19-50
ZB5AD912 – ZB5AD922	19-51
ZB5AG0	19-50
ZB5AG02 – ZB5AG09	19-50
ZB5AG1 – ZB5AG9	19-50
ZB5AH01 – ZB5AH06	19-48
ZB5AH013 – ZB5AH063	19-53
ZB5AH1 – ZB5AH6	19-48
ZB5AH13 – ZB5AH63	19-53
ZB5AJ2 – ZB5AJ8	19-50
ZB5AK12( )3 – ZB5AK18( )3	19-54
ZB5AL1 – ZB5AL6	19-46
ZB5AL232 – ZB5AL435	19-47
ZB5AL7340 – ZB5AL7341	19-48
ZB5AP1 – ZB5AP6	19-46
ZB5AP18 – ZB5AP68	19-46
ZB5AP1S – ZB5AP6S	19-46
ZB5APA1 – ZB5APA6	19-46
ZB5AR2 – ZB5AR6	19-47
ZB5AS12 – ZB5AS72	19-49
ZB5AS834 – ZB5AS964	19-49
ZB5AT2	19-49
ZB5AT24	19-49
ZB5AT84	19-49
ZB5AT844	19-49
ZB5AT8643M	19-54
ZB5AV01 – ZB5AV07	19-52
ZB5AV013 – ZB5AV063	19-52
ZB5AV013S – ZB5AV063S	19-52
ZB5AV01S – ZB5AV07S	19-52
ZB5AV18B1 – ZB5AV18G6	19-52
ZB5AV3 – ZB5AV6	19-52
ZB5AV6120	19-52
ZB5AV624	19-52
ZB5AV8 – ZB5AV9	19-52
ZB5AVB1 – ZB5AVB6	19-52
ZB5AVBG1 – ZB5AVBG6	19-52
ZB5AVG1 – ZB5AVG6	19-52
ZB5AVJ1 – ZB5AVJ6	19-52
ZB5AW031 – ZB5AW065	19-55
ZB5AW0B11 – ZB5AW0B65	19-55
ZB5AW0G11 – ZB5AW0G65	19-55
ZB5AW11 – ZB5AW17	19-53
ZB5AW113 – ZB5AW163	19-53
ZB5AW31 – ZB5AW37	19-53
ZB5AW313 – ZB5AW363	19-53
ZB5AW513 – ZB5AW563	19-53
ZB5AW713 – ZB5AW763	19-54
ZB5AW7A1715 – ZB5AW7A3741	19-54
ZB5AW7A9	19-54
ZB5AW7L3740 – ZB5AW7L3741	19-54
ZB5AX2	19-49
ZB5AX84	19-49
ZB5AZ009	19-56, 19-57, 19-64
ZB5AZ021 – ZB5AZ026	19-41
ZB5AZ101 – ZB5AZ141	19-55
ZB5AZ31	19-61
ZB5AZ901	19-61, 19-71, 19-108
ZB5AZ902	19-61, 19-71
ZB5AZ905	19-61, 19-71, 19-108
ZB5CA1 – ZB5CA6	19-46
ZB5CA16 – ZB5CA66	19-46
ZB5CA331 – ZB5CA432	19-47
ZB5CH01 – ZB5CH06	19-48
ZB5CL1 – ZB5CL6	19-46
ZB5CV013 – ZB5CV063	19-52
ZB5CW113 – ZB5CW163	19-53
ZB5CW313 – ZB5CW363	19-53
ZB5RTA1 – ZB5RTA6	19-63
ZB5RTA331	19-63
ZB5RTA432	19-63
ZB5RZA0	19-63
ZB5SZ3	19-41, 19-61, 19-71, 19-108
ZB5SZ5	19-61
ZB5SZ70	19-67
ZB5SZ71	19-67
ZB5SZ72	19-67

ZB6AA1 – ZB6DW9 ..... 19-16  
 ZB6AD22 – ZB6DD28 ..... 19-17  
 ZB6AGA – ZB6DGT ..... 19-18  
 ZB6E1B – ZB6E2E ..... 19-15  
 ZB6EB1B – ZB6EM0B ..... 19-15  
 ZB6Y001 – ZB6Y019 ..... 19-20  
 ZB6Y005 ..... 19-20, 19-23  
 ZB6Y010 – ZB6Y011 ..... 19-15, 19-20  
 ZB6Y2178 – ZB6Y2387 ..... 19-20  
 ZB6Y56 ..... 19-23  
 ZB6Y7001 – ZB6Y7330 ..... 19-13, 19-16, 19-20  
 ZB6Y905 ..... 19-20, 19-23  
 ZB6YA001 ..... 19-20, 19-23  
 ZB6YA002 – ZB6YB028 ..... 19-20  
 ZB6YA100 – ZB6YD626 ..... 19-19  
 ZB6YD001 ..... 19-20, 19-23  
 ZB6YD20 – ZB6YJ012 ..... 19-20  
 ZB6YF01 – ZB6YF05 ..... 19-23  
 ZB6Z1B – ZB6Z5B ..... 19-15  
 ZB6ZB11B – ZB6ZB65B ..... 19-15  
 ZB6ZG11B – ZB6ZG65B ..... 19-15  
 ZB6ZH01B – ZB6ZH05B ..... 19-15  
 ZB7EV01 – ZB7EV08 ..... 19-71  
 ZBA1 – ZBA9 ..... 19-40, 19-60  
 ZBA131 – ZBA141 ..... 19-40, 19-60  
 ZBA232 – ZBA245 ..... 19-40, 19-60  
 ZBA331 – ZBA346 ..... 19-40, 19-60  
 ZBA432 – ZBA435 ..... 19-40, 19-60  
 ZBA639 ..... 19-40, 19-60  
 ZBA708 ..... 19-42, 19-62  
 ZBA709 ..... 19-42, 19-62  
 ZBA71 – ZBA79 ..... 19-41, 19-61, 19-64  
 ZBA710 ..... 19-42, 19-62  
 ZBA7131 – ZBA7138 ..... 19-41, 19-61, 19-64  
 ZBA7232 – ZBA7237 ..... 19-41, 19-61, 19-64  
 ZBA7331 – ZBA7336 ..... 19-41, 19-61, 19-64  
 ZBA7432 ..... 19-41, 19-61, 19-64  
 ZBCV0113 – ZBCV0163 ..... 19-62  
 ZBCW9113 – ZBCW9363 ..... 19-62  
 ZBCY1101 ..... 19-60  
 ZBDD2 ..... 19-42, 19-62  
 ZBE101 – ZBE1026P ..... 19-36, 19-56  
 ZBE1015 – ZBE1025 ..... 19-37, 19-57  
 ZBE201 – ZBE205 ..... 19-36, 19-56  
 ZBG2201 – ZBG4401 ..... 19-31, 19-51  
 ZBG3131A ..... 19-42, 19-62  
 ZBG3131AP ..... 19-42, 19-62  
 ZBG421E ..... 19-42, 19-62  
 ZBG421EP ..... 19-42, 19-62  
 ZBG455 ..... 19-42, 19-62  
 ZBG455P ..... 19-42, 19-62  
 ZBG458A ..... 19-42, 19-62  
 ZBG458AP ..... 19-42, 19-62  
 ZBG520E ..... 19-42, 19-62  
 ZBG520EP ..... 19-42, 19-62  
 ZBL1 – ZBL9 ..... 19-40, 19-60  
 ZBP0A ..... 19-42, 19-62  
 ZBPA ..... 19-42, 19-62  
 ZBRA1 ..... 19-64  
 ZBRACS ..... 19-64  
 ZBRM21 ..... 19-64  
 ZBRM22 ..... 19-64  
 ZBRRA ..... 19-64  
 ZBRRC ..... 19-64  
 ZBRRD ..... 19-64  
 ZBRT1 – ZBRT2 ..... 19-63  
 ZBV011 – ZBV017 ..... 19-42, 19-62  
 ZBV0113 – ZBV0163 ..... 19-42, 19-62  
 ZBV6 ..... 19-36, 19-56  
 ZBVB1 – ZBVBG6 ..... 19-36, 19-56  
 ZBVB15 – ZBVB65 ..... 19-37, 19-57  
 ZBVG1 – ZBVG6 ..... 19-36, 19-56  
 ZBVG15 – ZBVG65 ..... 19-37, 19-57  
 ZBVJ1 – ZBVJ6 ..... 19-36, 19-56  
 ZBVJ15 – ZBVJ65 ..... 19-37, 19-57  
 ZBVM1 – ZBVM6 ..... 19-36, 19-56  
 ZBVM15 – ZBVM65 ..... 19-37, 19-57  
 ZBW911 – ZBW937 ..... 19-42, 19-62  
 ZBW9113 – ZBW9363 ..... 19-42, 19-62  
 ZBY01001 – ZBY01005 ..... 19-39, 19-59  
 ZBY0101 – ZBY0102 ..... 19-39, 19-59

ZBY0101T ..... 19-64, 19-67  
 ZBY02115 – ZBY02931 ..... 19-39, 19-59  
 ZBY05001 – ZBY05005 ..... 19-39, 19-59  
 ZBY1101 – ZBY1149 ..... 19-39, 19-60  
 ZBY1303 – ZBY1316 ..... 19-39, 19-60  
 ZBY1912 ..... 19-39, 19-60  
 ZBY2002 – ZBY2931 ..... 19-38, 19-58  
 ZBY2303 ..... 19-8, 19-38, 19-58  
 ZBY2304 ..... 19-8, 19-38, 19-58  
 ZBY2311 ..... 19-8, 19-38, 19-58  
 ZBY2312 ..... 19-8, 19-38, 19-58  
 ZBY2367 ..... 19-8, 19-38, 19-58  
 ZBY2387 ..... 19-8, 19-38, 19-58  
 ZBY2H101 ..... 19-38, 19-58  
 ZBY4001 ..... 19-38, 19-58  
 ZBY4005 ..... 19-38, 19-58  
 ZBY4101 ..... 19-38, 19-58  
 ZBY4H101 ..... 19-38, 19-58  
 ZBY5101 – ZBY5102 ..... 19-39, 19-59  
 ZBY6101 ..... 19-38, 19-58  
 ZBY6102 ..... 19-38, 19-58  
 ZBY6H101 ..... 19-38, 19-58  
 ZBY6H102 ..... 19-38, 19-58  
 ZBY8101 ..... 19-29, 19-49  
 ZBY8130 – ZBY9630 ..... 19-70  
 ZBY8330 ..... 19-29, 19-49, 19-70  
 ZBY9101T ..... 19-41  
 ZBY9121 ..... 19-29, 19-49  
 ZBY9220 ..... 19-29, 19-49  
 ZBY9320 ..... 19-8, 19-29, 19-49  
 ZBY9330T ..... 19-41  
 ZBY9420 ..... 19-29, 19-49  
 ZBZ1600 – ZBZ1800 ..... 19-41, 19-61  
 ZBZ28 – ZBZ58 ..... 19-42, 19-61  
 ZBZ32 – ZBZ35 ..... 19-38, 19-58  
 ZBZ3605 ..... 19-41, 19-61  
 ZBZ41 ..... 19-41, 19-61  
 ZBZ8 ..... 19-41, 19-61  
 ZCD21 – ZCD39 ..... 21-17  
 ZCD21M12 ..... 21-17  
 ZCDEF12 ..... 21-17  
 ZCDEG11 ..... 21-17  
 ZCDEG13 ..... 21-17  
 ZCDEN12 ..... 21-17  
 ZCDEP16 ..... 21-17  
 ZCDEP20 ..... 21-17  
 ZCE01 – ZCY91 ..... 21-16  
 ZCKD01 – ZCKD59 ..... 21-19  
 ZCKD02 ..... 21-19, 21-28  
 ZCKD06 – ZCKD109 ..... 21-28  
 ZCKE05 – ZCKE67 ..... 21-33  
 ZCKE055 ..... 21-34  
 ZCKE056 ..... 21-34  
 ZCKE06 – ZCKE676 ..... 21-34  
 ZCKG00 ..... 21-28  
 ZCKJ019H7 ..... 21-34  
 ZCKJ01H7 ..... 21-34  
 ZCKJ029H7 ..... 21-34  
 ZCKJ02H7 ..... 21-34  
 ZCKJ04H7 ..... 21-34  
 ZCKJ115H7 ..... 21-32  
 ZCKJ11H7 ..... 21-32  
 ZCKJ15H7 ..... 21-32  
 ZCKJ18H7 ..... 21-32  
 ZCKJ1H7 ..... 21-32  
 ZCKJ215H7 ..... 21-32  
 ZCKJ21H7 ..... 21-32  
 ZCKJ25H7 ..... 21-32  
 ZCKJ28H7 ..... 21-32  
 ZCKJ2H7 ..... 21-32  
 ZCKJ4045H7 ..... 21-32  
 ZCKJ41045H7 ..... 21-32  
 ZCKJ41H7 ..... 21-32  
 ZCKJ4H7 ..... 21-32  
 ZCKJ5H7 ..... 21-32  
 ZCKL18H7 ..... 21-28  
 ZCKL1H7 – ZCKL5H7 ..... 21-28  
 ZCKS7 – ZCKS9 ..... 21-19  
 ZCKY11 – ZCKY91 ..... 21-28, 21-34  
 ZCKY61 ..... 21-34  
 ZCMC21L1 – ZCMC39L5 ..... 21-17

ZCMD21 – ZCMD41 ..... 21-17  
 ZCMD21C12 ..... 21-17  
 ZCMD21M12 ..... 21-17  
 ZCP21 – ZCP39 ..... 21-17  
 ZCP21D44 ..... 21-17  
 ZCP21M12 ..... 21-17  
 ZCPED44 – ZCPEP20 ..... 21-17  
 ZCT21P16 ..... 21-17  
 ZCT25P16 ..... 21-17  
 ZENL1111 – ZENL1121 ..... 19-108  
 ZMLPA2NSH – ZMLPDPSSH ..... 22-11

1

1.5S1F ..... 14-11  
 1.5S1FSS ..... 14-11  
 1.5S43F ..... 14-12  
 1.5S46F ..... 14-12  
 1.5S51F ..... 14-11  
 1.5S7F ..... 14-11  
 1.5S82F ..... 14-12  
 1.5S8F ..... 14-11  
 10285 ..... 7-27  
 10286 ..... 7-27  
 10287 ..... 7-27  
 14210 ..... 7-28  
 14211 ..... 7-28  
 161332 ..... 23-26  
 161342 ..... 23-20  
 161344 ..... 23-26, 23-29  
 161351 ..... 23-26, 23-29  
 10100010 ..... 21-45  
 1003880A ..... 2-2  
 100S3HNV ..... 14-13  
 100SNA ..... 3-13  
 100SNA ..... 7-84 – 7-85  
 100SV1A ..... 14-11  
 100SV43A – 100SV82A ..... 14-12  
 100SV51A ..... 14-11  
 1010004 – 1010006 ..... 21-45  
 10S1F ..... 14-11  
 10S1FSS ..... 14-11  
 10S40F ..... 14-11  
 10S40FSS ..... 14-11  
 10S4F ..... 14-11  
 10S4FSS ..... 14-11  
 10S60F ..... 14-11  
 10S61F ..... 14-11  
 10S67F ..... 14-12  
 112T3HNV ..... 14-13  
 150SV1A ..... 14-11  
 150SV43A – 150SV82A ..... 14-12  
 150SV51A ..... 14-11  
 150T3HNV ..... 14-13  
 155DE175 ..... 11-21, 11-27  
 155DE200 ..... 11-21, 11-27  
 15S1F ..... 14-11  
 15S1FSS ..... 14-11  
 15S3HNV ..... 14-13  
 15S40F ..... 14-11  
 15S40FSS ..... 14-11  
 15S4F ..... 14-11  
 15S4FSS ..... 14-11  
 15SM5010 – 15SM5400 ..... 11-28  
 15T2F ..... 14-11  
 15T3HNV ..... 14-13  
 15T75F ..... 14-11  
 16700DIN ..... 23-16 – 23-108  
 16700ST1 – 16782PC1 ..... 23-16, 23-20  
 16750/782FT1 ..... 23-108  
 16750/788CBJ1 ..... 23-26, 23-29, 23-108  
 16750/788FT1 ..... 23-26, 23-29  
 16781C – 16781SC ..... 23-18  
 16782C ..... 23-15, 23-19  
 16782C1 ..... 23-15, 23-19  
 16782CBJ1 – 16782SC ..... 23-16  
 16782IDC ..... 23-20  
 16783C1 ..... 23-21, 23-23  
 16783IDC – 16783SC ..... 23-22  
 16784C ..... 23-23  
 16784IDC ..... 23-23



16784SC	23-23
16DCLIP1	23-16, 23-20, 23-22 – 23-23, 23-26, 23-29, 23-106, 23-108
16TDR782SC	23-106
16TDRPROSC	23-108
175DE010 – 175DE150	11-21, 11-27
199ABX14 – 199X8	23-48
1S1F	14-11
1S1FSS	14-11
1S43F – 1S82F	14-12
1S51F	14-11
1S51FSS	14-11
1S7F	14-11
1S8F	14-11
<b>2</b>	
26970	7-28
26975	7-28
26976	7-28
26978	7-28
26981	7-28
27046	7-28
27047	7-28
27048	7-28
27062	7-28
29007	1-37, 2-7, 2-21
29287	7-58
29370	18-40
2540902240	19-81
2550101020	19-11, 19-91, 19-100
2920910001	1-37, 2-3, 2-7, 2-21
2941101100	19-100
225SNA	3-13
225SNA	7-84 – 7-85
225T3HNV	14-13
2358C22G2 – 2358C6G3	21-38
250SV1B	14-11
250SV43B – 250SV82B	14-12
250SV51B	14-11
2510FF1 – 2510FF74P	16-4
2510FG02 – 2510FGJ6P	16-4
2510FK1	16-11
2510FL1	16-11
2510FN1 – 2510FN45	16-11
2510FO1 – 2510FO4P	16-4
2510FR1	16-4
2510FR2	16-4
2510FS1 – 2510FSJ4P	16-4
2510FW1 – 2510FW2P	16-4
2510KF1 – 2510KW6C	16-5
2510MBA1 – 2510MCW5	16-8
2510MBO1	16-8 – 16-9
2510MCO1	16-8 – 16-9
2510PB1	16-11
2510TBG1 – 2510TCO5	16-8
2510TBO1	16-8 – 16-9
2510TCG1	16-8 – 16-9
2510TCO1	16-8 – 16-9
2511KF11	16-5
2511KF22	16-5
2511KG11 – 2511KG22C	16-5
2511MBG1	16-9
2511MCG1	16-9
2512FF11 – 2512FF11P	16-4
2512FG11 – 2512FG22P	16-4
2512FS101P – 2512FS202P	16-4
2512KF11A – 2512KF22C	16-5
2512TBG1	16-9
2550101002 – 2550101037	19-91
2550101003 – 2550105014	19-100
2550101024 – 2550101040	19-11
25S1F	14-11
25S1FSS	14-11
25S40F	14-11
25S40FSS	14-11
25S4F	14-11
25S4FSS	14-11
29008W	1-37
29008W	2-3, 2-7, 2-21
2934D14G1 – 2934D34G1	21-43

2S1F	14-11
2S1FSS	14-11
2S43F – 2S82F	14-12
2S51F	14-11
2S51FSS	14-11
2S7F	14-11
2S8F	14-11
<b>3</b>	
32521	7-58
32556	7-52
32570	7-52
32595	7-57
33106	7-63
3010215901	16-80
3105206750	19-81
3105211101	19-81
3110112001	19-111
3020E083	4-21
3020E084	4-21
3020E164	4-21
3020E244	4-21
300T3HNV	14-13
300XB – 300XBXC124D	23-56
3020B012	4-21
3020B032	4-21
3020B043	4-21
3020B083	4-21
3020B084	4-21
3020B164	4-21
3020B244	4-21
3020E012 – 3020E043	4-21
30502W485C	4-21
3050EMBK3	4-21
3090SCCT022	4-21
3090SCCT032	4-21
3090SCCT043	4-21
3090SCCT063	4-21
3090SCCT083	4-21
3090SCCT084	4-21
3090SCCT124	4-21
3090SCCT164	4-21
30T2F	14-11
30T3HNV	14-13
30T75F	14-11
3105204101 – 3105205901	19-100
3105217001 – 3105406401	19-100
31085-381-50	16-11
3110451250 – 3112350156	16-124
37S3HNV	14-13
389FHXX	23-54
389FXAX – 389FXHX	23-54
389FXBXC12D – 389FXBXC1240A	23-53
389FXCXC12D – 389FXHXC1240A	23-53
3PDT	23-38
3S1F	14-11
3S1FSS	14-11
3S40F	14-11
3S40FSS	14-11
3S43F – 3S82F	14-12
3S4F	14-11
3S4FSS	14-11
3T2F	14-11
3T5F	14-11
<b>4</b>	
400SN	7-84 – 7-85
405WBAF010 – 415WBAF400	11-28
4458D20X3	19-100
4487D63XI	19-100
45T3HNV	14-13
490NAD91103	16-107
490NAD91104	16-107
490NAD91105	16-107
490NTW00002U – 490NTW00080U	16-107
4X1.5S1FSS	14-11
4X10S1FSS	14-11
4X10S40FSS	14-11
4X15S1FSS	14-11

4X15S40FSS	14-11
4X15T2FSS	14-11
4X1S1FSS	14-11
4X2S51FSS	14-11
4X2S540FSS	14-11
4X2S1FSS	14-11
4X30T2FSS	14-11
4X3S1FSS	14-11
4X3S40FSS	14-11
4X3T2FSS	14-11
4X5S1FSS	14-11
4X5S40FSS	14-11
4X6T2FSS	14-11
4X7S1FSS	14-11
4X7S40FSS	14-11
4X9T2FSS	14-11
<b>5</b>	
50437	16-106
50438	16-106
50439	16-106
50440	16-106
50441	16-106
50442	16-106
50485	16-106
50486	16-106
515608	12-3, 12-11
515614	12-3, 12-11
500SV1B	14-11
500SV43B – 500SV82B	14-12
500SV51B	14-11
50S3HNV	14-13
50SV1A	14-11
50SV43A	14-12
50SV46A	14-12
50SV51A	14-11
50SV82A	14-12
55DE010 – 55DE175	11-21, 11-27
55DE200 – 55DE450	11-21 – 11-22, 11-27
5GS010 – 5GS200	11-11
5GS065	11-11 – 11-12
5J	1-37, 2-7, 2-21
5S1F	14-11
5S1FSS	14-11
5S40F	14-11
5S40FSS	14-11
5S4F	14-11
5S4FSS	14-11
5S67F	14-12
5SM5010 – 5SM5400	11-28
<b>6</b>	
60488	7-27
64274	7-72
65346	7-72
65347	7-72
65348	7-72
65349	7-72
65356	7-72
65357	7-72
685831	7-62
6508804101	19-100
6512232801	19-81
6515802701	19-100
6( )XXTZBDC3	23-80
62( )AXXSZSDC3	23-79
6210AXXSZSAC90	23-79
6210AXXSZSDC3	23-79
6210BXXTZBDC3	23-79
6225AXXSZSAC90	23-79
6225AXXSZSDC3	23-79
6240AXXSZSAC90	23-79
6240AXXSZSDC3	23-79
6250AXXSZSAC90	23-79
6250AXXSZSDC3	23-79
6275AXXSZSAC90	23-79
6275AXXSZSDC3	23-79
63( )AXXMDSDC3	23-80
6312AXXMDSDC3	23-79

6325AXXMDSDC3..... 23-79  
 6340AXXMDSDC3..... 23-79  
 6382G3MODEM..... 9-41  
 6382RS485G3KIT..... 9-41  
 64( )AXXSZSAC90..... 23-79  
 64( )AXXSZSDC3..... 23-79  
 6410AXXSZSAC90..... 23-79  
 6425AXXSZSAC90..... 23-79  
 6425AXXSZSDC3..... 23-79  
 6425AXXTZBDC3..... 23-79  
 6425BXXTZBDC3..... 23-79  
 6440AXXSZSAC90..... 23-79  
 6440AXXSZSDC3..... 23-79  
 6450AXXSZSAC90..... 23-79  
 6450AXXSZSDC3..... 23-79  
 6475AXXSZSAC90..... 23-79  
 6475AXXSZSDC3..... 23-79  
 6508805201 – 6508805216..... 19-91  
 6508805207 – 6508805209..... 19-11  
 6509701801 – 6509705001..... 19-100  
 6512231201 – 6512243201..... 19-100  
 6516002379 – 6516002382..... 19-135  
 6T2F..... 14-11  
 6T5F..... 14-11

7

701242..... 23-29 – 23-30  
 701691..... 23-25, 23-31, 23-67, 23-108  
 701701..... 23-25, 23-31, 23-67, 23-108  
 701781..... 23-29, 23-32  
 701782..... 23-29, 23-32  
 703781..... 23-15, 23-33, 23-106  
 703791..... 23-15, 23-33, 23-106  
 704611..... 23-15, 23-36, 23-106  
 704631..... 23-29, 23-36  
 704641..... 23-25, 23-67, 23-108  
 704651..... 23-25, 23-67, 23-108  
 70750E81..... 23-25, 23-40, 23-67, 23-108  
 70750E111..... 23-25, 23-40, 23-67, 23-108  
 70782E141..... 23-15, 23-44, 23-106  
 704011 – 704591..... 23-19, 23-34  
 70750DL111..... 23-25, 23-39, 23-67, 23-108  
 70750DL81..... 23-25, 23-39, 23-67, 23-108  
 70750EL111..... 23-25, 23-41  
 70750EL81..... 23-25, 23-41  
 70781D5R1A..... 23-18, 23-42  
 70781T1..... 23-18, 23-42  
 70782D141..... 23-15, 23-43, 23-106  
 70782D81A..... 23-19, 23-43  
 70782EL141..... 23-15, 23-45, 23-106  
 70782EL81..... 23-15, 23-44, 23-106  
 70783D111A..... 23-21, 23-46  
 70784D141..... 23-23, 23-46  
 70788EL111..... 23-29, 23-47  
 70ASMD250..... 23-22 – 23-23, 23-26, 23-29  
 70ASMLG110/240..... 23-22 – 23-23, 23-26, 23-29  
 70ASMM24..... 23-22 – 23-23, 23-26, 23-29  
 70ASMR110/240..... 23-22 – 23-23, 23-26, 23-29  
 70BSMD250 – 70BSMM240..... 23-16, 23-18, 23-20  
 70S201A – 70S206C..... 23-85  
 725AXX – 725AXXSC3ML24A..... 23-51  
 725BXX – 725BXXSC3ML24D..... 23-51  
 7400CMB17K..... 14-8  
 7400CMB18K20K..... 14-8  
 7400CMB19K – 7400CMB22K..... 14-8  
 7400DS17K – 7400DS31J..... 14-8  
 7400ENT11..... 14-12  
 7400ENT13..... 14-12  
 7400WMB18K20K..... 14-8  
 7400WMB19K..... 14-8  
 7400WS17K – 7400WS31J..... 14-8  
 750SV1F..... 14-11  
 750SV43F – 750SV82F..... 14-12  
 750SV51F..... 14-11  
 750XBXH – 750XBXH240A..... 23-66  
 750XBXR – 750XBXRM4L6D..... 23-24  
 750XCXH – 750XCXH240A..... 23-66  
 750XCXR – 750XCXRM4L48D..... 23-24  
 75S3HNV..... 14-13  
 75T3HNV..... 14-13

781XAXRC110D – 781XAXRM4L48D..... 23-16  
 782XBXC12A – 782XBXC48D..... 23-19  
 782XBXC6A – 782XBXC6D..... 23-19  
 782XBXM4L12A – 782XBXM4L110D..... 23-19  
 783XCXC12A – 783XCXC4L240A..... 23-21  
 783CXM4L12A – 783CXM4L240A..... 23-21  
 784DXC110D – 784DXM4L48D..... 23-22  
 788XBXR – 788XBXRM4L48D..... 23-27  
 788XCXR – 788XCXRM4L48D..... 23-27  
 792XBX – 792DXM4L48D..... 23-14  
 7A1 – 7A1N..... 21-9  
 7A2 – 7A7N..... 21-9  
 7B1N..... 21-9  
 7B2 – 7B4N..... 21-9  
 7D – 7DN..... 21-9  
 7F1N – 7F4N..... 21-9  
 7J1N – 7J4N..... 21-9  
 7N..... 21-9  
 7S – 7S1FSS..... 21-9  
 7S40F – 7S40FSS..... 14-11  
 7S4F – 7S4FSS..... 14-11  
 7S67F..... 14-12

8

82254..... 3-33, 3-26  
 82344..... 3-27, 3-33  
 82354..... 3-33, 3-26  
 82444..... 3-27, 3-33  
 82454..... 3-33, 3-26  
 84956..... 7-61  
 84957..... 7-61  
 8011010401..... 9-21  
 8011010501..... 9-21  
 82254NW..... 3-33  
 82344DS..... 3-27, 3-33  
 82344RB..... 3-27, 3-33  
 82444DS..... 3-27, 3-33  
 82444R..... 3-27, 3-33  
 82454R..... 3-26, 3-33  
 8501CDO15V50 – 8501CDO8V60..... 23-65  
 8501CDPDT..... 19-114  
 8501CDPST..... 19-114  
 8501CO15V04 – 8501CO22V36..... 23-65  
 8501CO6V04 – 8501CO6V36..... 23-65  
 8501CO7V04 – 8501CO7V36..... 23-65  
 8501CO8V04 – 8501CO8V36..... 23-65  
 8501CSPST..... 19-114  
 8501KFDR12V51 – 8501KFDR13V60..... 23-60  
 8501KFR12V14 – 8501KFR13V24..... 23-60  
 8501KPDR12P14V51 – 8501KPDR13V60..... 23-60  
 8501KPR12P14V14 – 8501KPR13V24..... 23-60  
 8501KUDR12P14V51 – 8501KUDR13V60..... 23-60  
 8501KUR12P14V14 – 8501KUR13V24..... 23-60  
 8501NH42..... 23-62  
 8501NH52..... 23-61  
 8501NH7..... 23-61, 23-110  
 8501NH82..... 23-61  
 8501NR34 – 8501NR43..... 23-62  
 8501NR34B – 8501NR43B..... 23-62  
 8501NR45 – 8501NR45B..... 23-64  
 8501NR51 – 8501NR62..... 23-60, 23-110  
 8501NR51B – 8501NR62B..... 23-60, 23-110  
 8501NR82..... 23-60  
 8501NR82B..... 23-60 – 23-61  
 8501RS14P14V14 – 8501RS14V24..... 23-63  
 8501RS24P14V14 – 8501RS24V24..... 23-63  
 8501RS34V14 – 8501RS34V36..... 23-63  
 8501RS41P14V14 – 8501RS44V36..... 23-62  
 8501RSD14P14V51 – 8501RSD14V60..... 23-63  
 8501RSD24P14V51 – 8501RSD24V60..... 23-63  
 8501RSD34V50 – 8501RSD34V60..... 23-63  
 8501RSD41P14V51 – 8501RSD41V60..... 23-62  
 8501RSD42P14V51 – 8501RSD42V60..... 23-62  
 8501RSD43P14V51 – 8501RSD43V60..... 23-62  
 8501RSD44P14V51 – 8501RSD44V60..... 23-62  
 8501XO11..... 16-81  
 8502SAG11( )..... 16-31, 16-35  
 8502SAG12( ) – 8502SHW2( )..... 16-29  
 8502SAO11( )..... 16-31, 16-35  
 8502SBA1( )..... 16-32, 16-36, 16-61, 16-63

8502SBA2( )..... 16-30, 16-61, 16-63  
 8502SBA3( )..... 16-32, 16-36, 16-61, 16-63  
 8502SBA4( )..... 16-32, 16-60  
 8502SBA5( )..... 16-32, 16-61, 16-63  
 8502SBG1( )..... 16-31, 16-35, 16-61, 16-63  
 8502SBG2( )..... 16-29, 16-61, 16-63  
 8502SBG3( )..... 16-31, 16-35, 16-61, 16-63  
 8502SBG4( )..... 16-31, 16-60  
 8502SBG5( )..... 16-61, 16-63  
 8502SBO1( )..... 16-31, 16-35, 16-61, 16-63  
 8502SBO2( )..... 16-29, 16-61, 16-63  
 8502SBO3( )..... 16-31, 16-35, 16-61, 16-63  
 8502SBO4( )..... 16-31, 16-60  
 8502SBO5( )..... 16-31, 16-61, 16-63  
 8502SBR1( )..... 16-32, 16-36  
 8502SBR2( )..... 16-30  
 8502SBR3( )..... 16-32, 16-36  
 8502SBR5( ) – 8502SFT41( )..... 16-32  
 8502SBT1( )..... 16-32, 16-36  
 8502SBT2( )..... 16-30  
 8502SBT3( )..... 16-32, 16-36  
 8502SBT42( )..... 16-30  
 8502SBW11( )..... 16-31, 16-35, 16-61, 16-63  
 8502SBW12( )..... 16-29, 16-61, 16-63  
 8502SBW13( )..... 16-31, 16-35, 16-61, 16-63  
 8502SBW14( )..... 16-31, 16-60  
 8502SBW15( )..... 16-31, 16-61, 16-63  
 8502SBW21( )..... 16-32, 16-35  
 8502SBW22( )..... 16-30  
 8502SBW23( )..... 16-32, 16-35  
 8502SCA1( )..... 16-32, 16-36, 16-61, 16-63  
 8502SCA2( )..... 16-30, 16-36, 16-61, 16-63  
 8502SCA3( )..... 16-32, 16-61, 16-63  
 8502SCA4( )..... 16-32, 16-36, 16-60  
 8502SCA5( )..... 16-32, 16-61, 16-63  
 8502SCG1( )..... 16-31, 16-35  
 8502SCG2( )..... 16-29, 16-35, 16-61, 16-63  
 8502SCG3( ) – 8502SCG5( )..... 16-31  
 8502SCG4( )..... 16-31, 16-35, 16-61, 16-63  
 8502SCO1( )..... 16-31, 16-35, 16-61, 16-63  
 8502SCO2( )..... 16-29, 16-35, 16-61, 16-63  
 8502SCO3( )..... 16-31, 16-61, 16-63  
 8502SCO4( )..... 16-31, 16-35, 16-61, 16-63  
 8502SCO5( )..... 16-31, 16-61, 16-63  
 8502SCR1( )..... 16-32, 16-36  
 8502SCR2( )..... 16-30, 16-36  
 8502SCT1( )..... 16-32, 16-36  
 8502SCT2( )..... 16-30, 16-36  
 8502SCT42( )..... 16-30  
 8502SCW11( )..... 16-31, 16-35, 16-61, 16-63  
 8502SCW12( )..... 16-29, 16-35, 16-61, 16-63  
 8502SCW13( )..... 16-31, 16-61, 16-63  
 8502SCW14( )..... 16-31, 16-35, 16-60  
 8502SCW15( )..... 16-31, 16-61, 16-63  
 8502SCW21( )..... 16-32, 16-35  
 8502SCW22( )..... 16-30, 16-35  
 8502SDA1( )..... 16-32, 16-60  
 8502SDA2( )..... 16-30, 16-36, 16-61, 16-63  
 8502SDG1( ) – 8502SDW14( )..... 16-31  
 8502SDG2( )..... 16-29, 16-35, 16-60  
 8502SDG4( )..... 16-31, 16-61, 16-63  
 8502SDO1( )..... 16-31, 16-60  
 8502SDO2( )..... 16-29, 16-35, 16-60  
 8502SDO4( )..... 16-31, 16-61, 16-63  
 8502SDR2( )..... 16-30, 16-36  
 8502SDR3( )..... 16-32, 16-60  
 8502SDT2( )..... 16-30, 16-36  
 8502SDT42( )..... 16-30  
 8502SDW11( )..... 16-31, 16-60  
 8502SDW12( )..... 16-29, 16-35, 16-61, 16-63  
 8502SDW22( )..... 16-30, 16-35  
 8502SEA1( )..... 16-32, 16-60  
 8502SEA2( )..... 16-30, 16-36, 16-61, 16-63  
 8502SEG1( ) – 8502SEW14( )..... 16-31  
 8502SEG2( )..... 16-29, 16-35, 16-60  
 8502SEG4( )..... 16-31, 16-61, 16-63  
 8502SEO1( )..... 16-31, 16-60  
 8502SEO2( )..... 16-29, 16-35, 16-60  
 8502SEO4( )..... 16-31, 16-61, 16-63  
 8502SER2( )..... 16-30, 16-36  
 8502SET42( )..... 16-30

8502SEW11( )	16-31, 16-60	8536SFG1( )H30	16-33, 16-54, 16-70	8538SCA11( )H30	16-48, 16-68
8502SEW12( )	16-29, 16-35, 16-61, 16-63	8536SFO1( )H30	16-33, 16-62	8538SCA11S8( )H30	16-50
8502SEW22( )	16-30	8536SFW11( )H30	16-33, 16-62, 16-68, 16-70	8538SCA12( )H30	16-67
8502SFA1( )	16-32, 16-60	8536SFA1( )H30	16-34, 16-62, 16-67	8538SCA12S1( )H30	16-50
8502SFA2( )	16-30, 16-36, 16-61, 16-63	8536SGO1( )H30	16-33, 16-62	8538SCA12S8( )H30	16-50
8502SFG1( ) – 8502SFW14( )	16-31	8536SGW11( )H30	16-33, 16-48, 16-62, 16-68	8538SCA13( )H30	16-67, 16-71
8502SFG2( )	16-29, 16-35	8536SJG2( )H30	16-33, 16-55	8538SCA13S1( )H30	16-50
8502SFG3( )	16-31, 16-60	8536SJW2( )H30	16-33, 16-55	8538SCA13S8( )H30	16-50
8502SFG4( )	16-31, 16-61, 16-63	8538SBA11( )H30	16-48, 16-71	8538SCA14( )H30	16-47, 16-67
8502SFO1( )	16-31, 16-60	8538SBA11S8( )H30	16-50	8538SCA14S1( )H30	16-50
8502SFO2( )	16-29, 16-35	8538SBA12( )H30	16-67	8538SCA14S8( )H30	16-50
8502SFO3( )	16-31, 16-60	8538SBA12S8( )H30	16-50	8538SCA21( )H30	16-48, 16-68
8502SFO4( )	16-31, 16-61, 16-63	8538SBA13( )H30	16-47, 16-54, 16-67, 16-70	8538SCA21S8( )H30	16-50
8502SFR2( )	16-30	8538SBA13S8( )H30	16-50	8538SCA22( )H30	16-67
8502SFT42( )	16-30	8538SBA21( )H30	16-48, 16-68	8538SCA22S1( )H30	16-50
8502SFW11( )	16-31, 16-60	8538SBA21S8( )H30	16-50	8538SCA22S8( )H30	16-50
8502SFW12( )	16-29, 16-35, 16-61, 16-63	8538SBA22( )H30	16-67	8538SCA23( )H30	16-67
8502SFW22( )	16-30	8538SBA22S8( )H30	16-50	8538SCA23S1( )H30	16-50
8502SGA1( )	16-32, 16-60	8538SBA23( )H30	16-47, 16-67	8538SCA23S8( )H30	16-50
8502SGA2( )	16-30	8538SBA23S8( )H30	16-50	8538SCA24( )H30	16-47, 16-67
8502SGG1( )	16-31	8538SBA32( )H30	16-49, 16-68	8538SCA24S1( )H30	16-50
8502SGO1( )	16-31, 16-60	8538SBA32S8( )H30	16-50	8538SCA24S8( )H30	16-50
8502SGW11( )	16-31, 16-60	8538SBA33( )H30	16-49, 16-68	8538SCA32( )H30	16-49, 16-68
8502SHA1( )	16-32, 16-60	8538SBA33S8( )H30	16-50	8538SCA32S8( )H30	16-50
8502SHA2( )	16-30	8538SBA42( )H30	16-49, 16-68	8538SCA33( )H30	16-49, 16-68
8502SHG1( )	16-31, 16-60	8538SBA42S8( )H30	16-50	8538SCA33S8( )H30	16-50
8502SHO1( )	16-31, 16-60	8538SBA43( )H30	16-49, 16-51 – 52, 16-68 – 69	8538SCA34( )H30	16-49, 16-68
8502SHW1( )	16-31, 16-60	8538SBA43S8( )H30	16-50	8538SCA34S8( )H30	16-50
8502SJA1( )	16-32, 16-60, 16-75	8538SBA61V02	16-48	8538SCA42( )H30	16-49, 16-68
8502SJA2( )	16-30, 16-75	8538SBA61V03	16-48	8538SCA43( )H30	16-49, 16-68
8502SJG1( )	16-31, 16-60, 16-75	8538SBA62V02	16-47	8538SCA43S8( )H30	16-50
8502SJG2( )	16-29, 16-75	8538SBA62V03	16-47	8538SCA44( )H30	16-51
8502SJO1( )	16-31, 16-60, 16-75	8538SBA63V02	16-49	8538SCA44S8( )H30	16-50
8502SJO2( )	16-29, 16-75	8538SBA63V03	16-49	8538SCA61V02	16-48
8502SJW1( )	16-31, 16-60, 16-75	8538SBA64V02	16-48	8538SCA61V03	16-48
8502SJW2( )	16-29, 16-75	8538SBA64V03	16-48	8538SCA62V02	16-47
8536SAG12( )H30 – 8536SJO2( )H30	16-33	8538SBA65V02	16-47	8538SCA62V03	16-47
8536SAG13( ) – 8536SAG15( )	16-63	8538SBA65V03	16-47	8538SCA63V02	16-49
8536SAG16( )H30	16-62	8538SBA66V02	16-49	8538SCA63V03	16-49
8536SBA2( )H30 – 8536SJA2( )H30	16-34	8538SBA66V03	16-49	8538SCA64V02	16-48
8536SBT41	16-36	8538SBG11( )H30	16-48, 16-68	8538SCA64V03	16-48
8536SBTO2( )	16-37	8538SBG11S8( )H30	16-50	8538SCA65V02	16-47
8536SBW12( )H30 – 8536SBW22( )H30	16-67	8538SBG12( )H30	16-47	8538SCA65V03	16-47
8536SCA3( )H30	16-71	8538SBG12S8( )H30	16-50	8538SCA66V02	16-49
8536SCG3( )H30	16-33, 16-55, 16-71	8538SBG13( )H30	16-47, 16-67	8538SCA66V03	16-49
8536SCR4( )	16-36	8538SBG13S8( )H30	16-50	8538SCASP4	16-46
8536SCT4( )	16-36	8538SBG32( )H30	16-49, 16-68	8538SCASP5	16-46
8536SCT41	16-36	8538SBG32S8( )H30	16-50	8538SCASP6	16-46
8536SCT42	16-36	8538SBG33( )H30	16-49, 16-68	8538SCG11( )H30	16-48, 16-68
8536SCTO3( )	16-37	8538SBG33S8( )H30	16-50	8538SCG11S8( )H30	16-50
8536SCW13( )H30	16-67, 16-71	8538SBG61V02	16-48	8538SCG12( )H30	16-47
8536SCW23( )H30	16-67	8538SBG61V03	16-48	8538SCG12S8( )H30	16-50
8536SCW24( )	16-35	8538SBG62V02	16-47	8538SCG13( )H30	16-47
8536SDA1( )H30	16-71	8538SBG62V03	16-47	8538SCG13S8( )H30	16-50
8536SDA6( )	16-36	8538SBG63V02	16-49	8538SCG14( )H30	16-47, 16-67
8536SDG1( )H30	16-33, 16-54 – 16-55, 16-70 – 16-71	8538SBG63V03	16-49	8538SCG14S8( )H30	16-50
8536SDG6( )	16-35	8538SBW11( )H30	16-48, 16-54, 16-68, 16-70	8538SCG32( )H30	16-49, 16-68
8536SDH8( )	16-37	8538SBW11S8( )H30	16-50	8538SCG32S8( )H30	16-50
8536SDO1( )H30	16-33, 16-62	8538SBW12S8( )H30	16-50	8538SCG33( )H30	16-49, 16-68
8536SDO6( )	16-35	8538SBW13( )H30	16-47, 16-54, 16-67, 16-70	8538SCG33S8( )H30	16-50
8536SDO8( )	16-37	8538SBW13S8( )H30	16-50	8538SCG34( )H30	16-49, 16-68
8536SDR6( )	16-36	8538SBW21( )H30	16-48, 16-68	8538SCG34S8( )H30	16-50
8536SDT46	16-36	8538SBW23( )H30	16-47, 16-67	8538SCG61V02	16-48
8536SDT6( )	16-36	8538SBW32( )H30	16-49, 16-68	8538SCG61V03	16-48
8536SDTO1( )	16-37	8538SBW32S8( )H30	16-50	8538SCG62V02	16-47
8536SDW11( )H30	16-48, 16-71	8538SBW33( )H30	16-49, 16-68	8538SCG62V03	16-47
8536SDW16( )	16-35	8538SBW33S8( )H30	16-50	8538SCG63V02	16-49
8536SDW21( )H30	16-48	8538SBW42( )H30	16-49, 16-68	8538SCG63V03	16-49
8536SDW26( )	16-35	8538SBW43( )H30	16-49, 16-51 – 16-52, 16-68 – 16-69	8538SCW11( )H30	16-48, 16-68
8536SEA1( )H30	16-34, 16-54, 16-62, 16-70	8538SBW61V02	16-48	8538SCW11S8( )H30	16-50
8536SEA6( )	16-37	8538SBW61V03	16-48	8538SCW12( )H30	16-67
8536SEG1( )H30	16-33, 16-54, 16-70	8538SBW62V02	16-47	8538SCW12S8( )H30	16-50
8536SEG6( )	16-37	8538SBW62V03	16-47	8538SCW13S8( )H30	16-50
8536SEH6( )	16-37	8538SBW63V02	16-49	8538SCW14( )H30	16-47, 16-62, 16-67
8536SEO1( )H30	16-33, 16-62	8538SBW63V03	16-49	8538SCW14S8( )H30	16-50
8536SEO6( )	16-37	8538SBW64V02	16-48	8538SCW21( )H30	16-48, 16-68
8536SEW11( )H30	16-33, 16-48, 16-54, 16-62	8538SBW64V03	16-48	8538SCW22( )H30	16-67
8536SEW16( )	16-37	8538SBW65V02	16-47	8538SCW24( )H30	16-47, 16-67
8536SEW21( )H30	16-33, 16-48	8538SBW65V03	16-47	8538SCW32( )H30	16-49, 16-68
8536SEW26( )	16-37	8538SBW66V02	16-49	8538SCW32S8( )H30	16-50
8536SFA1( )H30	16-34, 16-54, 16-62, 16-70	8538SBW66V03	16-49	8538SCW33( )H30	16-49, 16-68

8538SCW33S8( )H30	16-50	8538SDW11( )H30	16-33, 16-48, 16-54, 16-62	8538SFW33( )H30	16-49, 16-68
8538SCW34( )H30	16-49, 16-68	8538SDW11S8( )H30	16-50	8538SFW35( )H30	16-49, 16-68
8538SCW34S8( )H30	16-50	8538SDW12( )H30	16-67	8538SGA11( )H30	16-48, 16-68
8538SCW42( )H30	16-49, 16-68	8538SDW12S8( )H30	16-50	8538SGA13( )H30	16-47, 16-67
8538SCW43( )H30	16-49, 16-68	8538SDW14( )H30	16-47, 16-67	8538SGA15( )H30	16-47, 16-67
8538SCW44( )H30	16-51	8538SDW14S8( )H30	16-50	8538SGA21( )H30	16-48, 16-68
8538SCW61V02	16-48	8538SDW16( )H301	16-47, 16-67	8538SGA23( )H30	16-47, 16-67
8538SCW61V03	16-48	8538SDW16S8( )H301	16-50	8538SGA25( )H30	16-47, 16-67
8538SCW62V02	16-47	8538SDW21( )H30	16-33, 16-48, 16-68	8538SGA33( )H30	16-49, 16-68
8538SCW62V03	16-47	8538SDW22( )H30	16-67	8538SGA35( )H30	16-49, 16-68
8538SCW63V02	16-49	8538SDW24( )H30	16-47, 16-67	8538SGA43( )H30	16-49, 16-68
8538SCW63V03	16-49	8538SDW26( )H301	16-47, 16-67	8538SGA45( )H30	16-49, 16-51, 16-68
8538SCW64V02	16-48	8538SDW32( )H30	16-49, 16-68	8538SGG11( )H30	16-48, 16-68
8538SCW64V03	16-48	8538SDW32S8( )H30	16-50	8538SGG13( )H30	16-47, 16-67
8538SCW65V02	16-47	8538SDW34( )H30	16-49, 16-68	8538SGG15( )H30	16-47, 16-67
8538SCW65V03	16-47	8538SDW34S8( )H30	16-50	8538SGG33( )H30	16-49, 16-68
8538SCW66V02	16-49	8538SDW36( )H301	16-49, 16-68	8538SGG35( )H30	16-49, 16-68
8538SCW66V03	16-49	8538SDW36S8( )H301	16-50	8538SGW13( )H30	16-47, 16-67
8538SDA11( )H3016-48, 16-54 – 16-55, 16-68, 16-70 – 16-71		8538SDW42( )H30	16-49, 16-68	8538SGW15( )H30	16-47, 16-67
8538SDA11S8( )H30	16-50	8538SDW44( )H30	16-49, 16-51, 16-68 – 16-69	8538SGW33( )H30	16-49, 16-68
8538SDA12( )H30	16-67, 16-71	8538SDW46( )H301	16-49, 16-68	8538SGW35( )H30	16-49, 16-68
8538SDA12S8( )H30	16-50	8538SDW61V02	16-48	8538SHA11( )H30	16-48
8538SDA14( )H30	16-47, 16-67	8538SDW61V03	16-48	8538SHA12( )H30	16-47
8538SDA14S8( )H30	16-50	8538SDW62V02	16-47	8538SHA13( )H30	16-47
8538SDA16( )H301	16-47, 16-67	8538SDW62V03	16-47	8538SHA21( )H30	16-48
8538SDA16S8( )H301	16-50	8538SDW63V02	16-49	8538SHA22( )H30	16-47
8538SDA21( )H30	16-48, 16-68	8538SDW63V03	16-49	8538SHA23( )H30	16-47
8538SDA21S8( )H30	16-50	8538SDW64V02	16-48	8538SHA32( )H30	16-49
8538SDA22( )H30	16-67	8538SDW64V03	16-48	8538SHA33( )H30	16-49
8538SDA22S8( )H30	16-50	8538SDW65V02	16-47	8538SHA42( )H30	16-49
8538SDA24( )H30	16-47, 16-67	8538SDW65V03	16-47	8538SHA43( )H30	16-49, 16-51 – 16-52, 16-69
8538SDA24S8( )H30	16-50	8538SDW66V02	16-49	8538SHG11( )H30	16-48
8538SDA26( )H301	16-47, 16-67	8538SDW66V03	16-49	8538SHG12( )H30	16-47
8538SDA26S8( )H301	16-50	8538SEA11( )H30	16-48, 16-54, 16-68, 16-70	8538SHG13( )H30	16-47
8538SDA32( )H30	16-49, 16-68	8538SEA12( )H30	16-47	8538SHG32( )H30	16-49
8538SDA32S8( )H30	16-50	8538SEA13( )H30	16-47, 16-54 – 16-55, 16-67	8538SHG33( )H30	16-49
8538SDA34( )H30	16-49, 16-68	8538SEA15( )H30	16-47, 16-54 – 16-55, 16-67	8538SHW11( )H30	16-48
8538SDA34S8( )H30	16-50	8538SEA21( )H30	16-48, 16-68	8538SHW12( )H30	16-47
8538SDA36( )H301	16-49, 16-68	8538SEA22( )H30	16-47	8538SHW13( )H30	16-47
8538SDA36S8( )H301	16-50	8538SEA23( )H30	16-47, 16-67	8538SHW32( )H30	16-49
8538SDA42( )H30	16-49, 16-68	8538SEA25( )H30	16-47, 16-67	8538SHW33( )H30	16-49
8538SDA42S8( )H30	16-50	8538SEA32( )H30	16-49	8539LO1000( ) – 8539LO1200( )	16-74
8538SDA44( )H30	16-49, 16-51, 16-68 – 16-69	8538SEA33( )H30	16-49, 16-68	8539R26 – 8539R46	16-57, 16-131
8538SDA44S8( )H30	16-50	8538SEA35( )H30	16-49, 16-68	8539R6 – 8539R9	16-57, 16-131
8538SDA46( )H301	16-49, 16-68	8538SEA42( )H30	16-49, 16-51 – 16-52, 16-69	8539SBA1( )H30	16-54 – 55, 16-70 – 71
8538SDA46S8( )H301	16-50	8538SEA43( )H30	16-49, 16-68	8539SBA3( )H30	16-54, 16-70
8538SDA61V02	16-48	8538SEA45( )H30	16-49, 16-68	8539SBA43S8( )H30	16-52 – 16-53
8538SDA61V03	16-48	8538SEG11( )H30	16-48, 16-68	8539SBA53( )H30	16-51 – 52, 16-69
8538SDA62V02	16-47	8538SEG12( )H30	16-47	8539SBA53S8( )H30	16-52 – 53
8538SDA62V03	16-47	8538SEG13( )H30	16-47, 16-67	8539SBA71V03	16-55
8538SDA63V02	16-49	8538SEG15( )H30	16-47, 16-67	8539SBA72V02	16-55
8538SDA63V03	16-49	8538SEG32( )H30	16-49	8539SBA74V03	16-55
8538SDA64V02	16-48	8538SEG33( )H30	16-49, 16-68	8539SBA75V02	16-55
8538SDA64V03	16-48	8538SEG35( )H30	16-49, 16-68	8539SBG1( )H30	16-71
8538SDA65V02	16-47	8538SEW12( )H30	16-47	8539SBG3( )H30	16-54, 16-70
8538SDA65V03	16-47	8538SEW13( )H30	16-47, 16-54 – 16-55, 16-67	8539SBG43( )H30	16-51 – 16-52, 16-69
8538SDA66V02	16-49	8538SEW15( )H30	16-47, 16-54 – 16-55, 16-67	8539SBG43S8( )H30	16-52 – 16-53
8538SDA66V03	16-49	8538SEW23( )H30	16-47	8539SBG71V03	16-55
8538SDASP4	16-46	8538SEW25( )H30	16-47	8539SBG72V02	16-55
8538SDASP6	16-46	8538SEW32( )H30	16-49	8539SBW1( )H30	16-71
8538SDG11( )H30	16-48, 16-68	8538SEW33( )H30	16-49, 16-68	8539SBW3( )H30	16-54, 16-70
8538SDG11S8( )H30	16-50	8538SEW35( )H30	16-49, 16-68	8539SBW43S8( )H30	16-52 – 16-53
8538SDG12( )H30	16-47, 16-67	8538SEW43( )H30	16-49	8539SBW53( )H30	16-51 – 16-52, 16-69
8538SDG12S8( )H30	16-50	8538SEW45( )H30	16-49	8539SBW71V03	16-55
8538SDG14( )H30	16-47, 16-67	8538SFA11( )H30	16-48, 16-54, 16-68, 16-70	8539SBW72V02	16-55
8538SDG14S8( )H30	16-50	8538SFA13( )H30	16-47, 16-54 – 16-55, 16-67	8539SBW74V03	16-55
8538SDG16( )H301	16-47, 16-67	8538SFA15( )H30	16-47, 16-55, 16-67, 16-71	8539SBW75V02	16-55
8538SDG16S8( )H301	16-50	8538SFA21( )H30	16-48, 16-68	8539SCA1( )H30	16-54
8538SDG32( )H30	16-49, 16-68	8538SFA23( )H30	16-47, 16-67	8539SCA15( )H30	16-54, 16-70
8538SDG32S8( )H30	16-50	8538SFA25( )H30	16-47, 16-67	8539SCA16( )H30	16-54, 16-70
8538SDG34( )H30	16-49, 16-68	8538SFA33( )H30	16-49, 16-68	8539SCA17( )H30	16-55, 16-71
8538SDG34S8( )H30	16-50	8538SFA35( )H30	16-49, 16-68	8539SCA18( )H30	16-71
8538SDG36( )H301	16-49, 16-68	8538SFA43( )H30	16-49, 16-68	8539SCA2( )H30	16-54, 16-70
8538SDG36S8( )H301	16-50	8538SFA45( )H30	16-49, 16-68	8539SCA44( )H30 16-49, 16-51 – 16-52, 16-68 – 16-69	
8538SDG61V02	16-48	8538SFG11( )H30	16-48, 16-68	8539SCA44S8( )H30	16-52 – 16-53
8538SDG61V03	16-48	8538SFG13( )H30	16-47, 16-67	8539SCA45( )H30	16-51, 16-69
8538SDG62V02	16-47	8538SFG15( )H30	16-47, 16-67	8539SCA45S8( )H30	16-53
8538SDG62V03	16-47	8538SFG33( )H30	16-49, 16-68	8539SCA5( )H30	16-54, 16-70
8538SDG63V02	16-49	8538SFG35( )H30	16-49, 16-68	8539SCA54( )H30	16-52, 16-69
8538SDG63V03	16-49	8538SFW13( )H30	16-47, 6-67, 16-70 – 16-71	8539SCA54S8( )H30	16-52 – 16-53
		8538SFW15( )H30	16-47, 16-55, 16-67, 16-71	8539SCA55( )H30	16-51, 16-69

8539SCA55S8( )H30 ..... 16-53  
8539SCA6( )H30 ..... 16-54, 16-70  
8539SCA7( )H30 ..... 16-55, 16-71  
8539SCA71V03 ..... 16-55  
8539SCA72V02 ..... 16-55  
8539SCA74V03 ..... 16-55  
8539SCA75V02 ..... 16-55  
8539SCA8( )H30 ..... 16-71  
8539SCASP6 ..... 16-46  
8539SCG2( )H30 ..... 16-54, 16-70  
8539SCG44( )H30 ..... 16-52, 16-69  
8539SCG44S8( )H30 ..... 16-52 – 16-53  
8539SCG45( )H30 ..... 16-51, 16-69  
8539SCG45S8( )H30 ..... 16-53  
8539SCG5( )H30 ..... 16-54, 16-70  
8539SCG6( )H30 ..... 16-54, 16-70  
8539SCG7( )H30 ..... 16-55, 16-71  
8539SCG71V03 ..... 16-55  
8539SCG72V02 ..... 16-55  
8539SCG8( )H30 ..... 16-55, 16-62  
8539SCW15( )H30 ..... 16-54, 16-70  
8539SCW16( )H30 ..... 16-54, 16-70  
8539SCW17( )H30 ..... 16-55, 16-71  
8539SCW18( )H30 ..... 16-71  
8539SCW2( )H30 ..... 16-54, 16-70  
8539SCW3( )H30 ..... 16-71  
8539SCW44( )H30 ..... 16-49, 16-51, 16-68  
8539SCW44S8( )H30 ..... 16-52 – 16-53  
8539SCW45( )H30 ..... 16-51, 16-69  
8539SCW45S8( )H30 ..... 16-53  
8539SCW5( )H30 ..... 16-54, 16-70  
8539SCW54( )H30 ..... 16-51 – 16-52, 16-69  
8539SCW55( )H30 ..... 16-51, 16-69  
8539SCW6( )H30 ..... 16-54, 16-70  
8539SCW7( )H30 ..... 16-55, 16-71  
8539SCW71V03 ..... 16-55  
8539SCW72V02 ..... 16-55  
8539SCW74V03 ..... 16-55  
8539SCW75V02 ..... 16-55  
8539SCW8( )H30 ..... 16-71  
8539SDA13( )H30 ..... 16-71  
8539SDA15( )H30 ..... 16-55, 16-71  
8539SDA17( )H30 ..... 16-54, 16-70  
8539SDA18( )H30 ..... 16-55, 16-71  
8539SDA3( )H30 ..... 16-71  
8539SDA42( )H30 ..... 16-51 – 16-52, 16-69  
8539SDA42S8( )H30 ..... 16-53  
8539SDA43( )H30 ..... 16-51 – 16-52, 16-69  
8539SDA43S8( )H30 ..... 16-53  
8539SDA44S8( )H30 ..... 16-53  
8539SDA5( )H30 ..... 16-55, 16-71  
8539SDA52( )H30 ..... 16-51 – 16-52, 16-69  
8539SDA52S8( )H30 ..... 16-53  
8539SDA53( )H30 ..... 16-51 – 16-52, 16-69  
8539SDA53S8( )H30 ..... 16-53  
8539SDA54( )H30 ..... 16-51, 16-69  
8539SDA54S8( )H30 ..... 16-53  
8539SDA7( )H30 ..... 16-54, 16-70  
8539SDA71V02 ..... 16-55  
8539SDA71V03 ..... 16-55  
8539SDA74V02 ..... 16-55  
8539SDA74V03 ..... 16-55  
8539SDA8( )H30 ..... 16-55, 16-71  
8539SDASP5 ..... 16-46  
8539SDASP6 ..... 16-46  
8539SDG3( )H30 ..... 16-55, 16-71  
8539SDG42( )H30 ..... 16-51 – 16-52, 16-69  
8539SDG42S8( )H30 ..... 16-53  
8539SDG43( )H30 ..... 16-51 – 16-52, 16-69  
8539SDG43S8( )H30 ..... 16-53  
8539SDG44( )H30 ..... 16-51, 16-69  
8539SDG44S8( )H30 ..... 16-53  
8539SDG5( )H30 ..... 16-55, 16-71  
8539SDG7( )H30 ..... 16-54, 16-70  
8539SDG71V02 ..... 16-55  
8539SDG71V03 ..... 16-55  
8539SDG8( )H30 ..... 16-55, 16-71  
8539SDW1( )H30 ..... 16-71  
8539SDW13( )H30 ..... 16-71  
8539SDW15( )H30 ..... 16-55, 16-71  
8539SDW17( )H30 ..... 16-54, 16-70

8539SDW18( )H30 ..... 16-55, 16-71  
8539SDW3( )H30 ..... 16-71  
8539SDW42( )H30 ..... 16-51 – 16-52, 16-69  
8539SDW42S8( )H30 ..... 16-53  
8539SDW43( )H30 ..... 16-51 – 16-52, 16-69  
8539SDW43S8( )H30 ..... 16-53  
8539SDW44S8( )H30 ..... 16-53  
8539SDW5( )H30 ..... 16-55, 16-71  
8539SDW52( )H30 ..... 16-51 – 16-52, 16-69  
8539SDW53( )H30 ..... 16-51 – 16-52, 16-69  
8539SDW54( )H30 ..... 16-51, 16-69  
8539SDW7( )H30 ..... 16-54, 16-70  
8539SDW71V02 ..... 16-55  
8539SDW71V03 ..... 16-55  
8539SDW74V02 ..... 16-55  
8539SDW74V03 ..... 16-55  
8539SDW8( )H30 ..... 16-55, 16-71  
8539SEA14( )H30 ..... 16-55, 16-71  
8539SEA16( )H30 ..... 16-55, 16-71  
8539SEA17( )H30 ..... 16-55  
8539SEA3( )H30 ..... 16-54 – 16-55, 16-68, 16-70 – 16-71  
8539SEA4( )H30 ..... 16-55, 16-71  
8539SEA41( )H30 ..... 16-52, 16-69  
8539SEA5( )H30 ..... 16-54 – 16-55, 16-70 – 16-71  
8539SEA51( )H30 ..... 16-52, 16-69  
8539SEA52( )H30 ..... 16-51 – 16-52, 16-69  
8539SEA6( )H30 ..... 16-55, 16-71  
8539SEA7( )H30 ..... 16-55  
8539SEG3( )H30 ..... 16-54 – 16-55, 16-70 – 16-71  
8539SEG4( )H30 ..... 16-55, 16-71  
8539SEG41( )H30 ..... 16-52, 16-69  
8539SEG42( )H30 ..... 16-51 – 16-52, 16-69  
8539SEG5( )H30 ..... 16-54 – 16-55, 16-70 – 16-71  
8539SEG6( )H30 ..... 16-55, 16-71  
8539SEG7( )H30 ..... 16-55  
8539SEW1( )H30 ..... 16-54, 16-70  
8539SEW14( )H30 ..... 16-55, 16-71  
8539SEW16( )H30 ..... 16-55, 16-71  
8539SEW17( )H30 ..... 16-55  
8539SEW3( )H30 ..... 16-54 – 16-55, 16-70 – 16-71  
8539SEW4( )H30 ..... 16-55, 16-71  
8539SEW41( )H30 ..... 16-52, 16-69  
8539SEW42( )H30 ..... 16-51 – 16-52, 16-69  
8539SEW5( )H30 ..... 16-54 – 16-55, 16-70 – 16-71  
8539SEW51( )H30 ..... 16-52, 16-69  
8539SEW52( )H30 ..... 16-51 – 16-52, 16-69  
8539SEW6( )H30 ..... 16-55, 16-71  
8539SEW7( )H30 ..... 16-55  
8539SFA14( )H30 ..... 16-54 – 16-55, 16-70 – 16-71  
8539SFA3( )H30 ..... 16-54 – 16-55, 16-70 – 16-71  
8539SFA4( )H30 ..... 16-54 – 16-55, 16-70 – 16-71  
8539SFA44( )H30 ..... 16-51 – 16-52, 16-69  
8539SFA5( )H30 ..... 16-55, 16-71  
8539SFA54( )H30 ..... 16-51 – 16-52, 16-69  
8539SFG3( )H30 ..... 16-54 – 16-55, 16-62, 16-70 – 16-71  
8539SFG4( )H30 ..... 16-54 – 16-55, 16-70 – 16-71  
8539SFG44( )H30 ..... 16-51 – 16-52, 16-69  
8539SFG5( )H30 ..... 16-55, 16-71  
8539SFW1( )H30 ..... 16-54, 16-70  
8539SFW14( )H30 ..... 16-54 – 16-55, 16-70 – 16-71  
8539SFW3( )H30 ..... 16-54 – 16-55, 16-70 – 16-71  
8539SFW4( )H30 ..... 16-54 – 16-55, 16-70 – 16-71  
8539SFW44( )H30 ..... 16-51 – 16-52, 16-69  
8539SFW5( )H30 ..... 16-55, 16-71  
8539SFW54( )H30 ..... 16-51 – 16-52, 16-69  
8539SGA12( )H30 ..... 16-54 – 16-55, 16-70 – 16-71  
8539SGA14( )H30 ..... 16-54 – 16-55, 16-70 – 16-71  
8539SGA16( )H30 ..... 16-54 – 16-55, 16-70 – 16-71  
8539SGA2( )H30 ..... 16-54 – 16-55, 16-70 – 16-71  
8539SGA4( )H30 ..... 16-54 – 16-55, 16-70 – 16-71  
8539SGA44( )H30 ..... 16-51 – 16-52, 16-69  
8539SGA54( )H30 ..... 16-51 – 16-52, 16-69  
8539SGA55( )H30 ..... 16-51 – 16-52, 16-69  
8539SGA6( )H30 ..... 16-54 – 16-55, 16-70 – 16-71  
8539SGG2( )H30 ..... 16-54 – 16-55, 16-70 – 16-71  
8539SGG4( )H30 ..... 16-54 – 16-55, 16-70 – 16-71  
8539SGG44( )H30 ..... 16-51 – 16-52, 16-69  
8539SGG45( )H30 ..... 16-51 – 16-52, 16-69  
8539SGG46( )H30 ..... 16-51  
8539SGG6( )H30 ..... 16-54 – 16-55, 16-70 – 16-71  
8539SGW2( )H30 ..... 16-54 – 16-55, 16-70 – 16-71

8539SGW4( )H30 ..... 16-54 – 16-55, 16-70 – 16-71  
8539SGW44( )H30 ..... 16-51 – 16-52, 16-69  
8539SGW45( )H30 ..... 16-51 – 16-52, 16-69  
8539SGW6( )H30 ..... 16-54 – 16-55, 16-70 – 16-71  
8539SHA14( )H30 ..... 16-54 – 16-55, 16-70 – 16-71  
8539SHA15( )H30 ..... 16-54 – 16-55, 16-70 – 16-71  
8539SHA4( )H30 ..... 16-54 – 16-55, 16-70 – 16-71  
8539SHA46( )H30 ..... 16-51 – 16-52, 16-69  
8539SHA46( )H30 ..... 16-51 – 16-52, 16-69  
8539SHA5( )H30 ..... 16-54 – 16-55, 16-70 – 16-71  
8539SHA53( )H30 ..... 16-51 – 16-52, 16-69  
8539SHA55( )H30 ..... 16-51 – 16-52, 16-69  
8539SHA56( )H30 ..... 16-51 – 16-52, 16-69  
8539SHG4( )H30 ..... 16-54 – 16-55, 16-70 – 16-71  
8539SHG43( )H30 ..... 16-51 – 16-52, 16-69  
8539SHG45( )H30 ..... 16-51 – 16-52, 16-69  
8539SHG46( )H30 ..... 16-51 – 16-52, 16-69  
8539SHG5( )H30 ..... 16-54 – 16-55, 16-70 – 16-71  
8539SHW4( )H30 ..... 16-54 – 16-55, 16-70 – 16-71  
8539SHW43( )H30 ..... 16-51 – 16-52, 16-69  
8539SHW45( )H30 ..... 16-51 – 16-52, 16-69  
8539SHW46( )H30 ..... 16-51 – 16-52, 16-69  
8539SHW5( )H30 ..... 16-54 – 16-55, 16-70 – 16-71  
8539SJA12( )H30 ..... 16-55  
8539SJA13( )H30 ..... 16-54 – 16-55  
8539SJA51( )H30 ..... 16-52  
8539SJA52( )H30 ..... 16-52  
8539SJA53( )H30 ..... 16-51 – 16-52  
8539SJG3( )H30 ..... 16-54 – 16-55  
8539SJG41( )H30 ..... 16-52  
8539SJG42( )H30 ..... 16-52  
8539SJG43( )H30 ..... 16-51 – 16-52  
8539SJW3( )H30 ..... 16-54 – 16-55  
8539SJW41( )H30 ..... 16-52  
8539SJW42( )H30 ..... 16-52  
8539SJW43( )H30 ..... 16-51 – 16-52  
8539TC10 ..... 16-57, 16-131  
8539TC11 ..... 16-57, 16-131  
8539TC20 ..... 16-57, 16-131  
8539TC21 ..... 16-57, 16-131  
861HSSR( )DC( ) ..... 23-68  
861HSSR( )DD ..... 23-68  
861HSSR115DD – 861HSSRA408DC2 ..... 23-68  
861SSR( )AC( ) ..... 23-68, 23-83  
861SSR( )DC( ) – 861SSRA( )DC( ) ..... 23-83  
861SSR115DD – 861SSR610DC2 ..... 23-83  
861SSRA208AC1 – 861SSRA408DC2 ..... 23-83  
8702SAG1( ) ..... 16-61  
8702SAG2( ) ..... 16-61  
8702SAG3( ) ..... 16-61  
8702SAG4( ) ..... 16-60  
8702SAO1( ) ..... 16-61  
8702SAO2( ) ..... 16-61  
8702SAO3( ) ..... 16-61  
8702SAO4( ) ..... 16-60  
8702SBO10( ) ..... 16-61  
8702SBO11( ) ..... 16-61, 16-63  
8702SBO12( ) ..... 16-60  
8702SBO13( ) ..... 16-61  
8702SBO9( ) ..... 16-61, 16-63  
8702SBR10( ) ..... 16-61, 16-63  
8702SBR6( ) ..... 16-61, 16-63  
8702SBR7( ) ..... 16-61, 16-63  
8702SBR8( ) ..... 16-61, 16-63  
8702SBR9( ) ..... 16-60  
8702SBT46( ) ..... 16-61, 16-63  
8702SBT47( ) ..... 16-61, 16-63  
8702SBT48( ) ..... 16-61, 16-63  
8702SBT49( ) ..... 16-60  
8702SCG10( ) ..... 16-61, 16-63  
8702SCG6( ) ..... 16-61, 16-63  
8702SCG8( ) ..... 16-60  
8702SCO10( ) ..... 16-61, 16-63  
8702SCO6( ) ..... 16-61, 16-63  
8702SCOT7( ) ..... 16-60  
8702SCO8( ) ..... 16-60  
8702SCO9( ) ..... 16-61, 16-63  
8702SCR10( ) ..... 16-61, 16-63  
8702SCR6( ) ..... 16-61, 16-63  
8702SCR7( ) ..... 16-61, 16-63  
8702SCR8( ) ..... 16-61, 16-63

8702SCR9( )	16-60	8739SCG8( )H30	16-71	8903SQG60( ) – 8903SQG91( )	16-77
8702SCT46( )	16-61, 16-63	8739SCW18( )H30	16-55	8903SQH1( ) – 8903SQH4( )	16-75
8702SCT47( )	16-61, 16-63	8739SCW3( )H30	16-55, 16-71	8903SQH61( ) – 8903SQH83( )	16-78
8702SCT48( )	16-61, 16-63	8739SCW8( )H30	16-55	8903SQO1( ) – 8903SQO13( )	16-75
8702SCT49( )	16-60	8739SDA1( )H30	16-34, 16-54 – 16-55, 16-62, 16-70 – 16-71	8903SQO2( ) – 8903SQO4( )	16-75
8702SDR4( )	16-61, 16-63	8739SDA13( )H30	16-55, 16-71	8903SQW1( ) – 8903SQW13( )	16-75
8702SDT43( )	16-60	8739SDA3( )H30	16-55, 16-71	8903SQW2( ) – 8903SQW22( )	16-75
8702SGG3( )	16-60	8739SDG1( )H30	16-71	8903SQW3( ) – 8903SQW32( )	16-75
8702SGO3( )	16-60	8739SDG3( )H30	16-71	8903SQW4( )	16-75
8702WHO3V	16-66	8739SDW1( )H30	16-54 – 16-55, 16-70 – 16-71	8903SQW60( ) – 8903SQW91( )	16-77
8736SAO13( )	16-63	8739SDW13( )H30	16-55, 16-71	8903SVA1( ) – 8903SVA12( )	16-75
8736SAO14( )	16-63	8739SDW3( )H30	16-55, 16-71	8903SVA2( ) – 8903SVA4( )	16-75
8736SAO15( )	16-63	8903L1L – 8903L3R	16-74	8903SVA60( ) – 8903SVA91( )	16-77
8736SAO16( )H30	16-62	8903LA1000( ) – 8903LA1200( )	16-74	8903SVC61( ) – 8903SVC83( )	16-78
8736SBA4( )H30	16-62	8903LA20( ) – 8903LA80( )	16-74	8903SVG1( ) – 8903SVG12( )	16-75
8736SBG4( )H30	16-62	8903LF1000( ) – 8903LF1200( )	16-74	8903SVG2( ) – 8903SVG4( )	16-75
8736SBO10( )H30	16-62	8903LGF20( ) – 8903LGF80( )	16-74	8903SVG60( ) – 8903SVG91( )	16-77
8736SBO4( )H30	16-62	8903LG1000( ) – 8903LG1200( )	16-74	8903SVH1( )	16-75
8736SBO7( )	16-63	8903LG20( ) – 8903LG80( )	16-74	8903SVH2( )	16-75
8736SBO8( )	16-63	8903LH1000( ) – 8903LH1200( )	16-74	8903SVH61( ) – 8903SVH83( )	16-78
8736SBR9( )H30	16-62	8903LH20( ) – 8903LH80( )	16-74	8903SVO1( ) – 8903SVO12( )	16-75
8736SBT49( )H30	16-62	8903LO20( ) – 8903LO80( )	16-74	8903SVO2( ) – 8903SVO4( )	16-75
8736SBW14( )H30	16-62	8903LW1000( ) – 8903LW1200( )	16-74	8903SVW1( ) – 8903SVW12( )	16-75
8736SCA4( )H30	16-62	8903LW20( ) – 8903LW80( )	16-74	8903SVW2( ) – 8903SVW4( )	16-75
8736SCO7( )H30	16-62	8903LWW1000( ) – 8903LWW1200( )	16-74	8903SVW60( ) – 8903SVW91( )	16-77
8736SCO8( )H30	16-62	8903LWW20( ) – 8903LWW80( )	16-74	8903SXA1( ) – 8903SXA14( )	16-75
8736SCR9( )H30	16-62	8903LXA1000( ) – 8903LXA1200( )	16-74	8903SXA2( )	16-75
8736SCT49( )H30	16-62	8903LXA20( ) – 8903LXA80( )	16-74	8903SXA60( ) – 8903SXA91( )	16-77
8736SDG2( )H30	16-62	8903LXF1000( ) – 8903LXF1200( )	16-74	8903SXG1( ) – 8903SXG14( )	16-75
8736SDO2( )H30	16-62	8903LXF20( ) – 8903LXF80( )	16-74	8903SXG2( )	16-75
8736SDR3( )H30	16-62	8903LXG1000( ) – 8903LXG1200( )	16-74	8903SXG60( ) – 8903SXG91( )	16-77
8736SDT43( )H30	16-62	8903LXG20( ) – 8903LXG80( )	16-74	8903SXO1( ) – 8903SXO14( )	16-75
8736SEG2( )H30	16-62	8903LXO1000( ) – 8903LXO1200( )	16-74	8903SXO2( )	16-75
8736SEO2( )H30	16-62	8903LXO20( ) – 8903LXO80( )	16-74	8903SXW1( ) – 8903SXW14( )	16-75
8736SFO3( )H30	16-62	8903LXW1000( ) – 8903LXW1200( )	16-74	8903SXW2( )	16-75
8736SGG3( )H30	16-62	8903LXW20( ) – 8903LXW80( )	16-74	8903SYW60( ) – 8903SYW91( )	16-77
8736SGO3( )H30	16-62	8903LXWW1000( ) – 8903LXWW1200( )	16-74	8903SYA1( ) – 8903SYA17( )	16-75
8736SHA1( )H30	16-63	8903LXWW20( ) – 8903LXWW80( )	16-74	8903SYA2( )	16-75
8736SHG1( )H30	16-63	8903SMA1( ) – 8903SMA13( )	16-75	8903SYA81( ) – 8903SYA91( )	16-77
8736SHO1( )H30	16-63	8903SMA2( ) – 8903SMA4( )	16-75	8903SYG1( ) – 8903SYG17( )	16-75
8736SHW1( )H30	16-63	8903SMA60( ) – 8903SMA91( )	16-77	8903SYG2( )	16-75
8736SJA1( )H30	16-63	8903SMC61( ) – 8903SMC83( )	16-78	8903SYG81( ) – 8903SYG91( )	16-77
8736SJG1( )H30	16-63	8903SMF1( ) – 8903SMF13( )	16-75	8903SYO1( ) – 8903SYO17( )	16-75
8736SJO1( )H30	16-63	8903SMF2( ) – 8903SMF4( )	16-75	8903SYO2( )	16-75
8736SJW1( )H30	16-63	8903SMG1( ) – 8903SMG13( )	16-75	8903SYW1( ) – 8903SYW17( )	16-75
8738SBA12( )H30	16-47	8903SMG2( ) – 8903SMG4( )	16-75	8903SYW2( )	16-75
8738SBA22( )H30	16-47	8903SMG60( ) – 8903SMG61( )	16-77	8903SYW81( ) – 8903SYW91( )	16-77
8738SBG12( )H30	16-47	8903SMO2( ) – 8903SMO4( )	16-75	8903SZA1( ) – 8903SZA19( )	16-75
8738SBW12( )H30	16-33, 16-47	8903SMW1( ) – 8903SMW13( )	16-75	8903SZA2( )	16-75
8738SBW22( )H30	16-33, 16-47	8903SMW2( ) – 8903SMW24( )	16-75	8903SZA81( ) – 8903SZA91( )	16-77
8738SCA12( )H30	16-47, 16-54, 16-70	8903SMW3( ) – 8903SMW34( )	16-75	8903SZG1( ) – 8903SZG19( )	16-75
8738SCA13( )H30	16-47, 16-55, 16-71	8903SMW4( )	16-75	8903SZG2( )	16-75
8738SCA14( )H301	16-67	8903SMW60( ) – 8903SMW72( )	16-77	8903SZG81( ) – 8903SZG91( )	16-77
8738SCA22( )H30	16-47	8903SMW81 – 8903SMW91( )	16-77	8903SZO1( ) – 8903SZO19( )	16-75
8738SCA23( )H30	16-47	8903SPA1( ) – 8903SPA13( )	16-75	8903SZO2( )	16-75
8738SCA24( )H301	16-67	8903SPA2( ) – 8903SPA4( )	16-75	8903SZW1( ) – 8903SZW19( )	16-75
8738SCG12( )H30	16-67	8903SPA60( ) – 8903SPA91( )	16-77	8903SZW2( )	16-75
8738SCG13( )H30	16-67	8903SPC61( ) – 8903SPC83( )	16-78	8903SZW81( ) – 8903SZW91( )	16-77
8738SCG14( )H301	16-67	8903SPF1( ) – 8903SPF13( )	16-75	8910DP11( ) – 8910DP12( )	16-89
8738SCW12( )H30	16-47, 16-54, 16-70	8903SPF2( ) – 8903SPF4( )	16-75	8910DP21( ) – 8910DP22( )	16-89
8738SCW13( )H30	16-33, 16-47, 16-55, 16-71	8903SPG1( ) – 8903SPG13( )	16-75	8910DP31( ) – 8910DP32( )	16-89
8738SCW14( )H301	16-67	8903SPG2( ) – 8903SPG4( )	16-75	8910DP41( ) – 8910DP42( )	16-89
8738SCW22( )H30	16-47	8903SPG60( ) – 8903SPG91( )	16-77	8910DPA12( ) – 8910DPA93( )	16-89
8738SCW23( )H30	16-33, 16-47	8903SPH1( ) – 8903SPH4( )	16-75	8910DPA14	16-90
8738SCW24( )H301	16-67	8903SPH61( ) – 8903SPH83( )	16-78	8910DPA24	16-90
8738SDA12( )H30	16-47	8903SPO1( ) – 8903SPO13( )	16-75	8910DPA34	16-90
8738SDA16( )H30	16-67	8903SPO2( ) – 8903SPO4( )	16-75	8911DPB1	16-92
8738SDA22( )H30	16-47	8903SPW1( ) – 8903SPW13( )	16-75	8911DPSG12 – 8911DPSG53	16-92
8738SDA26( )H30	16-67	8903SPW2( ) – 8903SPW24( )	16-75	8911DPSO12 – 8911DPSO53	16-92
8738SDG16( )H30	16-67	8903SPW3( ) – 8903SPW34( )	16-75	8911DSS1	16-92
8738SDW12( )H30	16-47	8903SPW4( )	16-75	8940SSC2007 – 8940SSC4010	16-93
8738SDW16( )H30	16-67	8903SPW60( ) – 8903SPW91( )	16-77	8940SSD2015	16-93
8738SDW22( )H30	16-47	8903SQA1( ) – 8903SQA13( )	16-75	8940SSE2030 – 8940SSE4050	16-93
8738SDW26( )H30	16-67	8903SQA2( ) – 8903SQA4( )	16-75	8940SSF2050 – 8940SSF4100	16-93
8739SBA1( )H30	16-71	8903SQA60( ) – 8903SQA91( )	16-77	8940SSG2100 – 8940SSG4200	16-93
8739SBG1( )H30	16-54 – 55, 16-70 – 71	8903SQ61( ) – 8903SQ83( )	16-78	8940WC1S2V03H30	16-94
8739SBW1( )H30	16-54 – 16-55, 16-70 – 16-71	8903SQF1( ) – 8903SQF11( )	16-75	8940WC3S2V06H30	16-94
8739SCA18( )H30	16-55	8903SQF2( )	16-75	8940WD1S2V03H30	16-94
8739SCA3( )H30	16-34, 16-55, 16-71	8903SQG1( ) – 8903SQG13( )	16-75	8940WD3S2V06H30	16-94
8739SCA8( )H30	16-55	8903SQG2( ) – 8903SQG4( )	16-75	8940WE1S2V03H30	16-94
8739SCG3( )H30	16-71			8940WE3S2V06H30	16-94

8940WF1S2V03H30	16-94
8940WF3S2V06H30	16-94
8940XSE2030V03H30	16-93
8940XSE2040V03H309	16-93
8940XSE4040V06H30	16-93
8940XSE4050V06H30	16-93
8940XSE4075V06H309	16-93
8940XSF2050V03H30	16-93
8940XSF4100V06H30	16-93
8940XSG2075 – 8940XSG4200	16-93
8940XSH2200 – 8940XSH4400	16-93
8940XSJ2300 – 8940XSJ4600	16-93
8941CBA06	16-96
8941CBA08	16-96
8941CBA10	16-96
8941CBG06	16-96
8941CBG08	16-96
8941CBG10	16-96
8941CBW06	16-96
8941CBW08	16-96
8941CBW10	16-96
8941CCA12	16-96
8941CCA14	16-96
8941CCA15	16-96
8941CCA16	16-96
8941CCA18	16-96
8941CCA20	16-96
8941CCG12	16-96
8941CCG14	16-96
8941CCG15	16-96
8941CCG16	16-96
8941CCG18	16-96
8941CCG20	16-96
8941CCW12	16-96
8941CCW14	16-96
8941CCW15	16-96
8941CCW16	16-96
8941CCW18	16-96
8941CCW20	16-96
8941CDA22	16-96
8941CDA24	16-96
8941CDA26	16-96
8941CDA28	16-96
8941CDA30	16-96
8941CDG22	16-96
8941CDG24	16-96
8941CDG26	16-96
8941CDG28	16-96
8941CDG30	16-96
8941CDW22	16-96
8941CDW24	16-96
8941CDW26	16-96
8941CDW28	16-96
8941CDW30	16-96
8941CEA32	16-96
8941CEA36	16-96
8941CEA38	16-96
8941CEA39	16-96
8941CEA40	16-96
8941CEG32	16-96
8941CEG36	16-96
8941CEG38	16-96
8941CEG39	16-96
8941CEG40	16-96
8941CEW32	16-96
8941CEW36	16-96
8941CEW38	16-96
8941CEW39	16-96
8941CEW40	16-96
8941CFA41	16-96
8941CFA43	16-96
8941CFA44	16-96
8941CFA45	16-96
8941CFA47	16-96
8941CFG41	16-96
8941CFG43	16-96
8941CFG44	16-96
8941CFG45	16-96
8941CFG47	16-96
8941CFW41	16-96
8941CFW43	16-96

8941CFW44	16-96
8941CFW45	16-96
8941CFW47	16-96
8941DBA08	16-97
8941DBA10	16-97
8941DBG08	16-97
8941DBG10	16-97
8941DBW08	16-97
8941DBW10	16-97
8941DCA18	16-97
8941DCA20	16-97
8941DCG18	16-97
8941DCG20	16-97
8941DCW18	16-97
8941DCW20	16-97
8941DDA28	16-97
8941DDA30	16-97
8941DDG28	16-97
8941DDG30	16-97
8941DDW28	16-97
8941DDW30	16-97
8941DEA40	16-97
8941DEG40	16-97
8941DEW40	16-97
8941NBA10	16-96
8941NBG10	16-96
8941NBO10	16-96
8941NBW10	16-96
8941NCA20	16-96
8941NCG20	16-96
8941NCO20	16-96
8941NCW20	16-96
8941NDA30	16-96
8941NDG30	16-96
8941NDO30	16-96
8941NDW30	16-96
8941NEA40	16-96
8941NEG40	16-96
8941NEO40	16-96
8941NEW40	16-96
8941NFA50	16-96
8941NFG50	16-96
8941NFO50	16-96
8941NFW50	16-96
8941UBA10	16-97
8941UBG10	16-97
8941UBW10	16-97
8941UCA20	16-97
8941UCG20	16-97
8941UCW20	16-97
8941UDA30	16-97
8941UDG30	16-97
8941UDW30	16-97
8941UEA40	16-97
8941UEG40	16-97
8941UEW40	16-97
8965DPR13	16-99
8965DPR14	16-99
8965DPR23	16-99
8965DPR24	16-99
8965DPR33	16-99
8965DPR34	16-99
8965DPR43	16-99
8965DPR44	16-99
8998BA003AFSMA	17-5
8998CP03 – 8998CP24	17-8
8998HBA001AFSMA – 8998HBA010XFTMA	17-7
8998HBA001AFSSS – 8998HBA010XFTSS	17-7
8998HBF015 – 8998HBF250	17-8
8998HFA001AFSMA – 8998HFA010XFTMA	17-7
8998HFA001AFSSS – 8998HFA010XFTSS	17-7
8998HFF030 – 8998HFF100	17-8
8998SBA001AFSMA – 8998SBC100XFTMA	17-5
8998SBA001AFSSS – 8998SBC100XFTSS	17-5
8998SBF015	17-8
8998SBF020	17-8
8998SBF030	17-8
8998SBF040	17-8
8998SBF050	17-8
8998SBF060	17-8
8998SBF070	17-8

8998SBF080	17-8
8998SBF100	17-8
8998SBF125	17-8
8998SBF150	17-8
8998SBF200	17-8
8998SBF250	17-8
8998SFA001AFSMA – 8998SFC100XFTMA	17-6
8998SFA001AFSSS – 8998SFC100XFTSS	17-6
8998SFF030 – 8998SFF200	17-8

**9**

92251	3-33, 3-26
92351	3-26
92451	3-26
9001A20 – 9001A31	19-99
9001A29 – 9001G29	19-11
9001A6 – 9001A9	19-99
9001A8 – 9001A24	19-75, 19-85, 19-99
9001AB1 – 9001AS2	19-114
9001B101 – 9001B342	19-110
9001B11 – 9001B25	19-75, 19-85, 19-99
9001B19 – 9001B23	19-99
9001B251 – 9001B264	19-110, 19-132
9001BF101 – 9001BF308	19-110
9001BFB107 – 9001BFB226	19-111
9001BG101 – 9001BG316	19-110
9001BGB107 – 9001BGB315	19-111
9001BGC107 – 9001BGC315	19-111
9001BOC107 – 9001BOC362	19-111
9001BOC358	19-132
9001BOC359	19-132
9001BOC366	19-132
9001BOC367	19-132
9001BOC368	19-132
9001BR101 – 9001BR218	19-110
9001BW100BU – 9001BW100YU	19-132
9001BW102B – 9001BW102Y	19-132
9001BW146 – 9001BW260	19-110
9001BW90BU – 9001BW98Y	19-132
9001BWD219 – 9001BWD220	19-110
9001BWP1	19-114
9001BWRB – 9001BWSR	19-132
9001C20 – 9001C31	19-99
9001C6 – 9001C9	19-99
9001C8 – 9001C24	19-75, 19-85, 19-99
9001G19 – 9001G31	19-99
9001G6 – 9001G9	19-99
9001G8 – 9001G24	19-75, 19-85, 19-99
9001JN100 – 9001JN799	19-11
9001JP1 – 9001JP1Y29	19-11
9001JP35 – 9001JP35Y29	19-11
9001JP38 – 9001JP38Y29	19-11
9001JT1 – 9001JT1Y29	19-11
9001JT35 – 9001JT35Y29	19-11
9001JT38 – 9001JT38Y29	19-11
9001K1 – 9001K3	19-101
9001K107 – 9001K162	19-97
9001K111	19-100
9001K11J1 – 9001K34J1R	19-75
9001K13B – 9001K13M	19-99
9001K15 – 9001K85	19-81
9001K16B – 9001K16Y	19-99
9001K16R05	19-99
9001K17B – 9001K17Y	19-99
9001K17R05	19-99
9001K1L – 9001K3L	19-93
9001K1L( ) – 9001K1L( )RH13	19-74
9001K1L1 – 9001K1L1RH13	19-74
9001K1L35( )	19-74
9001K1L35GH13 – 9001K1L35RH13	19-74
9001K1L7( )	19-74
9001K1L7GH13 – 9001K1L7RH13	19-74
9001K20	19-77
9001K21	19-77
9001K25 – 9001K28	19-112
9001K2L( ) – 9001K2L( )GH13	19-74
9001K2L( )RH13 – 9001K2L( )RH13	19-74
9001K2L1( )	19-74
9001K2L1G20H13 – 9001K2L1GH13	19-74
9001K2L1R20H13 – 9001K2L1RH13	19-74

9001K2L35( )	19-74	9001KR12( ) - 9001KR12( )H1H1	19-81	9001KS42( ) - 9001KS49( )	19-76
9001K2L35G20H13 - 9001K2L35RH13	19-74	9001KR12UH1H1	19-81	9001KS42BH1 - 9001KS49BH1	19-76
9001K2L7( )	19-74	9001KR131 - 9001KR153	19-80	9001KS42BH13 - 9001KS49BH13	19-76
9001K2L7G20H13 - 9001K2L7RH13	19-74	9001KR16 - 9001KR16H2	19-73	9001KS42BH2 - 9001KS49BH2	19-76
9001K30 - 9001K73	19-80	9001KR1B - 9001KR1UH6	19-72	9001KS42K( ) - 9001KS49K( )	19-76
9001K30H8 - 9001K73H7	19-80	9001KR1BH13	19-9, 19-72	9001KS43BH13	19-9, 19-76
9001K3L( ) - 9001K3L( )RH13	19-74	9001KR1RH13	19-9, 19-72	9001KS46BH2	16-81, 19-76
9001K3L1( ) - 9001K3L35( )	19-74	9001KR2 - 9001KS7	19-93	9001KS501 - 9001KS502	19-76
9001K3L1GH13 - 9001K3L1RH13	19-74	9001KR2( ) - 9001KR2( )H6	19-72	9001KS501( ) - 9001KS502( )	19-76
9001K3L35GH13 - 9001K3L35RH13	19-74	9001KR20 - 9001KR67	19-93	9001KS501K( ) - 9001KS502K( )	19-76
9001K3L7( )	19-74	9001KR24( ) - 9001KR24( )H6	19-72	9001KS52 - 9001KS59	19-76
9001K3L7GH13 - 9001K3L7RH13	19-74	9001KR24B - 9001KR24BM	19-72	9001KS52( ) - 9001KS59( )	19-76
9001K4 - 9001K7	19-97	9001KR24G - 9001KR24GM	19-72	9001KS52K( ) - 9001KS59K( )	19-76
9001K401J( ) - 9001K49J1R	19-76	9001KR24R - 9001KR24RM	19-72	9001KS601 - 9001KS602	19-76
9001K41 - 9001K58	19-100	9001KR25( ) - 9001KR25( )H6	19-72	9001KS601( ) - 9001KS602( )	19-76
9001K48 - 9001K97	19-97	9001KR25B - 9001KR25BM	19-72	9001KS601K( ) - 9001KS602K( )	19-76
9001K501J( ) - 9001K59J1R	19-76	9001KR25G - 9001KR25GM	19-72	9001KS62 - 9001KS69	19-76
9001K51	16-126, 19-98	9001KR25R - 9001KR25RM	19-72	9001KS62( ) - 9001KS69( )	19-76
9001K52	19-98	9001KR2B - 9001KR2BH6	19-72	9001KS62K( ) - 9001KS69K( )	19-76
9001K56( ) - 9001K56( )JM( )	19-97	9001KR2G - 9001KR2GH6	19-72	9001KS701 - 9001KS702	19-76
9001K601J( ) - 9001K69J1R	19-76	9001KR2R - 9001KR2RH6	19-72	9001KS701( ) - 9001KS702( )	19-76
9001K685	19-97	9001KR2U - 9001KR2UH6	19-72	9001KS72 - 9001KS79	19-76
9001K69 - 9001K95	19-101	9001KR3( ) - 9001KR3( )H6	19-72	9001KS72( ) - 9001KS79( )	19-76
9001K701J( ) - 9001K79J1R	19-76	9001KR3B - 9001KR3BH6	19-72	9001KS72K( ) - 9001KS79K( )	19-76
9001K88J1	19-77	9001KR3G - 9001KR3GH6	19-72	9001KS88	19-77
9001K88J1R	19-77	9001KR3R - 9001KR3RH6	19-72	9001KT( )G31	19-79
9001K92B	19-99	9001KR3U - 9001KR3UH6	19-72	9001KT( )R31	19-79
9001K92BM - 9001K92RM	19-99	9001KR4( ) - 9001KR4( )H6	19-72	9001KT1	19-79
9001K93B - 9001K93Y	19-99	9001KR4B - 9001KR4BH6	19-72	9001KT1( )	19-79
9001K93BM - 9001K93RM	19-99	9001KR4G - 9001KR4GH6	19-72	9001KT1G31	19-9, 19-79
9001K94BM - 9001K94RM	19-99	9001KR4R - 9001KR4R05H6	19-72	9001KT1R31	19-9, 19-79
9001K95BM - 9001K95RM	19-99	9001KR4RH13 - 9001KR4RH6	19-72	9001KT35	19-79
9001KA1 - 9001KA6	19-104	9001KR5( ) - 9001KR5( )H6	19-72	9001KT35G31	19-79
9001KA2	16-81, 19-104	9001KR5B - 9001KR5BH6	19-72	9001KT35R31	19-79
9001KA41 - 9001KA55	19-92	9001KR5G - 9001KR5GH6	19-72	9001KT7	19-79
9001KM1 - 9001KM8	19-91	9001KR5R - 9001KR5R05H6	19-72	9001KT7( )	19-79
9001KM14 - 9001KM58	19-91	9001KR5RH13 - 9001KR5RH6	19-72	9001KT7G31	19-79
9001KM1LG - 9001KM1LY	19-91	9001KR6( ) - 9001KR6( )H7	19-81	9001KT7R31	19-79
9001KM31LG - 9001KM58LY	19-91	9001KR67( ) - 9001KR67( )H7	19-81	9001KTR( )	19-79
9001KM3LG - 9001KM7LY	19-91	9001KR67GR - 9001KR67GRH7	19-81	9001KTR( )G31	19-79
9001KMF1	19-91	9001KR67UH37	19-81	9001KTR( )R31	19-79
9001KN100BP - 9001KN179WP	19-94	9001KR67UH7	19-81	9001KTR35	19-79
9001KN101SP	19-9, 19-94	9001KR6GR - 9001KR6GRH7	19-81	9001KTR35G31	19-79
9001KN102RP - 9001KN104SP	19-9	9001KR6U	19-81	9001KTR35R31	19-79
9001KN103SP	19-9, 19-94	9001KR6UH37	19-81	9001KT7	19-79
9001KN144SP	19-9, 19-94	9001KR6UH7	19-81	9001KT7( )	19-79
9001KN160SP	19-9, 19-94	9001KR7( )	19-81	9001KT7G31	19-79
9001KN200 - 9001KN278	19-94	9001KR7( )H37	19-81	9001KT7R31	19-79
9001KN200BP - 9001KN278WP	19-94	9001KR7( )H7	19-81	9001KTR	19-79
9001KN201	19-9, 19-94	9001KR7GR	19-81	9001KTR( )G31	19-79
9001KN202 - 9001KN204	19-9	9001KR7GRH37	19-81	9001KTR( )R31	19-79
9001KN203	19-9, 19-94	9001KR7GRH7	19-81	9001KTR35	19-79
9001KN244	16-81, 19-9, 19-94	9001KR7U	19-81	9001KTR35G31	19-79
9001KN260	16-81, 19-9, 19-94	9001KR7UH37	19-81	9001KTR35R31	19-79
9001KN300 - 9001KN379	19-94	9001KR7UH7	19-81	9001KTR38	19-79
9001KN300R( )	19-94	9001KR8( ) - 9001KR8( )H25	19-73	9001KTR38( )	19-79
9001KN700BP - 9001KN779WP	19-94	9001KR8G - 9001KR8GH25	19-73	9001KTR38G31	19-79
9001KN800 - 9001KN878	19-94	9001KR8P( ) - 9001KR8P( )RH25	19-73	9001KTR38R31	19-79
9001KN800R( )	19-94	9001KR8P1( ) - 9001KR8P1( )H25	19-73	9001KU1 - 9001KU8	19-98
9001KP	19-93	9001KR8P1RH25 - 9001KR8RH25	19-73	9001KU17 - 9001KU47	19-98
9001KP( )	19-79	9001KR9( ) - 9001KR9( )H13	19-73	9001KXAA4 - 9001KXAAW4	19-106
9001KP( )G31	19-79	9001KR9BM94 - 9001KR9BM95	19-73	9001KXBB06 - 9001KXBD83	19-102
9001KP( )R31	19-79	9001KR9G - 9001KR9GM95	19-73	9001KXN100 - 9001KXN199	19-105
9001KP1	19-79	9001KR9P( ) - 9001KR9P( )RH13	19-73	9001KXN200 - 9001KXN299V	19-105
9001KP1( )	19-79	9001KR9P1( ) - 9001KR9P1( )H13	19-73	9001KXN300 - 9001KXN399	19-105
9001KP1G31	19-9, 19-79	9001KR9P1RH13	19-73	9001KXN400 - 9001KXN499	19-105
9001KP1R31	19-9, 19-79	9001KR9R - 9001KR9R94H13	19-73	9001KXN500 - 9001KXN599	19-105
9001KP35	19-79	9001KR9RH13	19-73	9001KXN600 - 9001KXN699	19-105
9001KP35( )	19-79	9001KR9RM94 - 9001KR9RM95	19-73	9001KXN700 - 9001KXN799	19-105
9001KP35G31	19-79	9001KRD1UH1 - 9001KRD3UH2	19-81	9001KXPA1A - 9001KXPB1AA	19-103
9001KP35R31	19-79	9001KS11 - 9001KS34K1	19-75	9001KXPB1AG - 9001KXPB34WW	19-103
9001KP7	19-79	9001KS11BH1	16-81, 19-75	9001KXPC1WAGR - 9001KXPC34WAGR	19-103
9001KP7( )	19-79	9001KS11BH13	19-9, 19-75	9001KXRA133 - 9001KXRA134	19-102
9001KP7G31	19-79	9001KS11BM1	16-81	9001KXRAA - 9001KXRAW	19-103
9001KP7R31	19-79	9001KS401 - 9001KS402	19-76	9001KXRAA2 - 9001KXRALH2	19-102
9001KQ11 - 9001KQ15	19-80	9001KS401( ) - 9001KS402( )	19-76	9001KXRB1AH1 - 9001KXRB1RH1	19-102
9001KQ11B - 9001KQ15B	19-80	9001KS401BH1 - 9001KS402BH1	19-76	9001KXRB34AH1 - 9001KXRB34RH1	19-102
9001KR1( ) - 9001KR1( )H6	19-72	9001KS401BH13 - 9001KS402BH13	19-76	9001KXRB35A - 9001KXRB38W	19-103
9001KR11( ) - 9001KR11( )H1	19-81	9001KS401BH2 - 9001KS402BH2	19-76	9001KXRC111 - 9001KXRC136	19-102
9001KR11U - 9001KR67U	19-81	9001KS401K( ) - 9001KS402K( )	19-76	9001KXRCG - 9001KXRCWW	19-103
9001KR11UH1	19-81	9001KS42 - 9001KS49	19-76	9001KXRD140 - 9001KXRDLH7	19-102



9001KXRJ35GWG – 9001KXRJ38RWG .....	19-103	9001SKR25BH13 – 9001SKR25RH13.....	19-82	9001T8WH – 9001T8YW.....	19-99
9001KXRL121 – 9001KXRL138 .....	19-102	9001SKR25BH5 – 9001SKR25RH5.....	19-82	9001U19 – 9001W31 .....	19-99
9001KXRL34GRGR – 9001KXRL34GRGRH .....	19-102	9001SKR25BH6 – 9001SKR25RH6.....	19-82	9001W29 .....	19-11
9001KXRL35GGRR – 9001KXRL38RWWG .....	19-103	9001SKR2B – 9001SKR2U .....	19-82	9001W6 – 9001W9 .....	19-99
9001KXRM35RRGG – 9001KXRM38RWWG .....	19-103	9001SKR2BH13 – 9001SKR2UH13.....	19-82	9001W8 – 9001W24 .....	19-75, 19-85, 19-99
9001KXSA125 – 9001KXSD126.....	19-102	9001SKR2BH5 – 9001SKR2UH5.....	19-82	9001Y2 – 9001Y9 .....	19-99
9001KXSAEB .....	19-104	9001SKR2BH6 – 9001SKR2UH6.....	19-82	9001Y21 – 9001Y31 .....	19-99
9001KXSDCB .....	19-104	9001SKR3( ) – 9001SKR5( ) .....	19-82	9001Y236 .....	19-132
9001KXSHHB .....	19-104	9001SKR3( )H13 – 9001SKR5( )H13.....	19-82	9001Y29 .....	19-11
9001KXSJE35G – 9001KXSJE38W .....	19-104	9001SKR3( )H5 – 9001SKR5( )H5.....	19-82	9001Y8 – 9001Y24 .....	19-75, 19-85, 19-99
9001KXSRE1 – 9001KXSRE3 .....	19-104	9001SKR3( )H6 – 9001SKR5( )H6.....	19-82	9002AC1 – 9002AC8.....	19-139
9001KXSVC10 .....	19-104	9001SKR3B – 9001SKR3U .....	19-82	9002AW1 – 9002AW134 .....	19-139
9001KXSVC5 .....	19-104	9001SKR3BH13 – 9001SKR3UH13.....	19-82	9003K .....	19-141
9001KY1 – 9001KY6.....	19-112	9001SKR3BH5 – 9001SKR3UH5.....	19-82	9006PA08 .....	20-6, 20-9
9001KYAF1 – 9001KYAF6 .....	19-112	9001SKR3BH6 – 9001SKR3UH6.....	19-82	9006PA12 – 9006PA30 .....	20-6, 20-9 – 20-10
9001KYG1 – 9001KYG1Y .....	19-112	9001SKR4B – 9001SKR4R .....	19-82	9007AA0 – 9007AA17 .....	21-39
9001KYG11 – 9001KYG1Y2 .....	19-113	9001SKR4BH13 – 9001SKR4RH13.....	19-82	9007AA1M – 9007AA8M .....	21-40
9001KYK11 – 9001KYK326 .....	19-113	9001SKR4BH5 – 9001SKR4RH5.....	19-82	9007AB21 – 9007AB41 .....	21-6
9001KYSK101 – 9001KYSK210 .....	19-113	9001SKR4BH6 – 9001SKR4RH6.....	19-82	9007AC1 .....	21-6
9001KYSS1 – 9001KYSS6.....	19-112	9001SKR4G .....	19-82	9007AO1 – 9007AO6 .....	21-6
9001KYSS101 – 9001KYSS210 .....	19-113	9001SKR4GH13 – 9001SKR5RH13.....	19-82	9007AO1B .....	21-6
9001L20 – 9001L31 .....	19-99	9001SKR4GH5 – 9001SKR5RH5.....	19-82	9007AO2 .....	21-6
9001L21 .....	19-99	9001SKR4GH6 – 9001SKR5RH6.....	19-82	9007AO2A – 9007AO2B.....	21-6
9001L29 .....	19-11	9001SKR4R05 .....	19-82	9007AP201 – 9007AP323 .....	21-6
9001L6 – 9001L9 .....	19-99	9001SKR4R05H13 .....	19-82	9007B1 – 9007B19 .....	21-43
9001L8 – 9001L24 .....	19-75, 19-85, 19-99	9001SKR4R05H5 .....	19-82	9007B2 – 9007B27 .....	21-43
9001R19 – 9001R31 .....	19-99	9001SKR4R05H6 .....	19-82	9007BA0 .....	21-39
9001R2205 .....	19-99	9001SKR5R .....	19-82	9007BA1 – 9007BA18 .....	21-39
9001R29 .....	19-11	9001SKR5R05 .....	19-82	9007BA1M – 9007BA11M .....	21-40
9001R6 – 9001R9 .....	19-99	9001SKR5R05H13 .....	19-82	9007BA2 – 9007BA9 .....	21-39
9001R8 – 9001R24 .....	19-75, 19-85, 19-99	9001SKR5R05H5 .....	19-82	9007C1 – 9007C3 .....	21-43
9001R94 .....	19-99	9001SKR5R05H6 .....	19-82	9007C52A2 – 9007C54N2.....	21-37
9001S11 – 9001S25 .....	19-99	9001SKR8( ) .....	19-83	9007C52D – 9007C66L .....	21-38
9001SK11J1 – 9001SK12J1R .....	19-85	9001SKR8( )H25 .....	19-83	9007C62A2 – 9007C68T5.....	21-37
9001SK1L – 9001SKS7 .....	19-93	9001SKR8G .....	19-83	9007CA0 – 9007CA18 .....	21-39
9001SK1L( ) – 9001SK1L7RH13 .....	19-84	9001SKR8GH25 .....	19-83	9007CA1M – 9007CA11M.....	21-40
9001SK20 – 9001SK23 .....	19-87	9001SKR8P( ) .....	19-83	9007CA2 – 9007CA2S .....	21-39
9001SK25J1 – 9001SK25J1R .....	19-85	9001SKR8P( )H25 .....	19-83	9007CA4 – 9007CA9 .....	21-39
9001SK2L( ) – 9001SK2L7RH13 .....	19-84	9001SKR8P( )RH25 .....	19-83	9007CB31 – 9007CB41 .....	21-6
9001SK34J1 – 9001SK34J1R .....	19-85	9001SKR8P1( ) .....	19-83	9007CC1 .....	21-6
9001SK40 – 9001SK49 .....	19-100	9001SKR8P1( )H25 .....	19-83	9007CO3 – 9007CO7 .....	21-6
9001SK401J( ) – 9001SK49J1R .....	19-86	9001SKR8P1RH25 .....	19-83	9007CO52 – 9007CO68.....	21-38
9001SK501J( ) – 9001SK59J1R .....	19-86	9001SKR8R .....	19-83	9007CP221 – 9007CP323 .....	21-6
9001SK601J( ) – 9001SK69J1R .....	19-86	9001SKR8RH25 .....	19-83	9007CR53A2 – 9007CR67T5.....	21-37
9001SK701J( ) – 9001SK79J1R .....	19-86	9001SKR9( ) .....	19-83	9007CR53D – 9007CR65KC.....	21-38
9001SK88J( ) .....	19-87	9001SKR9( )H13 .....	19-83	9007CT10 – 9007CT12 .....	21-40
9001SK88J1 .....	19-87	9001SKR9G .....	19-83	9007CT52 – 9007CT62 .....	21-38
9001SK88J1R .....	19-87	9001SKR9GH13 .....	19-83	9007D .....	21-38
9001SKP( ) – 9001SKP( )R31 .....	19-88	9001SKR9P( ) .....	19-83	9007D1 – 9007D4 .....	21-43
9001SKP1 – 9001SKP1( ) .....	19-88	9001SKR9P( )H13 .....	19-83	9007DA1 – 9007DA18 .....	21-39
9001SKP1G31 .....	19-9, 19-88	9001SKR9P( )RH13 .....	19-83	9007DA2 – 9007DA4 .....	21-39
9001SKP1R31 .....	19-9, 19-88	9001SKR9P1( ) .....	19-83	9007DA3 – 9007DA31 .....	21-39
9001SKP35 – 9001SKP35R31 .....	19-88	9001SKR9P1( )H13 .....	19-83	9007DA3S – 9007DA4S .....	21-39
9001SKP7 – 9001SKP7R31 .....	19-88	9001SKR9P1RH13 .....	19-83	9007E .....	21-38
9001SKR1( ) .....	19-82	9001SKR9R .....	19-83	9007E4 – 9007E6 .....	21-43
9001SKR1( )H13 .....	19-82	9001SKR9RH13 .....	19-83	9007EAO5 .....	21-39
9001SKR1( )H5 .....	19-82	9001SKS11 – 9001SKS11BH2 .....	19-85	9007EA1 – 9007EA18 .....	21-39
9001SKR1( )H6 .....	19-82	9001SKS11BH13 .....	19-9, 19-85	9007EA1M – 9007EA18M .....	21-40
9001SKR11( ) – 9001SKR11( )H1 .....	19-89	9001SKS12 – 9001SKS34 .....	19-85	9007EA1S – 9007EA4S .....	21-39
9001SKR11U – 9001SKR11UH1 .....	19-89	9001SKS401 – 9001SKS49BH2 .....	19-86	9007EA2 – 9007EA9 .....	21-39
9001SKR12( ) – 9001SKR12( )H1H1 .....	19-89	9001SKS43BH13 .....	19-9, 19-86	9007ED .....	21-38
9001SKR12U – 9001SKR12UH1H1 .....	19-89	9001SKS501 – 9001SKS59( ) .....	19-86	9007F4 – 9007F6 .....	21-43
9001SKR16 .....	19-83	9001SKS601 – 9001SKS69( ) .....	19-86	9007FA1 – 9007FA6 .....	21-39
9001SKR16H13 .....	19-83	9001SKS701 – 9001SKS79( ) .....	19-86	9007G10 .....	21-43
9001SKR16H2 .....	19-83	9001SKS88 .....	19-87	9007HA0 – 9007HA26 .....	21-40
9001SKR1B – 9001SKR1U .....	19-82	9001SKS88( ) .....	19-87	9007J .....	21-38
9001SKR1BH13 .....	19-9, 19-82	9001SKT( ) – 9001SKT( )R31 .....	19-88	9007J1 – 9007J2 .....	21-43
9001SKR1BH5 – 9001SKR1UH5 .....	19-82	9001SKT1 – 9001SKT1( ) .....	19-88	9007K .....	21-38
9001SKR1BH6 – 9001SKR1UH6 .....	19-82	9001SKT1G31 .....	19-9, 19-88	9007K1 – 9007K2 .....	21-43
9001SKR1GH13 – 9001SKR1UH13.....	19-82	9001SKT1R31 .....	19-9, 19-88	9007KA1 – 9007KA21 .....	21-39
9001SKR1RH13 .....	19-9, 19-82	9001SKT35 – 9001SKT35R31 .....	19-88	9007KB11 – 9007KB15 .....	21-39
9001SKR2( ) .....	19-82	9001SKT7 – 9001SKT7R31 .....	19-88	9007KC .....	21-38
9001SKR2( )H5 – 9001SKR25( )H5 .....	19-82	9001SKTR( ) – 9001SKTR( )R31 .....	19-88	9007L .....	21-38
9001SKR2( )H6 – 9001SKR25( )H6 .....	19-82	9001SKTR35 – 9001SKTR35R31 .....	19-88	9007LA1 – 9007LA19 .....	21-39
9001SKR24( ) – 9001SKR25( ) .....	19-82	9001SKTR38 – 9001SKTR38R31 .....	19-88	9007MA0 .....	21-39
9001SKR24( )H13 – 9001SKR25( )H13 .....	19-82	9001SKY1 – 9001SKY6 .....	19-112	9007MA1 – 9007MA18S .....	21-39
9001SKR24B – 9001SKR24R .....	19-82	9001SKY105 – 9001SKY315A.....	19-113	9007MA1M – 9007MA18M .....	21-40
9001SKR24BH13 – 9001SKR24RH13 .....	19-82	9001SSKS46BH2 .....	19-86	9007MA2 – 9007MA22 .....	21-39
9001SKR24BH5 – 9001SKR24RH5 .....	19-82	9001T5BE – 9001T5YW .....	19-99	9007MA3 – 9007MA31 .....	21-39
9001SKR24BH6 – 9001SKR24RH6 .....	19-82	9001T8BE – 9001T8RD .....	19-99	9007ML01S0100 – 9007MS09S0100.....	21-8
9001SKR25B – 9001SKR25R .....	19-82	9001T8U .....	19-99	9007ML10S0100 – 9007ML12S0100.....	21-9

Product Locator Index

Alphanumeric Listing



www.se.com/us

Table listing product part numbers and their corresponding page numbers, organized in three columns. Includes part numbers like 9007MS10G0100, 9049A20, 9070TF25D31, etc.

ALPHA-NUMERIC LISTING

9422CFT11	8-35	9991DPG2	16-90, 16-111	9998DRC9	16-124
9422CFT30	8-35	9991DPG3	16-90, 16-111	9998HR2	16-11
9422CFT31	8-35	9991DPG4	16-90, 16-111	9998HR3	16-11
9422CFT40	8-35	9991DPSG1	16-111	9998HW1	16-11
9422CFT50	8-35	9991DPSG2	16-111	9998HWA1	16-11
9422CFT51	8-35	9991EN1	16-11, 16-111	9998IL1	16-11
9422CMP10	8-41	9991FE1	16-11	9998ML1	16-124
9422CMP40	8-41	9991KE1	16-11	9998ML2	16-124
9422CMP50	8-41	9991KE2	16-11	9998PB14	16-124
9422CSB10	8-41	9991KE3	16-11	9998PB15	16-124
9422CSB30	8-41	9991LG1	16-111	9998PB2	16-124
9422CSB50	8-41	9991LXG1	16-80, 16-111	9998PB3	16-124
9422CSB70	8-41	9991MA1	16-110	9998PBV02	16-123
9422CSBD1	8-42	9991MF1	16-11, 16-111	9998PBV08	16-123
9422CSBD31	8-42	9991MF2	16-11, 16-111	9998PBV28	16-123
9422CSBD33	8-42	9991MG1	16-11, 16-111	9998PBV39	16-123
9422CSBD35	8-42	9991MG2	16-11, 16-111	9998PC177 – 9998PC341	22-34
9422CSBD51	8-42	9991MW1	16-11, 16-110	9998RA10	16-124
9422CSBD55	8-42	9991MW11	16-11, 16-110	9998RA11	16-124
9422CSF10	8-41	9991SCA11	16-80, 16-110	9998RA12	16-124
9422CSF104	8-41	9991SCA12	16-110	9998RA13	16-124
9422CSF30	8-41	9991SCA13	16-110	9998RA14	16-124
9422CSF304	8-41	9991SCA4	16-112	9998RA15	16-124
9422CSF50	8-41	9991SCF1	16-80, 16-111	9998RA16	16-124
9422CSF504	8-41	9991SCF11 – 9991SCF13	16-80, 16-111	9998RA17	16-124
9422CSF70	8-41	9991SCF12	16-111	9998RA5	16-124
9422CSFD1	8-42	9991SCF2	16-80, 16-111	9998RA5B	16-124
9422CSFD31	8-42	9991SCG1	16-112	9998SG120	16-122
9422CSFD33	8-42	9991SCG7	16-80, 16-111	9998SG208	16-122
9422CSFD345	8-42	9991SCG8	16-111	9998SG240	16-122
9422CSFD35	8-42	9991SCG9	16-111	9998SG277	16-122
9422CSFD51	8-42	9991SCH2	16-80, 16-110	9998SG380	16-122
9422CSFD55	8-42	9991SCW1	16-80	9998SG480	16-122
9422CSFDJ10	8-42	9991SCW11	16-80, 16-110	9998SJ1	16-124
9422CSFDJ50	8-42	9991SCW12	16-110	9998SL10	16-124
9422CSJ10	8-41	9991SCW13	16-110	9998SL11	16-124
9422CSJ104	8-41	9991SCW20	16-80, 16-110	9998SL12	16-124
9422CSJ30	8-41	9991SCW21	16-110	9998SL13	16-124
9422CSJ304	8-41	9991SCW4	16-112	9998SL14	16-124
9422CSJ50	8-41	9991SDA11	16-80, 16-110	9998SL2	16-124
9422CSJ504	8-41	9991SDA12	16-110	9998SL22	16-124
9422CSJD10	8-42	9991SDA3	16-80, 16-112	9998SL24	16-124
9422CSJD50	8-42	9991SDA4	16-112	9998SL25	16-124
9422CSJD51	8-42	9991SDF1	16-80, 16-111	9998SL26	16-124
9422RB1	8-43	9991SDF11	16-80, 16-111	9998SL27	16-124
9422RM1	8-43	9991SDF12	16-111	9998SL28	16-124
9422RQ1	8-43	9991SDF13	16-80, 16-111	9998SL29	16-124
9422RS1	8-43	9991SDF2	16-80, 16-111	9998SL3	16-124
9422TC30	16-131	9991SDG3	16-80, 16-112	9998SL30	16-124
9422TC30	8-35	9991SDG4	16-111 – 16-112	9998SL31	16-124
9422TC33	16-131	9991SDG7	16-80, 16-111	9998SL32	16-124
9422TC33	8-35	9991SDG8	16-111	9998SL33	16-124
9422TCF30	8-33	9991SDG9	16-111	9998SL4	16-124
9422TCF30C	8-33	9991SDH1	16-80, 16-110	9998SL6	16-124
9422TCF33	8-33	9991SDW1	16-80	9998SL7	16-124
9422TCF33C	8-33	9991SDW11	16-80, 16-110	9998SL8	16-124
9422TCN30	8-33	9991SDW12	16-110	9998SL9	16-124
9422TCN30C	8-33	9991SDW20	16-80, 16-110	9998SMH1( ) – 9998SMH83( )	16-75
9422TD63	16-131	9991SDW21	16-110	9998SO1	16-92
9422TD63	8-35	9991SDW3	16-80, 16-112	9998SO31	16-11, 16-92, 16-125
9422TDF60	8-33	9991SDW4	16-112	9998SO32	16-125
9422TDF60C	8-33	9991SEA11	16-80, 16-110	9998UB01	16-125
9422TDF63	8-33	9991SEF11	16-80, 16-111	9998UB02	16-125
9422TDF63C	8-33	9991SEG7	16-111	9998UB03	16-125
9422TDN60	8-33	9991SEG8	16-111	9998UB04	16-125
9422TDN60C	8-33	9991SEH1	16-80, 16-110	9998UB11	16-125
9422TEF10	8-33	9991SEW11	16-80, 16-110	9998UB12	16-125
9422TEF10C	8-33	9991SFA11	16-110	9998UB13	16-125
9422TEN10	8-33	9991SFG4	16-80, 16-111	9998UB14	16-125
9422TEN10C	8-33	9991SFG8	16-80, 16-111	9998WFF	16-43 – 16-45, 16-66
9422TF1	8-33	9991SFH1	16-80, 16-110	9998WVG	16-43 – 16-45, 16-66
9422TF2	8-33	9991SFW11	16-110	9998WH	16-43 – 16-45, 16-66
9422TF3	8-33	9991SGG8	16-80, 16-111	9999AC04	16-128
9422TFB1	8-33	9991UE1	16-111	9999BLX	16-81
9422TFB2	8-33	9991UE6	16-111	9999D01	16-90, 16-99, 16-127
9422TFB3	8-33	9991UE7	16-111	9999D10	16-90, 16-29, 16-99, 16-127
9422TG1	8-33	9998DA2	16-90, 16-92	9999D11	16-90, 16-99, 16-127
9422TG2	8-33	9998DA3	16-90	9999D20	16-90, 16-99, 16-127
9788EZCIRIGB	4-9	9998DRC5	16-124	9999DA01	16-128
9788SER3200	4-9	9998DRC6	16-124	9999DD01	16-127
9991DPG1	16-90, 16-111	9998DRC7	16-124	9999DD10	16-127

9999DD11.....	16-127	9999SB11.....	16-128	9999SP15R.....	16-126
9999DD20.....	16-127	9999SB12.....	16-128	9999SP28R.....	16-81, 16-126
9999DMB1.....	16-90	9999SB13.....	16-128	9999SP29R.....	16-126
9999DPC1.....	16-90	9999SB14.....	16-128	9999SP2R.....	16-81, 16-126
9999LB0.....	16-128	9999SB15.....	16-128	9999SP3R.....	16-81, 16-126
9999LL0.....	16-128	9999SB21.....	16-76, 16-128	9999SP4R.....	16-126
9999LLX.....	16-80	9999SB22.....	16-76, 16-128	9999SP5R.....	16-126
9999LUW5.....	16-43 – 16-45, 16-66	9999SB23.....	16-76, 16-128	9999SPL28G.....	16-126
9999LUW6.....	16-43 – 16-44	9999SB24.....	16-76, 16-128	9999SPL28R.....	16-126
9999LXPB.....	16-81	9999SB25.....	16-76, 16-128	9999SPL29G.....	16-126
9999LXS.....	16-81	9999SB6.....	16-76, 16-128	9999SPL29R.....	16-126
9999MP1.....	16-11	9999SB7.....	16-76, 16-128	9999SR1.....	16-131
9999MP2.....	16-11	9999SB8.....	16-76, 16-128	9999SR2.....	16-131
9999MP3.....	16-11	9999SB9.....	16-76, 16-128	9999SR3.....	16-131
9999PL10 – 9999PL13G.....	16-11	9999SBT1.....	16-128	9999SR4.....	16-131
9999R10.....	16-127	9999SC2.....	16-81, 16-126	9999SR4.....	8-34
9999R11.....	16-127	9999SC22.....	16-81, 16-126	9999SR5.....	16-131
9999R12.....	16-127	9999SC8.....	16-81, 16-126	9999SR5.....	8-34
9999R13.....	16-127	9999SC9.....	16-126	9999ST1.....	16-129
9999R26.....	8-43	9999SF3.....	16-129	9999ST2.....	16-129
9999R26 – 9999R36.....	16-80	9999SF4.....	16-129	9999SX6 – 9999SX17.....	16-80, 16-127
9999R27.....	8-43	9999SFR3.....	16-80, 16-129	9999T7.....	16-129
9999R35.....	8-35	9999SFR4.....	16-80, 16-129	9999TC10.....	3-12 – 3-13, 16-80
9999R36.....	8-35	9999SG1.....	16-126	9999TC10.....	8-35
9999R47.....	16-131	9999SG2.....	16-126	9999TC11.....	16-80
9999R48.....	16-131	9999SG3.....	16-126	9999TC11.....	8-35
9999R8.....	3-12, 16-80	9999SJ2.....	16-131	9999TC20.....	3-12 – 3-13, 16-80
9999R8.....	8-35	9999SJ3.....	16-131	9999TC20.....	8-35
9999R9.....	3-12, 16-80	9999SJ4.....	16-131	9999TC21.....	16-80
9999R9.....	8-35	9999SM1 – 9999SM13.....	16-130	9999TC21.....	8-35
9999RB34.....	16-128	9999SMG62( ) – 9999SMG91( ).....	16-77	9999VFO3.....	16-44
9999RLX.....	16-81	9999SMO1( ) – 9999SMO13( ).....	16-75	9999VGO3.....	16-44
9999RR04.....	16-128	9999SN1.....	16-80, 16-129	9999VHO3.....	16-44
9999S1.....	16-131	9999SN2.....	16-80, 16-129	9999WCX11.....	16-43 – 16-45, 16-66
9999S2.....	16-131	9999SN3.....	16-80, 16-129	9999WFO3.....	16-43, 16-45, 16-66
9999S3.....	16-131	9999SN4.....	16-129	9999WGO3.....	16-43, 16-45, 16-66
9999S4.....	16-131	9999SO11.....	16-130	9999WHO3.....	16-43, 16-45
9999S5.....	16-131	9999SO12.....	16-130	9999WLX01.....	16-43 – 16-45, 16-66
9999SA10.....	16-81, 16-126	9999SO4.....	16-92, 16-129	9999WX11.....	16-43 – 16-45, 16-66
9999SA13.....	16-126	9999SO5.....	16-129	9T2F.....	14-11
9999SA2.....	16-126	9999SP12R.....	16-126	9T75F.....	14-11
9999SA3.....	16-81, 16-126	9999SP13R.....	16-126		
9999SB10.....	16-76, 16-128	9999SP14R.....	16-81, 16-126		

## Conductor Ampacity Based on the 2017 National Electrical Code®

Ampacity based on NEC® Table 310.15(B)(16) [Formerly Table 310.16] – Allowable Ampacities of Insulated Conductors Rated Up to and Including 2000 Volts, 60° Through 90°C (140° Through 194°F), Not More Than Three Current-Carrying Conductors in Raceway, Cable, or Earth (Directly Buried), Based on Ambient Temperature of 30°C (86°F)\*

For conduit fill see 2017 NEC Annex C.

For Information on Temperature Ratings of Terminations to Equipment See NEC 110.14(C).

Size	Temperature Rating of Conductor. [See Table 310.104(A).]						Size
	60°C (140°F)		75°C (167°F)		90°C (194°F)		
	Types TW, UF	Types RHW, THHW, THW, THWN, XHHW, USE, ZW	Types TBS, SA, SIS, FEP, FEPB, MI, RHH, RHW-2, THHN, THHW, THW-2, THWN-2, USE-2, XHH, XHHW, XHHW-2, ZW-2	Types TV, UF	Types RHW, THHW, THW, THWN, XHHW, USE	Types TBS, SA, SIS, THHN, THHW, THW-2, THWN-2, RHH, RHW-2, USE-2, XHH, XHHW, XHHW-2, ZW-2	
	Copper			Aluminum or Copper-Clad Aluminum			
18**	—	—	14	—	—	—	—
16**	—	—	18	—	—	—	—
14**	15	20	25	—	—	—	—
12**	20	25	30	15	20	25	12**
10**	30	35	40	25	30	35	10**
8	40	50	55	35	40	45	8
6	55	65	75	40	50	55	6
4	70	85	95	55	65	75	4
3	85	100	115	65	75	85	3
2	95	115	130	75	90	100	2
1	110	130	145	85	100	115	1
1/0	125	150	170	100	120	135	1/0
2/0	145	175	195	115	135	150	2/0
3/0	165	200	225	130	155	175	3/0
4/0	195	230	260	150	180	205	4/0
250	215	255	290	170	205	230	250
300	240	285	320	195	230	260	300
350	260	310	350	210	250	280	350
400	280	335	380	225	270	305	400
500	320	380	430	260	310	350	500
600	350	420	475	285	340	385	600
700	385	460	520	315	375	425	700
750	400	475	535	320	385	435	750
800	410	490	555	330	395	445	800
900	435	520	585	355	425	480	900
1000	455	545	615	375	445	500	1000
1250	495	590	665	405	485	545	1250
1500	525	625	705	435	520	585	1500
1750	545	650	735	455	545	615	1750
2000	555	655	750	470	560	630	2000

\* Refer to Section 310.15(B)(2)(a) for the ampacity correction factors where the ambient temperature is other than 30°C (86°F). Refer to 310.15(B)(3)(a) for more than three current-carrying conductors.

\*\* See Section 240.4(D) for conductor overcurrent protection limitations.

## 120/240 Volt Single Phase Dwelling Services and Feeders [Section 310.15(B)(7)]

For one family dwellings and the individual dwelling units of two family and multifamily dwellings, service and feeder conductors supplied by a single phase, 120/240 volt system shall be permitted to be sized as follows:

- For a service rated 100 through 400 A, the service conductors supplying the entire load associated with a one family dwelling, or the service conductors supplying the entire load associated with an individual dwelling unit in a two family or multifamily dwelling, shall be permitted to have an ampacity not less than 83 percent of the service rating.
- For a feeder rated 100 through 400 A, the feeder conductors supplying the entire load associated with a one family dwelling, or the feeder conductors supplying the entire load associated with an individual dwelling unit in a two-family or multifamily dwelling, shall be permitted to have an ampacity not less than 83 percent of the feeder rating.
- In no case shall a feeder for an individual dwelling unit be required to have an ampacity greater than that specified in (1) or (2).
- Grounded conductors shall be permitted to be sized smaller than the ungrounded conductors, provided that the requirements of Sections 220.61 and 230.42 for service conductors or the requirements of Sections 215.2 and 220.61 for feeder conductors are met.

Where correction or adjustment factors are required by 310.15(B)(2) or (3), they shall be applied to the ampacity associated with the temperature rating of the conductor.

## NEC 210.19 Conductors—Min. Ampacity and Size

For branch circuits not more than 600 volts, conductors shall have an ampacity not less than the maximum load to be served. Conductors shall be sized to carry not less than the larger of (a) or (b).

- Where a branch circuit supplies continuous loads or any combination of continuous and noncontinuous loads, the minimum branch-circuit conductor size shall have an allowable ampacity not less than the noncontinuous load plus 125 percent of the continuous load.
- The minimum branch-circuit conductor size shall have an allowable ampacity not less than the maximum load to be served after the application of any adjustment or correction factors.

Exception: If the assembly, including the overcurrent devices protecting the branch circuit(s), is listed for operation at 100 percent of its rating, the allowable ampacity of the branch-circuit conductors shall be permitted to be not less than the sum of the continuous load plus the noncontinuous load.

## Correction Factors

Based on NEC Table 310.15(B)(2)(a) Ambient Temperature Correction Factors Based on 30°C (86°F)

Ambient Temperature (°C)	Temperature Rating of Conductor			Ambient Temperature (°F)
	60°C	75°C	90°C	
10 or less	1.29	1.20	1.15	50 or less
11–15	1.22	1.15	1.12	51–59
16–20	1.15	1.11	1.08	60–68
21–25	1.08	1.05	1.04	69–77
26–30	1.00	1.00	1.00	78–86
31–35	0.91	0.94	0.96	87–95
36–40	0.82	0.88	0.91	96–104
41–45	0.71	0.82	0.87	105–113
46–50	0.58	0.75	0.82	114–122
51–55	0.41	0.67	0.76	123–131
56–60	—	0.58	0.71	132–140
61–65	—	0.47	0.65	141–149
66–70	—	0.33	0.58	150–158
71–75	—	—	0.50	159–167
76–80	—	—	0.41	168–176
81–85	—	—	0.29	177–185

## Adjustment Factors – See NEC Table 310.15 (B)(3)(a)

Where the number of current-carrying conductors in a raceway or cable exceeds three, the allowable ampacities shall be reduced as shown in the following table:

Number of Conductors***	Percent of Values in Table 310.15(B)(16) through Table 310.15(B)(19) as Adjusted for Ambient Temperature if Necessary
4 through 6	80
7 through 9	70
10 through 20	50
21 through 30	45
31 through 40	40
41 and Above	35

\*\*\* Number of conductors is the total number of conductors in the raceway or cable, including spare conductors. The count shall be adjusted in accordance with Section 310.15(B)(5) and (6). The count shall not include conductors that are connected to electrical components but that cannot be simultaneously energized.

## NEC 210.20(A) Continuous and Noncontinuous Loads

Where a branch-circuit supplies continuous loads or any combination of continuous and noncontinuous loads, the rating of the overcurrent device shall not be less than the noncontinuous load plus 125 percent of the continuous load.

## NEC 240.4 Protection of Conductors

Conductors, other than flexible cords, flexible cables, and fixture wires, shall be protected against overcurrent in accordance with their ampacities specified in 310.15, unless otherwise permitted or required in 240.4(A) through (G).

## NEC 240.4 (D) Small Conductors

Unless specifically permitted in 240.4(E) or (G), the overcurrent protection shall not exceed that required by (D)(1) through (D)(7) after any correction factors for ambient temperature and number of conductors have been applied.

## NEC 430.22(A) Direct-Current Motor-Rectifier Supplied

For dc motors operating from a rectified power supply, the conductor ampacity on the input of the rectifier shall not be less than 125 percent of the rated input current to the rectifier. For dc motors operating from a rectified single-phase power supply, the conductors between the field wiring output terminals of the rectifier and the motor shall have an ampacity of not less than the following percentages of the motor full-load current rating:

- Where a rectifier bridge of the single-phase, half-wave type is used, 190 percent.
- Where a rectifier bridge of the single-phase, full-wave type is used, 150 percent.